



**PDHonline Course C292 (4 PDH)**

---

## **Ponds - Planning and Construction Guidelines**

*Instructor: John Huang, Ph.D., PE and John Poullain, PE*

**2020**

**PDH Online | PDH Center**

5272 Meadow Estates Drive  
Fairfax, VA 22030-6658  
Phone: 703-988-0088  
[www.PDHonline.com](http://www.PDHonline.com)

An Approved Continuing Education Provider



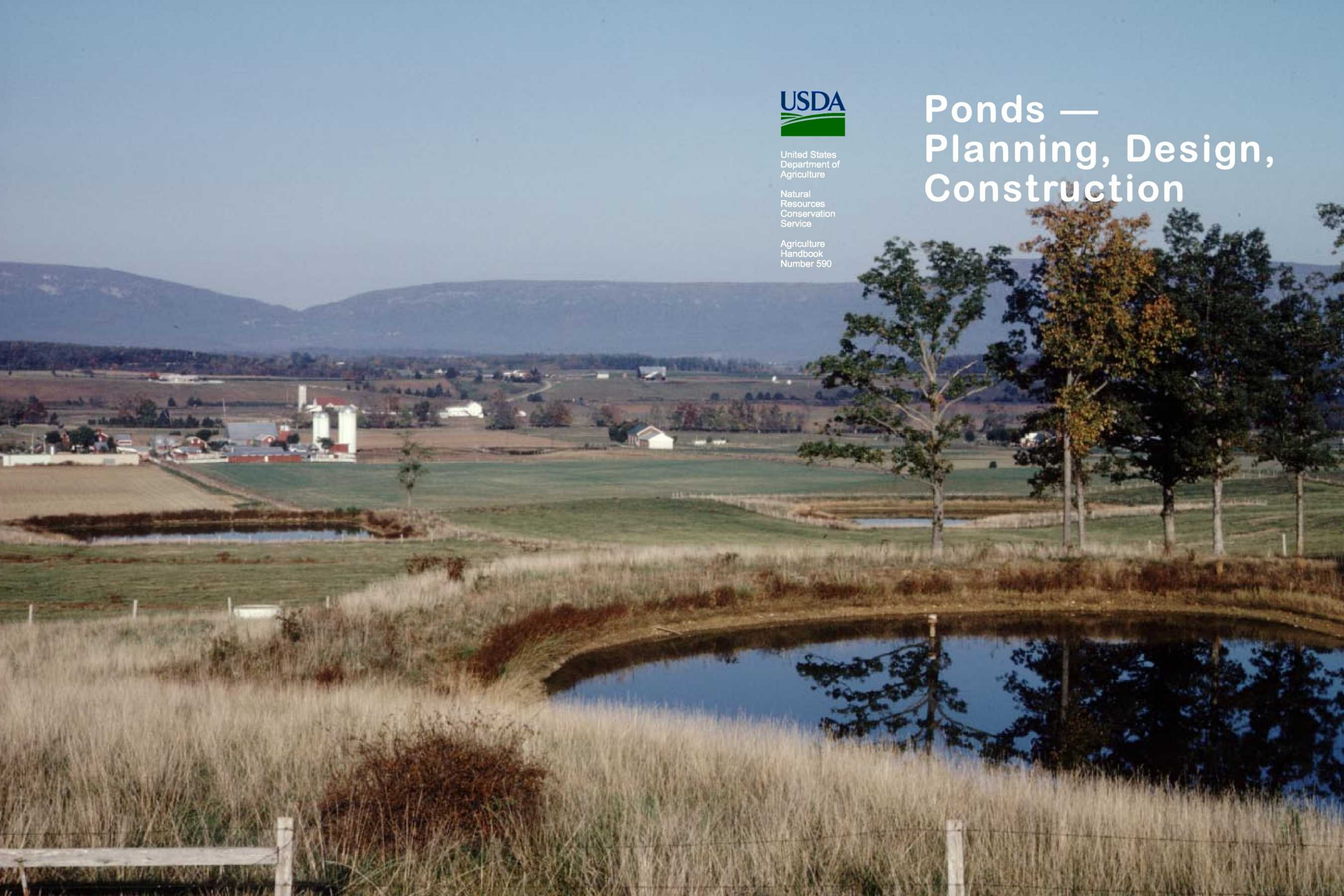


United States  
Department of  
Agriculture

Natural  
Resources  
Conservation  
Service

Agriculture  
Handbook  
Number 590

# Ponds — Planning, Design, Construction





# Ponds — Planning, Design, Construction

---

**Contents**

<b>Introduction</b>	<b>1</b>
<hr/>	
<b>Water needs</b>	<b>2</b>
Livestock .....	2
Irrigation .....	3
Fish production .....	3
Field and orchard spraying .....	4
Fire protection .....	4
Recreation .....	6
Waterfowl and other wildlife .....	6
Landscape quality .....	6
Multiple purposes .....	8
<hr/>	
<b>Preliminary investigations</b>	<b>9</b>
General considerations .....	9
Area adequacy of the drainage .....	9
Minimum pond depth .....	10
Drainage area protection .....	11
Pond capacity .....	12
Landscape evaluation .....	12
<hr/>	
<b>Estimating storm runoff</b>	<b>13</b>
Hydrologic groupings of soils .....	13
Runoff curve numbers .....	13
Volume of storm runoff .....	18
Rainfall amounts and expected frequency .....	19
Rainfall distribution .....	19
Peak discharge rate .....	20
Time of concentration .....	20
Average watershed slope .....	21
Flow length .....	21
$I_a/P$ ratio .....	21
Estimating peak discharge rates .....	22
<hr/>	
<b>Site surveys</b>	<b>24</b>

---

<b>Embankment ponds</b>	<b>24</b>
Detailed soils investigation .....	24
Spillway requirements .....	26
Pipes through the dam .....	36
Planning an earthfill dam .....	45
Staking for construction .....	53
Building the pond .....	53
<hr/>	
<b>Excavated ponds</b>	<b>57</b>
Soils .....	57
Spillway and inlet requirements .....	58
Planning the pond .....	58
Building the pond .....	61
<hr/>	
<b>Sealing the pond</b>	<b>62</b>
Compaction .....	62
Clay blankets .....	63
Bentonite .....	63
Chemical additives .....	64
Waterproof linings .....	65
<hr/>	
<b>Establishing vegetation</b>	<b>66</b>
Protecting the pond .....	66
Wave action .....	66
Livestock .....	67
<hr/>	
<b>Operating and maintaining the pond</b>	<b>68</b>
<hr/>	
<b>Pond safety</b>	<b>69</b>
Before construction .....	69
During construction .....	69
After completion .....	69
<hr/>	
<b>References</b>	<b>70</b>
<hr/>	
<b>Glossary</b>	<b>71</b>
<hr/>	
<b>Appendixes</b>	<b>75</b>
Appendix A: Estimating the Volume of an Excavated Pond .....	75
Appendix B: Flood-Tolerant Native Trees and Shrubs .....	79



# Ponds — Planning, Design, Construction

## Introduction

For many years farmers and ranchers have been building ponds for livestock water and for irrigation. By 1980 more than 2.1 million ponds had been built in the United States by land users on privately owned land. More will be needed in the future.

The demand for water has increased tremendously in recent years, and ponds are one of the most reliable and economical sources of water. Ponds are now serving a variety of purposes, including water for livestock and for irrigation, fish production, field and orchard spraying, fire protection, energy conservation, wildlife habitat, recreation, erosion control, and landscape improvement.

This handbook describes embankment and excavated ponds and outlines the requirements for building each. The information comes from the field experience and observation of land users, engineers, conservationists, and other specialists.

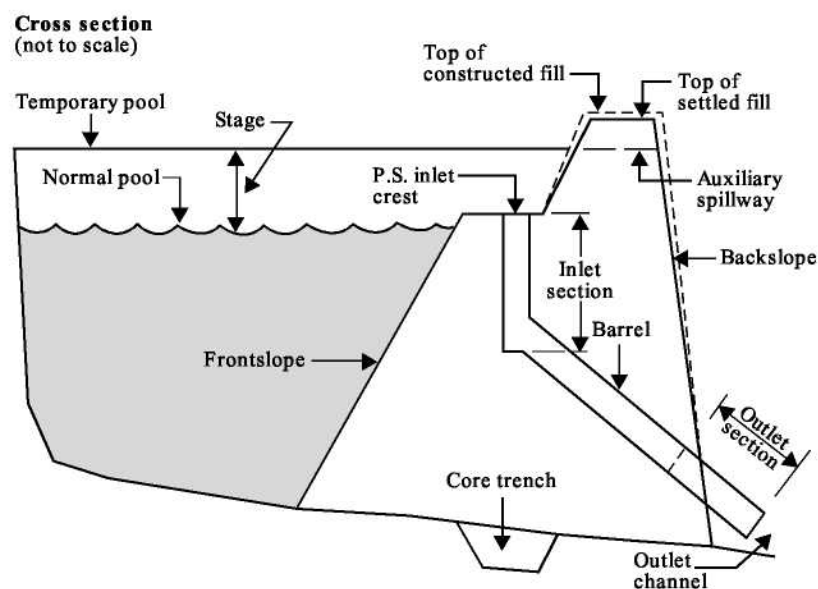
An embankment pond (fig. 1) is made by building an embankment or dam across a stream or watercourse where the stream valley is depressed enough to permit storing 5 feet or more of water. The land slope may range from gentle to steep.

An excavated pond is made by digging a pit or dugout in a nearly level area. Because the water capacity is obtained almost entirely by digging, excavated ponds are used where only a small supply of water is needed. Some ponds are built in gently to moderately sloping areas and the capacity is obtained both by excavating and by building a dam.

The criteria and recommendations are for dams that are less than 35 feet high and located where failure of the structure will not result in loss of life; in damage to homes, commercial or industrial buildings, main highways, or railroads; or in interrupted use of public utilities.

Local information is essential, and land users are encouraged to consult with specialists experienced in planning and building ponds.

**Figure 1** Typical embankment and reservoir



## Water needs

### Livestock

Clean water and ample forage are equally essential for livestock to be finished out in a marketable condition. If stockwater provisions in pasture and range areas are inadequate, grazing will be concentrated near the water and other areas will be undergrazed. This can contribute to serious livestock losses and instability in the livestock industry.

Watering places must also be properly distributed in relation to the available forage. Areas of abundant forage may be underused if water is not accessible to livestock grazing on any part of that area (fig. 2).

Providing enough watering places in pastures encourages more uniform grazing, facilitates pasture improvement practices, retards erosion, and enables farmers to make profitable use of soil-conserving crops and erodible, steep areas unfit for cultivation.

An understanding of stockwater requirements helps in planning a pond large enough to meet the needs of the stock using the surrounding grazing area. The average daily consumption of water by different kinds of livestock shown here is a guide for estimating water needs.

<u>Kind of livestock</u>	<u>Gallons per head per day</u>
Beef cattle and horses	12 to 15
Dairy cows (drinking only)	15
Dairy cows (drinking and barn needs)	35
Hogs	4
Sheep	2

The amount of water consumed at one pond depends on the average daily consumption per animal, number of livestock served, and period over which they are served.

**Figure 2** This pond supplies water to a stockwater trough used by cattle in nearby grazing area





## Irrigation

Farm ponds are now an important source of irrigation water (fig. 3), particularly in the East, which does not have the organized irrigation enterprises of the West. Before World War II irrigation was not considered necessary in the humid East. Now many farmers in the East are irrigating their crops.

Water requirements for irrigation are greater than those for any other purpose discussed in this handbook. The area irrigated from a farm pond is limited by the amount of water available throughout the growing season. Pond capacity must be adequate to meet crop requirements and to overcome unavoidable water losses. For example, a 3-inch application of water on 1 acre requires 81,462 gallons. Consequently, irrigation from farm ponds generally is limited to high-value crops on small acreages, usually less than 50 acres.

The required storage capacity of a pond used for irrigation depends on these interrelated factors: water requirements of the crops to be irrigated, effective

rainfall expected during the growing season, application efficiency of the irrigation method, losses due to evaporation and seepage, and the expected inflow to the pond. Your local NRCS conservationist can help you estimate the required capacity of your irrigation pond.

## Fish production

Many land users are finding that fish production is profitable. A properly built and managed pond can yield from 100 to 300 pounds of fish annually for each acre of water surface. A good fish pond can also provide recreation (fig. 4) and can be an added source of income should you wish to open it to people in the community for a fee.

Ponds that have a surface area of a quarter acre to several acres can be managed for good fish production. Ponds of less than 2 acres are popular because they are less difficult to manage than larger ones. A minimum depth of 8 feet over an area of approximately 1,000 square feet is needed for best management.

**Figure 3** Water is pumped out of this pond for irrigation



## Field and orchard spraying

You may wish to provide water for applying pesticides to your field and orchard crops. Generally, the amount of water needed for spraying is small, but it must be available when needed. About 100 gallons per acre for each application is enough for most field crops. Orchards, however, may require 1,000 gallons or more per acre for each spraying.

Provide a means of conveying water from the pond to the spray tank. In an embankment pond, place a pipe through the dam and a flexible hose at the downstream end to fill the spray tank by gravity. In an excavated pond, a small pump is needed to fill the tank.

## Fire protection

A dependable water supply is needed for fighting fire. If your pond is located close to your house, barn, or other buildings, provide a centrifugal pump with a power unit and a hose long enough to reach all sides of all the buildings. Also provide for one or more dry hydrants (figs. 5 and 6).

Although water-storage requirements for fire protection are not large, the withdrawal rate for fire fighting is high. A satisfactory fire stream should be at least 250 gallons per minute with pressure at the nozzle of at least 50 pounds per square inch. Fire nozzles generally are 1 inch to 1-1/2 inches in diameter. Use good quality rubber-lined firehoses, 2-1/2 to 3 inches in diameter. Preferably, the hose should be no more than 600 feet long.

A typical firehose line consists of 500 feet of 3-inch hose and a 1-1/8 inch smooth nozzle. A centrifugal pump operating at 63 pounds per square inch provides a stream of 265 gallons per minute with a nozzle pressure of 50 pounds per square inch. Such a stream running for 5 hours requires 1/4 acre-foot of water. If you live in an area protected by a rural fire fighting organization, provide enough storage to operate several such streams. One acre-foot of storage is enough for four streams.

Your local dealer in pumps, engines, and similar equipment can furnish the information you need about pump size, capacity, and engine horsepower.

**Figure 4** A pond stocked with fish can provide recreation as well as profit

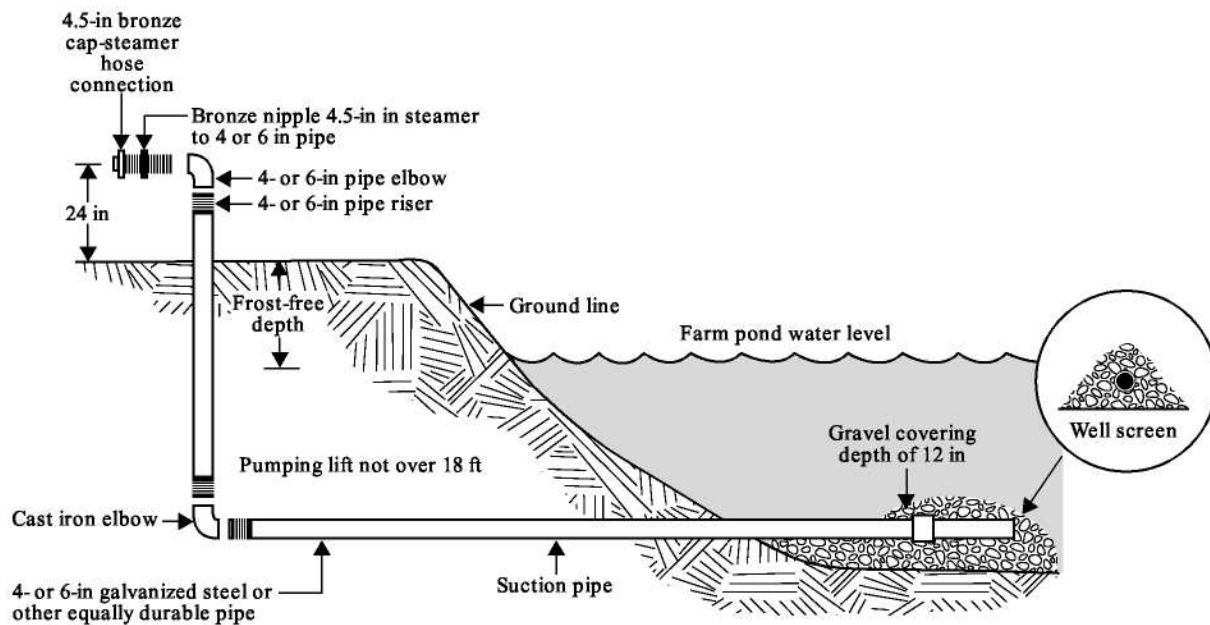




**Figure 5** A dry hydrant is needed when a pond is close enough to a home or barn to furnish water for fire fighting



**Figure 6** Details of a dry hydrant installation



Not to scale

## Recreation

A pond can provide many pleasant hours of swimming, boating, and fishing. The surrounding area can be made into an attractive place for picnics and games (fig. 7).

Many land users realize additional income by providing water for public recreation. If the public is invited to use a pond for a fee, the area must be large enough to accommodate several parties engaged in whatever recreation activities are provided.

If a pond is to be used for public recreation, supply enough water to overcome evaporation and seepage losses and to maintain a desirable water level. A pond used for swimming must be free of pollution and have an adequate depth of water near a gently sloping shore. Minimum facilities for public use and safety are also needed. These facilities include access roads, parking areas, boat ramps or docks, fireplaces, picnic tables, drinking water, and sanitary facilities.

To protect public health, most states have laws and regulations that require water supplies to meet certain prescribed standards if they are to be used for swimming and human consumption. Generally, water must be tested and approved before public use is permitted.

There are also rules and regulations for building and maintaining public sanitary facilities. The state board of health or a similar agency administers such laws and regulations. Contact your local health agency to become familiar with those regulations before making extensive plans to provide water for public recreation.

## Waterfowl and other wildlife

Ponds attract many kinds of wildlife. Migratory waterfowl often use ponds as resting places in their flights to and from the North. Ducks often use northern ponds as breeding places, particularly where the food supply is ample (fig. 8). Upland game birds use ponds as watering places.

## Landscape quality

Water adds variety to a landscape and further enhances its quality. Reflections in water attract the eye and help to create a contrast or focal point in the landscape (fig. 9). A pond visible from a home, patio, or entrance road increases the attractiveness of the landscape and often increases land value. Ponds in rural, suburban, and urban areas help to conserve or improve landscape quality.

**Figure 7** Ponds are often used for private as well as public recreation





**Figure 8** Waterfowl use ponds as breeding, feeding, watering places, and as resting places during migration



**Figure 9** The shoreline of a well-designed pond is protected from erosion by the addition of stone. Such a pond, reflecting nearby trees, increases the value of the surrounding land



Regardless of its purpose, a pond's appearance can be improved by using appropriate principles and techniques of design. Good design includes consideration of size, site visibility, relationship to the surrounding landscape and use patterns, and shoreline configuration.

Your local NRCS conservationist can help you apply the basic principles and design techniques. Consult a landscape architect for additional information and special designs.

### Multiple purposes

You may wish to use the water in your pond for more than one purpose; for example, to provide water for livestock, fish production, and spraying field crops. If so, two additional factors must be considered.

First, in estimating your water requirements you must total the amounts needed for each purpose and be sure that you provide a supply adequate for all the intended uses.

Second, make sure that the purposes for which the water is to be used are compatible. Some combinations, such as irrigation and recreation, generally are not compatible. You would probably use most of the water during the irrigation season, making boating and swimming impractical.

Ponds used temporarily for grade control or as sediment basins associated with construction sites can be converted later into permanent ponds by cleaning out the sediment, treating the shoreline, and adding landscape measures (fig. 10). If a sediment basin is to be cleaned and reconstructed as a water element, the standards for dam design should be used.

**Figure 10** This pond, which served as a sediment basin while homes in the background were being constructed, now adds variety and value to the community





---

## Preliminary investigations

### General considerations

Selecting a suitable site for your pond is important, and preliminary studies are needed before final design and construction. Analysis and selection of pond sites should be based on landscape structure and associated ecological functions and values. Relationship of the site to other ecological features within the landscape is critical to achieving planned objectives. If possible, consider more than one location and study each one to select the most ecologically appropriate, esthetic, and practical site. Weighing both onsite and offsite effects of constructing a pond is essential in site selection. Refer to figure 1 and the glossary to become familiar with the components of a pond and associated dam.

For economy, locate the pond where the largest storage volume can be obtained with the least amount of earthfill. A good site generally is one where a dam can be built across a narrow section of a valley, the side slopes are steep, and the slope of the valley floor permits a large area to be flooded. Such sites also minimize the area of shallow water. Avoid large areas of shallow water because of excessive evaporation and the growth of noxious aquatic plants.

If farm ponds are used for watering livestock, make a pond available in or near each pasture or grazing unit. Forcing livestock to travel long distances to water is detrimental to both the livestock and the grazing area. Space watering places so that livestock does not travel more than a quarter mile to reach a pond in rough, broken country or more than a mile in smooth, nearly level areas. Well-spaced watering places encourage uniform grazing and facilitate grassland management.

If pond water must be conveyed for use elsewhere, such as for irrigation or fire protection, locate the pond as close to the major water use as practicable. Conveying water is expensive and, if distance is excessive, the intended use of the water may not be practical.

Ponds for fishing, boating, swimming, or other forms of recreation must be reached easily by automobile, especially if the general public is charged a fee to use

the pond. The success of an income-producing recreation enterprise often depends on accessibility.

Avoid pollution of pond water by selecting a location where drainage from farmsteads, feedlots, corrals, sewage lines, mine dumps, and similar areas does not reach the pond. Use permanent or temporary measures, such as diversions, to redirect runoff from these sources to an appropriate outlet until the areas can be treated.

Do not overlook the possibility of failure of the dam and the resulting damage from sudden release of water. Do not locate your pond where failure of the dam could cause loss of life; injury to persons or livestock; damage to homes, industrial buildings, railroads, or highways; or interrupted use of public utilities. If the only suitable pond site presents one or more of these hazards, hire a qualified person to investigate other potential sites to reduce the possibility of failure from improper design or construction.

Be sure that no buried pipelines or cables cross a proposed pond site. They could be broken or punctured by the excavating equipment, which can result not only in damage to the utility, but also in injury to the operator of the equipment. If a site crossed by pipelines or cable must be used, you must notify the utility company before starting construction and obtain permission to excavate.

Avoid sites under powerlines. The wires may be within reach of a fishing rod held by someone fishing from the top of the dam.

### Area adequacy of the drainage

For ponds where surface runoff is the main source of water, the contributing drainage area must be large enough to maintain water in the pond during droughts. However, the drainage area should not be so large that expensive overflow structures are needed to bypass excess runoff during large storms.

The amount of runoff that can be expected annually from a given watershed depends on so many interrelated factors that no set rule can be given for its determination. The physical characteristics that directly affect the yield of water are relief, soil infiltration, plant cover, and surface storage. Storm characteris-

tics, such as amount, intensity, and duration of rainfall, also affect water yield. These characteristics vary widely throughout the United States. Each must be considered when evaluating the watershed area conditions for a particular pond site.

Figure 11 is a general guide for estimating the approximate size of drainage area needed for a desired water-storage capacity. For example, a pond located in west-central Kansas with a capacity of 5 acre-feet requires a drainage area of at least 175 acres under normal conditions. If reliable local runoff information is available, use it in preference to the guide.

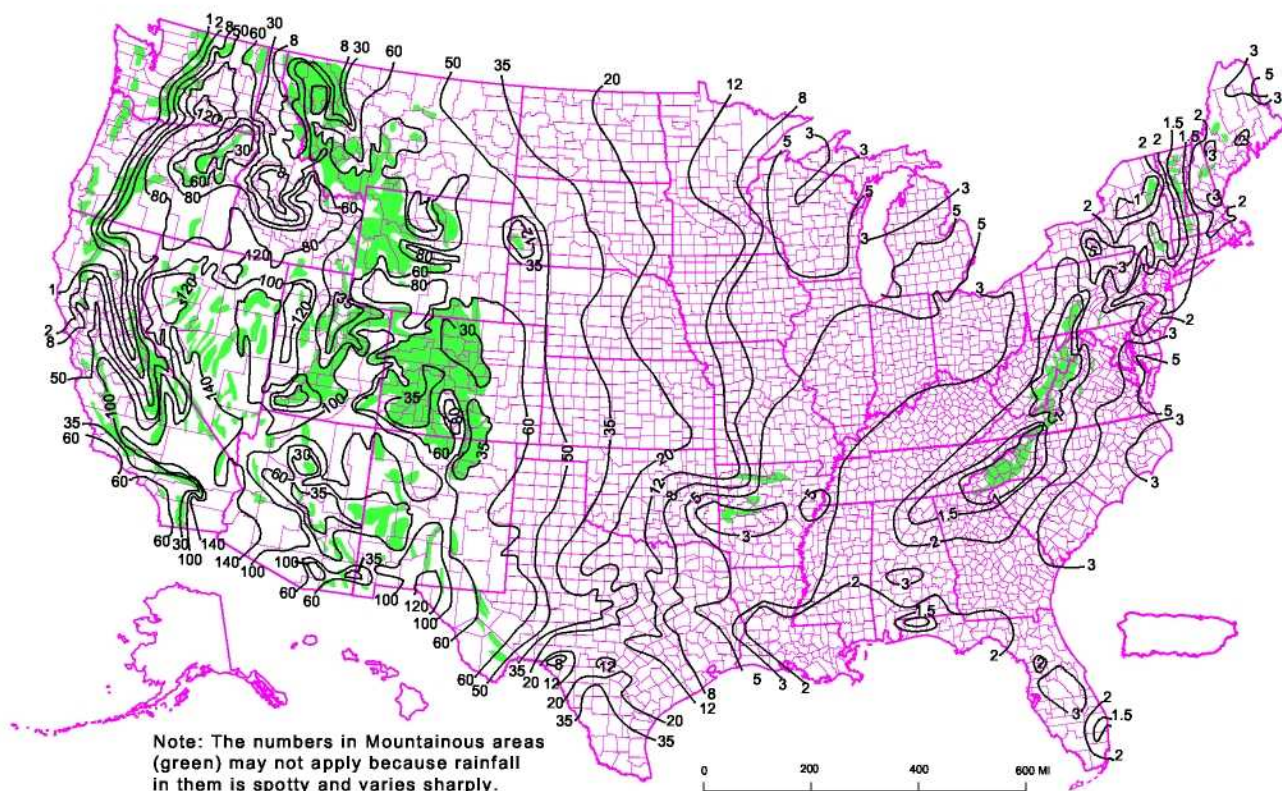
Average physical conditions in the area are assumed to be the normal runoff-producing characteristics for a drainage area, such as moderate slopes, normal soil infiltration, fair to good plant cover, and normal surface storage.

To apply the information given in figure 11, some adjustments may be necessary to meet local conditions. Modify the values in the figure for drainage areas having characteristics other than normal. Reduce the values by as much as 25 percent for drainage areas having extreme runoff-producing characteristics. Increase them by 50 percent or more for low runoff-producing characteristics.

### Minimum pond depth

To ensure a permanent water supply, the water must be deep enough to meet the intended use requirements and to offset probable seepage and evaporation losses. These vary in different sections of the country and from year to year in any one section. Figure 12 shows the recommended minimum depth of water for ponds if seepage and evaporation losses are normal. Deeper ponds are needed where a permanent or year-round water supply is essential or where seepage losses exceed 3 inches per month.

**Figure 11** A guide for estimating the approximate size of a drainage area (in acres) required for each acre-foot of storage in an embankment or excavated pond





### Drainage area protection

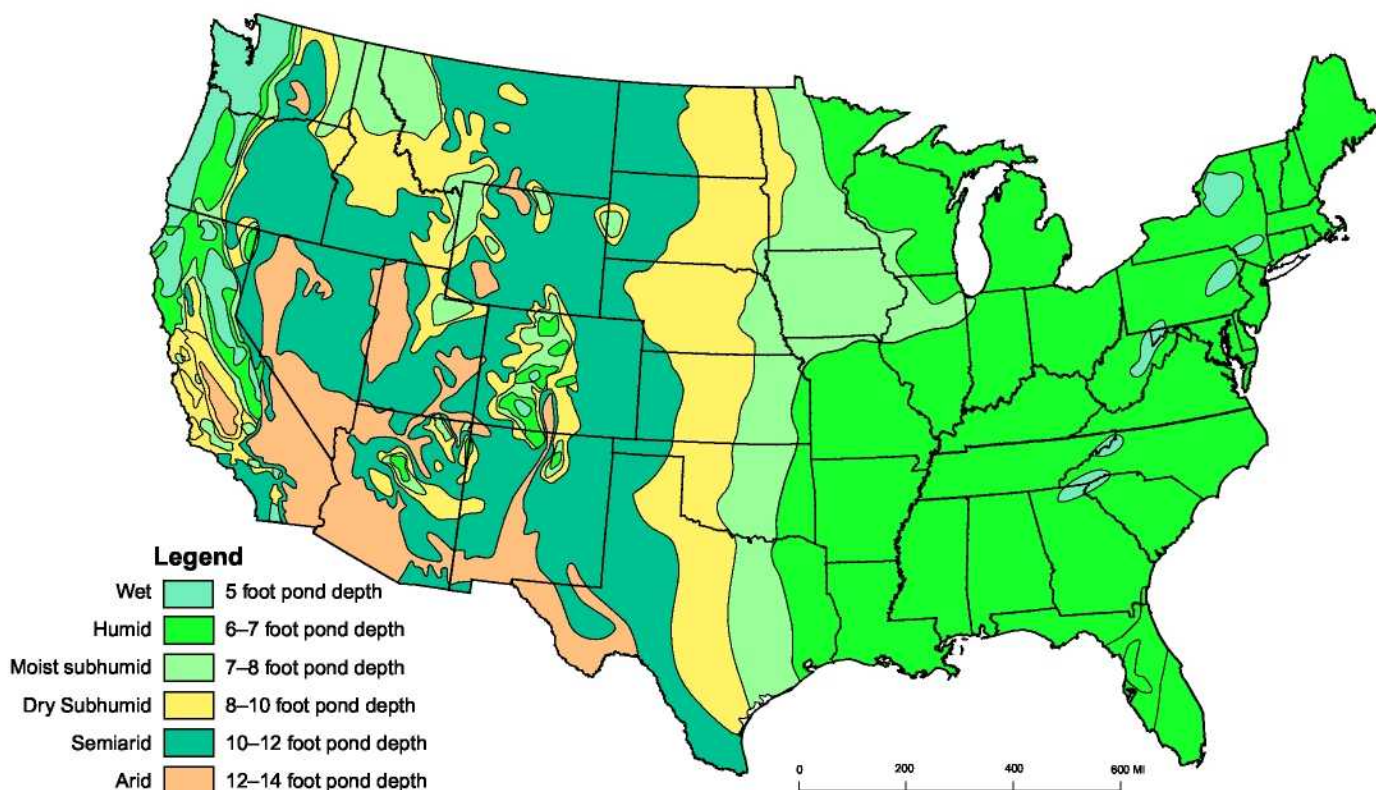
To maintain the required depth and capacity of a pond, the inflow must be reasonably free of silt from an eroding watershed. The best protection is adequate application and maintenance of erosion control practices on the contributing drainage area. Land under permanent cover of trees, grass, or forbs is the most desirable drainage area (fig. 13). Cultivated areas protected by conservation practices, such as terraces, conservation tillage, stripcropping, or conservation cropping systems, are the next best watershed conditions.

If an eroding or inadequately protected watershed must be used to supply pond water, delay pond construction until conservation practices are established. In any event, protection of the drainage area should be started as soon as you decide to build a pond.

**Figure 13** Land with permanent vegetation makes the most desirable drainage area



**Figure 12** Recommended minimum depth of water for ponds in the United States



## Pond capacity

Estimate pond capacity to be sure that enough water is stored in the pond to satisfy the intended use requirements. A simple method follows:

- Establish the normal pond-full water elevation and stake the waterline at this elevation.
- Measure the width of the valley at this elevation at regular intervals and use these measurements to compute the pond-full surface area in acres.
- Multiply the surface area by 0.4 times the maximum water depth in feet measured at the dam.

For example, a pond with a surface area of 3.2 acres and a depth of 12.5 feet at the dam has an approximate capacity of 16 acre-feet ( $0.4 \times 3.2 \times 12.5 = 16$  acre-feet) [1 acre-foot = 325,651 gallons].

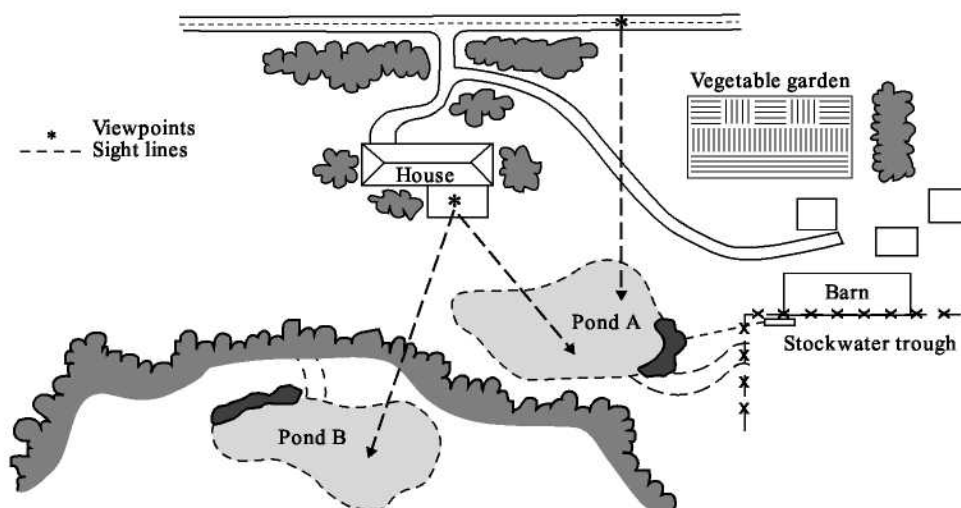
## Landscape evaluation

Alternative pond sites should be evaluated for potential visibility and compatibility with surrounding landscape characteristics and use patterns (fig. 14). Identify major viewpoints (points from which the site is viewed) and draw the important sight lines with cross sections, where needed, to determine visibility. If feasible, locate the pond so that the major sight line crosses the longest dimension of water surface. The pond should be placed so that a viewer will see the water first before noticing the dam, pipe inlet, or spillway. Often, minor changes in the dam alignment and spillway location can shift these elements out of view and reduce their prominence.

If possible, locate your pond so that some existing trees and shrubs remain along part of the shoreline. Vegetation adds aesthetic value by casting reflections on the water, provides shade on summer days, and helps blend the pond into the surrounding landscape. A pond can often be located and designed so that an island is created for recreation, wildlife habitat, or visual interest.

In addition to the more typical farm and residential sites, ponds can be located on poor quality landscapes to rehabilitate abandoned road borrow areas, dumping sites, abandoned rural mines, and other low production areas.

**Figure 14** A preliminary study of two alternative sites for a pond to be used for livestock water, irrigation, and recreation





## Estimating storm runoff

The amount of precipitation, whether it occurs as rain or snow, is the potential source of water that may run off small watersheds. The kind of soil and the type of vegetation affect the amount of water that runs off. Terraces and diversions, along with steepness and shape of a watershed, affect the rate at which water runs off.

A spillway is provided to bypass surface runoff after the pond is filled. The tables and charts in the following sections should be used to estimate the peak discharge rates for the spillway. They provide a quick and reliable estimate of runoff rates and associated volumes for a range of storm rainfall amounts, soil groups, land use, cover conditions, and watershed slopes.

## Hydrologic groupings of soils

Soils are classified in four hydrologic groups according to infiltration and transmission rates:

A—These soils have a high infiltration rate. They are chiefly deep, well-drained sand or gravel. The runoff potential is low.

B—These soils have a moderate infiltration rate when thoroughly wet. They are chiefly moderately deep, well-drained soils of moderately fine to moderately coarse texture.

C—These soils have a slow infiltration rate when wet. These moderately fine to fine texture soils have a layer that impedes downward movement of water.

D—These soils have a very slow infiltration rate. They are chiefly clay soils that have a high swelling potential, soils with a permanent high water table, soils with a claypan at or near the surface, and shallow soils over nearly impervious material. The runoff potential is high.

The NRCS district conservationist or your county extension agent can help you classify the soils for a given pond site in one of the four hydrologic groups.

## Runoff curve numbers

Tables 1 through 4 show numerical runoff ratings for a range of soil-use-cover complexes. Because these numbers relate to a set of curves developed from the NRCS runoff equation, they are referred to as curve numbers (CN) in these tables.

The watershed upstream from a farm pond often contains areas represented by different curve numbers. A weighted curve number can be obtained based on the percentage of area for each curve number. For example, assume that the watershed above a pond is mainly (three-fourths) in good pasture and a soil in hydrologic group B. The remainder is cultivated with conservation treatment on a soil in hydrologic group C.

A weighted curve number for the total watershed would be:

$$\begin{aligned} 3/4 \times 61 &= 46 \text{ (approximately)} \\ 1/4 \times 76 &= 20 \text{ (approximately)} \\ \text{Weighted} &= 66 \end{aligned}$$

**Table 1** Runoff curve numbers for urban areas <sup>1/</sup>

Cover description	Average percent impervious area <sup>2/</sup>	Curve numbers for hydrologic soil group			
		A	B	C	D
<b>Fully developed urban areas (vegetation established)</b>					
Open space (lawns, parks, golf courses, cemeteries, etc.) <sup>3/</sup>					
Poor condition (grass cover < 50%)		68	79	86	89
Fair condition (grass cover 50 to 75%)		49	69	79	84
Good condition (grass cover > 75%)		39	61	74	80
Impervious areas:					
Paved parking lots, roofs, driveways, etc. (excluding right-of-way)		98	98	98	98
Streets and roads:					
Paved; curbs and storm sewers (excluding right-of-way)		98	98	98	98
Paved; open ditches (including right-of-way)		83	89	92	93
Gravel (including right-of-way)		76	85	89	91
Dirt (including right-of-way)		72	82	87	89
Western desert urban areas:					
Natural desert landscaping (pervious areas only) <sup>4/</sup>		63	77	85	88
Artificial desert landscaping (impervious weed barrier, desert shrub with 1- to 2-inch sand or gravel mulch and basin borders)		96	96	96	96
Urban districts:					
Commercial and business	85	89	92	94	95
Industrial	72	81	88	91	93
Residential districts by average lot size:					
1/8 acre or less (town houses)	65	77	85	90	92
1/4 acre	38	61	75	83	87
1/3 acre	30	57	72	81	86
1/2 acre	25	54	70	80	85
1 acre	20	51	68	79	84
2 acres	12	46	65	77	82
<b>Developing urban areas</b>					
Newly graded areas (pervious areas only, no vegetation) <sup>5/</sup>		77	86	91	94
Idle lands (CN's are determined using cover types similar to those in table 3)					

1/ Average runoff condition, and  $I_a = 0.2S$ .

2/ The average percent impervious area shown was used to develop the composite CN's. Other assumptions are as follows: impervious areas are directly connected to the drainage system, impervious areas have a CN of 98, and pervious areas are considered equivalent to open space in good hydrologic condition. CN's for other combinations of conditions may be computed using figure 2-3 or 2-4 in NRCS Technical Release 55, Urban Hydrology for Small Watersheds.

3/ CN's shown are equivalent to those of pasture. Composite CN's may be computed for other combinations of open space cover type.

4/ Composite CN's for natural desert landscaping should be computed using figure 2-3 or 2-4 in Technical Release 55, based on the impervious area percentage (CN = 98) and the pervious area CN. The pervious area CN's are assumed equivalent to desert shrub in poor hydrologic condition.

5/ Composite CN's to use for the design of temporary measures during grading and construction should be computed using figure 2-3 or 2-4 in Technical Release 55, based on the degree of development (impervious area percentage) and the CN's for the newly graded pervious areas.



**Table 2** Runoff curve numbers for agricultural lands <sup>1/</sup>

Cover type	Cover description		Curve numbers for hydrologic soil group			
	Treatment <sup>2/</sup>	Hydrologic condition <sup>3/</sup>	A	B	C	D
Fallow	Bare soil	—	77	86	91	94
	Crop residue cover (CR)	Poor	76	85	90	93
		Good	74	83	88	90
Row crops	Straight row (SR)	Poor	72	81	88	91
		Good	67	78	85	89
	SR + CR	Poor	71	80	87	90
		Good	64	75	82	85
	Contoured (C)	Poor	70	79	84	88
		Good	65	75	82	86
	C + CR	Poor	69	78	83	87
		Good	64	74	81	85
	Contoured & terraced (C&T)	Poor	66	74	80	82
		Good	62	71	78	81
	C&T + CR	Poor	65	73	79	81
		Good	61	70	77	80
Small grain	SR	Poor	65	76	84	88
		Good	63	75	83	87
	SR + CR	Poor	64	75	83	86
		Good	60	72	80	84
	C	Poor	63	74	82	85
		Good	61	73	81	84
	C + CR	Poor	62	73	81	84
		Good	60	72	80	83
	C&T	Poor	61	72	79	82
		Good	59	70	78	81
	C&T + CR	Poor	60	71	78	81
		Good	58	69	77	80
Closed-seeded or broadcast legumes or rotation meadow	SR	Poor	66	77	85	89
		Good	58	72	81	85
	C	Poor	64	75	83	85
		Good	55	69	78	83
	C&T	Poor	63	73	80	83
		Good	51	67	76	80

1/ Average runoff condition, and  $I_a = 0.2S$ .

2/ Crop residue cover applies only if residue is on at least 5 percent of the surface throughout the year.

3/ Hydrologic condition is based on combination of factors that affect infiltration and runoff, including (a) density and canopy of vegetative areas, (b) amount of year-round cover, (c) amount of grass or close-seeded legumes in rotations, (d) percentage of residue cover on the land surface (good > 20%), and (e) degree of surface roughness.

Poor: Factors impair infiltration and tend to increase runoff.

Good: Factors encourage average and better than average infiltration and tend to decrease runoff.

**Table 3** Runoff curve numbers for other agricultural lands <sup>1/</sup>

Cover type	Cover description	Hydrologic condition <sup>3/</sup>	Curve numbers for hydrologic soil group			
			A	B	C	D
Pasture, grassland, or range—continuous grazing <sup>2/</sup>		Poor	68	79	86	89
		Fair	49	69	79	84
		Good	39	61	74	80
Meadow—continuous grass, protected from grazing and generally mowed for hay		—	30	58	71	78
Brush—brush-weed-grass mixture with brush the major element <sup>3/</sup>		Poor	48	67	77	83
		Fair	35	56	70	77
		Good	30 <sup>4/</sup>	48	65	73
Woods—grass combination (orchard or tree farm) <sup>5/</sup>		Poor	57	73	82	86
		Fair	43	65	76	82
		Good	32	58	72	79
Woods <sup>6/</sup>		Poor	45	66	77	83
		Fair	36	60	73	79
		Good	30 <sup>4/</sup>	55	70	77
Farmsteads—buildings, lanes, driveways, and surrounding lots.		—	59	74	82	86

1/ Average runoff condition, and  $I_a = 0.2S$ .

2/ Poor: <50% ground cover or heavily grazed with no mulch.

Fair: 50 to 75% ground cover and not heavily grazed.

Good: >75% ground cover and lightly or only occasionally grazed.

3/ Poor: <50% ground cover.

Fair: 50 to 75% ground cover.

Good: >75% ground cover.

4/ Actual curve number is less than 30; use CN = 30 for runoff computations.

5/ CN's shown were computed for areas with 50% woods and 50% grass (pasture) cover. Other combinations of conditions may be computed from the CN's for woods and pasture.

6/ Poor: Forest litter, small trees, and brush are destroyed by heavy grazing or regular burning.

Fair: Woods are grazed but not burned, and some forest litter covers the soil.

Good: Woods are protected from grazing, and litter and brush adequately cover the soil.



**Table 4** Runoff curve numbers for arid and semiarid rangelands <sup>1/</sup>

Cover type	Cover description	Hydrologic condition <sup>2/</sup>	Curve numbers for hydrologic soil group			
			A <sup>3/</sup>	B	C	D
Herbaceous—mixture of grass, forbs, and low-growing brush, with brush the minor element		Poor	—	80	87	93
		Fair	—	71	81	89
		Good	—	62	74	85
Oak-aspen—mountain brush mixture of oak brush, aspen, mountain mahogany, bitter brush, maple, and other brush.		Poor	—	66	74	79
		Fair	—	48	57	63
		Good	—	30	41	48
Pinyon-juniper—pinyon, juniper, or both grass understory		Poor	—	75	85	89
		Fair	—	58	73	80
		Good	—	41	61	71
Sagebrush with grass understory		Poor	—	67	80	85
		Fair	—	51	63	70
		Good	—	35	47	55
Desert shrub—major plants include saltbush, greasewood, creosotebush, blackbrush, bursage, palo verde, mesquite, and cactus		Poor	63	77	85	88
		Fair	55	72	81	86
		Good	49	68	79	84

1/ Average runoff condition, and  $I_a = 0.2S$ . For range in humid regions, use table 3.

2/ Poor: <30% ground cover (litter, grass, and brush overstory).

Fair: 30 to 70% ground cover.

Good: >70% ground cover.

3/ Curve numbers for group A have been developed only for desert shrub.

**Volume of storm runoff**

Often knowing how much water runs off from a big storm as well as the rate at which it flows is good. The volume is needed to compute needed storage as well as the peak discharge rate.

The figures in table 5 are the depth (in inches) at which the storm runoff, if spread evenly, would cover

the entire watershed. For example, the volume of runoff from a 3-inch rainfall on a 100-acre watershed with the weighted curve number of 66 would be:

0.55 inch (interpolated between 0.51 and 0.72 inches)  
 100 acres x 0.55 inch = 55 acre-inches  
 55 acre-inches ÷ 12 = 4.55 acre-feet  
 55 acre-inches x 27,152 gallons per acre-inch = 1.5 million gallons (approximately)

**Table 5** Runoff depth, in inches

Rainfall (inches)	Curve number						
	60	65	70	75	80	85	90
1.0	0	0	0	0.03	0.08	0.17	0.32
1.2	0	0	0.03	0.07	0.15	0.28	0.46
1.4	0	0.02	0.06	0.13	0.24	0.39	0.61
1.6	0.01	0.05	0.11	0.20	0.34	0.52	0.76
1.8	0.03	0.09	0.17	0.29	0.44	0.65	0.93
2.0	0.06	0.14	0.24	0.38	0.56	0.80	1.09
2.5	0.17	0.30	0.46	0.65	0.89	1.18	1.53
3.0	0.33	0.51	0.72	0.96	1.25	1.59	1.98
4.0	0.76	1.03	1.33	1.67	2.04	2.46	2.92
5.0	1.30	1.65	2.04	2.45	2.89	3.37	3.88
6.0	1.92	2.35	2.87	3.28	3.78	4.31	4.85
7.0	2.60	3.10	3.62	4.15	4.69	5.26	5.82
8.0	3.33	3.90	4.47	5.04	5.62	6.22	6.81
9.0	4.10	4.72	5.34	5.95	6.57	7.19	7.79
10.0	4.90	5.57	6.23	6.88	7.52	8.16	8.78
11.0	5.72	6.44	7.13	7.82	8.48	9.14	9.77
12.0	6.56	7.32	8.05	8.76	9.45	10.12	10.76



## Rainfall amounts and expected frequency

Maps in U.S. Weather Bureau Technical Paper 40 (USWP-TP-40), Rainfall Frequency Atlas of the United States, show the amount of rainfall expected in a 24-hour period. These maps have also been reprinted in Hydrology for Small Urban Watershed, Technical Release 55. Contact your local NRCS field office for rainfall amounts on maps.

Designing an ordinary pond spillway to accommodate the peak rate of runoff from the most intense rain-storm ever known or anticipated is not practical. The spillway for an ordinary farm pond generally is designed to pass the runoff from a 25-year frequency storm. This means a storm with only a 4 percent chance of occurring in any year or the size beyond which larger storms would not occur more often than an average of once in 25 years. Designing for a 50-year storm frequency is recommended for spillways for

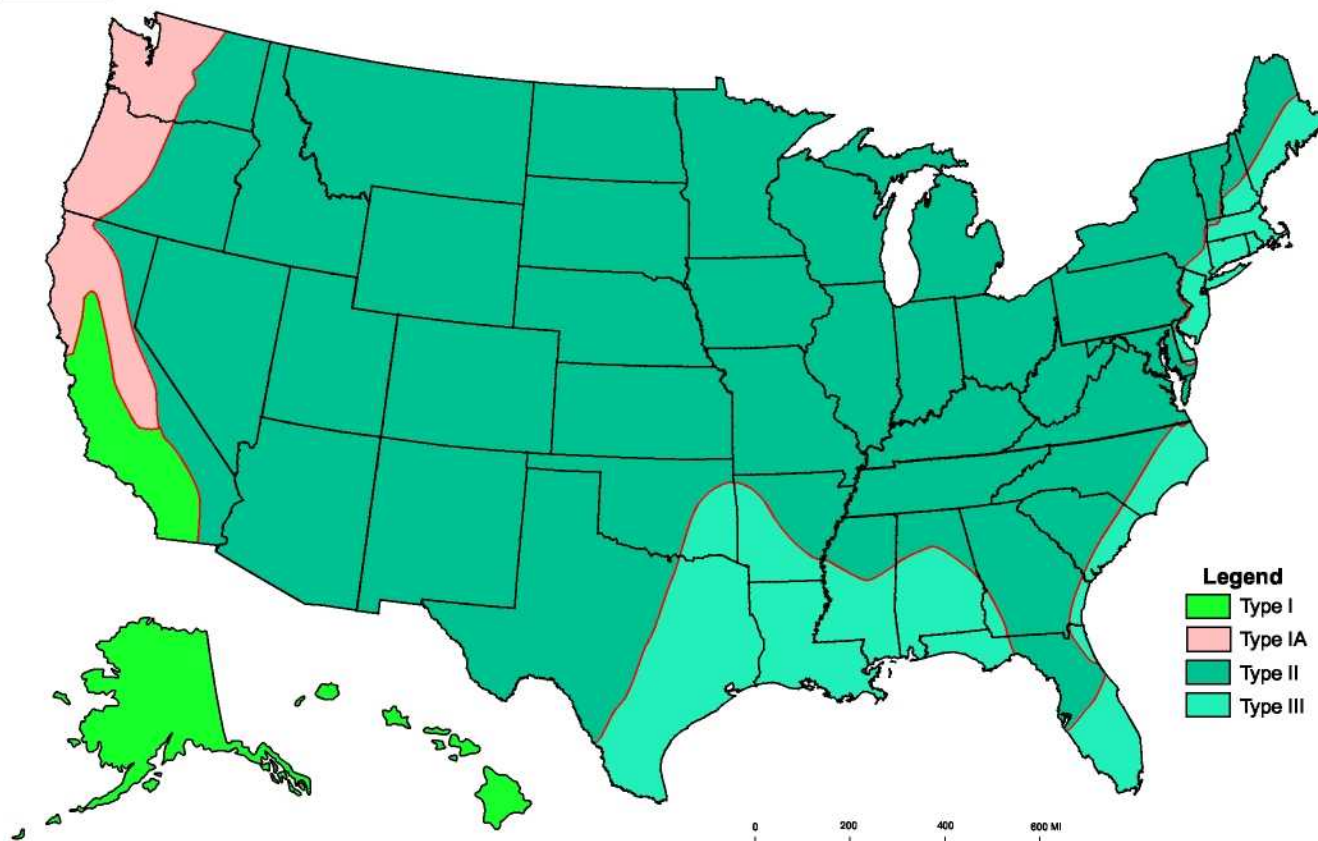
larger dams. A 10-year storm frequency may be adequate for sizing the spillway in small ponds.

## Rainfall distribution

The highest peak discharges from small watersheds are usually caused by intense, brief rainfalls that may occur as part of a longer duration storm. Different rainfall distributions with respect to time have been developed for four geographic areas of the United States. For each of these areas, a set of synthetic rainfall distributions having nested rainfall intensities were developed. These distributions maximize the rainfall intensities by incorporating selected storm duration intensities within those needed for longer durations at the same probability level.

In figure 15, type I and IA represent the Pacific maritime climate with wet winters and dry summers. Type III represents Gulf of Mexico and Atlantic coastal areas where tropical storms bring large rainfall amounts. Type II represents the rest of the country.

**Figure 15** Approximate geographic boundaries for NRCS rainfall distributions



### Peak discharge rate

The slope of the land above the pond affects the peak discharge rate significantly. The time of concentration along with the runoff curve number, storm rainfall, and rainfall distribution are used to estimate the peak discharge rate. This rate is used to design the auxiliary spillway width and depth of flow.

shorter the  $T_c$ , the larger the peak discharge. This means that the peak discharge has an inverse relationship with  $T_c$ .  $T_c$  can be estimated for small rural watersheds using equation 1. Figure 16 is a nomograph for solving this equation.

$$T_c = \frac{l^{0.8} \left[ \frac{(1000) - 9}{CN} \right]^{0.7}}{1140 Y^{0.5}} \quad [\text{Eq. 1}]$$

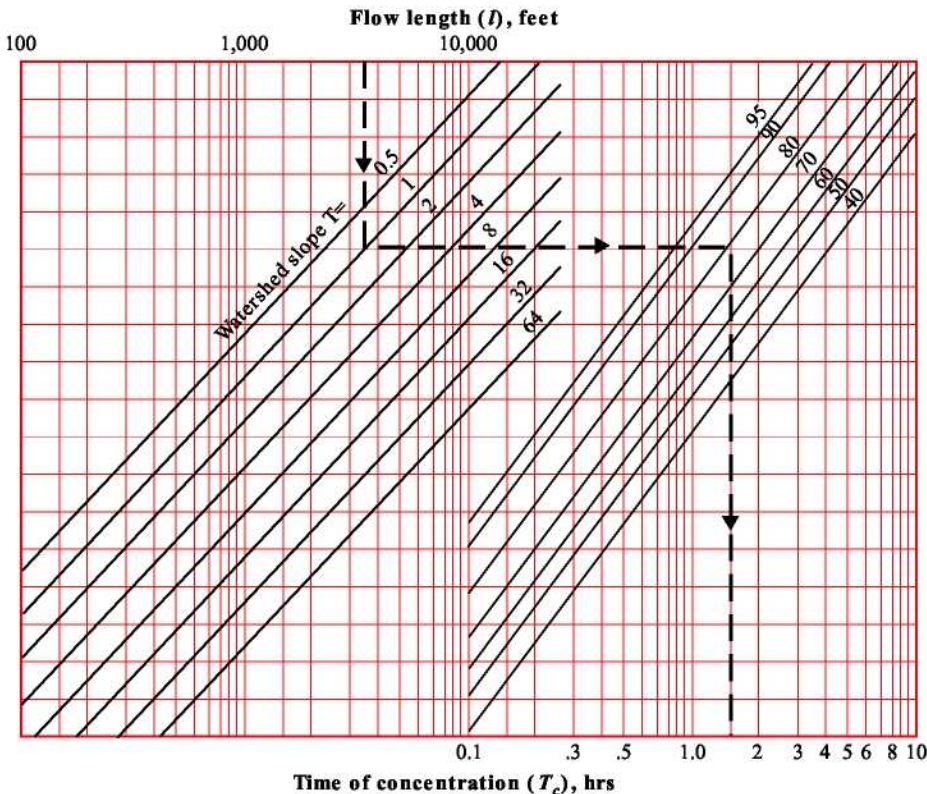
### Time of concentration

Time of concentration ( $T_c$ ) is the time it takes for runoff to travel from the hydraulically most distant point of the watershed to the outlet.  $T_c$  influences the peak discharge and is a measure of how fast the water runs off the land. For the same size watershed, the

where:

- $T_c$  = time of concentration, hr
- $l$  = flow length, ft
- $CN$  = runoff curve number
- $Y$  = average watershed slope, %

**Figure 16** Time of concentration ( $T_c$ ) nomograph



## Average watershed slope

The average watershed slope ( $Y$ ) is the slope of the land and not the watercourse. It can be determined from soil survey data or topographic maps. Hillside slopes can be measured with a hand level, lock level, or clinometer in the direction of overland flow. Average watershed slope is an average of individual land slope measurements. The average watershed slope can be determined using equation 2:

$$Y = \frac{100CI}{A} \quad [\text{Eq. 2}]$$

where:

- $Y$  = average slope, %
- $C$  = total contour length, ft
- $I$  = contour interval, ft
- $A$  = drainage area, ft<sup>2</sup>

## Flow length

Flow length ( $l$ ) is the longest flow path in the watershed from the watershed divide to the outlet. It is the total path water travels overland and in small channels on the way to the outlet. The flow length can be determined using a map wheel, or it can be marked along the edge of a paper and converted to feet.

## $I_a/P$ ratio

The watershed CN is used to determine the initial abstraction ( $I_a$ ) from table 6.  $I_a/P$  ratio is a parameter that indicates how much of the total rainfall is needed to satisfy the initial abstraction. The larger the  $I_a/P$  ratio, the lower the unit peak discharge ( $q_u$ ) for a given  $T_c$ .

**Table 6**  $I_a$  values for runoff curve numbers

Curve number	$I_a$ (in)	Curve number	$I_a$ (in)
40	3.000	70	0.857
41	2.878	71	0.817
42	2.762	72	0.778
43	2.651	73	0.740
44	2.545	74	0.703
45	2.444	75	0.667
46	2.348	76	0.632
47	2.255	77	0.597
48	2.167	78	0.564
49	2.082	79	0.532
50	2.000	80	0.500
51	1.922	81	0.469
52	1.846	82	0.439
53	1.774	83	0.410
54	1.704	84	0.381
55	1.636	85	0.353
56	1.571	86	0.326
57	1.509	87	0.299
58	1.448	88	0.273
59	1.390	89	0.247
60	1.333	90	0.222
61	1.279	91	0.198
62	1.226	92	0.174
63	1.175	93	0.151
64	1.125	94	0.128
65	1.077	95	0.105
66	1.030	96	0.083
67	0.985	97	0.062
68	0.941	98	0.041
69	0.899		



## Estimating peak discharge rates

The unit peak discharge ( $q_u$ ) is obtained from figure 17 depending on the rainfall type. Figure 15 shows the approximate geographic boundaries for the four rainfall distributions.  $T_c$  and  $I_a/P$  values are needed to obtain a value for  $q_u$  from the exhibit. The peak discharge ( $q_p$  in ft<sup>3</sup>/s) is computed as the product of the unit peak discharge ( $q_u$  in ft<sup>3</sup>/s/ac-in), the drainage area ( $A$  in acres), and the runoff ( $Q$  in inches).

$$q_p = q_u \times A \times Q \quad [\text{Eq. 3}]$$

### Example 1 Estimating peak discharge rates

#### Known:

Drainage area = 50 acres  
 Cole County, Missouri  
 Flow Path  $l' = 1,600$  feet  
 Watershed Slope  $\%Y = 4$  percent  
 25-year, 24-hour rainfall = 6 inches  
 Type II rainfall distribution  
 Runoff Curve Number = 66  
 (from example in runoff curve number section)

#### Solution:

Find  $T_c$

Enter figure 16,  $T_c = 0.60$  hours

Find  $I_a/P$

Enter table 6, use CN = 66,  $I_a = 1.030$

$I_a/P = 1.030/6.0$  inches = 0.172

Find runoff

Enter table 5, at rainfall = 6.0 inches  
 and runoff curve number = 66,

Read runoff = 2.44 inches. (Note: It was necessary to interpolate between RCN 65 and 70.)

Find the peak discharge for spillway design.

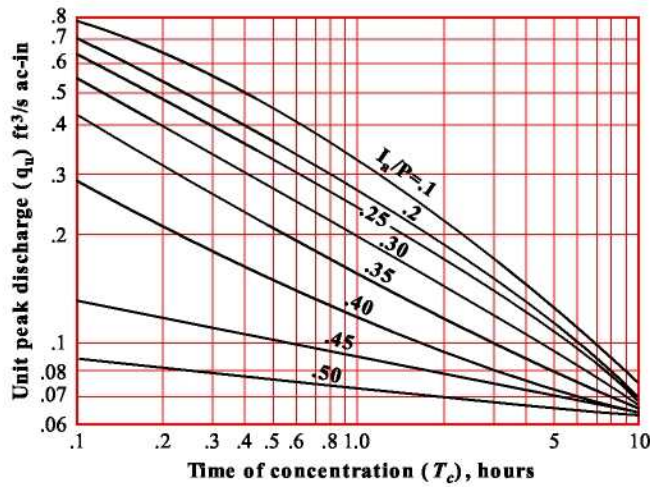
Enter figure 17(c):

$$q_u = 0.7$$

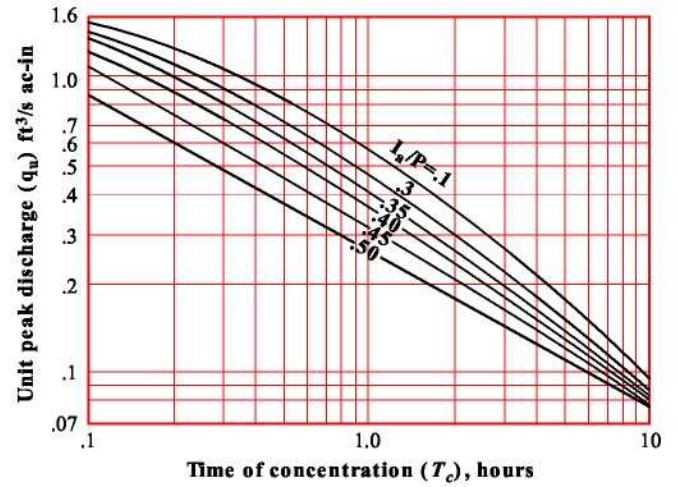
$$q_p = q_u \times A \times Q$$

$$q_p = 0.7 \times 50 \times 2.44 = 85 \text{ ft}^3/\text{s}$$

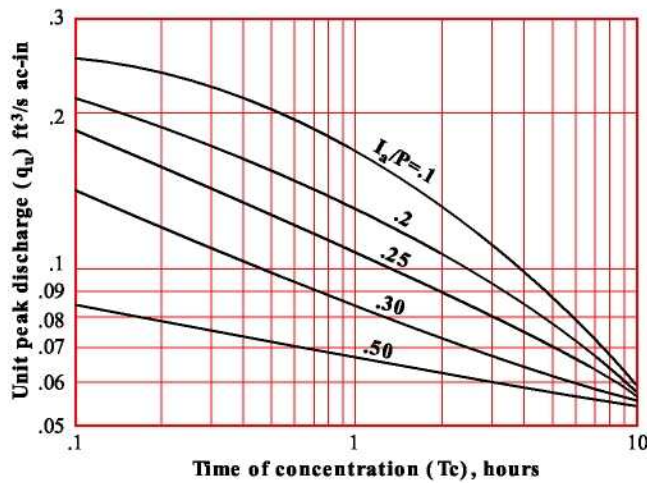
**Figure 17a** Unit peak discharge ( $q_u$ ) for Type I storm distribution



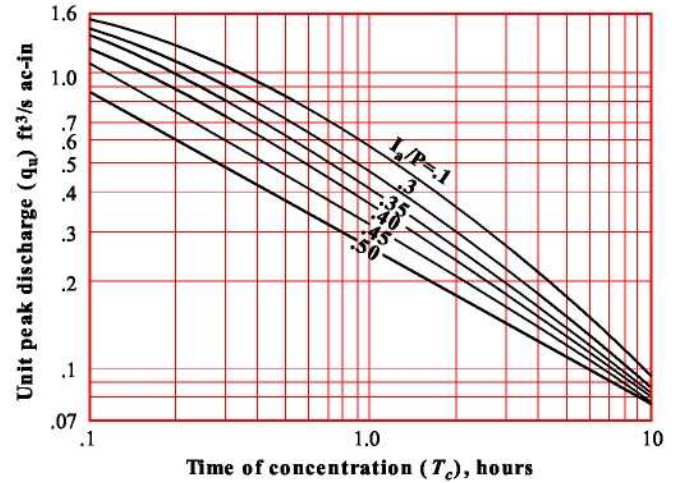
**Figure 17c** Unit peak discharge ( $q_u$ ) for Type II storm distribution



**Figure 17b** Unit peak discharge ( $q_u$ ) for Type IA storm distribution



**Figure 17d** Unit peak discharge ( $q_u$ ) for Type III storm distribution



## Site surveys

Once you determine the probable location of the pond, conduct a site survey to plan and design the dam, spillways, and other features. Those unfamiliar with the use of surveying instruments should employ a licensed surveyor or other qualified professional.

Pond surveys generally consist of a profile of the centerline of the dam, a profile of the centerline of the earth spillway, and enough measurements to estimate pond capacity. A simple method of estimating pond capacity is described on page 12. For larger and more complex ponds, particularly those used for water supply or irrigation, you may need a complete topographic survey of the entire pond site.

Run a line of profile level surveys along the centerline of the proposed dam and up both sides of the valley well above the expected elevation of the top of the dam and well beyond the probable location of the auxiliary spillway. The profile should show the surface elevation at all significant changes in slope and at intervals of no more than 100 feet. This line of levels establishes the height of the dam and the location and elevation of the earth spillway and the principal spillway. It is also used to compute the volume of earthfill needed to build the dam.

Run a similar line of profile levels along the centerline of the auxiliary spillway. Start from a point on the upstream end that is well below the selected normal water surface elevation and continue to a point on the downstream end where water can be safely discharged without damage to the dam. This line serves as a basis for determining the slope and dimensions of the spillway.

All surveys made at a pond site should be tied to a reference called a bench mark. This may be a large spike driven into a tree, an iron rod driven flush with the ground, a point on the concrete headwall of a culvert, or any object that will remain undisturbed during and after construction of the dam.

## Embankment ponds

### Detailed soils investigation

**Soils in the ponded area**—Suitability of a pond site depends on the ability of the soils in the reservoir area to hold water. The soil should contain a layer of material that is impervious and thick enough to prevent excessive seepage. Clays and silty clays are excellent for this purpose; sandy and gravelly clays are usually satisfactory. Generally, soils with at least 20 percent passing the No. 200 sieve, a Plasticity Index of more than 10 percent, and an undisturbed thickness of at least 3 feet do not have excessive seepage when the water depth is less than 10 feet. Coarse-textured sands and sand-gravel mixtures are highly pervious and therefore usually unsuitable. The absence of a layer of impervious material over part of the ponded area does not necessarily mean that you must abandon the proposed site. You can treat these parts of the area by one of several methods described later in this handbook. Any of these methods can be expensive.

Some limestone areas are especially hazardous as pond sites. Crevices, sinks, or channels that are not visible from the surface may be in the limestone below the soil mantle. They may empty the pond in a short time. In addition, many soils in these areas are granular. Because the granules do not break down readily in water, the soils remain highly permeable. All the factors that may make a limestone site undesirable are not easily recognized without extensive investigations and laboratory tests. The best clue to the suitability of a site in one of these areas is the degree of success others have had with farm ponds in the immediate vicinity.

Unless you know that the soils are sufficiently impervious and that leakage will not be a problem, you should make soil borings at intervals over the area to be covered with water. Three or four borings per acre may be enough if the soils are uniform. More may be required if there are significant differences.

**Foundation conditions**—The foundation under a dam must ensure stable support for the structure and provide the necessary resistance to the passage of water.



Soil borings help to investigate thoroughly the foundation conditions under the proposed dam site. The depth of the holes should be at least 1-1/2 times the height of the proposed dam. Ensure there are not any steep dropoffs in the rock surface of the foundation under the dam. Steep dropoffs in the rock surface can result in cracking of the embankment. Study the natural banks (abutments) at the ends of the dam as well as the supporting materials under the dam. If the dam is to be placed on rock, the rock must be examined for thickness and for fissures and seams through which water might pass.

Coarse-textured materials, such as gravel, sand, and gravel-sand mixtures, provide good support for a dam, but are highly pervious and do not hold water. Such materials can be used only if they are sealed to prevent seepage under the dam. You can install a cutoff core trench of impervious material under the dam or blanket the upstream face of the dam and the pond area with a leak-resistant material.

Fine-textured materials, such as silts and clays, are relatively impervious, but have a low degree of stability. They are not good foundation materials, but generally are satisfactory for the size of dams discussed in this handbook. Flattening the side slopes of some dams may be necessary to reduce the unit load on the foundation. Remove peat, muck, and any soil that has a high organic-matter content from the foundation.

Good foundation materials, those that provide both stability and imperviousness, are a mixture of coarse- and fine-textured soils. Some examples are gravel-sand-clay mixtures, gravel-sand-silt mixtures, sand-clay mixtures, and sand-silt mixtures.

Less desirable but still acceptable foundation materials for ordinary pond dams are gravelly clays, sandy clays, silty clays, silty and clayey fine sands, and clayey silts that have slight plasticity.

**Fill material**—The availability of suitable material for building a dam is a determining factor in selecting a pond site. Enough suitable material should be located close to the site so that placement costs are not excessive. If fill material can be taken from the reservoir area, the surrounding landscape will be left undisturbed and borrow areas will not be visible after the pond has been filled (fig. 18).

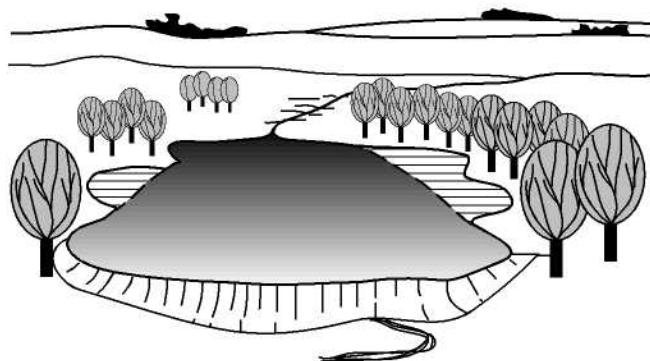
Materials selected must have enough strength for the dam to remain stable and be tight enough, when properly compacted, to prevent excessive or harmful percolation of water through the dam. Soils described as acceptable for foundation material generally are acceptable for fill material. The exceptions are organic silts and clays.

The best material for an earthfill contains particles ranging from small gravel or coarse sand to fine sand and clay in the desired proportions. This material should contain about 20 percent, by weight, clay particles. Though satisfactory earthfills can be built from soils that vary from the ideal, the greater the variance, the more precautions needed.

Soils containing a high percentage of gravel or coarse sand are pervious and can allow rapid seepage through the dam. When using these soils, place a core of clay material in the center of the fill and flatten the side slopes to keep the line of seepage from emerging on the downstream slope.

Fill material that has a high clay content swells when wet and shrinks when dry. The shrinkage may open dangerous cracks. If these soils are dispersive, they represent a serious hazard to the safety of the embankment and should be avoided. Dispersive soils can be identified by how easily they go into suspension in water, by the presence of a gelatinous cloud around a clod of soil in distilled water, and by the indefinite

**Figure 18** Borrow material taken from within the reservoir area creates an irregular pond configuration



length of time they stay in suspension in still water. High sodium soils identified in the soil survey for the planned area of the embankment also indicate dispersive soils. If any of these indicators are found at the proposed site, an engineer should be hired to provide the necessary guidance for sampling, testing, and using these soils for fill. For soils consisting mostly of silt, such as the loess areas of western Iowa and along the Mississippi River in Arkansas, Mississippi, and Tennessee, the right degree of moisture must be maintained during construction for thorough compaction.

To estimate the proportion of sand, silt, and clay in a sample of fill material, first obtain a large bottle with straight sides. Take a representative sample of the fill material and remove any gravel by passing the material through a 1/4-inch sieve or screen. Fill the bottle to about one-third with the sample material and finish filling with water. Shake the bottle vigorously for several minutes and then allow the soil material to settle for about 24 hours. The coarse material (sand) settles to the bottom first, and finer material (clay) settles last. Estimate the proportion of sand, silt, and clay by measuring the thickness of the different layers with a ruler.

**Landscape planning**—The pond should be located and designed to blend with the existing landform, vegetation, water, and structures with minimum disturbance. Landforms can often form the impoundment with minimum excavation. Openings in the vegetation can be used to avoid costly clearing and grubbing. Existing structures, such as stone walls and trails, can be retained to control pedestrian and vehicular traffic and minimize disruption of existing use. In the area where land and water meet, vegetation and landform can provide interesting reflections on the water's surface, guide attention to or from the water, frame the water to emphasize it, and direct passage around the pond.

A pond's apparent size is not always the same as its actual size. For example, the more sky reflected on the water surface, the larger a pond appears. A pond surrounded by trees will appear smaller than a pond the same size without trees or with some shoreline trees (fig. 19). The shape of a pond should complement its surroundings. Irregular shapes with smooth, flowing shorelines generally are more compatible with the patterns and functions found in most landscapes.

Peninsulas, inlets, or islands can be constructed to create diversity in the water's edge.

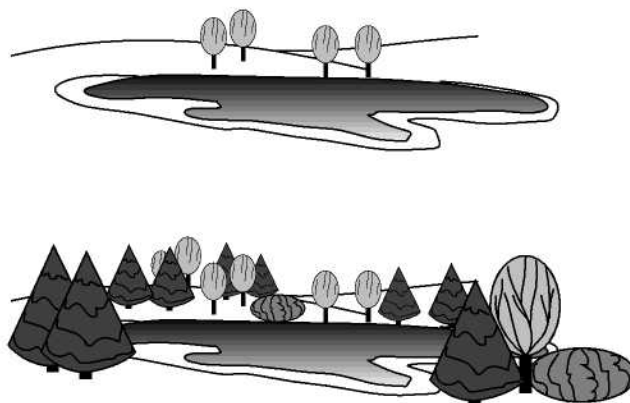
## Spillway requirements

A pipe spillway often is used as well as an earth auxiliary spillway to control runoff from the watershed. The principal spillway is designed to reduce the frequency of operation of the auxiliary spillway. Commonly the principal spillway may be a hooded or canopy inlet with a straight pipe or may be a drop inlet (vertical section) that has a pipe barrel through the dam. The pipe shall be capable of withstanding external loading with yielding, buckling, or cracking. The pipe joints and all appurtenances need to be watertight. Pipe materials may be smooth metal, corrugated metal, or plastic. Design limitations exist with all materials.

A small principal spillway pipe, formerly called a trickle tube, only handles a small amount of flow. Its purpose is to aid in keeping the auxiliary spillway dry during the passage of small storm events.

Hooded or canopy inlets are common. A disadvantage of this type inlet is the larger amount of stage (head over the inlet crest) needed to make the pipe flow at full capacity. Conversely, a drop inlet spillway requires less stage because the size of the inlet may be enlarged to make the barrel flow full.

**Figure 19** The apparent size of the pond is influenced by surrounding vegetation



The principal spillway normally is sized to control the runoff from a storm ranging from a 1-year to a 10-year frequency event. This depends on the size of the drainage area. For pond sites where the drainage area is small (less than 20 acres) and the condition of the vegetated spillway is good, no principal spillway is required except where the pond is spring fed or there are other sources of steady baseflow. In this case, a trickle tube shall be installed.

Earth spillways have limitations. Use them only where the soils and topography allow the peak flow to discharge safely at a point well downstream and at a velocity that does not cause appreciable erosion either within the spillway or beyond its outlet.

Soil borings generally are required for auxiliary spillways if a natural site with good plant cover is available. If spillway excavation is required, the investigations should be thorough enough to determine whether the soils can withstand reasonable velocities without serious erosion. Avoid loose sands and other highly erodible soils.

No matter how well a dam has been built, it will probably be destroyed during the first severe storm if the capacity of the spillway is inadequate. The function of an auxiliary spillway is to pass excess storm runoff around the dam so that water in the pond does not rise high enough to damage the dam by overtopping. The spillways must also convey the water safely to the

outlet channel below without damaging the downstream slope of the dam. The proper functioning of a pond depends on a correctly designed and installed spillway system.

Auxiliary spillways should have the minimum capacity to discharge the peak flow expected from a storm of the frequency and duration shown in table 7 less any reduction creditable to conduit discharge and detention storage. After the spillway capacity requirements are calculated, the permissible velocity must be determined. Table 8 shows the recommended allowable velocity for various cover, degree of erosion resistance, and slope of the channel. Table 9 gives the retardance factors for the expected height of the vegetation.

Both natural and excavated auxiliary spillways are used. A natural spillway does not require excavation to provide enough capacity to conduct the pond outflow to a safe point of release (fig. 20). The requirements discussed later for excavated spillways do not apply to natural spillways, but the capacity must be adequate.

With the required discharge capacity ( $Q$ ), the end slope of the embankment ( $Z_1$ ), and the slope of the natural ground ( $Z_2$ ) known, the maximum depth of water above the level portion ( $H_p$ ) can be obtained from table 10. The depth is added to the elevation of the spillway crest to determine the maximum elevation to which water will rise in the reservoir.

**Table 7** Minimum spillway design storm

Drainage area (acre)	Effective height of dam <sup>1/</sup> (ft)	Storage (acre-ft)	Minimum design storm	
			Frequency (yr)	Minimum duration (hr)
20 or less	20 or less	Less than 50	10	24
20 or less	More than 20	Less than 50	25	24
More than 20	20 or less	Less than 50	25	24
All others			50	24

<sup>1/</sup> The effective height of the dam is the difference in elevation between the auxiliary spillway crest and the lowest point in the cross section taken along the centerline of the dam.



**Table 8** Permissible velocity for vegetated spillways <sup>1/</sup>

Vegetation	----- Permissible velocity <sup>2/</sup> -----			
	Erosion-resistant soils <sup>3/</sup>		Easily eroded soils <sup>4/</sup>	
	----- Slope of exit channel (%) -----			
	0-5 (ft/s)	5-10 (ft/s)	0-5 (ft/s)	5-10 (ft/s)
Bermudagrass	8	7	6	5
Bahiagrass	8	7	6	5
Buffalograss	7	6	5	4
Kentucky bluegrass	7	6	5	4
Smooth brome	7	6	5	4
Tall fescue	7	6	5	4
Reed canarygrass	7	6	5	4
Sod-forming grass-legume mixtures	5	4	4	3
Lespedeza sericea	3.5	3.5	2.5	2.5
Weeping lovegrass	3.5	3.5	2.5	2.5
Yellow bluestem	3.5	3.5	2.5	2.5
Native grass mixtures	3.5	3.5	2.5	2.5

1/ SCS TP-61

2/ Increase values 10 percent when the anticipated average use of the spillway is not more frequent than once in 5 years, or 25 percent when the anticipated average use is not more frequent than once in 10 years.

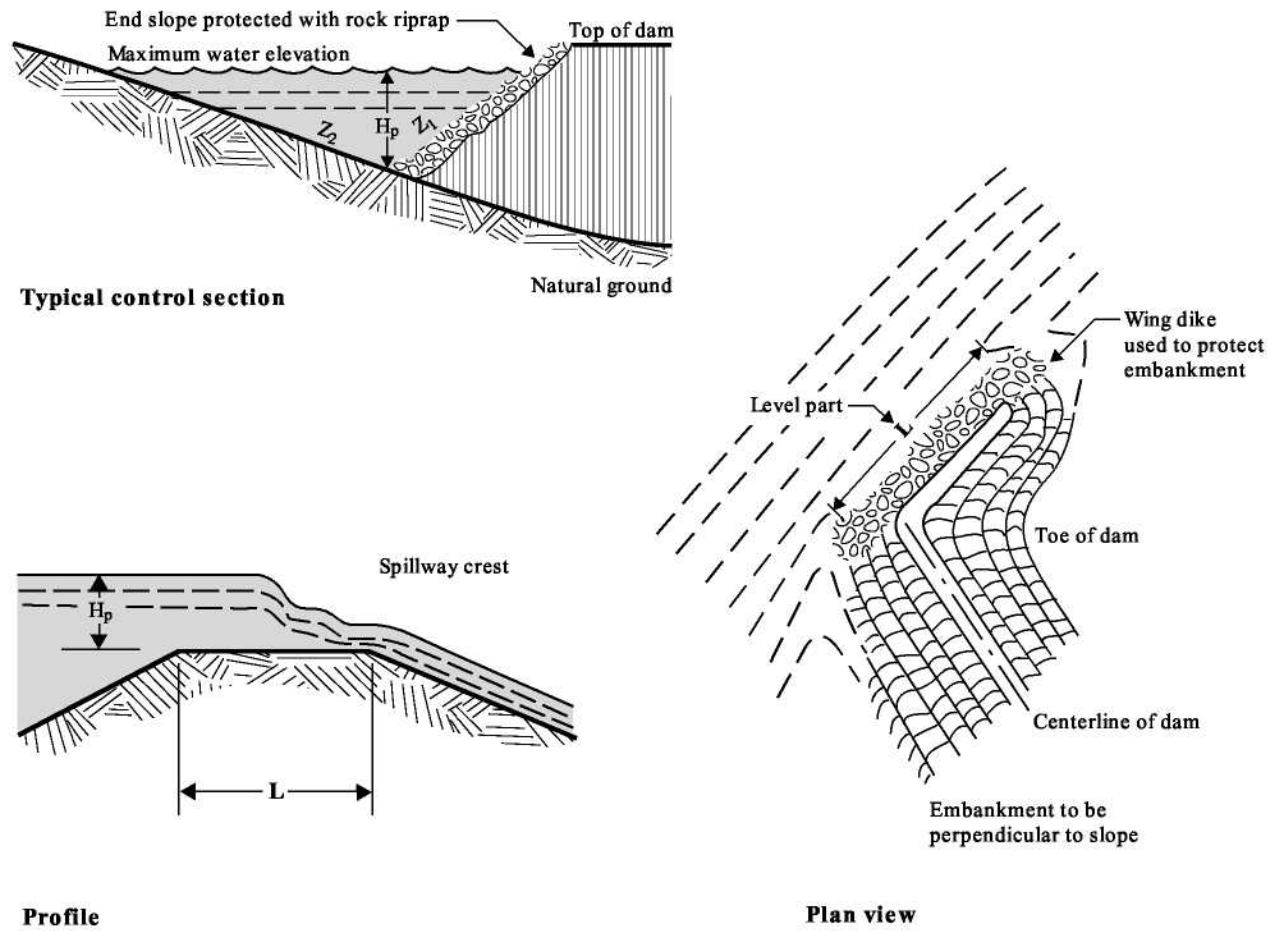
3/ Those with a higher clay content and higher plasticity. Typical soil textures are silty clay, sandy clay, and clay.

4/ Those with a high content of fine sand or silt and lower plasticity, or nonplastic. Typical soil textures are fine sand, silt, sandy loam, and silty loam.

**Table 9** Guide to selection of vegetal retardance

Stand	Average height of vegetation (in)	Degree of retardance
Good	Higher than 30	A
	11 to 24	B
	6 to 10	C
	2 to 6	D
	Less than 2	E
Fair	Higher than 30	B
	11 to 24	C
	6 to 10	D
	2 to 6	D
	Less than 2	E

**Figure 20** Plan, profile, and cross section of a natural spillway with vegetation



**Table 10**  $H_p$  discharge and velocities for natural vegetated spillways with 3:1 end slope ( $Z_1$ )

Natural ground slope $Z_2$ (%)	$H_p$ (ft)	Retardance												Slope	
		A		B		C		D		E		Min. (%)	Max. (%)		
		$Q$ (ft <sup>3</sup> /s)	$V$ (ft/s)	$Q$ (ft <sup>3</sup> /s)	$V$ (ft/s)	$Q$ (ft <sup>3</sup> /s)	$V$ (ft/s)	$Q$ (ft <sup>3</sup> /s)	$V$ (ft/s)	$Q$ (ft <sup>3</sup> /s)	$V$ (ft/s)				
0.5	1.0	19	0.3	28	0.5	47	1.3	68	1.8	130	2.8	0.5	3		
	1.1	21	.3	35	.5	76	1.5	108	2.1	154	3.0				
	1.2	29	.4	39	.6	97	1.6	122	2.3	204	3.2				
	1.3	36	.4	53	.6	125	2.0	189	2.5	250	3.4				
	1.5	61	.4	87	1.1	210	2.2	291	2.9	393	3.8				
	1.8	81	.5	187	1.8	384	2.9	454	3.5	651	4.5				
	2.0	110	.5	286	2.1	524	3.3	749	3.8	860	4.8				
1	1.0	10	0.4	16	0.5	31	2.0	45	2.6	64	3.4	1	3		
	1.1	13	.4	18	.6	50	2.3	63	2.8	90	3.7				
	1.2	15	.5	21	.8	62	2.5	78	3.1	99	4.0				
	1.3	22	.6	39	1.0	86	2.7	144	3.4	139	4.3				
	1.5	40	.7	75	1.8	133	3.1	186	4.0	218	5.1				
	1.8	56	.8	126	2.3	280	3.8	296	4.5						
	2.0	98	1.1	184	2.8	328	4.3	389	5.0						
	2.5	171	2.5	472	4.1	680	5.4								
2	1.0	6	0.5	9	0.8	18	2.5	27	3.3	36	4.2	1	3		
	1.1	7	.7	14	1.0	29	2.8	39	3.6	50	4.5				
	1.2	9	.8	19	1.1	40	3.1	51	3.9	64	4.9				
	1.3	13	.9	26	1.6	50	3.4	70	4.3	85	5.3				
	1.5	21	1.0	39	2.0	70	3.9	109	5.1	127	6.3				
	1.8	26	1.1	74	2.5	126	4.8	194	5.9						
	2.0	52	1.3	111	3.2	190	5.4	229	6.4						
	2.5	88	2.8	238	5.2	339	6.8								
3	1.0	4	0.7	7	0.8	15	2.8	21	3.7	28	4.8	1	3		
	1.1	5	.8	10	.9	24	3.2	31	4.0	38	5.2				
	1.2	7	.9	14	1.1	33	3.6	41	4.4	49	5.6				
	1.3	10	1.0	20	1.5	42	3.8	57	4.8	67	6.1				
	1.5	16	1.2	34	2.8	62	4.4	89	5.7	104	7.2				
	1.8	23	1.3	57	3.0	112	5.5	143	6.7						
	2.0	39	1.5	81	3.7	163	6.2	194	7.2						
	2.5	85	3.1	212	6.0	300	7.8								
4	1.2	6	1.0	11	1.4	25	3.9	31	4.8	38	6.1	1	4		
	1.5	15	1.3	29	3.1	49	4.8	69	5.5	81	7.9				
	1.8	20	1.4	47	4.1	98	6.1	116	7.3						
	2.0	30	1.6	65	4.7	139	6.7	161	7.8						
	2.5	72	3.3	167	6.6	238	8.5								
5	1.5	13	1.4	23	3.3	38	5.2	55	6.7	63	8.4	1	5		
	1.8	17	1.5	37	4.4	76	6.5	95	7.9						
	2.0	23	1.7	48	5.1	112	7.1	130	8.1						
	2.5	64	3.7	149	7.1	191	9.2								



The following example shows how to use table 10:

Given:

Vegetation: good stand of bermudagrass  
 Height: 6 to 10 inches  
 Slope of natural ground: 1.0 percent

Solution:

From table 9, determine a retardance of C.

From table 10, under natural ground slope  
 1 percent and retardance C column,

find  $Q = 88$

ft<sup>3</sup>/s at  $H_p = 1.3$  ft, and

$V = 2.7$  ft/s.

If the freeboard is 1.0 foot, the top of the dam should be constructed 2.3 feet higher than the spillway crest. The velocity is well below the maximum permissible velocity of 6 feet per second given in table 8.  $H_p$  can be determined by interpolation when necessary. For a  $Q$  greater than that listed in table 10, the spillway should be excavated according to the information in the next section, Excavated auxiliary spillways.

**Excavated auxiliary spillways**—Excavated spillways consist of the three elements shown in figure 21. The flow enters the spillway through the inlet channel. The maximum depth of flow ( $H_p$ ) located upstream from the level part is controlled by the inlet channel, level part, and exit channel.

Excavation of the inlet channel or the exit channel, or both, can be omitted where the natural slopes meet the minimum slope requirements. The direction of slope of the exit channel must be such that discharge does not flow against any part of the dam. Wing dikes, sometimes called kicker levees or training levees, can be used to direct the outflow to a safe point of release downstream.

The spillway should be excavated into the earth for its full depth. If this is not practical, the end of the dam and any earthfill constructed to confine the flow should be protected by vegetation or riprap. The entrance to the inlet channel should be widened so it is at least 50 percent greater than the bottom width of the level part. The inlet channel should be reasonably short and should be planned with smooth, easy curves for alignment. It should have a slope toward the reser-

voir of not less than 2.0 percent to ensure drainage and low water loss at the inlet.

With the required discharge capacity, the degree of retardance, permissible velocity, and the natural slope of the exit channel known, the bottom width of the level and exit sections and the depth of the flow ( $H_p$ ) can be computed using the figures in table 11. This table shows discharge per foot of width. The natural slope of the exit channel should be altered as little as possible.

The selection of the degree of retardance for a given auxiliary spillway depends mainly on the height and density of the cover chosen (table 9). Generally, the retardance for uncut grass or vegetation is the one to use for capacity determination. Because protection and retardance are lower during establishment and after mowing, to use a lower degree of retardance when designing for stability may be advisable.

The following examples show the use of the information in table 11:

Example 1 where only one retardance is used for capacity and stability:

Given:

$Q = 87$  ft<sup>3</sup>/s (total design capacity)

$S_o = 4$  percent (slope of exit channel determined from profile, or to be excavated)

$L = 50$  ft

Earth spillway is to be excavated in an erosion-resistant soil and planted with a sod-forming grass-legume mixture. After establishment, a good stand averaging from 6 to 10 inches in height is expected.

Required:

Permissible velocity ( $V$ )

Width of spillway ( $b$ )

Depth of water in the reservoir above the crest ( $H_p$ ).

Solution:

From table 8 for sod-forming grass-legume mixtures, read permissible velocity  $V = 5$  ft/s.

From table 9 for average height of vegetation of 6 to 10 inches, determine retardance C.

For retardance C, enter table 11 from left at maximum velocity  $V = 5$  ft/s. A 4 percent slope is in the slope range of 1–6 with  $Q$  of 3 ft<sup>3</sup>/s/ft.

$H_p$  for  $L$  of 50 ft = 1.4 ft.

If the freeboard is 1 foot, the spillway should be constructed 29 feet wide and 2.4 feet deep.

For retardance C, enter table 11 from left at maximum velocity  $V = 5$  ft/s. A 4 percent slope is in the slope range of 1–6 with  $Q$  of 3 ft<sup>3</sup>/s/ft.

$H_p$  for  $L$  of 50 ft = 1.4 ft.

If the freeboard is 1 foot, the spillway should be constructed 29 feet wide and 2.4 feet deep.

Example 2 where one retardance is used for stability and another is used for capacity:

Given:

$S_o$  = 4 percent (slope of exit channel determined from profile or to be excavated)

$L$  = 50 ft

Earth spillway is to be excavated in a highly erodible soil and planted with bahiagrass. After establishment a good stand of 11 to 24 inches is expected.

Required:

Permissible velocity ( $V$ )

Width of spillway ( $b$ )

Depth of water in reservoir above the crest ( $H_p$ ).

Solution:

From table 8 determine permissible velocity for bahiagrass in a highly erodible soil that has 8 percent slope  $V = 5$  ft/s.

From table 9, select retardants to be used for stability during an establishment period that has a good stand of vegetation of 2 to 6 inches (retardance D).

Select retardance to be used for capacity for good stand of vegetation that has a length of 11 to 24 inches (retardance B).

From table 11, enter from left at maximum velocity  $V = 5$  ft/s. A slope of 6 percent is in the range for  $Q = 2$  ft<sup>3</sup>/s/ft.

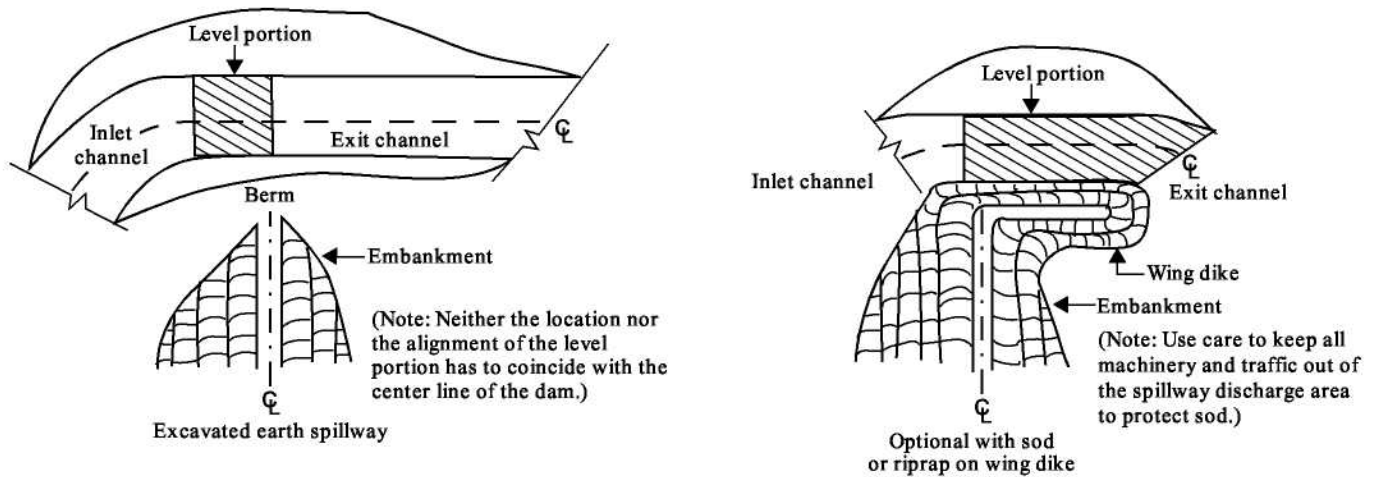
Then

From table 11, enter  $q = 2$  ft<sup>3</sup>/s/ft under retardance B and find  $H_p$  for  $L$  of 25 ft = 1.4 ft.

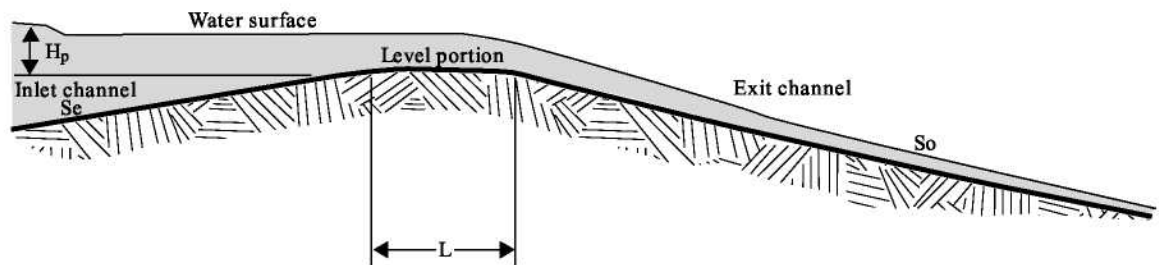
If the freeboard is 1 foot, the spillway should be constructed 50 feet wide and 2.4 feet deep.

**Protection against erosion**—Protect auxiliary spillways against erosion by establishing good plant cover if the soil and climate permit. As soon after construction as practicable, prepare the auxiliary spillway area for seeding or sodding by applying fertilizer or manure. Sow adapted perennial grasses and protect the seedlings to establish a good stand. Mulching is necessary on the slopes. Irrigation is often needed to ensure good germination and growth, particularly if seeding must be done during dry periods. If the added cost is justified, sprigging or sodding suitable grasses, such as bermudagrass, gives quick protection.

**Figure 21** Excavated earth spillway



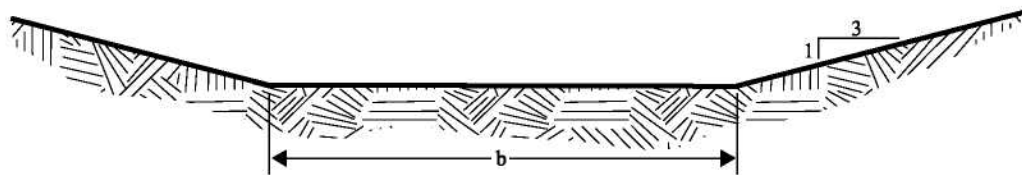
**Plan view of earth spillways**



**Profile along centerline**

**Definition of terms:**

- $H_p$  = depth of water in reservoir above crest
- $L$  = length of level portion min. 25 ft
- $b$  = bottom width of spillway
- $S_o$  = slope for exit channel
- $S_e$  = slope of inlet channel



**Cross section of level portion**



**Table 11** Depth of flow ( $H_p$ ) and slope range at retardance values for various discharges, velocities, and crest lengths

	Maximum velocity  (ft/s)	Discharge  (ft <sup>3</sup> /s/ft)	----- $H_p$ ----- ----- $L$ -----				-----Slope-----	
			25	50	100	200	Min.	Max.
			(ft)	(ft)	(ft)	(ft)	(%)	(%)
Retardance A	3	3	2.3	2.5	2.7	3.1	1	11
	4	4	2.3	2.5	2.8	3.1	1	12
	4	5	2.5	2.6	2.9	3.2	1	7
	5	6	2.6	2.7	3.0	3.3	1	9
	6	7	2.7	2.8	3.1	3.5	1	12
	7	10	3.0	3.2	3.4	3.8	1	9
	8	12.5	3.3	3.5	3.7	4.1	1	10
Retardance B	2	1	1.2	1.4	1.5	1.8	1	12
	2	1.25	1.3	1.4	1.6	1.9	1	7
	3	1.5	1.3	1.5	1.7	1.9	1	12
	3	2	1.4	1.5	1.7	1.9	1	8
	4	3	1.6	1.7	1.9	2.2	1	9
	5	4	1.8	1.9	2.1	2.4	1	8
	6	5	1.9	2.1	2.3	2.5	1	10
	7	6	2.1	2.2	2.4	2.7	1	11
8	7	2.2	2.4	2.6	2.9	1	12	
Retardance C	2	0.5	0.7	0.8	0.9	1.1	1	6
	2	1	0.9	1.0	1.2	1.3	1	3
	3	1.25	0.9	1.0	1.2	1.3	1	6
	4	1.5	1.0	1.1	1.2	1.4	1	12
	4	2	1.1	1.2	1.4	1.6	1	7
	5	3	1.3	1.4	1.6	1.8	1	6
	6	4	1.5	1.6	1.8	2.0	1	12
	8	5	1.7	1.8	2.0	2.2	1	12
	9	6	1.8	2.0	2.1	2.4	1	12
	9	7	2.0	2.1	2.3	2.5	1	10
10	7.5	2.1	2.2	2.4	2.6	1	12	
Retardance D	2	0.5	0.6	0.7	0.8	0.9	1	6
	3	1	0.8	0.9	1.0	1.1	1	6
	3	1.25	0.8	0.9	1.0	1.2	1	4
	4	1.25	0.8	0.9	1.0	1.2	1	10
	4	2	1.0	1.1	1.3	1.4	1	4
	5	1.5	0.9	1.0	1.2	1.3	1	12
	5	2	1.0	1.2	1.3	1.4	1	9
	5	3	1.2	1.3	1.5	1.7	1	4
	6	2.5	1.1	1.2	1.4	1.5	1	11
	6	3	1.2	1.3	1.5	1.7	1	7
	7	3	1.2	1.3	1.5	1.7	1	12
	7	4	1.4	1.5	1.7	1.9	1	7
	8	4	1.4	1.5	1.7	1.9	1	12
	8	5	1.6	1.7	1.9	2.0	1	8
10	6	1.8	1.9	2.0	2.2	1	12	

**Table 11** Depth of flow ( $H_p$ ) and slope range at retardance values for various discharges, velocities, and crest lengths—Continued.

	Maximum velocity  (ft/s)	Discharge  (ft <sup>3</sup> /s/ft)	----- $H_p$ ----- ----- $L$ -----				-----Slope-----	
			25	50	100	200	Min.	Max.
			(ft)	(ft)	(ft)	(ft)	(%)	(%)
Retardance E	2	0.5	0.5	0.5	0.6	0.7	1	2
	3	0.5	0.5	0.5	0.6	0.7	1	9
	3	1	0.7	0.7	0.8	0.9	1	3
	4	1	0.7	0.7	0.8	0.9	1	6
	4	1.25	0.7	0.8	0.9	1.0	1	5
	5	1	0.7	0.7	0.8	0.9	1	12
	5	2	0.9	1.0	1.1	1.2	1	4
	6	1.5	0.8	0.9	1.0	1.1	1	12
	6	2	0.9	1.0	1.1	1.2	1	7
	6	3	1.2	1.2	1.3	1.5	1	4
	7	2	0.9	1.0	1.1	1.2	1	12
	7	3	1.2	1.2	1.3	1.5	1	7
	8	3	1.2	1.2	1.3	1.5	1	10
	8	4	1.4	1.4	1.5	1.7	1	6
	10	4	1.4	1.4	1.5	1.7	1	12

## Pipes through the dam

**Pipe spillways**—Protect the vegetation in earth spillway channels against saturation from spring flow or low flows that may continue for several days after a storm. A pipe placed under or through the dam provides this protection. The crest elevation of the entrance should be 12 inches or more below the top of the control section of the auxiliary spillway.

The pipe should be large enough to discharge flow from springs, snowmelt, or seepage. It should also have enough capacity to discharge prolonged surface flow following an intense storm. This rate of flow generally is estimated. If both spring flow and prolonged surface flow can be expected, the pipe should be large enough to discharge both.

Drop inlet and hood inlet pipe spillways are commonly used for ponds.

**Drop-inlet pipe spillway**—A drop-inlet consists of a pipe barrel (fig. 22) located under the dam and a riser connected to the upstream end of the barrel. This riser can also be used to drain the pond if a suitable valve or gate is attached at its upstream end (fig. 23).

With the required discharge capacity determined, use table 12 or 13 to select an adequate pipe size for the barrel and riser. Table 12 is for barrels of **smooth pipe**, and table 13 is for barrels of **corrugated metal pipe**. The diameter of the riser must be somewhat larger than the diameter of the barrel if the tube is to flow full. Recommended combinations of barrel and riser diameters are shown in the tables. In these tables the total head is the vertical distance between a point 1 foot above the riser crest and the centerline of the barrel at its outlet end. Because pipes of small diameter are easily clogged by trash and rodents, no pipe smaller than 6 inches in diameter should be used for the barrel.

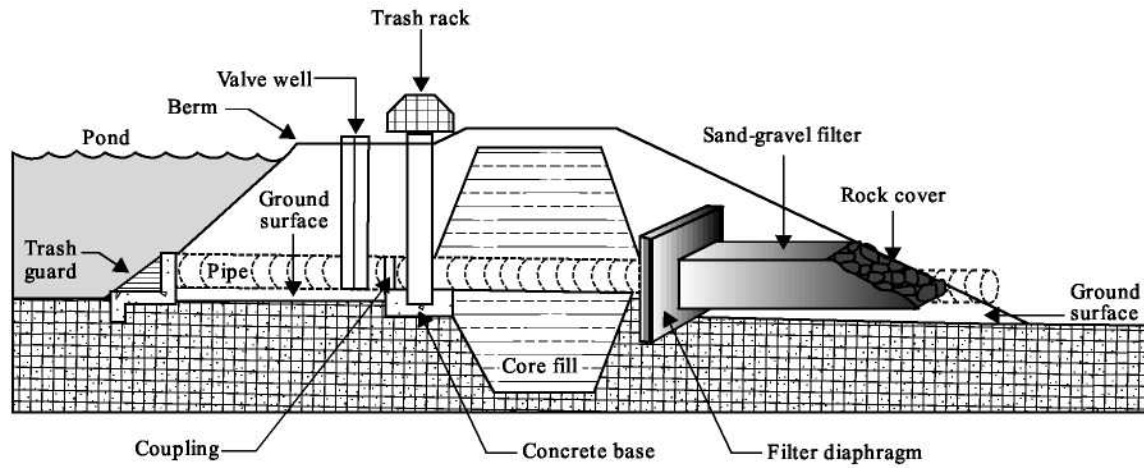
**Figure 22** Drop-inlet pipe spillway with antiseep collar



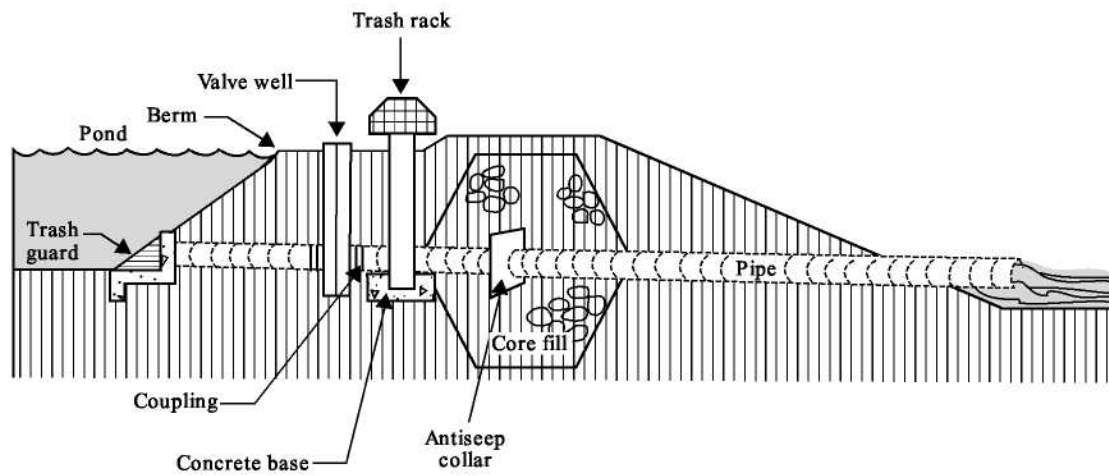


**Figure 23** Drop-inlet pipe spillways

(a) With sand-gravel filter



(b) With antiseep collar



**Table 12** Discharge values for **smooth pipe** drop inlets <sup>1/</sup>

Total head (ft)	Ratio of barrel diameter to riser diameter (in)					
	6:8 (ft <sup>3</sup> /s)	8:10 (ft <sup>3</sup> /s)	10:12 (ft <sup>3</sup> /s)	12:15 (ft <sup>3</sup> /s)	15:24 (ft <sup>3</sup> /s)	18:36 (ft <sup>3</sup> /s)
6	1.54	3.1	5.3	8.1	13.6	20.6
8	1.66	3.3	5.7	8.9	14.8	22.5
10	1.76	3.5	6.1	9.6	15.8	24.3
12	1.86	3.7	6.5	10.2	16.8	26.1
14	1.94	3.9	6.8	10.7	17.8	27.8
16	2.00	4.0	7.0	11.1	18.6	29.2
18	2.06	4.1	7.2	11.5	19.3	30.4
20	2.10	4.2	7.4	11.8	19.9	31.3
22	2.14	4.3	7.6	12.1	20.5	32.2
24	2.18	4.4	7.8	12.4	21.0	33.0
26	2.21	4.5	8.0	12.6	21.5	33.8

<sup>1/</sup> Length of pipe barrel used in calculations is based on a dam with a 12-foot top width and 2.5:1 side slopes. Discharge values are based on a minimum head on the riser crest of 12 inches. Pipe flow based on Manning's  $n = 0.012$ .

**Table 13** Discharge values for **corrugated metal pipe** drop inlets <sup>1/</sup>

Total head (ft)	Ratio of barrel diameter to riser diameter (in)					
	6:8 (ft <sup>3</sup> /s)	8:10 (ft <sup>3</sup> /s)	10:12 (ft <sup>3</sup> /s)	12:15 (ft <sup>3</sup> /s)	15:21 (ft <sup>3</sup> /s)	18:24 (ft <sup>3</sup> /s)
6	0.85	1.73	3.1	5.1	8.8	14.1
8	0.90	1.85	3.3	5.4	9.4	15.0
10	0.94	1.96	3.5	5.7	9.9	15.9
12	0.98	2.07	3.7	6.0	10.4	16.7
14	1.02	2.15	3.8	6.2	10.8	17.5
16	1.05	2.21	3.9	6.4	11.1	18.1
18	1.07	2.26	4.0	6.6	11.4	18.6
20	1.09	2.30	4.1	6.7	11.7	18.9
22	1.11	2.34	4.2	6.8	11.9	19.3
24	1.12	2.37	4.2	6.9	12.1	19.6
26	1.13	2.40	4.3	7.0	12.3	19.9

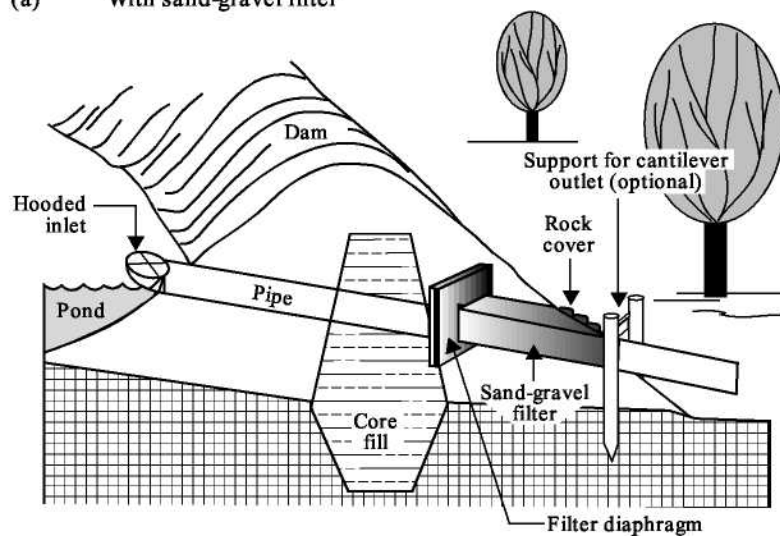
<sup>1/</sup> Length of pipe barrel used in calculations is based on a dam with a 12-foot top width and 2.5:1 side slopes. Discharge values are based on a minimum head on the riser crest of 12 inches. Pipe flow based on Manning's  $n = 0.012$ .

**Hood-inlet pipe spillway**—A hood-inlet consists of a pipe laid in the earthfill (fig. 24). The inlet end of the pipe is cut at an angle to form a hood. An antivortex device, usually metal, is attached to the entrance of the pipe to increase the hydraulic efficiency of the

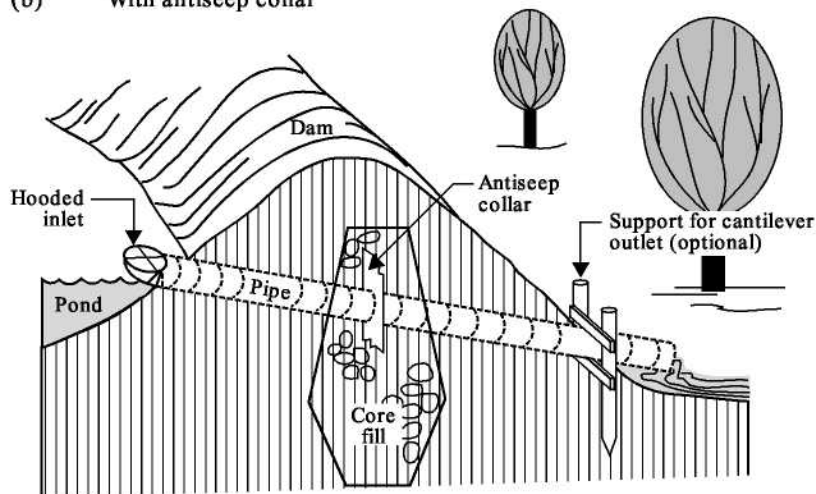
tube. Typical installations of hood inlets and details of the antivortex device are shown in figure 25. Often a hood-inlet can be built at less cost than a drop-inlet because no riser is needed. The major disadvantage of this kind of pipe spillway is that it cannot be used as a drain.

**Figure 24** Dam with hooded inlet pipe spillway

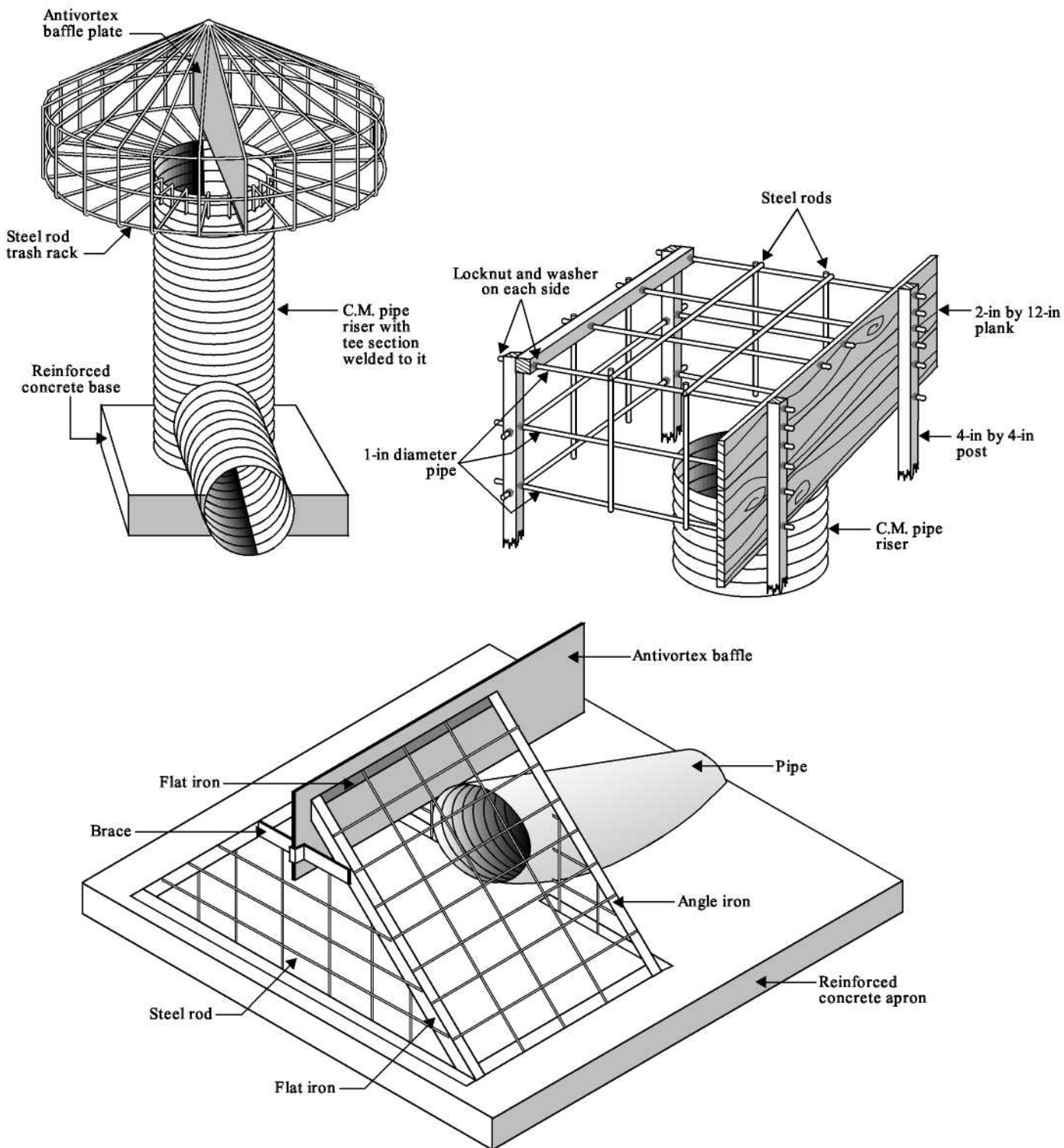
(a) With sand-gravel filter



(b) With antiseep collar



**Figure 25** Pipe inlet spillways that have trash rack and antivortex baffle





The required diameter for a hood-inlet pipe can be selected from table 14 or 15 after estimating the discharge capacity,  $Q$ , and determining the total head,  $H$ . The tables also show the minimum head,  $h$ , required above the invert or crest elevation of the pipe entrance. Unless you provide this minimum head, the pipe will not flow full.

Pipe made of cast iron, smooth steel, concrete, plastic, or corrugated metal is suitable for either kind of pipe spillway. All joints must be watertight. A concrete cradle or bedding is needed for concrete pipe to ensure a firm foundation and good alignment of the conduit. Seal the joints of concrete pipe with an approved type of rubber gasket to give them the desired amount of flexibility. For all pipe spillways, use new pipe or pipe so slightly used that it may be considered equivalent to new pipe.

To retard seepage through the embankment along the outside surface of the pipe, compact the fill around the pipe and use a filter and drainage diaphragm around the pipe like that shown in figure 24.

One filter and drainage diaphragm should be used around any structure that extends through the embankment to the downstream slope. The diaphragm should be located downstream of the centerline of a homogeneous embankment or downstream of the cutoff trench. The diaphragm should be a minimum of 3 feet thick and extend around the pipe surface a minimum of 2 times the outside diameter of the pipe ( $2D_o$ ). When a cradle or bedding is used under the pipe, the vertical downward  $2D_o$  is measured from the bottom of the cradle or bedding. If bedrock is encountered within the  $2D_o$  measurement, the diaphragm should terminate at the bedrock surface. The location

**Table 14** Minimum head,  $h$  (ft), required above the invert of hood inlets to provide full flow,  $Q$  (ft<sup>3</sup>/s), for various sizes of smooth pipe and values of total head,  $H$ <sup>1/</sup>

Total head (ft)	Diameter of pipe in inches					
	6	8	10	12	15	18
6	$h = 0.63$ $Q = 1.63$	$h = 0.85$ $Q = 3.0$	$h = 1.04$ $Q = 5.3$	$h = 1.23$ $Q = 8.5$	$h = 1.54$ $Q = 14.0$	$h = 1.82$ $Q = 21.2$
8	$h = 0.65$ $Q = 1.78$	$h = 0.86$ $Q = 3.5$	$h = 1.06$ $Q = 6.0$	$h = 1.27$ $Q = 9.3$	$h = 1.57$ $Q = 15.5$	$h = 1.87$ $Q = 23.3$
10	$h = 0.66$ $Q = 1.93$	$h = 0.87$ $Q = 3.8$	$h = 1.08$ $Q = 6.6$	$h = 1.30$ $Q = 10.2$	$h = 1.60$ $Q = 17.0$	$h = 1.91$ $Q = 25.4$
12	$h = 0.67$ $Q = 2.06$	$h = 0.88$ $Q = 4.1$	$h = 1.09$ $Q = 7.1$	$h = 1.32$ $Q = 10.9$	$h = 1.63$ $Q = 18.3$	$h = 1.94$ $Q = 27.5$
14	$h = 0.67$ $Q = 2.18$	$h = 0.89$ $Q = 4.3$	$h = 1.11$ $Q = 7.5$	$h = 1.33$ $Q = 11.6$	$h = 1.65$ $Q = 19.5$	$h = 1.96$ $Q = 29.4$
16	$h = 0.68$ $Q = 2.28$	$h = 0.90$ $Q = 4.5$	$h = 1.13$ $Q = 7.8$	$h = 1.35$ $Q = 12.2$	$h = 1.67$ $Q = 20.5$	$h = 1.98$ $Q = 31.0$
18	$h = 0.69$ $Q = 2.36$	$h = 0.91$ $Q = 4.7$	$h = 1.14$ $Q = 8.1$	$h = 1.36$ $Q = 12.7$	$h = 1.69$ $Q = 21.4$	$h = 2.00$ $Q = 32.5$
20	$h = 0.69$ $Q = 2.43$	$h = 0.92$ $Q = 4.9$	$h = 1.15$ $Q = 8.4$	$h = 1.37$ $Q = 13.2$	$h = 1.70$ $Q = 22.2$	$h = 2.02$ $Q = 33.9$
22	$h = 0.70$ $Q = 2.50$	$h = 0.93$ $Q = 5.0$	$h = 1.16$ $Q = 8.7$	$h = 1.38$ $Q = 13.6$	$h = 1.71$ $Q = 23.0$	$h = 2.04$ $Q = 35.1$
24	$h = 0.70$ $Q = 2.56$	$h = 0.93$ $Q = 5.1$	$h = 1.16$ $Q = 9.0$	$h = 1.39$ $Q = 14.0$	$h = 1.72$ $Q = 23.7$	$h = 2.05$ $Q = 36.3$
26	$h = 0.71$ $Q = 2.60$	$h = 0.94$ $Q = 5.2$	$h = 1.17$ $Q = 9.3$	$h = 1.40$ $Q = 14.4$	$h = 1.73$ $Q = 24.4$	$h = 2.07$ $Q = 37.5$

<sup>1/</sup> Length of pipe used in calculations is based on a dam with a 12-foot top width and 2.5:1 side slopes. Pipe flow based on Manning's  $n = 0.012$ .

of the diaphragm should never result in a minimum soil cover over a portion of the diaphragm measured normal to the nearest embankment surface of less than 2 feet. If this requirement is exceeded, the filter and drainage diaphragm should be moved upstream until the 2-foot minimum is reached. The outlet for the filter and drainage diaphragm should extend around the pipe surface a minimum of 1.5 times the outside diameter of the pipe (1.5*D*<sub>o</sub>) that has 1 foot around the pipe being a minimum.

In most cases where the embankment core consists of fine-grained materials, such as sandy or gravelly silts and sandy or gravelly clay (15 to 85 percent passing the No. 200 sieve), an aggregate conforming to ASTM C-33 fine concrete aggregate is suitable for the filter and drainage diaphragm material. A fat clay or elastic silt

(more than 85 percent passing No. 200 sieve) core requires special design considerations, and an engineer experienced in filter design should be consulted.

Using a filter and drainage diaphragm has many advantages. Some are as follows:

- They provide positive seepage control along structures that extend through the fill.
- Unlike concrete antiseep collars, they do not require curing time.
- Installation is easy with little opportunity for constructed failure. The construction can consist mostly of excavation and backfilling with the filter material at appropriate locations.

Antiseep collars can be used instead of the filter and drainage diaphragm. Antiseep collars have been used

**Table 15** Minimum head, *h* (ft), required above the invert of hood inlets to provide full flow, *Q* (ft<sup>3</sup>/s), for various sizes of corrugated pipe and values of total head, *H*<sup>1/</sup>

Total head (ft)	Diameter of pipe in inches					
	6	8	10	12	15	18
6	h = 0.59 Q = 0.92	h = 0.78 Q = 1.9	h = 0.97 Q = 3.3	h = 1.17 Q = 5.3	h = 1.46 Q = 9.1	h = 1.75 Q = 14.5
8	h = 0.59 Q = 1.00	h = 0.79 Q = 2.1	h = 0.98 Q = 3.6	h = 1.18 Q = 5.8	h = 1.48 Q = 10.0	h = 1.77 Q = 16.0
10	h = 0.60 Q = 1.06	h = 0.79 Q = 2.2	h = 0.99 Q = 3.9	h = 1.19 Q = 6.3	h = 1.49 Q = 10.9	h = 1.79 Q = 17.3
12	h = 0.60 Q = 1.12	h = 0.80 Q = 2.3	h = 1.00 Q = 4.2	h = 1.20 Q = 6.7	h = 1.50 Q = 11.6	h = 1.80 Q = 18.5
14	h = 0.61 Q = 1.18	h = 0.81 Q = 2.4	h = 1.01 Q = 4.4	h = 1.21 Q = 7.1	h = 1.51 Q = 12.2	h = 1.82 Q = 19.6
16	h = 0.61 Q = 1.22	h = 0.81 Q = 2.5	h = 1.01 Q = 4.6	h = 1.21 Q = 7.4	h = 1.52 Q = 12.7	h = 1.82 Q = 20.5
18	h = 0.61 Q = 1.26	h = 0.81 Q = 2.6	h = 1.02 Q = 4.8	h = 1.22 Q = 7.6	h = 1.53 Q = 13.2	h = 1.83 Q = 21.3
20	h = 0.62 Q = 1.30	h = 0.82 Q = 2.7	h = 1.03 Q = 4.9	h = 1.23 Q = 7.8	h = 1.54 Q = 13.7	h = 1.85 Q = 21.9
22	h = 0.62 Q = 1.33	h = 0.83 Q = 2.8	h = 1.03 Q = 5.0	h = 1.24 Q = 8.0	h = 1.55 Q = 14.1	h = 1.86 Q = 22.5
24	h = 0.63 Q = 1.35	h = 0.83 Q = 2.8	h = 1.04 Q = 5.1	h = 1.25 Q = 8.2	h = 1.56 Q = 14.5	h = 1.88 Q = 23.0
26	h = 0.63 Q = 1.37	h = 0.84 Q = 2.9	h = 1.05 Q = 5.2	h = 1.26 Q = 8.3	h = 1.58 Q = 14.7	h = 1.89 Q = 23.4

<sup>1/</sup> Length of pipe used in calculations is based on a dam with a 12-foot top width and 2.5:1 side slopes. Pipe flow based on Manning's *n* = 0.025.

with pipe spillways for many years. More fabricated materials are required for this type of installation. Both types of seepage control are acceptable; in either case, proper installation is imperative.

If an antiseep collar is used, it should extend into the fill a minimum of 24 inches perpendicular to the pipe. If the dam is less than 15 feet high, one antiseep collar at the centerline of the fill is enough. For higher dams, use two or more collars equally spaced between the fill centerline and the upstream end of the conduit when a hood-inlet pipe is used. If a drop-inlet pipe is used, the antiseep collars should be equally spaced between the riser and centerline of the fill.

Use trash racks to keep pipes from clogging with trash and debris. Of the many kinds of racks that have been used, the three shown in figure 25 have proved the most successful.

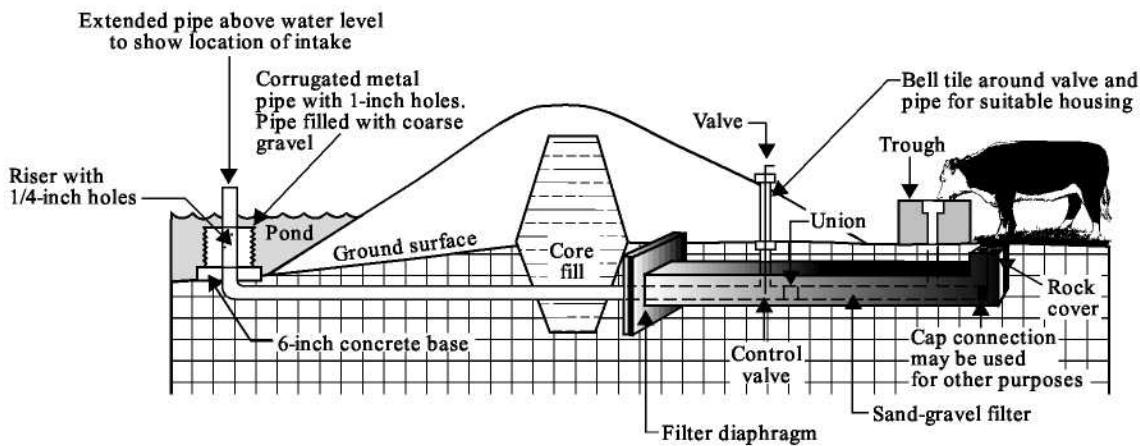
Extend the pipe 6 to 10 feet beyond the downstream toe of the dam to prevent damage by the flow of water from the pipe. For larger pipes, support the extension with a timber brace.

**Drainpipes**—Some state regulatory agencies require that provision be made for draining ponds completely or for fluctuating the water level to eliminate breeding places for mosquitoes. Whether compulsory or not, provision for draining a pond is desirable and recommended. It permits good pond management for fish production and allows maintenance and repair without cutting the fill or using siphons, pumps, or other devices to remove the water. Install a suitable gate or other control device and extend the drainpipe to the upstream toe of the dam to drain the pond.

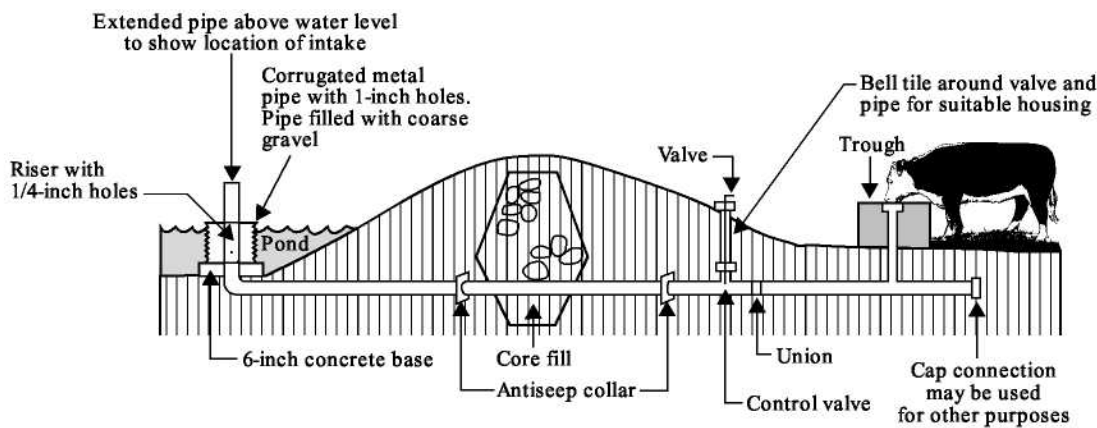
**Water-supply pipes**—Provide a water-supply pipe that runs through the dam if water is to be used at some point below the dam for supplying a stockwater trough, for irrigation, or for filling an orchard spray tank (fig. 26). This pipe is in addition to the principal spillway. A water-supply pipe should be rigid and have watertight joints, a strainer at its upper end, and a valve at its outlet end. For a small rate of flow, such as that needed to fill stockwater troughs, use steel or plastic pipe that is 1-1/2 inches in diameter. For a larger rate of flow, such as that needed for irrigation, use steel, plastic, or concrete pipe of larger diameter. Water-supply pipes also should have watertight joints and antiseep collars or a filter and drainage diaphragm.

**Figure 26** Water is piped through the dam's drainpipe to a stockwater trough

(a) Pipe with sand-gravel filter



(b) Pipe with antiseep collars





## Planning an earthfill dam

**Foundations**—You can build a safe earthfill dam on almost any foundation if you thoroughly investigate the foundation and adapt the design and construction to the conditions. Some foundation conditions require expensive construction measures that cannot be justified for small ponds.

The most satisfactory foundation consists of soil underlain at a shallow depth by a thick layer of relatively impervious consolidated clay or sandy clay. If a suitable layer is at or near the surface, no special measures are needed except removing the topsoil and scarifying or disking to provide a bond with the material in the dam.

If the foundation is sand or a sand-gravel mixture and there is no impervious clay layer at a depth that can be reached economically with available excavating equipment, an engineer should design the dam. Although such foundations may be stable, corrective measures are needed to prevent excessive seepage and possible failure. A foundation, consisting of or underlain by a highly plastic clay or unconsolidated material requires careful investigation and design to obtain stability. If the foundation consists of such materials, consult an engineer.

Water impounded on a bedrock foundation seldom gives cause for concern unless the rock contains seams, fissures, or crevices through which water may escape at an excessive rate. Where rock is in the foundation, investigate the nature of the rock carefully.

**Cutoffs**—If the dam's foundation is overlain by alluvial deposits of pervious sands and gravels at or near the surface and rock or clay at a greater depth, seepage in the pervious stratum must be reduced to prevent possible failure of the dam by piping. To prevent excessive seepage, you need a cutoff to join the impervious stratum in the foundation with the base of the dam.

The most common kind of cutoff is made of compacted clayey material. A trench is excavated along the centerline of the dam deep enough to extend well into the impervious layer (fig. 27). This trench extends into and up the abutments of the dam as far as there is any pervious material that might allow seepage. The bottom of the trench should be no less than 8 feet wide (or the bulldozer blade width, whichever is

greater), and the sides no steeper than 1.5:1. Fill the trench with successive thin layers (9-inch maximum) of clay or sandy clay material. Compact each layer thoroughly at near-optimum moisture conditions before placing the next layer. The moisture content is adequate for compaction when the material can be formed into a firm ball that sticks together and remains intact when the hand is vibrated violently and no free water appears.

**Top width and alignment**—For dams less than 10 feet high, a conservative minimum top width is 6 feet. As the height of the dam increases, increase the top width. The recommended minimum top width for earth embankments of various heights is:

<u>Height of dam</u> (ft)	<u>Minimum top width</u> (ft)
Under 10	6
11 to 14	8
15 to 19	10
20 to 24	12
25 to 34	14

If the top of the embankment is to be used for a roadway, provide for a shoulder on each side of the roadway to prevent raveling. The top width should be at least 16 feet. In some situations a curved dam align-

**Figure 27** A core trench is cut on the centerline of a dam



ment is more desirable than a straight alignment. Curvature can be used to retain existing landscape elements, reduce the apparent size of the dam, blend the dam into surrounding natural landforms, and provide a natural-appearing shoreline.

**Side slopes**—The side slopes of a dam depend primarily on the stability of the fill and on the strength and stability of the foundation material. The more stable the fill material, the steeper the side slopes. Unstable materials require flatter side slopes. Recommended slopes for the upstream and downstream faces of dams built of various materials are shown in table 16.

For stability, the slopes should not be steeper than those shown in table 16, but they can be flatter as long as they provide surface drainage. The side slopes need not be uniform, but can be shaped to blend with the surrounding landforms (fig. 28).

Finish-grading techniques used to achieve a smooth landform transition include slope rounding and slope warping. Slope rounding is used at the top and bottom of cuts or fills and on side slope intersections. Slope warping is used to create variety in the horizontal and vertical pitch of finished slopes (fig. 29). Additional fill can be placed on the backslope and abutments of the dam, if needed, to achieve this landform transition.

**Freeboard**—Freeboard is the additional height of the dam provided as a safety factor to prevent overtopping by wave action or other causes. It is the vertical distance between the elevation of the water surface in the pond when the spillway is discharging at designed depth and the elevation of the top of the dam after all

settlement. If your pond is less than 660 feet long, provide a freeboard of no less than 1 foot. The minimum freeboard is 1.5 feet for ponds between 660 and 1,320 feet long, and is 2 feet for ponds up to a half mile long. For longer ponds an engineer should determine the freeboard.

**Settlement allowance**—Settlement or consolidation depends on the character of the materials in both the dam and the foundation and on the construction method. To allow for settlement, build earth dams somewhat higher than the design dimensions. If your dam is adequately compacted in thin layers under good moisture conditions, there is no reason to expect any appreciable settlement in the dam itself, but the foundation may settle. For a compacted fill dam on unyielding foundation, settlement is negligible.

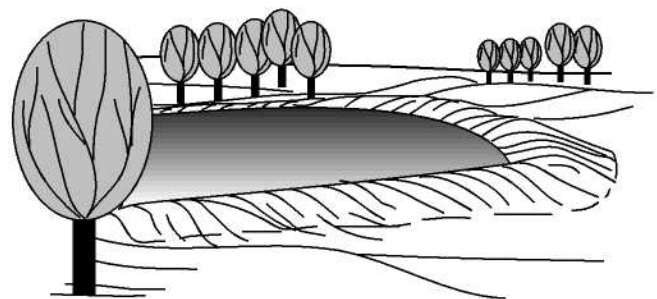
Most foundations are yielding, and settlement may range from 1 to 6 percent of the height of the dam, mainly during construction. The settlement allowance for a rolled-fill dam should be about 5 percent of the designed dam height. In other words, the dam is built 5 percent higher than the designed height. After settlement, the height of the dam will be adequate. Most pond dams less than 20 feet high, however, are not rolled fill. For these dams the total settlement allowance should be about 10 percent.

**Estimating the volume of the earthfill**—After planning is completed, estimate the number of cubic yards of earthfill required to build the dam. Also estimate excavation yardage in foundation stripping, core trench excavation, and any other significant excavations. This helps predict the cost of the dam

**Table 16** Recommended side slopes for earth dams

Fill material	Slope	
	Upstream	Downstream
Clayey sand, clayey gravel, sandy clay, silty sand, silty gravel	3:1	2:1
Silty clay, clayey silt	3:1	3:1

**Figure 28** Dam side slopes are curved and shaped to blend with surrounding topography



and serves as a basis for inviting bids and for awarding a construction contract. The estimate of the volume of earthfill should include

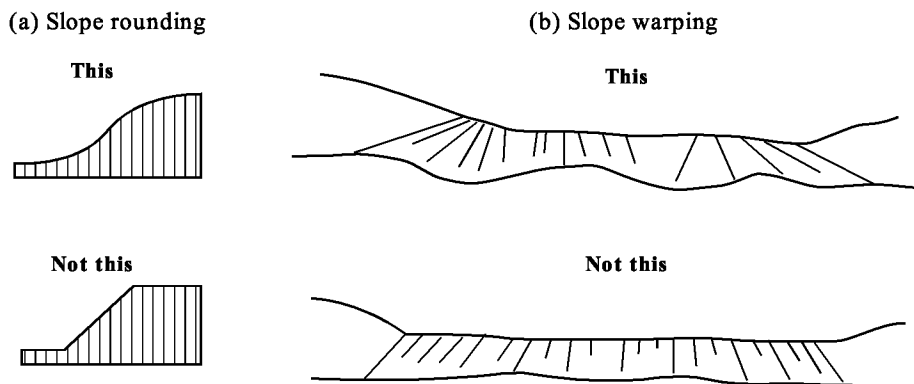
- volume in the dam itself including the allowance for settlement,
- volume required to backfill the cutoff trench,
- volume required to backfill stream channels or holes in the foundation area, and
- any other volume of earthfill the contractor is required to move.

Volume estimates for dams generally are made of the required number of cubic yards of earthfill in place. Probably the most efficient method of estimating the volume of earthfill is the sum-of-end-area method. The ground surface elevations at all points along the centerline of the dam where the slope changes significantly are established by the centerline profile. With the settled top elevation of the dam established, you

can obtain the settle fill height at each of these points by subtracting the ground surface elevation from the settle top elevation. With the fill heights, side slopes, and top width established, find the end areas at each of these stations along the centerline in table 17.

For example, assume that a dam has slopes of 3:1 on both upstream and downstream sides and a top width of 12 feet. For a point along the centerline where the fill is 15 feet high, the table shows that the end area at that point is 675 plus 180, or 855 square feet. The number of cubic yards of fill between two points on the centerline of the dam is equal to the sum of the end areas at those two points multiplied by the distance between these points and divided by 54. The total volume of earthfill in the dam is the sum of all such segments. A sample volume estimate illustrating the use of the sum-of-end-areas method is shown in table 18.

**Figure 29** Finished grading techniques



**Table 17** End areas in square feet of embankment sections for different side slopes and top widths <sup>1/</sup>

Fill height (ft)	-----Side slopes-----					-----Top width (ft)-----				
	2.5:1	2.5:1	3:1	3.5:1	4:1	8	10	12	14	16
	2.5:1	3:1	3:1	3.5:1	4:1					
	2:1	2:1	2.5:1	3:1	3:1					
	3:1	3.5:1	3.5:1	4:1	5:1					
1.0	3	3	3	4	4	8	10	12	14	16
1.2	4	4	4	5	6	10	12	14	17	19
1.4	5	5	6	7	8	11	14	17	20	22
1.6	6	7	8	9	10	13	16	19	22	26
1.8	8	9	10	11	13	14	18	22	25	29
2.0	10	11	12	14	16	16	20	24	28	32
2.2	12	13	15	17	19	18	22	27	31	35
2.4	14	16	17	20	23	19	24	29	34	39
2.6	17	19	20	24	27	21	26	31	36	42
2.8	20	22	23	27	31	22	28	34	39	45
3.0	22	25	27	32	36	24	30	36	42	48
3.2	26	28	31	36	41	26	32	38	45	51
3.4	29	32	35	40	46	27	34	41	47	55
3.6	32	36	39	45	52	29	36	43	50	58
3.8	36	40	43	50	58	30	38	46	53	61
4.0	40	44	48	56	64	32	40	48	56	64
4.2	44	49	53	62	71	34	42	50	59	67
4.4	48	53	58	68	77	35	44	53	61	71
4.6	53	58	63	74	85	37	46	55	64	74
4.8	57	63	69	81	92	38	48	57	67	77
5.0	62	69	75	87	100	40	50	60	70	80
5.2	67	74	81	94	108	42	52	62	73	83
5.4	73	80	87	102	117	43	54	65	75	87
5.6	78	86	94	110	125	45	56	67	78	90
5.8	84	93	101	118	135	46	58	69	81	93
6.0	90	99	108	126	144	48	60	72	84	96
6.2	96	106	115	135	154	50	62	74	87	99
6.4	102	113	123	143	164	51	64	77	89	103
6.6	109	120	131	152	174	53	66	79	92	106
6.8	116	128	139	162	185	54	68	81	95	109
7.0	123	135	147	172	196	56	70	84	98	112
7.2	130	143	156	182	207	58	72	86	101	115
7.4	138	152	165	193	219	59	74	89	103	119
7.6	145	159	174	203	231	61	76	91	106	122
7.8	153	168	183	214	243	62	78	93	109	125
8.0	160	176	192	224	256	64	80	96	112	128
8.2	169	185	202	235	269	66	82	98	115	131
8.4	177	194	212	247	282	67	84	101	117	135
8.6	186	204	222	259	296	69	86	103	120	138
8.8	194	213	232	271	310	70	88	105	123	141

See footnote at end of table.



**Table 17** End areas in square feet of embankment sections for different side slopes and top widths <sup>1/</sup>—Continued.

Fill height (ft)	-----Side slopes -----					----- Top width (ft) -----				
	2.5:1	2.5:1	3:1	3.5:1	4:1	8	10	12	14	16
	2.5:1	3:1	3:1	3.5:1	4:1					
	2:1	2:1	2.5:1	3:1	3:1					
3:1	3.5:1	3.5:1	4:1	5:1						
9.0	203	223	243	283	324	72	90	108	126	144
9.2	212	233	254	296	339	74	92	110	129	147
9.4	222	244	266	310	353	75	94	113	131	151
9.6	231	254	277	323	369	77	96	115	134	154
9.8	241	265	289	337	384	78	98	117	137	157
10.0	250	275	300	350	400	80	100	120	140	160
10.2	260	286	313	364	416		102	122	143	163
10.4	271	298	325	379	433		104	125	145	167
10.6	281	309	338	394	449		106	127	148	170
10.8	292	321	350	409	467		108	129	151	173
11.0	302	333	363	424	484		110	132	154	176
11.2	313	344	376	440	502		112	134	157	179
11.4	325	357	390	456	520		114	137	159	183
11.6	336	370	404	472	538		116	139	162	186
11.8	348	383	418	488	557		118	141	165	189
12.0	360	396	432	504	576		120	144	168	192
12.2	372	409	447	522	595		122	146	171	195
12.4	385	424	462	539	615		124	149	173	199
12.6	397	437	477	557	635		126	151	176	202
12.8	410	451	492	574	655		128	153	179	205
13.0	422	465	507	592	676		130	156	182	208
13.2	436	479	523	610	697		132	158	185	211
13.4	449	494	539	629	718		134	161	187	215
13.6	463	509	555	648	740		136	163	190	218
13.8	476	523	571	667	762		138	166	193	221
14.0	490	539	588	686	784		140	168	196	224
14.2	505	555	605	706	807		142	170	199	227
14.4	519	570	622	726	829		144	173	202	230
14.6	534	586	639	746	853		146	175	204	234
14.8	548	602	657	767	876		148	178	207	237
15.0	563	619	675	788	900		150	180	210	240
15.2	578	635	693	809	924		152	182	213	243
15.4	594	653	711	830	949		154	185	216	246
15.6	609	669	730	852	973		156	187	218	250
15.8	625	687	749	874	999		158	190	221	253
16.0	640	704	768	896	1,024		160	192	224	256
16.2	656	722	787	919	1,050			194	227	259
16.4	673	740	807	942	1,076			197	230	262
16.6	689	758	827	965	1,102			199	232	266
16.8	706	776	847	988	1,129			202	235	269
17.0	723	795	867	1,012	1,156			204	238	272

See footnote at end of table.

**Table 17** End areas in square feet of embankment sections for different side slopes and top widths <sup>1/</sup>—Continued.

Fill height (ft)	-----Side slopes-----					-----Top width (ft)-----				
	2.5:1	2.5:1	3:1	3.5:1	4:1	8	10	12	14	16
	2.5:1	3:1	3:1	3.5:1	4:1					
	2:1	2:1	2.5:1	3:1	3:1					
3:1	3.5:1	3.5:1	4:1	5:1						
17.2	740	814	888	1,036	1,183			206	241	275
17.4	757	833	909	1,060	1,211			209	244	278
17.6	774	852	930	1,084	1,239			211	246	282
17.8	792	871	951	1,109	1,267			214	249	285
18.0	810	891	972	1,134	1,296			216	252	288
18.2	828	911	994	1,160	1,325			218	255	291
18.4	846	931	1,016	1,186	1,354			221	258	294
18.6	865	951	1,038	1,212	1,384			223	260	298
18.8	884	972	1,060	1,238	1,414			226	263	301
19.0	903	993	1,083	1,264	1,444			228	266	304
19.2	922	1,014	1,106	1,291	1,475			230	269	307
19.4	941	1,035	1,129	1,318	1,505			233	272	310
19.6	960	1,056	1,152	1,345	1,537			235	274	314
19.8	980	1,078	1,176	1,372	1,568			238	277	317
20.0	1,000	1,100	1,200	1,400	1,600			240	280	320
20.2	1,020	1,122	1,224	1,428	1,632			242	283	323
20.4	1,040	1,144	1,248	1,457	1,665			245	286	326
20.6	1,061	1,167	1,273	1,486	1,697			247	288	330
20.8	1,082	1,190	1,298	1,515	1,731			250	291	333
21.0	1,103	1,213	1,323	1,544	1,764			252	294	336
21.2	1,124	1,236	1,348	1,574	1,798			254	297	339
21.4	1,145	1,254	1,374	1,604	1,832			257	300	342
21.6	1,166	1,283	1,400	1,634	1,866			259	302	346
21.8	1,188	1,307	1,426	1,664	1,901			262	305	349
22.0	1,210	1,331	1,452	1,694	1,936			264	308	352
22.2	1,232	1,356	1,479	1,725	1,971			266	311	355
22.4	1,254	1,380	1,506	1,756	2,007			269	314	358
22.6	1,277	1,405	1,533	1,788	2,043			271	316	362
22.8	1,300	1,430	1,560	1,820	2,079			274	319	365
23.0	1,323	1,455	1,587	1,852	2,116			276	322	368

1/ To find the end area for any fill height, add square feet given under staked side slopes to that under the top width for total section. Example: 6.4-foot 3:1 front and back slopes, 14-foot top width —123 plus 89, or 212 square feet for the section. Any combination of slopes that adds to 5, 6, or 7 may be used. A combination of 3.5:1 front and 2.5:1 back gives the same results as 3:1 front and back.

**Table 18** Volume of material needed for the earthfill

Station (ft)	Ground elevation (ft)	Fill height <sup>1/</sup> (ft)	End area <sup>2/</sup> (ft <sup>2</sup> )	Sum of end areas (ft <sup>2</sup> )	Distance (ft)	Double volume (ft <sup>3</sup> )
0 + 50	35.0	0	0	44	18	792
+ 68	32.7	2.3	44			
1 + 00	25.9	9.1	357	401	32	12,832
+ 37	21.5	13.5	709	1,066	37	39,442
+ 53	20.0	15.0	855	1,564	16	25,024
+ 75	19.8	15.2	875	1,730	22	38,060
2 + 00	19.5	15.5	906	1,781	25	44,525
+ 19	20.3	14.7	824	1,730	19	32,870
+ 32	20.3	14.7	824	1,648	13	21,424
+ 36	18.8	16.2	981	1,805	4	7,220
+ 40	18.2	16.8	1,049	2,030	4	8,120
+ 43	18.5	16.5	1,015	2,064	3	6,192
+ 46	19.6	15.4	896	1,911	3	5,733
+ 59	19.8	15.2	875	1,771	13	23,023
3 + 00	20.8	14.2	775	1,650	41	67,650
+ 35	27.7	7.3	248	1,023	35	35,805
+ 60	31.6	3.4	76	324	25	8,100
3 + 96	35.0	.0	0	76	36	2,736
<b>Total</b>						<b>379,548 <sup>3/</sup></b>

1/ Elevation of top of dam without allowance for settlement.

2/ End areas based on 12-foot top width and 3:1 slopes on both sides.

3/ Divide double volume in cubic feet by 54 to obtain volume in cubic yards; for example,

$$\frac{379,548}{54} = 7,029 \text{ yd}^3$$

Allowance for settlement (10%) = 703 yd<sup>3</sup>

Total volume = 7.732 yd<sup>3</sup>

The sample volume estimate of 7,732 cubic yards includes only the volume of earth required to complete the dam itself. Estimate the volume of earth required to backfill the core trench, old stream channels, and other required excavation and add it to the estimate for the dam. Also include an estimate of additional fill to be placed on the backslope and abutments. For example, assume that, in addition to the volume shown in table 18, there is a cutoff trench to be backfilled. The dimensions of the trench are:

Average depth = 4.0 ft  
 Bottom width = 8.0 ft  
 Side slopes = 1.5:1  
 Length = 177 ft

Compute the volume of backfill as follows:

$$\text{End area} = \left[ w + (z \times d) \right] d \quad [\text{Eq. 4}]$$

$$\text{Volume} = \frac{(\text{End area} \times l)}{27} \quad [\text{Eq. 5}]$$

where:

$d$  = average depth  
 $w$  = bottom width  
 $l$  = length  
 $z$  = side slopes

$$\text{End area} = [8 + (1.5 \times 4)]4 = 56 \text{ ft}^2$$

$$\text{Volume} = \frac{56 \times 177}{27} = 367 \text{ yd}^3$$

Add this to the volume required for the dam and the total volume is 7,732 plus 367, or 8,099 cubic yards. This 8,099 cubic yards represents the required compacted volume. To account for shrinkage resulting from compaction, a minimum of 1.5 times this amount is generally necessary to have available in the borrow areas and required excavations. In this example you need a minimum of 12,148 cubic yards available to construct the dam.

**Drawings and specifications**—Record on the engineering drawings all planning information that would affect the construction of the dam. These drawings should show all elevations and dimensions of the dam, the dimensions and extent of the cutoff trench and

other areas requiring backfill, the location and dimensions of the principal spillway and other planned appurtenances, and any other pertinent information. The drawings should also include a list of the estimated quantity and kind of building materials required. The construction and material specifications state the extent and type of work, site specific details, material quality, and requirements for prefabricated materials.

Observe all land disturbance laws by including temporary protective measures during construction to minimize soil erosion and sedimentation.

Unless you have all the necessary equipment, you will need to employ a contractor to build the pond. You may wish to receive bids from several contractors to be sure that you are getting the job done at the lowest possible cost. A set of drawings and specifications shows what is to be done. This provides a basis for contractors to bid on the proposed work, allows fair competition among bidders, and states the conditions under which the work is to be done. The specifications should

- give all the information not shown on the drawings that is necessary to define what is to be done,
- prescribe how the work is to be done if such direction is required,
- specify the quality of material and workmanship required, and
- define the method of measurement and the unit of payment for the various items of work that constitute the whole job.

Construction work of the quality and standards desired will not result unless there is a clear understanding of these requirements between the owner and the contractor. For these reasons specifications should be prepared for all ponds for which the owners award the construction contracts.

Assistance in preparing drawings and specifications is available from your local soil conservation district, NRCS specialists, or private consultants.



## Staking for construction

Each job must be adequately and clearly staked before construction is started. Staking transmits the information on the drawings to the job site. This information locates the work and provides the lines, grade, and elevations required for construction in accordance with the drawings. Consider the contractor's wishes in staking so that he can make the most effective use of the stakes. The quality and appearance of the completed job reflect the care used in staking. The staking should be done by an engineer or other qualified person.

The areas to be cleared generally consist of the dam site, the auxiliary spillway site, the borrow area, and the area over which water is to be impounded. Mark each area clearly with an adequate number of stakes. In the pond area, locate the proposed water line with a level and surveying rod. This provides a base line from which clearing limits can be established.

To locate the dam, set stakes along its centerline at intervals of 100 feet or less. (Generally this has been done during the initial planning survey.) Then set the fill and slope stakes upstream and downstream from the centerline stakes to mark the points of intersection of the side slopes with the ground surface and to mark the work area limits of construction. These stakes also establish the height of the dam.

To locate the earth auxiliary spillway, first stake the centerline and then set cut and slope stakes along the lines of intersection of the spillway side slopes with the natural ground surface.

If fill material must be obtained from a borrow area, this area must be clearly marked. Set cut stakes to indicate the depth to which the contractor can excavate to stay within the limits of suitable material, as indicated by soil borings. This allows the borrow area to drain readily and marks the limits of construction.

Set stakes to show the centerline location of the principal spillway after foundation preparation has reached the point at which the stakes will not be disturbed. Locate the pipe where it will rest on a firm foundation. Mark the stakes to show cuts from the top of the stakes to the grade elevation of the pipe. With additional stakes, mark the location of the riser, drainage gate, filter and drainage diaphragm or antiseep collars, outlet structures, and other appurtenances.

## Building the pond

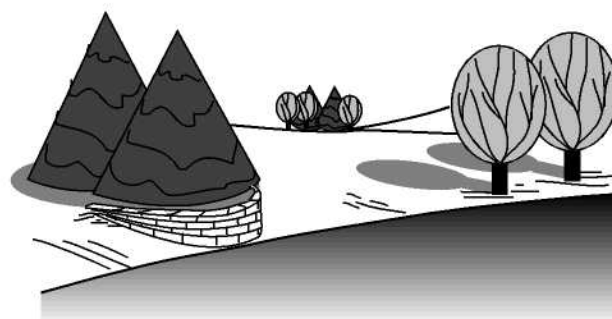
Attention to the details of construction and adherence to the drawings and specifications are as important as adequate investigation and design. Careless and shoddy construction can make an entirely safe and adequate design worthless and cause failure of the dam. Adherence to specifications and prescribed construction methods becomes increasingly important as the size of the structure and the failure hazards increase. Good construction is important regardless of size, and the cost is generally less in the long run than it is for dams built carelessly.

**Clearing and grubbing**—Clear the foundation area and excavated earth spillway site of trees and brush. In some states this is required by statute. Cut trees and brush as nearly flush with the ground as practicable and remove them and any other debris from the dam site. Should you or your contractor elect to uproot the trees with a bulldozer, you must determine if the tree roots extend into pervious material and if the resultant holes will cause excessive seepage. If so, fill the holes by placing suitable material in layers and compact each layer by compacting or tamping.

All material cleared and grubbed from the pond site, from the earth spillway and borrow areas, and from the site of the dam itself should be disposed of. This can be done by burning, burying under 2 feet of soil, or burying in a disposal area, such as a sanitary landfill.

Minimal clearing conserves site character and minimizes the difficulty and expense of reestablishing vegetation. Confine clearing limits to the immediate construction areas to avoid unnecessary disturbance.

**Figure 30** A tree well preserves vegetation



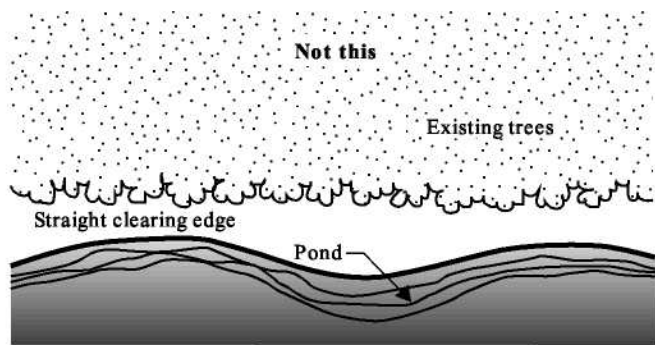
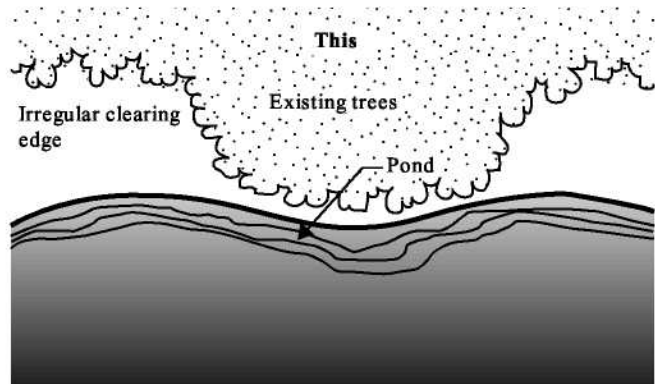
Removing all vegetation within the construction limits is not always necessary. Selected groupings of desirable plants can be kept. Trees and shrubs can often survive a 1- to 2-foot layer of graded fill over their root systems or they can be root-pruned in excavated areas. Tree wells and raised beds can also be used to retain vegetation (fig. 30).

Clearing limits should be irregular to create a natural-looking edge and open area (fig. 31). Further transition with vegetated surroundings can be accomplished by feathering clearing edges. Density and height of vegetation can be increased progressively from the water's edge to the undisturbed vegetation (fig. 32). Feathering can be accomplished by selective clearing, installation of new plants, or both.

**Preparing the foundation**—Preparing the foundation includes treating the surface, excavating and backfilling the cutoff trench, and excavating and backfilling existing stream channels. If the foundation has an adequate layer of impervious material at the surface or if it must be blanketed by such a layer, you can eliminate the cutoff trench. Remove sod, boulders, and topsoil from the entire area over which the embankment is to be placed. This operation is best performed by using a tractor-pulled or self-propelled wheeled scraper. The topsoil should be stockpiled temporarily for later use on the site.

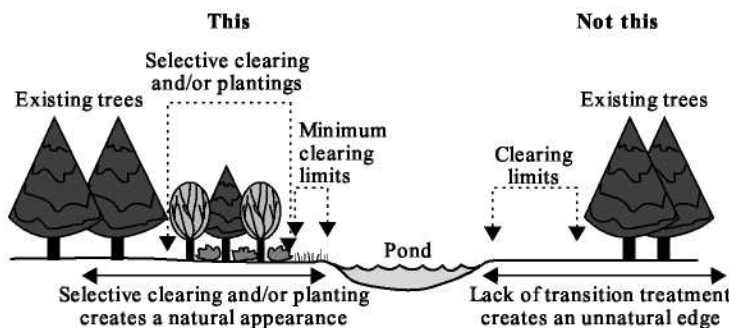
Fill all holes in the foundation area, both natural and those resulting from grubbing operations, with suitable fill material from borrow areas. Use the same method of placement and compaction as used to build the dam. Where necessary use hand or power tampers in areas not readily accessible to other compacting equipment.

**Figure 31** Irregular clearing around the pond helps create a natural appearing edge



After filling the holes, thoroughly break the ground surface and turn it to a depth of 6 inches. Roughly level the surface with a disk harrow and then compact it so that the surface materials of the foundation are as well compacted as the subsequent layers of the fill. Dig the cutoff trench to the depth, bottom width, and side slopes shown on the drawings. Often the depths shown on the drawings are only approximate; you

**Figure 32** Feathering vegetation at the pond's edge makes a natural transition with existing vegetation



need to inspect the completed trench before backfilling to be sure that it is excavated at least 12 inches into impervious material throughout its entire length.

Material removed from the trench can be placed in the downstream third of the dam and compacted in the same manner as the earthfill if the material is free of boulders, roots, organic matter, and other objectionable material.

A dragline excavator and a tractor-pulled or self-propelled wheeled scraper are the most satisfactory equipment for excavating cutoff trenches. Before backfilling operations are attempted, pump all free water from the cutoff trench. Some material high in clay content takes up more than twice its own weight of water and becomes a soggy mass. Such clay puddled in the cutoff of a dam may require many years to become stable. Also, in drying it contracts and may leave cracks that can produce a roof of the overlying impervious earthfill section and provide passageways for seepage through the dam.

Backfill the cutoff trench to the natural ground surface with suitable fill material from designated borrow areas. Place the backfill material in thin layers and compact it by the same methods used to build the dam.

Deepen, slope back, and widen stream channels that cross the embankment foundation. This is often necessary to remove all stones, gravel, sand, sediment, stumps, roots, organic matter, and any other objectionable material that could interfere with proper bonding of the earthfill with the foundation. Leave side slopes

of the excavated channels no steeper than 3:1 when the channels cross the embankment centerline. If the channels are parallel to the centerline, leave the side slopes no steeper than 1:1. Backfill these channels as recommended for the cutoff trench.

**Installing the pipe spillway**—Install the pipe, riser (if applicable), filter and drainage diaphragm or antiseep collars, trash rack, and other mechanical components of the dam to the lines and grades shown on the drawings and staked at the site. To minimize the danger of cracks or openings at the joints caused by unequal settlement of the foundation, place all pipes and other conduits on a firm foundation.

Install pipes and filter and drainage diaphragm or antiseep collars and tamp the selected backfill material around the entire structure before placing the earthfill for the dam. The same procedure applies to all other pipes or conduits.

**Excavating the earth spillway**—The completed spillway excavation should conform as closely as possible to the lines, grades, bottom width, and side slopes shown on the drawings and staked at the site. Leave the channel bottom transversely level to prevent meandering and the resultant scour within the channel during periods of low flow. If it becomes necessary to fill low places or depressions in the channel bottom caused by undercutting the established grade, fill them to the established grade by placing suitable material in 8-inch layers and compacting each layer under the same moisture conditions regardless of the placement in or under the embankment.

**Building the dam**—Clear the dam and spillway area of trees, brush, stumps, boulders, sod, and rubbish. The sod and topsoil can be stockpiled and used later to cover the dam and spillway (fig. 33). This will help when vegetation is established. Get suitable fill material from previously selected borrow areas and from sites of planned excavation. The material should be free of sod, roots, stones more than 6 inches in diameter, and any material that could prevent the desired degree of compaction. Do not use frozen material or place fill material on frozen foundations.

Selected backfill material should be placed in the core trench and around pipes and antiseep collars, when used. The material should be compacted by hand tamping or manually directed power tampers around pipes. Begin placing fill material at the lowest point and bring it up in horizontal layers, longitudinal to the centerline of dam, approximately 6 inches thick. For fill placement around risers, pipes and filter, and drainage diaphragms, the horizontal layers should be

approximately 4 inches thick. Do not place fill in standing water. The moisture content is adequate for compaction when the material can be formed into a firm ball that sticks together and remains intact when the hand is vibrated violently and no free water appears. If the material can be formed into a firm ball that sticks together, the moisture content is adequate for compaction. Laboratory tests of the fill material and field testing of the soil for moisture and compaction may be necessary for large ponds or special conditions.

If the material varies in texture and gradation, use the more impervious (clay) material in the core trench, center, and upstream parts of the dam. Construction equipment can be used to compact earthfill in an ordinary pond dam. Equipment that has rubber tires can be routed so each layer is sufficiently covered by tire tracks. For dams over 20 feet high, special equipment, such as sheepsfoot rollers, should be used.

**Figure 33** The sod and topsoil in a pond construction area can be stockpiled for later use





## Excavated ponds

Excavated ponds are the simplest to build in relatively flat terrain. Because their capacity is obtained almost solely by excavation, their practical size is limited. They are best suited to locations where the demand for water is small. Because excavated ponds can be built to expose a minimum water surface area in proportion to their volume, they are advantageous in places where evaporation losses are high and water is scarce. The ease with which they can be constructed, their compactness, their relative safety from flood-flow damage, and their low maintenance requirements make them popular in many sections of the country.

Two kinds of excavated ponds are possible. One is fed by surface runoff and the other is fed by ground water aquifers, usually layers of sand and gravel. Some ponds may be fed from both of these sources.

The general location of an excavated pond depends largely on the purpose or purposes for which the water is to be used and on other factors discussed previously in this handbook. The specific location is often influenced by topography. Excavated ponds fed by surface runoff can be located in almost any kind of topography. They are, however, most satisfactory and most commonly used in areas of comparatively flat, but well-drained terrain. A pond can be located in a broad natural drainageway or to one side of a drainageway if the runoff can be diverted into the pond. The low point of a natural depression is often a good location. After the pond is filled, excess runoff escapes through regular drainageways.

Excavated ponds fed by ground water aquifers can be located only in areas of flat or nearly flat topography. If possible, they should be located where the permanent water table is within a few feet of the surface.

### Soils

If an excavated pond is to be fed by surface runoff, enough impervious soil at the site is essential to avoid excess seepage losses. The most desirable sites are where fine-textured clay and silty clay extend well below the proposed pond depth. Sites where sandy

clay extends to adequate depths generally are satisfactory. Avoid sites where the soil is porous or is underlain by strata of coarse-textured sand or sand-gravel mixtures unless you are prepared to bear the expense of an artificial lining. Avoid soil underlain by limestone containing crevices, sinks, or channels.

The performance of nearby ponds that are fed by runoff and in a similar soil is a good indicator of the suitability of a proposed site. Supplement such observations of existing ponds by boring enough test holes at intervals over the proposed pond site to determine accurately the kind of material there. You can get some indication of permeability by filling the test holes with water. The seepage indicates what to expect of a pond excavated in the same kind of material.

If an excavated pond is to be fed from a water-bearing sand or a sand-gravel layer, the layer must be at a depth that can be reached practically and economically by the excavating equipment. This depth seldom exceeds 20 feet. The water-bearing layer must be thick enough and permeable enough to yield water at a rate that satisfies the maximum expected demand for water and overcomes evaporation losses.

Thoroughly investigate sites proposed for aquifer-fed excavated ponds. Bore test holes at intervals over the site to determine the existence and physical characteristics of the water-bearing material. The water level in the test holes indicates the normal water level in the completed pond. The vertical distance between this level and the ground surface determines the volume of overburden or excavation needed that does not contribute to the usable pond capacity, but may increase the construction cost considerably. From an economic standpoint, this vertical distance between water level and ground surface generally should not exceed 6 feet.

Check the rate at which the water rises in the test holes. A rapid rate of rise indicates a high-yielding aquifer. If water is removed from the pond at a rapid rate, as for irrigation, the water can be expected to return to its normal level within a short time after removal has ceased. A slow rate of rise in the test holes indicates a low-yielding aquifer and a slow rate of recovery in the pond. Check the test hole during drier seasons to avoid being misled by a high water table that is only temporary.

### Spillway and inlet requirements

If you locate an excavated pond fed by surface runoff on sloping terrain, you can use a part of the excavated material for a small low dam around the lower end and sides of the pond to increase its capacity. You need an auxiliary spillway to pass excess storm runoff around the small dam. Follow the procedures for planning the spillway and provide protection against erosion as discussed in the *Excavating the earth spillway* section.

Ponds excavated in areas of flat terrain generally require constructed spillways. If surface runoff must enter an excavated pond through a channel or ditch rather than through a broad shallow drainageway, the overfall from the ditch bottom to the bottom of the pond can create a serious erosion problem unless the ditch is protected. Scouring can occur in the side slope of the pond and for a considerable distance upstream in the ditch. The resulting sediment tends to reduce the depth and capacity of the pond. Protect the slope by placing one or more lengths of rigid pipe in the ditch and extending them over the side slope of the excavation. The extended part of the pipe or pipes can be cantilevered or supported with timbers. The diameter of the pipes depends on the peak rate of runoff that can be expected from a 10-year frequency storm. If you need more than one pipe inlet, the combined capacity should equal or exceed the estimated peak rate of runoff.

<u>Pipe diameter</u> <sup>1/</sup> (in)	<u>Pond inflow Q</u> (ft <sup>3</sup> /s)
15	0 to 6
18	6 to 9
21	9 to 13
24	13 to 18
30	18 to 30
36	30 to 46
42	46 to 67
48	67 to 92
54	92 to 122
60	122 to 157

<sup>1/</sup> Based on a free outlet and a minimum pipe slope of 1 percent with the water level 0.5 foot above the top of the pipe at the upstream end.

In areas where a considerable amount of silt is carried by the inflowing water, you should provide a desilting area or filterstrip in the drainageway immediately above the pond to remove the silt before it enters the pond. This area or strip should be as wide as or somewhat wider than the pond and 100 feet or more long. After you prepare a seedbed, fertilize, and seed the area to an appropriate mix of grasses and forbs. As the water flows through the vegetation, the silt settles out and the water entering the pond is relatively silt free.

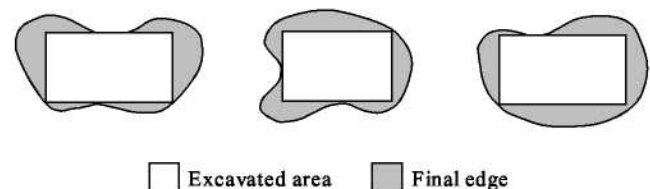
### Planning the pond

Although excavated ponds can be built to almost any shape desired, a rectangle is commonly used in relatively flat terrain. The rectangular shape is popular because it is simple to build and can be adapted to all kinds of excavating equipment.

Rectangular ponds should not be constructed, however, where the resulting shape would be in sharp contrast to surrounding topography and landscape patterns. A pond can be excavated in a rectangular form and the edge shaped later with a blade scraper to create an irregular configuration (fig. 34).

The capacity of an excavated pond fed by surface runoff is determined largely by the purpose or purposes for which water is needed and by the amount of inflow that can be expected in a given period. The required capacity of an excavated pond fed by an underground waterbearing layer is difficult to determine because the rate of inflow into the pond can seldom be estimated accurately. For this reason, the pond should be built so that it can be enlarged if the original capacity proves inadequate.

**Figure 34** Geometric excavation graded to create more natural configuration



**Selecting the dimensions**—The dimensions selected for an excavated pond depend on the required capacity. Of the three dimensions of a pond, the most important is depth. All excavated ponds should have a depth equal to or greater than the minimum required for the specific location. If an excavated pond is fed from ground water, it should be deep enough to reach well into the waterbearing material. The maximum depth is generally determined by the kind of material excavated and the type of equipment used.

The type and size of the excavating equipment can limit the width of an excavated pond. For example, if a dragline excavator is used, the length of the boom usually determines the maximum width of excavation that can be made with proper placement of the waste material.

The minimum length of the pond is determined by the required pond capacity.

To prevent sloughing, the side slopes of the pond are generally no steeper than the natural angle of repose of the material being excavated. This angle varies with different soils, but for most ponds the side slopes are 1:1 or flatter (fig. 35).

If the pond is to be used for watering livestock, provide a ramp with a flat slope (4:1 or flatter) for access.

Regardless of the intended use of the water, these flat slopes are necessary if certain types of excavating equipment are used. Tractor-pulled wheeled scrapers and bulldozers require a flat slope to move material from the bottom of the excavation.

**Estimating the volume**—After you have selected the dimensions and side slopes of the pond, estimate the volume of excavation required. This estimate determines the cost of the pond and is a basis for inviting bids and for making payment if the work is to be done by a contractor.

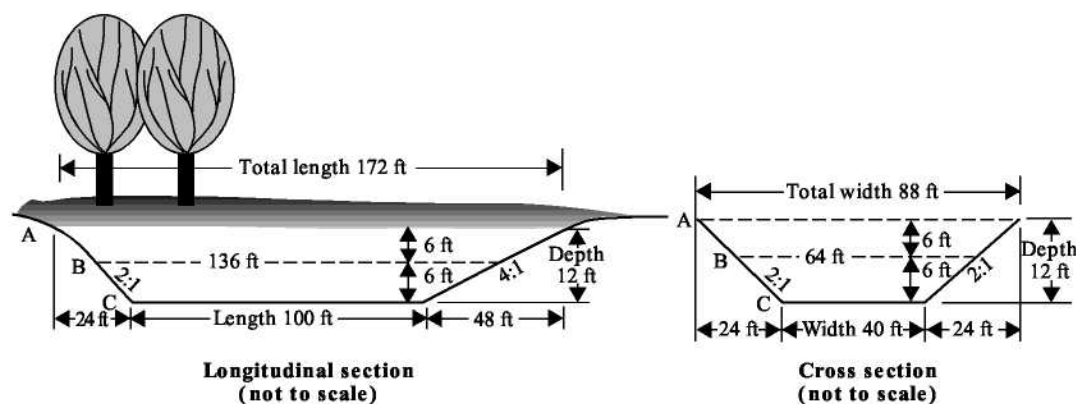
The volume of excavation required can be estimated with enough accuracy by using the prismoidal formula:

$$V = \frac{(A + 4B + C)}{6} \times \frac{D}{27} \quad [\text{Eq. 6}]$$

where:

- $V$  = volume of excavation (yd<sup>3</sup>)
- $A$  = area of the excavation at the ground surface (ft<sup>2</sup>)
- $B$  = area of the excavation at the mid-depth (1/2 D) point (ft<sup>2</sup>)
- $C$  = area of the excavation at the bottom of the pond (ft<sup>2</sup>)
- $D$  = average depth of the pond (ft<sup>2</sup>)
- 27 = factor converting cubic feet to cubic yards

**Figure 35** Typical sections of an excavated pond



As an example, assume a pond with a depth,  $D$ , of 12 feet, a bottom width,  $W$ , of 40 feet, and a bottom length,  $L$ , of 100 feet as shown in figure 35. The side slope at the ramp end is 4:1, and the remaining slopes are 2:1. The volume of excavation,  $V$ , is computed as follows:

$$\begin{aligned} A &= 88 \times 172 = 15,136 \\ 4B &= 4(64 \times 136) = 34,816 \\ C &= 40 \times 100 = 4,000 \\ (A + 4B + C) &= 53,952 \end{aligned}$$

Then

$$V = \frac{53,952}{6} \times \frac{12}{27} = 3,996 \text{ yd}^3$$

If the normal water level in the pond is at the ground surface, the volume of water that can be stored in the pond is 3,996 cubic yards times 0.00061963, or 2.48 acre-feet. To convert to gallons, 3,996 cubic yards multiplied by 201.97 equals 807,072 gallons. The same procedure is used to compute the volume of water that can be stored in the pond if the normal water level is below the ground surface. The value assigned to the depth  $D$  is the actual depth of the water in the pond rather than depth of excavation.

A summary of methods for estimating the volume of an excavated pond is provided in appendix A. This summary information is reprinted from NRCS (formerly SCS) Landscape Architecture Note No. 2, Landscape Design: Ponds, September 2, 1988.

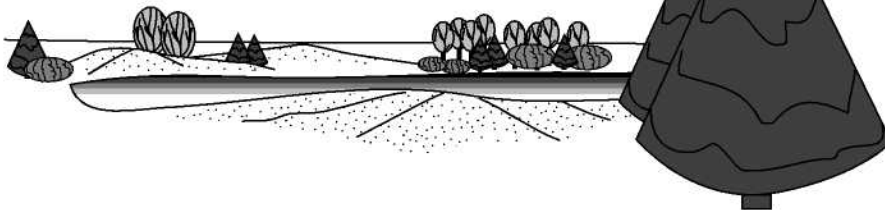
**Waste material**—Plan the placement or disposal of the material excavated from the pond in advance of construction operations. Adequate placement prolongs the useful life of the pond, improves its appearance, and facilitates maintenance and establishment of vegetation. The waste material can be stacked, spread, or removed from the site as conditions, nature of the material, and other circumstances warrant.

If you do not remove the waste material from the site, place it so that its weight does not endanger the stability of the side slopes and rainfall does not wash the material back into the pond. If you stack the material, place it with side slopes no steeper than the natural angle of repose of the soil. Do not stack waste material in a geometric mound, but shape and spread it to blend with natural landforms in the area. Because many excavated ponds are in flat terrain, the waste material may be the most conspicuous feature in the landscape. Avoid interrupting the existing horizon line with the top of the waste mound (fig. 36).

**Figure 36** Correct disposal of waste material

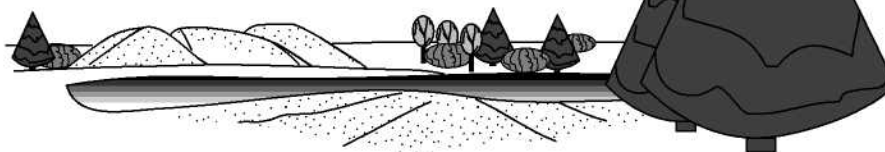
Waste material properly shaped, graded, and vegetated blends into surrounding landscape.

This



Waste material poorly shaped, unvegetated, and interrupting the horizon line appears unnatural.

Not this



Waste material can also be located and designed to be functional. It can screen undesirable views, buffer noise and wind, or improve the site's suitability for recreation (fig. 37). In shaping the material, the toe of the fill must be at least 12 feet from the edge of the pond. In the Great Plains you can place the waste material on the windward side of the pond to serve as a snow fence for collecting drifts in the pond. These banks can also reduce evaporation losses by breaking the force of prevailing winds across the pond.

Perhaps the most satisfactory method of handling waste material is to remove it from the site. Complete removal, however, is expensive and can seldom be justified unless the material is needed nearby. Waste material can sometimes be used advantageously for filling nearby low areas in a field or in building farm roads. If state or county highway maintenance crews need such material, you may be able to have them remove it.

## Building the pond

Clear the pond area of all undesired vegetation. Mark the outside limits of the proposed excavation with stakes. On the stakes indicate the depth of cut from the ground surface to the pond bottom.

Excavation and placement of the waste material are the principal items of work in building this type pond.

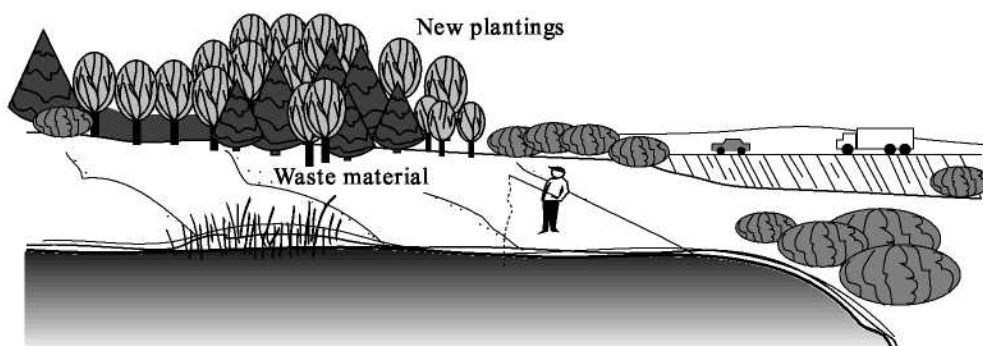
The kind of excavating equipment used depends on the climatic and physical conditions at the site and on what equipment is available.

In low-rainfall areas where water is unlikely to accumulate in the excavation, you can use almost any kind of available equipment. Tractor-pulled wheeled scrapers, dragline excavators, and track-type tractors equipped with a bulldozer blade are generally used. Bulldozers can only push the excavated material, not carry it; if the length of push is long, using these machines is expensive.

In high-rainfall areas and in areas where the water table is within the limits of excavation, a dragline excavator is commonly used because it is the only kind of equipment that operates satisfactorily in any appreciable depth of water. For ponds fed by ground water aquifers, a dragline is normally used to excavate the basic pond.

Excavate and place the waste material as close as possible to the lines and grades staked on the site. If you use a dragline excavator, you generally need other kinds of equipment to stack or spread the waste material and shape the edge to an irregular configuration. Bulldozers are most commonly used. Graders, either tractor-pulled or self-propelled, can be used to good advantage, particularly if the waste material is to be shaped.

**Figure 37** Waste material and plantings separate the pond from a major highway





---

## Sealing the pond

Excessive seepage in ponds is generally because the site is poor; that is, one where the soils in the impounding area are too permeable to hold water. Selecting a poor site is often the result of inadequate site investigations and could have been avoided. In some places no satisfactory site is available, but the need for water is great enough to justify using a site that is somewhat less than satisfactory. In this case the original pond design must include plans for reducing seepage by sealing (fig. 38). In some places excessive removal of the soil mantle during construction, usually to provide material for the embankment, exposes highly pervious material, such as sand, gravel, or rock containing cracks, crevices, or channels. This can be avoided by carefully selecting the source of embankment material.

To prevent excessive seepage, reduce the permeability of the soils to a point at which losses are insignificant or at least tolerable. The method depends largely on the proportions of coarse-grained sand and gravel and of fine-grained clay and silt in the soil.

## Compaction

Some pond areas can be made relatively impervious by compaction alone if the material contains a wide range of particle sizes (small gravel or coarse sand to fine sand) and enough clay (10 percent or more) and silt to effect a seal. This is the least expensive method of those presented in this handbook. Its use, however, is limited to these soil conditions as well as by the depth of water to be impounded.

The procedure is simple. Clear the pond area of all trees and other vegetation. Fill all stump holes, crevices, and similar areas with impervious material. Scarify the soil to a depth of 16 to 18 inches with a disk, rototiller, pulverizer, or similar equipment. Remove all rocks and tree roots. Roll the loosened soil under optimum moisture conditions in a dense, tight layer with four to six passes of a sheepsfoot roller in the same manner as for compacting earth embankments.

Make the compacted seal no less than 12 inches thick where less than 10 feet of water is to be impounded. Because seepage losses vary directly with the depth of water impounded over an area, increase the thickness of the compacted seal proportionately if the depth of

---

**Figure 38** Disking in chemical additive to seal a pond



water impounded exceeds 10 feet or more. The thickness of the compacted seal can be determined using equation 7.

$$d = \frac{k \times H}{(v - k)} \quad [\text{Eq. 7}]$$

where:

- $d$  = thickness of compacted seal
- $k$  = coefficient of permeability of compacted seal, which is assumed to be 0.003 fpd unless testing is done
- $H$  = water depth
- $v$  = allowable specific discharge which is assumed to be 0.028 fpd unless otherwise specified

As an example, assume a pond with a depth,  $H$ , of 12 feet. No soil samples were taken for laboratory testing. Therefore, use the assumed values for  $k$  and  $v$ . Calculate the required minimum thickness of the compacted seal. Using the preceding equation:

$$\begin{aligned} d &= \frac{0.003 \text{ fpd} \times 12 \text{ ft}}{0.028 \text{ fpd} - 0.003 \text{ fpd}} \\ &= 1.4 \text{ ft} \end{aligned}$$

If soil samples were taken and permeability tests were performed on the material of the compacted seal at the density it is to be placed, a thickness less than what was calculated may be possible. Without knowing whether the soil underlying the compacted layer will act as a filter for the compacted layer, the minimum thickness should never be less than 12 inches.

Compact the soils in two or more layers not exceeding 9 inches uncompacted over the area. Remove and stockpile the top layer or layers while the bottom layer is being compacted.

## Clay blankets

Pond areas containing high percentages of coarse-grained soils, but lacking enough clay to prevent excessive seepage, can be sealed by blanketing. Blanket the entire area over which water is to be impounded as well as the upstream slope of the embankment. The blanket should consist of a well-graded

material containing at least 20 percent clay. The requirements for good blanket material are about the same as those described for earth embankments. You can usually obtain material for the blanket from a borrow area close enough to the pond to permit hauling at a reasonable cost.

Thickness of the blanket depends on the depth of water to be impounded. The minimum compacted thickness is 12 inches for all depths of water under 10 feet. Increase this thickness by 2 inches for each foot of water over 10 feet and above.

Construction is similar to that for earth embankments. Remove all trees and other vegetation and fill all holes and crevices before hauling earth material from the borrow area to the pond site in tractor-pulled wheeled scrapers or similar equipment. Spread the material uniformly over the area in layers 6 to 8 inches thick. Compact each layer thoroughly, under optimum moisture conditions, by four to six passes of a sheepsfoot roller before placing the next layer.

Protect clay blankets against cracking that results from drying and against rupture caused by freezing and thawing. Spread a cover of gravel 12 to 16 inches thick over the blanket below the anticipated high water level. Use rock riprap or other suitable material to protect areas where the waterflow into the pond is concentrated.

## Bentonite

Adding bentonite is another method of reducing excessive seepage in soils containing high percentages of coarse-grained particles and not enough clay. Bentonite is a fine-textured colloidal clay. When wet it absorbs several times its own weight of water and, at complete saturation, swells as much as 8 to 20 times its original volume. Mixed in the correct proportions with well-graded coarse-grained material, thoroughly compacted and then saturated, the particles of bentonite swell until they fill the pores to the point that the mixture is nearly impervious to water. On drying, however, bentonite returns to its original volume leaving cracks. For this reason, sealing with bentonite usually is not recommended for ponds in which the water level is expected to fluctuate widely. A laboratory analysis of the pond area material to determine the rate of application is essential.

Before selecting this method of sealing a pond, locate the nearest satisfactory source of bentonite and investigate the freight rates. If the source is far from the pond site, the cost may prohibit the use of bentonite.

As with other methods, clear the pond area of all vegetation. Fill all holes or crevices, and cover and compact areas of exposed gravel with suitable fill material.

The soil moisture level in the area to be treated is important. Investigate it before applying bentonite. The moisture level should be optimum for good compaction. If the area is too wet, postpone sealing until moisture conditions are satisfactory. If it is too dry, add water by sprinkling.

Spread the bentonite carefully and uniformly over the area to be treated at the rate determined by the laboratory analysis. This rate usually is 1 to 3 pounds per square foot of area. Thoroughly mix the bentonite with the surface soil to a depth that will result in a 6-inch compacted layer. This generally is an uncompacted thickness of approximately 8 to 9 inches. A rototiller is best for this operation, but a disk or similar equipment can be used. Then compact the area with four to six passes of a sheepsfoot roller.

If considerable time elapses between applying the bentonite and filling the pond, protecting the treated area against drying and cracking may be necessary. A mulch of straw or hay pinned to the surface by the final passes of the sheepsfoot roller gives this protection. Use rock riprap or other suitable material to protect areas where water inflow into the treated area is concentrated.

## Chemical additives

Because of the structure or arrangement of the clay particles, seepage is often excessive in fine-grained clay soils. If these particles are arranged at random with end-to-plate or end-to-end contacts, they form an open, porous, or honeycomb structure; the soil is said to be aggregated. Applying small amounts of certain chemicals to these porous aggregates may result in collapse of the open structure and rearrangement of the clay particles. This dispersed structure reduces soil permeability. The chemicals used are called dispersing agents.

The soils in the pond area should contain more than 50 percent fine-grained material (silt and clay) and at least 15 percent clay for chemical treatment to be effective. Chemical treatment is not effective in coarse-grained soils.

Although many soluble salts are dispersing agents, sodium polyphosphates and sodium chloride (common salt) are most commonly used. Of the sodium polyphosphates, tetrasodium pyrophosphate and sodium tripolyphosphate are most effective. Soda ash, technical grade 99 to 100 percent sodium carbonate, can also be used. Sodium polyphosphates generally are applied at a rate of 0.05 to 0.10 pound per square foot, and sodium chloride at a rate of 0.20 to 0.33 pound per square foot. Soda ash is applied at a rate of 0.10 to 0.20 pound per square foot. A laboratory analysis of the soil in the pond area is essential to determine which dispersing agent will be most effective and to determine the rate at which it should be applied.

Mix the dispersing agent with the surface soil and then compact it to form a blanket. Thickness of the blanket depends on the depth of water to be impounded. For water less than 10 feet deep, the compacted blanket should be at least 12 inches thick. For greater depths, the thickness should be increased at the rate of 2 inches per foot of water depth from 10 feet and above.

The soil moisture level in the area to be treated should be near the optimum level for good compaction. If the soil is too wet, postpone treatment. Polyphosphates release water from soil, and the material may become too wet to handle. If the soil is too dry, add water by sprinkling.

Clear the area to be treated of all vegetation and trash. Cover rock outcrops and other exposed areas of highly permeable material with 2 to 3 feet of fine-grained material. Thoroughly compact this material. In cavernous limestone areas, the success or failure of the seal may depend on the thickness and compaction of this initial blanket.

Apply the dispersing agent uniformly over the pond area at a rate determined by laboratory analysis. It can be applied with a seeder, drill, fertilizer spreader, or by hand broadcasting. The dispersant should be finely granular, with at least 95 percent passing a No. 30 sieve and less than 5 percent passing a No. 100 sieve.

Thoroughly mix the dispersing agent into each 6-inch layer to be treated. You can use a disk, rototiller, pulverizer, or similar equipment. Operating the mixing equipment in two directions produces best results. Thoroughly compact each chemically treated layer with four to six passes of a sheepsfoot roller.

Protect the treated blanket against puncturing by livestock. Cover the area near the high-water line with a 12- to 18-inch blanket of gravel or other suitable material to protect it against erosion. Use riprap or other suitable material in areas where inflow into the pond is concentrated.

### **Waterproof linings**

Using waterproof linings is another method of reducing excessive seepage in both coarse-grained and fine-grained soils. Polyethylene, vinyl, butyl-rubber membranes, and asphalt-sealed fabric liners are gaining wide acceptance as linings for ponds because they virtually eliminate seepage if properly installed.

Thin films of these materials are structurally weak, but if not broken or punctured they are almost completely watertight. Black polyethylene films are less expensive and have better aging properties than vinyl. Vinyl, on the other hand, is more resistant to impact damage and is readily seamed and patched with a solvent cement. Polyethylene can be joined or patched with a special cement.

All plastic membranes should have a cover of earth or earth and gravel not less than 6 inches thick to protect against punctures. Butyl-rubber membranes need not be covered except in areas traveled by livestock. In these areas a minimum 9-inch cover should be used on all types of flexible membranes. The bottom 3 inches of cover should be no coarser than silty sand.

Clear the pond area of all undesired vegetation. Fill all holes and remove roots, sharp stones, or other objects that might puncture the film. If the material is stony or of very coarse texture, cover it with a cushion layer of fine-textured material before placing the lining.

Some plants may penetrate both vinyl and polyethylene film. If nutgrass, johnsongrass, quackgrass, and other plants having high penetration are present, the subgrade, especially the side slopes, should be sterilized. Several good chemical sterilizers are available commercially. Sterilization is not required for covered butyl-rubber linings 20 to 30 mils thick.

Lay the linings in sections or strips, allowing a 6-inch overlap for seaming. Vinyl and butyl-rubber linings should be smooth, but slack. Polyethylene should have up to 10 percent slack. Be extremely careful to avoid punctures. Anchor the top of the lining by burying it in a trench dug completely around the pond at or above the normal water level. The anchor trench should be 8 to 10 inches deep and about 12 inches wide.

## Establishing vegetation

Trees, shrubs, grasses, and forbs should be planted during or soon after construction. Their functions include erosion control, screening, space definition, climate control, and wildlife habitat. The vegetation should be able to survive under prevailing conditions with minimum maintenance. Native varieties are preferred for new plantings.

In many areas the exposed surface of the dam, the auxiliary spillway, and the borrow areas as well as other disturbed surfaces can be protected from erosion by establishing a vegetative community of appropriate species. Prepare a seedbed as soon after construction as practicable. This is generally done by disking or harrowing. Fertilize and seed with mixtures of perennial grasses and forbs appropriate for local soil and climatic conditions. If construction is completed when the soils are too dry for the seeds to germinate, irrigate the soils to ensure prompt germination and continued growth. Mulching with a thin layer of straw, fodder, old hay, asphalt, or one of several commercially manufactured materials may be desirable. Mulching not only protects the newly prepared seedbed, seeds, or small plants from rainfall damage, but also conserves moisture and provides conditions favorable for germination and growth.

Soil bioengineering systems should be employed to establish woody vegetation where appropriate on the shorelines of ponds. The systems best suited to these conditions include live stakes, live fascines, brushmattresses, live siltation, and reed clumps. Additional information about these and other soil bioengineering systems is in Part 650, Engineering Field Handbook, chapters 16 and 18.

Trees and shrubs that remain or those planted along the shoreline will be subject to flooding, wave action, or a high water table. The ability to tolerate such drastic changes varies greatly among species. Flood tolerance and resistance to wave action depend on root density and the ability to regenerate from exposed roots.

A planting plan indicating the species and rate of application of the vegetation can be helpful in achiev-

ing the desired results. For information on recommended plants and grass mixtures, rates of fertilization, and mulching procedures, contact the local representatives of the Natural Resources Conservation Service or the county agent.

## Protecting the pond

Construction of the pond is not complete until you have provided protection against erosion, wave action, trampling by livestock, and any other source of damage. Ponds without this protection may be short lived, and the cost of maintenance is usually high.

Leave borrow pits in condition to be planted so that the land can be used for grazing or some other purpose. Grade and shape the banks or side slopes of borrow pits to a slope that permits easy mowing, preferably no steeper than 4:1, and allows the graded area to blend with the landscape. It is often desirable to establish vegetation to make the borrow area compatible with undisturbed surroundings.

Grade all areas or pits from which borrow material has been obtained so they are well drained and do not permit stagnant water to accumulate as breeding places for mosquitoes.

## Wave action

Several methods are available to protect the upstream face of a dam against wave action. The choice of method depends on whether the normal pool level remains fairly constant or fluctuates. An irrigation pond is an example of the latter. In these ponds, water is withdrawn periodically during the growing season and the water level may fluctuate from normal pool level to near pond bottom one or more times each year. The degree of protection required also influences the choice of method.

**Berms**—If the water level in the pond is expected to remain fairly constant, a berm 6 to 10 feet wide located at normal pool level generally provides adequate protection against wave action. The berm should have a downward slope of about 6 to 12 inches toward the pond. The slope above the berm should be protected by vegetation.



**Booms**—Log booms also break up wave action. A boom consists of a single or double line of logs chained or cabled together and anchored to each end of the dam. Tie the logs end to end as close together as practicable. Leave enough slack in the line to allow the boom to adjust to fluctuating water levels. If you use double rows of logs, frame them together to act as a unit. For best results place the boom so that it floats about 6 feet upstream from the face of the dam. If the dam is built on a curve, you may need anchor posts on the face of the dam as well as at the ends to keep the boom from riding on the slope. Booms do not give as much protection as some other methods described, but they are inexpensive if timber is readily available. They generally are satisfactory for small structures.

**Riprap**—Rock riprap is an effective method of control if a high degree of protection is required or if the water level fluctuates widely. Riprap should extend from the top of the dam down the upstream face to a level at least 3 feet below the lowest anticipated water level. Riprap is dumped directly from trucks or other vehicles or is placed by hand. Hand placing gives more effective protection and requires less stone. Dumping requires more stone, but less labor. The layer of stones should be at least 12 inches thick and must be placed on a bed of gravel or crushed stone at least 10 inches thick. This bed keeps the waves from washing out the underlying embankment material that supports the riprap.

If riprap is not continuous to the upstream toe, provide a berm on the upstream face to support the layer of riprap and to keep it from sliding downslope. If possible, use stones whose color is similar to that in the immediate area. Allow grass and herbs to grow through the riprap to blend with surrounding vegetation, but control woody vegetation.

## Livestock

Complete fencing of areas on which embankment ponds are built is recommended if livestock are grazed or fed in adjacent fields. Fencing provides the protection needed to develop and maintain a good plant cover on the dam, the auxiliary spillway, and in other areas. It enhances clean drinking water and eliminates damage or pollution by livestock. If you fence the entire area around the pond and use the pond for watering livestock, install a gravity-fed watering trough just downstream from the dam and outside the fenced area.

Fencing also enables you to establish an environment beneficial to wildlife. The marshy vegetation needed around ponds for satisfactory wildlife food and cover does not tolerate much trampling or grazing.

Not all ponds used for watering livestock need to be fenced. On some western and midwestern ranges, the advantages derived from fencing are more than offset by the increased cost and maintenance and the fact that fewer animals can water at one time. A rancher with many widely scattered ponds and extensive holdings must have simple installations that require minimum upkeep and inspection. Fencing critical parts of livestock watering ponds, particularly the earthfill and the auxiliary spillway, is usually advantageous even if complete fencing is impractical.

---

## Operating and maintaining the pond

A pond, no matter how well planned and built, must be adequately maintained if its intended purposes are to be realized throughout its expected life. Lack of operation and maintenance has caused severe damage to many dams and spillways. Some structures have failed completely. For these reasons you must be fully aware of the need for adequate operation and maintenance, and you should carry out all measures required.

Inspect your pond periodically. Be sure to examine it after heavy rains to determine whether it is functioning properly or needs minor repairs. Repairing damage immediately generally eliminates the need for more costly repairs later. Damage may be small, but if neglected it may increase until repair becomes impractical and the entire structure must be replaced.

Fill any rills on the side slopes of the dam and any washes in the auxiliary spillway immediately with suitable material and compact it thoroughly. Fertilize as needed and reseed or resod these areas. If the upstream face of the earthfill shows signs of serious washing or sloughing because of wave action, install protective devices, such as booms or riprap. If seepage through or under the dam is evident, consult an engineer at once so that you can take proper corrective measures before serious damage occurs.

To maintain the protective plant cover on the dam and on the auxiliary spillway, mow it frequently and fertilize when needed. Mowing prevents the growth of woody plants where undesirable and helps develop a cover and root system more resistant to runoff. If the plant cover is protected by fencing, keep the fences in good repair.

Keep pipes, trash racks, outlet structures, valves, and watering troughs free of trash at all times.

In some localities burrowing animals such as badgers, gophers, beaver, and prairie dogs cause severe damage to dams or spillways. If this damage is not repaired, it may lead to failure of the dam. Using a submerged inlet or locating the inlet in deeper water discourages beavers from the pipe inlets. A heavy layer of sand or gravel on the fill discourages burrowing to some extent. Poultry netting can be used, but in time it rusts out and needs to be replaced.

Keep the water in your pond as clean and unpolluted as possible. Do not permit unnecessary trampling by livestock, particularly hogs. If fencing is not practical, pave the approaches to the pond with small rocks or gravel. Divert drainage from barn lots, feeding yards, bedding grounds, or any other source of contamination away from the pond. Clean water is especially important in ponds used for wildlife, recreation, and water supply.

In areas where surface water encourages mosquito breeding, stock the pond with topfeeding fish. Gambusia minnows are particularly effective in controlling mosquitoes. In malaria areas, do not keep any aquatic growth or shoreline vegetation and take special precautions in planning, building, and operating and maintaining the pond. Most states in malaria areas have health regulations covering these precautions. These regulations should be followed.

In some areas, algae and other forms of plant life may become objectionable. They can cause disagreeable tastes or odors, encourage bacterial development, and produce an unsightly appearance.

---

## **Pond safety**

Ponds, like any body of water, attract people so that there is always a chance of injury or drowning. You may be planning to build a pond for watering livestock, irrigation, or any of the other purposes discussed in this handbook. However, your family and friends may picnic beside the pond or use it for fishing, swimming, boating, or ice skating, and you can never tell what a small child passing by may do.

Your pond can become a source of pleasure as well as profit, but only if it is safe. You can take some of the following steps to prevent injuries or drownings and to protect yourself financially.

### **Before construction**

Almost all states have laws on impounding water and on the design, construction, and operation and maintenance of ponds. In many states small farm ponds are exempt from any such laws. You should become familiar with those that apply in your state and be sure that you and your engineer comply with them.

Find out what your community or state laws are regarding your liability in case of injury or death resulting from use of your pond, whether you authorize such use or not. This is particularly important if you intend to open your pond to the public and charge a fee for its use. You may find that you need to protect yourself with insurance.

You should decide how the water is going to be used so that you can plan the needed safety measures before construction starts. For example, if the water is to be used for swimming, guards over conduits are required. You may wish to provide for beaches and diving facilities; the latter require a minimum depth of about 10 feet of water.

### **During construction**

Your contractor should take other safety measures during pond construction. Remove all undesirable trees, stumps, and brush and all rubbish, wire, junk machinery, and fences that might be hazardous to boating and swimming. Eliminate sudden dropoffs and deep holes.

### **After completion**

Mark safe swimming areas and place warning signs at all danger points. Place lifesaving devices, such as ring buoys, ropes, planks, or long poles, at swimming areas to facilitate rescue operations should the need arise. Place long planks or ladders at ice skating areas for the same reason.