



**PDHonline Course C295 (7 PDH)**

---

# **Designing Accessible Sidewalks and Trails - Part I**

*Instructor: Vincent D. Reynolds, MBA, PE*

**2020**

**PDH Online | PDH Center**

5272 Meadow Estates Drive  
Fairfax, VA 22030-6658  
Phone: 703-988-0088  
[www.PDHonline.com](http://www.PDHonline.com)

An Approved Continuing Education Provider

# **Designing Sidewalks and Trails for Access**

## **Part I of II: Review of Existing Guidelines and Practices**

### **Program Manager:**

Barbara McMillen

### **Authors:**

*Beneficial Designs, Inc.*

Peter W. Axelson, M.S.M.E., A.T.P.

Denise A. Chesney, M.E., B.M.E.

Dorothy V. Galvan

Julie B. Kirschbaum, B.A.

Patricia E. Longmuir, M.S.C.

Camille Lyons, B.A.

Kathleen M. Wong, B.A.

### **Illustrations:**

Matthew J. Boisseau, B.S.

Clay Butler

### **Date:**

July 1999

---

## Notice:

This document is disseminated under the sponsorship of the U.S. Department of Transportation in the interest of information exchange. The United States Government assumes no liability for its contents or use thereof.

The contents of this report reflect the views of the contractor, who is responsible for the accuracy of the data presented herein. The contents do not necessarily reflect the official policy of the Department of Transportation.

This report does not constitute a standard, specification, or regulation. The United States Government does not endorse products or manufacturers. Trade or manufacturers' names appear herein only because they are considered essential to the object of this document.

---

**Designing Sidewalks  
and Trails for Access**  
**Part I of II:  
Review of Existing  
Guidelines and Practices**

**Acknowledgement:** *Julie Kirschbaum was the project coordinator for this report, and for the last two years, has focused on the development of this document.*

# Table of Contents

<i>List of Figures</i> .....	v
<i>List of Tables</i> .....	ix
<i>Introduction</i> .....	xi
<b>1. Disability Rights Legislation and Accessibility Guidelines and Standards in the United States</b> .....	<b>1</b>
1.1 Accessibility Legislation and Access Design Standards Prior to the ADA .....	1
1.1.1 American National Standards Institute (ANSI) A117.1 .....	1
1.1.2 The Architectural Barriers Act (ABA) .....	2
1.1.3 The Rehabilitation Act .....	3
1.2 The Americans with Disabilities Act (ADA) .....	4
1.2.1 Americans with Disabilities Act Accessibility Guidelines (ADAAG) .....	4
1.2.2 Implementing Regulations for Title II and Title III .....	5
1.2.3 ADA Regulations that Apply to Public Entities .....	6
1.2.4 ADA Regulations for Places of Public Accommodation and Commercial Facilities .....	6
1.3 Accessibility Guidelines, Requirements, and Standards for Sidewalks and Trails .....	8
1.3.1 Sidewalks .....	8
1.3.2 Trails .....	9
1.3.3 Access to Wilderness Areas .....	10
1.4 Conclusion .....	11
<b>2. Characteristics of Pedestrians</b> .....	<b>13</b>
2.1 Older Adults .....	14
2.1.1 Safety .....	14
2.1.2 Ambulation .....	15
2.1.3 Object Manipulation .....	15
2.1.4 Visual and Cognitive Processing .....	15
2.2 Children .....	15
2.3 People with Disabilities .....	16
2.3.1 People with Mobility Impairments .....	16
2.3.1.1 Wheelchair and scooter users .....	16
2.3.1.2 Walking-aid users .....	19



2.3.1.3	Prosthesis users .....	20
2.3.2	People with Sensory Impairments .....	20
2.3.2.1	People with visual impairments .....	21
2.3.2.2	People with hearing impairments .....	23
2.3.3	People with Cognitive Impairments .....	23
2.4	Conclusion .....	23
<b>3</b>	<b>Summary of the Planning Process .....</b>	<b>25</b>
3.1	Intermodal Surface Transportation Efficiency Act and Transportation Equity Act for the 21st Century .....	25
3.2	Building a Multi- and Intermodal System .....	25
3.3	Federal Transportation Funding Opportunities .....	26
3.4	Planning under Federal Transportation Legislation .....	27
3.5	Transportation Agencies .....	27
3.6	Land Management Agencies .....	28
3.7	Pedestrian/Bicycle Coordinators .....	28
3.8	Other Transportation Planning Participants .....	28
3.9	Strategies for Public Involvement .....	29
3.10	Community Impact Assessment .....	30
3.11	Conclusion .....	30
<b>4</b>	<b>Sidewalk Design Guidelines and Existing Practices .....</b>	<b>31</b>
4.1	Location Research .....	31
4.2	Design Guideline Comparisons .....	32
4.3	Access Characteristics .....	32
4.3.1	Grade .....	32
4.3.2	Cross-Slope .....	35
4.3.3	Width .....	36
4.3.4	Passing Space and Passing Space Interval .....	38
4.3.5	Vertical Clearance .....	38
4.3.6	Changes in Level .....	39
4.3.7	Grates and Gaps .....	39
4.3.8	Obstacles and Protruding Objects .....	40
4.3.9	Surface .....	41
4.4	Sidewalk Elements .....	41
4.4.1	Curb Ramps .....	41

4.4.1.1	Curb ramp components .....	42
4.4.1.2	Curb ramp specifications .....	42
4.4.1.3	Curb ramp types .....	44
4.4.1.4	Curb ramp placement .....	46
4.4.1.5	Curb ramps and people with visual impairments .....	48
4.4.2	Conveying Information to Pedestrians with Visual Impairments .....	48
4.4.2.1	Raised tactile surfaces used as detectable warnings .....	50
4.4.2.2	Raised tactile surfaces used for wayfinding .....	51
4.4.2.3	Materials with contrasting sound properties .....	52
4.4.2.4	Grooves .....	52
4.4.2.5	Contrasting colors for people with low vision .....	52
4.4.2.6	Audible and vibrotactile pedestrian signals .....	53
4.4.2.7	ADAAG requirements for detectable warnings .....	54
4.4.3	Driveway Crossings .....	55
4.4.4	Medians and Islands .....	57
4.4.5	Crosswalks .....	57
4.4.6	Crossing Times .....	59
4.4.7	Pedestrian-Actuated Traffic Controls .....	59
4.4.8	Midblock Crossings .....	60
4.4.9	Sight Distances .....	61
4.4.10	Grade-Separated Crossings .....	62
4.4.11	Roadway Design .....	63
4.4.12	Drainage .....	64
4.4.13	Building Design .....	65
4.4.14	Maintenance .....	66
4.4.15	Signs .....	68
4.5	Conclusion .....	69
<b>5.</b>	<b>Trail Design for Access .....</b>	<b>75</b>
5.1	Universal Trail-Assessment Process .....	75
5.2	Design Guideline Comparisons .....	75
5.3	Trail Types .....	76
5.4	Access Characteristics .....	77
5.4.1	Grade .....	77
5.4.2	Rest Areas .....	79

5.4.3	Cross-Slope .....	79
5.4.4	Width .....	80
5.4.5	Passing Space .....	81
5.4.6	Changes in Level .....	81
5.4.7	Vertical Clearance .....	82
5.4.8	Surface .....	82
5.4.9	Trail Information .....	83
5.4.10	Maintenance .....	84
5.5	Design Conflicts .....	85
5.5.1	Trail Elements .....	85
5.5.2	Built Facilities Along Trails .....	85
5.5.3	Designing Trail Amenities for Multiple User Groups .....	86
5.5.4	Drainage Control Measures and Access .....	86
5.5.5	Complying with Design Standards .....	87
5.5.6	Difficulty Ratings for Trails .....	87
5.6	User Conflicts .....	87
5.6.1	Experience Level .....	87
5.6.2	Expectations .....	88
5.6.3	Conflicts Among User Groups .....	88
5.6.3.1	Technology differences .....	88
5.6.3.2	Movement patterns .....	88
5.6.3.3	Perceived environmental impact .....	89
5.6.3.4	New and newly popularized sports .....	89
5.6.4	Lack of Communication Among Trail Users .....	89
5.6.5	Number of Users .....	90
5.6.6	Minimizing User Conflicts on Trails .....	90
5.7	Conclusion .....	91
<b>Appendix A: Abbreviations and Acronyms .....</b>		<b>111</b>
<b>Appendix B: Glossary .....</b>		<b>113</b>
<b>Appendix C: Bibliography .....</b>		<b>121</b>

# List of Figures

Figure 2-1: Wheelchair and scooter dimensions (in mm) (based on Architecture and Engineering for Parks Canada and Public Works and Government Services Canada, 1994). .....	17
Figure 2-2: Circle diameter of a standard manual wheelchair [ADAAG, Figure 4.3(a), U.S. Access Board, 1991]. .....	17
Figure 2-3: High and low side-reach limits (Barrier Free Environments, Inc., 1996). .....	18
Figure 2-4: Maximum side-reach over an obstruction [ADAAG, Figure 4.6(c), U.S. Access Board, 1991]. .....	18
Figure 2-5: High and low forward-reach limits (Barrier Free Environments, Inc., 1996). .....	18
Figure 2-6: Maximum forward-reach over an obstruction (PLAE, Inc., 1993). .....	19
Figure 3-1: Sources of input during the project development process (based on FHWA, 1997a). .....	29
Figure 4-1: Maximum grades can make a sidewalk difficult to traverse, even if the overall running grade is moderate. ....	33
Figure 4-2: The gutter slopes counter to the slope of the curb ramp to promote drainage. ....	33
Figure 4-3: Excessive slope differences between gutter and ramp can cause a wheelchair to tip forward. ....	34
Figure 4-4: Excessive slope differences between a gutter and a ramp can cause wheelchairs to flip over backward. ....	34
Figure 4-5: Ramps must have level landings (based on ADAAG Figure 16, U.S. Access Board, 1991). ....	35
Figure 4-6: When cross-slopes change rapidly over a short distance, wheelchair use becomes extremely unstable. ....	36
Figure 4-7: Most pedestrians prefer to travel in the center of the sidewalk. ....	37
Figure 4-8: Passing spaces should be included at intervals on narrow sidewalks to allow wheelchair users to pass one another. ....	38
Figure 4-9: Wheelchair users require 1.525 m x 1.525 m (60 in x 60 in) to maneuver in a complete circle. ....	38
Figure 4-10: Changes in level are often caused by tree roots that break through the sidewalk surface. ....	39
Figure 4-11: Vertical and beveled changes in level [ADAAG, Figure 7(c, d), U.S. Access Board, 1991]. ....	39
Figure 4-12: Wheelchair casters and cane and crutch tips can easily get caught in wide grates. ....	39

Figure 4-13: Obstacles mounted on posts should not protrude more than 0.305 m (12 in) into a circulation corridor [ADAAG, Figure 8(d), U.S. Access Board, 1991].	40
Figure 4-14: Components of a curb ramp.	42
Figure 4-15: Alternative slope profiles for alterations when an 8.33 percent slope is not achievable.	42
Figure 4-16: This wheelchair user is maneuvering successfully at a curb ramp because a level landing is provided.	43
Figure 4-17: This wheelchair user will have difficulty entering the sidewalk because the curb ramp lacks a landing.	43
Figure 4-18: This wheelchair user will have difficulty traveling around the corner because the curb ramp lacks a landing.	43
Figure 4-19: Flares provide a sloped transition between the ramp and the surrounding sidewalk and are designed to prevent ambulatory pedestrians from tripping.	44
Figure 4-20: Returned curbs may be used when the curb ramp is located outside the pedestrian walkway, such as in a planting strip.	44
Figure 4-21: Without level landings, perpendicular curb ramps are problematic for wheelchair users and others to travel across.	44
Figure 4-22: Two perpendicular curb ramps with level landings maximize access for pedestrians at intersections.	45
Figure 4-23: If diagonal curb ramps are installed, a 1.220-m (48-in) clear space should be provided to allow wheelchair users enough room to maneuver into the crosswalk.	45
Figure 4-24: Parallel curb ramps work well on narrow sidewalks but require users continuing on the pathway to negotiate two ramp grades.	46
Figure 4-25: A combination curb ramp is a creative way to avoid steep curb ramps and still provide level landings.	46
Figure 4-26: Built-up curb ramp with drainage inlets.	46
Figure 4-27: Built-up curb ramp with a drainage pipe.	46
Figure 4-28: To avoid having to negotiate changing grades and changing cross-slope simultaneously, a wheelchair user has to turn at the grade transition.	47
Figure 4-29: Curb ramps designed with the ramp perpendicular to the curb eliminate rapidly changing grades and cross-slopes at the grade transition.	48
Figure 4-30: Truncated domes are an effective way of indicating a drop-off at transit platform.	50
Figure 4-31: Colored stone sidewalks with concrete curb ramps have a detectable color change.	52
Figure 4-32: Driveway crossings without landings confront wheelchair users with severe and rapidly changing cross-slopes at the driveway flare.	55

Figure 4-33: When sidewalks have a planter strip, the ramp of the driveway does not interfere with a pedestrian's path of travel. ....	55
Figure 4-34: On wide sidewalks, there is enough room to provide a ramp for drivers and retain a level landing for pedestrians. ....	56
Figure 4-35: Jogging the sidewalk back from the street provides a level landing for pedestrians on narrow sidewalks. ....	56
Figure 4-36: Although parallel driveway crossings provide users with level landings, users continuing on the sidewalk are forced to negotiate two ramps. ....	56
Figure 4-37: Inaccessible sidewalk caused by many individual parking lots. ....	56
Figure 4-38: Improved accessibility created by combining parking lots and reducing the number of entrances and exits. ....	56
Figure 4-39: Cut-through corner island and center median (based on OR DOT, 1995). ....	57
Figure 4-40: Ramped corner island and cut-through median (based on OR DOT, 1995). ....	57
Figure 4-41: Two horizontal lines are the most common crosswalk markings. ....	58
Figure 4-42: A ladder design was found to be the most visible type of pedestrian crosswalk marking. ....	58
Figure 4-43: Diagonal markings enhance visibility. ....	58
Figure 4-44: A large, easy-to-press button makes pedestrian-actuated traffic controls more usable for people with limited hand strength and dexterity. ....	60
Figure 4-45: Curb extensions at midblock crossings help reduce crossing distance. ....	61
Figure 4-46: Sight line obstructed by parked cars prevents drivers from seeing pedestrians starting to cross the street. ....	61
Figure 4-47: Partial curb extensions improve visibility between pedestrians and motorists. ....	62
Figure 4-48: Full curb extensions improve visibility between pedestrians and motorists. ....	62
Figure 4-49: Pedestrian and biker underpass. ....	62
Figure 4-50: When roads are not milled, layers of asphalt build up and make the crossing difficult for wheelchair users and others. ....	64
Figure 4-51: Milling roads from gutter to gutter prevents rapidly changing grades and makes intersections easier for wheelchair users to negotiate. ....	64
Figure 4-52: Stairs bridging low street elevation and high finished-floor elevation prevent wheelchair access into the building. ....	65
Figure 4-53: Steep cross-slopes bridging low street elevation and high finished-floor elevation make the sidewalk difficult for wheelchair users to travel across. ....	65

Figure 4-54: A level area at least 0.915 m (36 in) wide improves access when there is a low street elevation and high finished-floor elevation. ....	66
Figure 4-55: A higher curb provides a level pathway but might increase the slope of curb ramps if the sidewalk is narrow. ....	66
Figure 4-56: Traffic sign indicating upcoming steep grade (US DOT, 1988). ....	68
Figure 4-57: Pedestrian sign indicating upcoming steep grade. ....	68
Figure 5-1: Outdoor recreation access routes (ORARs) link accessible elements at a recreation site. ....	76
Figure 5-2: Trails often have maximum grades that are significantly steeper than typical running grades. ....	77
Figure 5-3: Well-designed switchbacks reduce the grade of a trail and make hiking easier for people with mobility disabilities. ....	78
Figure 5-4: Rest areas enhance the trail for all users. ....	79
Figure 5-5: Tree roots that break up the surface of the trail should be removed because they can cause users to trip. ....	82
Figure 5-6: The vertical clearance of a trail should depend on the designated user groups. ....	82
Figure 5-7: Soft surfaces are difficult for people with mobility impairments to negotiate and therefore should be avoided. ....	83
Figure 5-8: If a trail is accessible, the trail elements along the path also should be accessible. ....	85
Figure 5-9: Rubber waterbars are difficult for wheelchair users and bikers to push down when traveling uphill, but they are still more desirable than inflexible waterbars. ....	86
Figure 5-10: Swales can control drainage and eliminate the need for waterbars. ....	86
Figure 5-11: Separate pathways and clear signage can help reduce conflicts between users who travel at different speeds. ....	89
Figure 5-12: Trail signs can help clarify trail etiquette. ....	90

# List of Tables

Table 1-1: Developments in Disability Rights Legislation and Accessibility Guidelines from 1961 to 1998 .....	2
Table 2-1: Highest Reach for Wheelchair Users (based on Steinfeld, Schroeder, and Bishop, 1979) .....	18
Table 2-2: Eye-Level Measurements for Wheelchair Users (based on Steinfeld, Schroeder, and Bishop, 1979) .....	19
Table 4-1: Grade, Cross-Slope, and Curb Height Guidelines by Functional Class of Roadway (based on information contained in AASHTO, 1995) .....	63
Table 4-2.1: Federal Accessibility Guidelines for Accessible Routes .....	70
Table 4-2.2: ADAAG-Proposed Section 14 (1994) Accessibility Guidelines for Public Rights-of-Way .....	70
Table 4-2.3: State Guidelines for Sidewalks .....	71
Table 4-2.4: Additional Recommendations for Sidewalks .....	71
Table 4-3.1: Federal Accessibility Guidelines for Curb Ramps (CR) .....	72
Table 4-3.2: ADAAG-Proposed Section 14 (1994) Accessibility Guidelines for Curb Ramps (CR) .....	72
Table 4-3.3: State and City Guidelines for Curb Ramps (CR) .....	73
Table 4-3.4: Additional Recommendations for Curb Ramps (CR) .....	73
Table 5-1: Results of 10 Trail Assessments Show That on Many Trails, the Maximum Grade and Cross-Slope Significantly Exceed the Typical Average Grade and Cross-Slope (Chesney and Axelson, 1994) .....	77
Table 5-2: Cross-Slope Ranges by Surface Type (AASHTO, 1995) .....	80
Table 5-3: Scoping Requirements for Accessible Parking Spaces .....	85
Table 5-4.1: Federal Accessibility Guidelines for Maximum Allowable Running Slope without Landings and Handrails .....	92
Table 5-4.2: Federal Advisory Committee Recommendations for Maximum Allowable Running Grade .....	92
Table 5-4.3: Federal Guidelines for Maximum Allowable Running Grade .....	92
Table 5-4.4: State, County, and City Guidelines for Maximum Allowable Running Grade .....	93
Table 5-4.5: Additional Recommendations for Maximum Allowable Running Grade .....	94
Table 5-5.1: Federal Accessibility Guidelines for Maximum Slope for a Specified Ramp Run with Landings and Handrails .....	95
Table 5-5.2: Federal Advisory Committee Recommendations for Maximum Grade for a Specified Distance (Run) .....	95



Table 5-5.3: Federal Guidelines for Maximum Grade for a Specified Distance (Run) .....	95
Table 5-5.4: State, County, and City Guidelines for Maximum Grade for a Specified Distance (Run) .....	96
Table 5-5.5: Additional Recommendations for Maximum Grade for a Specified Distance (Run) .....	97
Table 5-6.1: Federal Accessibility Guidelines for Maximum Allowable Running Cross-Slope .....	98
Table 5-6.2: Federal Advisory Committee Recommendations for Maximum Allowable Running Cross-Slope .....	98
Table 5-6.3: Federal Guidelines for Maximum Allowable Running Cross-Slope .....	98
Table 5-6.4: State, County, and City Guidelines for Maximum Allowable Running Cross-Slope .....	99
Table 5-6.5: Additional Recommendations for Maximum Allowable Running Cross-Slope .....	100
Table 5-7.1: Federal Accessibility Guidelines for Minimum Clearance Width .....	101
Table 5-7.2: Federal Advisory Committee Recommendations for Minimum Clearance Width .....	101
Table 5-7.3: Federal Guidelines for Minimum Clearance Width.....	101
Table 5-7.4: State, County, and City Guidelines for Minimum Clearance Width .....	102
Table 5-7.5: Additional Recommendations for Minimum Clearance Width .....	103
Table 5-8.1: Federal Accessibility Guidelines for Vertical Changes in Level .....	104
Table 5-8.2: Federal Advisory Committee Recommendations for Vertical Changes in Level.....	104
Table 5-8.3: Federal Guidelines for Vertical Changes in Level .....	104
Table 5-8.4: State, County, and City Guidelines for Vertical Changes in Level .....	105
Table 5-8.5: Additional Recommendations for Vertical Changes in Level .....	106
Table 5-9.1: Federal Accessibility Guidelines for Vertical Clearance (Head Room) .....	107
Table 5-9.2: Federal Advisory Committee Recommendations for Vertical Clearance .....	107
Table 5-9.3: Federal Guidelines for Vertical Clearance .....	107
Table 5-9.4: State, County, and City Guidelines for Vertical Clearance .....	108
Table 5-9.5: Additional Recommendations for Vertical Clearance .....	109

# Introduction

Sidewalks and trails serve as critical links in the transportation network by providing pedestrian access to commercial districts, schools, businesses, government offices, and recreation areas. Because sidewalks and trails provide such fundamental services to the public, they should be designed to meet the needs of the widest possible range of users.

Accessible sidewalks and trails enrich a community's quality of life on many levels. People with disabilities are better able to participate in the community if accessible facilities are available because it is easier for them to reach their desired destinations. Accessible sidewalk and trail networks are cost-effective because they promote independence for people with disabilities and reduce the need for social services in many cases. Commercial districts with accessible facilities have a customer base that includes people with disabilities. People with temporary disabilities such as broken legs also will be able to continue their daily functions with less inconvenience.

More accessible sidewalks and trails also mean better pedestrian facilities for everyone. Sidewalks and trails with curb ramps and benches invite strolling and shopping. Neighborhoods with well-designed pedestrian facilities are generally safer because more people are out walking in the community. In addition, a broader range of consumer, social, and recreational opportunities is available in areas catering to pedestrians.

Unfortunately, many sidewalks and trails do not adequately meet the needs of people with disabilities, who make up nearly one-fifth of the American population (U.S. Census Bureau, 1994). People with disabilities who live in areas without accessible facilities and do not have access to automobiles face a greater

risk of becoming isolated from the community and unnecessarily dependent upon others to perform errands such as grocery shopping.

The Americans with Disabilities Act (ADA) of 1990 is a civil rights law that identifies and prohibits discrimination on the basis of disability. The ADA prohibits public entities from designing new facilities or altering existing facilities, including sidewalks and trails, that are not accessible to people with disabilities. Although the current ADA Accessibility Guidelines (ADAAG) do not specifically address sidewalk and trail design, the guidelines do contain provisions that are applicable to sidewalks and trails. To best serve people with disabilities and meet the legal obligations of the ADA, designers should follow the applicable guidelines in ADAAG whenever possible.

In an effort to determine when ADAAG provisions apply to sidewalks and trails, and to bridge the remaining gaps, the Federal Highway Administration sponsored a project to research existing conditions on sidewalks and trails for people with disabilities. As part of Phase I of this project, an extensive literature review was conducted, and existing guidelines and recommendations for developing sidewalks and trails were compiled and analyzed. In addition, site visits were made to many towns and cities across the United States. The locations included areas known for providing excellent accommodations for people with disabilities, as well as locations with less accessible facilities. Quantitative measurements of sidewalk and trail characteristics that affect accessibility were taken at the sites. Experts also were interviewed to obtain the most current information on sidewalk and trail access as it relates to people with disabilities.

This report presents the findings of the Phase I study. A number of factors that affect the accessibility of sidewalks and trails in the United States are presented. The history of accessibility legislation and an overview of current accessibility laws are provided as a social backdrop to the study. The travel characteristics of people with disabilities, children, and older adults are analyzed in relation to their use of sidewalks and trails. The effects of current legislation pertaining to sidewalk and trail project planning and funding are reviewed. Current design practices used in the design of sidewalks and trails are described and analyzed in terms of accessibility, engineering, and construction.

Definitions for most of the terms in this report can be found in Appendix B. For the purposes of this report, *path or pathway* may refer to either a sidewalk or a trail. A *sidewalk* is defined in this report as the portion of a highway, road, or street intended for pedestrians. A *trail* is defined

as a path of travel for recreation and/or transportation within a park, natural environment, or designated corridor that is not classified as a highway, road, or street. A *shared-use path* is defined as a trail permitting more than one type of user, such as a trail specifying both pedestrians and bicyclists as designated users. An equestrian-only trail would not be considered a shared-use path.

Part II of this project, a guidebook, will produce a manual recommending accessible designs for sidewalk and trail facilities. Guidebook recommendations will draw upon information gathered for this report and will provide specific practices that can improve the accessibility of outdoor pathways. General principles of accessible design, accessibility requirements, facility design suggestions, and other considerations will be discussed. Sufficient detail will be included to allow planners and designers to improve the accessibility of sidewalks and trails in their communities.

# Disability Rights Legislation and Accessibility Guidelines and Standards in the United States

The Americans with Disabilities Act of 1990 (ADA) is a landmark civil rights law that both identifies and prohibits discrimination on the basis of disability. The Act prohibits discrimination in employment, telecommunications, transportation, access to facilities and programs provided by State and local government entities, and access to the goods and services provided by places of public accommodation such as lodging, health, and recreation facilities. People who design and construct buildings and facilities are responsible under the ADA to make them accessible to and usable by people with disabilities.

## 1.1 Accessibility Legislation and Access Design Standards Prior to the ADA

Although the ADA is the most comprehensive Federal law protecting the rights of people with disabilities, several important pieces of legislation and accessible design standards helped pave the way for passage of the ADA. Major milestones in the evolution of accessibility regulations are listed in Table 1-1.

### 1.1.1 American National Standards Institute (ANSI) A117.1

In 1959, the President's Committee on Employment of the Physically Handicapped and the National Society for Crippled Children co-sponsored the development of ANSI A117.1, the first national standard for accessibility (PLAE, Inc., 1993). ANSI standards are developed through a consensus process involving all directly and materially affected interests. Compliance with ANSI Standards is voluntary (ANSI A117.1, Council of American Building Officials, 1992).

The technical provisions of ANSI A117.1 are intended for "the design and construction of new buildings and facilities," as well as the "remodeling, alteration, and rehabilitation of existing conditions" (ANSI A117.1, Council of American Building Officials, 1992). Technical provisions delineate how features should be designed and installed. Technical information in ANSI A117.1 is largely based on anthropometric, ergonomic, and human performance data. ANSI A117.1 does not include scoping provisions, which describe where accessibility is appropriate; when it is required; and what features of a building, facility, or site must be accessible.

ANSI A117.1 was first published in 1961 and reaffirmed without changes in 1971. A completely new and more comprehensive version of ANSI A117.1 was published in 1980. Later editions were published in 1986, 1992, and 1998.

Although ANSI A117.1 is a voluntary standard, it has been adopted as an enforceable code by many State and local agencies that regulate the design and construction of built facilities. The technical requirements in ANSI A117.1 are also referenced in the model building codes established by regional organizations such as the following:

- Building Officials and Code Administrators International (BOCA)
- International Conference of Building Officials (ICBO)
- Southern Building Code Congress International (SBCCI)

Agencies and organizations that reference ANSI A117.1 must establish scoping specifications because the ANSI guidelines

contain only technical requirements. ANSI A117.1 has served as the basis for most of the accessibility standards subsequently adopted by Federal and State governments.

### **1.1.2 The Architectural Barriers Act (ABA)**

Congress passed the Vocational Rehabilitation Amendment Act of 1965 to encourage public facilities to comply with ANSI A117.1. The Act established the National Commission on Architectural Barriers to Rehabilitation of the Handicapped to study how and to what extent architectural barriers impeded access to or use of facilities in buildings, and what, if anything, was being done to eliminate barriers. The Commission concluded that the public was largely ignorant of disability access problems and that little was being done to provide access (PLAE, Inc., 1993).

Recognizing the ineffectiveness of voluntary compliance, Congress passed the Architectural Barriers Act (ABA) in 1968. The ABA requires that buildings and facilities designed, constructed, or altered with Federal funds, or leased by a Federal agency, must comply with standards for physical accessibility. The ABA signaled the first time physical access to buildings was required by Federal law.

The ABA required the U.S. Department of Defense (DoD), the U.S. Department of Housing and Urban Development, the U.S. General Services Administration, and the U.S. Postal Service to develop accessibility standards for all buildings and facilities covered by the ABA. Initially, ANSI A117.1 1961/71 was referenced as the accessibility standard, until 1984, when the four agencies published the Uniform Federal Accessibility Standards (UFAS).

---

**Table 1-1:**

***Developments in Disability Rights Legislation and Accessibility Guidelines from 1961 to 1998***

1961	ANSI publishes ANSI A117.1, Making Buildings Accessible to and Usable by the Physically Handicapped.
1965	Congress passes the Vocational Rehabilitation Amendment Act (P.L. 89-333).
1968	Congress passes the Architectural Barriers Act (ABA) (P.L. 90-480).
1973	Congress passes the Rehabilitation Act (P.L. 93-112).
1978	Sections 502 and 504 of the Rehabilitation Act of 1973 (P.L. 93-112) are amended.
1980	ANSI publishes a revised version of ANSI A117.1, designated ANSI A117.1-1980.
1982	U.S. Access Board publishes Minimum Guidelines and Requirements for Accessible Design (MGRAD).
1984	Federal ABA rule-making agencies publish Uniform Federal Accessibility Standard (UFAS).
1986	ANSI publishes revised version of ANSI A117.1, designated ANSI A117.1-1986.
1988	Congress passes the Fair Housing Amendments Act (P.L. 100-430).
1990	Congress passes the Americans with Disabilities Act (P.L. 101-336).
1991	U.S. Access Board publishes Americans with Disabilities Act Accessibility Guidelines for Buildings and Facilities (ADAAG).
1991	U.S. Departments of Justice and Transportation publish the ADA Standards for Accessible Design.
1992	ANSI publishes a revised version of ANSI A117.1, designated CABO/ANSI A117.1-1992.
1995	Congress passes the Congressional Accountability Act.
1998	ANSI publishes a revised version of ANSI A117.1, designated CABO/ANSI A117.1-1998.
1998	Congress reauthorizes the Rehabilitation Act.

---

### 1.1.3 The Rehabilitation Act

The drive to achieve access for people with disabilities gained momentum with the passage of the Rehabilitation Act in 1973. The Act signaled a profound shift in Federal public policy for people with disabilities. It requires nondiscrimination in the employment practices of Federal agencies of the executive branch (Section 501) and Federal contractors (Section 503). In addition, it requires all federally assisted programs, services, and activities to be available to people with disabilities (Section 504).

The Rehabilitation Act recognized that unemployment, lack of education, and poverty were not inevitable consequences of physical limitation. The Act identified societal prejudices and the inaccessibility of the environment as the sources of many of these problems. In addition, for the first time, people with disabilities were considered a unified group rather than a collection of different groups separated by diagnosis. The Act recognized that people with disabilities, as a group, face similar discrimination in employment, education, and access to society, and as such, constitute a legitimate minority group deserving basic civil rights protection (Golden, Kilb, and Mayerson, 1993).

Section 504 of the Rehabilitation Act introduced the concept of program access to federally conducted programs by prohibiting discrimination in any program, service, or activity of the Federal government. Program access allows “recipients to make their federally assisted programs and activities available to individuals with disabilities without extensive retrofitting of their existing buildings and facilities, by offering those programs through alternative methods” (US DOJ, 1994b). There are many ways to achieve program access. For example, if a private interview is to be conducted on the third floor, a first-floor interview would be acceptable if a comparable level of privacy could be obtained. Structural

modifications are required only for program access if there is no other feasible way to make a program accessible (*ibid.*). The requirement for program access reappears in Title II of the ADA (see Section 1.2.3).

Each Federal agency applies a unique set of Section 504 regulations to its own programs. Agencies that provide Federal financial assistance also have Section 504 regulations covering entities that receive Federal aid. Requirements common to these regulations include reasonable accommodation for employees with disabilities, program accessibility, effective communication with individuals who have disabilities, and accessible new construction and alterations. Each agency enforces its own regulations. Section 504, as it applies to entities that receive Federal assistance, also may be enforced through private lawsuits.

Section 502 of the Rehabilitation Act established the U.S. Architectural and Transportation Barriers Compliance Board (U.S. Access Board or U.S. ATBCB) as an independent regulatory agency with authority to enforce the ABA. In addition to its enforcement role, the U.S. Access Board developed the guidelines that formed the Uniform Federal Accessibility Standards (UFAS) and works with the four Federal agencies that set accessibility standards under the ABA.

In 1982, the U.S. Access Board published the *Minimum Guidelines and Requirements for Accessible Design* (MGRAD). The technical specifications of MGRAD were largely based on ANSI A117-1980. Scoping specifications were derived from State accessibility codes, U.S. Access Board research, public comment, and existing Federal agency standards. The four Federal agencies charged with developing accessibility standards for the ABA used the specifications in MGRAD to develop UFAS. All Federal agencies also have designated UFAS as the accessibility

standard for new construction and alterations under Section 504 of the Rehabilitation Act.

## 1.2 The Americans with Disabilities Act (ADA)

Passage of the Americans with Disabilities Act in 1990 gave civil rights protection to individuals with disabilities. The ADA defines an individual with a disability (ADA, 1990) as a person who

1. has a physical or mental impairment that substantially limits one or more major life activities,
2. has a record of such an impairment, or
3. is regarded by others as having such an impairment.

The ADA is divided into the following five titles, which prohibit discrimination on the basis of disability:

- Title I Employment
- Title II Public Services
- Title III Public Accommodations and Commercial Facilities
- Title IV Telecommunications
- Title V Miscellaneous

In 1995, Congress passed the Congressional Accountability Act, which extended the rights and protections of 11 employment and labor laws, including the ADA, to the legislative branch of the Federal government. The executive branch of the Federal government is not covered by the ADA but must comply with the Architectural Barriers Act and the Rehabilitation Act and must meet UFAS requirements.

### 1.2.1 Americans with Disabilities Act Accessibility Guidelines (ADAAG)

Title V of the ADA requires the U.S. Access Board to issue minimum guidelines for accessible design to ensure that

buildings, facilities, rail passenger cars, and vehicles are accessible in terms of architecture and design, transportation, and communication to individuals with disabilities (ADA, 1990, Section 504). The U.S. Department of Justice (US DOJ) and the U.S. Department of Transportation (US DOT) use the U.S. Access Board guidelines as a basis to establish accessibility standards. Although the DOJ and DOT may create standards that exceed the recommendations published by the U.S. Access Board, they must be consistent with the minimum guidelines. The DOJ and DOT standards are enforceable under the ADA; however, the U.S. Access Board guidelines are only advisory.

Sections 1–10 of ADAAG were completed by the U.S. Access Board in 1991 and were concurrently published by the DOJ and DOT as the ADA Standards for Accessible Design. The ADA Standards for Accessible Design are identical in content to ADAAG Sections 1–10; however, the ADA Standards for Accessible Design are enforceable under the ADA.

ADAAG is based on specifications established in UFAS and ANSI A117.1-1980 and -1986. In 1998, the U.S. Access Board published final guidelines for Section 11: *Judicial, Regulatory, and Legislative Facilities* and Section 12: *Detention and Correctional Facilities*. Section 13: *Accessible Residential Housing*, and Section 14: *Public Rights-of-Way*, which had been published previously as interim guidelines, were withdrawn and reserved for future rulemaking. To date, the DOJ or the DOT has not developed standards based on Sections 11 and 12.

ADAAG and UFAS provide specific information on dimensions and details for new construction and alterations. The specifications of ADAAG and UFAS establish minimum levels of accessibility. Architects and building owners may

choose to design alternative but equally accessible facilities. However, if an alternative design is used, it must provide a level of access equivalent to the requirements in the ADA Standards for Accessible Design or UFAS.

In addition to the Federal standards, almost all States have adopted accessibility guidelines as part of their building codes. Although States may adopt and enforce standards that are more stringent than Federal standards, covered entities must comply with Federal minimum standards. State and local governments may apply to the DOJ Assistant Attorney General for Civil Rights to certify that a State or local building code meets or exceeds the ADA's minimum requirements.

### **1.2.2 Implementing Regulations for Title II and Title III**

Title II, Subpart A, and Title III of the ADA are implemented by the DOJ in the Code of Federal Regulations (CFR). Title II, Subpart B is implemented by the DOT. The DOJ implementing regulations for Titles II and III of the ADA are in CFR Title 28, Parts 35 and 36, respectively. The DOT implementing regulations for Title II, Subpart B, are published in CFR 49, Part 37.

The DOJ regulations for Titles II and III are very similar in their general requirements. The DOJ developed technical assistance manuals for Titles II and III to help public and private entities comply with the ADA implementation regulations. The information line of the Disability Rights Section of the DOJ may be contacted at (800) 514-0301 (V) or (800) 514-0383 (TTY), or on the Internet at [www.usdoj.gov/crt/ada/adahom1.htm](http://www.usdoj.gov/crt/ada/adahom1.htm).

Both Titles II and III prohibit exclusion of people with disabilities from services, programs, and activities. Both titles also stipulate that the equal participation of individuals with disabilities in the

mainstream of society is a primary goal. Therefore, to prevent segregation, entities covered by Titles II and III must make every effort to integrate people with disabilities to the maximum extent possible. The type of program provided must be appropriate to the needs of the particular individual. For example, an appropriate program for a hearing wheelchair user could include a videotape of a tour through the upper floors of a historic house museum that could not be made physically accessible. However, a program providing sign-language interpretation for a hearing wheelchair user would not be appropriate. Individuals with disabilities are not required to use separate services, even if a qualified separate program exists (US DOJ, 1993b; US DOJ, 1993c).

State and local governments and places of public accommodation are required to make reasonable modifications to their policies, practices, and procedures to avoid discriminating against people with disabilities. Reasonable modifications might include permitting service animals into food establishments, even if other animals are not allowed or granting a variance to a zoning requirement so a business may encroach on the sidewalk to install a storefront ramp (US DOJ, 1993b; US DOJ, 1993c).

Exceptions in both titles are made for historic sites or programs for which providing physical access would “threaten or destroy the historic significance” (ADA, 1990). In such cases, architectural access should be provided to the maximum extent possible, even if full compliance with the ADA standards cannot be met. Examples of partial compliance include providing a steeper-than-average ramp or ground-floor-only access. In situations where no architectural modifications are possible, auxiliary aids such as films, models, or activities representative of the inaccessible area must be provided (US DOJ, 1993b; US DOJ, 1993c).



### **1.2.3 ADA Regulations that Apply to Public Entities**

Title II, Subpart A of the ADA prohibits State and local governments (public entities) from discriminating against people with disabilities in all programs, services, and activities. Title II, Subpart B prohibits discrimination against people with disabilities in public transportation provided by public entities (private transportation is covered in Title III).

Similar to Section 504 of the Rehabilitation Act, Title II requires public entities to provide people with disabilities with program access in existing facilities. Program access for people with mobility disabilities may be achieved by relocating a program to an accessible building or changing the way a service is delivered. Structural modifications are required only if there is no other feasible way to make a program accessible (US DOJ, 1994b). Effective communication for people who have hearing, vision, or speech disabilities can be achieved by providing appropriate means of communication. The requirements for program access are published in the DOJ and DOT regulations.

New construction is held to the highest standard of accessibility because the cost of including accessibility is minimal compared to the overall cost of construction. The current implementing regulations for Title II allow public entities the flexibility to use either UFAS or the ADA Standards for Accessible Design for new construction and alterations. Once a standard has been chosen, it must be followed completely for a given facility or project in both new construction and subsequent alterations (US DOJ, 1993b).

If a public entity follows the ADA Standards for Accessible Design, alterations and new additions must meet the minimum specifications for new construction unless it is “technically infeasible” to do so. An improvement is technically infeasible only

if “existing structural conditions would require removing or altering a load-bearing member which is an essential part of the structural frame; or because other existing physical or site constraints prohibit modification or addition of elements, spaces, or features which are in full and strict compliance with the minimum requirements for new construction and which are necessary to provide accessibility” (US DOJ, 1991). According to UFAS, alterations and new additions must meet the minimum specifications for new construction unless it is “structurally impracticable” to do so (UFAS, U.S. DoD et al., 1984). Structurally impracticability is defined in UFAS as “changes having little likelihood of being accomplished without removing or altering a load-bearing structural member and/or incurring an increased cost of 50 percent or more of the value of the element of the building or facility involved” (UFAS, U.S. DoD et al., 1984). Special technical provisions may be applied where constraints prohibit full compliance with new construction standards. However, this decision must be made carefully, and the accessibility standards must be met to the maximum extent feasible.

New construction or alteration work commenced after January 26, 1992, must meet the requirements outlined in the ADA Standards for Accessible Design or UFAS.

### **1.2.4 ADA Regulations for Places of Public Accommodation and Commercial Facilities**

Title III prohibits discrimination on the basis of disability in places of public accommodation and in commercial facilities. Places of public accommodation are facilities operated by private entities that fall within the following 12 broad categories defined by Congress [ADA, Section 301(7), 1990]:

1. Places of lodging
2. Establishments serving food or drink

3. Places of exhibition or entertainment
4. Places of public gathering
5. Sales or rental establishments
6. Service establishments
7. Stations used for specified public transportation
8. Places of public display or collection
9. Places of recreation
10. Places of education
11. Social service center establishments
12. Places of exercise or recreation

Private entities who own, lease, lease to, and/or operate places of public accommodation are responsible for compliance with all Title III requirements.

Title III of the ADA requires that new or altered places of public accommodation be “readily accessible to and usable by” people with disabilities [ADA, 1990, Section 303(2)]. Places of public accommodation are required to provide auxiliary aids, such as interpreters for people who are deaf. Places of public accommodation are also required to remove architectural barriers in existing facilities where it is readily achievable to do so. Readily achievable is defined by the ADA as “easily accomplishable and able to be carried out without much difficulty or expense” (US DOJ, 1991). Architectural barriers include elements such as steps, doorways that are very narrow, deep pile carpeting on floors, and objects positioned in a manner that impedes access. Modifications that may be considered readily achievable include installing ramps, restriping parking lots, placing Braille in elevators, repositioning shelves, rearranging furniture, and other actions. Rearranging furniture or equipment to provide access is not considered readily achievable if it results

in a significant loss of selling or serving space. If architectural modifications are made to meet barrier-removal requirements, the ADA Standards for Accessible Design should be used as a guide. However, when it is not readily achievable to install architectural improvements that comply with the ADA Standards, alternative designs that increase access but do not meet all the specifications are acceptable.

If barrier removal is not readily achievable, a public accommodation must make goods, services, facilities, privileges, advantages, or accommodations available through alternative measures, if those measures are readily achievable. Alternative measures include providing curb service or home delivery, retrieving merchandise from inaccessible areas, or relocating activities to accessible locations (US DOJ, 1991).

Barrier removal is an ongoing obligation. However, places of public accommodation may not be required to complete access improvements to all their facilities immediately. The DOJ implementing regulations for Title III strongly recommend that places of public accommodation comply with barrier-removal requirements according to the following priorities (US DOJ, 1991):

1. Access to a place of public accommodation from public sidewalks, parking, or public transportation
2. Access to those areas of a place of public accommodation where goods and services are made available to the public
3. Access to and usability of restroom facilities
4. Any other measures necessary to provide access to the goods, services, facilities, privileges, advantages, or accommodations of a place of public accommodation

Commercial facilities (US DOJ, 1991) are facilities operated by private entities

1. whose operations will affect commerce;
2. that are intended for nonresidential use by a private entity; and
3. that are not
  - i. facilities that are covered or expressly exempted from coverage under the Fair Housing Act of 1968, as amended (42 U.S.C. 3601–3631);
  - ii. aircraft; or
  - iii. railroad locomotives, railroad freight cars, railroad cabooses, commuter or intercity passenger rail cars.

Examples of commercial facilities include factories and warehouses that are not open to the public. Commercial facilities do not have to make auxiliary aids available, nor are they obligated to meet barrier-removal requirements.

Both places of public accommodation and commercial facilities must comply with the ADA Standards for Accessible Design for new construction and alterations. New construction must be in full compliance with the requirements specified in the ADA Standards for Accessible Design unless compliance would be structurally impracticable. Full compliance is considered “structurally impracticable only in those rare circumstances when the unique characteristics of terrain prevent the incorporation of accessible features” (US DOJ, 1991).

Alterations must be readily accessible to and usable by individuals with disabilities in accordance with the ADA Standards for Accessible Design to the maximum extent feasible. Alterations are considered to be any change to the facility that affects usability, such as renovation of walls and remodeling, but does not include normal maintenance, such as painting or electrical work, unless it affects usability. When alterations are made to an area of primary function, up to an additional 20 percent

of total spending must be allocated to make the path of travel to the altered area accessible. The path of travel includes elements such as toilets, drinking fountains, and telephones serving the altered area.

### **1.3 Accessibility Guidelines, Requirements, and Standards for Sidewalks and Trails**

It is critical for sidewalks and trails to be accessible because such paths often link individually accessible facilities. For example, a person may wish to do business with a bank in an accessible building but may be unable to use the bank’s services if he or she cannot negotiate the curbs, intersections, and other public rights-of-way required to reach the bank.

#### **1.3.1 Sidewalks**

The implementing regulations for Titles II and III of the ADA require curb ramps to be provided in all existing facilities and for new construction and alterations. The implementing regulations also require public entities that have responsibility for or authority over streets, roads, sidewalks, and/or other areas meant for pedestrian use to develop a transition plan within 6 months of January 26, 1992 (by July 26, 1992). Structural changes identified in the transition plan were to be completed within 3 years of the transition plan (by January 26, 1995) (US DOJ, 1994b). A transition plan should include an assessment of the existing sidewalks requiring access improvements and present a schedule for curb ramp installations where an existing pedestrian walkway crosses a curb or other barrier.

The DOJ Title II implementing regulations [28 CFR Section 35.105(d)(2), US DOJ, 1994b] require State and local government entities to prioritize the installation of curb ramps on walkways serving

1. State and local government offices and facilities;
2. Transportation;
3. Places of public accommodation (private-sector facilities covered by Title III); and
4. Places of employment.

With the exception of the curb ramp requirement, accessibility standards specifically applicable to public sidewalks have not yet been developed by the DOJ. In 1994, the U.S. Access Board published four additional sections of ADAAG, including proposed public right-of-way guidelines (Section 14) now reserved. The proposed 1994 guidelines were circulated for a public review period, during which the U.S. Access Board received some negative feedback relating to specific sections of the document. Based on the comments received, the U.S. Access Board decided to withdraw the guidelines and focus on a public awareness campaign for the transportation industry. Section 14 was reserved to allow the possibility of developing accessibility guidelines for public sidewalks in the future. Although Section 14 was withdrawn, it was reviewed for this report because it made an impact on the transportation industry and because it is still being used by many State and local transportation agencies.

Despite the current lack of enforceable standards for public sidewalks and trails, public and private entities who design and construct sidewalks and trails are still obligated under the ADA to make them accessible to and usable by people with disabilities. In the absence of accessibility guidelines for public sidewalks and trails, planners, designers, and builders should adhere to appropriate sections of the ADA Standards for Accessible Design or UFAS and applicable State and local accessibility provisions. The ADA Standards for Accessible Design contain many sections that are potentially applicable to elements found in sidewalks. For example, Section 4.7 of the ADA Standards provides design specifications for curb ramps on accessible

routes. Some State and local governments have expanded the ADA Standards for Accessible Design to develop their own accessibility standards for sidewalks.

If a sidewalk is significantly altered, accessibility improvements must be made. However, there has been extensive debate about whether modifying a street triggers the same requirement to make accessibility improvements to the sidewalk. Altered or new facilities must be readily accessible and usable by individuals with disabilities. Under the ADA, modifications that affect usability are considered alterations. In *Kinney v. Yerusalim*, a Federal district appeals court ruled that if the depth of the resurfacing overlay is at least 38 mm (1.5 in), the usability of a street is affected. The court further ruled that because a street and its curbs are interdependent facilities, alteration of a street triggers the installation of curb ramps (U.S. District Court, Eastern District of Pennsylvania, 1993). According to the DOJ Technical Assistance Manual, “resurfacing beyond normal maintenance” is an alteration; construction limited in scope to a spot repair, such as patching potholes, is considered maintenance and does not trigger additional access retrofit requirements (US DOJ, 1993c).

### 1.3.2 Trails

Outdoor trail facilities should be accessible to the full range of potential users to ensure that people with disabilities will have access to the same recreational experiences available to those without disabilities. The U.S. Access Board established the Recreation Access Federal Advisory Committee in 1993 to examine accessibility in outdoor facilities. The Committee published its recommendations in 1994. The report divided outdoor recreation into six categories:

- Sports facilities
- Amusement areas
- Play settings

- Golf
- Boating and fishing facilities
- Developed outdoor recreation facilities

Access recommendations for these categories are being addressed by the U.S. Access Board in different ways. Methods for making play settings and outdoor developed areas accessible are being addressed by regulatory negotiation committees. The two committees are composed of experts and interested parties and are working toward consensus guidelines for these areas. The play settings committee has completed and forwarded its recommendations to the U.S. Access Board. The U.S. Access Board published a national public rulemaking for access to play areas in April 1998 to seek public comment on the play areas document. A public hearing was held in Denver, Colorado, to receive additional feedback during the comment period. The outdoor developed areas committee continues to meet and is scheduled to submit recommendations to the U.S. Access Board by September 1999.

Even though the DOJ has not adopted specific standards, recreation areas are covered by the ADA. For new construction and alterations, recreation area managers should apply applicable sections of the ADA Standards for Accessible Design or UFAS, as well as any appropriate State or local accessibility provisions. Public entities responsible for recreation areas also must provide program access to existing facilities and develop a written plan and schedule to implement access improvements.

### **1.3.3 Access to Wilderness Areas**

A significant number of trails in the United States are administered by the U.S. Department of Agriculture (USDA, including the U.S. Forest Service), the U.S. Department of the Interior (USDI, including the National Park Service, the Bureau of

Land Management, and the U.S. Fish and Wildlife Service), and the Army Corps of Engineers. Some lands managed by these executive-branch agencies bear an additional Wilderness Area designation. In 1964, Congress passed the Wilderness Act to ensure that certain lands would remain free of roads and other types of development and that unimproved trails would constitute the only paths of access to these areas. Such wilderness lands were identified by Congress and were designated as the National Wilderness Preservation System (NWPS).

The Wilderness Act was enacted in 1964, before the recent gains in disability rights, and makes no mention of people with disabilities. Because the Wilderness Act prohibits the use of motorized vehicles and mechanized transport within federally designated wilderness areas (Wilderness Inquiry, Inc., 1992), some people have claimed that it discriminates against the rights of persons with disabilities, especially those who use electric-powered wheelchairs or scooters.

Congress sought to clarify the issue of access for people with disabilities to wilderness areas in Title V, Section 507(c) of the ADA (ADA, 1990):

Congress reaffirms that nothing in the Wilderness Act is construed as prohibiting the use of a wheelchair in a wilderness area by an individual whose disability requires use of a wheelchair, and consistent with the Wilderness Act no agency is required to provide any form of special treatment or accommodation, or to construct any facilities or modify any conditions of lands within a wilderness area to facilitate such use.

Thus, only assistive devices such as wheelchairs or scooters suitable for indoor use are eligible to enter wilderness

areas. For example, a manual or powered wheelchair capable of traveling on off-road terrain would be permitted, while motorcycles, all-terrain vehicles (ATVs), off-highway vehicles (OHVs), and other vehicles with internal combustion engines are prohibited. Although wheelchair users are permitted to enter wilderness areas, land management agencies “are not required to construct any facilities or modify any conditions of lands within Wilderness to facilitate use by persons with disabilities” (Wilderness Inquiry, Inc., 1995). However, when modifications to protect the resource are made, land managers are encouraged to use accessible designs. For example, when a toilet is necessary to protect the resource from the impact of many visitors, land managers are “encouraged to make the toilet as accessible as possible within a primitive design” (ibid.).

## 1.4 Conclusion

The ADA was passed to prohibit discrimination against people with disabilities. Title II of the ADA requires public entities that build sidewalks and trails to provide program access to existing facilities and to design and construct new facilities and altered facilities to be readily accessible to individuals with disabilities. Title III of the ADA requires places of public accommodation to remove barriers to access when it is readily achievable to do so and to meet the requirements for new construction and alteration in the ADA Standards for Accessible Design. Designers and planners of outdoor facilities should apply applicable sections of the ADA Standards for Accessible Design or UFAS and employ good design principles to ensure that facilities are accessible to and usable by people with disabilities.



# Characteristics of Pedestrians

Public sidewalks and trails are more effective when designed to accommodate the needs of all potential users. To develop effective transportation networks, people responsible for designing public sidewalks and trails must understand the needs of the full range of route users. The concept of the “standard pedestrian” is a myth; in reality, the travel speeds, endurance limits, physical strength, stature, and judgmental abilities of pedestrians vary tremendously. Sidewalk and trail users include children, older adults, families, and people with and without disabilities.

Pedestrians are defined in this report as people who travel on foot or who use assistive devices, such as wheelchairs, for mobility. Many people have conditions that limit their ability to negotiate public sidewalks and trails. According to the 1990 U.S. Census, an estimated 49 million noninstitutionalized Americans (about one in five) have a disability (U.S. Department of Commerce, Bureau of the Census, 1994). Many of these individuals have needs characteristic of more than one type of limitation. For example, a wheelchair user might also have a hearing impairment.

Different individuals are capable of varying degrees of mobility. Some people are able to climb mountains, whereas others cannot cross a room independently, even with the aid of an assistive device such as crutches or a wheelchair. In general, the ability to reach a destination depends on a person’s speed, coordination, endurance, and the types of obstacles, grades, and cross-slopes he or she encounters along the way. Accessibility guidelines, such as ADAAG or UFAS, provide minimum specifications for accessibility that meet the needs of most people. However, exceeding the minimum standards whenever possible will increase a facility’s overall ease of use and will make environments accessible to more

people. For example, routing a trail to minimize grades, rather than installing an 8.3 percent ramp, would enable more people who cannot negotiate steep grades to use that trail.

The physical fitness of pedestrians spans a wide range and affects mobility in a number of ways. Strength and flexibility, for example, are required to open doors, press control switches, and travel up curbs and stairs. Stamina, or the ability to repeat a movement, is required to travel for extended distances.

More than 50 percent of American adults are considered overweight or obese. Excess body weight increases strain on the body during physical activity and intensifies the risk of joint injury, temperature regulation problems, and heart disease (American College of Sports Medicine, 1997). Cardiac conditions such as atherosclerosis and angina, pulmonary diseases such as emphysema, circulatory problems such as hypertension and peripheral vascular disease, and degenerative joint diseases such as arthritis are other examples of long-term medical conditions that may limit the individual’s capacity for walking. Cardiac conditions also might limit an individual’s ability to perform sudden movements such as moving out of the path of an oncoming car.

Carrying packages or luggage, pushing children in strollers, pulling delivery dollies, or otherwise transporting items can also limit the physical capabilities of pedestrians. Pedestrians who are transporting additional items cannot react as quickly to potential hazards as other pedestrians because they are more physically taxed and distracted. They might walk more slowly, tire more easily, and require larger spaces to turn or maneuver than other pedestrians.

Facilities that are accessible to people with disabilities are generally safer and more



user-friendly for all pedestrians. Most people will become temporarily disabled by injury at some point in their lives. People with temporary disabilities, such as a broken arm or sprained ankle, will be able to continue their daily functions with less inconvenience if accessible features, such as curb ramps, are available in their communities.

Some design approaches might benefit one group but inhibit access for another. For example, installing ramps to accommodate wheelchair users might make walking more difficult for many cane and crutch users who may have an easier time negotiating short steps. To accommodate both user groups, steps and a ramp should be provided whenever possible. The needs and capabilities of all potential users should be considered and balanced when designing pedestrian facilities.

## 2.1 Older Adults

Improvements in quality of life, nutrition, and health care have lengthened the average American lifespan and increased the ranks of older adults. By the year 2020, it is estimated that 17 percent or more of the U.S. population (nearly one in five) will be older than 65 (Staplin, Lococo, and Byington, 1998). Although aging itself is not a disability, according to the U.S. Census, in 1990 “most persons aged 75 or older had a disability” (U.S. Department of Commerce, Bureau of the Census, 1994). Many of the characteristics commonly associated with aging might limit mobility. Because the attenuated reflexes and physical limitations of older adults might prohibit them from driving automobiles, they are more likely to rely on public transit or walking than other adults (FHWA and NHTSA, 1996). Although not all older adults have disabilities, those who do benefit from accessible designs.

The aging process frequently causes a general deterioration of physical, cognitive, and sensory abilities. These

changes intensify over time and are most pronounced for individuals over 75 years of age (ibid.). Characteristics of many older adults may include the following (FHWA and NHTSA, 1996; University of North Carolina Highway Safety Research Center, 1996; Knoblauch, Nitxburg, Dewar, Templer, and Pietrucha, 1995; and Staplin, Lococo, and Byington, 1998):

- Vision problems, such as degraded acuity, poor central vision, and reduced ability to scan the environment
- Reduced range of joint motion
- Reduced ability to detect, localize, and differentiate sounds
- Limited attention span, memory, and cognitive abilities
- Reduced endurance
- Reduced tolerance for extreme temperature and environments
- Decreased agility, balance, and stability
- Inability to quickly avoid dangerous situations
- Excessive trust that fellow drivers will obey traffic rules
- Slower reflexes
- Impaired judgment, confidence, and decision-making abilities

### 2.1.1 Safety

Older adults are more likely to suffer serious consequences or fatalities from falling or traffic crashes than other pedestrians (Burden and Wallwork, 1996). Older people generally need frequent resting places and prefer more sheltered environments. Surveys of older pedestrians indicate that many have an increased fear for personal safety. Their fears are confirmed by statistics indicating that older pedestrians appear to be at increased risk for crime and crashes at places with no sidewalks, sidewalks on only one side, and places with no street lighting.

Older people would thus benefit from accessible paths that are well lit and policed (Knoblauch, Nitxburg, Dewar, Templer, and Pietrucha, 1995).

### 2.1.2 Ambulation

Because older people tend to move more slowly than other pedestrians, they require more time to cross streets than other sidewalk users. One survey revealed that the most common complaint among older pedestrians was not having sufficient time to cross intersections before signal changes (ibid.). The *Manual on Uniform Traffic Control Devices* (MUTCD) assumes that the average pedestrian walking rate is 1.2 m/s (4 ft/s) (US DOT, 1988). However, adjusting signal timing based on an assumed walking speed of 0.85 m/s (2.8 ft/s) might better accommodate older pedestrians (Staplin, Lococo, and Byington, 1998).

The ambulation of older adults is also affected by their reduced strength. Traveling over changes in level, such as high curbs, can be difficult or impossible for older adults (Knoblauch, Nitxburg, Dewar, Templer, and Pietrucha, 1995). However, some older people may prefer the direct path of short stair steps to the gradual grades of lengthy ramps.

### 2.1.3 Object Manipulation

The reduced manual dexterity, grip force, and coordination experienced by many older people can affect their ability to operate common mechanisms such as doors and door handles, phones, drinking fountains, pedestrian-actuated traffic signals, and parking meters.

### 2.1.4 Visual and Cognitive Processing

Older people are likely to experience a reduction in visual ability. The reduced visual acuity of older people can make it difficult for them to read signs or to detect curbs. Visual changes that occur with age

make older people more dependent on high contrast between sign backgrounds and lettering. Older people are also more susceptible to glare. Reduction in pupil size with age also makes night travel more difficult for older people. Contrast-resolution losses in older people can cause them to have difficulty seeing small changes in level, causing trips and falls on irregular surfaces (Staplin, Lococo, and Byington, 1998).

A reduced capacity for sensory processing or problem solving can cause older adults increased difficulties when negotiating unfamiliar environments. Older adults tend to require more time to make decisions and often start moving later than other pedestrians when crosswalk signals indicate a walk phase. These limitations, plus reductions in peripheral vision capabilities, the tendency to underestimate traffic speeds, and a diminishing ability to process multiple sources of information, make it difficult for older adults to use wide, complex intersections (Staplin, Lococo, and Byington, 1998). Several studies indicate that the majority of older people do not correctly understand many traffic signals. This confusion was attributed to inconsistent meaning and insufficient clarity of the signals (Knoblauch, Nitxburg, Dewar, Templer, and Pietrucha, 1995).

## 2.2 Children

Children have fewer capabilities than adults because of their developmental immaturity and lack of experience. Compared to adults, children tend to exhibit the following characteristics (FHWA and NHTSA, 1996):

- One-third less peripheral vision
- Less accuracy in judging speed and distance
- Difficulty localizing the direction of sounds
- Overconfidence
- Inability to read or comprehend warning signs and traffic signals

- Unpredictable or impulsive actions
- Lack of familiarity with traffic patterns and expectations
- Trust that others will protect them
- Inability to understand complex situations

Like older adults, children rely on public transit and walking more than other people because they cannot drive. Routes frequently traveled by children, including areas near schools or playgrounds, should have traffic flow patterns that are simple and easy to understand.

Children are involved in more than 30 percent of traffic crashes involving pedestrians. In 1991, entering the street midblock was by far the leading cause of traffic accident fatalities for children (54 percent for ages 5 to 9 years, 26 percent for ages 10 to 14 years). These large proportions may indicate a need to add more midblock crossings in areas frequented by children (Burden and Wallwork, 1996).

Children benefit from facilities such as lower drinking fountains, lower sign placement, and doors that are easier to open because they lack the physical stature and strength of adults. In addition, because many children have not yet learned to read, symbol-based pedestrian signals might be easier for them to understand than signals that contain words.

## 2.3 People with Disabilities

According to the 1990 U.S. Census, one in every five Americans has a disability (U.S. Department of Commerce, Bureau of the Census, 1994). Anyone can experience a temporary or permanent disability at any time due to age, illness, or injury. In fact, 85 percent of Americans living to their full life expectancy will suffer a permanent disability (University of North Carolina Highway Safety Research Center, 1996).

People with disabilities are also more likely to be pedestrians than other adults because some physical limitations can make driving difficult and because they experience financial hardship at a higher rate than other adults (Golden, Kilb, and Mayerson, 1993).

For the purposes of this report, disabilities have been divided into the following three categories:

- Mobility
- Sensory
- Cognitive

### 2.3.1 People with Mobility Impairments

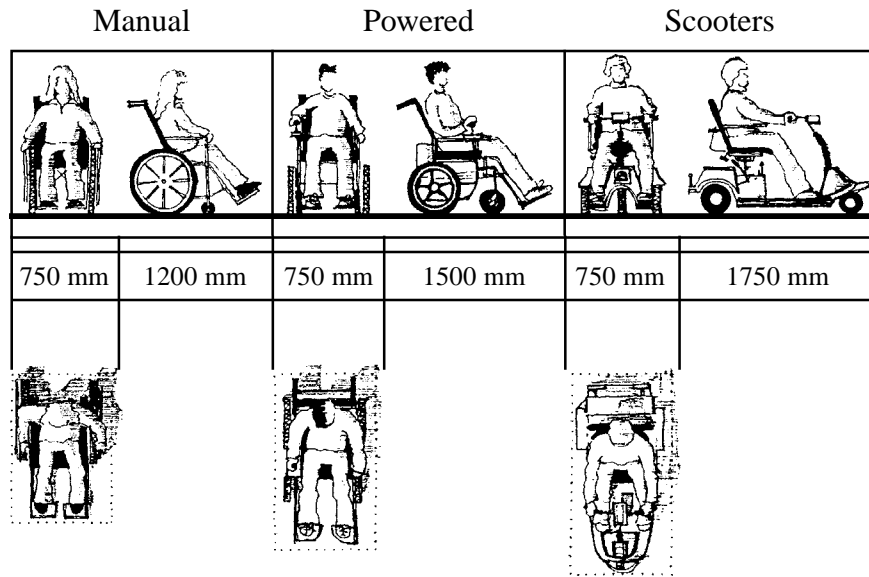
People with mobility impairments include those who use wheelchairs, crutches, canes, walkers, orthotics, and prosthetic limbs. However, there are many people with mobility impairments who do not use assistive devices. Characteristics common to people with mobility limitations include substantially altered space requirements to accommodate assistive device use, difficulty negotiating soft surfaces, and difficulty negotiating surfaces that are not level.

#### 2.3.1.1 Wheelchair and scooter users

In 1990, 1.9 million Americans identified themselves as wheelchair users for the U.S. Census (U.S. Department of Commerce, Bureau of the Census, 1994).

Wheelchair and scooter users often travel much faster than walking pedestrians, especially on level surfaces or downgrades, but they can be much slower when traveling uphill. In addition, their stability and control can be affected by surfaces with cross-slopes, grades, or rough terrain. Wheelchair and scooter users require a wider path of travel than ambulatory pedestrians. Therefore, sufficient passing space should be provided to allow wheelchair users to pass one another and to turn around.

**Figure 2-1:**  
**Wheelchair and scooter dimensions (in mm)**  
(based on *Architecture and Engineering for Parks Canada and Public Works and Government Services Canada, 1994*).



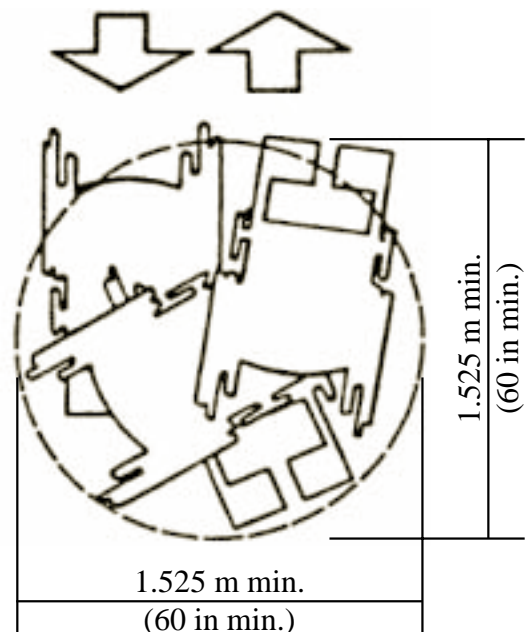
Wheelchair and scooter users require more space to turn around than other pedestrians. Furthermore, people who are unable to pull backward on their wheelchair wheels require a larger maneuvering space than those who can move one wheel forward and the other backward while turning. The turning diameter of a wheelchair or scooter is dependent upon the length of its wheelbase. Powered wheelchairs and scooters are generally longer than manual wheelchairs (Figure 2-1). Research at the Georgia Institute of Technology by John Templer (1980c) found that the turning radii of manual wheelchairs ranged from 0.635 to 1.270 m (25 to 50 in). Powered wheelchairs tended to have larger turning radii than manual wheelchairs because of the longer wheelbase (Templer, 1980c). The Templer research did not address scooters because they were relatively new in 1980.

ADAAG Section 4.2.3 specifies a 1.525 m x 1.525 m (60 in x 60 in) area for a wheelchair user to make a 180-degree turn (Figure 2-2). According to ADAAG, a T-intersection of two walkways is also an acceptable turning space (ADAAG, U.S. Access Board, 1991). The ADAAG specifications for turning

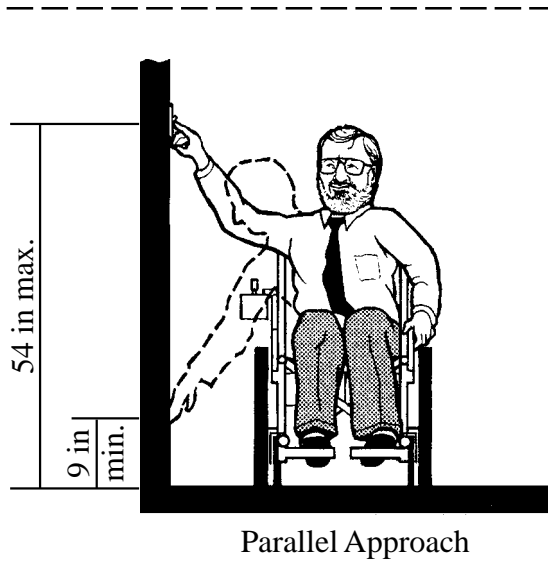
space are consistent with the findings from the Templer research.

The U.S. Department of Housing and Urban Development (HUD) sponsored a study comparing the reach and physical capabilities of a number of wheelchair users and walking pedestrians. Many of

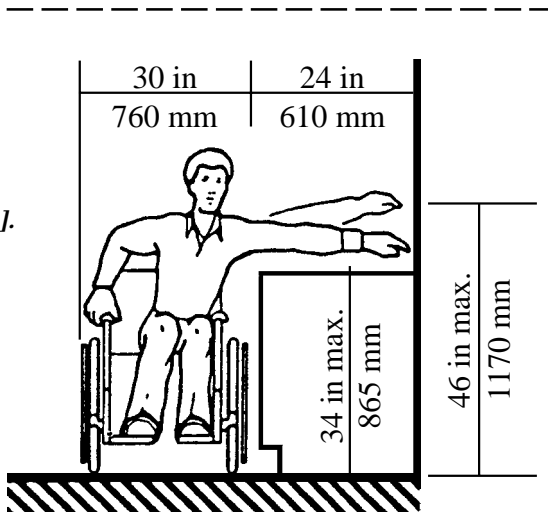
**Figure 2-2:**  
**Circle diameter of a standard manual wheelchair**  
[ADAAG, *Figure 4.3(a)*, *U.S. Access Board, 1991*].



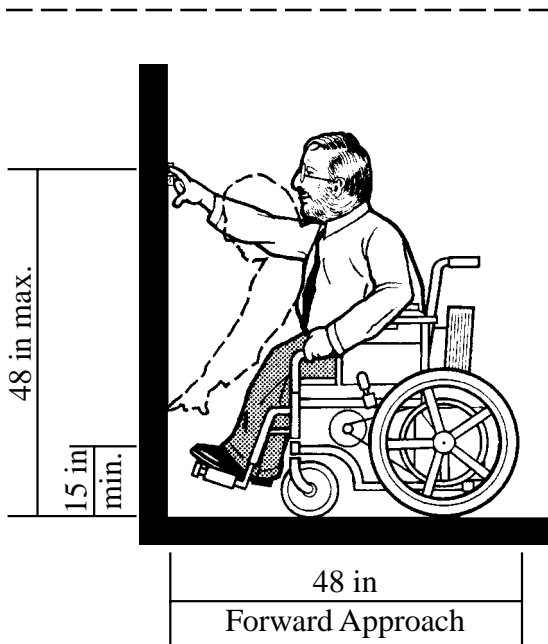
**Figure 2-3:**  
**High and low side-reach limits**  
(Barrier Free Environments, Inc., 1996).



**Figure 2-4:**  
**Maximum side-reach over an obstruction**  
[ADAAG, Figure 4.6(c), U.S. Access Board, 1991].



**Figure 2-5:**  
**High and low forward-reach limits**  
(Barrier Free Environments, Inc., 1996).



the specifications in ADAAG and UFAS are based on the anthropometric data obtained in the HUD study. Of the wheelchair users who participated, 87 percent had a maximum high side-reach of at least 1.370 m (54 in), when the clear floor space allowed a parallel approach to an object (Table 2-1) (Steinfeld, Schroeder, and Bishop, 1979). ADAAG specifies a maximum high side-reach of 1.370 m (54 in) and a minimum low side-reach of 0.230 m (9 in) when a parallel approach is possible (ADAAG, U.S. Access Board, 1991). Figure 2-3 illustrates maximum high side-reach and maximum low side-reach. If the side-reach is over an obstruction, such as a pedestrian-actuated signal positioned next to a trash receptacle, the reach and clearances should be consistent with Figure 2-4.

ADAAG Section 4.2.5 specifies a maximum high forward-reach of 1.220 m (48 in) and a minimum low forward-reach of 0.380 m (15 in) if an object can be approached only from the front (ADAAG, U.S. Access Board, 1991). Figure 2-5 illustrates maximum high forward-reach and maximum low forward-reach. If the

**Table 2-1:**  
**Highest Reach for Wheelchair Users**  
(based on Steinfeld, Schroeder, and Bishop, 1979)

Maximum High Side-Reach (m)	Number of Subjects	Percent of Subjects
<0.915	1	2
0.915–1.065	0	0
1.065–1.220	1	2
1.220–1.370	4	7
1.370–1.525	19	31
1.525–1.675	30	51
1.675–1.830	3	5
Missing data	1	2
<b>Total</b>	<b>59</b>	<b>100</b>

forward-reach is over an obstruction, the reach and clearances should be consistent with Figure 2-6.

The seated position of wheelchair users also impacts the height of their line of sight, which is important when looking for traffic and reading street signs. Based on the results in Table 2-2, the HUD study recommended that the eye level for wheelchair users be considered as a range from 0.890 to 1.320 m (35 to 52 in) (Steinfeld, Schroeder, and Bishop, 1979).

**Table 2-2:**

**Eye-Level Measurements for Wheelchair Users (based on Steinfeld, Schroeder, and Bishop, 1979)**

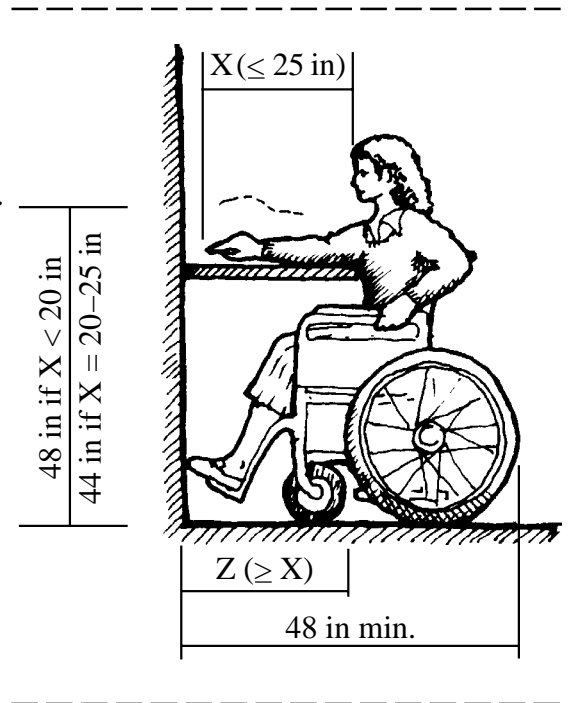
Eye-Level Height (m)	Number of Subjects	Percent of Subjects
<0.915	0	0
0.915–1.015	1	2
1.015–1.120	12	20
1.120–1.220	37	62
1.220–1.320	8	14
>1.320	0	0
Missing data	1	2
Total	59	100

Because wheels are difficult to propel over uneven or soft surfaces, wheelchair and scooter users need firm, stable surfaces and structures such as ramps or beveled edges to negotiate changes in level. Curb ramps allow wheelchair users to negotiate curbs more easily.

Because cross-slopes tend to cause wheelchairs and scooters to veer downhill, manual wheelchair users must perform additional work to continue traveling in a straight line over areas such as driveway crossings. Severe cross-slopes can cause wheelchairs to tip over sideways, especially during a turn (FHWA and NHTSA, 1996).

Cross-slopes that change very rapidly cause additional problems for wheelchair

**Figure 2-6:**  
**Maximum forward-reach over an obstruction (PLAE, Inc., 1993).**



users. The rate of change of cross-slope is most problematic when it occurs over a distance of less than 0.610 m (2 ft), the approximate distance covered by a wheelchair wheelbase. As the wheelchair moves over the surface of a severely warped driveway flare, it will first balance on the two rear wheels and one front caster. As the wheelchair moves forward, it then tips onto both front casters and one rear wheel. This transition may cause the wheelchair user to lose control and possibly tip over. A rapid change in cross-slope can also cause people with walkers to stumble. For more information on rate of change of cross-slope, refer to Section 4.3.2.

### 2.3.1.2 Walking-aid users

People who employ walking aids include those who use canes, crutches, or walkers to ease their ambulation. According to the 1990 U.S. Census, 4 million adult Americans reported having used a cane for longer than 6 months (U.S. Department of Commerce, Bureau of the Census, 1994). The limitations of walking-aid users might include the following (Bhambhani and Clarkson, 1989):

- Difficulty negotiating steep grades
- Difficulty negotiating steep cross-slopes
- Decreased stability
- Slower walking speed
- Reduced endurance
- Inability to react quickly to dangerous situations
- Reduced floor reach

People who use walking aids are often able to negotiate small steps and might even prefer steps to a longer ramp. In these situations, railings can be extremely helpful. Tall steps are generally quite difficult for cane, crutch, and walker users to negotiate. People who use walkers and crutches also benefit from stairs deep enough to accommodate all four legs of the walker or crutches positioned in front of the feet.

Surface quality significantly affects ease of travel for walking-aid users. Grates and cracks wide enough to catch the tip of a cane can be potentially dangerous for walking-aid users. Icy or uneven surfaces can also be hazardous because they further reduce the already precarious stability of walking-aid users.

People who use walking aids tend to travel more slowly than other pedestrians. As a result, they benefit from longer pedestrian signal cycles at intersections and the presence of passing spaces to allow others to travel around them. According to ADAAG Section A4.2.1(2), people who use crutches or walkers can maneuver through clear width openings that are 0.815 m (32 in); however, at least 0.915 m (36 in) is necessary if the passageway is restricted for more than 0.610 m (24 in) (ADAAG, U.S. Access Board, 1991).

Walking-aid users also require significantly more energy for ambulation than pedestrians who do not use walking aids (Fisher and Patterson, 1981; Fisher and Gullickson,

1978). As a result, they benefit from sidewalks and trails that have frequent rest areas.

### **2.3.1.3 Prosthesis users**

People lacking one or more limbs, hands, and/or feet often use prostheses such as metal hooks or molded plastic limbs to help them walk or grip items. Prosthesis users with amputations due to diabetes, cardiovascular problems, or other diseases might have a more limited capacity for exercise than prosthesis users whose missing limbs resulted from developmental difficulty or traumatic injury (Shephard, 1990).

Although people using leg prostheses can achieve levels of fitness similar to their peers', their most comfortable walking speeds are typically slower than those of individuals without disabilities (Ward and Meyers, 1995). People who use above-knee prostheses move more slowly and expend more energy in ambulation than individuals with below-knee prostheses (ibid.). In general, prosthesis users benefit from extended signal timing at wide intersections. Some people with lower limb prostheses might have greater difficulty than other pedestrians maintaining balance on grades or cross-slopes.

Some electric devices, such as computerized information kiosks, use screens sensitive to the body's electric potential to interact with the user. Although these heat-sensitive devices can be helpful for people with little manual dexterity, people who use metal hooks or plastic hands cannot trigger these sensors with their prostheses.

### **2.3.2 People with Sensory Impairments**

Although sensory disabilities are commonly thought of as total blindness or deafness, partial hearing or vision loss is much more common. Other types

of sensory disabilities can affect touch, balance, or the ability to detect the position of one's own body in space. Color blindness is also considered a sensory deficit (University of North Carolina Highway Safety Research Center, 1996).

### 2.3.2.1 People with visual impairments

In 1990 the U.S. Census reported that 1.8 million noninstitutionalized Americans over the age of 15 had a visual disability that prevented them from seeing words or letters in ordinary newspaper. (U.S. Department of Commerce, Bureau of the Census, 1994). Visual disabilities can cause the following impediments to mobility (Clark–Carter, Heyes, and Howarth, 1987):

- Limited perception of the path ahead (preview)
- Navigation with limited information about surroundings, providing less protection against obstacles and other dangers
- Reliance on memory and unchanging conditions in familiar terrain
- The need to assimilate information obtained through nonvisual sources such as texture and sound.

Because many people with visual disabilities have diminished peripheral vision, they may have difficulty perceiving or reacting quickly to approaching dangers, obstacles, and changing conditions (Clark–Carter, Heyes, and Howarth, 1987).

#### 2.3.2.1.1 Cane users

Many people who are blind use long canes to navigate. There are two principal cane techniques: touch and diagonal. In the touch technique, the cane arcs from side to side and touches points outside both shoulders. In the diagonal technique,

the cane is held out stationary across the body or just above the ground at a point outside one shoulder. The cane handle or grip then extends to a point outside the other shoulder. The touch technique is generally used in uncontrolled areas such as on a sidewalk, while the diagonal technique is used primarily in controlled and familiar environments. Cane users are often trained in both techniques (Park, 1989a; Jacobson, 1993).

The touch and diagonal techniques are typically used in conjunction with the constant-contact technique. When the cane user wants to explore an area more completely, he or she will drag the cane tip across the surface. The constant contact between the cane and the ground provides very detailed information about the area explored (ibid.).

#### 2.3.2.1.2 Dog-guide users

Some people who are blind use dog guides to navigate. “Dogs guide in response to a specific set of commands given by voice and hand signals” (Whitstock, Franck, and Haneline, 1997, in Blasch et al.). A common misconception about dog guides is that they are capable of making decisions for their owners. Dog guides are trained to avoid obstacles, including those overhead that would not be detected by a long cane. Dog guides are also taught to pause at stairs, curbs, and other significant changes in elevations. When traveling along a sidewalk, dog guides tend to follow the left border of a sidewalk or trail. Because dog guides crossing an intersection generally aim for the opposite curb, they may guide their owners outside the marked crosswalk path, missing medians and pedestrian refuge islands, to take the shortest path to the opposite curb. (*The Seeing Eye*, 1996). Intersections are easiest to negotiate for dog-guide users when the line of travel from the edge of the sidewalk to the opposite curb is straight rather than skewed, as it is at some irregularly shaped intersections.



### **2.3.2.1.3 Information for people with visual impairments**

People with visual impairments benefit from two distinct types of information along sidewalks and trails: detectable warnings, which are intended to identify potentially hazardous situations, such as the transition from the sidewalk to the street; and wayfinding information, which allows users to orient themselves within their environment.

Detectable warnings are surfaces that can be detected underfoot and by a person using a cane through texture, color, and resilience. Detectable warnings should convey a “stop” message to people with visual impairments. Once the user has stopped and identified the hazard, he or she can determine if it is safe to proceed. Detectable warnings are not required on sidewalks. However, if they are installed, they should be consistent with the specifications in ADAAG Section 4.29. Use of a consistent formula to indicate detectable warnings will prevent people with visual impairments from misinterpreting warning messages as orientation information.

Wayfinding information does not convey a warning, but rather provides orientation information to the user. People with visual impairments use a variety of cues to orient themselves within their environment. However, many of the cues, such as the sound of traffic, are not consistently available. To provide people with visual impairments with accessible wayfinding information, environmental modifications should be provided. Visual cues, tactile surfaces, and audible pedestrian signals can make information about traffic flow and street crossings accessible to people with visual impairments. Examples of accessible wayfinding information include audible pedestrian signals and tactile guidestrips at crosswalks. Visual information, such as painted crosswalks, are beneficial to the 80 percent of the people who are legally blind but have some residual vision. If a detectable surface is used to provide wayfinding

information, it should be distinct from the surface used to convey a warning message. For more information on detectable warnings and wayfinding information, refer to Section 4.4.2.

### **2.3.2.1.4 Crossing intersections**

Where pedestrian signals are not accessible, people with visual impairments might start to cross an intersection later than other pedestrians because they might wait for the sound of parallel traffic and/or other crossing pedestrians to identify the crossing interval. In addition, people with visual impairments might have difficulty identifying and maintaining the correct path across the intersection. In combination, these factors increase the amount of time that people with visual impairments might need to complete street crossings.

People with severe visual impairments take the following steps to cross an intersection:

1. Detect arrival at an intersection by using a combination of cues such as a raised curb, the slope of a curb ramp, the absence of a building shoreline, detectable indicators, remembered landmarks, traffic sounds, and any other available wayfinding cues.
2. Determine whether a pedestrian signal must be actuated to get the walk signal and actuate it if necessary.
3. Determine when it is safe to walk by using traffic or pedestrian surge noise cues or audible traffic signal cues.
4. Orient themselves toward the crosswalk by using cues such as traffic noise, audible or otherwise detectable beacons (see Chapter 4), and physical features of the environment, such as the boundary between a sidewalk and an adjacent planting strip, that are known to be parallel to the crosswalk, or curb lines that are known to be perpendicular to the crosswalk.

5. Navigate to the opposite curb through any medians, islands, crosswalk angles, or other obstacles.

### **2.3.2.2 People with hearing impairments**

Although as many as 40 percent of older adults have hearing impairments, hearing loss is not generally believed to be a significant barrier to sidewalk and trail use. However, hearing loss can limit a person's ability to use cues such as the increasing noise of an approaching vehicle to detect impending dangers. Hearing loss thus forces users to rely heavily on visual indicators or vibrations caused by passing traffic. Areas with long sight distances relatively free of visual obstructions, such as landscaping, may be useful to people with hearing impairments (FHWA and NHTSA, 1996).

### **2.3.3 People with Cognitive Impairments**

Cognition is the ability to perceive, recognize, understand, interpret, and respond to information. It relies on complex processes such as thinking, knowing, memory, learning, and recognition. Cognitive disabilities can hinder the ability to think, learn, respond, and perform coordinated motor skills.

The movement skills of people with cognitive disabilities vary tremendously. However, the motor skills and fitness potential of people with cognitive disorders are often hampered by a lack of opportunity to learn and practice appropriate physical activity movements. As a result, walking speed has been shown to decrease with the presence of cognitive or depressive disabilities (Woo, Ho, Lau, Chan, and Yuen, 1995). People with cognitive disabilities also might have difficulty navigating through complex environments

such as city streets and might become lost more easily than other people.

Design approaches for people with cognitive impairments also might benefit children and the more than 20 percent of American adults who do not read English (National Library of Education, Office of Educational Research and Improvement, personal communication, 1998). Signs that use pictures, universal symbols, and colors convey meaning to a broad range of people. For example, pedestrian crossing signals that display a picture of a person walking may be more universally understood than signs reading WALK. Always placing the DON'T WALK signal above the WALK signal also increases the clarity of pedestrian signals for users because people who cannot read can derive meaning from the order of the signals. Traffic signals for automobiles are also placed in a consistent order to benefit people who are color blind and cannot distinguish between red and green. Additional research is needed to determine if the contrasting colors of the WALK and DON'T WALK lights play a significant role in people's understanding of pedestrian signals. However, people who are color blind do not benefit from pedestrian signals that use distinct colors.

## **2.4 Conclusion**

A good understanding of how all pedestrians, including people with disabilities, older people, and children, perform in sidewalk and trail environments can help designers determine how best to implement accessibility improvements to outdoor facilities. Sidewalk and trail designers who have a solid background in the capabilities and travel habits of their design audience can make more informed decisions to create pathways that serve the entire community.



# Summary of the Planning Process

Before passage of the Intermodal Surface Transportation Efficiency Act (ISTEA) in 1991, transportation planning and investment decisions were focused on national transportation priorities that favored automobile travel, such as the completion of the Interstate system. In recent years, transportation planners have shifted emphasis to address more State and local concerns, including alternatives to the car. Planners have started to obtain more input from local users. Projects planned with local citizen involvement have led to the development of transportation facilities that better meet the needs of local users, including underserved communities such as minorities and people with disabilities. These projects have also tended to encourage more pedestrian use. Federal, State, and regional transportation agencies now routinely assess both the positive and negative impacts of a planned project by holding community meetings, distributing surveys, and interviewing individuals from a wide variety of user groups.

## 3.1 Intermodal Surface Transportation Efficiency Act and Transportation Equity Act for the 21st Century

The 1956 Federal-Aid Highway Act directed Federal transportation policy to construct “an extensive network of roads across America” (DiStefano and Raimi, 1996), including the 42,000-mile Interstate highway system. For the next 35 years, most Federal and State transportation plans and funding focused on this primary task. In 1991, with the system almost complete, Congress shifted the focus of national transportation policy to the efficient movement of people and goods. As part of this shift, Congress gave States and metropolitan planning organizations (MPOs) greater flexibility to use their transportation funds on State and local

priorities as part of an enhanced transportation planning process that ensured the involvement of all affected agencies, as well as the community.

ISTEA placed a greater focus on the concepts of intermodalism and multimodalism, increased funding opportunities for transportation projects promoting alternatives to the automobile, and emphasized the importance of involving the community in the planning process. After the enactment of ISTEA, the US DOT undertook a major effort to develop a national policy to promote bicycling and walking as viable transportation options. This work is published in *The National Bicycling and Walking Study — Transportation Choices for a Changing America* (1994). The study established goals to double the number of walking and bicycling trips and to reduce traffic injuries and crashes affecting pedestrians and bicyclists. Ongoing strategies were developed for Federal, State, and local governments to improve bicycling and walking conditions. The Transportation Equity Act for the 21st Century (TEA-21), signed into law on June 9, 1998, builds on the many changes made by ISTEA.

## 3.2 Building a Multi- and Intermodal System

A multimodal transportation system allows people to choose to walk, bicycle, use transit, or drive according to the type of trip they wish to make. Short trips can be made by foot or bicycle, while transit and driving options exist for longer trips or those involving heavy loads. Such a system helps promote choice, ensures equitable access to transportation, and reduces societal reliance on a single mode of transportation. Creating such a multimodal system challenges planners and decision makers to create innovative

solutions to current transportation problems. These strategies, such as telecommuting and ridesharing, can go beyond traditional infrastructure investments.

A multimodal system must also be intermodal. Intermodalism integrates all forms of transportation, such as highways, public transit systems, sidewalks, and bicycle facilities, into one seamless system. In an intermodal system, two or more distinct modes of travel are coordinated so that people can reach their destinations by transferring quickly and easily from one mode to the next. For example, for a public transit system to be a viable transportation alternative, it must provide frequent connections to an extensive network of accessible sidewalks and shared-use paths.

The trend toward more integrated, multimodal transportation systems has improved transportation options for people with disabilities, especially those who do not drive automobiles. The additional requirement that all new construction must comply with the ADA to the fullest extent possible has brought about an overall increase in the number of accessible pedestrian and public transit facilities.

### **3.3 Federal Transportation Funding Opportunities**

Since ISTEA was passed, budgets for pedestrian facilities have increased dramatically. Projects improving walking opportunities are eligible for all major Federal highway funding categories. Furthermore, TEA-21 clarifies that projects intended for the “modification of sidewalks to comply with the Americans with Disabilities Act of 1990” are eligible for Surface Transportation Program funds, the biggest single source of transportation funding for States in the legislation (TEA-21, 1998). Other categories include the National Highway System (NHS) funding program, which may be used to build sidewalks and trails as

integral parts of major highways, including Interstate corridors; the Congestion Mitigation and Air Quality Improvement (CMAQ) program, which may be used to make improvements to curb ramps, sidewalks, and intersections; and the Recreational Trails Program, which may be used to sponsor accessible off-road trail opportunities and improvements.

In recent years, the biggest source of funds for pedestrian and bicycle improvements has been the Transportation Enhancements program, which requires States to spend 10 percent of their Surface Transportation Program funds on a specific list of eligible projects. This list includes the development of pedestrian and bicycle facilities and the conversion of abandoned railroad corridors to trails. More than half of the funds available under this program have been used for these two activities. Pedestrian projects designed to improve the accessibility of a sidewalk or trail are also eligible for transportation enhancement funding.

Most States have appointed a transportation enhancement coordinator to oversee the management of these funds. States typically invite applications for enhancement funding each year and appoint a committee to select the projects that will be funded.

TEA-21 created two new funding opportunities for pedestrian and bicycle projects. The law established a Transit Enhancement Program that is similar to the Transportation Enhancement Program. One percent of the funds for urban transit projects is set aside for a prescribed list of activities that include “pedestrian access and walkways. . . and enhanced access for people with disabilities to mass transportation” (TEA-21, 1998). TEA-21 also made pedestrian, bicycling, and traffic calming measures eligible for Hazard Elimination Program funds. This program was designed to improve the safety of locations that present a danger to pedestrians, bicyclists, and motorists.

Like the Transportation Enhancement Program, this program consists of 10 percent of a State's Surface Transportation Program funds.

Transportation projects using Federal funds must be included in an approved transportation plan developed by a State or Metropolitan Planning Organization (MPO). Most federally funded pedestrian and bicycle projects require a certain level of matching State or local dollars, and a State or local agency must assume responsibility for maintaining facilities built with these funds.

### **3.4 Planning under Federal Transportation Legislation**

States and Metropolitan Planning Organizations (planning agencies established for each urbanized area of more than 50,000 population) are required to develop a transportation plan that provides for the development, integrated management, and operation of transportation systems and facilities, including pedestrian walkways and bicycle transportation facilities. Both statewide and MPO plans include projects and strategies that increase the safety and security of the transportation system for nonmotorized users.

States and MPOs are required to develop two types of transportation planning documents: a long-range plan with a 20-year horizon, and a Transportation Improvement Program (TIP) listing proposed projects to be completed over the next 3 years with Federal funding. Projects that appear in the TIP should be consistent with, or drawn from, the long-range plan. Both documents must be developed with significant public input and updated at least every 3 years.

Federal transportation legislation further requires that the needs of pedestrians and bicyclists be considered in these planning documents. TEA-21 specifies

that "bicycle transportation facilities and pedestrian walkways shall be considered, where appropriate, in conjunction with all new construction and reconstruction of transportation facilities, except where bicycle and pedestrian use are not permitted" (TEA-21, 1998). Transportation plans and projects must also provide due consideration of safe and contiguous pedestrian and bicycle routes. These safety considerations should include "the installation, where appropriate, and maintenance of audible traffic signals and audible signs at street crossings" (TEA-21, 1998).

Involvement in the planning process is critical to improving the transportation system for people with disabilities. States and MPOs are required to provide citizens, affected public agencies, and other interested parties with a reasonable opportunity to comment on the long-range plans and TIPs before they are approved; many agencies go further than this by including users and user groups on project selection committees and advisory boards.

During the development of the long-range plans and the TIPs, citizens can request funding for sidewalk and trail projects. Each revision and update to these documents is an opportunity to protect existing projects or promote new pedestrian improvements. Opportunities to affect the design and implementation of the project to benefit sidewalk users may continue to occur even after a project has been approved. As a result, interest groups must remain engaged throughout the planning process to ensure the usability of final designs.

### **3.5 Transportation Agencies**

Various Federal, State, and local government agencies are responsible for developing and maintaining transportation networks that link cities and towns. The Federal Highway Administration (FHWA) provides funding and technical assistance to States developing their transportation systems. Each State has a department of

transportation (DOT) that plans, designs, and maintains State roadway systems and other transportation. Jurisdiction over roadways and funding processes varies greatly from State to State.

Urbanized areas with populations larger than 50,000 have regional planning agencies, or MPOs, that are responsible for transportation planning and policy within their areas. Some MPOs also conduct other types of regional planning. MPOs and State DOTs should collaborate closely with each other, local transportation agencies, and community residents during the planning process.

### 3.6 Land Management Agencies

Land management agencies include Federal entities such as the USDA Forest Service, the USDI Bureau of Land Management, the USDI National Park Service, and the USDI Fish and Wildlife Service, as well as State and local entities responsible for parks, forests, or other public lands. Typically, such agencies have jurisdiction over tracts of land encompassing urban to wilderness environments. Like their civic counterparts, Federal land management agencies often delegate decisions to their regional and local divisions. Land management agencies are responsible for transportation planning within their own jurisdictions. However, if a land management agency uses Federal highway funding for its transportation projects, it must follow a planning process similar to that of the State DOT, which includes coordinating with appropriate State and local planning agencies. Although land management agencies construct some sidewalks, they are more likely to be involved in constructing trails.

### 3.7 Pedestrian/Bicycle Coordinators

Each State DOT is required to have a pedestrian/bicycle coordinator position.

In most States, this position is full time with sufficient authority to make pedestrian and bicycling issues a priority with other agencies, State offices, and divisions within the State DOT. Duties of the coordinator may include the following (Associate Administrator for Program Development, Federal Highway Administration, 1992):

- Planning and managing new nonmotorized facilities and programs
- Creating safety and promotional information for the public
- Helping to develop State and MPO pedestrian and bicycle facility plans
- Serving as the principal liaison among Federal, State, and local agencies and the press, citizen organizations, and individuals on bicycling and walking issues

### 3.8 Other Transportation Planning Participants

Federal legislation requires transportation agencies to engage the public throughout the planning process. The “public” consists of a diverse web of people whose varied activities and presence make up the fabric of a community. The following are segments of the public that are involved in the planning process:

**Individual citizens** — members of the community unaffiliated with advocacy groups

**Citizens’ groups** — citizen-organized volunteer groups, including neighborhood organizations and business coalitions

**Advocacy groups** — grassroots organizations dedicated to representing the needs of a particular interest group, such as people with disabilities

**Land developers** — professionals who are not part of a State or local agency employed in the real estate, construction, or development industry

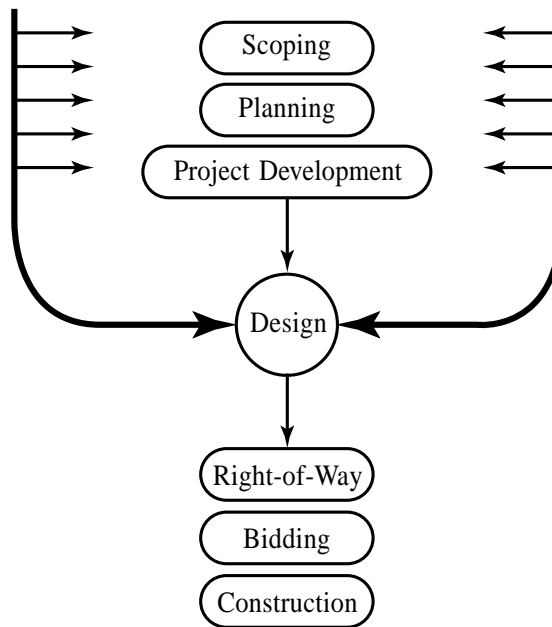
**Figure 3-1:**  
**Sources of input during the project development process (based on FHWA, 1997a).**

### Professional Input

- Engineers
- Landscape Architects
- Urban Planners
- Archaeologists
- Historians
- Environmental Specialists

### User Input

- Citizens' Groups
- Public Meeting Participants
- Bicycle and Other Interest Groups
- Historical Associates
- Public Officials



**Advisory committees** — groups convened by agencies to provide planning advice

**Elected local officials** — people who represent the public interest and are responsible to a geographically close but often highly diverse constituency. Elected officials such as city council members and legislative representatives serve as repositories for the opinions of a wide cross-section of the public.

Although citizens are not directly responsible for construction of public sidewalks and trails, they imbue the planning process with a unique local perspective. For example, a resident might know of a better location for a playground or sidewalk than a regional planner less familiar with the area. Citizens who travel around their communities are often best qualified to identify when the transportation network breaks down and where problems exist. Ideally, the public involvement process will result in decisions that best reflect the community's mobility and accessibility needs. Public involvement should pervade all aspects of the overall project development process, including

the choice of priorities and investment decisions, as shown in Figure 3-1 (FHWA and FTA, 1995).

### 3.9 Strategies for Public Involvement

ISTEA's increased acknowledgment of public involvement became the impetus for the development of more innovative and friendly public involvement strategies. While past public involvement efforts have emphasized "telling" or "selling" something to the public, the operative phrase is now "consulting with" the public (US DOT, 1995c). According to Siwek and Associates (1996), "users, transportation providers, and the public should be given sufficient opportunity to provide input to the plan's development, not just to comment on a draft final project."

Transportation agencies need to implement effective procedures for involving the public. The public involvement technique selected depends on the results the agency wants to achieve, but techniques used should always involve the full range of users. For example,



an MPO may elect to use surveys in the early stages of planning, while relying on the input of an advisory committee for more in-depth planning discussions, such as those of a corridor master planning process.

It is important to provide opportunities for all segments of the community to participate in the planning process. Proactive outreach techniques are effective ways to consult with underserved communities, such as people with disabilities. Inviting the clients of retirement homes, Veterans Administration offices, and independent living facilities to a public planning meeting is a more productive strategy for obtaining input from people with disabilities than merely announcing the meeting in the local newspaper. In addition, holding planning meetings in venues accessible to people with disabilities should be a routine part of inviting all citizens to the planning table (US DOT, 1994c). MPOs should determine what public involvement techniques will work best given their local circumstances.

### **3.10 Community Impact Assessment**

When a new transportation facility is built or an existing facility is significantly expanded using Federal funds, Federal environmental legislation requires agencies to conduct a community impact assessment. The assessment process alerts affected businesses and residents, as well as transportation planners and decision makers, to the potential effects of a project (Brock et al., 1996). An agency considering a project must review the

potential positive and negative effects on the community and specific populations before proceeding to the construction stage. The potential impact of the project on accessibility should always be considered during the community impact assessment.

The information obtained during the community assessment process should be used to develop better projects and limit negative side effects. Perceived negative impacts can be overcome by involving the public from the start of the planning process. Agencies should be aware that mitigating the effects of one impact might create unanticipated new problems (*ibid.*). For example, the disturbance involved in rerouting a road through a residential neighborhood to avoid demolishing a historic downtown area might anger home owners.

### **3.11 Conclusion**

ISTEA signaled a dramatic change in national transportation policy. It increased community involvement in the planning process, expanded intermodal transportation facilities, and broadened opportunities for funding alternatives to the automobile. TEA-21 built on the foundation of ISTEA, and together, these two instrumental pieces of legislation have led to the development of a more comprehensive, locally determined, and flexible transportation system. The increased availability of pedestrian and bicycle facilities, combined with better outreach policies, will lead to more accessible communities.

# Sidewalk Design Guidelines and Existing Practices

Sidewalks form the backbone of the pedestrian transportation network. According to the Institute of Transportation Engineers, Technical Council Committee 5A-5 (1998), sidewalks “reduce the incidence of pedestrian collisions, injuries, and deaths in residential areas and along two-lane roadways.” Without sidewalks, public rights-of-way are inaccessible to all pedestrians, including people with disabilities. When sidewalks are not available, pedestrians are forced to share the street with motorists, access to public transportation is restricted, and children might not have safe play areas. Because Federal regulations do not require agencies to build sidewalks, the decision is left to States and local agencies. Some agencies prioritize sidewalk installation, while others do not.

Accessible pedestrian facilities should be considered part of every new public right-of-way project where pedestrians are permitted. Sidewalk installation and the linking of pedestrian routes to transportation stops and major corridors should always be a priority. The decision to install sidewalks should not be optional. “Sidewalks should be built and maintained in all urban areas, along non-Interstate public highway rights-of-way, in commercial areas where the public is invited, and between all commercial transportation stops and public areas” (Institute of Transportation Engineers, Technical Council Committee 5A-5, 1998). This chapter examines the elements and characteristics of sidewalks that have the greatest impact on access. These characteristics include grade, cross-slope, and the design of specific elements such as curb ramps, driveway crossings, and intersections.

## 4.1 Location Research

The researchers visited a variety of sidewalk locations to determine what

access provisions were being made for pedestrians. Eighteen jurisdictions across the United States were selected; some were chosen for their pedestrian-friendly reputations, while others were visited because the researchers had other business in the area. Measurements were taken during these visits to determine if the access needs of people with disabilities were being addressed and where improvements needed to be made.

During the site visits, local transportation officials responsible for sidewalk design and construction were interviewed about the ways their agencies were making sidewalks more accessible. Officials contacted included engineers responsible for implementing access improvements, ADA compliance officers, pedestrian/bicycle coordinators, and planners overseeing the construction of access features for new construction and renovations.

The interviews indicated that many sidewalk professionals have a desire to make sidewalks accessible. Designers and builders are beginning to realize that the standard pedestrian is a myth and that, in reality, sidewalk users are very diverse. However, there remains a need to provide information to designers and builders on ways to develop accessible facilities within the constraints of existing facilities, as well as in new construction.

During the visits, it became clear that techniques needed to be developed to accurately measure sidewalk elements such as curb ramps, driveway crossings, and medians. Techniques to quickly and accurately assess sidewalk environments were adapted from the Universal Trail Assessment Process (UTAP), originally developed to assess access conditions on recreational trails. The tools used to measure sidewalks were identical to those used in the UTAP, with the addition of a profile gauge to record small changes

in level and raised tactile surfaces (see Section 5.1 for more information about the UTAP). The terminology and measurement process was standardized to ensure consistency among personnel.

General information about each sidewalk feature was recorded, including type, dimensions, and location with respect to other sidewalk elements. A data sheet was developed for quick recording of general access information. More detailed measurements of curb ramps, driveway crossings, and medians were recorded on a separate form. Up to 10 grade segments, 8 lengths, and 6 transition heights were recorded for these elements for full characterization of the dimensions and grades of each ramp, street, and gutter.

## 4.2 Design Guideline Comparisons

In addition to visiting a variety of sidewalk locations, the researchers identified existing guidelines that could be applied to public rights-of-way. The guidelines were collected from Federal, State, and city agencies, as well as private research and advocacy organizations. Guidelines for sidewalks were compiled in Tables 4-2.1 to 4-2.4. Guidelines for curb ramps were compiled in Tables 4-3.1 to 4-3.4. Both sets of tables are located at the end of this chapter.

The degree of accessibility provided by each guideline depends on the focus of the authorizing agency or organization. For example, the design guidelines produced by the American Association of State Highway and Transportation Officials (AASHTO) focus primarily on vehicle use, whereas ADAAG emphasizes accessible design for pedestrians. The AASHTO guidelines for public rights-of-way are titled *A Policy on Geometric Design of Highways and Streets*; however, the document is commonly referred to as the *AASHTO Green Book*. This terminology will be used throughout this report to avoid confusion with the

AASHTO guidelines for bicycle and shared-use paths.

The Federal accessibility guidelines (the ADA Standards for Accessible Design and UFAS) were originally developed for accessible routes in buildings and on building sites. Many of the requirements for accessible routes can be extrapolated to public rights-of-way. In 1994, the U.S. Access Board developed draft accessibility guidelines, proposed by ADAAG (1994), that specifically applied to public rights-of-way. Even though proposed Section 14 (1994) is now reserved, some State DOTs have adopted it as their accessibility standard for public rights-of-way. Some State and local transportation agencies have also developed their own standards for sidewalk design because traditional guidelines, such as the *AASHTO Green Book*, do not include comprehensive sidewalk recommendations. Other organizations, such as the Institute of Transportation Engineers and the Federal Highway Administration, have also developed sidewalk and curb ramp design recommendations.

## 4.3 Access Characteristics

The design of a sidewalk can be described by a variety of characteristics. This report focuses on sidewalk characteristics that have the greatest impact on accessibility, such as grade and surface type. Other characteristics such as location, type of street, and climate also affect the pedestrian friendliness of a sidewalk but do not directly impact access. Access characteristics directly affect usability of a sidewalk. The amount of attention paid to these details will determine whether a facility is accessible or not. Even mildly difficult features in combination can add up to an inaccessible pathway.

### 4.3.1 Grade

*Grade* (slope) is defined as the slope parallel to the direction of travel and is calculated by dividing the vertical change in elevation by the horizontal distance

covered. For example, a path that gains 2 m in elevation over 50 m of horizontal distance has a grade of 4 percent. Although some guidelines use the term “slope” instead of “grade,” the term “grade” is used in this report to avoid confusion with cross-slope.

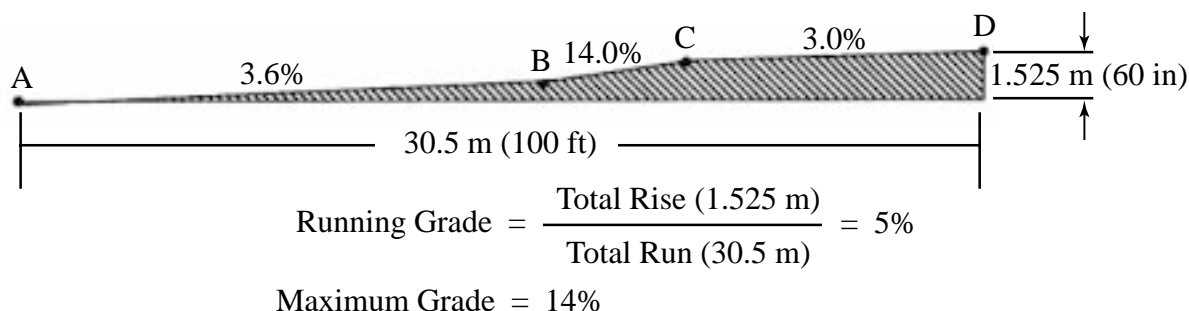
*Running grade* is defined as the average grade along a contiguous grade. *Maximum grade* is defined as a limited section of path that exceeds the typical running grade. In the pedestrian environment, maximum grade should be measured over 0.610 m (24 in) intervals (the approximate length of a wheelchair wheelbase, or a single walking pace). When measuring sidewalk grade, both running grade and maximum grade should be determined. Measuring running grade only does not give an accurate understanding of the sidewalk environment because small steep sections may not be detected. Figure 4-1

provides an example of a typical grade that is fairly negotiable, with a maximum grade that could be very difficult for some users to traverse. In the illustration, the running grade between Points A and D is 5 percent, but the grade between Points B and C is 14 percent. A person who could negotiate a 5 percent grade might not be able to negotiate a 14 percent grade, even for short distances.

The *rate of change of grade* is defined as the change in grade over a given distance. The rate of grade change is determined by measuring the grade and the distance over which it occurs for each segment of the overall distance. For the purposes of this report, rate of change of grade is measured over 0.610 m (2 ft) intervals, which represent the approximate length of a single walking pace and a wheelchair wheelbase (Figure 4-2). In the sidewalk environment, rate of change of grade

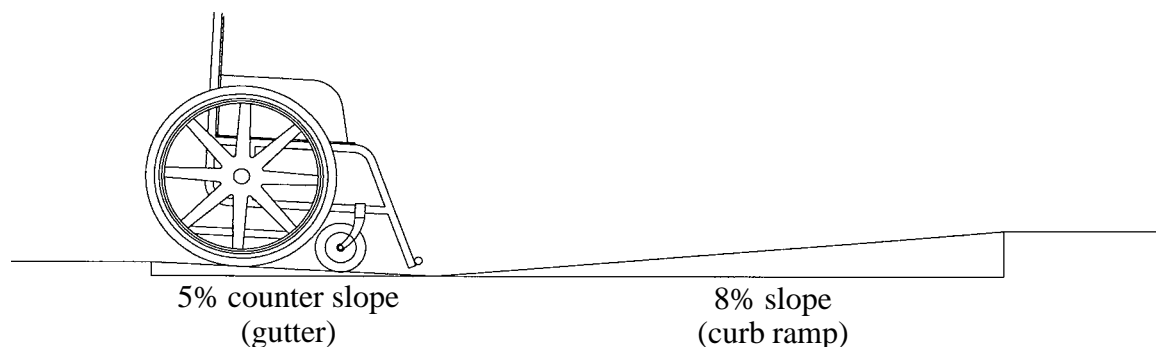
**Figure 4-1:**

**Maximum grades can make a sidewalk difficult to traverse, even if the overall running grade is moderate.**



**Figure 4-2:**

**The gutter slopes counter to the slope of the curb ramp to promote drainage.**



should not exceed 13 percent. An example of a 13 percent change in grade occurs at a curb ramp if the slope of the gutter is 5 percent and the slope of the curb ramp is 8 percent (Figure 4-2).

If the rate of change of grade exceeds 13 percent over a 0.610 m (2 ft) interval, the ground clearance of the footrests and or antitip wheels might be compromised. Antitip wheels are placed on the back of some wheelchairs to improve stability and prevent tipping. Even wheelchair users traveling slowly can get stuck if the footrest or antitip wheels get caught.

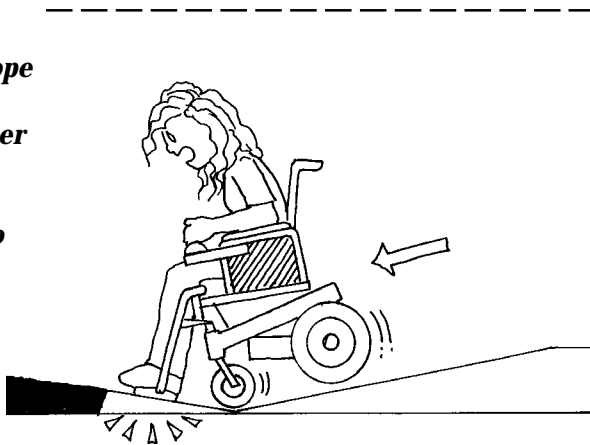
If the rate of change of grade exceeds 13 percent, the dynamic stability of the sidewalk user can also be significantly

compromised, depending on the speed at which the wheelchair user goes through the curb ramp. Dynamic stability is compromised because the negative slope of the gutter causes the wheelchair to rotate forward. However, upon reaching the bottom of the transition, the wheelchair begins to pitch back rapidly as the wheelchair travels up onto the positive slope in front of the chair (Figure 4-3). Rapid changes in grade can also cause a wheelchair user traveling with speed to flip over backward, as illustrated in Figure 4-4. Any amount of height transition between the curb ramp and the gutter can intensify problems for wheelchair users.

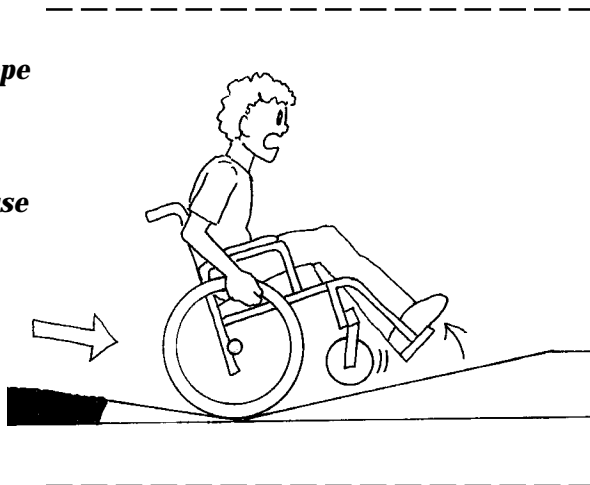
*Counter slope* is defined as a grade that is opposite to the general running grade of a path. For example, at a curb ramp, the slope of the gutter is generally counter to the slope of the ramp (Figure 4-2). According to ADAAG, the counter slope to a curb ramp should not exceed 5 percent (ADAAG, U.S. Access Board, 1991). If the counter slope of a curb ramp exceeds 5 percent, the rate of change of grade is likely to exceed 13 percent, depending upon the grade of the ramp.

The guidelines and recommendations that were reviewed for running grade and maximum grade are included in Tables 4-2.1 through 4-2.4, located at the end of this chapter. ADAAG and UFAS specify that the maximum grade of an accessible route on a building site be no more than 8.33 percent with a maximum rise of 0.760 m (30 in). Grades greater than 5 percent require handrails and level landings at least 1.525 m (60 in) wide. If the ramp turns, the landing dimensions should be 1.525 m x 1.525 m (60 in x 60 in). A ramp with level landings at both ends is illustrated in Figure 4-5. The distance between level landings is dependent on the grade of the ramp. For example, if the ramp grade is 8.33 percent, a level landing is required at least every 9.1 m (30 ft). However, if the grade of

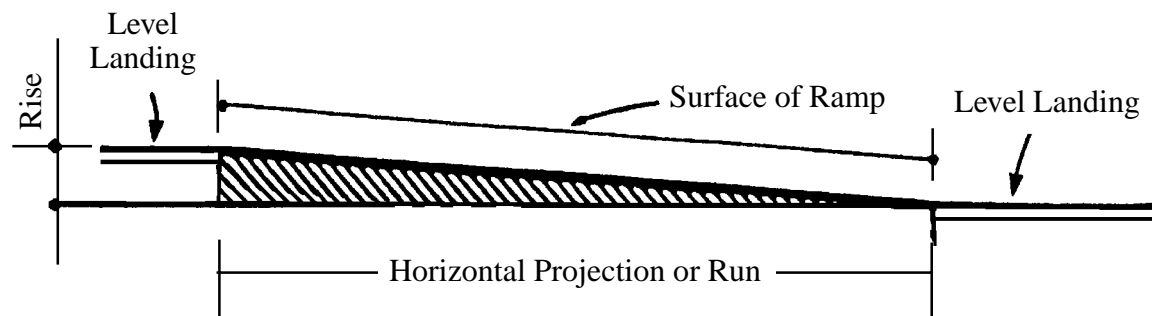
**Figure 4-3:**  
**Excessive slope differences between gutter and ramp can cause a wheelchair to tip forward.**



**Figure 4-4:**  
**Excessive slope differences between a gutter and a ramp can cause wheelchairs to flip over backward.**



**Figure 4-5:**  
**Ramps must have level landings**  
 (based on ADAAG Figure 16, U.S. Access Board, 1991).



the ramp is 6.5 percent, a level landing is required only every 12 m (40 ft). (ADAAG, U.S. Access Board, 1991; UFAS, U.S. DoD et al., 1984). Level landings provided at regular intervals allow wheelchair users and others a place to rest, turn around, and gain relief from prevailing grade demands. Level landings at storefronts and driveway crossings can also provide valuable resting spots for sidewalk users.

The *AASHTO Green Book* recommends that the running grade of sidewalks be consistent with the running grade of adjacent roadways. Section 14.2.1 (2a) in ADAAG proposed Section 14 (1994), now reserved, permits the running grade of the sidewalk to be consistent with the grade of adjacent roadways but recommends that the minimum feasible slope be used (U.S. Access Board, 1994b). State guidelines examined concur with the Federal accessibility standards, proposed Section 14 (1994), or the *AASHTO Green Book*.

### 4.3.2 Cross-Slope

*Cross-slope* is defined as the slope measured perpendicular to the direction of travel. Unlike grade, cross-slope can be measured only at specific points. Steep cross-slopes can make it difficult for wheelchair or crutch users to maintain lateral balance and can cause wheelchairs

to veer downhill or into the street. Cross-slope is determined by taking measurements at intervals throughout a section of sidewalk and then averaging the values.

*Running cross-slope* is defined as the average cross-slope of a contiguous section of sidewalk. Often within the typical running cross-slope, there are inaccessible *maximum cross-slopes* that exceed the running cross-slope. The distance over which a maximum cross-slope occurs significantly influences how difficult a section of sidewalk is to negotiate.

*Rate of change of cross-slope* is defined as the change in cross-slope over a given distance. Rate of change of cross-slope can be measured by placing a digital level a specified distance before and after a maximum cross-slope. The specified distance should be about 0.610 m (2 ft) to represent the approximate stride of a pedestrian or the wheelbase of a wheelchair.

A cross-slope that changes so rapidly that there is no planar surface within 0.610 m (2 ft) could create a safety hazard. As the wheelchair moves over a surface that is severely warped, it will first balance on the two rear wheels and one front caster. As the wheelchair moves forward, it then

tips onto both front casters and one rear wheel. This transition could cause the wheelchair user to lose control and tip over.

Proposed Section 14 (1994) specifies that sidewalks should lie in a continuous plane with a minimum of surface warping. Nonplanar surfaces are frequently found at driveway crossing flares and curb ramps without landings. Rapidly changing cross-slopes can cause one wheel of a wheelchair or one leg of a walker to lose contact with the ground (Figure 4-6) and also can cause walking pedestrians to stumble or fall.

Most sidewalks are built with some degree of cross-slope, to allow water to drain into the street and to prevent water from collecting on the path. Water puddles pose a slipping hazard to sidewalk users and are even more difficult to negotiate when frozen into ice sheets in colder climates.

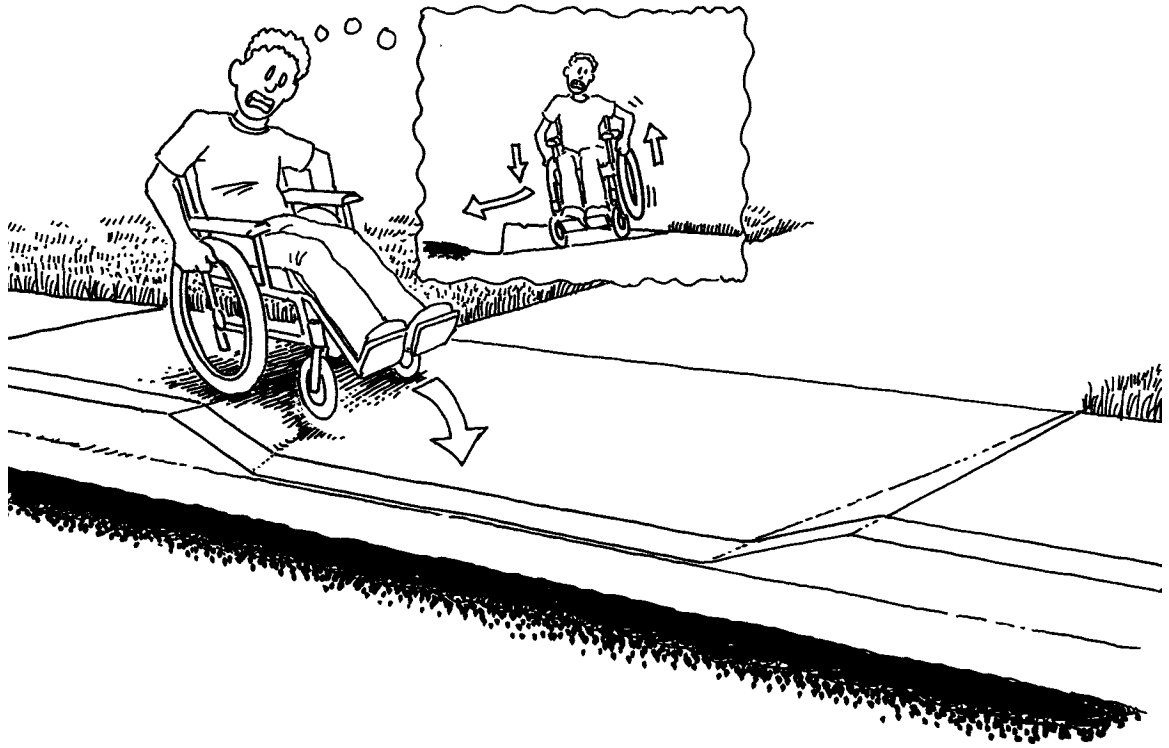
The guidelines and recommendations that were reviewed for running cross-slope are

included in Tables 4-2.1 through 4-2.4 at the end of this chapter. ADAAG and the State pedestrian facility guidelines reviewed for this report do not permit cross-slopes to exceed 2 percent. The *AASHTO Green Book* requires the cross-slope of roads to be at least 1.5 percent to permit adequate drainage. The *AASHTO Green Book* does not provide cross-slope specifications for sidewalks. No guidelines or recommendations for maximum cross-slopes on sidewalks were identified.

### 4.3.3 Width

The widths of sidewalks not only affect pedestrian usability but also determine the types of access and other pedestrian elements that can be installed. For example, a 1.525-m (60-in) sidewalk is probably wide enough to accommodate pedestrian traffic in a residential area, but a much wider sidewalk would be necessary to include amenities such as street furniture or newspaper stands. *Design width* is defined as the width

**Figure 4-6:**  
**When cross-slopes change rapidly over a short distance, wheelchair use becomes extremely unstable.**



specification the sidewalk was intended to meet; it extends from the curb or planting strip to any buildings or landscaping that form the opposite borders of the sidewalk. *Minimum clearance width* is defined as the narrowest point on a sidewalk. An inaccessible minimum clearance width is created when obstacles such as utility poles protrude into the sidewalk and reduce the design width. A reduction in the design width could also create a minimum clearance width.

Although most guidelines require sidewalk design widths to be at least 1.525 m (60 in) wide, larger design widths can accommodate more pedestrians and improve ease of access. The *AASHTO Green Book*, the Oregon Department of Transportation guidebook, and other guidelines recommend wider design widths in areas with high volumes of pedestrians. The sidewalk width often depends on the type of street. In general, residential streets have narrower sidewalks than commercial streets.

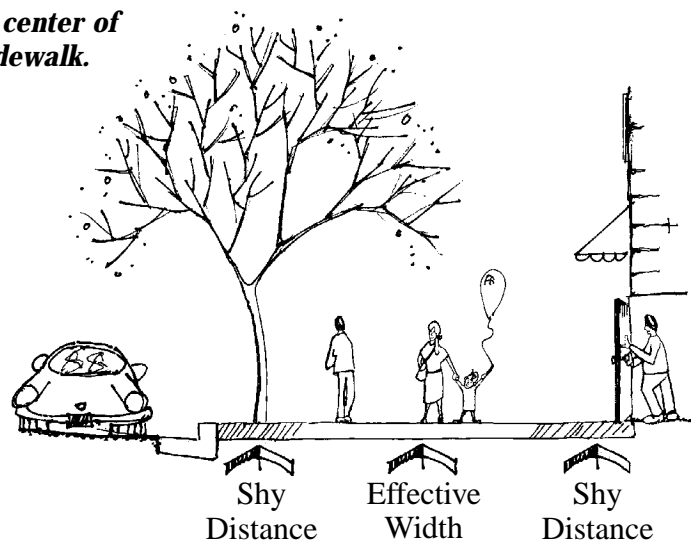
The guidelines and recommendations that were reviewed for minimum clearance width are included in Tables 4-2.1 through 4-2.4 at the end of this chapter. Most of the guidelines reviewed concur with ADAAG, which specifies that the minimum passage width for wheelchairs should be 0.815 m (32 in) at a point and 0.915 m (36 in) continuously (ADAAG, U.S. Access Board, 1991). Additional width is necessary for turning and maneuvering.

The width of the sidewalk is also affected by pedestrian travel tendencies. Pedestrians tend to travel in the center of sidewalks to separate themselves from the rush of traffic and avoid street furniture, vertical obstructions, and other pedestrians entering and exiting buildings. Pedestrians avoid the edge of the sidewalk close to the street because it often contains utility poles, bus shelters, parking meters, sign poles, and other street furniture. Pedestrians also avoid traveling

in the 0.610 m (24 in) of the sidewalk close to buildings to avoid retaining walls, street furniture, and fences (OR DOT, 1995). The sidewalk area that pedestrians tend to avoid is referred to as the *shy distance*. Taking into account the shy distance, only the center 1.830 m (6 ft) of a 3.050-m (10-ft) sidewalk is used by pedestrians for travel, as shown in Figure 4-7. Thus, the effective width of a sidewalk, not the design width, constitutes the sidewalk area needed to accommodate anticipated levels of pedestrian traffic.

When right-of-way is acquired for sidewalk construction, it is important that adequate width be included to make the facility accessible. If sidewalks are not currently included, the agency responsible for sidewalk construction might consider purchasing additional right-of-way to anticipate future construction. When improving existing facilities, designers should consider purchasing additional right-of-way or narrowing the vehicle portion of the roadway.

**Figure 4-7:**  
**Most pedestrians prefer to travel in the center of the sidewalk.**





### 4.3.4 Passing Space and Passing Space Interval

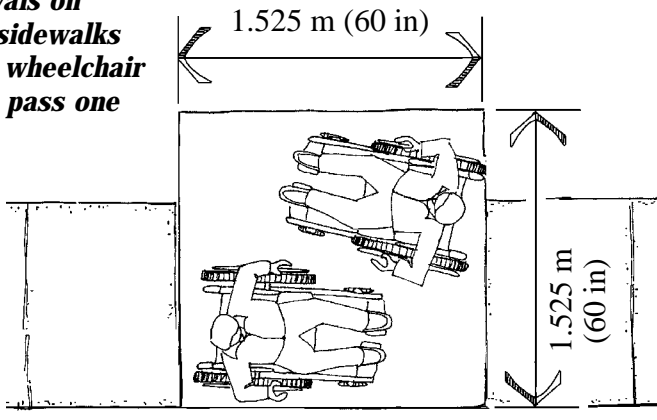
*Passing space* is defined as a section of path wide enough to allow two wheelchair users to pass one another or travel abreast (Figure 4-8). The passing space provided should also be designed to allow one wheelchair user to turn in a complete circle (Figure 4-9).

*Passing space interval* is defined as the distance between passing spaces. Passing

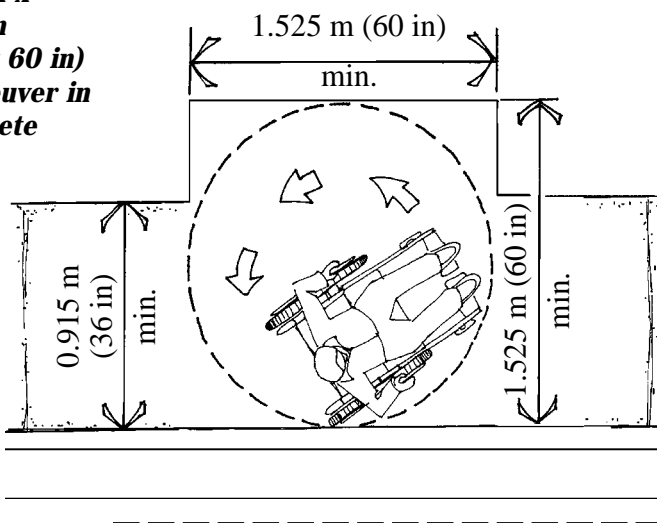
spaces should be provided when the sidewalk width is narrow for a prolonged extent because of a narrow design width or continuous obstacles.

Many agencies and private organizations do not provide guidelines for passing space or passing space intervals. Those that do provide guidelines concur with ADAAG Section 4.3.4, which specifies that accessible routes with less than 1.525 m (60 in) of clear width must provide passing spaces at least 1.525 m (60 in) wide at reasonable intervals not exceeding 61 m (200 ft). If turning or maneuvering is necessary, a turning space of 1.525 m x 1.525 m (60 in x 60 in) should be provided (ADAAG, U.S. Access Board, 1991).

**Figure 4-8:**  
*Passing spaces should be included at intervals on narrow sidewalks to allow wheelchair users to pass one another.*



**Figure 4-9:**  
*Wheelchair users require 1.525 m x 1.525 m (60 in x 60 in) to maneuver in a complete circle.*



### 4.3.5 Vertical Clearance

*Vertical clearance* is defined as the minimum unobstructed vertical passage space required along a sidewalk. Vertical clearance is often limited by obstacles such as building overhangs, tree branches, signs, and awnings.

The guidelines and recommendations that were reviewed for minimum allowable vertical clearance are included in Tables 4-2.1 through 4-2.4 at the end of this chapter. The majority of guidelines require a minimum of 2.030 m (80 in) of unobstructed vertical passage space. However, Oregon and Pennsylvania require 2.1 and 2.4 m (83 and 94 in) of vertical passage space, respectively (OR DOT, 1995; PA DOT, 1996). ADAAG states that circulation spaces, such as corridors, should have at least 2.030 m (80 in) of head room. ADAAG further specifies that if the vertical clearance of an area next to a circulation route is less than 2.030 m (80 in), elements that project into the circulation space must be protected by a barrier to warn people who are visually disabled or blind (ADAAG, U.S. Access Board, 1991).

### 4.3.6 Changes in Level

*Changes in level* are defined as vertical height transitions between adjacent surfaces or along the surface of a path. In the sidewalk environment, curbs without curb ramps, cracks (Figure 4-10), and dislocations in the surface material are common examples of changes in level. Changes in level also can result at expansion joints between elements such as curb ramps and gutters.

Changes in level can cause ambulatory pedestrians to trip or catch the casters of a manual wheelchair, causing the chair to come to an abrupt stop. People who are blind or who have low vision might not anticipate changes in level such as a buckling brick sidewalk.

The following conditions were observed to cause changes in level:

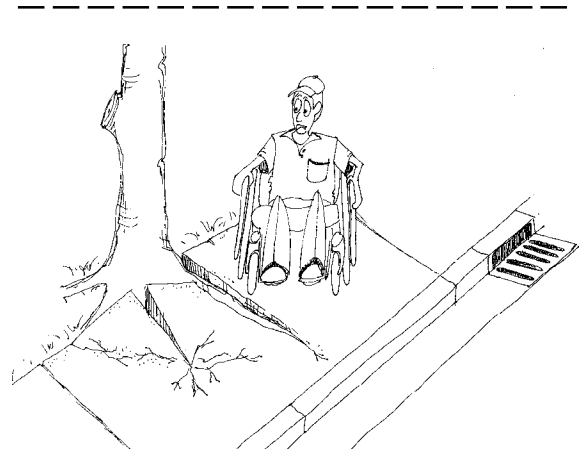
- Buckled bricks
- Cracks
- Curbs without ramps
- Drainage grates
- Grooves in concrete
- Heaving and settlement due to frost
- Lips at curb ramp frames
- Railroad tracks
- Roots
- Small steps
- Tree grates
- Uneven transitions between streets, gutters, and ramps

The guidelines and recommendations that were reviewed for changes in level are included in Tables 4-2.1 through 4-2.4 at the end of this chapter. The Federal accessibility standards permit changes in level less than 6 mm (0.25 in) high to be vertical but require changes in level between 6 mm and 13 mm (0.25 in and 0.50 in) to have a maximum bevel of 50 percent, as shown in Figure 4-11. A ramp is required for changes in level that exceed 13 mm (0.50 in) (US DOJ, 1991; UFAS, U.S. DoD et al., 1984).

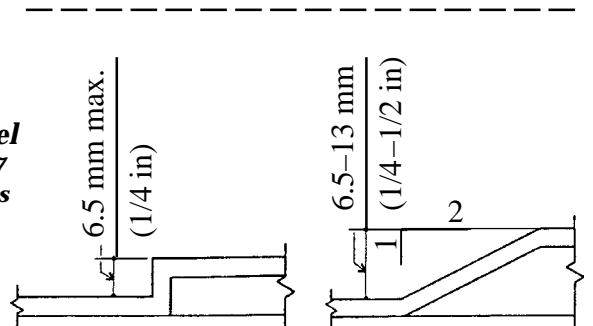
### 4.3.7 Grates and Gaps

A *grate* is a framework of latticed or parallel bars that prevents large objects from falling through a drainage inlet but permits water and some debris to fall through the slots (Figure 4-12). A *gap* is defined as a single channel embedded in the travel surface of a path. Gaps are often found at intersections where railroad tracks are embedded into the road surface.

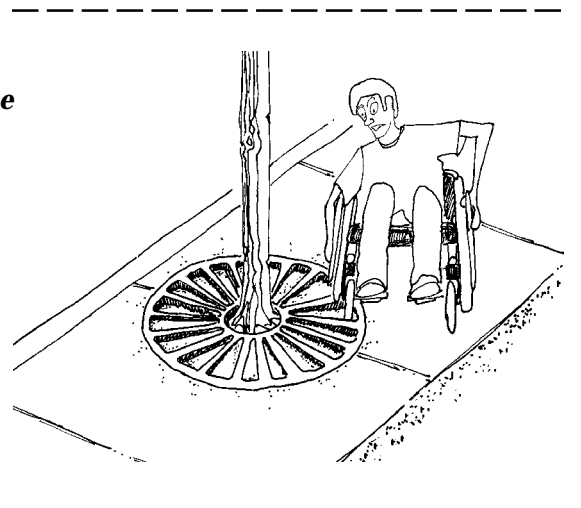
**Figure 4-10:**  
*Changes in level are often caused by tree roots that break through the sidewalk surface.*



**Figure 4-11:**  
*Vertical and beveled changes in level [ADAAG, Figure 7 (c, d), U.S. Access Board, 1991].*



**Figure 4-12:**  
*Wheelchair casters and cane and crutch tips can easily get caught in wide grates.*



Wheelchair casters and crutch tips can get caught in poorly aligned grate and gap openings. ADAAG specifies that grates located in walking surfaces should have spaces no greater than 13 mm (0.5 in) wide in one direction. It also states that gratings with elongated openings should be oriented so that the long dimension is perpendicular to the dominant direction of travel (ADAAG, U.S. Access Board, 1991). Although ADAAG does not directly address gaps, the similarity of a gap to a single grate slot suggests that ADAAG’s grate specifications also apply to gaps.

### 4.3.8 Obstacles and Protruding Objects

*Obstacles* in the pedestrian environment are defined as objects that limit the vertical passage space, protrude into the circulation route, or reduce the clearance width of the sidewalk. Obstacles with large overhangs that protrude into the path of travel can be hazardous for people with visual impairments if they are difficult to detect. The full width of the circulation path should be free of protruding objects. Obstacles that reduce the minimum clearance width, such as decorative

planters on a narrow sidewalk, can create significant barriers for wheelchair or walker users.

Most guidelines for accessibility concur with the ADAAG specifications for protruding objects. ADAAG states that objects projecting from walls that have leading edges between 0.685 m and 2.030 m (27 in and 80 in) should not protrude more than 100 mm (4 in) into walks and passageways. Freestanding objects mounted on posts or pylons may overhang a maximum of 0.305 m (12 in) from 0.685 m to 2.030 m (27 in to 80 in) above the ground (ADAAG, U.S. Access Board, 1991), as shown in Figure 4-13.

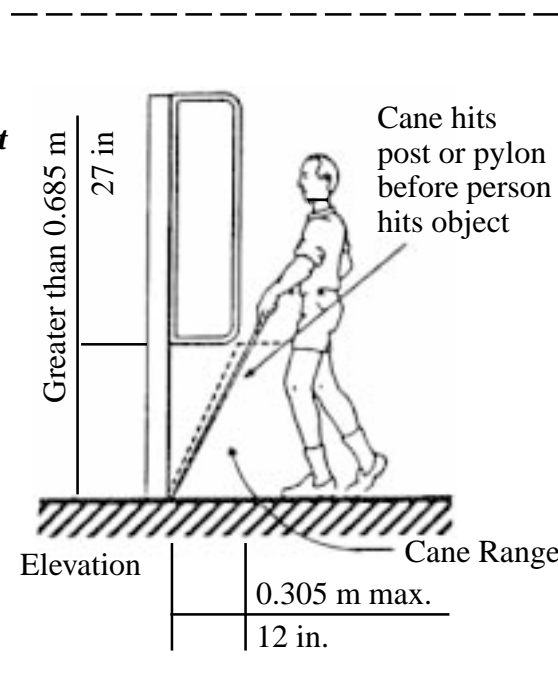
During the sidewalk assessments, potential obstacles and protruding objects were measured as they occurred along the sidewalk. Characteristics of obstacles measured in the sidewalk assessment include height, amount of overhang over the supporting structure (if any), and minimum clearance width around the obstacle.

The following objects can make a sidewalk difficult for some users to traverse if they protrude into the pathway or reduce the vertical or horizontal clear space:

- Awnings
- Benches
- Bike racks
- Bollards
- Cafe tables and chairs
- Drinking fountains
- Fire hydrants
- Folding business signs
- Grates
- Guy wires
- Landscaping
- Mailboxes (public and private)
- Newspaper vending machines

**Figure 4-13:**

**Obstacles mounted on posts should not protrude more than 0.305 m (12 in) into a circulation corridor**  
[ADAAG, Figure 8(d), U.S. Access Board, 1991].



- Parking meters
- Planters
- Public telephones (mounted)
- Puddles
- Signal control boxes
- Sign poles
- Snow
- Street vendors' carts
- Street light poles
- Street sculptures
- Telephone booths
- Telephone/utility poles and their stabilizing wires
- Traffic sign poles
- Transit shelters
- Trash bags and cans
- Tree, bush, and shrub branches
- Utility boxes

### 4.3.9 Surface

*Surface* is defined as the material on which a person walks or wheels in the pedestrian environment. The type of surface often determines how difficult an area is to negotiate. For example, wood floors can be traversed without much difficulty by most people, while a gravel surface can be impossible for some people, especially wheelchair users, to cross. Surfaces in sidewalk environments are generally concrete or asphalt but commonly include tile, stone, and brick.

Most guidelines for accessibility adhere to ADAAG, which defines accessible surfaces as firm, stable, and slip-resistant. Firm and stable surfaces resist deformation, especially by indentation or the movement of objects. For example, a firm and stable surface, such as concrete, resists indentation from the forces applied by a walking person's feet and reduces the rolling resistance experienced by a wheelchair (U.S. Access Board, 1994a). When a

pedestrian or wheelchair user crosses a surface that is not firm or stable, energy that would otherwise cause forward motion deforms or displaces the surface instead.

A slip-resistant surface provides enough frictional counterforce to the forces exerted in ambulation to permit effective travel (*ibid.*). For example, a slip-resistant surface prevents a person's shoes, crutch tips, or tires from sliding across the surface while bearing weight. A broom finish is used on many concrete sidewalks to provide sufficient slip resistance for pedestrians. The *AASHTO Green Book* requires sidewalks to have all-weather surfacing. The surface texture of curb ramps should be coarse enough to provide slip resistance when wet.

Although asphalt and concrete are the most common surfaces for sidewalks, many sidewalks are designed using brick or cobblestones. Although these surfaces are decorative, they increase the amount of work required for mobility. In addition, brick and cobblestone have inherent changes in level that are often tripping hazards. Alternatives to brick sidewalks include colored concrete stamped to look like brick, and asphalt or concrete paths with brick trim. Both alternatives preserve the decorative quality of brick but are easier for people with disabilities to negotiate.

## 4.4 Sidewalk Elements

### 4.4.1 Curb Ramps

Curb ramps provide critical access between the sidewalk and the street for people with mobility impairments. Without curb ramps, people who use wheelchairs cannot access the sidewalk. Curb ramps are most commonly found at intersections but may also be used at midblock crossings and medians. The implementing regulations for Title II of the ADA require curb ramps to be included in all new construction of sidewalks. The

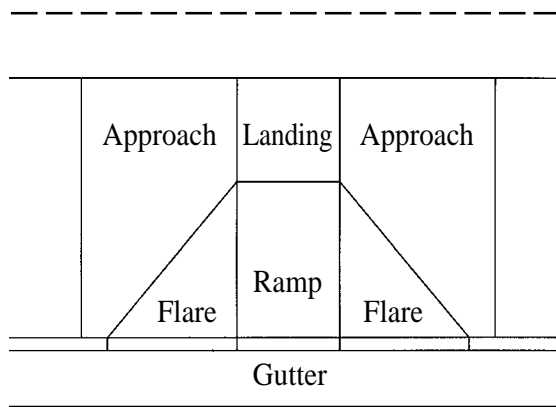
regulations also require curb ramps to be installed where existing pedestrian walkways cross a curb or other barrier (US DOJ, 1994b). Although no city surveyed has installed curb ramps in all existing pedestrian walkways, some cities have initiated aggressive plans calling for up to 500 curb ramp installations per year.

#### 4.4.1.1 Curb ramp components

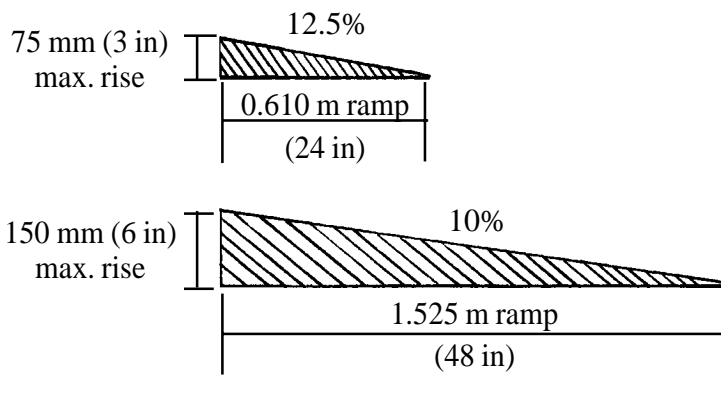
Although there are a variety of curb ramp designs, each type of curb ramp comprises some or all of the following elements, which are illustrated in Figure 4-14:

- **Landing** — level area of sidewalk at the top of a curb ramp facing the ramp path.

**Figure 4-14:**  
**Components of a curb ramp.**



**Figure 4-15:**  
**Alternative slope profiles for alterations when an 8.33 percent slope is not achievable.**



- **Approach** — section of the accessible route flanking the landing of a curb ramp. The approach may be slightly graded if the landing level is below the elevation of the adjoining sidewalk.
- **Flare** — sloped transition between the curb ramp and the sidewalk. The path along the flare has a significant cross-slope and is not considered an accessible path of travel. When the sidewalk is set back from the street, returned curbs often replace flares (see Figure 4-20, p. 44).
- **Ramp** — sloped transition between the street and the sidewalk where the grade is constant and the cross-slope is at a minimum (preferably less than 2 percent).
- **Gutter** — trough or dip used for drainage purposes that runs along the edge of the street and the curb or curb ramp.

#### 4.4.1.2 Curb ramp specifications

Curb ramps should be designed to minimize the grade, cross-slope, and changes in level experienced by users. Most agencies use standard drawings to design curb ramps. Some of these guidelines are compiled in Tables 4-3.1 to 4-3.4 at the end of this chapter. The majority of the guidelines reviewed agree with ADAAG Section 4.7 specifications for curb ramps.

##### 4.4.1.2.1 Ramps

According to ADAAG, the slope of a curb ramp should not exceed 8.33 percent, and the cross-slope should not exceed 2 percent. ADAAG also states that the least severe slope should be used in every situation. In retrofitting situations in which space prohibits the installation of an 8.33 percent ramp, ADAAG allows a slope between 8.33 percent and 10 percent for a maximum rise of 150 mm (6 in) or a slope between 10 percent and 12.5 percent for a maximum rise of 75 mm (3 in) (ADAAG, U.S. Access Board, 1991), as demonstrated in Figure 4-15.

Curb ramp widths should depend on the volume of pedestrian traffic at the specified intersection. Although ramp widths are permitted to vary, they must always be wide enough for comfortable use by wheelchair users. For this reason, ADAAG specifies that curb ramps should be at least 0.915 m (36 in) wide, not including the width of the flared sides (ADAAG, U.S. Access Board, 1991). The *AASHTO Green Book* states that curb ramps, a minimum of 1.0 m (39 in) wide or of the same width as the approach sidewalk, should be provided at crosswalks (AASHTO, 1995).

Curb ramps that are too wide and curb ramps with gradual slopes are difficult for pedestrians with visual impairments to detect. Adding a 0.610 m (2 ft) detectable warning at the bottom of these types of ramps will improve detectability. In many cities, grooves, which are intended to work as detectable warnings, are placed along the top of the ramp and/or on the ramp surface. However, grooves are difficult for people with visual impairments to detect. In addition, detectable warnings are most effective if placed at the location of the hazard. For sidewalks, the hazard occurs at the transition point between the sidewalk and the street. Section 4.4.2 contains additional information for pedestrians with visual impairments.

#### 4.4.1.2.2 Gutters

The slopes of adjacent gutters and streets significantly affect the overall accessibility of curb ramps. When the rate of change of grade between the gutter and the ramp exceeds 13 percent over a 0.610-m (2-ft) interval, wheelchair users can lose their balance. Any amount of height transition between the curb ramp and the gutter can compound the difficulties caused by rapidly changing grades. According to ADAAG, the slope of the road or gutter surface immediately adjacent to the curb ramp should not exceed 5 percent, and the transition between the ramp and the gutter should be smooth (ADAAG, U.S. Access Board, 1991). Section 4.3.1 contains

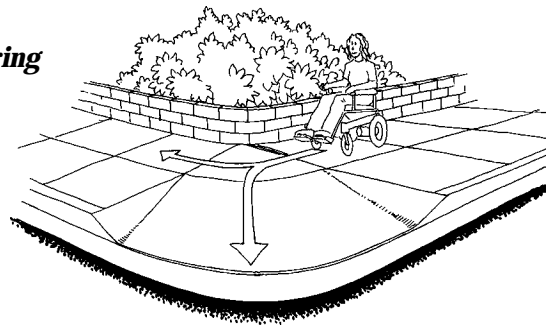
additional information on rate of change of grade.

#### 4.4.1.2.3 Landings

Curb ramp landings allow people with mobility impairments to move completely off the curb ramp and onto the sidewalk, as shown in Figure 4-16. Curb ramps without landings force wheelchair users entering the ramp from the street, as well as people turning the corner, to travel on the ramp flares (Figures 4-17 and 4-18). According to ADAAG, the landing should be a level surface at least 0.915 m (36 in)

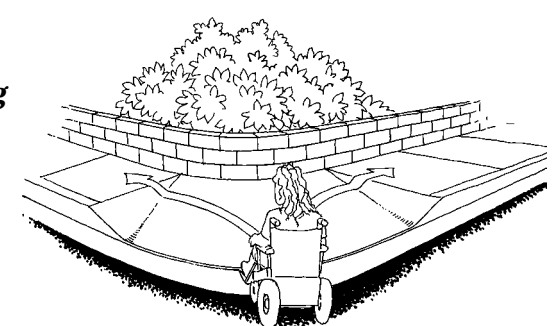
**Figure 4-16:**

***This wheelchair user is maneuvering successfully at a curb ramp because a level landing is provided.***



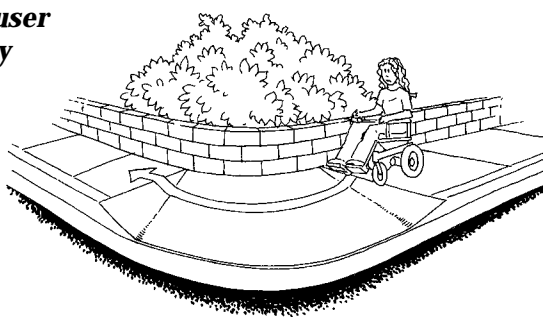
**Figure 4-17:**

***This wheelchair user will have difficulty entering the sidewalk because the curb ramp lacks a landing.***



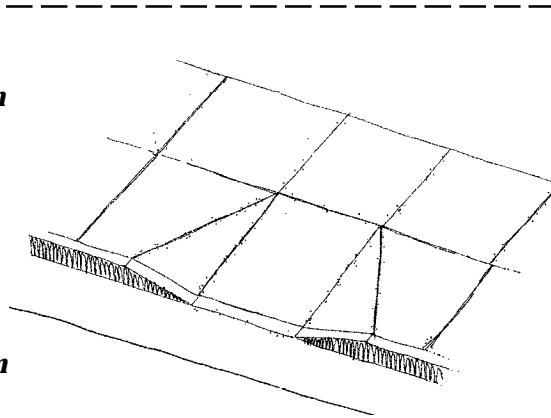
**Figure 4-18:**

***This wheelchair user will have difficulty traveling around the corner because the curb ramp lacks a landing.***

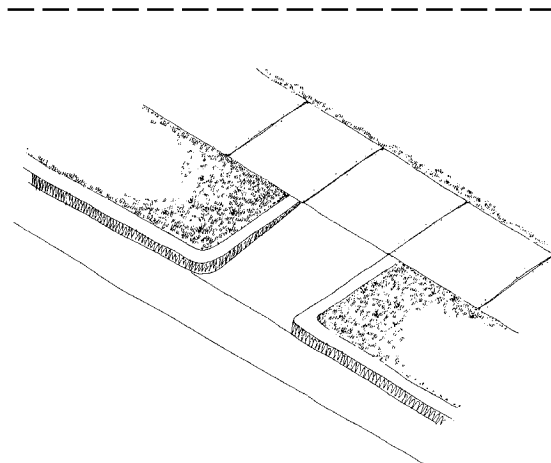


wide to prevent pedestrians from having to cross the curb ramp flare. ADAAG Section 14 (1994) recommends a 1.220-m (48-in) landing for perpendicular curb ramps and a 1.525-m (60-in) landing for parallel curb ramps (U.S. Access Board, 1994b).

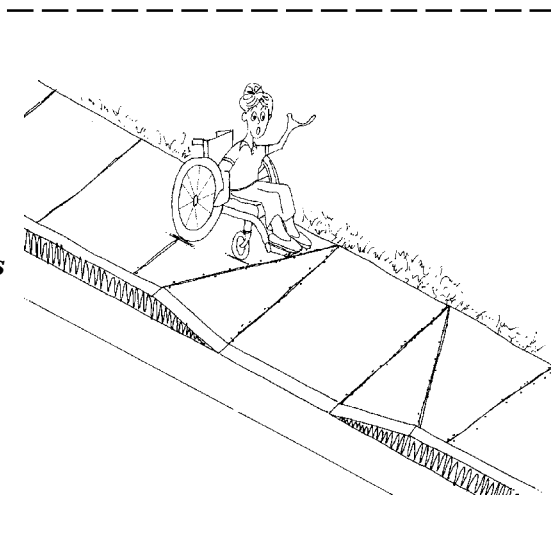
**Figure 4-19:**  
Flares provide a sloped transition between the ramp and the surrounding sidewalk and are designed to prevent ambulatory pedestrians from tripping.



**Figure 4-20:**  
Returned curbs may be used when the curb ramp is located outside the pedestrian walkway, such as in a planting strip.



**Figure 4-21:**  
Without level landings, perpendicular curb ramps are problematic for wheelchair users and others to travel across.



#### 4.4.1.2.4 Flares

The flared sides of curb ramps provide a graded transition between the ramp and the surrounding sidewalk (Figure 4-19). Flares are not considered an accessible path of travel because they are generally steeper than the ramp and often feature significant cross-slopes with excessive rate of change of cross-slope. According to ADAAG, if the landing width is less than 1.220 m (48 in), then the slope of the flares at the curb face should not exceed 8.33 percent. If the landing width is greater than 1.220 m (48 in), a 10 percent slope is acceptable (ADAAG, U.S. Access Board, 1991). If the curb ramp is located where a pedestrian might normally walk, flares are useful indicators to people with visual disabilities. Flares may be replaced with returned curbs if the curb ramp is located where a pedestrian does not have to walk across the ramp or if the sides are protected by guardrails or handrails (Figure 4-20).

#### 4.4.1.3 Curb ramp types

Curb ramps can be configured in a variety of patterns, depending on the location, type of street, and existing design constraints. Curb ramps are often categorized by their position relative to the curb line. The three most common and basic configurations are termed perpendicular, parallel, and diagonal.

##### 4.4.1.3.1 Perpendicular curb ramps

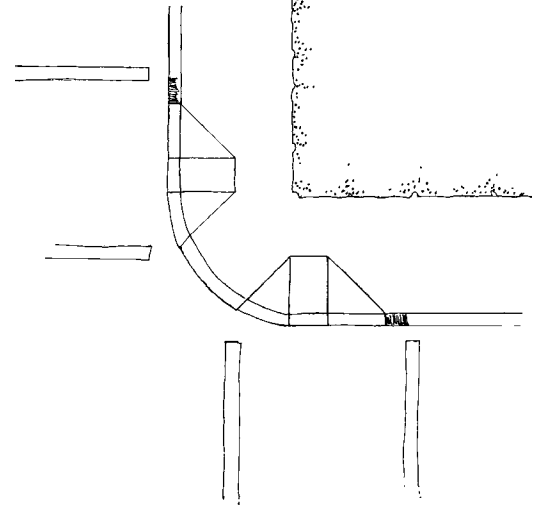
The path of travel along a perpendicular curb ramp is oriented at a 90-degree angle to the curb face. Perpendicular curb ramps are difficult for wheelchair users to negotiate if they do not have a level landing (Figure 4-21). When the sidewalk is very narrow, it can be costly to purchase additional right-of-way to accommodate a landing for perpendicular curb ramps. An alternative to purchasing more land is to extend the corner into the parking lane with a curb extension (also known as a *bulbout*). In addition

to providing space for a level landing, curb extensions calm traffic, reduce the crossing distance, and provide a larger refuge for pedestrians to congregate while waiting to cross the street (reference Section 4.4.9 for additional information on curb extensions). An additional option for providing landings is to increase the overall width of the sidewalk by adding right-of-way from the roadway. Perpendicular curb ramps are often installed in pairs at a corner (Figure 4-22). For new construction, Section 14 (1994) proposed that two perpendicular curb ramps with level landings should be provided at street crossings. This recommendation was included because two accessible perpendicular curb ramps are generally safer and more usable for pedestrians than a single curb ramp.

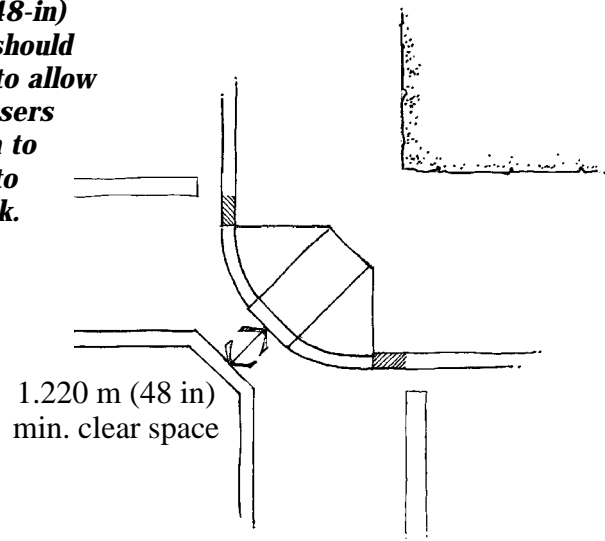
#### 4.4.1.3.2 Diagonal curb ramps

Diagonal curb ramps are single curb ramps installed at the apex of a corner (Figure 4-23). Diagonal curb ramps force pedestrians descending the ramp to proceed into the intersection before turning to the left or right to cross the street. This puts them in danger of being hit by turning cars. A marked clear space of 1.220 m (48 in) at the base of diagonal curb ramps is necessary to allow ramp users in wheelchairs enough room to maneuver into the crosswalk (Figure 4-23) (ADAAG, U.S. Access Board, 1991). A designer's ability to create a clear space at a diagonal curb ramp might depend on the turning radius of the corner. For example, a tight turning radius requires the crosswalk line to extend too far into the intersection and exposes pedestrians to being hit by oncoming traffic. In many situations, diagonal curb ramps are less costly to install than two perpendicular curb ramps. Although diagonal curb ramps might save money, they create potential safety and mobility problems for pedestrians, including reduced maneuverability and increased interaction with turning vehicles, particularly in areas with high traffic volumes. Diagonal curb ramps are not

**Figure 4-22:**  
**Two perpendicular curb ramps with level landings maximize access for pedestrians at intersections.**



**Figure 4-23:**  
**If diagonal curb ramps are installed, a 1.220-m (48-in) clear space should be provided to allow wheelchair users enough room to maneuver into the crosswalk.**



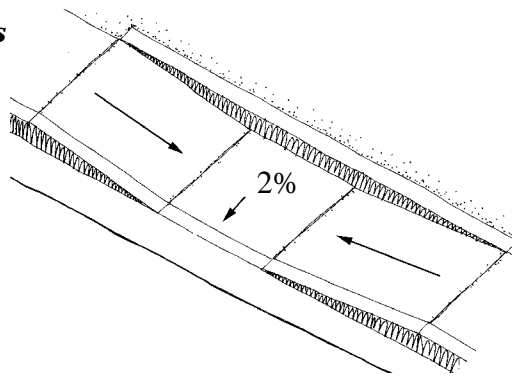
desirable in new construction but might be effective in retrofitting if there is not enough space for two accessible perpendicular curb ramps.

#### 4.4.1.3.3 Parallel curb ramps

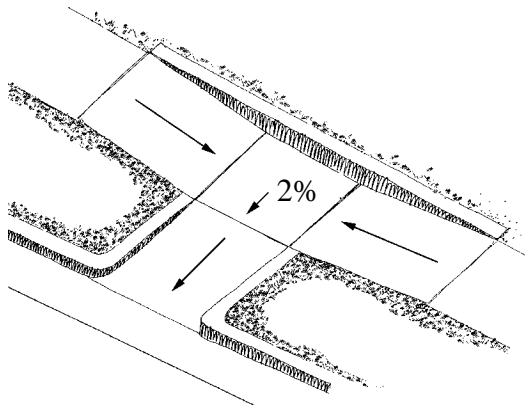
The path of travel along a parallel curb ramp is a continuation of the sidewalk, as



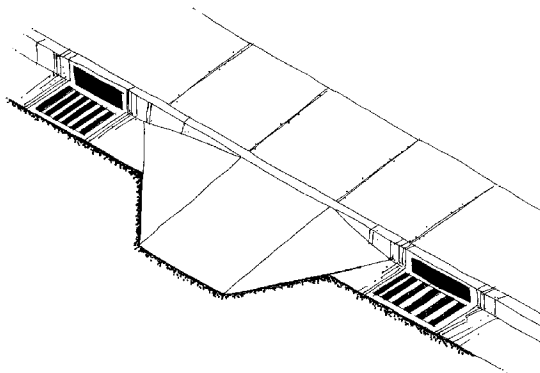
**Figure 4-24:**  
**Parallel curb ramps work well on narrow sidewalks but require users continuing on the pathway to negotiate two ramp grades.**



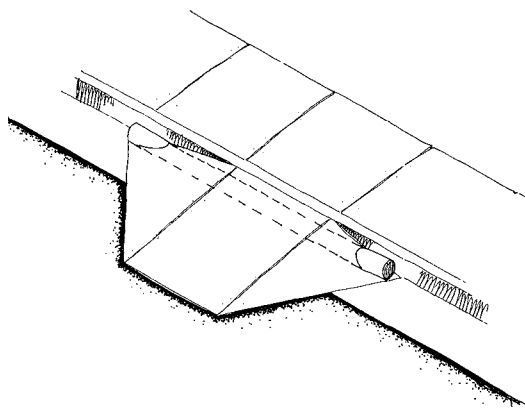
**Figure 4-25:**  
**A combination curb ramp is a creative way to avoid steep curb ramps and still provide level landings.**



**Figure 4-26:**  
**Built-up curb ramp with drainage inlets.**



**Figure 4-27:**  
**Built-up curb ramp with a drainage pipe.**



shown in Figure 4-24. Parallel curb ramps provide an accessible transition to the street on narrow sidewalks. However, if the landing on parallel curb ramps is not sloped toward the gutter (no more than 2 percent), water and debris can pool there and obstruct passage along the sidewalk. Parallel curb ramps also require those wishing to continue along the sidewalk to negotiate two ramp grades, unless a wide buffer zone permits the sidewalk to be set back behind the ramps. A combination perpendicular and parallel ramp will significantly reduce the ramp grades for people who wish to continue along the sidewalk (Figure 4-25).

#### 4.4.1.3.4 Built-up curb ramps

Built-up curb ramps are oriented in the same direction as perpendicular curb ramps but project out from the curb. For this reason, built-up curb ramps can be installed on narrow sidewalks but are most often installed in parking lots. If an edge protection is not provided on built-up curb ramps between the ramp and the sidewalk, people with visual disabilities might not be able to distinguish between the sidewalk and the street. According to ADAAG, built-up curb ramps should not extend into a vehicular traffic lane (ADAAG, U.S. Access Board, 1991). Built-up curb ramps also should not extend into bicycle lanes because they might present a hazard for cyclists.

Built-up curb ramps have additional drainage requirements because they block the gutter. Possible solutions include providing drainage inlets or placing a drainage pipe under the curb ramp (Figures 4-26 and 4-27).

#### 4.4.1.4 Curb ramp placement

In addition to specifying curb ramp designs, most transportation agencies provide specifications for their placement. Curb ramp placement can be especially complicated in retrofit situations.

Relocating or redesigning the intersection and street furniture can be expensive. Many sidewalk characteristics, including width, elevation of buildings, and position of street furniture, can affect the curb ramp design chosen. In retrofit situations in which sidewalk width is limited, parallel curb ramps might provide more gradual slopes and landings.

Curb ramps that force users to cross storm drain inlets often present hidden risks to pedestrians. The grates covering such inlets can catch the casters of wheelchairs or the tips of canes and walkers, causing falls and injuries. Water at the base of curb ramps can obscure the transition from the ramp to the gutter and cause pedestrians to misjudge the terrain. Puddles at the base of curb ramps can also freeze and cause users to slip. Locating drain inlets uphill from curb ramps will reduce the amount of water that collects at the base.

Curb ramps ending in parking spaces are not usable when blocked by parked vehicles. This situation can be prevented through parking enforcement and warning signs but perhaps more effectively through the use of curb extensions (see Section 4.4.9 for additional information on curb extensions).

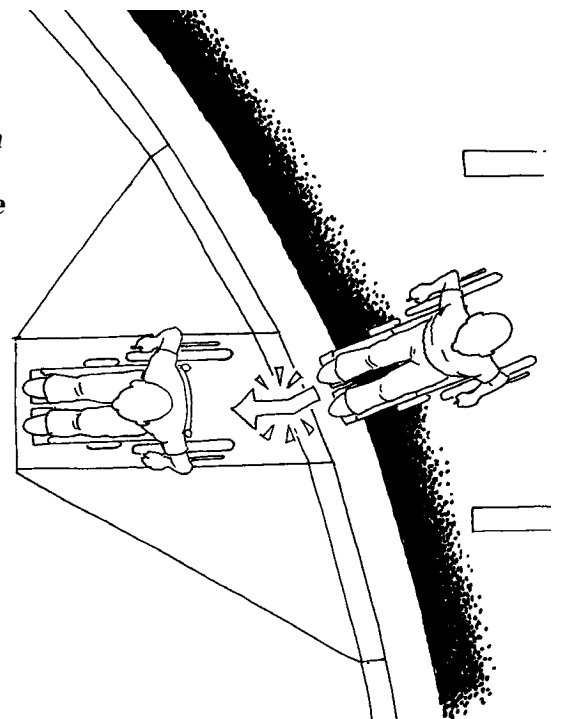
Perpendicular curb ramps should be built 90 degrees to the curb face. At a corner with a tight turning radius, a perpendicular curb ramp built 90 degrees to the curb face will be oriented toward the crosswalk. This is helpful to users because they can follow the ramp path directly across the street. Curb ramps aligned with the crosswalk also reduce the maneuvering that wheelchair users must perform to use the ramp.

At corners with larger turning radii, the curb ramp cannot always point in the direction of the crosswalk and be perpendicular to the curb face. In some cities, designers

align curb ramps parallel to the crosswalk, causing the ramp face to be skewed. This design has some benefit to people with visual impairments because they can use the path of the curb ramp to direct them across the street. However, people with visual impairments tend not to rely on the direction of curb ramps because of the abundance of diagonal curb ramps that point into the center of the street.

In addition, if the curb ramp is not perpendicular to the curb, as illustrated in Figure 4-28, wheelchair users have to negotiate changing cross-slopes and changing grades simultaneously, or they have to turn while making the grade transition. Turning at the grade transition requires a wheelchair user traveling down a curb ramp to go down one edge of the ramp and try to turn while on a significant grade. Curb ramps that are perpendicular to the curb prevent wheelchair users from

**Figure 4-28:**  
**To avoid having to negotiate changing grades and changing cross-slope simultaneously, a wheelchair user has to turn at the grade transition.**



having to turn at the ramp to a gutter transition (Figure 4-29).

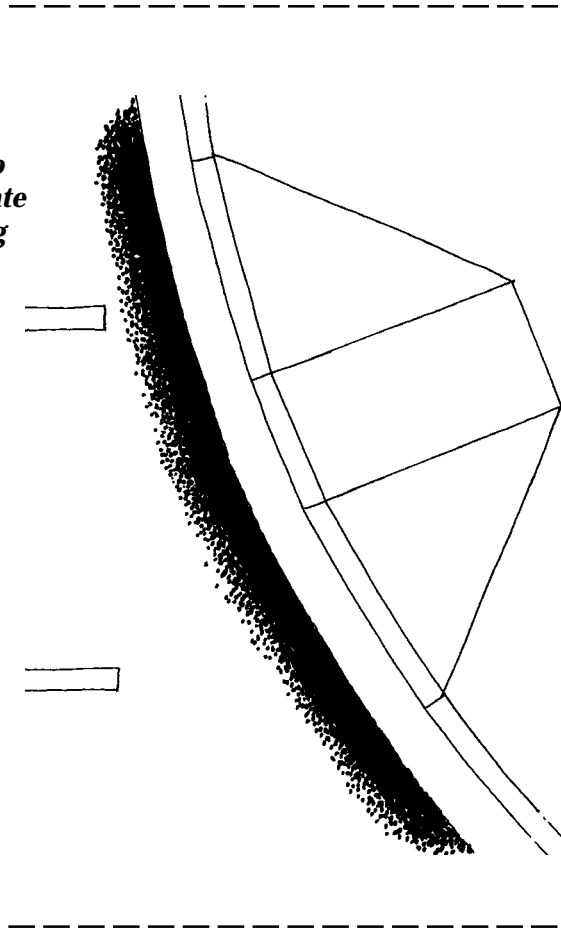
#### 4.4.1.5 Curb ramps and people with visual impairments

People with visual impairments do not use curb ramps in the same manner as people with mobility impairments. Although people with visual impairments can obtain helpful navigational cues from perpendicular curb ramps, they can learn the same information from the edge of the curb. Curb ramps and flare slopes that are steep enough relative to the grade of the surrounding sidewalk are more detectable than gradually sloped curb ramps or depressed corners (GA Institute of Technology, 1979). If people with visual impairments are unable to detect a curb ramp, they will not know that they are moving into the street. Installing detectable warnings on ramps can help people with visual impairments detect the

upcoming intersection (see Section 4.4.2). Some States also require minimum curb ramp slopes to improve detectability for people with visual impairments.

It is commonly believed that the orientation of curb ramps helps people with visual impairments determine the direction of the crosswalk. However, this technique is generally not taught or used because many curb ramps are not aligned with the path of travel across the street. The skew of diagonal curb ramps can be a particular source of confusion to people with visual impairments if other sidewalk cues present conflicting information about the intersection. Some dog-guide users interviewed for this project said they were most wary of diagonal curb ramps because their dogs might follow the curb ramp path out into the middle of the intersection. However, most people with visual impairments interviewed said that while a diagonal slope to the sidewalk indicated the presence of an intersection, they used other cues, such as the sound of traffic, to orient for the crossing.

**Figure 4-29:**  
*Curb ramps designed with the ramp perpendicular to the curb eliminate rapidly changing grades and cross-slopes at the grade transition.*



#### 4.4.2 Conveying Information to Pedestrians with Visual Impairments

All pedestrians must obtain a certain amount of information from the environment to travel along sidewalks safely and efficiently. Most pedestrians obtain this essential information visually, by seeing such cues as intersections, traffic lights, street signs, and traffic movements. People with visual impairments also use cues in the environment to travel along sidewalks. For example, the sound of traffic, the slope of curb ramps, changes in surface texture, and a shadow from an overhead awning serve as primary indicators of an upcoming intersection for people with visual impairments. Blind pedestrians also use their ability to estimate distances and directions they have walked (dead reckoning) to determine their location relative to desired destinations (Long and Hill, in Blasch et al., 1997).

Good design in the form of regularly aligned streets, simple crossing patterns, and easy-to-understand city layouts is generally the best method to provide good orientation cues for pedestrians with visual impairments. However, accessible information might be needed in some situations to supplement existing information. Locations where supplementary information is most beneficial include irregular intersections, open spaces such as plazas, raised intersections, and curb ramps with a slope less than 8.33 percent.

Some cues that people with visual impairments use are permanent, such as the edge of the curb; other cues, such as the sound of traffic, are intermittent. Although the sound of traffic is a very effective way for people with visual impairments to identify an intersection, it is unreliable because cars are not always present. Another issue that affects the usefulness of cues is a person's familiarity with the environment. For example, a person who lives near an intersection with a pedestrian-actuated control signal might be able to identify it easily because of repeated use and familiarity with its presence. However, a person who is unfamiliar with the intersection would be less likely to detect such a device. The most reliable cues for people with visual impairments are permanent and can be detected even in unfamiliar environments.

People with visual impairments should have access to the same information as sighted pedestrians when traveling in unfamiliar areas. To accommodate all pedestrians, it is important to provide information that can be assimilated using more than one sense. For example, an intersection that contains a raised tactile surface warning, a WALK signal light, and an audible pedestrian signal would be more accessible than an intersection that provides only a WALK signal light. Redundancy and multiplicity of formats increase the likelihood that people with

impairments and others will be able to make informed traveling decisions.

The most effective accessible information is easy to locate and intuitive to understand, even for pedestrians who are unfamiliar with an area. People with visual impairments stress the importance of consistency in design because accessible information added to the environment is most useful "when used in consistent locations so that the traveler can rely on their existence" and find them reliably (Peck and Bentzen, 1987). Users would benefit if each type of accessible indicator were exclusively reserved to indicate a specific situation in the pedestrian environment and consistently installed to avoid conveying conflicting and confusing information. Studies in the United Kingdom have shown that pedestrians with visual impairments can reliably detect, distinguish, and remember a limited number of different tactile paving surfaces and the distinct meanings assigned to them (Department of the Environment, Transport, and the Regions, Scottish Office, Notified Draft, 1997).

Visual, auditory, and tactile perceptual information is very useful in detecting cues and landmarks essential to wayfinding and is also important in detecting obstacles and hazards. Mobility is defined as "the act or ability to move from one's present position to one's desired position in another part of the environment safely, gracefully, and comfortably." Wayfinding is defined as "the process of navigating through an environment and traveling to places by relatively direct paths" (Long and Hill, in Blasch et al., 1997). The long cane is a primary example of an environmental probe that allows blind pedestrians to acquire perceptual information about their immediate environment systematically and efficiently. The long cane helps users establish and maintain orientation, as well as detect and avoid hazards.

Because people with visual impairments obtain information about the environment

in many ways, the most effective cues convey information in more than one format. For example, truncated domes can be detected not only by texture but by sound and color contrast as well. The greater number of sensory qualities (color, texture, resilience, and sound) the cue has, the more likely it will be detected and understood (Sanford and Steinfeld, 1985). The following are common types of accessible information added to sidewalk environments:

- Raised tactile surfaces used as detectable warnings
- Raised tactile surfaces used for wayfinding
- Materials with contrasting sound properties
- Grooves
- Contrasting colors for people with low vision
- Audible and vibrotactile pedestrian signals

#### 4.4.2.1 Raised tactile surfaces used as detectable warnings

Raised tactile surfaces used as warnings employ textures detectable with the touch of a foot or sweep of a cane to indicate

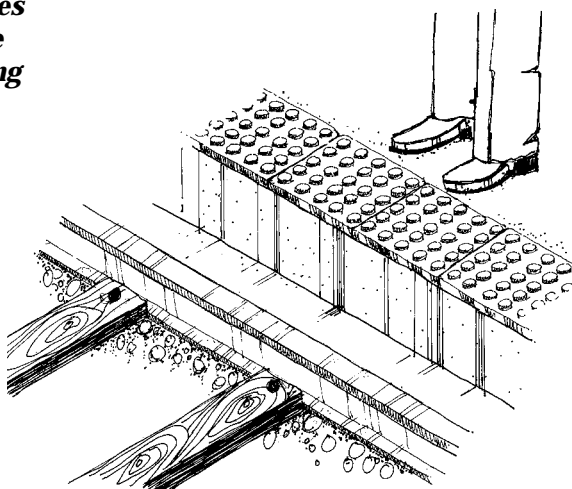
upcoming hazards or changes in the pedestrian environment. Many different types of raised tactile surfaces have been proven to be detectable by people with visual disabilities. However, tactile surfaces used as detectable warnings should meet the technical specifications in ADAAG (see Section 4.4.2.7) to avoid confusion with tactile surfaces used for wayfinding. Raised tactile surfaces include truncated domes, patterned panels, and other textured designs. Tactile surfaces used as detectable warnings must also provide color contrast with surrounding surface materials.

Raised tactile surfaces have been shown to be very effective in actual application. BART in the San Francisco Bay Area and METRO DADE transit in Miami have used raised tactile surfaces as systemwide warnings on platform edges since 1989 and have documented no instances of rider dissatisfaction with truncated dome surfaces (Figure 4-30). In contrast, the overall incidence of trips, slips, and falls at platform edges has been significantly reduced. In addition, BART riders exhibit an increased sense of drop-off awareness by tending to “stand farther from the platform edge than MUNI (San Francisco) riders standing at different tracks in the same stations but lacking detectable warnings” (Bentzen, Nolin, and Easton, 1994).

Domes with truncated tops are generally more comfortable than other dome designs for pedestrians to travel across (O’Leary, Lockwood, Taylor, and Lavelly, 1995). Low truncated domes have been used to provide warning information in a number of countries, including the United Kingdom (Department of the Environment, Transport, and the Regions, Scottish Office, Notified Draft, 1997), and Japan (Sawai, Takato, and Tauchi, 1998). In the United States, truncated domes are required at transit platform drop-offs (US DOJ, 1991; US DOT, 1991).

The detectability of raised tactile surfaces can depend upon the degree of contrast

**Figure 4-30:**  
**Truncated domes are an effective way of indicating a drop-off at transit platform.**



between the surface and the surrounding surface materials. For example, raised detectable surfaces have been shown to be significantly less detectable when located adjacent to coarse aggregate concrete (Bentzen, Nolin, Easton, Desmarais, and Mitchell, 1994). Raised surfaces are thus much more effective when placed next to smooth paving materials such as brushed concrete.

Climate can determine what type of detectable surface is most appropriate for a region. For example, ice was found to obscure the textural contrast of some raised surface materials (U.S. Access Board, 1985). Surfaces that withstand scraping by snowplows, minimize the collection of precipitation such as snow and ice, and resist degradation by snow-melting additives such as salt are most effective in colder areas. Some cities in the United States have discontinued the use of truncated domes at curb ramps because the materials used wore down quickly and could not be plowed free of snow. However, New York and New Jersey, both areas that experience significant amounts of snow and ice, continue to use raised tactile surfaces (O’Leary, Lockwood, Taylor, and Lavelly, 1995).

The length of raised tactile surfaces in the path of travel is most effective when “beyond the average stride in length” so that pedestrians with visual disabilities can “sense it physically, understand its meaning, and react appropriately” before the hazard is encountered (U.S. Access Board, 1995). However, there is a definite trade-off between the high detectability of raised tactile surfaces for people with visual disabilities and ease of movement for people with mobility disabilities (O’Leary, Lockwood, Taylor, and Lavelly, 1995).

Several researchers suggested limiting the width of detectable warnings to no more than that required to provide effective warning for people with visual impairments “given the moderately increased level of difficulty and decrease

in safety” that raised tactile surfaces on slopes pose for people with physical disabilities (Bentzen, Nolin, Easton, Desmarais, and Mitchell, 1994; Rabelle, Zabihaylo, and Gresset, 1998; Hughes, 1995). Truncated domes that are uneven or too high can cause navigation difficulties for certain sidewalk users, including some bicyclists and in-line skaters. People who use walking aids and pedestrians wearing high heels might lose some stability along ramps covered with raised tactile surfaces. Neither manual nor powered wheelchair users appear to be at significant risk of instability when traveling on ramps with raised warnings (Hughes, 1995).

#### **4.4.2.2 Raised tactile surfaces used for wayfinding**

Raised tactile surfaces also might provide wayfinding information to people with visual impairments, delineating paths across open plazas, crosswalks, and complex indoor environments such as transit stations. Wayfinding cues include raised tactile surfaces covered with bar patterns laid out in a path to indicate the appropriate walking direction, especially along routes where traditional cues such as property lines, curb edges, and building perimeters are unavailable. In Japan, bar tile has been used to direct pedestrians with visual impairments along transit stations and other heavily used pedestrian areas (Sawai, Takato, and Tauchi, 1998).

The city of Sacramento, California, uses a tactile guidestrip located in the center of some crosswalks to direct people with visual impairments across “irregular and complex” intersections. A San Francisco report recommended guidestrips at intersections with more than two streets, unusual crosswalks, right-turn lanes, diagonal crossings, exceptionally wide streets, and intersections with other unusual geometric designs (San Francisco Bureau of Engineering, 1996).

Hughes (1995) recommended that “mixed” patterns of both bar tiles and

dome tiles be developed for use on curb ramps to provide orientation, as well as warning information, at intersections. However, research in Japan indicated that subjects who were blind had difficulty distinguishing between detectable surfaces with bars and dots or domes. In fact, confusion between warning and guiding tiles was suspected as the cause of several train platform accidents in Japan (Bentzen, Nolin, and Easton, 1994).

#### 4.4.2.3 Materials with contrasting sound properties

Adjacent surfacing materials that make different sounds when tapped by a cane can also serve as navigation cues (U.S. Access Board, 1985). Examples of materials with contrasting sound properties include concrete sidewalks next to textured metal, or paving tiles next to rubberized raised tactile surfaces. Materials with contrasting sound properties are used along curb ramps, crosswalks, and transportation platforms. Contrasting materials can also be colored differently from the surrounding paving material (Figure 4-31) or textured to provide visual and tactile information as well.

Materials used to provide sound contrasts should be appropriate to the given setting. For example, materials that degrade in

harsh weather conditions or become slippery or hazardous when icy should not be installed outdoors but might be appropriate for indoor environments such as transit stations. People who use dog guides have a reduced opportunity to use sound cues, as described in this section.

#### 4.4.2.4 Grooves

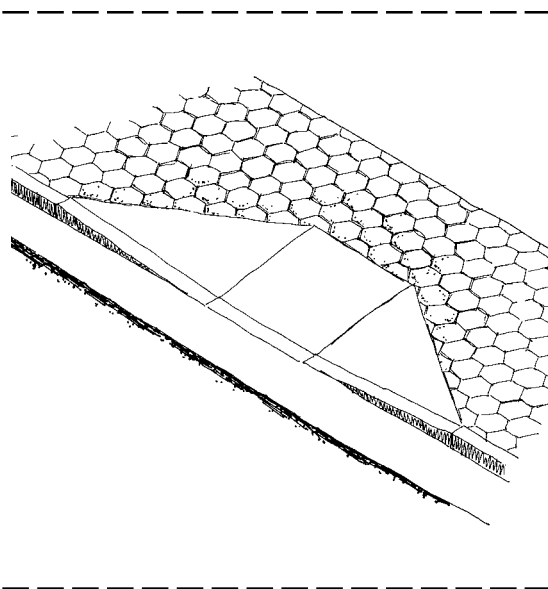
Grooves are common and inexpensive to install, but there is little evidence that they can be detected or used by people with visual disabilities. One study indicated that concrete panels with various groove configurations had only a 9 to 40 percent detectability rate (Templer, Wineman, and Zimring, 1982). Cane users could confuse them with the grooves between sidewalk panels and cracks in the sidewalk.

Long-cane users typically travel using a “two-point touch” technique and only scrape the tip of the cane along the ground in the “constant contact” technique when more in-depth exploration of an area is warranted. However, in general, grooves can be detected only by a cane if the constant-contact technique is used to scan the environment. For this reason, grooves are generally ineffective to warn of a potentially hazardous situation such as an intersection. In addition, dirt, snow, ice, weeds, and other debris in the sidewalk environment are likely to collect in grooves and obscure any warning provided.

#### 4.4.2.5 Contrasting colors for people with low vision

Contrasting colors such as yellow paint against black asphalt can indicate a change in environment for people with low vision. Texture differences may also be detected by people with low vision. For example, although sidewalk grooves do not provide a significant tactile contrast, some people with low vision can detect groove patterns visually. The color contrast of visual warnings helps both sighted and partially sighted pedestrians

**Figure 4-31:**  
**Colored stone sidewalks with concrete curb ramps have a detectable color change.**



to identify potentially hazardous areas. Colorized warnings are particularly useful for all pedestrians at night, when visual acuity and contrast sensitivity are impaired. Variations in surface coloring between the crosswalk and the street can also be used to mark the best path across an intersection. Reflective paint and building materials of contrasting colors are common methods used to provide visual warnings.

ADAAG Section 4.29.2 specifies that detectable warnings “shall contrast visually with adjoining surfaces, either light-on-dark, or dark-on-light.” ADAAG Section A4.29.2 further specifies that “the material used to provide contrast should contrast by at least 70%” (ADAAG, U.S. Access Board, 1991). The effectiveness of ADAAG’s recommendations for color contrast was evaluated by Bentzen, Lolin, and Easton (1994). The study concluded that the ADAAG 70 percent contrast recommendation “appears adequate to provide high visual detectability” but cautioned that minimum reflectance values should also be specified for the lighter surface to limit the effects of glare. The study also reported that surfaces colored safety yellow (ISO 3864) were most frequently chosen by low vision subjects as “most visually detectable” (Bentzen, Nolin, and Easton, 1994).

During the sidewalk assessments, visual warnings used on sidewalks were observed to include painted curb edges, tinted curb ramps, colored sidewalks (Figure 4-31), colorized raised tactile warnings, and painted crosswalks.

#### **4.4.2.6 Audible and vibrotactile pedestrian signals**

Although people with visual impairments generally rely on traffic surges to determine when it is safe to cross an intersection, additional information about crossing conditions can be very useful when traffic sounds are sporadic or masked by ambient noise, the geometry of the intersection is irregular, or acoustics

are poor. Accessible pedestrian signals can provide supplementary information, such as timing (when the signal cycle allows pedestrians to cross the street), wayfinding (which roads intersect at the junction), and orientation (the directional heading of each crosswalk). Accessible pedestrian signals are generally installed at complex intersections; intersections experiencing high volumes of turning traffic; major corridors leading to areas of fundamental importance such as post offices, courthouses, and hospitals; and places where people with visual impairments request them (Bentzen, 1998).

A number of different types of accessible pedestrian signals have been developed and were analyzed in a 1998 synthesis by B.L. Bentzen. These include audible broadcast, tactile, vibrotactile, and receiver-based systems, many of which may be integrated with each other to provide additional sources of information.

Audible traffic signals (ATs) include devices that emit audible sounds when the signal permits pedestrians to cross. ATs “comprise a warning system that alerts the pedestrian to the onset of a green light” (Hall, Rabelle, and Zabihaylo, 1994). Simple systems use a consistent sound to indicate when the signal has changed. More complex systems use one sound pattern to indicate north/south streets, and another sound to indicate east/west streets, providing both timing and orientation information. Others broadcast prerecorded speech messages telling the name of the street being crossed and the status of the signal cycle (Bentzen, 1998). Street crossings that can be negotiated easily by people with visual impairments are preferred to ATs systems. These systems should be installed only “as a last resort, and only when the installation will guarantee the safety of the visually impaired pedestrian” (Hall, Rabelle, and Zabihaylo, 1994).

Alternating ATs systems, in which speakers on either side of the street



alternate indicator sounds, provide alignment assistance for pedestrians with visual impairments. “An alternating signal counters the masking effect of the nearby signal [and] promotes more accurate alignment before crossing and straight-line travel throughout the crossing” (Hall, Rabelle, and Zabihaylo, 1994). Alternating ATS systems result in a straighter line of travel because they allow people with visual disabilities “to align themselves more accurately before and during the crossing. . . .” (Hall, Rabelle, and Zabihaylo, 1994).

Audible information is also useful to identify pedestrian-actuated control signals. Audible pedestrian signals that alert pedestrians to the existence and location of the signal actuator include push-button devices that emit sounds. Tactile pedestrian signals include raised arrows on the signal actuator that indicate which street is controlled by the push button. Tactile pedestrian signals can also provide map information, using raised dot and line symbols to indicate details such as the number of lanes to be crossed, the direction of traffic in each lane, and whether there is a median (Bentzen, 1998).

Vibrotactile traffic devices also can provide information about the presence and location of a pedestrian-actuated signal. In vibrotactile systems, the push-button apparatus will vibrate while pedestrians are permitted to cross. Such systems allow deaf-blind pedestrians to identify the WALK interval and can be installed at medians to prevent signal overlap when audible broadcast signals are in effect (Bentzen, 1998).

Receiver-based systems provide audible or other accessible information only when triggered by a nearby pedestrian-carried receiver. The Talking Signs® system, for example, uses transmitters that emit infrared beams containing prerecorded speech information. The speech message can label streets, transit kiosks, and other areas. The transmitters can be mounted on

traffic poles, buildings, and other significant locations. Pedestrians using the system carry a receiver that picks up the infrared signals and plays them back as audible messages. This system provides both orientation and wayfinding information. The user can hone in on the transmitter’s location because the messages are played most clearly when the receiver is oriented directly toward the transmitter (Bentzen, 1997, in Blasch et al.)

#### **4.4.2.7 ADAAG requirements for detectable warnings**

When ADAAG was first approved in 1991, it contained requirements for detectable warnings at curb ramps, transit platforms, reflecting pools, and hazardous vehicular areas. ADAAG defined a detectable warning as “a standardized surface feature built in or applied to walking surfaces or other elements to warn visually impaired people of hazards on a circulation path.” Detectable warnings on walking surfaces were required to be truncated domes with a diameter of 23 mm (0.9 in.), a height of 5 mm (0.2 in.) and a center-to-center spacing of 60 mm (2.35 in.). In addition, detectable warnings had to offer a strong visual contrast to adjacent pedestrian surfaces and had to be an integral part of the walking surface (ADAAG, U.S. Access Board, 1991).

On April 1, 1994, the ADAAG scoping provisions for detectable warnings at curb ramps, hazardous vehicular areas, and reflecting pools were initially suspended until July 1996, and were later extended until July 26, 1998, and 2001, while the requirements for detectable warnings at transit platforms remained in effect. The requirement was initially suspended to allow the U.S. Access Board, the US DOJ, and the US DOT to consider the results of additional research on the need for and safety effects of detectable warnings at vehicular–pedestrian intersections.

The study found that, although detectable warnings were not shown to be needed at all curb ramp locations, they did provide “the blind traveler with one potential additional cue that is especially useful in a low-cue environment.” Many nonvisual cues used to detect streets are intermittent, such as the sound of traffic. Detectable warning surfaces provide a permanent cue that identifies the transition between the sidewalk and the street. The study concluded that “the effectiveness of detectable warning surfaces on curb ramps depends greatly on other aspects of the design of the intersection, as well as on such social factors as the density of traffic and the skills of the traveler.” The study recommended the installation of a 2-foot-wide strip of detectable surface at the curb line as an alternative to covering the entire surface of the ramp (Hauger et al., 1996).

#### 4.4.3 Driveway Crossings

Driveway crossings permit cars to cross the sidewalk and enter the street, and they consist of the same components found in curb ramps. It is the driver’s responsibility to yield to the pedestrian at the driveway–sidewalk interface.

Intersections of driveways and sidewalks are the most common locations of severe cross-slopes for sidewalk users. Some inaccessible driveway crossings have cross-slopes that match the grade of the driveway because a level area is not provided for the crossing pedestrian. This type of crossing can be very difficult for people who use wheelchairs or walking aids (Figure 4-32).

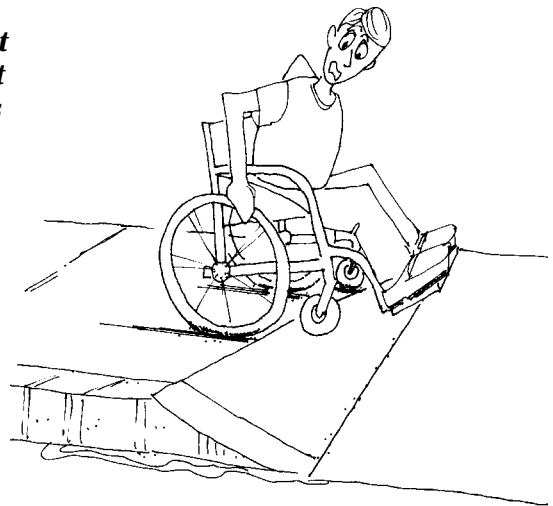
Rapid changes in cross-slope usually occur at driveway flares and are most problematic when they occur over a distance of less than 0.610 m (24 in), or the approximate length of a wheelchair wheelbase. As the wheelchair moves over the surface of a severely warped driveway flare, it will first balance on the two rear wheels and one front caster. As the

wheelchair continues to move forward, it then tips onto both front casters and one rear wheel (Figure 4-32). Rapidly changing cross-slopes also can cause wheelchair users to lose directional control, veer downhill toward the street, and potentially tip over. This phenomenon can also cause pedestrians who use walking aids to stumble. For more information on rate of change of cross-slope, refer to Section 4.3.2.

Well-designed driveway crossings eliminate severe cross-slope along the path of travel. Driveway crossings designed along setback sidewalks can easily be made accessible because the setback permits designers to maintain a level path of travel along the sidewalk. The driveway ramp then resumes sloping at the setback (Figure 4-33).

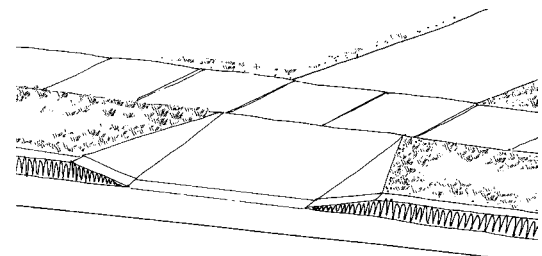
**Figure 4-32:**

***Driveway crossings without landings confront wheelchair users with severe and rapidly changing cross-slopes at the driveway flare.***

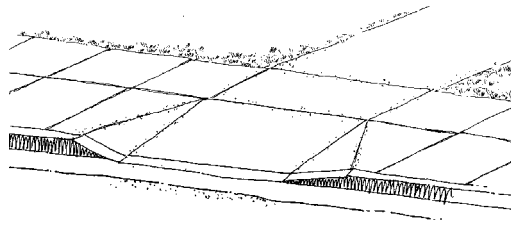


**Figure 4-33:**

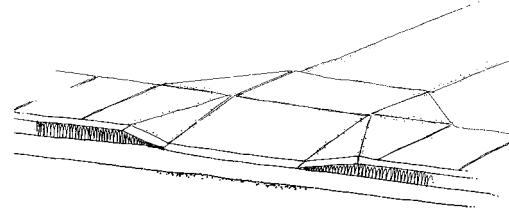
***When sidewalks have a planter strip, the ramp of the driveway does not interfere with a pedestrian’s path of travel.***



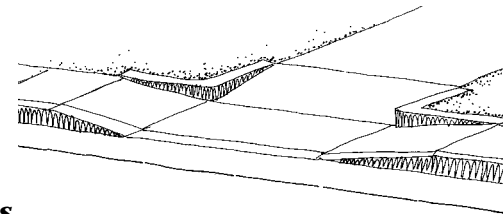
**Figure 4-34:**  
**On wide sidewalks, there is enough room to provide a ramp for drivers and retain a level landing for pedestrians.**



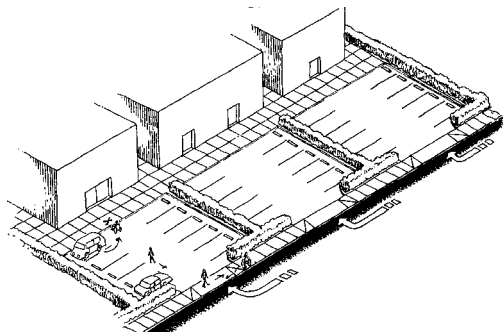
**Figure 4-35:**  
**Jogging the sidewalk back from the street provides a level landing for pedestrians on narrow sidewalks.**



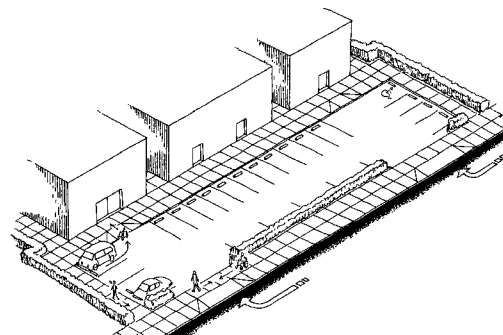
**Figure 4-36:**  
**Although parallel driveway crossings provide users with level landings, users continuing on the sidewalk are forced to negotiate two ramps.**



**Figure 4-37:**  
**Inaccessible sidewalk caused by many individual parking lots.**



**Figure 4-38:**  
**Improved accessibility created by combining parking lots and reducing the number of entrances and exits.**



Wide sidewalks can be designed similar to sidewalks with a setback if the upper portion of the sidewalk is leveled for pedestrians and the bottom portion is sloped for automobiles (Figure 4-34).

A level landing area can be achieved on narrow sidewalks if the sidewalk is jogged back from the street as it crosses the driveway (Figure 4-35). Purchasing additional land to jog the sidewalk back should be strongly considered when there is not enough space for a level sidewalk.

Similar to a parallel curb ramp, a parallel driveway crossing provides a level landing by lowering the sidewalk to the grade of the street (Figure 4-36). This design is preferable to the severe cross-slopes at some driveway crossings, but it is not as easy to negotiate as setback and wide sidewalk designs. With this type of crossing, drivers assume that they can speed up on the level portion next to the street. In addition, the parallel ramp can produce steep grades on both sides of the driveway and initiate drainage problems on the landing.

Commercial districts with front parking between the sidewalk and the buildings are often designed with a series of individual lots with individual entrances and exits (Figure 4-37). This design increases the number of driveway crossings and forces pedestrians to encounter automobiles repeatedly. If the driveway crossings do not have level landings, people with mobility disabilities must also repeatedly negotiate severe cross-slopes. To improve access for all pedestrians, including pedestrians with mobility disabilities, individual parking lots should be combined to reduce the number of entrances and exits. The remaining driveway crossings should be retrofitted to include level landings (Figure 4-38).

#### 4.4.4 Medians and Islands

Medians and islands help pedestrians cross streets by providing refuge areas that are physically separated from the automobile path of travel. A *median* separates opposing lanes of traffic. An *island* is a protected spot within a crosswalk for pedestrians to wait to continue crossing the street or to board transportation such as a bus. Medians and islands are useful at irregularly shaped intersections, such as where two roads converge into one (Earnhart and Simon, 1987).

Medians and islands reduce the crossing distance from the curb and allow pedestrians to cross during smaller gaps in traffic. Examples of cut-through medians and ramped and cut-through islands are shown in Figure 4-39 and 4-40. Medians and islands are useful to pedestrians who are unable to judge distances accurately. Medians and islands also help people with slow walking speeds cross long intersections with short signal cycles. Because medians and islands separate traffic into channels going in specific directions, they require crossing pedestrians to watch for traffic coming in only one direction.

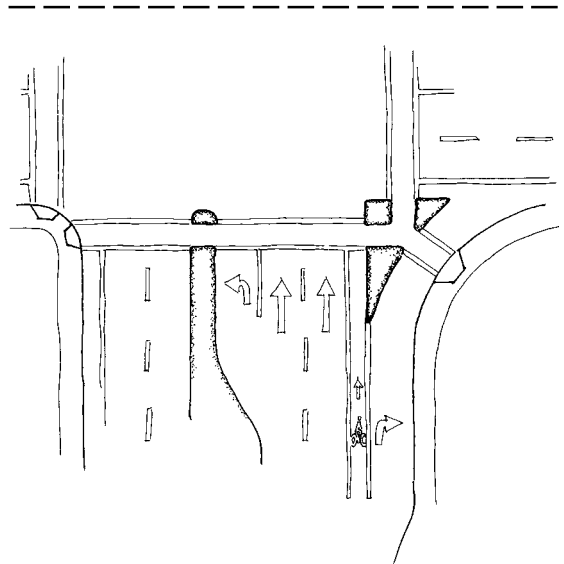
According to ADAAG, a raised island or median should be level with the street or have curb ramps at all sides and a level area 1.220 m (48 in) long in all directions. If a cut-through design is used, it should be at least 0.915 m (36 in) wide. Cut-through medians are easier for wheelchair users and other people with mobility impairments to negotiate than ramps. In addition, the edge of a cut-through can provide directional information to people with visual impairments. However, if the cut-through is too wide, people with visual impairments might not detect the presence of a median or island. For this reason, the width of the cut-through should be limited to ensure detection by people with visual impairments. A detectable warning on the surface of the cut-through will also improve detectability.

#### 4.4.5 Crosswalks

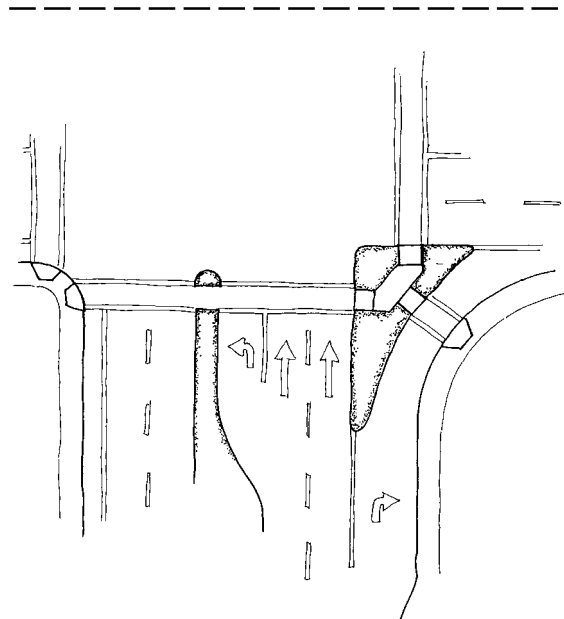
Crosswalks are a critical part of the pedestrian network. A crosswalk is defined as “the portion of a roadway designated for pedestrians to use in crossing the street” and may be either marked or unmarked (Institute of Transportation Engineers, Technical Council Committee 5A-5, 1998).

Marked crosswalks are most effective when they can be identified easily by motorists. However, many pedestrians,

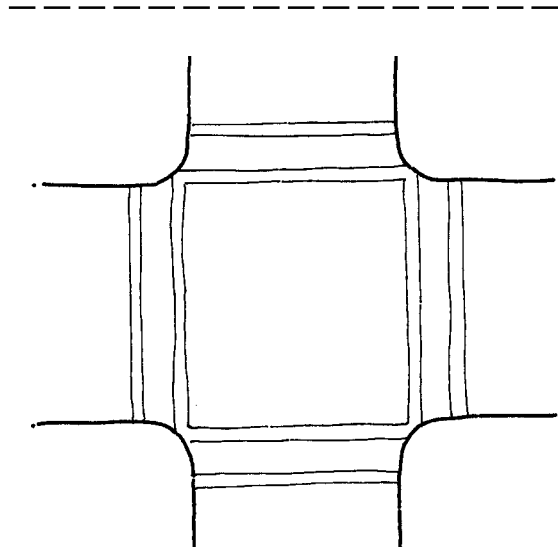
**Figure 4-39:**  
***Cut-through  
corner island  
and center  
median***  
(based on  
OR DOT, 1995).



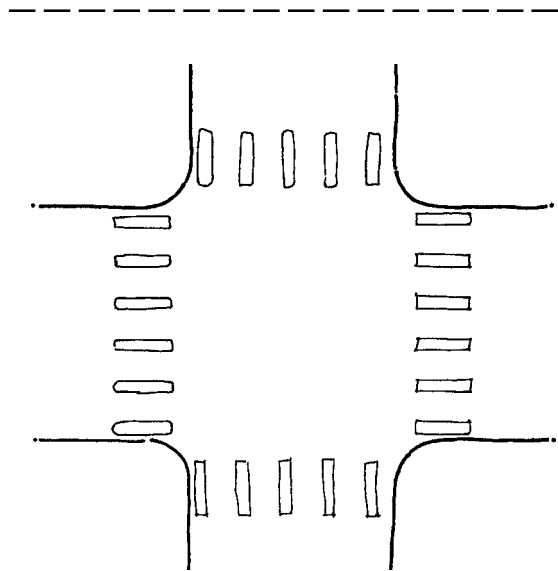
**Figure 4-40:**  
***Ramped corner  
island and  
cut-through  
median***  
(based on  
OR DOT, 1995).



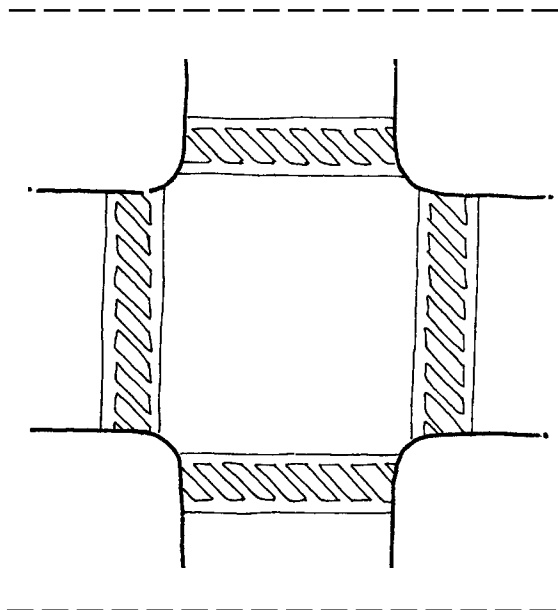
**Figure 4-41:**  
Two horizontal lines are the most common crosswalk markings.



**Figure 4-42:**  
A ladder design was found to be the most visible type of pedestrian crosswalk marking.



**Figure 4-43:**  
Diagonal markings enhance visibility.



including pedestrians with low vision, benefit from clearly marked crosswalks. For this reason, proposed Section 14 (1994) required marked crossings to be “delineated in materials or markings that provide a visual contrast with the surface of the street” (U.S. Access Board, 1994b). Most State DOTs follow the *Manual of Uniform Traffic Control Devices (MUTCD)* guidelines for marking crosswalks. Although the MUTCD does permit some variations for additional visibility, the basic specifications call for solid white lines not less than 150 mm (6 in) marking both edges of the crosswalk and spaced at least 1.830 m (72 in) apart (US DOT, 1988) (Figure 4-41). A study by Knoblauch, Testin, Smith, and Pietrucha (1988) found the ladder design, shown in Figure 4-42, to be the most visible type of crosswalk marking for drivers. Diagonal striping can also enhance the visibility of a pedestrian crossing (Figure 4-43).

When a diagonal curb ramp is used at an intersection, a 1.220-m (48-in) clear space should be provided to allow ramp users enough room to maneuver into the crosswalk.

In some situations, marked crosswalks might not be enough to ensure pedestrian safety. For example, at high-speed intersections without traffic signals, drivers often cannot perceive a marked crosswalk quickly enough to react to pedestrians in the roadway. This problem is compounded by the fact that “pedestrians may ‘feel safer’ within a marked crosswalk and expect motorists to act more cautiously” (Institute of Transportation Engineers, Technical Council Committee 5A-5, 1998). Some agencies around the United States consider that removing crosswalk markings improves pedestrian safety. Alternative treatments such as electronically activated crosswalks, pedestrian-actuated traffic controls, flashing traffic signals, light guard flashing crosswalks, traffic calming measures, raised crosswalks, and traffic

signals are also being used. FHWA studies are currently being conducted to determine if these measures provide safer crossing for pedestrians.

Most marked crosswalks observed during the sidewalk assessments were marked with paint. Others were built with contrasting materials such as red brick inside the crosswalk, bordered with gray concrete. Contrasting textures can provide tactile guidance for people with visual impairments, as well as visible colorized warnings.

#### 4.4.6 Crossing Times

People's walking pace and starting pace varies depending on their personal situation. Older pedestrians might require longer starting times to verify that cars have stopped. They also might have slower reaction times and slower walking speeds. Powered wheelchair users and manual wheelchair users on level or downhill slopes might travel faster than other pedestrians. But on uphill slopes, manual wheelchair users might have slower travel speeds. At intersections without audible pedestrian signals, people with visual impairments generally require longer starting times because they rely on the sound of traffic for signal-timing information.

The *AASHTO Green Book* indicates that "average walking speeds range from 0.8 to 1.8 m/s." The MUTCD assumes an average walking speed of 1.220 m/s (4 ft/s). However, research on pedestrian walking speeds has demonstrated that more than 60 percent of pedestrians walk more slowly and that 15 percent of pedestrians walk at less than 1.065 m/s (3.5 ft/s) (Kell and Fullerton, 1982). The *AASHTO Green Book* recommends a walking rate of 1.0 m/s (39 in/s) for older pedestrians (AASHTO, 1995).

Pedestrians of all mobility levels need to cross intersections. However, when

crossing times accommodate only people who walk at or above the average walking speed, intersections become unusable for people who walk at a slower pace. To accommodate the slower walking speeds of some pedestrians, transportation agencies should consider extending their pedestrian signal cycles. Signal timing should be determined on a case-by-case basis, although extended signal cycles are strongly recommended at busy intersections that are unusually long or difficult to negotiate.

#### 4.4.7 Pedestrian-Actuated Traffic Controls

Pedestrian-actuated traffic controls require the user to push a button to activate a walk signal. According to the MUTCD, pedestrian-actuated traffic controls should be installed when a traffic signal is installed under the Pedestrian Volume or School Crossing warrant, when an exclusive pedestrian phase is provided, when vehicular indications are not visible to pedestrians, and at any established school crossings with a signalized intersection (US DOT, 1988). If the intersection has a median, a button should be added to the median and both corners.

Unfortunately, pedestrian-actuated control signals are often inaccessible to people with mobility impairments and people with visual impairments. To be accessible to wheelchair users and people with limited mobility, pedestrian-actuated traffic controls need to be located as close as possible to the curb ramp without reducing the width of the path. They also need to be mounted low enough to permit people in wheelchairs to reach the buttons. ADAAG does not specify a height for pedestrian-actuated control systems. However, ADAAG Section 4.10.3 states that elevator buttons should be located no higher than 1.065 m (42 in) (ADAAG, U.S. Access Board, 1991).

The size and type of the button also affect the accessibility of the control. Larger raised buttons are easier for people with visual impairments to identify (Figure 4-44). According to proposed Section 14 (1994), buttons should be raised above or flush with their housings and be at least 50 mm (2 in) in the smallest dimension (U.S. Access Board, 1994b).

Pedestrian-actuated control buttons require more force to operate than most indoor buttons. However, people with limited hand strength or dexterity might be able to exert only a limited amount of force. To address this need, proposed Section 14 (1994) recommended that the force required to activate controls should not be greater than 22.2 N (5 lbf) (U.S. Access Board, 1994b).

People with visual impairments might be at a disadvantage at intersections with pedestrian-actuated crossing controls if they are unaware that they need to use a

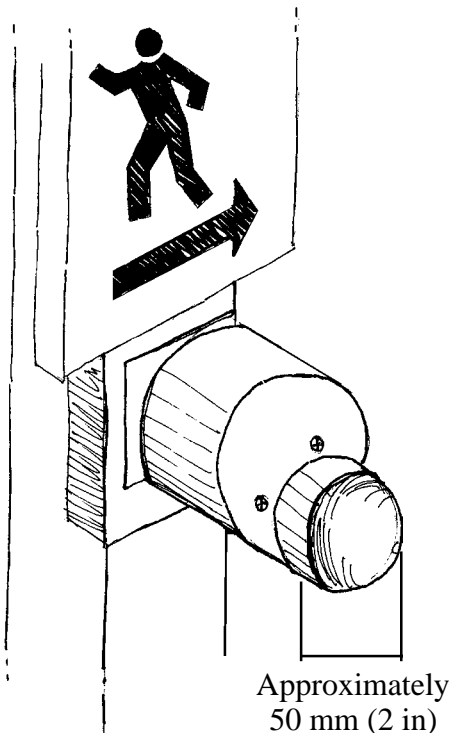
control to initiate a pedestrian crossing signal. At an intersection with a pedestrian-actuated control button, a person with a visual impairment must detect whether a signal button is present, then push it and return to the curb to align for the crossing. This process might require several signal cycles if the button is not located within easy reach of the curb edge. People with visual impairments can confirm the presence of and locate pedestrian-actuated crossing controls more easily if the controls emit sounds and/or vibrations. To address the need for pedestrian-actuated control signals that are accessible to people with visual impairments, TEA-21 provides funding for “the installation, where appropriate, and maintenance of audible traffic signals and audible signs at street crossings” (TEA-21, 1998). Accessible pedestrian signals that accommodate people with visual impairments are discussed in Section 4.4.2.6 of this report.

Many varieties of controls were observed during the sidewalk assessments. The most accessible were relatively large and could be activated with little force. Those that were least accessible were small, required significant force to activate, and were located far from the logical crossing point. Some pedestrian-actuated traffic controls were positioned so that users standing at the edge of the sidewalk had to walk around traffic poles to reach the control button. In other instances, obstacles such as newspaper stands were placed in front of the controls, blocking access to the trigger mechanism. Intersections with awkwardly placed pedestrian-actuated controls can be made more accessible by moving the control to a more easily reached location or altering the signal timing to allow pedestrians to realign themselves for a crossing before the light changes.

#### 4.4.8 Midblock Crossings

Midblock crossings are pedestrian crossing points that do not occur at

**Figure 4-44:**  
**A large, easy-to-press button makes pedestrian-actuated traffic controls more usable for people with limited hand strength and dexterity.**



intersections. They are often installed in areas with heavy pedestrian traffic to provide more frequent crossing opportunities. For midblock crossings to be accessible to people with mobility impairments, a curb ramp needs to be installed at both ends of the crossing along a direct line of travel. If the curb ramps are offset, pedestrians who rely on the curb ramps are forced to travel in the street.

For midblock crossings to be accessible to people with visual impairments, they need to be detectable. At midblock crossings, pedestrians with visual impairments do not have the sound of parallel traffic available to identify a midblock crossing opportunity. If a traffic signal is installed, an audible indicator that provides timing information should also be included. Audible or vibrotactile information is effective in alerting people with visual impairments of a midblock crossing.

Midblock crossings spanning multiple lanes can be difficult for some pedestrians to cross. In these situations, curb extensions can be effective in reducing crossing times and increasing visibility between pedestrians and motorists (Figure 4-45). A median is another effective method to reduce crossing distances.

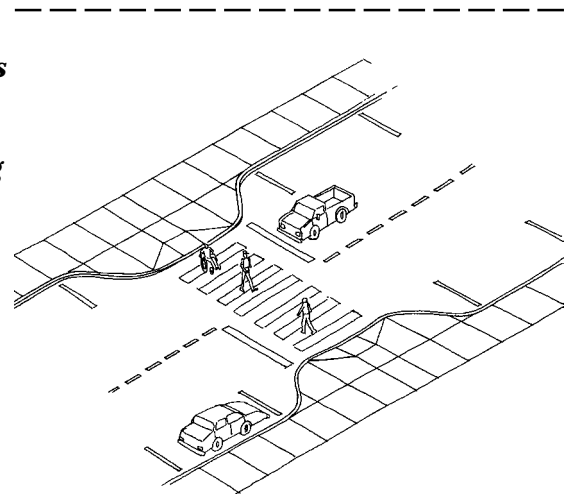
#### 4.4.9 Sight Distances

Sight distance is defined as “the distance a person can see along an unobstructed line of sight” (University of North Carolina, Highway Safety Research Center, 1996). Adequate sight distances between pedestrians and motorists increase pedestrian safety. Motorists also need appropriate sight distances to see traffic signals in time to stop. Vertical sight distance can be important for drivers of high vehicles such as trucks and buses, whose sight lines might be blocked by trees or signs (ibid.). Although bollards, landscaping, parking, benches, or bus shelters make pedestrian areas more

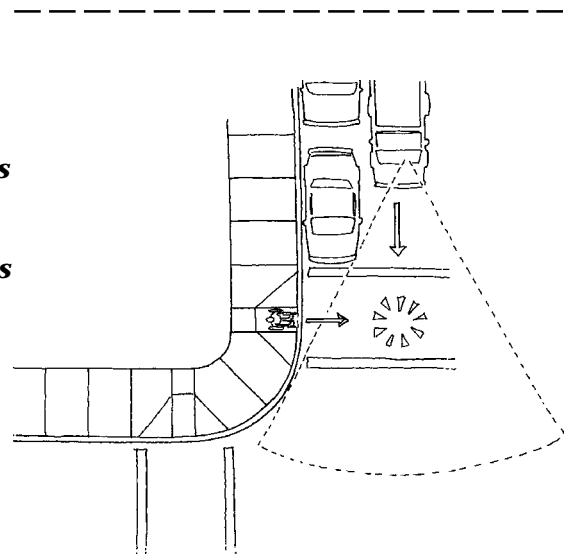
inviting by calming traffic and providing amenities, they can also clutter the environment and block sight lines between motorists and pedestrians waiting to cross the intersection.

Trimming vegetation, relocating signs, and hanging more than one sign or traffic signal on one arm pole where permitted by MUTCD can improve sight distances at corners. Parked cars near the intersection or midblock crossing can also reduce sight distances (Figure 4-46). Installing curb extensions physically deters parking at intersection corners and improves the visibility of pedestrians, as

**Figure 4-45:**  
**Curb extensions at midblock crossings help reduce crossing distance.**



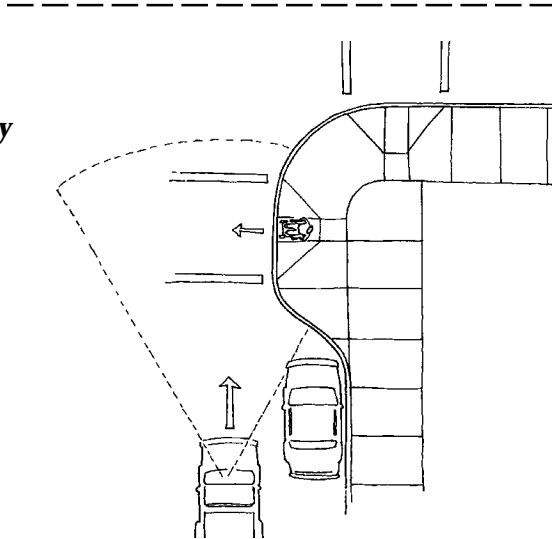
**Figure 4-46:**  
**Sight line obstructed by parked cars prevents drivers from seeing pedestrians starting to cross the street.**



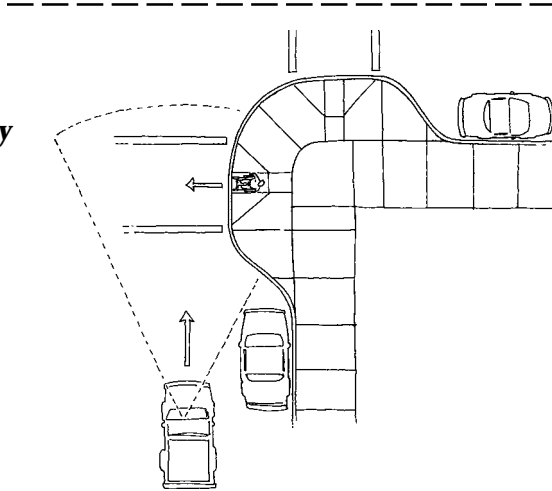


shown in Figures 4-47 and 4-48. Curb extensions can also increase the angle at which pedestrians meet motor vehicles, improving the visibility of both (OR DOT, 1995). In addition, curb extensions shorten crossing distances and provide sidewalk space for curb ramps with landings.

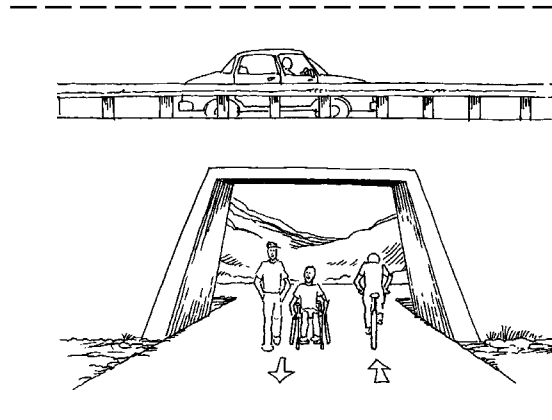
**Figure 4-47:**  
**Partial curb extensions improve visibility between pedestrians and motorists.**



**Figure 4-48:**  
**Full curb extensions improve visibility between pedestrians and motorists.**



**Figure 4-49:**  
**Pedestrian and biker underpass.**



#### 4.4.10 Grade-Separated Crossings

Grade-separated crossings are facilities that allow pedestrians and motor vehicles to cross at different levels. Some grade separated crossings are very steep and are difficult for people with mobility impairments to negotiate. In addition, grade-separated crossings are extremely costly to construct and are often not considered pedestrian-friendly because pedestrians are forced to travel out of their way to use the underpass or overpass. The effectiveness of a grade-separated crossing depends on whether or not pedestrians perceive that it is easier to use than a street crossing (Bowman, Fruin, and Zegeer, 1989).

Examples of grade-separated crossings include the following (Institute of Transportation Engineers Technical Council Committee 5A-5, 1998):

- *Overpasses* — bridges, elevated walkways, and skywalks or skyways
- *Underpasses* — pedestrian tunnels and below-grade pedestrian networks

Figure 4-49 illustrates a pedestrian underpass.

The needs of pedestrians should be a high priority at grade-separated crossings. If designed correctly, grade-separated crossings can reduce pedestrian-vehicle conflicts and potential accidents by allowing pedestrians to avoid crossing the path of traffic. They can also limit vehicle delay, increase highway capacity, and reduce vehicle accidents when appropriately located and designed. Grade-separated crossings can improve pedestrian safety, reduce travel time, and serve to maintain the continuity of a neighborhood in which high-traffic roads run through residential areas (University of North Carolina, Highway Safety Research Center, 1996).

Grade-separated crossings are most efficient in areas where pedestrian attractions such as shopping centers, large schools, recreational facilities, parking garages, and other activity centers are separated from pedestrian generators by high-volume and/or high-speed arterial streets.

Well-designed grade-separated crossings minimize slopes, feel open and safe, and are well lit. Minimizing the slope of a grade-separated crossing is often difficult because a significant rise, generally from 4.3 to 5.5 m (14 to 18 ft), must be accommodated. Inaccessible grade-separated crossings should not be constructed. In some situations, elevators can be installed to accommodate people with mobility impairments.

Underpasses might invite crime if insufficiently lit and seldomly traveled. Underpasses can also be more expensive to install than other pedestrian facilities

because a tunnel must be dug and utility lines relocated. Tunnels are more inviting to use when they are brightened with skylights or artificial lighting and are wide and high enough to feel open and airy (ibid.).

#### 4.4.11 Roadway Design

Sidewalk accessibility is intimately affected by the design of roads. Factors affecting roadway safety and accessibility for pedestrians include sight distance, design speed, location, cross-slope, grade, and the functional class of the road. Although some States have their own guidelines, most roadway designers rely on the *AASHTO Green Book* for street development specifications. The *AASHTO Green Book* recognizes several general factors as important to the functionality of public rights-of-way, including the grade of the road, cross-slopes, traffic control devices, curbs, drainage, the road crown, and roadway width (Table 4-1).

**Table 4-1:**  
**Grade, Cross-Slope, and Curb Height Guidelines by Functional Class of Roadway**  
*(based on information contained in AASHTO, 1995)*

Road Type	Maximum Grade (%) <sup>1</sup> Level/Rolling/Mountain	Cross-Slope <sup>3</sup> (%)	Curb Height (mm)	Sidewalk Coverage
Urban local	Consistent with terrain  <15.0/<8.0 <sup>2</sup>	1.5–6.0 <sup>4</sup>	100–225	Commercial — both sides Residential — at least one side
Rural local	8.0/11.0/16.0	1.5–6.0 <sup>4</sup>	n/a	n/a <sup>5</sup>
Urban collector	9.0/12.0/14.0	1.5–3.0	150–225	Same as Urban local
Rural collector	7.0/10.0/12.0	1.5–3.0	n/a	n/a <sup>5</sup>
Urban arterial	8.0/9.0/11.0	1.5–3.0	150–225	n/a <sup>5</sup>
Rural arterial	5.0/6.0/8.0	1.5–2.0	n/a	n/a <sup>5</sup>
Recreational	8.0/12.0/18.0	n/a	n/a	n/a <sup>5</sup>

Chart does not include figures for freeways or divided arterials, which are not designed for pedestrians and are not built with sidewalks.

<sup>1</sup> The lower the maximum speed permitted on the road, the steeper the grade is permitted to be. The numbers listed in the chart represent the lowest road speeds indicated in the *AASHTO Green Book*.

<sup>2</sup> Residential/commercial or industrial.

<sup>3</sup> The numbers listed in the chart indicate what the cross-slope should generally be for proper drainage.

<sup>4</sup> Cross-slopes ranging from 3.0 to 6.0 percent should be used only for low surface types such as gravel, loose earth, and crushed stone.

<sup>5</sup> Sidewalks are still needed, even though the *AASHTO Green Book* does not specify guidelines for sidewalk coverage along this road.

The functionality of a roadway should be balanced with the needs of pedestrians. Too often, roadway design prioritizes the needs of motorists, and pedestrians are put at risk. Pedestrians would be well accommodated if they received the same design considerations as drivers. When a sidewalk is included along a roadway, it must be accessible according to the ADA regulations. To accomplish this task, roadway designers must understand how roadway designs impact pedestrians and prioritize accessible road development.

The manner in which roads are maintained also impacts pedestrians. Asphalt, an economical and durable material, is used to pave most roads. In the past, repairing damage to asphalt roads typically entailed overlaying the existing pavement with more asphalt. Over time, the asphalt layers build up the roadway crown and can create steep slopes on either side of the centerline. These slopes can be difficult for crossing pedestrians to negotiate (Figure 4-50) and create rapidly changing grades at curb ramps. Because

used asphalt can now be recycled, it is currently more common for roads to be milled before they are resurfaced. To improve accessibility, roads should always be milled before being resurfaced. The same amount of asphalt to be added to a road should be milled away prior to any resurfacing project. Milling should be completed from gutter to gutter to avoid crowning (Figure 4-51). In addition, because the US DOJ has indicated that “resurfacing beyond normal maintenance is an alteration,” accessibility improvements such as curb ramp installations must also be incorporated into road resurfacing projects (US DOJ, 1994).

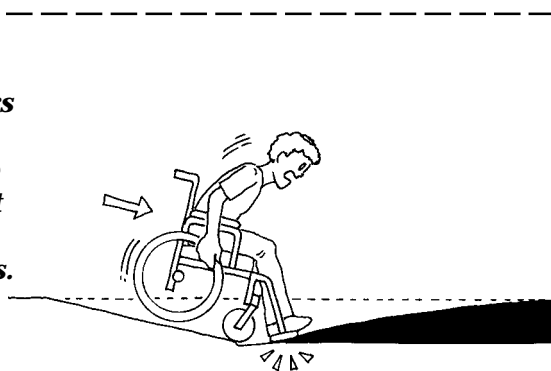
#### 4.4.12 Drainage

Sidewalks and sidewalk elements, such as curb ramps and driveway crossings, must be designed to provide efficient drainage as well as good access. Sidewalks provide the main conduit for draining the walking surface, adjacent properties, and, in some cases, the roadway. Sidewalks with poor drainage can accumulate precipitation that is not only a nuisance but might impede access or endanger the health, safety, and welfare of all pedestrians. For example, poorly drained sidewalks in cold climates can freeze over with ice and cause a hazard for pedestrians. Poorly drained sidewalks also permit the accumulation of silt and debris, further impeding access. The *AASHTO Green Book*, adopted by most States, provides slope ranges based on street type (Table 4-1).

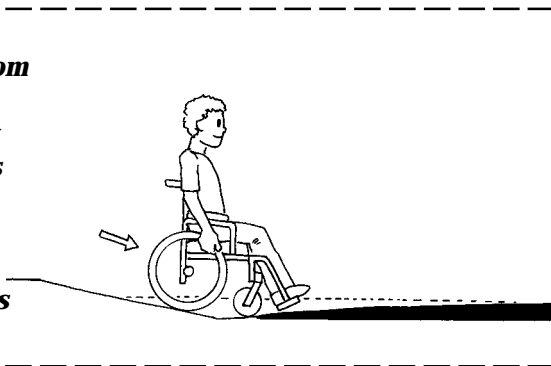
Local topography and weather conditions also affect how steeply sidewalks, gutters, and roads should be sloped to provide adequate drainage. According to the *AASHTO Green Book*, a cross-slope between 1.5 to 2.0 percent provides effective drainage on paved surfaces in most weather conditions (AASHTO, 1995).

Gutters are generally sloped more steeply than the roadway to increase runoff velocity. Concrete gutters are smoother,

**Figure 4-50:**  
When roads are not milled, layers of asphalt build up and make the crossing difficult for wheelchair users and others.



**Figure 4-51:**  
Milling roads from gutter to gutter prevents rapidly changing grades and makes intersections easier for wheelchair users to negotiate.



offer less resistance to runoff, and are more water-resistant than asphalt, but they are also more expensive to install. According to the *AASHTO Green Book*, gutters should have “a cross-slope of 5 to 8 percent to increase the hydraulic capacity of the gutter section” (AASHTO, 1995). ADAAG specifies a 5 percent maximum slope at gutters (ADAAG, U.S. Access Board, 1991). This provision helps prevent wheelchair users from hitting their footrests on the ramp or gutter and potentially being thrown forward out of their wheelchairs. Section 4.3.1 contains additional information on rate of change of grade and gutter design.

A wider gutter can be used to drain larger volumes of water without increasing the slope experienced by curb ramp users. However, widening the gutter might require the purchase of additional right-of-way. According to the *AASHTO Green Book*, gutters formed in combination with curbs should range from 0.3 m to 1.8 m (12 in to 71 in) wide (AASHTO, 1995).

Barrier curbs are higher than other types of curbs to discourage vehicles from leaving the roadway (AASHTO, 1995). The height and more perpendicular face of barrier curbs also help sidewalks from being inundated in areas prone to flooding. High curbs can also cause curb ramps to be longer and occupy more sidewalk or street space. These restrictions make it more difficult to install accessible ramps on narrower sidewalks.

Storm drains and catch basins are normally placed where they will intercept surface water runoff. Installing a curb ramp at a point of strategic runoff interception can compromise effective drainage. Regrading the section of road or curb ramp location to alter drainage patterns can resolve some situations in which drainage concerns conflict with accessibility requirements. Ideally, inlets should be placed uphill of crossings or curb ramps to drain water before it can puddle where pedestrians are crossing. In locations with heavy rainfall,

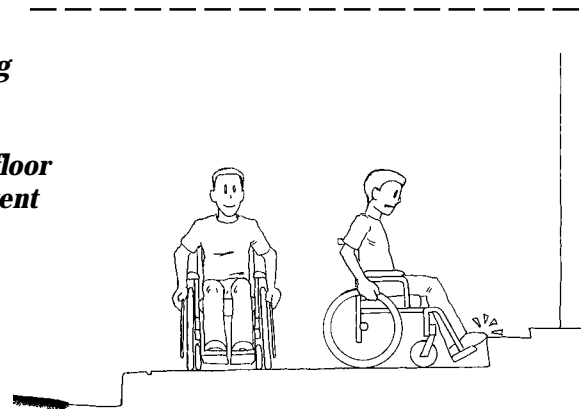
more frequent drainage inlets, more strategic placement of inlets, and basin pickups will also reduce the frequency of puddles.

#### 4.4.13 Building Design

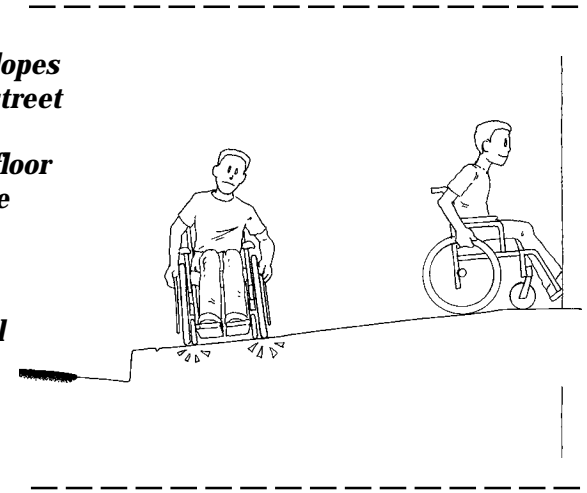
Newly constructed buildings are required to be accessible under Titles II and III of the ADA. Building entrances must be at grade with the sidewalk or provide accessible ramps to bridge elevation changes between the building and the street. In some existing facilities, a significant elevation difference exists between the street and the finished floor elevation (FFE) of the building. Inaccessible building entrances with stairs or sidewalks with significant cross-slopes are often the result (Figures 4-52 and 4-53).

Factors influencing the FFE of a building can include zoning ordinances, building

**Figure 4-52:**  
*Stairs bridging low street elevation and high finished-floor elevation prevent wheelchair access into the building.*



**Figure 4-53:**  
*Steep cross-slopes bridging low street elevation and high finished-floor elevation make the sidewalk difficult for wheelchair users to travel across.*



codes, and conditions such as geologic formations, topography, and the hydrologic makeup of an area. The requirements of other agencies, including the Federal Emergency Management Agency (FEMA), the Army Corps of Engineers, and the Federal Aviation Administration, as well as wetland laws, can also influence the FFE of buildings in a given region. For example, FEMA requires communities located within flood plains to elevate buildings above expected water rise levels. Such safety recommendations are commonly included in local building codes. Insurance companies might demand higher FFEs if coverage for flood damage is desired.

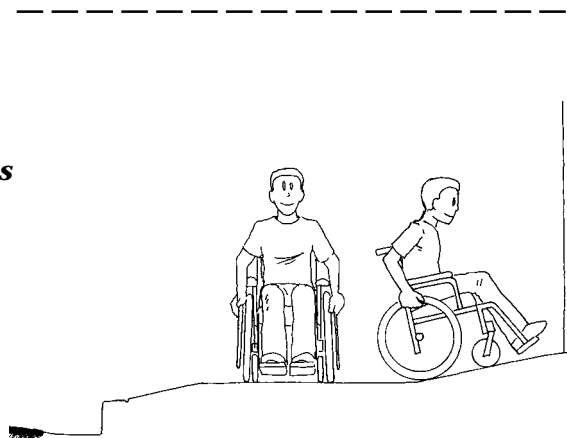
When sidewalk design is not given sufficient emphasis by transportation planning and review processes, sidewalk

designers are left to bridge the gap between building and street elevations. Creative solutions include providing a level area and sloping the edge of the path, or raising the curb to level the sidewalk (Figures 4-54 and 4-55).

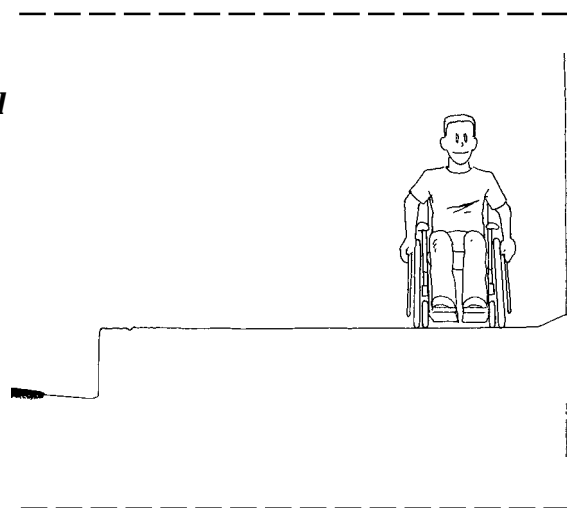
Road, sidewalk, and building designers should coordinate their efforts to ensure that accessible sidewalks are developed in new construction and alterations. Good review processes, including a variety of interest groups, can ensure that construction plans for accessible sidewalks are implemented.

Transportation agencies differ greatly in the degree to which they address pedestrian facilities. Some areas permit developers to exclude sidewalk plans from the review of the overall construction plan and create inaccessible pathways and noncompliant buildings, while others make consideration of sidewalk plans mandatory. The disparity in the types of requirements builders and developers must meet was illustrated in a 1995 National Association of Home Builders (NAHB) survey. The survey revealed that, while 94 percent of builders and developers had to obtain building permits, only 36 percent were required to undergo plan checking, and only 19 percent were required to design sidewalks more than 1.220 m (48 in) wide (NAHB, 1995).

**Figure 4-54:**  
**A level area at least 0.915 m (36 in) wide improves access when there is a low street elevation and high finished-floor elevation.**



**Figure 4-55:**  
**A higher curb provides a level pathway but might increase the slope of curb ramps if the sidewalk is narrow.**



#### 4.4.14 Maintenance

Sidewalks are prone to damage caused by environmental conditions. Maintaining sidewalk elements in good condition is an essential part of providing access to public rights-of-way. Sidewalks in poor repair can limit access and threaten the health and safety of pedestrians. If sidewalks are in poor condition or nonexistent, pedestrians are forced to travel in the street.

A public information program by the Campaign to Make America Walkable indicated that 3 of the top 10 most frequently cited roadway safety and

sidewalk design problems were the following maintenance issues (The Campaign to Make America Walkable, 1997):

1. Missing sections of sidewalk, especially on key walking routes
2. Bad sidewalk surfaces, i.e., uneven or broken concrete or uplifted slabs over tree roots
3. Bad sidewalk maintenance, i.e., overhanging bushes or trees or unshoveled snow on sidewalks

Maintenance problems are usually identified by pedestrians who report the location to the municipal authorities. Identification of locations requiring maintenance may be done in conjunction with a city's accessibility improvement program. Effective maintenance programs are quick to identify conditions that can impede access and respond with repairs. Some cities survey and repair all sidewalks in regular cycles. Other cities make or enforce repairs only if a complaint is filed. Cities also might have pavement management programs and personnel devoted entirely to inspecting and repairing damaged access routes. Assessing sidewalks for accessibility should be an integral part of maintenance survey programs.

Sidewalk inspectors typically look for conditions that are likely to inhibit access or cause pedestrians to injure themselves. The following list of common sidewalk maintenance problems was generated from promotional material created for home owners by the Bureau of Maintenance in the City of Portland, Oregon (1996) and the Division of Engineering for the Lexington–Fayette County Urban Government (1993):

- *Step separation* — a vertical displacement of 13 mm (0.5 in) or greater at any point on the walkway that could cause pedestrians to trip, lock up the wheels of a wheelchair, or prevent the wheels of a wheelchair from rolling smoothly

- *Badly cracked concrete* — holes and rough spots ranging from hairline cracks to indentations wider than 25 mm (1 in)
- *Spalled areas* — fragments of concrete or other building material detached from larger structures; also losses of aggregate and cement leaving holes or depressions greater than 50 mm x 50 mm (2 in x 2 in) in the sidewalk
- *Settled areas that trap water* — sidewalk panels with depressions, reverse cross-slopes, or other indentations that cause the sidewalk path to be lower than the curb; these depressions cause silt and water to settle on the walkway path and might require replacement.
- *Tree root damage* — roots from trees growing in adjacent landscaping that cause the walkway surface to buckle and crack, impeding access
- *Vegetation overgrowth* — ground cover, trees, or shrubs on properties or setbacks adjacent to the sidewalk that have not been pruned. Overgrown vegetation can encroach onto the walkway and pose obstacles, inhibiting pedestrian access.
- *Obstacles* — objects located on the sidewalk, in setbacks, or on properties adjacent to the sidewalk that obstruct passage space. Obstacles commonly include trash receptacles, parked cars, and private mailboxes.
- *Sidewalks of materials other than specified by the municipality* — the use of materials other than those specified by the municipality in the construction of sidewalks and driveway aprons. Materials not approved for sidewalk construction can erode quickly, cause excessive slippage, or be inappropriate to the atmosphere of a particular area.
- *Driveway flares* — that do not comply with standard criteria set by the municipality
- *Any safety issue* — that a pedestrian or sidewalk inspector believes merits attention

Although sidewalks are elements of the public right-of-way, many city charters assign the owner of the adjacent property with responsibility for sidewalk upkeep. It is common for city charters to specify that the city cannot be held liable for any accident or injury due to sidewalk conditions.

Home owners are commonly allowed to decide whether to hire a contractor, perform repairs on their own, or have the city do the repair. The home owners' association in some neighborhoods

address right-of-way maintenance to minimize the cost to individual members. Some cities subsidize property owners for repairing sidewalks. Local laws also might dictate whether a home owner must engage a professional contractor to undertake sidewalk repair. If municipal inspectors review and approve sidewalk repairs, the finished sidewalks are more likely to meet pedestrian access needs.

#### 4.4.15 Signs

Most agencies rely on the MUTCD for sign guidelines. For font recommendations, the MUTCD references the *Standard Alphabets for Highway Signs and Pavement Markings*, which permits a series of six letter types on signs. Each letter type features a different stroke width-to-height ratio (Office of Traffic Operations, FHWA, 1982). Various sign shapes, colors, and lettering are used for each type of sign (warning, street, regulatory, etc.) (US DOT, 1988). Braille and raised lettering are not addressed in the MUTCD.

ADAAG Section 4.30 also provides guidelines for signage. ADAAG specifications are targeted at indoor facilities and might not be applicable to all outdoor spaces. According to ADAAG, “letters and numbers on signs shall have a width-to-height ratio between 3:5 and 1:1 and a stroke width-to-height ratio between 1:5 and 1:10” (ADAAG, U.S. Access Board, 1991). MUTCD requirements for size and stroke meet and might even exceed ADAAG specifications. ADAAG Section 4.30 also provides guidelines for character height, raised and brailled characters and pictorial symbol signs, finish and contrast, mounting location and height, and symbols of accessibility.

Pedestrian signs should not be placed in locations where they obstruct the minimum clearance width or protrude into the pathway.

**Figure 4-56:**  
Traffic sign indicating upcoming steep grade (US DOT, 1988).



**Figure 4-57:**  
Pedestrian sign indicating upcoming steep grade.<sup>1</sup>



<sup>1</sup>This sign is not currently included in the *Manual on Uniform Traffic Control Devices* (MUTCD). Before using any traffic control device that is not included in the MUTCD, the interested State or locality should submit a request for permission to experiment to FHWA's Office of Highway Safety (HHS-10), 400 Seventh Street, SW, Washington, DC 20590. Guidelines for conducting an experiment can be found in Part 1A-6 of the MUTCD.

The majority of signs in the public right-of-way are directed at the motorist. Although these signs often affect pedestrians, they are usually not intended for or positioned to be seen by sidewalk users. For example, the street name signs on many large arterials are hung in the center of the intersection. This location is essentially invisible to pedestrians traveling along the sidewalk. Pedestrians might even be put in danger because important safety information, such as yield signage, is not easily visible.

Targeting more signs toward pedestrians would improve safety and permit them to identify routes requiring the least effort for travel. Warning signs similar to standard traffic warning signs (Figure 4-56) would provide information on sidewalk characteristics such as steep grades (Figure 4-57). To date, these types of signs have not been introduced into the MUTCD. Inclusion in this report does not constitute FHWA endorsement. Pedestrian-oriented signage containing access information for trails has been

developed as part of the Universal Trail Assessment Process (UTAP) (see Sections 5.1 and 5.4.9). Objective signage provides users with reliable information they can use to make informed choices about their travel routes. In the sidewalk environment, signage should be supplemented with audible or tactile information to be accessible to people with visual impairments.

## 4.5 Conclusion

Many factors work in concert to make sidewalks and sidewalk elements accessible. Although it is important to make individual features accessible, such improvements will not be useful unless the conditions of the sidewalk as a whole can be negotiated. Accessible sidewalks must be included as part of all new construction and alterations. In addition, regular maintenance programs should be implemented to keep existing routes safe and usable.



**Table 4-2.1:**  
**Federal Accessibility Guidelines for Accessible Routes**

Source	Maximum Allowable Running Grade without Handrails	Maximum Grade with Handrails and Landings	Maximum Allowable Running Cross-Slope	Minimum Clearance Width	Maximum Allowable Vertical Change in Level	Minimum Allowable Vertical Clearance (Overhead)
	%	% m	%	m	mm	m
ADA Standards for Accessible Design <sup>1</sup> (US DOJ, 1991)	5.0 <sup>2</sup>	8.33 <sup>2</sup> 9.1	2.0	0.915 <sup>3</sup>	6 <sup>4</sup>	2.030
UFAS (US DoD, et al., 1984)	5.0 <sup>2</sup>	8.33 <sup>2</sup> 9.1	2.0	0.915 <sup>3</sup>	6 <sup>4</sup>	2.030

<sup>1</sup> The ADA Standards for Accessible Design are identical in content to ADAAG Sections 1–10. However, the Design Standards are enforceable by the U.S. Department of Justice.

<sup>2</sup> The ADA Standards for Accessible Design require people to use the least slope possible on accessible routes.

<sup>3</sup> Minimum clearance width may be reduced to 0.815 m (32 in) at an obstruction for a maximum length of 0.610 m (24 in).

<sup>4</sup> Changes in level between 6 mm (.25 in) and 13 mm (.5 in) are permitted if beveled with a maximum slope of 50 percent.

**Table 4-2.2:**  
**ADAAG-Proposed Section 14 (1994) Accessibility Guidelines for Public Rights-of-Way**

Source	Maximum Allowable Running Grade	Maximum Grade for a Specified Distance (Run)	Maximum Allowable Running Cross-Slope	Minimum Clearance Width	Maximum Allowable Vertical Change in Level	Minimum Allowable Vertical Clearance (Overhead)
	%	% m	%	m	mm	m
ADAAG-proposed Section 14 (1994) (U.S. Access Board, 1994b)	n/a <sup>1</sup>	n/a n/a	2.0	0.915	6 <sup>2</sup>	2.030

<sup>1</sup> Sidewalk slopes may be consistent with the slope of the adjacent roadway.

<sup>2</sup> Changes in level between 6 mm (.25 in) and 13 mm (.5 in) are permitted if beveled with a maximum slope of 50 percent.

**Table 4-2.3:**  
**State Guidelines for Sidewalks**

Source	Maximum Allowable Running Grade	Maximum Grade for a Specified Distance (Run)	Maximum Allowable Running Cross-Slope	Minimum Clearance Width	Maximum Allowable Vertical Change in Level	Minimum Allowable Vertical Clearance (Overhead)
	%	% m	%	m	mm	m
FL Ped. Planning and Dgn. Guidelines (University of NC Hwy. Safety Research Ctr., 1996)	5.0	n/a <sup>1</sup> n/a <sup>1</sup>	2.0	1.220	n/a	n/a
Oregon Pedestrian Design Guidelines	5.0	8.33 9.1	2.0	1.0	n/a	2.1
Architectural Barriers Act (Texas Department of Licensing and Regulation, 1997)	5.0	8.33 9.1	2.0	0.915	6 <sup>2</sup>	2.030

<sup>1</sup> Florida directs people to the ADA for maximum grade requirements.

<sup>2</sup> Changes in level between 6 mm (.25 in) and 13 mm (.5 in) are permitted if beveled with a maximum slope of 50 percent.

**Table 4-2.4:**  
**Additional Recommendations for Sidewalks**

Source	Maximum Allowable Running Grade without Handrails	Maximum Grade with Handrails and Level Landings	Maximum Allowable Running Cross-Slope	Minimum Clearance Width	Maximum Allowable Vertical Change in Level	Minimum Allowable Vertical Clearance (Overhead)
	%	% m	%	m	mm	m
Accessibility for Elderly and Handicapped Peds. (Earnhart and Simon, 1987)	5.0	8.33 9.1	2.0	0.915	6 <sup>1</sup>	2.030
ANSI A117.1-1980 (ANSI, 1980)	5.0	8.33 9.1	2.0	0.915	6 <sup>1</sup>	2.030
ANSI A117.1-1992 (Council of American Building Officials, 1992)	5.0	8.33 9.1	2.1	0.915	6 <sup>1</sup>	2.030
Dgn. and Safety of Ped. Facilities (ITE Tech. Council Comm. SA-5, 1998)	8.0	8.0 9.1	2.1	0.915	n/a	n/a

<sup>1</sup> Changes in level between 6 mm (.25 in) and 13 mm (.5 in) are permitted if beveled with a maximum slope of 50 percent.

**Table 4-3.1:**  
**Federal Accessibility Guidelines for Curb Ramps (CR)**

Source	Maximum Slope of Curb Ramps %	Maximum Cross-Slope of Curb Ramps %	Maximum Slope of Flared Sides %	Minimum Ramp Width m	Minimum Landing Length m
ADA Standards for Accessible Design <sup>1</sup> (US DOJ, 1991)	8.33 <sup>2, 3</sup>	2.0	10.0 <sup>4, 5</sup>	0.915 <sup>6</sup>	0.915
UFAS (US DoD, et al., 1984)	8.33 <sup>2, 3</sup>	2.0	10.0 <sup>4, 5</sup>	0.915 <sup>6</sup>	0.915

<sup>1</sup> The ADA Standards for Accessible Design are identical in content to ADAAG Sections 1–10. However, the Design Standards are enforceable by the U.S. Department of Justice.

<sup>2</sup> The ADA Standards for Accessible Design require people to use the least slope possible on curb ramps that are part of accessible routes.

<sup>3</sup> If space prohibits a slope less than 8.33%, curb ramps to be constructed on existing sites may have a slope of 8.33% to 10% with a maximum rise of 150 mm (6 in) or a slope of 10% to 12.5% with a maximum rise of 75 mm (3 in).

<sup>4</sup> The flare guidelines do not apply if the curb ramp is located where a pedestrian does not have to walk across the ramp or if the flared sides are protected by handrails or guardrails.

<sup>5</sup> If the landing is less than 1.220 m long, the slope of the flared sides must not exceed 8.33%.

<sup>6</sup> Exclusive of flared sides.

**Table 4-3.2:**  
**ADAAG-Proposed Section 14 (1994) Accessibility Guidelines for Curb Ramps (CR)**

Source	Maximum Slope of Curb Ramps %	Maximum Cross-Slope of Curb Ramps %	Maximum Slope of Flared Sides %	Minimum Ramp Width m	Minimum Landing Length m
ADAAG-Proposed Section 14 (1994) (U.S. Access Board, 1994b)	8.33 <sup>1, 2</sup>	2.0	10.0 <sup>3</sup>	0.915 <sup>4</sup>	0.915 <sup>5</sup>

<sup>1</sup> The U.S. Access Board recommends using the least slope possible.

<sup>2</sup> The slope of a parallel curb ramp should not exceed 8.33%, but is not expected to exceed 2.440 m in length.

<sup>3</sup> The flare guidelines do not apply if the curb ramp is located where a pedestrian does not have to walk across the ramp or if the flared sides are protected by handrails or guardrails.

<sup>4</sup> Exclusive of flared sides.

<sup>5</sup> The minimum allowable landing length is 0.915 m for parallel curb ramps and 1.220 m for perpendicular curb ramps.

**Table 4-3.3:**  
**State and City Guidelines for Curb Ramps (CR)**

Source	Maximum Slope of Curb Ramps %	Maximum Cross-Slope of Curb Ramps %	Maximum Slope of Flared Sides %	Minimum Ramp Width m	Minimum Landing Length m
FL Ped. Planning and Dgn. Guidelines (University of NC Hwy. Safety Research Ctr., 1996)	8.33	n/a	8.33 <sup>1</sup>	1.0	1.220
Ped. Compatibility Planning and Dgn. Guidelines (NJ DOT, 1996)	8.33 <sup>2</sup>	2.0 <sup>2</sup>	10.0 <sup>1</sup>	1.220	1.220
Ped. Dgn. Guide (City of Portland, 1997)	8.33	2.0	n/a	0.915	1.220
Architectural Barriers Act (Texas Department of Licensing and Regulation, 1997)	8.33 <sup>2, 3</sup>	2.0	10.0 <sup>1, 4</sup>	0.915 <sup>5</sup>	0.915

<sup>1</sup> The flare guidelines do not apply if the curb ramp is located where a pedestrian does not have to walk across the ramp or if the flared sides are protected by handrails or guardrails.

<sup>2</sup> The least possible slope should be used.

<sup>3</sup> If space prohibits a slope less than 8.33%, curb ramps to be constructed on existing sites may have a slope of 8.33 to 10% with a maximum rise of 150 mm (6 in) or a slope of 10 to 12.5% with a maximum rise of 75 mm (3 in).

<sup>4</sup> If the landing is less than 1.220 m long, the slope of the flared sides must not exceed 8.33%.

<sup>5</sup> Exclusive of flared sides.

**Table 4-3.4:**  
**Additional Recommendations for Curb Ramps (CR)**

Source	Maximum Slope of Curb Ramps %	Maximum Cross-Slope of Curb Ramps %	Maximum Slope of Flared Sides %	Minimum Ramp Width m	Minimum Landing Length m
Accessibility for Elderly and Handicapped Peds. (Earnhart and Simon, 1987)	8.33 <sup>1</sup>	n/a	10.0 <sup>2, 3</sup>	0.915	n/a
ANSI A117.1-1980 (ANSI, 1980)	8.33 <sup>1, 4</sup>	2.0	10.0 <sup>2</sup>	0.915 <sup>5</sup>	0.915
ANSI A117.1-1992 (Council of American Building Officials, 1992)	8.33 <sup>1, 4</sup>	2.1	10.0 <sup>2</sup>	0.915 <sup>5</sup>	0.915
Dgn. and Safety of Ped. Fac. (ITE Tech Council Comm SA-5, 1998)	8.33	n/a	10.0	0.915	n/a
Planning Dgn. and Maintenance of Ped. Facilities (Bowman, Fruin, and Zegeer, 1989)	8.33 <sup>1</sup>	n/a	10.0 <sup>2, 3</sup>	0.915 <sup>6</sup>	n/a

<sup>1</sup> If space prohibits a slope less than 8.33%, curb ramps to be constructed on existing sites may have a slope of 8.33 to 10% with a maximum rise of 150 mm (6 in) or a slope of 10% to 12.5% with a maximum rise of 75 mm (3 in).

<sup>2</sup> The flare guidelines do not apply if the curb ramp is located where a pedestrian does not have to walk across the ramp or if the flared sides are protected by handrails or guardrails.

<sup>3</sup> If the landing is less than 1.220 m long, the slope of the flared sides must not exceed 8.33%.

<sup>4</sup> The least possible slope should be used.

<sup>5</sup> Exclusive of flared sides.

<sup>6</sup> In areas with snow removal, 1.220 m is the minimum recommended ramp width.



# Trail Design for Access

Trails provide both recreation and transportation routes through natural environments and urban areas. A wide variety of people with a range of mobility and physical endurance enjoy visiting outdoor trails. Trail users include people with and without disabilities, children, families, and older adults. Trail users participate in a variety of activities, including biking, cross-country skiing, and hiking.

This chapter examines elements and characteristics, such as grade, cross-slope, surface type, and signage, that have the greatest impact on access. Design and user conflicts that result from having multiple user groups on the same trails are addressed as well.

## 5.1 Universal Trail-Assessment Process

To gain a better understanding of existing trail conditions, the researchers visited several trail and shared-use-path facilities within the United States. During these visits, trail characteristics were measured using the Universal Trail Assessment Process (UTAP). The UTAP was chosen because it collects objective mapping, usage, and maintenance information about trails, as well as information about characteristics that significantly influence user safety and access. It is critical to obtain quantitative information about trail characteristics to determine how access can be improved through maintenance, reconstruction, and/or dissemination of information. The National Park Service, the California State Park System, and the Minnesota Department of Natural Resources are among the land management agencies that have implemented the UTAP in their jurisdictions.

The UTAP utilizes the following simple surveying tools to measure trail characteristics:

- A compass to measure bearing
- A rolatape to measure distance
- A clinometer to measure running grade
- A tape measure to determine width, clearance, and obstacle dimensions
- A level to measure maximum grade, running cross-slope, and maximum cross-slope

The Global Positioning System (GPS) can be used as an alternative to the compass and clinometer to track positioning and elevation. GPS was not used during the sidewalk assessments because it has several drawbacks. These disadvantages include increased expense, reliance on battery power, problems obtaining signals in forested areas or narrow canyons, the requirement to wait before a reading can be obtained, and grade measurements that are significantly less accurate than those obtained by a clinometer (unless a base station providing differential signal correction is used).

## 5.2 Design Guideline Comparisons

The researchers compiled existing guidelines and recommendations related to trail design and construction. Guidelines published by Federal and State governments, counties, cities, private organizations, and advocacy groups were collected and summarized in Tables 5-4 through 5-9, which are located at the end of this chapter.

Consideration of the needs of bicyclists, pedestrians, people with disabilities, and other user groups differ greatly among guidelines. This variation is primarily due to the mission and constituency that each agency or organization serves. For example, the U.S. Access Board focuses primarily on the needs of people with disabilities, while State DOTs serve a

more varied group of people and might focus on design issues that do not relate to access. Recommendations for trails intended for use by a single recreation group, such as motorcyclists, are sometimes written by advocacy groups such as the American Motorcyclists Association.

Some design guidelines make provisions for different levels of difficulty to provide a variety of trail experiences within a single recreation area. Guidelines and recommendations for trails designed at multiple difficulty levels are represented in the tables as Multiple Levels. These levels are termed Easier, Moderate, and Difficult. If a fourth level of difficulty, equivalent to Most Difficult, was included in a guideline or recommendation, it was not listed in the table. Guidelines and recommendations recognizing only one level of difficulty are represented in the tables as Single Level. The tables are organized by trail type. Abbreviated bibliographical information for each document is included in the Source column of the tables; however, complete bibliographical information is included at the end of this report.

Although trail designers may find it helpful to adhere to guidelines for easier,

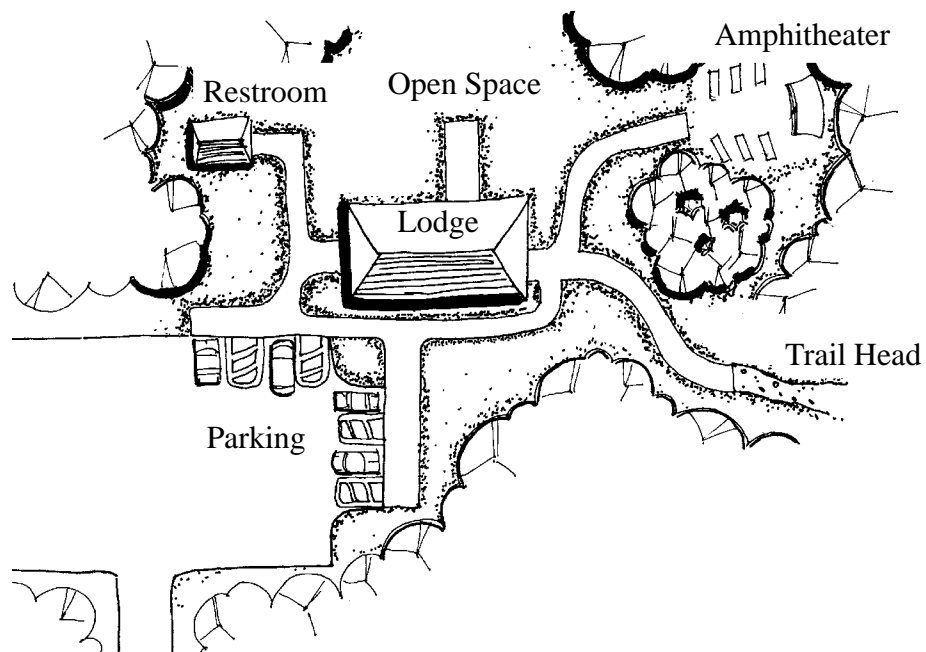
moderate, and difficult trails during the design process, rating trails as such can be misleading for users. What is considered easier, moderate, and difficult varies between areas and can be hard for users to interpret. Alternatively, conveying the dimensions and magnitudes of trail characteristics to users through signage would provide visitors with reliable and comparable information.

### 5.3 Trail Types

Trail design guidelines are generally written to accommodate a specific type of user. For example, guidelines developed solely for snow machine use will not meet the needs of a cross-country skier. In practice, most trails are used by more than one type of user and should be considered shared-use paths. Only trails with features and strict enforcement practices that effectively exclude other users are single-user paths. For this reason, the design needs of all potential user groups should be considered when planning a trail.

Guidelines for the following types of paths were compiled and considered in

**Figure 5-1:**  
**Outdoor recreation access routes (ORARs) link accessible elements at a recreation site.**



this report; definitions for each are listed in the Glossary (Appendix B):

- Accessible Routes
- Outdoor Recreation Access Routes (Figure 5-1)
- Recreational Trails
- Hiking Trails
- Shared-Use Paths
- Bicycle Paths
- Mountain Biking Trails
- Equestrian Trails
- Cross-Country Ski Trails
- Snow Machine Trails
- All-Terrain Vehicle Trails
- Off-Highway Vehicle Trails
- Motorcycle Trails

## 5.4 Access Characteristics

### 5.4.1 Grade

*Grade* (slope) is defined as the slope parallel to the direction of travel and is calculated by dividing the vertical change in elevation by the horizontal distance covered. For example, a trail that gains 2 m in elevation over 40 m of horizontal distance has a grade of 5 percent. Some guidelines use the term “slope” to refer to grade. However, the term “grade” is used in this report to avoid confusion with cross-slope. *Average grade* is defined as the average of many contiguous running grades. Running grade is usually measured over the maximum distance afforded by sight lines when grades are continuous. However, more detailed grade information can be obtained if measurement distances do not exceed 30 m (100 ft). Running grade is also measured on shorter trail segments between changes on grade. *Maximum grade* is defined as a limited section of trail that exceeds the typical running grade. Maximum grade values can differ significantly from the running

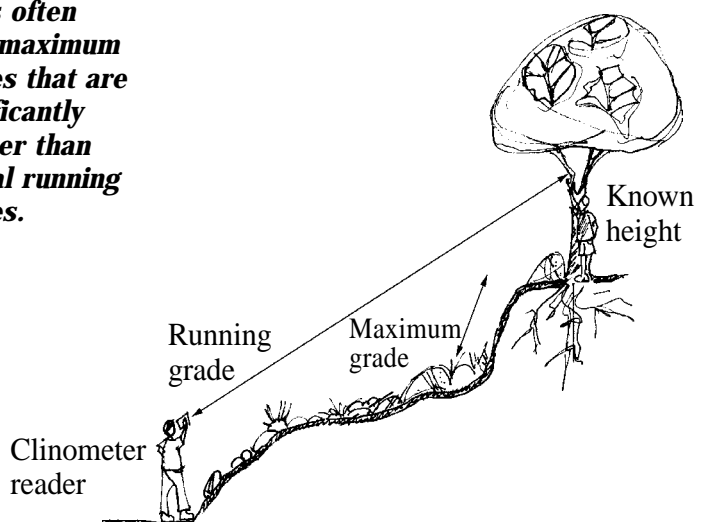
grade values. For example, a trail that gains 15 m in elevation gradually over 1 km has the same running grade as a trail that is flat for 0.75 km and then climbs 15 m over the last 0.25 km; however, the two trails make very different strength and endurance demands of users. The steeper segment in Figure 5-2 is an example of a maximum grade that occurs over a short distance and significantly exceeds the typical running grade. Table 5-1 contains

**Table 5-1:**

**Results of 10 Trail Assessments Show That on Many Trails, the Maximum Grade and Cross-Slope Significantly Exceeded the Typical Average Grade and Cross-Slope (Chesney and Axelson, 1994)**

Trail	Average Grade (%)	Maximum Grade (%)	Average Cross-Slope (%)	Maximum Cross-Slope (%)
Beehive	10	47	9	34
Boiling River	4	62	7	32
Fairy Falls	3	40	10	25
Grotto Falls	4	19	2	12
Ice Lake	3	14	6	9
Kersey Lake	5	70	11	32
Mystic Falls	6	62	9	38
Palisades Falls	10	32	3	14
Pine Creek Falls	8	75	16	47
Wraith Falls	6	42	6	18

**Figure 5-2:**  
**Trails often have maximum grades that are significantly steeper than typical running grades.**





the typical running grade and the maximum grade from 10 trail assessments. The maximum grade significantly exceed the typical running grade in all 10 examples.

The *rate of change of grade* is defined as the change in grade over a given distance. The rate of grade change is determined by measuring the grade and the distance over which it occurs for each segment of the overall distance. For the purposes of this report, rate of change of grade is measured over 0.610 m (2 ft) intervals, which represent the approximate length of a single walking pace and a wheelchair wheelbase.

In the trail environment, rate of change of grade should not exceed 13 percent. If the rate of change of grade exceeds 13 percent over a 0.610 m (2 ft) interval, the ground clearance of the footrests and or antitip wheels may be compromised. Antitip wheels are placed on the back of some wheelchairs to improve stability and prevent tipping. Even wheelchair users traveling slowly can get stuck if the footrest or antitip wheels get caught.

If the rate of change of grade exceeds 13 percent, the dynamic stability of the trail user can also be significantly compromised, depending on the speed at which the wheelchair user goes through the rapidly changing grade. Dynamic stability is compromised because the

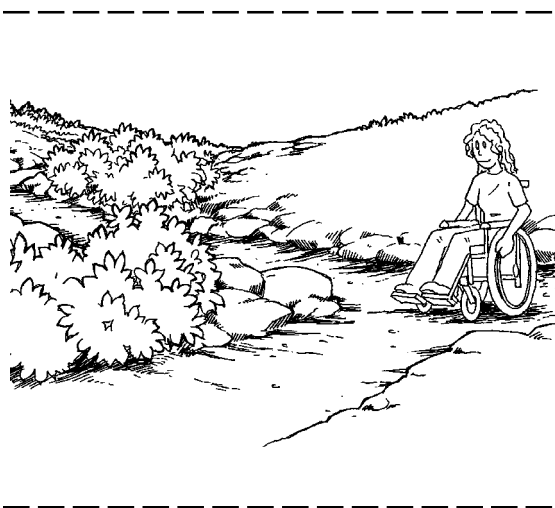
negative grade of the first sloped surface causes the wheelchair to rotate forward. However, upon reaching the bottom of the transition, the wheelchair begins to rapidly pitch back as the wheelchair transitions up onto the positive grade of the second sloped surface. Rapid changes in grade can also cause a wheelchair user traveling with speed to flip over backward. Any amount of height transition between the two sloped surfaces can further contribute to problems for wheelchair users.

Most design guidelines provide specifications for maximum allowable running grade over long distances and maximum grade between level areas. Tables 5-4.1 through 5-4.5 list design guidelines for maximum allowable running grade. Tables 5-5.1 through 5-5.5 list design guidelines for maximum grade between level landings.

The recommendations for running grade and maximum grade usually depend on the designated users of the trail. For example, grades up to 25 percent are typically permitted for snow machine trails, while the recommended running grade for Outdoor Recreation Access Routes is only 5 percent. The distances over which maximum grades are permitted to occur also vary by the type of user group. For example, the USDA Forest Service guidelines recommend a 20 percent maximum grade for 30 m (100 ft) on hiking trails, but a 20 percent maximum grade is permitted to extend for 61 m (200 ft) on ATV trails. In some instances, the location of the trail also might impact the running grade. For example, a trail that follows a stream may be permitted to have grades similar to those of the land contours.

Long switchbacks are often recommended in steep terrain to reduce grades (Figure 5-3). The steeper the terrain, the longer the switchbacks should be. In open areas, hikers and other user groups often create way trails to avoid traversing the entire switchback. A way trail is an informal

**Figure 5-3:**  
**Well-designed switchbacks reduce the grade of a trail and make hiking easier for people with mobility disabilities.**



path that allows users to travel a shorter distance by cutting across the land between the switchbacks. Way trails hasten soil erosion and destroy surrounding vegetation.

Installing landscaping barriers, such as shrubs, along switchbacks is one method to prevent hikers from creating way trails. However, a more cost-effective solution involves choosing switchback points with natural barriers, such as rocks or thick vegetation, as illustrated in Figure 5-3. Wherever possible, trails should be designed on more level terrain to maintain minimum design guidelines for grade and avoid the need for switchbacks.

### 5.4.2 Rest Areas

*Rest areas* are defined as level portions of a trail wide enough to provide wheelchair users and others a place to rest and gain relief from prevailing grade and cross-slope demands. Users can benefit from rest stops on steep or very exposed trails to pause from their exertions and enjoy the environment. Rest areas are most effective when placed at intermediate points, scenic lookouts, or near trail amenities. Rest areas located off the trail allow stopped trail users to move out of the way of continuing traffic (Figure 5-4). The most inviting rest areas have a bench, shade, a place to rest bicycles, and a trash receptacle. Water fountains and washroom facilities are also useful on long trails (FL DOT, 1997).

*Rest area interval* is defined as the distance between rest areas. Most agencies and private organizations that provide recommendations for rest area intervals concur with the 1994 Recreation Access Advisory Committee, which recommends that easier, moderate, and difficult trails should have rest areas at maximum intervals of 121.9 m, 274.3 m, and 365.8 m (400 ft, 900 ft, and 1200 ft), respectively. The California State Parks Guidelines call for rest areas on easier, moderate, and difficult ORARs

at maximum intervals of 61.0 m, 121.9 m, and 182.9 m (200 ft, 400 ft, and 600 ft), respectively. The New Mexico Plan specifies 402.5 m (1,321 ft) as the maximum allowable interval between rest areas on difficult trails.

### 5.4.3 Cross-Slope

*Cross-slope* is defined as the slope measured perpendicular to the direction of travel. Cross-slope must be measured at specific points. The average cross-slope is the average of cross-slopes measured at regular intervals along the trail. *Running cross-slope* is defined as the average cross-slope of a contiguous section of trail. The running cross-slope can be determined by taking periodic measurements throughout a section of trail and then averaging the values. *Maximum cross-slope* is defined as a limited section of the trail that exceeds the typical running cross-slope of the path.

*Rate of change of cross-slope* is defined as the change in cross-slope over a given distance. For the purposes of this report, rate of change of cross-slope was measured over 0.610 m (2 ft) intervals, which is the approximate length of a single walking pace and the wheelbase of a wheelchair. Rate of change of cross-slope can be measured by placing a level 0.610 m (2 ft) before and after a

**Figure 5-4:**  
**Rest areas enhance the trail for all users.**



maximum cross-slope. Rapidly changing cross-slopes can cause one wheel of a wheelchair or one leg of a walker to lose contact with the ground and also can cause walking pedestrians to stumble or fall.

A summary of the guidelines and recommendations for running cross-slope can be found at the end of the chapter in Tables 5-6.1 through 5-6.5. Most of the trail design specifications address maximum allowable running cross-slope but do not address maximum cross-slope for short distances. Table 5-1 contains the average and maximum cross-slope from 10 trail assessments. The maximum cross-slope significantly exceeds the average cross-slope in all 10 examples. Some trail users, including people in wheelchairs, may have difficulty negotiating extreme cross-slopes even for short distances. To address this concern, Axelson, Chesney, and Longmuir (1995) made recommendations for both average and maximum cross-slope. The recommendations differ from the majority of existing recommendations because they suggest maximum average grades and cross-slopes rather than maximum running grades and cross-slopes. On easier ORARs, they recommend a maximum cross-slope of 5 percent for a distance of 3.050 m (10 ft); and on easier recreational trails they recommend a maximum cross-slope of 5 percent for 3.660 m (12 ft).

The accessibility guidelines and most State guidelines for ORARs, access routes, recreational trails, and hiking trails require running cross-slopes that do not exceed 2 percent; however, some nongovernmental organizations recommend cross-slopes that exceed 2 percent. For example, Rathke and Baughman (1994) specify a maximum running cross-slope of 4 percent for hiking trails. Plae, Inc. (1993) and the Recreation Access Advisory Committee (1994) recommend a maximum running cross-slope of 3 percent for easy-level ORARs and recreational trails.

Table 5-2 contains the *AASHTO Green Book's* specifications for cross-slopes

**Table 5-2:**  
**Cross-Slope Ranges by Surface Type**  
(AASHTO, 1995)

Surface Type	Cross-Slope Range
High (highest pavement standard)	1.5–2.0%
Intermediate (slightly below high)	1.5–3.0%
Low (loose surface; earth, gravel, etc.)	2.0–6.0%

based on surface type. According to the *AASHTO Green Book*, a 1.5 percent cross-slope provides effective drainage in most weather conditions for surfaces with the highest pavement standards. Intermediate and low surface types, such as gravel, may require larger cross-slopes to enable adequate drainage (AASHTO, 1995).

A recently conducted pilot study has concluded that adults with and without disabilities are unable to distinguish between 2 and 3 percent cross-slopes (Axelson, Chesney, and Longmuir, 1995). Maintaining minimal cross-slope values can significantly increase the cost and environmental modifications required to build trails on steep terrain.

#### 5.4.4 Width

Two measurements, the *design width* and the *minimum clearance width*, are used to characterize trail width. *Design width* is defined as the width specification the trail was intended to meet. Some guidelines refer to design width as tread width. Some agencies recommend clearing brush from an area wider than the design width. *Minimum clearance width* is defined as the narrowest point on a trail. A minimum clearance width is created when the actual “usable surface” of the trail is substantially smaller than the full trail width. This can result from obstacles such as trees

protruding into the trail and reducing the clear space or from a reduction in the design width.

Trail features such as large rocks and fallen trees can be obstacles to trail users if they limit the passage space (the vertical clear space or clear width) of the trail. Although some obstacles might not impede a hiker or equestrian, they might impede the progress of those using strollers, wheelchairs, walkers, snow machines, or off-highway vehicles. Maintenance, reconstruction, and signage posted on the trail can help visitors avoid frustration and potential safety hazards when encountering obstacles such as a landslide that blocks a portion of the trail.

The types of user groups permitted on a trail affect its optimal design width. In general, the faster a user travels, the wider the trail must be to accommodate turns and limit collisions. For example, snow machines can attain speeds equivalent to those of automobiles and require the widest types of trails. Other user groups capable of faster travel than most pedestrians include OHVs, motorcycles, ATVs, bicyclists, equestrians, skaters, and skateboarders. Trails that accommodate such fast-moving technologies may be made narrower to increase the challenge to users, as with single-track mountain bike trails, or to limit user speed. However, more trail crashes and conflicts might occur on narrow trails if users travel fast despite width limitations.

The movement patterns of user groups also affect the design width of a trail. For example, skaters use a lateral foot motion for propulsion that is wider than the stride of most pedestrians. The width required to accommodate this motion increases when skiers and skaters wish to ascend grades or pick up speed. As a result, trails permitting these user groups should be wider than trails that permit only pedestrians.

Guidelines for minimum clearance width are presented in Tables 5-7.1 through 5-7.5, located at the end of this chapter. Many guidelines do not include recommendations for minimum clearance width. Guidelines that do address minimum clearance width generally concur with ADAAG, which specifies 0.915 m (36 in) of clear space (the passage space required for a wheelchair user) (ADAAG, U.S. Access Board, 1991).

### 5.4.5 Passing Space

*Passing space* is defined as a section of path wide enough to allow two wheelchair users to pass one another or travel abreast. *Passing space interval* is defined as the distance between passing spaces. Accessible passing spaces allow two wheelchairs to pass one another, or for one wheelchair user to turn in a complete circle. Passing spaces are recommended at regular intervals when the trail is narrow for long distances.

Many agencies and private organizations do not provide guidelines or recommendations for passing space or passing space intervals because their design width specifications are usually wide enough to allow for users to pass one another. Most guidelines that do address passing space concur with ADAAG's guidelines for accessible routes, which specify a passing space of at least 1.525 m x 1.525 m (60 in by 60 in) whenever an accessible route provides less than 1.525 m (60 in) of clear space. According to ADAAG, a T-intersection of two walkways is also an acceptable passing space (ADAAG, U.S. Access Board, 1991).

### 5.4.6 Changes in Level

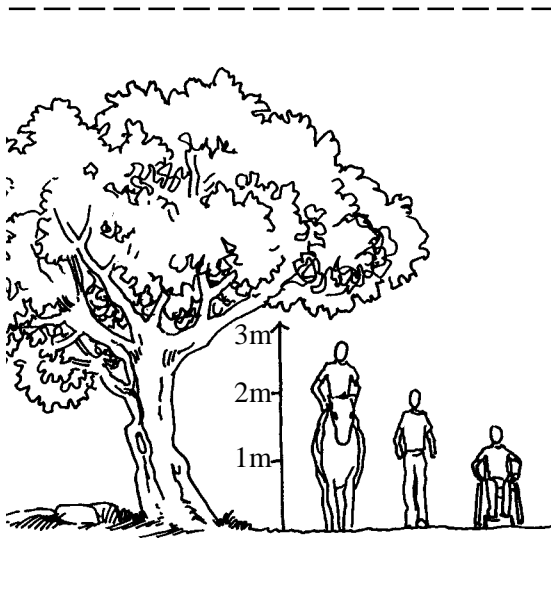
*Changes in level* are vertical height transitions between adjacent surfaces or along the surface of a path. Ruts caused by weather erosion, tree roots

**Figure 5-5:**  
**Tree roots that break up the surface of the trail should be removed because they can cause users to trip.**



(Figure 5-5), and rocks protruding from the trail surface are common sources of changes in level on trails. Trails with surface materials such as soil and crushed rock almost always have small changes in level. Changes in level can cause many difficulties for people with mobility impairments, such as cane or crutch users. Many cane and crutch users have difficulty lifting their feet high up off the ground, and abrupt changes in level can cause them to trip or fall. People using wheeled

**Figure 5-6:**  
**The vertical clearance of a trail should depend on the designated user groups.**



devices such as bicycles, wheelchairs, and scooters can easily catch their wheels in small changes in level, which can cause them to tip over.

Guidelines for changes in level are listed in Tables 5-8.1 through 5-8.5, located at the end of this chapter. The ADA Standards for Accessible Design and UFAS permit changes in level of less than 6 mm (0.24 in) to be vertical but changes in level between 6 mm (0.25 in) and 13 mm (0.5 in) to have a 50 percent bevel (US DOJ, 1991; UFAS, US DoD et al., 1984). An accessible ramp is required for changes in level that exceed 13 mm (0.5 in). Some States and private organizations allow vertical changes in level up to 13 mm (0.5 in).

### 5.4.7 Vertical Clearance

*Vertical clearance* is the minimum unobstructed vertical passage space required along a trail. Guidelines and recommendations for vertical clearance are contained in Tables 5-9.1 through 5-9.5, located at the end of this chapter. Specifications for vertical clearance vary depending on the designated trail users (Figure 5-6). For example, guidelines for trails that permit equestrians typically specify a vertical clearance of 3.050 m (10 ft), while trails that permit only hikers typically require a vertical clearance of 2.030 m (80 in). Because cane or crutch users might have difficulty ducking under vertical obstructions, sufficient vertical clearance is necessary to allow them to remain upright while proceeding along a trail. The height of the average blanket of snow added each winter should also be taken into account for trails that allow cross-country skiing and snow machining.

### 5.4.8 Surface

The surfacing material on a trail significantly affects which user groups will be capable of negotiating the path. Soft surfaces, e.g., sand and gravel, are

more difficult for all users to negotiate (Figure 5-7). They present particular hazards for those using wheeled devices such as road bicycles, strollers, and wheelchairs not designed for outdoor terrain. In contrast, unpaved surfaces might be preferred by equestrians and runners to prevent excessive jarring of the joints and skeleton. Others, such as mountain bikers and off-road wheelchair users, often prefer unpaved surfaces for the thrill and challenge of negotiating rough terrain.

Local conditions also determine the choice of trail surfaces. Recreational trail surfaces are most commonly composed of naturally occurring soil; however, surfaces ranging from concrete to wood chips may be used depending on the designated user types, the anticipated volume of traffic, the climate, and the conditions of the surrounding environment. High-use trails passing through developed areas and fragile environments are commonly surfaced with pavement, crushed rock, or soils mixed with stabilizing agents to minimize the impact of human traffic on the path.

Locations where the surface changes unexpectedly can frustrate or even endanger trail users unable to negotiate the new surface. This is especially critical in areas where surface conditions change dramatically, i.e., from a paved trail to a sandy beach. Providing information about surface changes through signage or other trail guide products can help visitors avoid such problems.

#### 5.4.9 Trail Information

People select trails based on a variety of criteria, including personal interest, destination, environment, and desired difficulty. Accurate and detailed trail information can provide users with sufficient data to choose routes appropriate to their skill level and desired experience. Trail information can be provided in many formats, including signs, maps, computer

**Figure 5-7:**  
**Soft surfaces are difficult for people with mobility impairments to negotiate and therefore should be avoided.**



programs, posters at park information stations, audio descriptions, and published travel guides. Trail information has traditionally been limited to the trail length, elevation change, usage rules, destination, and descriptive information about points of interest. Signage that provides objective and detailed information about potential obstacles, surface type, grade, cross-slope, and other trail features further benefits users by allowing them to accurately assess whether or not a trail meets their personal level of safety, comfort, and access. Trail users with visual impairments benefit from signs with large lettering, Braille panels, raised lettering, or audio boxes that play prerecorded trail information at the push of a button.

According to ADAAG, “Letters and numbers on signs shall have a width-to-height ratio between 3:5 and 1:1 and a stroke-width-to-height ratio between 1:5 and 1:10.” ADAAG also indicates that the letters and numbers of signs designating permanent locations, such as the woman or man indicators on a bathroom door, be raised 0.8 mm (0.03 in) from the surrounding surface and be in upper case, sans serif, or simple serif type. Type should always be accompanied by Grade 2 Braille. The background color of a sign should contrast with the color of the lettering (ADAAG, U.S. Access Board, 1991). Signs should not be placed

in locations where they obstruct the minimum clearance width or vertical clearance of the trail.

The MUTCD references the *Standard Alphabets for Highway Signs and Pavement Markings*, which permits a series of six letter types on signs. Each letter type features a different-stroke width-to-height ratio (Office of Traffic Operations, FHWA, 1982). Various sign, shapes, colors, and lettering are reserved for different types of information such as warnings, destinations, and regulatory functions. The MUTCD does not address the use of Braille and raised lettering (US DOT, 1988).

In a report to the U.S. Access Board, the Recreation Access Advisory Committee recommended that trail type and difficulty level be displayed for all ORARs and recreational trails. The Committee further recommended that maps and signage be provided to users with information on running and maximum grade, maximum cross-slope, minimum trail width, surface type, and magnitude of obstacles (Recreation Access Advisory Committee, 1994).

Trail signs should be appropriate for the environment in which they are located. For example, recreational trails could provide signs on wooden posts to meet user expectations of a “natural” environment.

#### **5.4.10 Maintenance**

Trail maintenance keeps trails at or near constructed or intended conditions. Regular trail maintenance can enhance visitor safety, protect resources, and provide continued access to the public.

Regular inspections to identify public safety issues, routine maintenance needs, and resource management problems help ensure that trails remain safe, accessible, and in good condition. Once problems are identified, managers can schedule corrections through a maintenance program.

A system to assess and catalog problems on trails can be used to obtain a comprehensive list of potential maintenance items. All human-built structures on the trail, such as bridges and retaining walls, should be inventoried. The structural integrity and general condition of all features may be assessed at the same time as needed repairs, upgrading, or replacements are recorded. The inspection may include an analysis of the trail surface conditions to identify and measure the extent of entrenchment, drainage, and obstacle problems. A comprehensive list of maintenance items also helps trail managers prioritize and budget for trail repair and improvement projects. When a trail is severely deteriorated, rerouting might be the best alternative to attempting maintenance.

Trail maintenance activities entail a number of preventative and corrective actions (Beers, 1993):

1. Checking the structural integrity of trail features, such as bridges, steps, and railings, and repairing damages.
2. Keeping the tread surface free of obstacles or hazards, such as downed trees and landslides. Loose rocks and earth in a disturbed area should be removed and the trail tread restored to its intended state.
3. Clearing and maintaining drainage features to minimize trail erosion and environmental damage. Drainage methods causing the least impact on the natural environment should be used. In order of least to most damaging, these methods include clearing drainage channels, maintaining outslope of the trail bed, cleaning drain dips or water bars, clearing parallel ditches, and cleaning culverts through or beneath the trail.
4. Cutting vegetation to define the established trail tread and/or protect resources adjacent to the trail.
5. Maintaining the tread in a condition that can be negotiated by trail users.

Tread maintenance can include restoring sloped or crowned surfaces to facilitate drainage, extending the trail back to its original width, filling ruts and holes, and restoring raised approaches to bridges.

## 5.5 Design Conflicts

The many types of users and varied terrain along which trails are constructed can place competing demands upon trail designers. To minimize impact on the environment while maintaining user safety and avoiding potential user conflicts, trail designers must understand how design specifications affect user interactions and activities. The following discussions provide examples of design conflicts that can occur in trail environments.

### 5.5.1 Trail Elements

The scope and design of trail elements, e.g., bridges and water bars, should be appropriate to the conditions of the trail and the needs of the full range of users. The accessibility and safety of a trail might be significantly compromised if trail elements do not provide a level of accommodation consistent with the surrounding environment. For example, a trail user negotiating a paved, level path would expect to use an accessible bridge, not a fallen log, when crossing a stream (Figure 5-8). When a trail element along an accessible trail is not consistent with the trail’s overall design, a user might be forced to turn back in frustration before reaching his or her destination. If the trail user chooses not to turn back and attempts to continue along the path, he or she risks possible injury.

### 5.5.2 Built Facilities Along Trails

People with disabilities participate in all types of trail activities at a wide range of skill levels. For example, a person with a mobility impairment might be an advanced horse rider. In addition, a person with a mobility impairment might use a

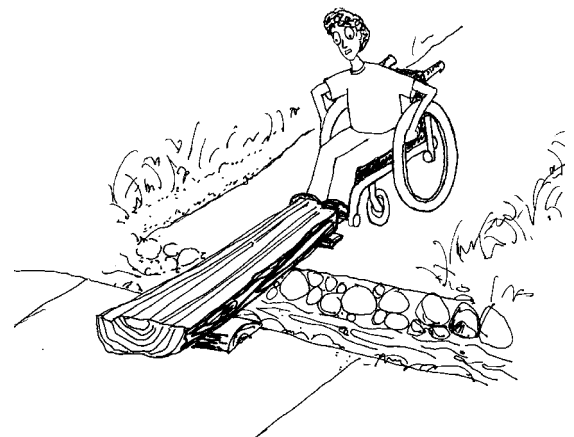
mechanical device, such as an ATV, to reach trail segments that would not ordinarily be accessible to him or her.

It is critical that built facilities, such as restrooms and parking lots at the trailhead and along the trail, be accessible, to address the reality that people with disabilities use all types of trails. ADAAG provides scoping requirements for all built facilities along an accessible route, including restrooms, drinking fountains, and parking lots. The number of accessible spaces required in parking lots, for example, is listed in Table 5-3. All new or remodeled

**Table 5-3:**  
**Scoping Requirements for Accessible Parking Spaces**

Total Parking in Lot	Required Minimum No. of Accessible Spaces
1 to 25	1
26 to 50	2
51 to 75	3
76 to 100	4
101 to 150	5
151 to 200	6
201 to 300	7
301 to 400	8
401 to 500	9
501 to 1000	2 percent of total
over 1000	20 plus 1 for each 100

**Figure 5-8:**  
**If a trail is accessible, the trail elements along the path also should be accessible.**





built trail facilities provided along a trail or at the trailhead should be built to ADAAG specifications, regardless of the user types permitted or the difficulty level of the trail.

### 5.5.3 Designing Trail Amenities for Multiple User Groups

Different types of users have distinct needs for trail amenities. For example, bicyclists might need facilities such as bike racks that are easy to use and highly visible (Ryan, 1993). Equestrians require hitching posts and water troughs near stopping points such as picnic tables. Equestrians also need staging and rest areas large enough to accommodate the movements of a horse (ibid.). OHV users require a testing circle, or “landing,” to determine if their equipment is operating correctly. The needs of all user groups should be included during the development stage of a trail facility to ensure that adequate amenities are available.

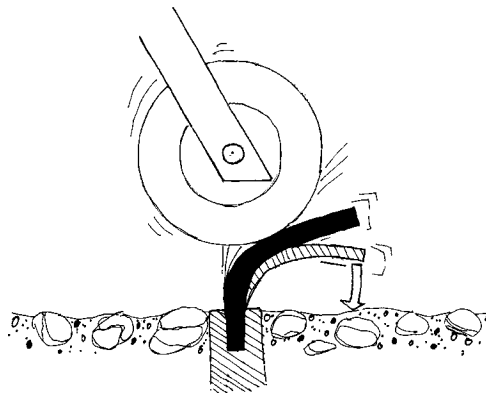
### 5.5.4 Drainage Control Measures and Access

Excessive water on a trail can significantly limit trail use, creating conditions harmful to the trail and hazardous to the user. In addition, excess water accelerates erosion and damages the trail surface. Users seeking to avoid the wet conditions might trample adjacent vegetation or cut damaging way trails.

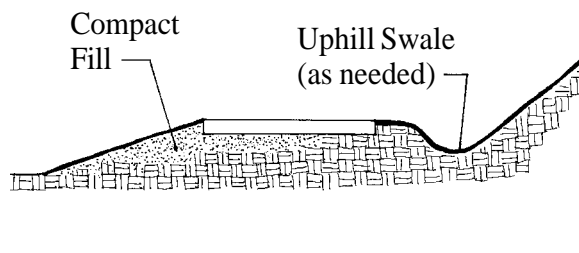
Some cross-slope is needed along a trail to allow water to drain off the path. However, excessive cross-slopes are difficult for people with mobility disabilities to negotiate. For more information on cross-slope, refer to Section 5.4.3.

Drainage bars are often used to encourage the flow of water off the trail. The presence of drainage bars can significantly impact access for trail users. Drainage bars consist of rock, wood, or rubber structures placed across the trail tread to divert water off the trail on steep slopes. All drainage bars can be difficult for people using wheelchairs and other wheeled devices to cross. However, thin rubber drainage bars that flex (Figure 5-9) are easier to travel over than drainage bars made of inflexible materials such as rock. Trails where many users are expected to use wheeled devices, such as shared-use paths in urban areas, should never have drainage bars. Wheeled trail users often attempt to travel around the ends of drainage bars rather than over them, cutting a channel that renders the drainage bar ineffective. Swales (Figure 5-10) and drainage channels can provide the same degree of water runoff while affording better access than drainage bars. However, building trails with less extreme slopes is the easiest manner to avoid the need for drainage bars.

**Figure 5-9:**  
*Rubber waterbars are difficult for wheelchair users and bikers to push down traveling uphill, but they are still more desirable than inflexible waterbars.*



**Figure 5-10:**  
*Swales can control drainage and eliminate the need for waterbars.*



Where water flow is consistent, culverts, short sections of boardwalk, or bridging can be provided. Swamps and other areas that drain poorly might be closed during

certain times such as spring thaw. Porous surfacing materials such as gravel, wood chips, or corduroys (logs or rocks laid on or in the path of travel) may be used to improve drainage and mitigate trail erosion.

### **5.5.5 Complying with Design Standards**

Flexibility in applying guideline specifications might be necessary to acknowledge the diversity of outdoor environments. Variations in terrain, changing outdoor conditions, time periods between access and maintenance reviews, and conflicts between design standards for different user groups are among the factors that can affect the implementation of design guidelines. Design guidelines that cannot realistically be met in some natural environments create an unworkable situation for trail designers. In the worst-case scenario, trail designers might feel that meeting rigid guidelines is impossible and ultimately ignore all design recommendations. For this reason, design guidelines for trails are most effective when they contain provisions to address situations when full compliance is not feasible or desirable.

### **5.5.6 Difficulty Ratings for Trails**

Subjective trail difficulty ratings can be misleading because challenge levels are often determined relative to the trails within a given park or forest area, instead of being based on objective information. As a result, visitors cannot be certain that a trail rated difficult in one area will provide the same challenge as one with the same rating at another area.

Furthermore, most trail rating systems do not allow changes in the design parameters of a trail, and the same difficulty rating can be unrealistic to apply over the full length of a trail. This is especially true for trails that meander through extremely varied terrain. For

example, Pine Creek Trail in the Gallatin National Forest in Montana provides access from a campground to a creek, then climbs out of a canyon and across a plateau to a lake. The hike to the creek access is paved and level, requiring approximately 10 minutes to complete, while the rest of the trail is about 8 km long and requires many hours to finish. If considered across its full length, Pine Creek Trail would most likely be categorized as “most difficult,” even though the segment from the trailhead to the creek provides an easier level of access.

Instead of labeling trails with difficulty ratings, trail managers should consider disclosing objective measurement information about trail conditions to visitors. Trail information provided via formats such as signage can convey surface type, grade, cross-slope, and width information. Such information can help visitors determine for themselves which trails will help them achieve their desired experience.

## **5.6 User Conflicts**

When a trail user fails to achieve his or her desired experience from the trip and determines that it is due to someone else’s behavior, conflict results and satisfaction suffers. Conflict is not the same as competition for scarce resources. If people attribute not getting a parking place to their own lack of planning, there is no conflict (Moore, 1994). Conflicts among trail users can stem from a variety of sources, including personal expectations, clashes between different skill levels and speeds, attitudes toward other types of trail users, and intrinsic differences in movement patterns.

### **5.6.1 Experience Level**

Conflicts can arise when trail users with different levels of experience interact

because experts and novices often do not mix well. Skill level affects how well a trail user can maneuver a vehicle or animal. For example, some equestrians might not have sufficient skill to prevent their mounts from running away or kicking other trail users. Similarly, new cyclists might not be aware of the custom of ringing a bell or providing an audible warning before passing other trail users.

The level of intensity at which an activity is pursued also generates user conflicts. For example, fit and experienced bicyclists tend to travel quickly and aggressively. Their approach from behind might frighten less experienced bicyclists.

### **5.6.2 Expectations**

Discrepancies between trail expectations can cause conflicts between users. Many people enjoy trails because they desire a quiet respite from their busy lives. Other people expect an area where they can seek adventure and make noise without disturbing neighbors. When these groups encounter one another on a trail, conflict over expectations often ensues. For example, bird watchers expecting tranquil, undisturbed surroundings might be angry to encounter noise from OHV riders along a trail. Large groups, such as classes of excited schoolchildren, also might disturb other trail users by foiling their expectations of privacy and relaxation. People who view trails as a largely natural environment might become hostile toward trail users who litter or play loud music.

### **5.6.3 Conflicts Among User Groups**

Conflicts on trails most frequently stem from the attitudes of different user groups. Trail users traveling at different speeds and following different movement patterns might clash in attitude and expectation.

#### **5.6.3.1 Technology differences**

Discrepancies in the level of technology used on a trail can be a major source of friction between trail users. Those hiking or using nonmotorized technologies such as cross-country skis tend to have more conflicts with users of motorized vehicles, such as snow machines, than vice versa. Recreational technologies such as mountain bikes and OHVs permit trail users to travel faster than pedestrians, who might complain of being startled by the sudden appearance and fast approach of these users. The speeds attained and the surface disturbance caused by motorized technologies can make hikers or those using a quiet mobility device such as a wheelchair feel threatened and overwhelmed. In general, the greater the difference in the level of technology used, the more likely the “low-tech” user will be to develop hostilities (Moore, 1994).

#### **5.6.3.2 Movement patterns**

Movement patterns vary significantly between user groups and is another potential source of trail conflict. Trail users travel at different speeds and require different amounts of space to move forward, stop, and turn. For example, skaters might occupy a larger width of trail than other users due to their kick-out propulsion method. Users who move at high speeds, e.g., snow machine users and bicyclists, require longer stopping and maneuvering distances. Those who use larger devices, such as OHVs or recumbent bicycles, also require more space to turn than pedestrians or wheelchair users, who are quite maneuverable. Sudden changes in direction can leave other trail users without sufficient time to react. Resulting collisions or near-misses can lead to hostilities. Separating different types of trail users (Figure 5-11), limiting speeds using design techniques such as shorter sight distances, and designing wider trails might mitigate movement pattern conflicts.

### 5.6.3.3 Perceived environmental impact

Perceived environmental disturbance also creates conflict between hikers and those who use recreation technologies to enjoy trails. Because equestrian, OHV, and mountain bike use can hasten erosion of soft surfaces so that they become more difficult to negotiate for other users (Cimarron Designs, 1994), hikers often perceive these groups as “ruining” trails or surrounding natural areas (Ryan, 1993). This perception, however, does not take into consideration the fact that hikers damage trails and soils as well.

The combined size and power of some trail users and their mode of transport can frighten or intimidate others. For example, a cross-country skier might feel that encounters with large, loud snow machines are unsafe and overwhelming (Moore, 1994). Conflicts between equestrians and other trail users can occur because horses are often skittish and can startle or bolt, creating a hazard for other trail users. Those unaccustomed to being around horses might unwittingly provoke them to bite, rear, or flee by petting or otherwise approaching them. Other trail users might feel threatened by the size or proximity of a horse.

### 5.6.3.4 New and newly popularized sports

People encountering an activity or technology for the first time on a trail can be suspicious and wary of the behavior, appropriateness, and demeanor of the newcomers. For example, new sports often attract young people; their boisterous behavior can often antagonize older trail users disturbed by the noise. When an activity such as in-line skating suddenly becomes popular, many people with little control over their speed and maneuverability appear on trails. The seemingly reckless and irresponsible behavior of novices often causes other trail users to develop negative stereotypes

about those who practice the activity. New and newly popularized sports also tend to lack established standards of etiquette. As a result, those who encounter people using the new technology do not know how to react to the newcomers.

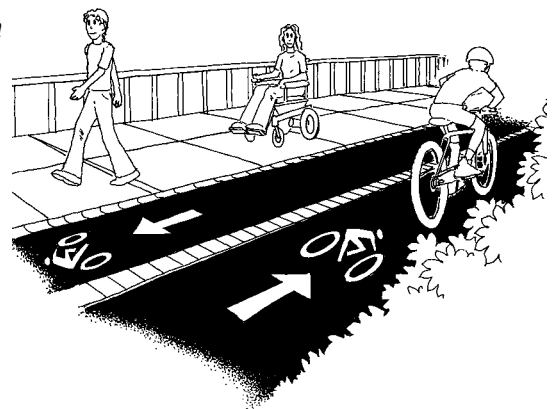
As more people participate in a new sport, other trail users gain experience interacting with the newcomers. As the new activity becomes established, etiquette standards become more widely known, followed, and understood by all trail users. For example, good trail-user ethics have recently been developed and publicized for mountain biking, a relatively new trail activity. Once learned by more users, these etiquette standards will help mitigate the conflicts between bikers and other trail users. Another method of blending new users into an established trail community is to encourage use of appropriate equipment and behavior in promotional programs (Moore, 1994).

### 5.6.4 Lack of Communication Among Trail Users

A lack of communication between different trail users is the root of many clashes and collisions on trails. Users must realize that communication is a two-way interaction and make an effort

**Figure 5-11:**

***Separate pathways and clear signage can help reduce conflicts between users who travel at different speeds.***



to warn others of their needs and intentions. For example, cyclists overtaking a pedestrian might communicate their approach through an audible signal such as their voice or a bell but might also opt to use hand and arm turning signals. For communication to be successful, those receiving the signal must understand its meaning. For instance, a person who is Deaf or hard of hearing might not detect the ringing of a bicycle bell, or some people might not understand that an outstretched, bent arm indicates a right turn. If trail users are schooled in a basic and universal system of communication, such as what ringing a bike bell means, chances for conflict and crashes are minimized. Signs, speed limits, and good user etiquette can also help minimize hostility between groups (Ryan, 1993).

### 5.6.5 Number of Users

The number of trail users will increase the chances of conflicts, regardless of the mix of user groups. For example, if backpackers seeking solitude encounter more users on the trail than expected, their frustration at being unable to find an uncrowded area might spur them to initiate a conflict with other users.

### 5.6.6 Minimizing User Conflicts on Trails

Promoting responsible behavior on trails can minimize user conflict. Trail etiquette

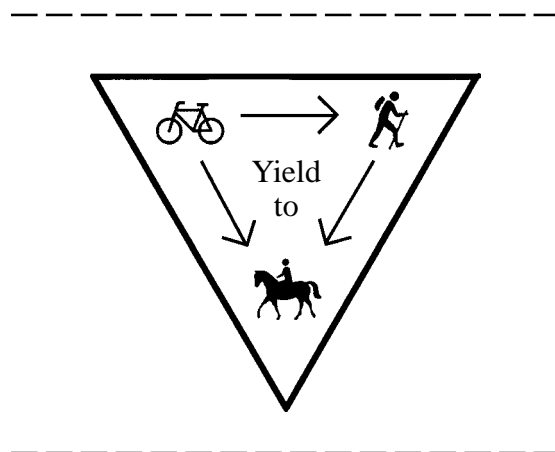
standards can be publicized on trail signs (Figure 5-12) and in existing educational materials (Orwig, 1995). Trail users might be less likely to become offended at the actions of other people once they understand how each group is supposed to act. Trail users also might be less likely to violate an established code of behavior if they believe the rules will be enforced by trail personnel.

Minimizing contact between conflicting types of trail users, especially in congested areas such as trailheads, can be the best method to avoid trail problems. Providing several entrances to a single trail, or several trails at a variety of difficulty levels, can help reduce conflicts between individual user types (Orwig, 1995). Trails that permit only trail users that have similar needs and expectations might have fewer incidences of user conflicts than trails that permit motorized users to mix with nonmotorized users. A good understanding of the needs and behavior of different groups is essential to make wise trail-use decisions.

Ultimately, trail managers must have a good understanding of the motivations, desired experiences, and points of view of various trail user groups (Moore, 1994). This information can help trail managers anticipate conflicts before they arise and identify solutions satisfactory to the majority of trail users. Trail managers can obtain information on existing conflicts and gather proposed solutions by meeting with individual user groups, including people with disabilities. These contacts can be used to call a negotiation meeting if conflicts arise in the future. Such a meeting can help all parties arrive at a consensus on how to address the problem.

Although eliminating all trail conflicts on very crowded or otherwise problematic trails might not be possible, conflict-mitigation techniques will usually help reduce the effects of such dilemmas.

**Figure 5-12:**  
Trail signs can help clarify trail etiquette.



## **5.7 Conclusion**

Everyone should have the opportunity to experience and enjoy the natural environment. People with and without disabilities, older people, families, and children all benefit from being able to enjoy parks and forests. To the maximum extent feasible, trails should be designed to accommodate the access needs of all designated users. Considering accessibility when designing trails and installing accessible built facilities such as wheelchair-accessible toilets, Braille displays in visitor centers, and lowered

drinking fountains will permit more people to enjoy the outdoors. In addition, providing detailed information about existing path conditions and available facilities can help visitors select trails. Such trail information reduces the likelihood that a trail user will become stranded or endangered and can improve safety and visitor enjoyment. Although increased use might be accompanied by increased conflicts between different types of trail users, land managers can minimize friction between groups by using good trail-management techniques.

**Table 5-4.1:**  
**Federal Accessibility Guidelines for Maximum Allowable Running Slope without Landings and Handrails**

Source	Path Type	Single Level %	Multiple Levels		
			Easier %	Moderate %	Difficult %
ADA Standards for Access. Design <sup>1</sup> (US DOJ, 1991)	AR	5 <sup>2</sup>			
UFAS (US DoD, et al., 1984)	AR	5 <sup>2</sup>			

<sup>1</sup> The ADA Standards for Accessible Design are identical in content to ADAAG Sections 1–10. However, the Design Standards are enforceable by the U.S. Department of Justice.

<sup>2</sup> The ADA Standards for Accessible Design and UFAS both require people to use the least slope possible on accessible routes. An accessible route with a running slope greater than 5% is considered a ramp whose slope should be the least possible but may not exceed 8.33% (see Table 5-5.1).

**Table 5-4.2:**  
**Federal Advisory Committee Recommendations for Maximum Allowable Running Grade**

Source	Path Type	Single Level %	Multiple Levels		
			Easier %	Moderate %	Difficult %
Recommendations for Accessibility Guidelines: Recreational Facilities. . . (Rec. Access. Adv. Comm., 1994)	ORAR		5	5	8
Recommendations for Accessibility Guidelines: Recreational Facilities. . . (Rec. Access. Adv. Comm., 1994)	RT		5	8	12

**Table 5-4.3:**  
**Federal Guidelines for Maximum Allowable Running Grade**

Source	Path Type	Single Level %	Multiple Levels		
			Easier %	Moderate %	Difficult %
USDA FS Trails Mgt. Handbook (USDA FS, 1985)	H		n/a	n/a	n/a
Guide for the Dev. of Bicycle Facilities (AASHTO, 1997, Draft)	S	5			
Guide for the Dev. of Bicycle Facilities (AASHTO, 1991)	B	5			
USDA FS Trails Mgt. Handbook (USDA FS, 1985)	E		n/a	n/a	n/a
USDA FS Trails Mgt. Handbook (USDA FS, 1985)	X		7.5	12	17
USDA FS Trails Mgt. Handbook (USDA FS, 1985)	SM		8	n/a	15
USDA FS Trails Mgt. Handbook (USDA FS, 1985)	ATV		15	25	35

AR = Accessible Route  
 H = Hiking Trail  
 MB = Mountain Biking Trail  
 SM = Snow Machine Trail  
 OHV = Off-Highway Vehicle Trail  
 ORAR = Outdoor Recreation Access Route  
 S = Shared-Use Path  
 E = Equestrian Trail  
 ATV = All-Terrain Vehicle Trail  
 M = Motorcycle Trail  
 RT = Recreational Trail  
 B = Bicycle Path  
 X = Cross-Country Ski Trail

**Table 5-4.4:**  
**State, County, and City Guidelines for Maximum Allowable Running Grade**

Source	Path Type	Single Level %	Multiple Levels		
			Easier %	Moderate %	Difficult %
Klamath District's Trail . . . (Beers, 1993, Draft)	ORAR	5			
NM Plan for Accessible Fishing (Nordhaus, et al., 1984)	ORAR		5	6.3	8.33
Access to Parks Guidelines (CA State Parks, 1997)	RT		< 5	5	6.3
Ped. Facilities Guidebook for WA DOT (WA DOT, 1997)	RT		5	8.33	12.5
Alaska Region Trails Const. (USDA FS, AK Reg. FS, 1991)	H		n/a	n/a	n/a
MO St. Parks Trail Const. Guidelines (MO DNR, 1975)	H	10			
PA Plan for Nonmotorized Trails (PA Trails Pgm., 1980b)	H	10			
FL Bicycle Facilities Planning. . . (FL DOT. . ., 1997)	S	5			
Oregon Bicycle and Ped. Plan (OR DOT, 1995)	S	5			
Pitkin City Trails Dgn. and Mgt. . . . (Cimarron Designs, 1994)	S	5			
KY Dept. of Parks Trail Construction. . . (KY Dept. of Parks, 1989)	B	15			
MO St. Parks Trail Const. Guidelines (MO DNR, 1975)	B	n/a			
PA Plan for Nonmotorized Trails (PA Trails Pgm., 1980b)	B	5			
Wisconsin DNR Design Standards (WI DNR, 1994)	B	15			
KY Dept. of Parks Trail Construction. . . (KY Dept. of Parks, 1989)	E	15			
MO St. Parks Trail Const. Guidelines (MO DNR, 1975)	E	10			
PA Plan for Nonmotorized Trails (PA Trails Pgm., 1980b)	E	15			
Wisconsin DNR Design Standards (WI DNR, 1994)	E	15			
PA Plan for Nonmotorized Trails (PA Trails Pgm., 1980b)	X			8	17
PA Plan for Motorized Trails (PA Trails Pgm., 1980a)	SM	25			
Wisconsin DNR Design Standards (WI DNR, 1994)	SM	25			
PA Plan for Motorized Trails (PA Trails Pgm., 1980a)	ATV	75			
Wisconsin DNR Design Standards (WI DNR, 1994)	ATV	n/a			

AR = Accessible Route  
H = Hiking Trail  
MB = Mountain Biking Trail  
SM = Snow Machine Trail  
OHV = Off-Highway Vehicle Trail

ORAR = Outdoor Recreation Access Route  
S = Shared-Use Path  
E = Equestrian Trail  
ATV = All-Terrain Vehicle Trail  
M = Motorcycle Trail

RT = Recreational Trail  
B = Bicycle Path  
X = Cross-Country Ski Trail



**Table 5-4.5:**  
**Additional Recommendations for Maximum Allowable Running Grade**

Source	Path Type	Single Level %	Multiple Levels		
			Easier %	Moderate %	Difficult %
ORAR and RT Design Specification (Axelson et al., 1995) <sup>1</sup>	ORAR		5	8	10
Universal Access. to Outdoor Rec. (PLAE, Inc., 1993)	ORAR		5	5	8.33
ORAR and RT Design Specification (Axelson et al., 1995) <sup>1</sup>	RT		8	10	14
Universal Access. to Outdoor Rec. (PLAE, Inc., 1993)	RT		5	8.33	12.5
Recreational Trail Design and Const. (Rathke and Baughman, 1994)	H	15			
Trails for the 21st Century (Ryan, 1993)	S	5			
Recreational Trail Design and Const. (Rathke and Baughman, 1994)	B	10			
Trails for the 21st Century (Ryan, 1993)	B	8			
Mountain Bike Trails: Tech for. . . (McCoy and Stoner, 1992)	MB		5	10	15
Recreational Trail Design and Const. (Rathke and Baughman, 1994)	E	10			
Trails for the 21st Century (Ryan, 1993)	E	10			
Recreational Trail Design and Const. (Rathke and Baughman, 1994)	X	10			
Trails for the 21st Century (Ryan, 1993)	X	5			
Recreational Trail Design and Const. (Rathke and Baughman, 1994)	SM	25			
Trails for the 21st Century (Ryan, 1993)	SM	n/a			
OHM and ATV Trails Guidelines for Dgn. . . . (Wemex, 1994)	ATV		8	12	15

<sup>1</sup> Maximum allowable average grade not running grade.

AR = Accessible Route                      ORAR = Outdoor Recreation Access Route                      RT = Recreational Trail  
H = Hiking Trail                              S = Shared-Use Path                              B = Bicycle Path  
MB = Mountain Biking Trail                      E = Equestrian Trail                              X = Cross-Country Ski Trail  
SM = Snow Machine Trail                      ATV = All-Terrain Vehicle Trail  
OHV = Off-Highway Vehicle Trail                      M = Motorcycle Trail

**Table 5-5.1:****Federal Accessibility Guidelines for Maximum Slope for a Specified Ramp Run with Landings and Handrails**

Source	Path Type	Single Level		Multiple Levels					
				Easier		Moderate		Difficult	
		Grade %	Run m	Grade %	Run m	Grade %	Run m	Grade %	Run m
ADA Standards for Access. Design (US DOJ, 1991)	AR	8.33 <sup>1</sup>	9.1						
UFAS (US DoD, et al., 1984)	AR	8.33 <sup>1</sup>	9.1						

<sup>1</sup> ADA Standards for Accessible Design and UFAS both require people to use the least slope possible on accessible routes.

**Table 5-5.2:****Federal Advisory Committee Recommendations for Maximum Grade for a Specified Distance (Run)**

Source	Path Type	Single Level		Multiple Levels					
				Easier		Moderate		Difficult	
		Grade %	Run m	Grade %	Run m	Grade %	Run m	Grade %	Run m
Recommendations for Accessibility Guidelines: Recreational Facilities... (Rec. Access. Adv. Comm., 1994)	ORAR			8	9.1	10	15.2	10	15.2
Recommendations for Accessibility Guidelines: Recreational Facilities... (Rec. Access. Adv. Comm., 1994)	RT			10	9.1	14	15.2	20	15.2

**Table 5-5.3:****Federal Guidelines for Maximum Grade for a Specified Distance (Run)**

Source	Path Type	Single Level		Multiple Levels					
				Easier		Moderate		Difficult	
		Grade %	Run m	Grade %	Run m	Grade %	Run m	Grade %	Run m
USDA FS Trails Mgt. Handbook (USDA FS, 1985)	H			20	30.5	30	91.4	+30	152.4
Guide for the Dev. of Bicycle Facilities (AASHTO, 1997, Draft)	S	+11	15						
Guide for the Dev. of Bicycle Facilities (AASHTO, 1991)	B	n/a	n/a						
USDA FS Trails Mgt. Handbook (USDA FS, 1985)	E			15	61	25	91.4	+30	152.4
USDA FS Trails Mgt. Handbook (USDA FS, 1985)	X			10	30.5	20	30.5	n/a	n/a
USDA FS Trails Mgt. Handbook (USDA FS, 1985)	SM			25	n/a <sup>1</sup>	n/a	n/a	35	n/a <sup>1</sup>
USDA FS Trails Mgt. Handbook (USDA FS, 1985)	ATV			20	61.0	30	91.4	50	152.4

<sup>1</sup> The requirement was for maximum pitch, no distance was specified.

AR = Accessible Route	ORAR = Outdoor Recreation Access Route	RT = Recreational Trail
H = Hiking Trail	S = Shared-Use Path	B = Bicycle Path
MB = Mountain Biking Trail	E = Equestrian Trail	X = Cross-Country Ski Trail
SM = Snow Machine Trail	ATV = All-Terrain Vehicle Trail	
OHV = Off-Highway Vehicle Trail	M = Motorcycle Trail	

**Table 5-5.4:**  
**State, County, and City Guidelines for Maximum Grade for a Specified Distance (Run)**

Source	Path Type	Single Level		Multiple Levels					
		Grade %	Run m	Easier		Moderate		Difficult	
				Grade %	Run m	Grade %	Run m	Grade %	Run m
Klamath District's Trail . . . (Beers, 1993, Draft)	ORAR	8.33	9.1						
NM Plan for Accessible Fishing (Nordhaus, et al., 1984)	ORAR			8.33	9.1	8.33	9.1	8.33	9.1
Access to Parks Guidelines (CA State Parks, 1997)	RT			5	15.2	6.3	12.2	8.33	9.1
Ped. Facilities Guidebook for WA DOT (WA DOT, 1997)	RT			8.33	9.1	14	15.2	20	15.2
Alaska Region Trails Const. (USDA FS, AK Reg. FS, 1991)	H			20	30.5	30	91.4	+30	152.4
MO St. Parks Trail Const. Guidelines (MO DNR, 1975)	H	15	n/a <sup>1</sup>						
PA Plan for Nonmotorized Trails (PA Trails Pgm., 1980b)	H	20	n/a <sup>2</sup>						
FL Bicycle Facilities Planning. . . (FL DOT. . ., 1997)	S	11	15.2						
Oregon Bicycle and Ped. Plan (OR DOT, 1995)	S	8.33	9.1						
Pitkin City Trails Dgn. and Mgt. . . . (Cimarron Designs, 1994)	S	10	15.2						
KY Dept. of Parks Trail Construction. . . (KY Dept. of Parks, 1989)	B	30	152.4						
MO St. Parks Trail Const. Guidelines (MO DNR, 1975)	B	5	91.4						
PA Plan for Nonmotorized Trails (PA Trails Pgm., 1980b)	B	n/a	n/a						
Wisconsin DNR Design Standards (WI DNR, 1994)	B	30	30.5						
KY Dept. of Parks Trail Construction. . . (KY Dept. of Parks, 1989)	E	25	30.5						
MO St. Parks Trail Const. Guidelines (MO DNR, 1975)	E	15	45.7						
PA Plan for Nonmotorized Trails (PA Trails Pgm., 1980b)	E	n/a	n/a						
Wisconsin DNR Design Standards (WI DNR, 1994)	E	25	30.5						
PA Plan for Nonmotorized Trails (PA Trails Pgm., 1980b)	X			n/a	n/a	10	n/a <sup>1</sup>	20	n/a <sup>1</sup>
PA Plan for Motorized Trails (PA Trails Pgm., 1980a)	SM	n/a	n/a						
Wisconsin DNR Design Standards (WI DNR, 1994)	SM	n/a	n/a						
PA Plan for Motorized Trails (PA Trails Pgm., 1980a)	ATV	n/a	n/a						
Wisconsin DNR Design Standards (WI DNR, 1994)	ATV	n/a							

<sup>1</sup> For short distances.

<sup>2</sup> In extreme circumstances, 20% is permitted. In general 15% should be observed as the maximum grade and should only be used over short distances.

AR = Accessible Route	ORAR = Outdoor Recreation Access Route	RT = Recreational Trail
H = Hiking Trail	S = Shared-Use Path	B = Bicycle Path
MB = Mountain Biking Trail	E = Equestrian Trail	X = Cross-Country Ski Trail
SM = Snow Machine Trail	ATV = All-Terrain Vehicle Trail	
OHV = Off-Highway Vehicle Trail	M = Motorcycle Trail	

**Table 5-5.5:**  
**Additional Recommendations for Maximum Grade for a Specified Distance Run**

Source	Path Type	Single Level		Multiple Levels					
		Grade %	Run m	Easier		Moderate		Difficult	
				Grade %	Run m	Grade %	Run m	Grade %	Run m
ORAR and RT Design Specification (Axelson et al., 1995)	ORAR			8	3.0	12	9.1	14	9.1
Universal Access. to Outdoor Rec. (PLAE, Inc., 1993)	ORAR			8.33	9.1	10	15.2	10	15.2
ORAR and RT Design Specification (Axelson et al., 1995)	RT			14	3.0	14	9.1	20	9.1
Universal Access. to Outdoor Rec. (PLAE, Inc., 1993)	RT			10	15.2	14	15.2	20	15.2
Recreational Trail Design and Const. (Rathke and Baughman, 1994)	H	40	45.7						
Trails for the 21st Century (Ryan, 1993)	S	8.0	9.1						
Recreational Trail Design and Const. (Rathke and Baughman, 1994)	B	15	45.7						
Trails for the 21st Century (Ryan, 1993)	B	n/a	n/a						
Mountain Bike Trails: Tech for... (McCoy and Stoner, 1992)	MB			10	30.5	30	91.4	+30	152.4
Recreational Trail Design and Const. (Rathke and Baughman, 1994)	E	20	45.7						
Trails for the 21st Century (Ryan, 1993)	E	n/a	n/a						
Recreational Trail Design and Const. (Rathke and Baughman, 1994)	X	40	45.7						
Trails for the 21st Century (Ryan, 1993)	X	n/a	n/a						
Recreational Trail Design and Const. (Rathke and Baughman, 1994)	SM	40	45.7						
Trails for the 21st Century (Ryan, 1993)	SM	n/a	n/a						
OHM and ATV Trails Guidelines for Dgn. . . . (Wemex, 1994)	ATV			15	n/a	30	n/a	50	n/a

AR = Accessible Route  
H = Hiking Trail  
MB = Mountain Biking Trail  
SM = Snow Machine Trail  
OHV = Off-Highway Vehicle Trail

ORAR = Outdoor Recreation Access Route  
S = Shared-Use Path  
E = Equestrian Trail  
ATV = All-Terrain Vehicle Trail  
M = Motorcycle Trail

RT = Recreational Trail  
B = Bicycle Path  
X = Cross-Country Ski Trail

**Table 5-6.1:**  
**Federal Accessibility Guidelines for Maximum Allowable Running Cross-Slope**

Source	Path Type	Single Level %	Multiple Levels		
			Easier %	Moderate %	Difficult %
ADA Standards for Access. Design (US DOJ, 1991)	AR	2 <sup>1</sup>			
UFAS (US DoD, et al., 1984)	AR	2 <sup>1</sup>			

<sup>1</sup> ADA Standards for Accessible Design and UFAS both require people to use the least slope possible on accessible routes.

**Table 5-6.2:**  
**Federal Advisory Committee Recommendations for Maximum Allowable Running Cross-Slope**

Source	Path Type	Single Level %	Multiple Levels		
			Easier %	Moderate %	Difficult %
Recommendations for Accessibility Guidelines: Recreational Facilities. . . (Rec. Access. Adv. Comm., 1994)	ORAR		3	3	3
Recommendations for Accessibility Guidelines: Recreational Facilities. . . (Rec. Access. Adv. Comm., 1994)	RT		3	5	8

**Table 5-6.3:**  
**Federal Guidelines for Maximum Allowable Running Cross-Slope**

Source	Path Type	Single Level %	Multiple Levels		
			Easier %	Moderate %	Difficult %
USDA FS Trails Mgt. Handbook (USDA FS, 1985)	H		n/a	n/a	n/a
Guide for the Dev. of Bicycle Facilities (AASHTO, 1997, Draft)	S	2			
Guide for the Dev. of Bicycle Facilities (AASHTO, 1991)	B	2			
USDA FS Trails Mgt. Handbook (USDA FS, 1985)	E		n/a	n/a	n/a
USDA FS Trails Mgt. Handbook (USDA FS, 1985)	X		n/a	n/a	n/a
USDA FS Trails Mgt. Handbook (USDA FS, 1985)	SM		15	30	40
USDA FS Trails Mgt. Handbook (USDA FS, 1985)	ATV		20	30	40

AR = Accessible Route	ORAR = Outdoor Recreation Access Route	RT = Recreational Trail
H = Hiking Trail	S = Shared-Use Path	B = Bicycle Path
MB = Mountain Biking Trail	E = Equestrian Trail	X = Cross-Country Ski Trail
SM = Snow Machine Trail	ATV = All-Terrain Vehicle Trail	
OHV = Off-Highway Vehicle Trail	M = Motorcycle Trail	

**Table 5-6.4:**  
**State, County, and City Guidelines for Maximum Allowable Running Cross-Slope**

Source	Path Type	Single Level %	Multiple Levels		
			Easier %	Moderate %	Difficult %
Klamath District's Trail . . . (Beers, 1993, Draft)	ORAR	1			
NM Plan for Accessible Fishing (Nordhaus, et al., 1984)	ORAR		2	3.3	5
Access to Parks Guidelines (CA State Parks, 1997)	RT		1	2	n/a
Ped. Facilities Guidebook for WA DOT (WA DOT, 1997)	RT		2	3	5
Alaska Region Trails Const. (USDA FS, AK Reg. FS, 1991)	H		n/a	n/a	n/a
MO St. Parks Trail Const. Guidelines (MO DNR, 1975)	H	n/a			
PA Plan for Nonmotorized Trails (PA Trails Pgm., 1980b)	H	n/a			
FL Bicycle Facilities Planning. . . (FL DOT. . ., 1997)	S	2			
Oregon Bicycle and Ped. Plan (OR DOT, 1995)	S	2			
Pitkin City Trails Dgn. and Mgt. . . (Cimarron Designs, 1994)	S	2			
KY Dept. of Parks Trail Construction. . . (KY Dept. of Parks, 1989)	B	n/a			
MO St. Parks Trail Const. Guidelines (MO DNR, 1975)	B	n/a			
PA Plan for Nonmotorized Trails (PA Trails Pgm., 1980b)	B	n/a			
Wisconsin DNR Design Standards (WI DNR, 1994)	B	n/a			
KY Dept. of Parks Trail Construction. . . (KY Dept. of Parks, 1989)	E	n/a			
MO St. Parks Trail Const. Guidelines (MO DNR, 1975)	E	n/a			
PA Plan for Nonmotorized Trails (PA Trails Pgm., 1980b)	E	n/a			
Wisconsin DNR Design Standards (WI DNR, 1994)	E	n/a			
PA Plan for Nonmotorized Trails (PA Trails Pgm., 1980b)	X		n/a	n/a	n/a
PA Plan for Motorized Trails (PA Trails Pgm., 1980a)	SM	n/a			
Wisconsin DNR Design Standards (WI DNR, 1994)	SM	n/a			
PA Plan for Motorized Trails (PA Trails Pgm., 1980a)	ATV	n/a			
Wisconsin DNR Design Standards (WI DNR, 1994)	ATV	n/a			

AR = Accessible Route  
H = Hiking Trail  
MB = Mountain Biking Trail  
SM = Snow Machine Trail  
OHV = Off-Highway Vehicle Trail

ORAR = Outdoor Recreation Access Route  
S = Shared-Use Path  
E = Equestrian Trail  
ATV = All-Terrain Vehicle Trail  
M = Motorcycle Trail

RT = Recreational Trail  
B = Bicycle Path  
X = Cross-Country Ski Trail

**Table 5-6.5:**  
**Additional Recommendations for Maximum Allowable Running Cross-Slope**

Source	Path Type	Single Level %	Multiple Levels		
			Easier %	Moderate %	Difficult %
ORAR and RT Design Specification (Axelson et al., 1995) <sup>1</sup>	ORAR		3	5	8
Universal Access. to Outdoor Rec. (PLAE, Inc., 1993)	ORAR		3	3	3
ORAR and RT Design Specification (Axelson et al., 1995) <sup>1</sup>	RT		5	8	12
Universal Access. to Outdoor Rec. (PLAE, Inc., 1993)	RT		3	5	8.33
Recreational Trail Design and Const. (Rathke and Baughman, 1994)	H	4			
Trails for the 21st Century (Ryan, 1993)	S	2			
Recreational Trail Design and Const. (Rathke and Baughman, 1994)	B	4			
Trails for the 21st Century (Ryan, 1993)	B	4			
Mountain Bike Trails: Tech for. . . (McCoy and Stoner, 1992)	MB		n/a	n/a	n/a
Recreational Trail Design and Const. (Rathke and Baughman, 1994)	E	4			
Trails for the 21st Century (Ryan, 1993)	E	4			
Recreational Trail Design and Const. (Rathke and Baughman, 1994)	X	2			
Trails for the 21st Century (Ryan, 1993)	X	4			
Recreational Trail Design and Const. (Rathke and Baughman, 1994)	SM	2			
Trails for the 21st Century (Ryan, 1993)	SM	n/a			
OHM and ATV Trails Guidelines for Dgn. . . . (Wemex, 1994)	ATV		n/a	n/a	n/a

<sup>1</sup> Maximum allowable average cross-slope not running cross-slope.

AR = Accessible Route  
H = Hiking Trail  
MB = Mountain Biking Trail  
SM = Snow Machine Trail  
OHV = Off-Highway Vehicle Trail  
ORAR = Outdoor Recreation Access Route  
S = Shared-Use Path  
E = Equestrian Trail  
ATV = All-Terrain Vehicle Trail  
M = Motorcycle Trail  
RT = Recreational Trail  
B = Bicycle Path  
X = Cross-Country Ski Trail

**Table 5-7.1:****Federal Accessibility Guidelines for Minimum Clearance Width**

Source	Path Type	Single Level	Multiple Levels		
			Easier	Moderate	Difficult
		m	m	m	m
ADA Standards for Access. Design (US DOJ, 1991)	AR	0.915			
UFAS (US DoD, et al., 1984)	AR	0.915			

**Table 5-7.2:****Federal Advisory Committee Recommendations for Minimum Clearance Width**

Source	Path Type	Single Level	Multiple Levels		
			Easier	Moderate	Difficult
		m	m	m	m
Recommendations for Accessibility Guidelines: Recreational Facilities. . . (Rec. Access. Adv. Comm., 1994)	ORAR		1.220	0.915	0.915
Recommendations for Accessibility Guidelines: Recreational Facilities. . . (Rec. Access. Adv. Comm., 1994)	RT		1.220	0.915	0.760

**Table 5-7.3:****Federal Guidelines for Minimum Clearance Width**

Source	Path Type	Single Level	Multiple Levels		
			Easier	Moderate	Difficult
		m	m	m	m
USDA FS Trails Mgt. Handbook (USDA FS, 1985)	H		n/a	n/a	n/a
Guide for the Dev. of Bicycle Facilities (AASHTO, 1997, Draft)	S	n/a			
Guide for the Dev. of Bicycle Facilities (AASHTO, 1991)	B	n/a			
USDA FS Trails Mgt. Handbook (USDA FS, 1985)	E		n/a	n/a	n/a
USDA FS Trails Mgt. Handbook (USDA FS, 1985)	X		n/a	n/a	n/a
USDA FS Trails Mgt. Handbook (USDA FS, 1985)	SM		n/a	n/a	n/a
USDA FS Trails Mgt. Handbook (USDA FS, 1985)	ATV		n/a	n/a	n/a

AR = Accessible Route  
H = Hiking Trail  
MB = Mountain Biking Trail  
SM = Snow Machine Trail  
OHV = Off-Highway Vehicle Trail

ORAR = Outdoor Recreation Access Route  
S = Shared-Use Path  
E = Equestrian Trail  
ATV = All-Terrain Vehicle Trail  
M = Motorcycle Trail

RT = Recreational Trail  
B = Bicycle Path  
X = Cross-Country Ski Trail



**Table 5-7.4:**  
**State, County, and City Guidelines for Minimum Clearance Width**

Source	Path Type	Single Level m	Multiple Levels		
			Easier m	Moderate m	Difficult m
Klamath District's Trail . . . (Beers, 1993, Draft)	ORAR	1.525			
NM Plan for Accessible Fishing (Nordhaus, et al., 1984)	ORAR		0.915	0.915	0.815
Access to Parks Guidelines (CA State Parks, 1997)	RT		0.915	0.915	n/a
Ped. Facilities Guidebook for WA DOT (WA DOT, 1997)	RT		1.2	.9	0.7
Alaska Region Trails Const. (USDA FS, AK Reg. FS, 1991)	H		n/a	n/a	n/a
MO St. Parks Trail Const. Guidelines (MO DNR, 1975)	H	n/a			
PA Plan for Nonmotorized Trails (PA Trails Pgm., 1980b)	H	n/a			
FL Bicycle Facilities Planning. . . (FL DOT. . ., 1997)	S	n/a			
Oregon Bicycle and Ped. Plan (OR DOT, 1995)	S	n/a			
Pitkin City Trails Dgn. and Mgt. . . . (Cimarron Designs, 1994)	S	n/a			
KY Dept. of Parks Trail Construction. . . (KY Dept. of Parks, 1989)	B	n/a			
MO St. Parks Trail Const. Guidelines (MO DNR, 1975)	B	n/a			
PA Plan for Nonmotorized Trails (PA Trails Pgm., 1980b)	B	n/a			
Wisconsin DNR Design Standards (WI DNR, 1994)	B	n/a			
KY Dept. of Parks Trail Construction. . . (KY Dept. of Parks, 1989)	E	n/a			
MO St. Parks Trail Const. Guidelines (MO DNR, 1975)	E	n/a			
PA Plan for Nonmotorized Trails (PA Trails Pgm., 1980b)	E	n/a			
Wisconsin DNR Design Standards (WI DNR, 1994)	E	n/a			
PA Plan for Nonmotorized Trails (PA Trails Pgm., 1980b)	X		n/a	n/a	n/a
PA Plan for Motorized Trails (PA Trails Pgm., 1980a)	SM	n/a			
Wisconsin DNR Design Standards (WI DNR, 1994)	SM	n/a			
PA Plan for Motorized Trails (PA Trails Pgm., 1980a)	ATV	n/a			
Wisconsin DNR Design Standards (WI DNR, 1994)	ATV	n/a			

AR = Accessible Route

H = Hiking Trail

MB = Mountain Biking Trail

SM = Snow Machine Trail

OHV = Off-Highway Vehicle Trail

ORAR = Outdoor Recreation Access Route

S = Shared-Use Path

E = Equestrian Trail

ATV = All-Terrain Vehicle Trail

M = Motorcycle Trail

RT = Recreational Trail

B = Bicycle Path

X = Cross-Country Ski Trail

**Table 5-7.5:**  
**Additional Recommendations for Minimum Clearance Width**

Source	Path Type	Single Level m	Multiple Levels		
			Easier m	Moderate m	Difficult m
ORAR and RT Design Specification (Axelson et al., 1995)	ORAR		0.915	0.815	0.710
Universal Access. to Outdoor Rec. (PLAE, Inc., 1993)	ORAR		1.220 <sup>2</sup>	0.915 <sup>2</sup>	0.915 <sup>2</sup>
ORAR and RT Design Specification (Axelson et al., 1995)	RT		1.220	0.915	0.710
Universal Access. to Outdoor Rec. (PLAE, Inc., 1993)	RT		1.220	0.915	0.710
Recreational Trail Design and Const. (Rathke and Baughman, 1994)	H	n/a			
Trails for the 21st Century (Ryan, 1993)	S	.815 <sup>1</sup>			
Recreational Trail Design and Const. (Rathke and Baughman, 1994)	B	n/a			
Trails for the 21st Century (Ryan, 1993)	B	n/a			
Mountain Bike Trails: Tech for. . . (McCoy and Stoner, 1992)	MB		n/a	n/a	n/a
Recreational Trail Design and Const. (Rathke and Baughman, 1994)	E	n/a			
Trails for the 21st Century (Ryan, 1993)	E	n/a			
Recreational Trail Design and Const. (Rathke and Baughman, 1994)	X	n/a			
Trails for the 21st Century (Ryan, 1993)	X	n/a			
Recreational Trail Design and Const. (Rathke and Baughman, 1994)	SM	n/a			
Trails for the 21st Century (Ryan, 1993)	SM	n/a			
OHM and ATV Trails Guidelines for Dgn. . . . (Wemex, 1994)	ATV		n/a	n/a	n/a

<sup>1</sup> For reasonably short distances, 0.815 m is permitted.

<sup>2</sup> For distances less than 0.610 m, 0.815 m is permitted.

AR = Accessible Route  
H = Hiking Trail  
MB = Mountain Biking Trail  
SM = Snow Machine Trail  
OHV = Off-Highway Vehicle Trail

ORAR = Outdoor Recreation Access Route  
S = Shared-Use Path  
E = Equestrian Trail  
ATV = All-Terrain Vehicle Trail  
M = Motorcycle Trail

RT = Recreational Trail  
B = Bicycle Path  
X = Cross-Country Ski Trail

**Table 5-8.1:**  
**Federal Accessibility Guidelines for Vertical Changes in Level**

Source	Path Type	Single Level mm	Multiple Levels		
			Easier mm	Moderate mm	Difficult mm
ADA Standards for Access. Design (US DOJ, 1991)	AR	6 <sup>1</sup>			
UFAS (US DoD, et al., 1984)	AR	6 <sup>1</sup>			

<sup>1</sup> Changes in level between 6 and 13 mm must be beveled with a maximum slope of 50 percent. Changes in level greater than 13 mm must be treated with a ramp, curb ramp, or elevator.

**Table 5-8.2:**  
**Federal Advisory Committee Recommendations for Vertical Changes in Level**

Source	Path Type	Single Level mm	Multiple Levels		
			Easier mm	Moderate mm	Difficult mm
Recommendations for Accessibility Guidelines: Recreational Facilities. . . (Rec. Access. Adv. Comm., 1994)	ORAR		13	13	25
Recommendations for Accessibility Guidelines: Recreational Facilities. . . (Rec. Access. Adv. Comm., 1994)	RT		13	13	25

**Table 5-8.3:**  
**Federal Guidelines for Vertical Changes in Level**

Source	Path Type	Single Level mm	Multiple Levels		
			Easier mm	Moderate mm	Difficult mm
USDA FS Trails Mgt. Handbook (USDA FS, 1985)	H		n/a	n/a	n/a
Guide for the Dev. of Bicycle Facilities (AASHTO, 1997, Draft)	S	n/a			
Guide for the Dev. of Bicycle Facilities (AASHTO, 1991)	B	n/a			
USDA FS Trails Mgt. Handbook (USDA FS, 1985)	E		n/a	n/a	n/a
USDA FS Trails Mgt. Handbook (USDA FS, 1985)	X		n/a	n/a	n/a
USDA FS Trails Mgt. Handbook (USDA FS, 1985)	SM		n/a	n/a	n/a
USDA FS Trails Mgt. Handbook (USDA FS, 1985)	ATV		n/a	n/a	n/a

AR = Accessible Route	ORAR = Outdoor Recreation Access Route	RT = Recreational Trail
H = Hiking Trail	S = Shared-Use Path	B = Bicycle Path
MB = Mountain Biking Trail	E = Equestrian Trail	X = Cross-Country Ski Trail
SM = Snow Machine Trail	ATV = All-Terrain Vehicle Trail	
OHV = Off-Highway Vehicle Trail	M = Motorcycle Trail	

**Table 5-8.4:**  
**State, County, and City Guidelines for Vertical Changes in Level**

Source	Path Type	Single Level mm	Multiple Levels		
			Easier mm	Moderate mm	Difficult mm
Klamath District's Trail . . . (Beers, 1993, Draft)	ORAR	n/a			
NM Plan for Accessible Fishing (Nordhaus, et al., 1984)	ORAR		6	13	n/a
Access to Parks Guidelines (CA State Parks, 1997)	RT	6			
Ped. Facilities Guidebook for WA DOT (WA DOT, 1997)	RT		13	26	76
Alaska Region Trails Const. (USDA FS, AK Reg. FS, 1991)	H		n/a	n/a	n/a
MO St. Parks Trail Const. Guidelines (MO DNR, 1975)	H	n/a			
PA Plan for Nonmotorized Trails (PA Trails Pgm., 1980b)	H	n/a			
FL Bicycle Facilities Planning. . . (FL DOT. . ., 1997)	S	n/a			
Oregon Bicycle and Ped. Plan (OR DOT, 1995)	S	6			
Pitkin City Trails Dgn. and Mgt. . . . (Cimarron Designs, 1994)	S	n/a			
KY Dept. of Parks Trail Construction. . . (KY Dept. of Parks, 1989)	B	n/a			
MO St. Parks Trail Const. Guidelines (MO DNR, 1975)	B	n/a			
PA Plan for Nonmotorized Trails (PA Trails Pgm., 1980b)	B	n/a			
Wisconsin DNR Design Standards (WI DNR, 1994)	B	n/a			
KY Dept. of Parks Trail Construction. . . (KY Dept. of Parks, 1989)	E	n/a			
MO St. Parks Trail Const. Guidelines (MO DNR, 1975)	E	n/a			
PA Plan for Nonmotorized Trails (PA Trails Pgm., 1980b)	E	n/a			
Wisconsin DNR Design Standards (WI DNR, 1994)	E	n/a			
PA Plan for Nonmotorized Trails (PA Trails Pgm., 1980b)	X		n/a	n/a	n/a
PA Plan for Motorized Trails (PA Trails Pgm., 1980a)	SM	n/a			
Wisconsin DNR Design Standards (WI DNR, 1994)	SM	n/a			
PA Plan for Motorized Trails (PA Trails Pgm., 1980a)	ATV	n/a			
Wisconsin DNR Design Standards (WI DNR, 1994)	ATV	n/a			

AR = Accessible Route  
H = Hiking Trail  
MB = Mountain Biking Trail  
SM = Snow Machine Trail  
OHV = Off-Highway Vehicle Trail

ORAR = Outdoor Recreation Access Route  
S = Shared-Use Path  
E = Equestrian Trail  
ATV = All-Terrain Vehicle Trail  
M = Motorcycle Trail

RT = Recreational Trail  
B = Bicycle Path  
X = Cross-Country Ski Trail

**Table 5-8.5:**  
**Additional Recommendations for Vertical Changes in Level**

Source	Path Type	Single Level mm	Multiple Levels		
			Easier mm	Moderate mm	Difficult mm
ORAR and RT Design Specification (Axelson et al., 1995)	ORAR		13	25	50
Universal Access. to Outdoor Rec. (PLAE, Inc., 1993)	ORAR		13	13	25
ORAR and RT Design Specification (Axelson et al., 1995)	RT		25	50	100
Universal Access. to Outdoor Rec. (PLAE, Inc., 1993)	RT		13 <sup>1</sup>	25 <sup>1</sup>	75 <sup>1</sup>
Recreational Trail Design and Const. (Rathke and Baughman, 1994)	H	n/a			
Trails for the 21st Century (Ryan, 1993)	S	n/a			
Recreational Trail Design and Const. (Rathke and Baughman, 1994)	B	n/a			
Trails for the 21st Century (Ryan, 1993)	B	n/a			
Mountain Bike Trails: Tech for. . . (McCoy and Stoner, 1992)	MB	n/a			
Recreational Trail Design and Const. (Rathke and Baughman, 1994)	E	n/a			
Trails for the 21st Century (Ryan, 1993)	E	n/a			
Recreational Trail Design and Const. (Rathke and Baughman, 1994)	X	n/a			
Trails for the 21st Century (Ryan, 1993)	X	n/a			
Recreational Trail Design and Const. (Rathke and Baughman, 1994)	SM	n/a			
Trails for the 21st Century (Ryan, 1993)	SM	n/a			
OHV and ATV Trails Guidelines for Dgn. . . . (Wemex, 1994)	ATV		n/a	n/a	n/a

<sup>1</sup> Changes in level greater than 6 mm must be beveled with a 1:2 slope.

AR = Accessible Route  
H = Hiking Trail  
MB = Mountain Biking Trail  
SM = Snow Machine Trail  
OHV = Off-Highway Vehicle Trail  
ORAR = Outdoor Recreation Access Route  
S = Shared-Use Path  
E = Equestrian Trail  
ATV = All-Terrain Vehicle Trail  
M = Motorcycle Trail  
RT = Recreational Trail  
B = Bicycle Path  
X = Cross-Country Ski Trail

**Table 5-9.1:**  
**Federal Accessibility Guidelines for Vertical Clearance (Head Room)**

Source	Path Type	Single Level m	Multiple Levels		
			Easier m	Moderate m	Difficult m
ADA Standards for Access. Design (US DOJ, 1991)	AR	2.030			
UFAS (US DoD, et al., 1984)	AR	2.030			

**Table 5-9.2:**  
**Federal Advisory Committee Recommendations for Vertical Clearance**

Source	Path Type	Single Level m	Multiple Levels		
			Easier m	Moderate m	Difficult m
Recommendations for Accessibility Guidelines: Recreational Facilities. . . (Rec. Access. Adv. Comm., 1994)	ORAR		2.030	2.030	2.030
Recommendations for Accessibility Guidelines: Recreational Facilities. . . (Rec. Access. Adv. Comm., 1994)	RT		2.030	2.030	2.030

**Table 5-9.3:**  
**Federal Guidelines for Vertical Clearance**

Source	Path Type	Single Level m	Multiple Levels		
			Easier m	Moderate m	Difficult m
USDA FS Trails Mgt. Handbook (USDA FS, 1985)	H		2.440	2.440	2.440
Guide for the Dev. of Bicycle Facilities (AASHTO, 1997, Draft)	S	2.5			
Guide for the Dev. of Bicycle Facilities (AASHTO, 1991)	B	2.440			
USDA FS Trails Mgt. Handbook (USDA FS, 1985)	E		3.050	2.440	2.440
USDA FS Trails Mgt. Handbook (USDA FS, 1985)	X		1.830	1.830	1.830
USDA FS Trails Mgt. Handbook (USDA FS, 1985)	SM		2.135 <sup>1</sup>	2.135 <sup>1</sup>	2.135 <sup>1</sup>
USDA FS Trails Mgt. Handbook (USDA FS, 1985)	ATV		1.830	1.830	1.525

<sup>1</sup> Above-average snow level.

AR = Accessible Route	ORAR = Outdoor Recreation Access Route	RT = Recreational Trail
H = Hiking Trail	S = Shared-Use Path	B = Bicycle Path
MB = Mountain Biking Trail	E = Equestrian Trail	X = Cross-Country Ski Trail
SM = Snow Machine Trail	ATV = All-Terrain Vehicle Trail	
OHV = Off-Highway Vehicle Trail	M = Motorcycle Trail	

**Table 5-9.4:**  
**State, County, and City Guidelines for Vertical Clearance**

Source	Path Type	Single Level m	Multiple Levels		
			Easier m	Moderate m	Difficult m
Klamath District's Trail . . . (Beers, 1993, Draft)	ORAR	2.440			
NM Plan for Accessible Fishing (Nordhaus, et al., 1984)	ORAR		2.030	2.030	2.030
Access to Parks Guidelines (CA State Parks, 1997)	RT		2.135	2.135	2.135
Ped. Facilities Guidebook for WA DOT (WA DOT, 1997)	RT		n/a	n/a	n/a
Alaska Region Trails Const. (USDA FS, AK Reg. FS, 1991)	H		2.440	2.440	2.440
MO St. Parks Trail Const. Guidelines (MO DNR, 1975)	H	2.135			
PA Plan for Nonmotorized Trails (PA Trails Pgm., 1980b)	H	2.440			
FL Bicycle Facilities Planning. . . (FL DOT. . ., 1997)	S	2.4			
Oregon Bicycle and Ped. Plan (OR DOT, 1995)	S	2.4			
Pitkin City Trails Dgn. and Mgt. . . . (Cimarron Designs, 1994)	S	3.050			
KY Dept. of Parks Trail Construction. . . (KY Dept. of Parks, 1989)	B	3.050			
MO St. Parks Trail Const. Guidelines (MO DNR, 1975)	B	2.440			
PA Plan for Nonmotorized Trails (PA Trails Pgm., 1980b)	B	2.440			
Wisconsin DNR Design Standards (WI DNR, 1994)	B	3.050			
KY Dept. of Parks Trail Construction. . . (KY Dept. of Parks, 1989)	E	3.050			
MO St. Parks Trail Const. Guidelines (MO DNR, 1975)	E	2.440			
PA Plan for Nonmotorized Trails (PA Trails Pgm., 1980b)	E	3.050			
Wisconsin DNR Design Standards (WI DNR, 1994)	E	3.660			
PA Plan for Nonmotorized Trails (PA Trails Pgm., 1980b)	X			2.440 <sup>1</sup>	2.440 <sup>1</sup>
PA Plan for Motorized Trails (PA Trails Pgm., 1980a)	SM	2.440 <sup>1</sup>			
Wisconsin DNR Design Standards (WI DNR, 1994)	SM	3.660 <sup>1</sup>			
PA Plan for Motorized Trails (PA Trails Pgm., 1980a)	ATV	2.440 <sup>2</sup>			
Wisconsin DNR Design Standards (WI DNR, 1994)	ATV	3.660 <sup>2</sup>			

<sup>1</sup> Above-average snow level.

<sup>2</sup> Above trail surface.

AR = Accessible Route	ORAR = Outdoor Recreation Access Route	RT = Recreational Trail
H = Hiking Trail	S = Shared-Use Path	B = Bicycle Path
MB = Mountain Biking Trail	E = Equestrian Trail	X = Cross-Country Ski Trail
SM = Snow Machine Trail	ATV = All-Terrain Vehicle Trail	
OHV = Off-Highway Vehicle Trail	M = Motorcycle Trail	

**Table 5-9.5:**  
**Additional Recommendations for Vertical Clearance**

Source	Path Type	Single Level m	Multiple Levels		
			Easier m	Moderate m	Difficult m
ORAR and RT Design Specification (Axelson et al., 1995)	ORAR		n/a	n/a	n/a
Universal Access. to Outdoor Rec. (PLAE, Inc., 1993)	ORAR		2.030	2.030	2.030
ORAR and RT Design Specification (Axelson et al., 1995)	RT		n/a	n/a	n/a
Universal Access. to Outdoor Rec. (PLAE, Inc., 1993)	RT		2.030	2.030	2.030
Recreational Trail Design and Const. (Rathke and Baughman, 1994)	H	2.440			
Trails for the 21st Century (Ryan, 1993)	S	3.050			
Recreational Trail Design and Const. (Rathke and Baughman, 1994)	B	2.440			
Trails for the 21st Century (Ryan, 1993)	B	2.135			
Mountain Bike Trails: Tech for. . . (McCoy and Stoner, 1992)	MB		2.440	2.440	2.440
Recreational Trail Design and Const. (Rathke and Baughman, 1994)	E	3.050			
Trails for the 21st Century (Ryan, 1993)	E	3.050			
Recreational Trail Design and Const. (Rathke and Baughman, 1994)	X	2.440			
Trails for the 21st Century (Ryan, 1993)	X	2.135 <sup>1</sup>			
Recreational Trail Design and Const. (Rathke and Baughman, 1994)	SM	2.440			
Trails for the 21st Century (Ryan, 1993)	SM	3.050			
OHM and ATV Trails Guidelines for Dgn. . . . (Wemex, 1994)	ATV		2.740	2.440	2.440

<sup>1</sup> Above-average snowfall.

AR = Accessible Route  
H = Hiking Trail  
MB = Mountain Biking Trail  
SM = Snow Machine Trail  
OHV = Off-Highway Vehicle Trail

ORAR = Outdoor Recreation Access Route  
S = Shared-Use Path  
E = Equestrian Trail  
ATV = All-Terrain Vehicle Trail  
M = Motorcycle Trail

RT = Recreational Trail  
B = Bicycle Path  
X = Cross-Country Ski Trail





# Abbreviations and Acronyms

AASHTO	American Association of State Highway and Transportation Officials
ABA	Architectural Barriers Act
ADA	Americans with Disabilities Act
ADAAG	Americans with Disabilities Act Accessibility Guidelines/ADA Standards for Accessible Design
ANSI	American National Standards Institute
ATS	Audible traffic signal
ATV	All-terrain vehicle
CFR	Code of Federal Regulations
BOCA	Building Officials and Code Administrators International
DoD	Department of Defense
DOJ	Department of Justice
DOT	Department of Transportation
EEOC	Equal Employment Opportunity Commission
FCC	Federal Communications Commission
FEMA	Federal Emergency Management Agency
FFE	Finished floor elevation
FHWA	Federal Highway Administration
FTA	Federal Transit Administration
GPS	Global Positioning System
HUD	United States Department of Housing and Urban Development
ICBO	International Conference of Building Officials
ISTEA	Intermodal Surface Transportation Efficiency Act
NAHB	National Association of Home Builders
MPO	Metropolitan Planning Organization
MGRAD	Minimum Guidelines and Requirements for Accessible Design
MUTCD	<i>Manual on Uniform Traffic Control Devices</i>
NWPS	National Wilderness Preservation System
OHV	Off-highway vehicle
ORAR	Outdoor Recreation Access Route
RT	Recreation trail
SBCCI	Southern Building Code Congress International

STIP	Statewide Transportation Improvement Program
STP	Surface Transportation Program
TIP	Transportation Improvement Program
TDD	Telecommunication display device, or text telephone
TTY	Telecommunication display device, or text telephone
TEA-21	Transportation Equity Act for the 21st Century
U.S. Access Board	United States Architectural and Transportation Barriers Compliance Board
U.S. ATBCB	United States Architectural and Transportation Barriers Compliance Board
UFAS	Uniform Federal Accessibility Standards
USDA	United States Department of Agriculture
USDI	United States Department of the Interior
U.S. DoD	United States Department of Defense
U.S. DOJ	United States Department of Justice
U.S. DOT	United States Department of Transportation
UTAP	Universal Trail Assessment Process

# Glossary

**Accessible route** — A continuous, unobstructed path connecting all accessible elements and spaces of a building or facility that meets the requirements of ADAAG.

**Alteration** — Modification made to an existing building or facility that goes beyond normal maintenance activities and affects or could affect usability.

**Americans with Disabilities Act of 1990 (ADA)** — A Federal law prohibiting discrimination against people with disabilities. Requires public entities and public accommodations to provide accessible accommodations for people with disabilities.

**Americans with Disabilities Act Accessibility Guidelines** — Provide scoping and technical specifications for new construction and alterations undertaken by entities covered by the ADA.

**ANSI A117.1, Making Buildings Accessible to and Usable by the Physically Handicapped** — The first American standard developed for accessibility; specifies technical requirements for new construction and alterations.

**Approach** — The section of the accessible route that flanks the landing of a curb ramp. The approach may be slightly graded if the landing level is below the elevation of the adjoining sidewalk.

**Architectural Barriers Act of 1968 (ABA)** — A Federal law stating that buildings and facilities designed, constructed, or altered with Federal funds, or leased by a Federal agency, must comply with standards for physical accessibility.

**Arterial road** — A major through route; arterials often provide direct service between cities and large towns.

**Assistive device** — A device that assists users in accomplishing day-to-day functions. For example, a wheelchair is an assistive device to assist a person who cannot walk.

**Audible warning** — A warning consisting of words or sounds indicating a potentially hazardous situation.

**Barrier curb** — A relatively high and steep-faced curb, designed with the intention of discouraging vehicles from leaving the roadway.

**Barrier removal** — Removal, rearrangement, or modification of objects positioned or structured in a manner that impedes access. Can include rearrangement or removal of furniture or equipment, installation of curb cuts or ramps, or repositioning items such as telephone kiosks or newspaper boxes.

**Bevel** — A surface that meets another surface at any angle other than 90 degrees.

**Bulbout** — Another term for a curb extension, which is a section of sidewalk at an intersection or midblock crossing that reduces the crossing width for pedestrians and can help reduce traffic speeds.

**Caster** — A wheel that can pivot but is not intended to govern the driving direction; typically used for the front wheels of most wheelchairs.

- Changes in level** — Vertical height transitions between adjacent surfaces or along the surface of a path.
- Clear space in crosswalk** — The additional space required to be included in a crosswalk at the corner where the ramp of a diagonal curb ramp meets the street so that those entering or exiting the base of the ramp can remain within the crosswalk.
- Cognitive disability** — Limitation of the ability to perceive, recognize, understand, interpret, and/or respond to information.
- Collector road** — A roadway linking traffic on local roads to the arterial road network.
- Commercial facility** — Facilities that are intended for nonresidential use by private entities and whose operation affects commerce.
- Community impact assessment** — Assessment of the impact of a proposed transportation project on a community; includes informing local residents, businesses, transportation planners, and politicians of the probable positive and negative effects of a project.
- Continuous passage** — An unobstructed way of pedestrian passage or travel that connects pedestrian areas, elements, and facilities to accessible routes on adjacent sites.
- Crosswalk** — Portion of a roadway where pedestrians are permitted to cross the street; can be marked or unmarked.
- Cross-slope** — The slope measured perpendicular to the direction of travel.
- Curb extension** — A section of sidewalk at an intersection or midblock crossing that reduces the crossing width for pedestrians and that can help reduce traffic speeds.
- Curb ramp** — A combined ramp and landing that accomplishes a change in level at a curb. This element provides street and sidewalk access to pedestrians using wheelchairs.
- Design width** — The width specification that a sidewalk or trail was intended to meet, usually set by building codes or agency guidelines.
- Detectable warning** — A standardized surface feature built in or applied to walking surfaces or other elements to warn visually impaired people of upcoming hazards.
- Diagonal curb ramp** — A curb ramp positioned at the corner of an intersection.
- Diagonal technique** — An environmental scanning technique in which a visually disabled person holds a cane in a stationary position diagonally across the body with the cane touching or just above the ground at a point outside one shoulder. This technique is used primarily in familiar, controlled environments.
- Drainage bar** — A bar made of wood, rubber, or stone placed across a trail to divert runoff across rather than down the trail.
- Drainage inlet** — A location where water runoff from the street or sidewalk enters the storm drain system; the openings to drainage inlets are typically covered by a grate or other perforated surface to protect pedestrians.

- Driveway crossing** — A ramp positioned where a driveway and the sidewalk meet; designed to ease the transition between a street and a driveway.
- Existing facility** — A structure such as a building, site, complex, road, walkway, parking lot, or other real or personal property.
- Feasible** — Capable of being accomplished with a reasonable amount of effort, cost, or other hardship. With regard to ADA compliance, feasibility is determined on a case-by-case basis. For example, it might not be feasible to install a ramp that meets ADAAG specifications on a very steep hill, but it would be feasible to install an ADAAG ramp at the entrance of a building.
- Finished-floor elevation** — The elevation at which the building foundation meets the prevailing ground surface.
- Flare** — A sloped surface that flanks a curb ramp and provides a graded transition between the ramp and the sidewalk. Flares bridge differences in elevation and are intended to prevent ambulatory pedestrians from tripping. Flares are not considered part of the accessible route.
- Global Positioning System (GPS)** — A system that identifies position and elevation; a hand console is used to obtain data from an orbiting satellite.
- Grade** — The slope parallel to the direction of travel that is calculated by dividing the vertical change in elevation by the horizontal distance covered.
- Grade-separated crossings** — Facilities such as overpasses, underpasses, skywalks, or tunnels that allow pedestrians and motor vehicles to cross a street at different levels.
- Gutter** — A trough or dip used for drainage purposes that runs along the edge of the street and curb or curb ramp.
- Hearing impairment** — A condition causing partial or total deafness.
- Hot response** — An instant response to a trigger stimulus, such as a signal change caused by pedestrian-actuated traffic controls at many medians.
- Intermodalism** — The use of multiple types of transportation to reach one destination; includes combining the use of trains and buses, automobiles, bicycles, and pedestrian transport on a given trip.
- Intersection** — An area where two or more pathways or roadways join together.
- Island** — A pedestrian refuge within the right-of-way and traffic lanes of a highway or street; also used as loading stops for light rail or buses.
- Intermodal Surface Transportation Efficiency Act of 1991 (ISTEA)** — Federal legislation authorizing highway, highway safety, transit, and other surface transportation programs from 1991 through 1997. It provided new funding opportunities for sidewalks, shared-use paths, and recreational trails. ISTEA was superseded by the Transportation Equity Act for the 21st Century.

**Land management agency** — Includes national entities such as the USDA Forest Service and National Park Service, State and local park systems, and private organizations that manage large tracts of land including primitive or wilderness recreation areas.

**Landing** — A level area of sidewalk at the top of a curb ramp facing the ramp path.

**Local road** — A road that serves individual residences or businesses and/or distributes traffic within a given urban or rural area.

**Long-range transportation plan** — A transportation plan developed by States and MPOs to encapsulate 20 years of transportation planning and policy.

**Maximum cross-slope** — A limited section of a trail or sidewalk that exceeds the typical running cross-slope of the path.

**Maximum grade** — A limited section of path that exceeds the typical running grade.

**Median** — An island in the center of a road that provides pedestrians with a place of refuge and reduces the crossing distance between safety points.

**Midblock crossing** — A crossing point positioned in the center of a block rather than at an intersection.

**Minimum clearance width** — the narrowest point on a sidewalk or trail.

**Mobility impairment** — A condition limiting physical ability; generally considered to include lack of a limb or loss of limb use due to disease, amputation, paralysis, injury, or developmental condition; or limitation of movement due to cardiovascular or other disease. Although visual or hearing impairments and cognitive disabilities can hamper ease of travel, people with sensory or cognitive impairments are not termed people with mobility impairments in this report.

**Metropolitan Planning Organization (MPO)** — A regional transportation planning and policy agency for urban areas with populations larger than 50,000.

**New construction** — A project in which entirely new facility will be built from the ground up.

**Obstacle** — An object that limits the vertical passage space, protrudes into the circulation route, or reduces the clearance width of a sidewalk or trail.

**Parallel curb ramp** — A curb ramp design in which the sidewalk slopes down on either side of a landing; parallel curb ramps require users to turn before entering the street.

**Passing space** — A section of path wide enough to allow two wheelchair users to pass one another or travel abreast.

**Passing space interval** — The distance between passing spaces.

**Path or pathway** — A track or route along which people are intended to travel.

**Pedestrian** — A person who travels on foot or who uses assistive devices, such as a wheelchair, for mobility.

**Pedestrian-actuated traffic control** — A push-button or other control operated by pedestrians that is designed to interrupt the prevailing signal cycle to permit pedestrians to cross an intersection.

**Pedestrian/Bicycle Coordinator** — A position responsible for planning and managing nonmotorized facilities and programs, creating safety and promotional materials encouraging bicycle and pedestrian transportation, and serving as the principal liaison between government transportation entities, the press, citizen organizations, and individuals on bicycling and walking issues.

**Perpendicular curb ramp** — A curb ramp design in which the ramp path is perpendicular to the edge of the curb.

**Places of public accommodation** — Facilities operated by private entities that fall within the following 12 broad categories defined by Congress: places of lodging, food establishments, entertainment houses, public gathering centers, sales establishments, service establishments, transportation stations, places of recreation, museums and zoos, social service establishments, and places of education.

**Private entity** — An individual or organization not employed, owned, or operated by the government.

**Program access** — Access provided to a program, service, or activity conducted or funded by a public entity.

**Prosthesis** — An artificial device that replaces part of the body; includes artificial limbs that serve as assistive devices and enable mobility.

**Public entity** — Any State or local government; department agency, special-purpose district, or other instrumentality of a State or States or local government, and any commuter authority.

**Ramp** — A sloped transition between two elevation levels.

**Rate of cross-slope change** — The change in cross-slope over a given distance.

**Rate of grade change** — The change in grade over a given distance.

**Readily achievable** — Easily accomplished and able to be carried out without much difficulty or expense; refers to the criterion for barrier removal under Title III of the ADA.

**Reasonable accommodation** — Modifications or adjustments to a program, work environment, or job description that make it easier for a person with a disability to participate in the same manner as other employees.

**Recreation Access Advisory Committee** — A committee established in 1993 by the U.S. Access Board to develop recommendations for accessible recreation facilities.

**Rehabilitation Act of 1973** — A Federal law requiring nondiscrimination in the employment practices of Federal agencies of the executive branch and Federal contractors; requires all Federally assisted programs, services, and activities to be available to people with disabilities.



- Rest area** — A level portion of a trail that is wide enough to provide wheelchair users and others a place to rest and gain relief from prevailing grade and cross-slope demands.
- Rest area interval** — The distance between rest areas.
- Right-of-way** — Real property rights (whether by fee-simple ownership, by easement, or by other agreement) acquired across land for a purpose, including pedestrian use.
- Running cross-slope** — The average cross-slope of a contiguous section of a sidewalk or trail.
- Running grade** — The average of many short, contiguous grades.
- Rural** — Areas outside the boundaries of urban areas.
- Scoping specifications** — Describes where accessibility is appropriate, when it is required, and how many aspects of a building, facility, or site must be accessible.
- Section 14 (1994)** — Proposed accessibility guidelines for public rights-of-way (now reserved).
- Section 504** — The section of the Rehabilitation Act that prohibits discrimination by any program or activity conducted by the Federal government.
- Sensory deficit** — Impairment of one of the five senses; includes partial or complete loss of hearing or vision, color blindness, loss of sensation in some part of the body or the loss of the sense of balance.
- Shared-use path** — A trail that permits more than one type of user, such as a trail designated for use by both pedestrians and bicyclists.
- Shy distance** — The area along the sidewalk closest to buildings, retaining walls, curbs, and fences generally avoided by pedestrians.
- Sidewalk** — The portion of a highway, road, or street intended for pedestrians.
- Sight distance** — The length of roadway visible to a driver or pedestrian; the distance a person can see along an unobstructed line of sight.
- Site infeasibility** — Existing site development conditions that prohibit the incorporation of elements, spaces, or features that are in full and strict compliance with the minimum requirements for new construction and that are necessary for pedestrian access, circulation, and use.
- Structural impracticability** — Changes having little likelihood of being accomplished without removing or altering a load-bearing structural member and/or incurring an increased cost of 50 percent or more of the value of the element of the building or facility involved.
- Surface Transportation Program (STP)** — A Federal program that provides grants to States for federally funded roadways and enhancement projects.
- Suburban** — Refers to an area surrounding a city that is closely settled.

**Switchback** — A trail or road that ascends a steep incline by taking a winding course to reduce the grade of the path.

**Tactile warning** — A change in surface condition that provides a tactile cue to alert pedestrians of a hazardous situation.

**Technical specifications** — Design and installation requirements.

**Technically infeasible** — A situation that prevents full compliance with ADAAG because existing structural conditions would require removing or altering a load-bearing member that is an essential part of the structural frame; or because other existing physical or site constraints prohibit modification or addition of elements, spaces, or features that are in full and strict compliance with the minimum requirements for new construction and that are necessary to provide accessibility.

**Title II of the Americans with Disabilities Act of 1990** — The section of the Americans with Disabilities Act of 1990 that prohibits State and local governments from discriminating against people with disabilities in programs, services, and activities.

**Title III of the Americans with Disabilities Act of 1990** — The section of the Americans with Disabilities Act of 1990 that prohibits places of public accommodation and commercial facilities from discriminating on the basis of disability.

**Touch technique** — An environmental scanning method in which a blind person arcs a cane from side to side and touches points outside both shoulders. Used primarily in unfamiliar or changing environments, such as on sidewalks and streets.

**Trail** — A path of travel for recreation and/or transportation within a park, natural environment, or designated corridor that is not classified as a highway, road, or street.

**Transportation agency** — A Federal, State, or local government entity responsible for planning and designing transportation systems and facilities for a particular jurisdiction.

**Transportation Enhancement** — Projects that include providing bicycle and pedestrian facilities; converting abandoned railroad rights-of-way into trails; preserving historic transportation sites; acquiring scenic easements; mitigating the negative impacts of a project on a community by providing additional benefits; and other projects.

**Transportation Enhancement Coordinator** — A position that manages transportation enhancement programs for State departments of transportation.

**Transportation Equity Act for the 21st Century (TEA-21)** — Federal legislation authorizing highway, highway safety, transit, and other surface transportation programs from 1998 through 2003. It provides funding opportunities for pedestrian, bicycling, and public transit facilities and emphasizes intermodalism, multimodalism, and community participation in transportation planning initiated by ISTEA.

**Transportation Improvement Program or Statewide Transportation Improvement Plan (TIP or STIP)** — A transportation plan that encapsulates planning and policy for a minimum of 3 years. Includes a prioritized list of all projects that will be constructed with Federal transportation funding.

**Truncated domes** — Small domes with flattened tops that are used as tactile warnings at transit platforms and curb edges.

**Uniform Federal Accessibility Standards** — Accessibility standards that all Federal agencies are required to meet; includes scoping and technical specifications.

**Urban** — Refers to places within boundaries set by State and local officials that have a population of 50,000 or more. Urban areas are more densely populated and contain a higher density of built structures.

**U.S. Access Board (United States Architectural and Transportation Barriers Compliance Board)** — A Federal agency that is responsible for developing Federal accessibility guidelines under the ADA and other laws.

**Vertical clearance** — The minimum unobstructed vertical passage space required along a sidewalk or trail.

**Visual impairment** — Loss or partial loss of vision.

**Visual warning** — The use of contrasting surface colors to indicate a change in environment, such as at a curb ramp where the sidewalk changes to the street.

**Wilderness Act of 1964** — A Federal law that prohibits the use of motorized vehicles and mechanized construction on certain tracts of federally managed land.

# Bibliography

ADAAG Review Federal Advisory Committee. (1996). *Final report: Recommendations for a new ADAAG*. Washington: U.S. Architectural and Transportation Barriers Compliance Board.

This report provides the final recommendations of the ADAAG Review Advisory Committee to the U.S. Access Board for revisions to the Americans with Disabilities Act Accessibility Guidelines in the form of a new set of guidelines.

The Access Board, 1311 F Street NW, Washington, DC 20004-1111,  
Telephone: (202) 272-5434, TDD (202) 272-5449, Fax: (202) 272-5447.

Adaptive Environments Center, Inc. (1992). *ADA Title II action guide for State and local governments*. Horsham: LRP Publications.

This book is a practical manual and workbook designed to guide State and local governments through the Title II compliance process. It features a planning process that will help ensure that State and local entities provide equal opportunity to people with disabilities.

LRP Publications, 747 Dresher Road, P.O. Box 980, Horsham, PA 19044-0980,  
Telephone: (215) 784-0860.

Albright, D.P. (1995). *Standing in the cold: Mobility and the mentally challenged*. Washington: Surface Transportation Policy Project.

This booklet depicts the access deficiencies of public transportation.

Alliance for Transportation Research, 1001 University Blvd., S.E.,  
Albuquerque, NM 87106, Telephone: (505) 246-6410.

American Association of State Highway and Transportation Officials. (1983). *Transportation glossary*. Washington.

This book contains definitions of 1,500 transportation terms.

AASHTO, 444 North Capitol Street, N.W., Washington, DC 20001,  
Telephone: (202) 624-5800.

American Association of State Highway and Transportation Officials. (1995). *A policy on geometric design of highways and streets: 1994*. Washington.

This book lists AASHTO-recommended policies for roadway design.

AASHTO, 444 North Capitol Street, N.W., Suite 249, Washington, DC 20001,  
Telephone: (202) 624-5800.

American Association of State and Highway Transportation Officials, Task Force on Geometric Design. (1991). *Guide for the development of bicycle facilities*. Washington.

This guide provides information to help accommodate bicycle traffic in all riding environments. Topics covered include a list of definitions, planning considerations, design considerations, operation and maintenance, and a list of references.

AASHTO, 444 North Capitol Street, N.W., Suite 249, Washington, DC 20001,  
Telephone: (202) 624-5800.

American Association of State Highway and Transportation Officials Task Force on Geometric Design. (Draft, 1997). *Guide for the development of bicycle facilities: Pre-final draft*. Washington.

This document contains design guidelines for bicycle facilities. It addresses design concerns that are not discussed in *A Policy on Geometric Design of Highways and Streets*, 1994.

AASHTO, 444 North Capitol Street N.W., Suite 249, Washington, DC 20001, Telephone: (202) 624-5800.

American College of Sports Medicine. (1986). *Guidelines for exercise testing and prescription*. Philadelphia: Lea and Febiger.

Standard reference document for the industry. Identifies standards of practice for fitness appraisal and exercise prescription. Includes information on health conditions that might influence exercise capacity or participation.

Williams 'n Wilkins, Rosetree Corporate Center Building Two, Suite 5025, 1440 North Providence Road, Media, PA 19063-2043, Telephone: (610) 925-9055, Fax: (610) 892-6670.

American College of Sports Medicine. (1997). *ACSM's exercise management for persons with chronic diseases and disabilities*. Champaign: Human Kinetics.

Summary of diseases and disabilities that influence the ability to exercise.

Human Kinetics Publishers, Inc., Fulfillment Department, P.O. Box 5076, Champaign, IL 61825-5076, Telephone: (800) 747-4457, Fax: (217) 351-1549, Web site: [www.humankinetics.com](http://www.humankinetics.com).

American National Standards Institute, Inc. (1980). *Specifications for making buildings and facilities accessible to and usable by physically handicapped people*. New York.

This manual provides recommendations for designing buildings and facilities accessible to and usable by people with disabilities.

American National Standards Institute, 1430 Broadway, New York, NY 10018.

American Society of Civil Engineers, National Association of Home Builders, The Urban Land Institute. (1990). *Residential streets: Second edition*. Washington: Bicycle Federation of America.

This book outlines current practices in residential street design that provide good examples of design criteria. Specifications related to drainage, intersection, and pavement options are also provided.

Bicycle Federation of America, 1506 Twenty-First Street, N.W., Suite 200, Washington, DC 20036, Telephone: (202) 463-6622, Fax: (202) 463-6625, Email: [bfa@igc.org](mailto:bfa@igc.org) or [bikefed@aol.com](mailto:bikefed@aol.com).

American Society for Testing Materials. (1997). *Annual book of ASTM standards: Section 15: General products, chemical specialties, and end-use products*. West Conshohocken.

This book contains updated information standards for products, chemical specialties, and end-use products.

ASTM, 100 Bar Harbor Drive, West Conshohocken, PA 19428, Telephone: (610) 832-9500, Fax: (610) 832-9555.

Americans with Disabilities Act. (1990). *Public Law 226, 101st Congress*. (July 26, 1990).

Civil rights legislation prohibiting discrimination against people with disabilities; written by the 101st Congress of the United States.

U.S. Government Printing Office, Superintendent of Documents, P.O.  
Box 371954, Pittsburgh, PA 15250-7954, Telephone: (202) 512-1800,  
Fax: (202) 512-2233.

Arapahoe County Department of Development Services and Infrastructure Management. (1997). *Arapahoe County 1997 handicap ramp installation program*. Littleton.

This book contains an outline of the steps that should be taken when designing or constructing public ramps.

Arapahoe County Administration Building, 5334 South Prince Street,  
Littleton, CO 80166-0001, Telephone: (303) 795-4640.

Architecture and Engineering for Parks Canada, Public Works and Government Services Canada. (1994). *Design guidelines for accessible outdoor recreation facilities*. Ottawa: Canada Paraplegic Association.

Provides diagrams and design guidelines for developing accessible outdoor recreation facilities.

Canadian Paraplegic Association, National Office, 1101 Prince of Wales Dr., Suite 320, Ottawa, Ontario K2C 3W7, Telephone: (613) 723-1033,  
Fax: (613) 723-1060.

Ashmead, D.H., Hill, E.W., Talor, C.R. (1989). *Obstacle perception by congenitally blind children*. *Perception and Psychophysics*, 46, pp. 425-433.

This study determined whether or not congenitally blind children were able to use nonvisual information to perceive objects.

Daniel H. Ashmead, Department of Psychology, Venderbilt Bill Wilkerson Center for Otolaryngology and Communication Sciences, Vanderbilt University, Nashville, TN 37232-8700, Telephone: (615) 340-8280,  
Fax: (615) 343-7705, Email: ashmead@ctrvax.vanderbilt.edu.

Ashmead, D.H., Wall, R.S., Eaton, S.B., Ebinger, K.A., Snook-Hill, M.M., Yang, X. (1998a). *Echolocation reconsidered: Using spatial variations in the ambient sound field to guide locomotion*. *Journal of Visual Impairment and Blindness*.

This study determined the ability of people with visual disabilities to use ambient, low-frequency sound to guide their locomotion.

Daniel H. Ashmead, Department of Psychology, Vanderbilt Bill Wilkerson Center for Otolaryngology and Communication Sciences, Vanderbilt University, Nashville, TN 37232-8700, Telephone: (615) 340-8280, Fax: (615) 343-7705,  
Email: ashmead@ctrvax.vanderbilt.edu.

Ashmead, D.H., Wall, R.S., Ebinger, K.A., Eaton, S.B., Snook-Hill, M.M. (1998b). *Spatial hearing in children with visual disabilities*. *Perception*, 27, pp. 105-122.

This study determined whether spatial hearing in children with visual disabilities was equivalent to that of sighted people.

Daniel H. Ashmead, Department of Psychology, Vanderbilt Bill Wilkerson Center for Otolaryngology and Communication Sciences, Vanderbilt University, Nashville, TN 37232-8700, Telephone: (615) 340-8280, Fax: (615) 343-7705, Email: ashmead@ctrvax.vanderbilt.edu.

Axelson, P.W., Chesney, D.A., Faraone, M., Kirschbaum, J.B., Longmuir, P.E., Richter, W.M., Wong, K.M. (1997). *Accessible exterior surfaces: A review of existing test methods for surface firmness and stability: Phase 1 report*. Washington: U.S. Architectural and Transportation Barriers Compliance Board.

This research report evaluates existing test methods to determine the accessibility of surfaces.

Beneficial Designs, Inc., 5858 Empire Grade, Santa Cruz, CA 95060, Telephone: (831) 429-8447, Fax: (831) 423-8450, Email: mail@beneficialdesigns.com.

Axelson, P., Chesney, D., Kelley, B., Longmuir, P., Pasternak, M., Wong, K., Wright, W. (1997). *Universal trail assessment coordinator training guide*. Santa Cruz: Pax Press.

This book is a guide to the Universal Trail Assessment Process, which can be used to objectively assess outdoor recreation routes and recreation trails to collect access, mapping, usage, and maintenance information.

Beneficial Designs, Inc., 5858 Empire Grade, Santa Cruz, CA 95060, Telephone: (831) 429-8447, Fax: (831) 423-8450, Email: mail@beneficialdesigns.com. Web site: www.beneficialdesigns.com

Axelson, P.W., Chesney, D.A., Longmuir, P. (1995). *Outdoor recreation access route (ORAR) and recreation trail design specification research: Final report*. Martinsville: National Center on Accessibility.

This study measures the difficulty experienced by wheelchair users and pedestrians traveling over a variety of different surfaces with different grade and cross-slope characteristics.

Beneficial Designs, Inc., 5858 Empire Grade, Santa Cruz, CA 95060, Telephone: (831) 429-8447, Fax: (831) 423-8450, Email: mail@beneficialdesigns.com. Web site: www.beneficialdesigns.com

Bach, B. Delft University of Technology, Traffic Consultants Diepens and Okkema. (1993). *International handbook for cycle network design: Second edition*. Delft: Diepens en Okkema Traffic Consultants.

This handbook discusses the vulnerability of bicycle users in automobile traffic and provides illustrated solutions to various traffic and bicycle conflicts.

Diepens and Okkema, P.O. Box 2873, 2601 CW DELFT, Telephone: 015 (2) 147899, Fax: 015 (2) 147902.

Barham, P., Oxley, P., Shaw, T. (1994). *Accessible public transport infrastructure: Guidelines for the design of interchanges, terminals, and stops*. Crowthorne: Mobility Unit of the Department of Transport and the Passenger Transport Executive Group.

These design guidelines outline methods that can be used to develop public transport infrastructures that are more accessible for people with disabilities.

Transport Research Laboratory, Old Wokingham Road, Crowthorne Berks  
RG11 6AV.

Bar-Or O. (1983). *Pediatric sports medicine for the practitioner*. New York: Springer Verlag.

This book contains standards of practice relating to exercise and children, including detailed information on the effect of congenital disabilities (such as cerebral palsy and spina bifida), exercise, and physical activity.

Springer Verlag, 175 Fifth Avenue, New York, NY 10010, Telephone: (212) 460-1500, Fax: (212) 473-6272.

Barrier Free Environments, Inc. (1991). *UFAS retrofit manual*. Washington: United States Architectural and Transportation Barriers Compliance Board.

This manual was designed to provide supplemental information regarding the application of the Uniform Federal Accessibility Standards in retrofit situations.

United States Architectural and Transportation Barriers Compliance Board,  
1331 F Street, N.W., Suite 1000, Washington, DC 20004-1111, Telephone: (202) 272-5434.

Barrier Free Environments, Inc. (1996). *Accessibility in Georgia*. Raleigh: Governor's Council on Developmental Disabilities for Georgia.

This is a technical and policy guide to access in Georgia.

Governor's Council on Developmental Disabilities, ADA Program Consultant,  
254 Washington St., S.W., Atlanta, GA 30334, Telephone: (404) 657-7313,  
TDD: (404) 657-9993.

Bearden, D.M. (1998). *Federal highway funding for air quality projects and transportation enhancements: How much, to whom, and for what?* Washington: Congressional Research Service, Library of Congress.

This report examines how Federal highway funding helps States address the environmental impacts of surface transportation. Funding structure, eligible project types, and other major funding situations are discussed.

Congressional Research Service, Library of Congress, Washington,  
DC 20540-7000.

Beers, D. (Draft, 1993). *Klamath district's trail manual: Draft*. Los Altos: California Trails Foundation.

This manual contains equestrian and mountain bike trail information.

Don Beers, North Coast Redwoods Headquarters, 600-A West Clark,  
Eureka, CA 95501, Telephone: (707) 445-6547 ext.18, Fax: (707) 441-5737.

Bentzen, B.L. (1995). *Impact of curb ramps on the safety of persons who are blind*. *Journal of Visual Impairment and Blindness*, 89, pp. 319-328.

The research presented in this article found that curb ramps do, in fact, affect the safety of individuals with visual impairments.

AFB Press, American Foundation for the Blind, 11 Penn Plaza, New York,  
NY 10001.



Bentzen, B.L. (1997). *Environmental Accessibility*. In Blasch, W. Wiener, R. Welsh (Eds.), *Foundations of orientation and mobility: second edition* (pp. 317–356). New York, NY: AFB Press, American Foundation for the Blind.

This chapter of *Foundations of Orientation and Mobility* contains detailed information pertaining to environmental accessibility.

AFB Press, American Foundation for the Blind, 11 Penn Plaza, Suite 300, New York, NY 10001. Web site: [http://www.afb.org/r\\_dwrep.html](http://www.afb.org/r_dwrep.html).

Bentzen, B.L., Jackson, R.M., Peck, A.F. (1981). *Information about visual impairment for architects and transit planners*. Washington: U.S. Department of Transportation.

This document reports on improving communications with the visually impaired in rail rapid-transit systems.

National Technical Information Service, Springfield, VA 22161, Telephone: (703) 605–6000.

Bentzen, B.L., Nolin, T.L., Easton, R.D. (1994). *Detectable warning surfaces: Color, contrast, and reflectance*. Washington: U.S. Department of Transportation.

This laboratory study was conducted to determine the optimal physical properties of a detectable warning system and to study properties such as contrast, hue, and reflectance.

National Technical Information Service, Springfield, VA 22161, Telephone: (703) 605–6000.

Bentzen, B.L., Nolin, T.L., Easton, R.D., Desmarais, L., Mitchell, P.A. (1994). *Detectable warnings: Detectability by individuals with visual impairments, and safety and negotiability on slopes for persons with physical impairments*. Washington: U.S. Department of Transportation.

The authors of this study tested the configurations of a variety of detectable warnings against a number of surrounding surfaces and determined how well people with visual impairments, as well as people with physical disabilities, were able to detect and negotiate the surfaces. They tested the stopping distance required for different surfaces and analyzed the causes of negotiation difficulties for people with physical disabilities who use mobility aids.

National Technical Information Service, Springfield, VA 22161, Telephone: (703) 605–6000.

Bentzen, B.L., Tabor, L.S. (1998). *Accessible Pedestrian Signals*. Washington: U.S. Access Board.

This report summarizes available types of accessible pedestrian signals. It analyzes when they are needed and what types of information they provide. Audible broadcast, tactile, vibrotactile, and receiver-based systems are discussed.

U.S. Architectural and Transportation Barriers Compliance Board, 1111 18th Street, N.W., Suite 501, Washington, DC 20036, Telephone: (800) 872–2253 or (202) 272–5434, TTY: (800)993–2822 or (202) 272–5449, Fax: (202) 272–5447.

Bhambhani, Y., Clarkson, H. (1989). *Acute physiologic and perceptual responses during three modes of ambulation: Walking, auxiliary crutch walking, and running*. *Archives of Physical Medicine and Rehabilitation*, 70, (June 1989). pp. 445–450.

This research studies the energy cost of walking, running, and crutch use for able-bodied adults.

University of Alberta, Faculty of Rehabilitation Medicine, Dr. Bhambhani,  
Room 308 Corbett Hall, Edmonton, Alberta T6G2G4 Canada.

Bicycle Federation of America. (1992). *Case study no. 21: Integrating bicycle and pedestrian considerations into State and local transportation planning, design, and operations*. Washington: Federal Highway Administration. Report # FHWA-PD-93-021.

This report discusses methods to integrate bicycle and pedestrian considerations into State and local transportation planning, design, and operations.

Federal Highway Administration, U.S. Department of Transportation,  
400 Seventh Street, S.W., Washington, DC 20590. Fax requests to  
FHWA R & T Report Center: (301) 577-1421.

Bicycle Federation of America. (1993a). *Case study no. 5: An analysis of current funding mechanisms for bicycle and pedestrian programs at the Federal, State, and local levels*. Washington: Federal Highway Administration. Report # FHWA-PD-93-008.

This document, published by the Federal Highway Administration, reviews funding sources for bicycle and pedestrian facilities available under ISTEA.

Federal Highway Administration, U.S. Department of Transportation,  
400 Seventh Street, S.W., Washington, DC 20590. Fax requests to  
FHWA R & T Report Center: (301) 577-1421.

Bicycle Federation of America. (1993b). *Case study no. 18: Final report, analyses of successful provincial, State, and local bicycle and pedestrian programs in Canada and the United States*. Washington: Federal Highway Administration.

This document, published by the Federal Highway Administration, reviews several State and local bicycle and pedestrian programs that have been exceptionally effective.

Federal Highway Administration, U.S. Department of Transportation,  
400 Seventh Street, S.W., Washington, DC 20590. Fax requests to  
FHWA R & T Report Center: (301) 577-1421.

Bicycle Federation of America, Pedestrian Federation of America. (1996). *Probike/pro walk '96, The ninth international conference on bicycle and pedestrian programs*. Portland.

This book contains the papers presented at the Ninth International Conference on Bicycle and Pedestrian Programs, 1996. A list of available references, publications, and reports is included.

Bicycle Federation of America, 1506 Twenty-First Street, N.W., Suite 200,  
Washington, DC 20036, Telephone: (202) 463-6622, Fax: (202) 463-6625,  
Email: bfa@igc.org or bikefed@aol.com.

Birchard, W., Jr., Proudman, R.D. (1981). *Trail design, construction, and maintenance*. Harpers Ferry: Appalachian Trail Conference.

Written for trail workers who maintain the Appalachian Trail, this book provides information about designing, constructing, and maintaining outdoor recreation trails.

Appalachian Trail Conference, P.O. Box 236, Harpers Ferry, WV 25425,  
Telephone: (304) 535-6331.

Birkby, R.C. (1996). *Lightly on the land*. Seattle: The Mountaineers.

This book is a guide for building trails written for the Student Conservation Association. It explains techniques for using volunteers to design and maintain outdoor trails.

The Mountaineers, 1001, S.W. Klickitat Way, Seattle, WA 98134.

Blomberg, R.D., Cleven, A.M. (1998). *Development, implementation, and evaluation of a pedestrian safety zone for elderly pedestrians*. Washington: U.S. Department of Transportation.

The objectives of this study were to develop and apply procedures for defining pedestrian safety zones for older (age 65+) adults and to develop, implement, and evaluate a countermeasure program in the defined zones.

U.S. Department of Transportation, National Highway Traffic Safety Administration/Federal Highway Administration, 400 Seventh Street, S.W., Washington, DC 20590, Telephone: (202) 366-4000.

Bowman, B.L., Fruin, J.J., Zegeer, C.V. (1989). *Planning design and maintenance of pedestrian facilities*. McLean: Federal Highway Administration.

This handbook's contents include pedestrian characteristics, results of pedestrian traffic and safety studies, pedestrian traffic control devices and procedures, pedestrian facilities in work zones, facility maintenance, and a summary of pedestrian facility problems.

Research, Development and Technology, Turner-Fairbank Highway Research Center, 6300 Georgetown Pike, McLean, VA 22101-2296. Fax requests to FHWA R & T Report Center: (301) 577-1421.

Brambilla, R., Longo, G. (1976). *A handbook for pedestrian action*. Washington: U.S. Department of Commerce.

This guidebook provides alternates in improving pedestrian accessibility and includes practical techniques a citizen can use to advocate improvement of pedestrian access.

National Technical Information Service, Springfield, VA 22161,  
Telephone: (703) 605-6000.

Brock, W., Cunill, B., Dockter, S., Isom, J., King, G., Lindsey-Forester, J., Sparklin, D., Stevens, B. (1996). *Community impact assessment: A quick reference for transportation*. Washington: Federal Highway Administration.

This guide outlines the community impact assessment process, highlights areas that must be examined, and identifies basic tools and information sources planners can use to assess the impact of transportation projects.

Office of Environment and Planning, Telephone: (202) 366-0106.

Brown, S.A., Stein, S.M., Warner, J.C. (1996). *Urban drainage design manual: Hydraulic engineering circular 22*. Washington: Federal Highway Administration.

This book is a practical guide to designing storm drain systems connected with transportation facilities.

National Technical Information Service, Springfield, VA 22161,  
Telephone: (703) 605-6000.

BT Countryside for All. (1997). *A good practice guide to disabled people's access in the countryside: Standards and guidelines*. Sheffield.

This document is a collection of more than 20 different plans for countryside accessibility.

BT Countryside For All, The Fairfield Trust, 67a The Wicker,  
Sheffield, South Yorkshire S3 8HT, Telephone: 0114-270-1668,  
Minicom: 0114-275-5380, Fax: 0114-276-7900.

Building Standards Branch, Ministry of Municipal Affairs. (1995). *Building access handbook: Building requirements for persons with disabilities*. Victoria: Queens Printer.

This handbook provides guidelines for and the rationale behind building specifications designed to improve access for people with disabilities.

Crown Publications, 521 Fort Street, Victoria, B.C. V8W 1E7,  
Telephone: (607) 386-4636, Fax: (604) 386-0221.

Burden, D. (1994). *Bike lanes: Improving motorist/bicyclist behavior*. Tallahassee: Florida Department of Transportation.

This paper explores the history and benefits of providing bike lines and paved shoulders in urban settings.

Theo Petritsch, State Pedestrian and Bicycle Coordinator, Florida Department of Transportation, 605 Suwannee Street, MS-82, Tallahassee, FL 32399,  
Telephone: (850) 487-1200, Fax: (850) 922-2935, Email:  
theopetritsch@dot.State.fl.us.

Burden, D., Wallwork, M. (1996). *Handbook for walkable communities*. High Springs.

This handbook discusses problems that pedestrians face because of increased auto congestion and introduces planning and engineering principles designed to improve pedestrian safety. Alternatives to private automobile transportation are discussed as well.

Dan Burden, Telephone: (904) 454-3304, Email: dburden@aol.com.

California State Parks. (1997). *Access to parks guidelines: California edition*. Sacramento.

This document contains the accessibility design guidelines for California State Parks.

California State Parks Store, P.O. Box 942896, Sacramento, CA 94296-0001,  
Ray Ann Watson (ADA Coordinator), Telephone: (916) 653-8148.

Campaign To Make America Walkable. (1997). *The pedestrian resource book*. Washington.

This document contains abstracts and meeting agendas from the National Pedestrian Conference held in Washington, DC, on September 6, 1997.

Bicycle Federation of America, 1506 Twenty-First Street, N.W., Suite 200, Washington, DC 20036-1008, Telephone: (202) 463-6622, Fax: (202) 463-6625, Email: bikefed@aol.com or walk@transact.org, Web site: www.bikefed.com or www.prowalk.org.

Chesney, D.A., Axelson, P.W. (1994). *Assessment of outdoor environments for accessibility*. Proceedings of the Rehabilitation Engineering Society of North America: RESNA Press.

The objectives of this research project were to develop a quantitative system for assessing outdoor environments for accessibility and to evaluate the reliability of the methodology.

Beneficial Designs, 5858 Empire Grade, Santa Cruz, CA 95060, Telephone: (831) 429-8447, Fax: (831) 423-8450.

Chilman, K., Vogel, J., Conley, J. (1991). *Turkey Bay off-road vehicle area at Land Between Lakes: Monitoring use and impacts since 1973*. Carbondale: Department of Forestry, Southern Illinois University.

This report describes 17 years of the changes and monitoring systems in Turkey Bay, an area in western Kentucky and Tennessee designated for off-road vehicle use.

TVA's Land Between the Lakes, Golden Pond, KY 42211, Telephone: (502) 924-5602, Fax: (502) 924-2093.

Cimarron Design. (1994). *Trails design and management handbook: Revision 1.1*. Aspen: Pitkin County Open Space and Trails Program.

This handbook contains the trail design standards for Pitkin County, Colorado. Separate standards are provided for hard surfaces and soft surfaces on multiple-use trails.

Pitkin County Open Space and Trails, 530 East Main Street, Suite 301, Aspen, CO 81611, Telephone: (970) 920-5232, Fax: (970) 920-5198.

City of Boulder. (1995). *Transportation master plan update for Boulder Valley*. Boulder: Charlier Associates, Inc.

This document contains transportation planning strategies for the city of Boulder, Colorado.

Mr. Randall Rutsch, Project Manager, Transportation Engineering City of Boulder, Park Central Building, 1739 Broadway, Second Floor, Boulder, CO 80206, Telephone: (303) 441-4413.

City of Memphis. (1994). *City of Memphis construction standards*. Memphis: City of Memphis, Division of Public Works, Department of Engineering.

This document contains design details for transportation facilities.

City of Memphis, Division of Public Works, Department of Engineering, 125 North Main, Suite 677, Memphis, TN 38103, Telephone: (901) 576-6700, Fax: (901) 576-6960.

City of Portland, Oregon, *Bureau of Maintenance, Sidewalk Repair*. (1996). The sidewalk handbook. Portland.

This brochure reviews property owners' responsibilities with regard to maintaining sidewalks and discusses available city support to repair sidewalks.

Bureau of Maintenance, Sidewalk Repair, 2929 N. Kerby Avenue, Portland, OR 97227, Telephone: (503) 823-1711, Fax: (503) 823-4043.

City of Portland, *Bureau of Transportation Engineering and Development, and the Pedestrian Transportation Program*. (1998). Pedestrian master plan. Portland.

This is the pedestrian Master Plan of Portland; it contains construction guidelines and layouts used by the City of Portland to design pedestrian facilities.

Pedestrian Transportation Program, 1120, S.W. Fifth Avenue, Room 802, Portland, OR 97204-1971, Telephone: (503) 823-7211, Email: jean@sysgen.ci.portland.or.us.

City of Portland, Bureau of Transportation Engineering and Development, and the Pedestrian Transportation Program. (Draft, 1997). *Pedestrian design guide*. Portland.

This is the curb ramp section of the draft design guidelines for pedestrian facilities in Portland.

Pedestrian Transportation Program, 1120, S.W. Fifth Avenue, Room 802, Portland, OR 97204-1971, Telephone: (503) 823-7211.

City of Seattle. (1996). *Making streets that work: Neighborhood planning tool*. Seattle.

This workbook is designed to help planners improve the attractiveness and safety of urban neighborhoods.

Office of the Mayor, City of Seattle, 600 Fourth Avenue, 12th Floor, Seattle, WA 98104-1873.

Clark-Carter, D.D., Heyes, A.D., Howarth, I. (1987). *The gait of visually impaired pedestrians*. Human Movement Science 6 (pp. 277-282). North Holland: Elsevier Science Publishers B.V.

This research study documents the gait characteristics (speed, stride length, etc.) of adults with visual impairments.

Elsevier Science, Regional Sales Office, Customer Support Department, P.O. Box 945, New York, NY 10159-0945, Telephone: (212) 633-3680 or (800) 4ES-INFO, Fax: (212) 633-3680, Email: usinfo-f@elsevier.com.

Conley, J., Vogel, J., Chilman, K. (1990). *Open-area management and monitoring programs*. Proceedings of the cooperative off-highway vehicle workshop. (pp. 10-12) Waterville: Motorcycle Industry Council.

This article discusses the open-area management of an outdoor recreation and environmental education demonstration area administered by the Tennessee Valley Authority (TVA) in western Kentucky and Tennessee designated for off-road vehicle (ORV) riding and contrasts that to designating individual trails for ORV use.

TVA's Land Between the Lakes, Golden Pond, KY 42211, Telephone: (502) 924-5602, Fax: (502) 924-2093.

Council of American Building Officials. (1992). *American national standard: Accessible and usable buildings and facilities* (CABO/ANSI A117.1-1992). Falls Church.

This manual provides recommendations for designing buildings and facilities that are accessible to and usable by people with disabilities.

Council of American Building Officials, 5203 Leesburg Pike, #708, Falls Church, VA 22041, Telephone: (703) 931-4533.

Covington, G.A., Hannah, B. (1997). *Access by design*. New York: International Thomson Publishing Inc.

This book promotes the application of universal design principles in the creation of products, spaces, and services.

Van Nostrand Reinhold, 115 Fifth Avenue, New York, NY 10003.

Davies, S.C. (1993). *Designing effective pedestrian improvements in business districts*. New York: Project for Public Spaces.

This report discusses how pedestrian improvements can be designed and managed to meet peoples' needs more effectively.

Project for Public Spaces, Inc., 875 Avenue of the Americas, Room 201, New York, NY 10001.

De Leuw, C., Jr., Danielson, F., Kudlick, W., Swan, S. (1981). *Effective treatments of over- and undercrossings for use by bicyclists, pedestrians, and the handicapped*. Washington: Federal Highway Administration.

This study provides information about improving access to under- and overcrossings for bicyclists, pedestrians, and the handicapped.

National Information Service, Springfield, VA 22161, Telephone: (703) 605-6000, Fax: (703) 321-8547.

Department of Rehabilitation. (1995). *Access guide: Survey checklist*. Sacramento.

This booklet contains a checklist that can be used to determine whether buildings meet accessible accommodation requirements applicable within the State of California.

Department of Rehabilitation, ADA Implementation Section, P.O. Box 944222, Sacramento, CA 94244-2220, Telephone: (916) 322-0251, TTY (916) 322-1096, CALNET 492-0251 (Voice or TTY).

DiStefano, J., Raimi, M. (1996). *Five years of progress: 110 communities making a difference*. Washington: Surface Transportation Policy Project.

This series of case studies highlights successful community ISTEAs projects.

Surface Transportation Policy Project, 1100 Seventeenth Street, N.W., Tenth Floor, Washington, DC 20036, Telephone: (202) 466-2636, Fax: (202) 466-2247, Email: stpp@transact.org.

Division of Engineering, Lexington–Fayette County Urban Government. (1993). *Sidewalks: A home owner's guide*. Lexington.

This booklet provides an outline of the Urban County Government sidewalk inspection program. It is intended to aid property owners in the regular maintenance of right-of-ways adjoining their private property.

Division of Engineering, Lexington–Fayette County Urban Government, Lexington–Fayette Government Building, 200 East Main Street, Lexington, KY 40507, Telephone: (606) 258–3410.

Earnhart, G., Simon, L. (1987). *Accessibility for elderly and handicapped pedestrians: A manual for cities*. McLean: Turner–Fairbank Highway Research Center.

This handbook provides an overview of existing accessibility planning and programming. Each chapter provides definitions, illustrations, and Federal standards, if they exist, and includes a section on problems and recommended solutions.

National Technical Information Service, Springfield, VA 22161, Telephone: (703) 605–6000.

Ellis–Cauthron, S.L., Cauthron, H.E. (1995). *Accessibility survey for identification of structural barriers to programs and services at visitor centers, developed campgrounds, and day-use/picnic areas*. Phoenix.

This is a collection of survey forms that land managers can use to identify structural barriers to programs and services at visitor centers and outdoor facilities.

Sandra LeAnn Ellis–Cauthron, 6702 West Merrell Street, Phoenix, AZ 85033.

Equal Employment Opportunity Commission, U.S. Department of Justice. (1991). *Americans with Disabilities Act handbook*. Washington.

This handbook was written to provide information and assistance on the ADA to people with disabilities, businesses, and the public. This handbook is a particularly valuable tool that contains EEOC Title I regulations and DOJ Title II and III regulations, together with a section-by-section analysis of each regulatory provision.

U.S. Department of Justice, Telephone: (202) 514–0301 or (800) 514–0301, TTY: (800) 514–0383.

Farbman, A., Park, D.C. (1989d). *Philosophical foundations in providing accessible recreation facilities*. Design: Access 4: Philosophical Concepts: Accessible Picnic Areas and Campgrounds. pp. 3–16. (Fall 1989). Washington: Park Practice Program.

This article is the last in a series of four outlining accessibility design requirements as they relate to standards development, access to buildings and structures, and access to outdoor recreation and trails.

National Recreation and Park Association, 22377 Delmont Ridge Road, Ashburn, VA 20148, Telephone: (703) 858–0784, Fax: (703) 858–0794.

Federal Highway Administration. (1994). *Final report: The national bicycling and walking study: Transportation choices for a changing America*. Washington.



This study analyzes the current state of bicycling and walking in the United States.

Federal Highway Administration, U.S. Department of Transportation,  
400 Seventh Street, S.W., Washington, DC 20590. Fax requests to  
FHWA R & T Report Center: (301) 577-1421.

Federal Highway Administration. (1996a). *Chapter 18 facilities for pedestrians and bicyclists*. Washington.

This book discusses taking bicyclists and pedestrians into consideration when proposed facilities are being designed.

U.S. Government Printing Office, Superintendent of Documents, P.O.  
Box 371954, Pittsburgh, PA 15250-7954, Telephone: (202) 512-1800,  
Fax: (202) 512-2233.

Federal Highway Administration, Region 8 Office. (1996b). *Commentary and text: Section 14: ADA accessibility guidelines*. Lakewood.

This booklet is designed to assist designers, builders, architects, and other planners in the interpretation of Section 14 of the ADA Accessibility Guidelines.

Brenda Weltzer, Federal Highway Administration, Region 8 Office,  
555 Zang Street, Suite 400, Lakewood, CO 80228, Telephone: (303) 969-6716.

Federal Highway Administration. (1997a). *Flexibility in highway design*. Washington. Report # FHWA-PD-97-062.

This book identifies and explains the opportunities and constraints facing designers and design teams responsible for the development of transportation facilities. It includes many illustrations and examples of well-designed highways and roadways.

Federal Highway Administration, U.S. Department of Transportation,  
400 Seventh Street, S.W., Washington, DC 20590. Telephone: (202) 366-0106.

Federal Highway Administration. (1997b). *Urban drainage design programs: HY-22 version 2.0 [diskette]*. Washington.

This technical manual provides a comprehensive guide to designing storm drainage systems for transportation facilities.

Federal Highway Administration, U.S. Department of Transportation,  
400 Seventh Street, S.W., Washington, DC 20590.

Federal Highway Administration, Associate Administrator for Program Development, *Designation of Bicycle and Pedestrian Coordinators within State Departments of Transportation*, January 28, 1992.

This letter outlines the responsibilities of bicycle and pedestrian coordinators within State departments of transportation.

Federal Highway Administration, Federal Transit Administration, Acting Associate Administrator for Program Development, *Associate Administrator for Grants Management, Federal Transit Administration*, November 28, 1994.

This unpublished letter discusses the distribution of interim technical guidance for bicycle and pedestrian planning at State and local MPO levels.

Federal Highway Administration, Federal Transit Administration. (1995). *A guide to metropolitan transportation planning under ISTEA: How the pieces fit together*. Washington: Federal Highway Administration. Report # FHWA-PD-95-031.

This guidebook describes how Metropolitan Planning Organizations operate under ISTEA. Long- and short-range plans are discussed in detail.

Federal Highway Administration, U.S. Department of Transportation, 400 Seventh Street, S.W., Washington, DC 20590. Telephone: (202) 366-5003.

Federal Highway Administration, National Highway Traffic Safety Administration. (1996). *Pedestrian and bicyclist safety and accommodation: Participant workbook*. Washington: Federal Highway Administration. Report # FHWA-HI-96-028.

Prepared by Dan Burden and Betty Drake, this book supplements a National Highway Institute course that focused on pedestrian and bicycle safety and design. It outlines how focus groups and charities can be incorporated into a public participation model.

Federal Highway Administration, U.S. Department of Transportation, 400 Seventh Street, S.W., Washington, DC 20590. Fax requests to FHWA R & T Report Center: (301) 577-1421.

Fischer, J.W. (1998a). *ISTEA reauthorization: Highway and transit legislative proposals in the 105th Congress: Second session*. Washington: Congressional Research Service, Library of Congress.

This report discusses the structure of the House and Senate proposals and provides an overview of the issues that might have come to the forefront during conference.

Congressional Research Service, Library of Congress, Washington, DC 20540-7000.

Fischer, J.W. (1998b). *Transportation trust funds: Budgetary treatment*. Washington: Congressional Research Service, Library of Congress.

This report addresses issues associated with the purpose and use of transportation trust funds.

Congressional Research Service, Library of Congress, Washington, DC 20540-7000.

Fisher, S.V., and Gullickson, G. (1978). *Energy cost of ambulation in health and disability: A literature review*. Archives of Physical Medicine and Rehabilitation, 59, pp. 124-133.

A review of literature pertaining to the energy cost of ambulation with various types of disability. It summarizes previously published research on the energy cost of various physical disabilities.

Archives of Physical Medicine and Rehabilitation, W.B. Saunders Company, Periodicals Department, 6277 Sea Harbor Drive, Orlando, FL 32887-4800, Telephone: (407) 345-2500 or (800) 654-2452, Outside USA or Canada: (407) 345-4000, Web site: [www.archives-pmr.org/apmr/about.html](http://www.archives-pmr.org/apmr/about.html).

Fisher, S.V., and Patterson, R.P. (1981). *Energy cost of ambulation with crutches*. Archives of Physical Medicine and Rehabilitation, 62, pp. 125-127.

This study compares the energy cost of ambulation for walking with that of underarm crutches on level terrain, grade, and climbing stairs.

Archives of Physical Medicine and Rehabilitation, W.B. Saunders Company, Periodicals Department, 6277 Sea Harbor Drive, Orlando, FL 32887-4800, Telephone: (407) 345-2500 or (800) 654-2452, Outside USA or Canada: (407) 345-4000, Web site: [www.archives-pmr.org/apmr/about.html](http://www.archives-pmr.org/apmr/about.html).

Flascher, O.M., Kadar, E.E., Garrett, S.R., Meyer, J., Shaw, R.E. (1995). *Perceptual scaling of doorways: An investigation of perception for design principles development*. In J.L. Nasar, P. Grannis, K. Hanyu (Eds.), *Proceedings of the Twenty-Sixth Annual Conference of the Environmental Design Research Association* (pp. 18-23). Boston, MA: Ohio State University.

This study investigates the relationship between a passageway's size and a human's perception of its accessibility. The researchers propose that this measure of clearance can be applied to ensure the design of maximally efficient and safe throughways and access technologies.

Environmental Design Research Association, P.O. Box 7146, Edmond, OK 73083-7146, Telephone: (405) 330-4863, Fax: (406) 330-4150, Email: [edra@telepath.com](mailto:edra@telepath.com).

Flasher, O.M., Kadar, E.E., Shaw, R.E. (1993). *Dimensionless invariance for intentional systems: Measuring the fit of vehicular activities to environmental layout*. In J.M. Flach, P.A. Hancock, J.K. Caird, K.J. Vicente (Eds.), *An ecological approach to human-machine systems I: A global perspective*. (Chapter 11). Hillsdale: Lawrence Erlbaum Associates.

This article considers how wheelchair users are able to select and follow the best route through cluttered and obstacle-laden courses. It discusses using dimensionless invariance to measure the dynamic fit of active wheelchairs through their functional spaces if given a navigational goal.

Lawrence Erlbaum Associates, 10 Industrial Avenue, Mahwah, NJ 07430-2262, Telephone: (201) 236-9500 or (800) 9-BOOKS-9, Fax: (201) 236-0072, Email: [orders@erlbaum.com](mailto:orders@erlbaum.com).

Florida Department of Transportation, State Safety Office, MS 82. (1997). *Bicycle facilities planning and design handbook*. Tallahassee: Bicycle and Pedestrian Program.

This manual provides a practical overview of the concept and need for bicycle roadway planning. It includes defined terms, bicycle planning needs, principles, and issues. It also describes the bicycle planning process in terms of engineers and community collaboration.

Florida Department of Transportation, Bicycle/Pedestrian Program, State Safety Office, 605 Suwannee Street, Mail Station 82, Tallahassee, FL 32399-0450.

Gallon, C. (1992). *Contractor report 317: Tactile surfaces in the pedestrian environment: Experiments in Wolverhampton*. Crowthorne: Transport and Road Research Laboratory.

This report looks at how effective tactile markings would be in a real pedestrian environment and what form the layout of these surfaces should take.

Vehicles and Environment Division, Vehicles Group, Transport and Road Research Laboratory, Old Wokingham Road, Crowthorne, Berkshire RG11 6AU, Telephone: (STD 0344) 773131, Telex: 848272, Fax: 0344 770356.

Gallon, C., Oxley, P., Simms, B. (1991). *Contractor report 257: Tactile footway surfaces for the blind*. Crowthorne: Transport and Road Research Laboratory.

This document summarizes research to determine how well different textured surfaces were distinguished by the visually disabled.

Vehicles and Environment Division, Vehicles Group, Transport and Road Research Laboratory, Old Wokingham Road, Crowthorne, Berkshire RG11 6AU, Telephone: (STD 0344) 773131, Telex: 848272, Fax: 0344 770356.

Geiger, R.A., Jr. (Summer 1989). *National Wildlife Federation's Mountain Laurel Trail*. Design access 3: Access to outdoor recreation: Trails, pp. 12–16.

This document examines accessibility issues in the outdoor recreation environment using the Mountain Laurel Trail as an example.

Park Practice Program, National Park Service, P.O. Box 37127, Washington, DC 20013-7127, Telephone: (202) 343–7067.

Georgia Institute of Technology. (1979). *Provisions for elderly and handicapped pedestrians: Volume 1: Executive summary*. Springfield: U.S. Department of Commerce.

This document is an executive summary of research done regarding older pedestrians and pedestrians with disabilities. It outlines the research methodologies and summarizes the results of the study.

National Technical Information Service, Springfield, VA 22161, Telephone: (703) 605–6000.

Gilbert, T.A., Goltsman, S.M., Wohlford, S.D. (1992). *User's guide: The accessibility checklist: An evaluation system for buildings and outdoor settings*. Berkeley: MIG Communications.

A comprehensive checklist to determine whether buildings and outdoor settings comply with the ADA Guidelines, UFAS, and California's Title 24 building codes.

MIG Communications, 1802 Fifth Street, Berkeley, CA 94710, Telephone: (510) 845–0953.

Gilleran, B.F., Pates, G. (1994). *Bicycling and walking in the nineties and beyond: Applying Scandinavian experience to America's challenges*. Washington: Federal Highway Administration. Report # FHWA-PL-95-005.

This report is a review of Scandinavian techniques, technologies, practices, and policies for promoting bicycling and pedestrian transportation. It includes an examination of their applicability in the United States.

Federal Highway Administration, U.S. Department of Transportation, 400 Seventh Street, S.W., Washington, DC 20590. Fax requests to FHWA R & T Report Center: (301) 577–1421.

Golden, M., Kilb, L., Mayerson, A. (1993). *Americans with Disabilities Act: An implementation guide*. Berkeley: Disability Rights Education and Defense Fund, Inc.

This manual is designed to provide answers to questions businesses, organizations, and individuals might have about the ADA. The explanation of the law integrates the legislative history, the statute, the regulations and analyses, and Section 504 cases. A guide to legal documents, selected cases under Section 504, and a section on tax incentives are also included.

DREDF, 2212 Sixth Street, Berkeley, CA 94710, Telephone: (510) 644-2555 or (800) 466-4232.

Goltsman, S.A., Gilbert, T.A., Wohlford, S.D. (1993a). *Survey forms: The accessibility checklist: An evaluation system for buildings and outdoor settings: Second edition*. Berkeley: MIG Communications.

This book contains forms to use in conducting accessibility evaluations of buildings and outdoor facilities. Instructions for using the Survey Forms are contained in the User's Guide, the companion volume of The Accessibility Checklist.

MIG Communications, 1802 Fifth Street, Berkeley, CA 94710, Telephone: (510) 845-8750, Fax: (510) 845-8750.

Goltsman, S.A., Gilbert, T.A., Wohlford, S.D. (1993b). *User's guide: The accessibility checklist: An evaluation system for buildings and outdoor settings: Second edition*. Berkeley: MIG Communications.

Designed to accompany *Survey Forms*, this checklist translates the codes and standards of the ADA guidelines and the UFAS standards used on the forms.

MIG Communications, 1802 Fifth Street, Berkeley, CA 94710, Telephone: (510) 845-8750, Fax: (510) 845-8750.

Governor's Committee on Concerns of the Handicapped. (1995). *Sidewalk and curb ramp design*. Santa Fe.

This outline contains design regulations and requirements for all situations encountered with ramp design.

Governor's Committee on Concerns of the Handicapped, Lamy Building Room 117, 491 Old Santa Fe Trail, Santa Fe, NM 87503, Telephone: (505) 827-6465, TDD: (505) 827-6329, Fax: (505) 827-6328.

Greenways Incorporated. (1992a). *Case study no. 7: Transportation potential and other benefits of off-road bicycle and pedestrian facilities*. Washington: Federal Highway Administration. Report # FHWA-PD-92-040.

This report is a compendium of the benefits gained by having bicycle and pedestrian trails; it cites examples of highly successful community greenways.

Federal Highway Administration, U.S. Department of Transportation, 400 Seventh Street, S.W., Washington, DC 20590. Fax requests to FHWA R & T Report Center: (301) 577-1421.

Greenways Incorporated. (1992b). *Case study no. 24: Current planning guidelines and design standards being used by State and local agencies for bicycle and pedestrian facilities*. Washington: Federal Highway Administration. Report # FHWA-PD-93-006.

This is a review of some State and local existing bicycle and pedestrian programs to determine the state-of-practice. The report summarizes the best guidelines and standards currently being used. It also names reference materials critical for leading-edge facility design.

Federal Highway Administration, U.S. Department of Transportation,  
400 Seventh Street, S.W., Washington, DC 20590. Fax requests to  
FHWA R & T Report Center: (301) 577-1421.

Greenways Incorporated. (1996). *Birmingham-area bicycle, pedestrian, and greenway plan: Final plan report*. Birmingham: Birmingham Regional Planning Commission.

This document contains the projected transportation needs of the Birmingham area to the year 2015. Detailed maps, charts, and requirements are also included.

Birmingham Regional Planning Commission, Magnolia Office Park Suite 220,  
2112 Eleventh Avenue South, Birmingham, AL 35256-4799, Telephone:  
(205) 251-8139.

Gusey, D.L. (1991). *Trail hardening test: Project # ORV-86-3P: Final report*.  
Washington: State of Washington Interagency Committee for Outdoor Recreation.

This report discusses study results after examining different methods to harden trails to inhibit erosion and better maintain trails.

Daryl L. Gusey, Grand Mesa, Uncompahgre and Gunnison National  
Forests, 2250 Highway Fifty, Delta, CO 81416, Telephone: (303) 874-7691,  
DG: RO2FO4A.

Guth, D.A., Rieser, J.J. (1997). *Perception and the control of locomotion by blind and visually impaired pedestrians*. In B.B. Blasch, W.R. Wiener, R.L. Welsh (Eds.), *Foundations of orientation and mobility: Second edition*. (pp. 9-37). New York: AFB Press.

This chapter from *Foundations of Orientation and Mobility* discusses how pedestrians with visual impairments obtain information about and navigate through the pedestrian environment.

AFB Press, American Foundation for the Blind, 11 Penn Plaza, New York,  
NY 10001, Web site: [http://www.afb.org/r\\_dwrep.html](http://www.afb.org/r_dwrep.html).

Hall, G., Rabelle, A., Zabihaylo, C. (1994). *Audible traffic signals: A new definition*.  
Montreal: Montreal Association for the Blind.

This guidance document provides government agencies with information regarding audible traffic signals.

Montreal Association for the Blind (MAB), 7000 Shebrooke Street West,  
Montreal, Quebec H4B 1R3.

Harkey, D.L., Stewart, J.R., Rodgman, E.A. (1996). *Evaluation of shared-use facilities for bicycles and motor vehicles: Final report*. Tallahassee: Florida Department of Transportation.

Sponsored by the Florida Department of Transportation, this study evaluates the safety and utility of shared-use facilities to provide engineers and planners comprehensive results.

Theo Petritsch, State Pedestrian and Bicycle Coordinator, Florida Department of Transportation, 605 Suwannee Street, MS-82, Tallahassee, FL 32399, Telephone: (850) 487-1200, Fax: (850) 922-2935, Email: theopetritsch@dot.State.fl.us.

Hauger, J.S., Rigby, J.C., Safewright, M., McAuley, W.J. (1996). *Detectable warning surfaces at curb ramps*. *Journal of Visual Impairment and Blindness*, 90, pp. 512-525.

This article includes tests of blind pedestrians' need for detectable warning surfaces at curb ramps.

AFB Press, American Foundation for the Blind, 11 Penn Plaza, New York, NY 10001.

Hesselbarth, W., Vachowski, B. (1996). *Trail construction and maintenance notebook*. Missoula: USDA Forest Service.

Written in a concise, pocket format that can be used on the trail, this guide summarizes basic trail construction and maintenance information relevant to field work.

USDA-FS, Missoula Technology and Development Center, Building One, Fort Missoula, Missoula, MT 59804-7294, Telephone: (406) 329-3900, Fax: (406) 329-3719.

Hooper, L. (1994). *NPS trails management handbook*. Denver: Denver Service Center.

This book contains easily reduced drainage and construction guidelines.

Lennon Hooper Trails Coordinator, National Park Service, P.O. Box 25287, 655 Parfet Street, Denver, CO 80225.

Hopf, P.S., Raeber, J.A. (1984). *Access for the handicapped*. New York: Van Nostrand Reinhold Company Inc.

This book provides information to make facilities suitable for use by the physically handicapped.

Van Nostrand Reinhold Company Inc., 135 West Fiftieth Street, New York, NY 10020.

Hughes, R.G. (1995). *An evaluation of detectable warnings in curb ramps: Mobility considerations for the blind and visually impaired*. Tallahassee: Florida Department of Transportation.

This study tested the optimal configuration for detectable warnings installed on curb ramps. It also analyzed any difficulties subjects had with negotiating the ramp and provided recommendations on ramp design and configuration regarding tactile warnings.

Theo Petritsch, State Pedestrian and Bicycle Coordinator, Florida Department of Transportation, 605 Suwannee Street, MS-82, Tallahassee, FL 32399, Telephone: (850) 487-1200, Fax: (850) 922-2935, Email: theopetritsch@dot.State.fl.us.

Hughes, R.G., and Harkey, D. (1996). *Lane conditions, traffic speed, and traffic volume: Effects on cyclists' perception of risk in a virtual environment*. Tallahassee: Florida Department of Transportation.

This study addresses the extent to which bicyclists' use of roadway facilities is affected by the conditions of the curb lane, traffic speed, and traffic volume. Subjects viewed several virtual environment simulations of a road from different perspectives.

Theo Petritsch, State Pedestrian and Bicycle Coordinator, Florida Department of Transportation, 605 Suwannee Street MS-82, Tallahassee, FL 32399, Telephone: (850) 487-1200, Fax: (850) 922-2935, Email: theopetritsch@dot.State.fl.us.

Institute of Transportation Engineers, Technical Council Committee A-55. (1997a). *Review of planning guidelines and design standards for bicycle facilities*. Washington: Institute of Transportation Engineers.

This report defines planning guidelines and design standards used by States and localities to develop bicycle facilities and identifies practices that can be used as models by other communities.

Institute of Transportation Engineers, 525 School Street, S.W., Suite 410, Washington, DC 20024-2797, Telephone: (202) 554-8050, Fax: (202) 863-5486.

Institute of Transportation Engineers, Technical Council Committee 5A-5. (1998). *Design and safety of pedestrian facilities*. Chapel Hill.

Provides design recommendations for developing safer and more accessible pedestrian facilities.

Institute of Transportation Engineers, 525 School Street, S.W., Suite 410, Washington, DC 20024-2797, Telephone: (202) 554-8050, Fax: (202) 863-5486.

Institute of Transportation Engineers, Transportation Planning Council Committee 5P-8. (1997b). *Traditional neighborhood development: Street design guidelines*. Washington.

This report, a recommended practice published by ITE, discusses traditional neighborhood development, design parameters, and community planning.

Institute of Transportation Engineers, 525 School Street, S.W., Suite 410, Washington, DC 20024-2797, Telephone: (202) 554-8050, Fax: (202) 863-5486, Web site: <http://www.ite.org>.

Intermodal Surface Transportation Efficiency Act. (1991). *Public Law 240, 102nd Congress*. (December 18, 1991).

This law authorizes transportation funds to be spent on improving intermodal surface transportation alternatives for moving goods and people.

U.S. Government Printing Office, Superintendent of Documents, P.O. Box 371954, Pittsburgh, PA 15250-7954, Telephone: (202) 512-1800, Fax: (202) 512-2233.

Jacobson, W.H. (1993). *The art and science of teaching orientation and mobility to persons with visual impairments*. New York: American Foundation for the Blind.

This textbook teaches orientation and mobility professionals to instruct people with visual impairments in wayfinding and navigation techniques.



AFB Press, American Foundation for the Blind, 15 West 16th Street,  
New York, NY 10011.

Jansma, P., French, R. (1994). *Special physical education: Physical activity, sports, and recreation*. Des Moines: Prentice Hall.

Identifies the impact of various disabilities on the participation in physical activity, sports, and recreation programs. Discusses effective strategies for including individuals with disabilities in physical activity.

Prentice Hall, Order Processing Center, P.O. Box 11071, Des Moines,  
IA 50336, Telephone: (800) 947-7700, Fax: (515) 284-6709,  
Email: orders@prenhall.com.

Joffe, E. (1994). *A detectable warnings implementation document*. Washington: Federal Transit Administration.

This report contains technical help and information on the ADA Rule of 1991.

American Foundation for the Blind, Web site: [http://www.afb.org/r\\_dwrep.html](http://www.afb.org/r_dwrep.html).

Kadar, E.E., Flascher, O.M., Shaw, R.E. (1995). *A field theoretic description for navigation through cluttered environments: Consequences for environment design*. In J.L. Nasar, P. Grannis, K. Hanyu (Eds.), *Proceedings of the EDRA* (pp. 13–17). Edmond: Environmental Design Research Association.

This paper proposes the concept of isovists, or the points visible to a vantage point in space taken with respect to the environment, as useful tools in the objective assessment of environment functionality. It also describes a prototype device that can be used in evaluation.

Environmental Design Research Association, P.O. Box 7146, Edmond,  
OK 73083-7146, Telephone: (405) 330-4863, Fax: (406) 330-4150,  
Email: edra@telepath.com.

Kell, J.H., Fullerton, I.J. (1982). *Manual of traffic signal design*. Washington: Institute of Transportation Engineers.

This manual discusses how to design traffic signals that function well in the street environment.

Institute of Transportation Engineers, 525 School Street, S.W.,  
Suite 410, Washington, DC 20024-2797, Telephone: (202) 554-8050,  
Fax: (202) 863-5486, Web site: <http://www.ite.org>.

Kentucky Department of Parks. (1989). *Trail construction and maintenance: Division of recreation and interpretation*. Frankfort.

This book contains guidelines for equestrian, hiking, OHV, and mountain bike trails.

Kentucky Department of Parks, Telephone: (502) 564-2172.

Knoblauch, R.L., Crigler, K.L. (1987a). *Model pedestrian safety program: User's guide*. McLean: Federal Highway Administration.

This guide describes how localities can plan, implement, and evaluate a pedestrian safety program.

National Technical Information Service, Technology Administration,  
U.S. Department of Commerce, Springfield, VA 22161, Telephone:  
(703) 605-6000, Fax: (703) 321-8547.

Knoblauch, R.L., Crigler, K.L. (1987b). *Model pedestrian safety program: User's guide: Supplement*. McLean: Federal Highway Administration.

This supplement provides detailed information on specific pedestrian encounters.

National Technical Information Service, Technology Administration,  
U.S. Department of Commerce, Springfield, VA 22161, Telephone:  
(703) 605-6000, Fax: (703) 321-8547.

Knoblauch, R., Nitzburg, M., Dewar, R., Templer, J., Pietrucha, M. (1995). *Older pedestrian characteristics for use in highway design*. McLean: Federal Highway Administration.

This report conducts a field study on more than 7,000 pedestrians in four cities to determine older-pedestrian data. This was done to develop traffic planning and engineering guidelines with older-pedestrian capabilities in mind.

National Technical Information Service, Springfield, VA 22161,  
Telephone: (703) 605-6000.

Knoblauch, R.L., Tustin, B.H., Smith, S.A., Pietrucha, M.T. (1988). *Investigation of exposure-based pedestrian areas: Crosswalks, sidewalks, local streets, and major arterials*. McLean: Federal Highway Administration.

This study determined how well drivers and pedestrians recognize marked crosswalk designs.

National Technical Information Service, Springfield, VA 22161,  
Telephone: (703) 605-6000.

Lamont, B., et al. (1997). *Encouraging local planning and regional cooperation*. Colorado Commons, pp. 15-17. (Spring 1997).

This article discusses techniques for encouraging local and regional coordination with regard to transportation issues.

Colorado Commons, P.O. Box 417, Longmont, CO 80502-0417,  
Telephone: (303) 530-1925 ext. 114, Fax: (303) 530-2401, Web site:  
[www.cityofdreams.com](http://www.cityofdreams.com).

Lexington-Fayette Urban County Government. (1993). *Sidewalks: A homeowner's guide*. Lexington.

This booklet contains procedures for evaluating sidewalks and an outline of the local sidewalk improvement maintenance program.

Lexington-Fayette Urban County Government, Division of Engineering,  
Lexington-Fayette Government Building, 200 East Main Street, Lexington,  
KY 40507, Telephone: (606) 258-3410.

Long, R.G., Hill, E.W. (1997). *Establishing and maintaining orientation for mobility*. In B.B. Blasch, W.R. Wiener, R.L. Welsh (Eds.), *Foundations of orientation and mobility: Second edition*, (pp. 39–59). New York: AFB Press.

This is a chapter from Foundations of Orientation and Mobility about spatial orientation of individuals who are blind or visually impaired. It focuses on spatial problems they must solve to move efficiently from place to place and the strategies or tools they use to solve them.

AFB Press, American Foundation for the Blind, 11 Penn Plaza, New York, NY 10001. Web site: [http://www.afb.org/r\\_dwrep.html](http://www.afb.org/r_dwrep.html).

Macdonald, S.H. (1988). *Colorado off-highway vehicle recreation plan*. Denver: Colorado Division of Parks and Outdoor Recreation.

This document reviews current needs and problems of OHV use in Colorado. It also analyzes proposed actions and makes recommendations.

Colorado Division of Parks and Outdoor Recreation, 1313 Sherman Street, Room 618, Denver, CO 80203, Telephone: (303) 866–3437.

Mace, R.L., Hardie, G.J., Place, J.P. (1991). *Accessible environments: Toward universal design*. Raleigh: The Center for Universal Design.

This booklet discusses how universal design can benefit all segments of the population and suggests design principles that can be used to improve access to buildings, outdoor facilities, and other spaces. It also discusses the disabled population and provides an overview of the accommodations required by the Americans with Disabilities Act.

The Center for Universal Design, North Carolina State University, P.O. Box 8613, Raleigh, NC 27695-8613, Telephone and TDD: (919) 515–3082, Info. Requests: (800) 647–6777.

Maine Bureau of Parks and Recreation Department of Conservation. (1995). *1994/1995 Bicycling survey of household residents*. Augustus: Maine Department of Transportation.

This report details the results of a statewide survey of Maine residents regarding bicycling habits, attitudes, complaints, and criticisms of existing bicycle transportation conditions.

Maine Department of Transportation, Sixteen State House Station, Augusta, ME 04333-0016, Telephone: (207) 287–3318, Fax: (207) 287–8300, Web site: [www.State.me.us/mdot/opt/opt1.htm](http://www.State.me.us/mdot/opt/opt1.htm).

Maine Department of Transportation. (1995). *You can get there from here: Volume two: The pedestrian plan*. Augusta.

This report provides an overview of State and local bodies involved with implementing the Multimodal Transportation Act of 1991. The report discusses current needs and conditions and proposes engineering and design principles to facilitate the execution of the plan.

Maine Department of Transportation, Sixteen State House Station, Augusta, ME 04333-0016, Telephone: (207) 287–3318, Fax: (207) 287–8300, Web site: [www.State.me.us/mdot/opt/opt1.htm](http://www.State.me.us/mdot/opt/opt1.htm).

Marcil, F. (1995). *Multi-use trails in Canada: An analysis of some successful cases*. Montreal: Velo Quebec.

This book discusses the importance of having multi-use trails in Canada. It pairs problems and situations with proposed ideas and solutions.

Velo Quebec, 1251 Rue Rachel Est, Montreal (Quebec) H2J 2J9 Canada, Telephone: (514) 521-8356, Fax: (514) 521-5711.

Marshall, L. (1993). *Responsible riding: Snowmobilers aim to freeze out unethical behavior*. *Outdoor Ethics*, 12 (1), pp. 1-4.

This article cites various problems associated with snowmobiling.

Joshua Winchell, Outdoor Ethics Program, Izaak Walton League of America, 707 Conservation Lane, Gaithersburg, MD 20878-2983, Telephone: (301) 548-0150, Fax: (301) 548-0146.

Materials Division, Virginia Transportation Research Council. (1996). *Pavement design guide for subdivision and secondary roads in Virginia*. Richmond: Virginia Department of Transportation.

This document is a companion reference to the Subdivision Street Requirements booklet. It also replaces three earlier documents designated VHRC 73-R18, VHRC 73-R21, and the 1993 revision for secondary and subdivision pavement design manuals.

Virginia Department of Transportation, Secondary Roads Division, 1401 East Broad Street, Richmond, VA 23219, Telephone: (804) 786-2576, Fax: (804) 7786-2603.

McAuley, W.J., Hauger, J.S., Safewright, M.P., Rigby, J.C. (1995). *The detectable warnings project*. Washington: U.S. Architectural and Transportation Barriers Compliance Board.

This paper discusses the results of a study to determine the level of detectability of a variety of raised tactile warning surfaces.

U.S. Access Board, Recreation Report, 1331 F Street, N.W., Suite 1000, Washington, DC 20004-1111, Telephone: (202) 272-5434 or (800) 872-2253, TTY (202) 272-5449 or (800) 993-2822, Web site: <http://www.access-board.gov/rules/child.htm>.

McCoy, M., Stoner, M. (1992). *Mountain bike trails: Techniques for design, construction, and maintenance*. Missoula: Bikecentennial.

This publication contains illustrations and tables of mountain-bike-trail design techniques.

Adventure Cycling Association, P.O. Box 8308, Missoula, MT 59807, Telephone: (406) 721-1776, Fax: (406) 721-8754.

McMillan, J. (1982). *Crowded urban pathways create perils for exercisers*. *The Physician and Sportsmedicine*, 10, pp. 179-180. (October 1982).

This article summarizes the types of injury and increased risks that have been observed with the growing use of shared-use paths and highlights injuries resulting from user conflicts, particularly related to differences in user speed (e.g., bike versus pedestrian).

The Physician and Sportsmedicine, 4530 West Seventy-Seventh Street, Minneapolis, MN 55435, Telephone: (612) 835-3222, Fax: (612) 835-3460, Web site: [www.physsportsmed.com](http://www.physsportsmed.com).

Metropolitan Center for Independent Living. (1993). *How to build ramps for home accessibility*. St. Paul.

This manual offers ramp design standards and principles, ramp blueprints, hints for obtaining local building permits and building according to code, and suggestions for ramp maintenance.

Metropolitan Center for Independent Living, 1600 University Avenue, West, Suite Sixteen, St. Paul, MN 55104, Telephone: (612) 646-8342, TDD: (612) 603-2001, Fax: (612) 603-2006.

Mickelson, L. (1985). *Parkland access for the disabled*. Vancouver: Greater Vancouver Regional District Parks Department and Advent Accounting Services Ltd.

This publication is a design manual for planning and constructing accessible features in the outdoors. Text examples are heavily illustrated with diagrams of standard signage and facilities that include dimensions and useful accessories.

Greater Vancouver Regional District Parks, 4330 Kingsway, Burnaby, B.C., Canada V5H 4G8.

Missouri Department of Natural Resources. (1975). *Missouri State Parks: Trail construction guidelines*. Jefferson City.

This booklet contains the Missouri State Trails System guidelines for trail construction, as well as the procedure for signing trails.

Missouri Department of Natural Resources, Telephone: (573) 751-5360.

Moore, R.L. (1994). *Conflicts on multiple-use trails: Synthesis of the literature and state of the practice*. Washington: Federal Highway Administration. Report # FHWA-PD-94-031.

This report provides a synthesis of existing research to explain the underlying causes of trail conflict, identify approaches for promoting trail sharing, and identify gaps in current knowledge. Principles for minimizing conflicts on multiple-use trails are also reviewed.

Federal Highway Administration, 400 Seventh Street, S.W., Washington, DC 20590. Fax requests to FHWA R & T Report Center: (301) 577-1421.

Moore, R., Dattilo, J., Devine, M.A. (1996). *A comparison of rail-trail preferences between adults with and without disabilities*. Adapted Physical Activity Quarterly 13, pp. 27-37.

Survey research of users on three rail-trails to identify trail characteristics that significantly influence their use of the trail.

Human Kinetics Publishers, Inc., Fulfillment Department, P.O. Box 5076, Champaign, IL 61825-5076, Telephone: (800) 747-4457, Fax: (217) 351-1549, Web site: [www.humankinetics.com](http://www.humankinetics.com).

National Bicycle and Pedestrian Clearinghouse. (1996a). *NBPC technical brief*. Washington.

This newsletter contains public statistics information on bicycle transportation.

The National Bicycle and Pedestrian Clearinghouse, 1506 Twenty-First Street, N.W., Suite 200, Washington, DC 20036, Telephone: (800) 760-6272 or (202) 463-8405, Fax: (202) 463-6625, Email: bikefed@aol.com.

National Bicycle and Pedestrian Clearinghouse. (Ninth edition). (1996b). *NBPC technical brief*. Washington.

This newsletter contains design factors that are critical for nonmotorized trail users.

The National Bicycle and Pedestrian Clearinghouse, 1506 Twenty-First Street, N.W., Suite 210, Washington, DC 200036, Telephone: (800) 760-6272 or (202) 463-8405, Fax: (202) 463-6625, Email: bikefed@aol.com.

National Council on Disability. (1996). *Achieving independence: The challenge for the 21st century: A decade of progress in disability policy: Setting an agenda for the future*. Washington.

This book offers an assessment of the nation's progress in achieving equal opportunity and empowerment during the last decade.

National Council on Disability, 1331 F Street, N.W., Suite 1050, Washington, DC 20004-1107, Telephone: (202) 272-2004, Fax: (202)-272-2022, TDD: (202) 272-2074.

National Highway Traffic Safety Administration. (1998). *Zone guide for pedestrian safety*. Washington: U.S. Department of Transportation.

This document details a method to identify target areas for pedestrian improvements that would make the most impact on safety.

U.S. Department of Transportation, National Highway Traffic Safety Administration/Federal Highway Administration, 400 Seventh Street, S.W., Washington, DC 20590.

New Jersey Department of Transportation. (1995). *Statewide bicycle and pedestrian master plan*. Trenton.

This is the Bicycle and Pedestrian Master Plan for New Jersey. It delineates the vision, strategic planning model, current conditions and needs, implementation strategies, and actions and responsibilities of the plan and includes a list of supporting documents.

Bill Feldman, Pedestrian and Bicycle Advocate, New Jersey Department of Transportation, 1035 Parkway Avenue, P.O. Box 600, Trenton, NJ 08625-0600, Telephone: (609) 530-8062, Fax: (609) 530-3723, Email: billatng@aol.com.

New Jersey Department of Transportation. (1996). *Pedestrian-compatible planning and design guidelines*. Trenton: New Jersey Department of Transportation, Bureau of Suburban Mobility.

These guidelines include an overview of pedestrian activities and problems in New Jersey. Guidelines for accommodating pedestrians on roadways and design techniques encouraging pedestrian travel.

Bill Feldman, Pedestrian and Bicycle Advocate, New Jersey Department of Transportation, 1035 Parkway Avenue, P.O. Box 600, Trenton, NJ 08625-0600, Telephone: (609) 530-8062, Fax: (609) 530-3723, Email: billatng@aolcom.

New York State Department of Transportation. (1997). *The next generation: Transportation choices for the 21st century: The New York State bicycle and pedestrian plan*. Albany.

This document consists of planning strategies and design guidelines for bicycle and pedestrian facilities in New York State.

New York State Department of Transportation, Statewide Bicycle and Pedestrian Program, 1120 Washington Avenue, Building Four, Room 206, Albany, NY 12232-0424, Telephone: (518) 457-8307, Fax: (518) 457-1058, Email: mreilly@gw.dot.State.ny.us.

Nordhaus, R.S., Kantrowitz, M., Siembieda, W.J. (1984). *Accessible fishing: A planning handbook*. Santa Fe: New Mexico Natural Resources Department.

This document presents accessibility design guidelines for most fishing situations.

Resource Management and Development Division, New Mexico Natural Resources Department, Villagra Building, 408 Galisteo, Suite 129, Santa Fe, NM 87504-1147.

O'Leary, A.A., Lockwood, P.B., Taylor, R.V., Lavelly, J.L. (1995). *An evaluation of detectable warning surfaces for sidewalk curb ramps*. Richmond: Virginia Department of Transportation.

The authors of this report investigated the usage of raised detectable warnings, such as truncated domes on curb ramps and other sidewalk environments.

National Technical Information Service, Technology Administration, U.S. Department of Commerce, Springfield, VA 22161, Telephone: (703) 605-6000, Fax: (703) 321-8547.

Office of Traffic Operations, Federal Highway Administration. (1982). *Standard alphabets for highway signs and pavement markings*. Washington: U.S. Department of Transportation

This document contains the latest series of standard metric alphabets for highway signs and pavement markings created by the Federal Highway Administration at the request of the National Advisory Committee on Uniform Traffic Control Devices.

U.S. Government Printing Office, Superintendent of Documents, P.O. Box 371954, Pittsburgh, PA 15250, Telephone: (202) 512-1800, Fax: (202) 512-2233.

Ontario Parks. (1996). *Barrier-free guidelines design manual*. Ottawa.

This report presents guidelines for accessible design. Different needs and types of disabilities are also discussed.

Ontario Parks, 300 Water Street, P.O. Box 700, Peterborough, Ontario K9J 8M5, Telephone: (705) 755-PARK, Fax: (705) 755-1701, Email: ontparks@www.mnr.gov.on.ca.

Oregon Department of Transportation. (1995). *Oregon bicycle and pedestrian plan*. Salem.

This book is a guideline for State and local entities in Oregon involved in establishing bicycle and pedestrian facilities on local transportation systems.

Bicycle and Pedestrian Program, Room 210 Transportation Building,  
Salem, OR 97310, Telephone: (503) 986-3555, Fax: (503) 986-3749,  
Email: michael.p.ronkin@odot.State.or.us.

Orwig, M. (1995). *How to avoid trouble on the trail*. IWLA Outdoor Ethics Newsletter, Winter/Spring, pp. 4-5.

This article discusses human conflicts that occur on trails.

Joshua Winchell, Outdoor Ethics Program, Izaak Walton League of America, 707 Conservation Lane, Gaithersburg, MD 20878-2983,  
Telephone: (301) 548-0150, Fax: (301) 548-0146.

Park, D.C. (1989a). *Designing for everyone: Part of the public is disabled*. Design: Access 1: Standards Development: Space Requirements, pp. 3-16. (Winter 1989). Washington: Park Practice Program.

This document is the first in a series of four articles outlining accessibility design requirements as they relate to standards development, access to buildings and structures, and access to outdoor recreation and trails.

National Recreation and Park Association, 22377 Delmont Ridge Road,  
Ashburn, VA 20148, Telephone: (703) 858-0784, Fax: (703) 858-0794.

Park, D.C. (1989b). *What is accessibility?* Design: Access 2: Access to Buildings and Structures, pp. 3-16. (Spring 1989). Washington: Park Practice Program.

This document is the second in a series of four articles outlining accessibility design requirements as they relate to standards development, access to buildings and structures, and access to outdoor recreation and trails.

National Recreation and Park Association, 22377 Delmont Ridge Road,  
Ashburn, VA 20148, Telephone: (703) 858-0784, Fax: (703) 858-0794.

Park, D.C., Farbman, A. (1989c). *Accessible outdoor recreation facilities*. Design Access 3: Access to Outdoor Recreation: Trails, pp. 3-11. (Summer 1989). Washington: Park Practice Program.

This document is the third in a series of four articles outlining accessibility design requirements as they relate to standards development and access to buildings, structures, outdoor recreation, and trails.

National Recreation and Park Association, 22377 Delmont Ridge Road,  
Ashburn, VA 20148, Telephone: (703) 858-0784, Fax: (703) 858-0794.

Pedestrian Federation of America. (1995). *Walk tall: A citizens' guide to walkable communities*. Emmaus: Rodale Press.

This publication contains stories, ideas, suggestions, resources, and various charts for easy use by people of the community.

Rodale Press, Inc., Thirty-Three East Minor Street, Emmaus, PA 18098.



Pein, W.E. (1996). *Trail intersection design guidelines*. Tallahassee: Florida Department of Transportation.

This publication addresses the details associated with trail–roadway intersection design, with views toward minimizing accidents and problems at crossing points.

Theo Petritsch, State Pedestrian and Bicycle Coordinator, Florida Department of Transportation, 605 Suwannee Street MS-82, Tallahassee, FL 32399, Telephone: (850) 487–1200, Fax: (850) 922–2935, Email: theopetritsch@dot.State.fl.us.

Pennsylvania Department of Transportation, Bureau of Highway Safety and Traffic Engineering. (1996). *Statewide bicycle and pedestrian master plan: Bicycling and walking in Pennsylvania: A contract for the 21st century*. Pittsburgh.

This five-part document contains the planning strategies and design guidelines for bicycle and pedestrian facilities in Pennsylvania State.

Appalachian Trail Conference, P.O. Box 326, Harpers Ferry, WV 25425, Telephone: (304) 535–6331.

Pennsylvania Trails Program. (1980a). *Motorized trails: An introduction to planning and development*. Harrisburg: The Pennsylvania Trails Program, Division of Outdoor Recreation, Bureau of State Parks.

This is a guide to designing trails to be used by motorized vehicles.

Pennsylvania State Parks, Telephone: (717) 787–6674.

Pennsylvania Trails Program. (1980b). *Nonmotorized trails: An introduction to planning and development*. Harrisburg: The Pennsylvania Trails Program, Division of Outdoor Recreation, Bureau of State Parks.

This is a guide for developing nonmotorized trails and discusses maximizing public use of existing trails. It also includes a section on improving access for people with disabilities.

Pennsylvania State Parks, Telephone: (717) 787–6674.

Perry, J., Garrett, M., Gronley, J.K., Mulroy, S.J. (June 1995). *Classification of walking handicap in the stroke population*. *Stroke* 26, pp. 982–989.

This research identifies and evaluates the walking efficiency of individuals who have had a stroke.

American Heart Association, Western States Affiliate, 1710 Gilbreth Road, Burlingame, CA 94010-13317, Telephone: (650) 259–6700 or (800) AHA–USA1, Fax: (650) 259–6891.

Petzall, J. (1993). *Design for accessibility: The development of public transport vehicles with regard to mobility-impaired passengers*. Goteborg: Department of Transportation and Logistics, Chalmers University of Technology.

This is a description and analysis of the process of developing accessible public transportation. It also contains a case study showing how to define specifications for buses, based on results of anthropometric studies.

Department of Transportation and Logistics Chalmers University of Technology, S412 96 Goteborg, Sweden, ISBN 91-7032-847-1, ISSN 0283-3611, Bibliotekets Reproservice CTHB Goteborg.

PLAE, Inc. (1993). *A design guide: Universal access to outdoor recreation*. Berkeley.

This book provides a framework for determining the appropriate level of accessibility in a range of outdoor recreational settings and contains detailed guidelines for designing the elements and spaces necessary for ensuring accessible paths, signage, restrooms, and other outdoor facilities.

MIG Communications, 1802 Fifth Street, Berkeley, CA 94710, Telephone: (510) 845-0953, Fax: (510) 845-8750.

Prestipino, S., Keller, S. (Producers). (1996). *ADA training at the National Civil Rights Conference [Slide set]*. Helena: Montana Department of Transportation.

This is a four-box set of slides portraying problems detected by people with disabilities when encountering curb ramps and other such barriers in public rights-of-way. These slides are available for use in training or promotion of Section 14 standards.

Montana Department of Transportation, P.O. Box 201001, Helena, MT 59620-1001, Telephone: (406) 444-6200, Fax: (406) 444-7643.

Project for Public Spaces, Inc. (1993). *Case study no. 20: The effects of environmental design on the amount and type of bicycling and walking*. Washington: Federal Highway Administration. Report # FHWA-PD-93-037.

This study summarizes knowledge on the impact of environmental design on walking and bicycling. It also identifies successes and failures in the downtown design environment and the factors that promote effective bicycle and walking use.

Federal Highway Administration, U.S. Department of Transportation, 400 Seventh Street, S.W., Washington, DC 20590. Fax requests to FHWA R & T Report Center: (301) 577-1421.

Project for Public Spaces, Inc., Konhiem, Ketcham, and Whyte, W.H. (1986). *Improving how a street works for all users: A design and planning manual*. New York: Project for Public Spaces, Inc.

This book provides planning guidelines designed to improve the accessibility of streets for all users; diagrams are included.

Project for Public Spaces, 153 Waverly Place, New York, NY 10014, Telephone: (212) 206-0254.

Peck, A.F., Bentzen, B.L. (1987). *Tactile warnings to promote safety in the vicinity of transit platform edges*. Washington: U.S. Department of Transportation.

This study discusses the effectiveness of tactile warning materials to assist visually disabled travelers in hands-on station environments. It includes a laboratory evaluation of transit service and additional evaluation of two particular warning systems.

National Technical Information Service, Springfield, VA 22161, Telephone: (703) 605-6000.

Province of British Columbia, Ministry of Education. (1990). *The universal playground: A planning guide*. Victoria.

This planning guide was written to assist schools in planning playgrounds for children of all abilities, with limited resources, while achieving educational objectives.

Ministry of Education, Special Programs Branch, P.O. Box 9165,  
Stn Provgovt, Victoria BC Z8W9H4, Telephone: (250) 356-2333,  
Fax: (250) 356-7631, TTY: (250) 356-7632.

Province of British Columbia Ministry of Education, Ministry Responsible for Multiculturalism and Human Rights. (1992). *Access to conferences, institutes, and meetings: A planning guide*. Victoria: Student Support Services.

These design guidelines discuss what spaces and objects need to be made accessible and show how to identify facilities and programs that need to be modified.

Student Support Services, Parliament Buildings, Victoria,  
British Columbia V8V 1X4.

Province of Ontario, Ministry of Housing. (1989). *Main street: Planning and design guidelines*. Ottawa.

This guidebook looks at existing sidewalks and roads that require repair or readaptation. Suggestions for making safer walkways are included.

Housing Development and Buildings Branch, Ontario Ministry of Municipal Affairs and Housing, 777 Bay Street, Toronto, Ontario M6R1L1,  
Telephone: (416) 585-6515, Fax: (416) 585-7531.

Pugh, B. (1989a). *A bikeway design cookbook*. Roseville: BP Engineering.

This manual contains excerpts from the 2010 Sacramento City/County Bikeway Master Plan. It discusses design standards, figures, uniform traffic control devices, and includes a chapter on signage and roadway traffic diagram figures.

BP Engineering, P.O. Box 1385, Roseville, CA 95678-8385, Telephone:  
(916) 771-4563, Fax: (916) 771-4569, Email: BIKEFED@aol.com.

Pugh, B. (1989b). *A bikeway master plan cookbook*. Roseville: BP Engineering.

This manual contains excerpts from the 2010 Sacramento City/County Bikeway Master Plan. It includes chapters on formulating a bikeway master plan, describes general and specific planning criteria, and introduces the concept of a bicycle advisory committee.

BP Engineering, P.O. Box 1385, Roseville, CA 95678-8385, Telephone:  
(916) 771-4563, Fax: (916) 771-4569, Email: BIKEFED@aol.com.

Pugh, B. (1989c). *A bicycle parking cookbook*. Roseville: BP Engineering.

This manual contains excerpts from the 2010 Sacramento City/County Bikeway Master Plan. It contains chapters on bicycle parking and amenities, Classes I-III bicycle parking, Sacramento City and County bicycle parking-zoning ordinance, and the Sacramento County parking reduction ordinance.

BP Engineering, P.O. Box 1385, Roseville, CA 95678-8385, Telephone:  
(916) 771-4563, Fax: (916) 771-4569, Email: BIKEFED@aol.com.

Rails to Trails Conservancy, Association of Pedestrian and Bicycle Professionals. (1998). *Improving conditions for bicycling and walking: A best practice report*. Washington: Federal Highway Administration.

This is a compilation of walking and biking plans from many different cities and states. An abbreviated list of their restrictions and requirements is included.

Rails to Trails Conservancy, 1100 Seventeenth Street, Tenth Floor, Washington, DC 20036, Telephone: (202) 331-9696, Web site: [www.railtrails.org](http://www.railtrails.org).

Rabelle, A., Zabihaylo, C., Gresset, J. (1998). *Detectability of warning tiles by functionally blind persons: Effects of warning tiles' width and adjoining surfaces texture*. In E. Siffermann, M. Williams, B.B. Blasch (Eds.), *Proceedings of the Ninth International Mobility Conference* (pp. 38-41). Decatur, GA: Rehabilitation Research and Development Center.

This study determines the width needed for pedestrians to detect the presence of truncated domes and other detectable warning systems.

Rathke, D.M., Baughman, M.J. (1994). *Recreational trail design and construction*. St. Paul: Educational Development System, Minnesota Extension Service, University of Minnesota.

This publication was designed to be used by small organizations or private individuals to design and construct trails. It contains step-by-step construction methods.

University of Minnesota, Minnesota Extension Service, Distribution Center, 20 Coffey Hall, 1420 Eckles Avenue, St. Paul, MN 55108-6069, Fax: (612) 625-6281.

Recreation Access Advisory Committee. (1994). *Recommendation for accessibility guidelines: Recreational facilities and outdoor developed areas*. Washington: U.S. Architectural and Transportation Barriers Compliance Board.

This report contains the scoping technical requirements and rationale of the Recreation Access Advisory Committee for accessible outdoor recreational facility. It contains both final guidelines and proposed work perimeters.

U.S. Access Board, Recreation Report, 1331 F Street, N.W., Suite 1000, Washington, DC 20004-1111, Telephone: (202) 272-5434 or (800) 872-2253, TTY (202) 272-5449 or (800) 993-2822, Web site: <http://www.access-board.gov/rules/child.htm>.

Rehabilitation Engineering and Assertive Technology Society of North America. (1998). *American national standard for wheelchairs: Volume 1: Requirements and test methods for wheelchairs (including scooters)*. Arlington.

This document contains wheelchair testing specifications.

RESNA, 1700 North Moore Street, Suite 1540, Arlington, VA 22209, Telephone: (703) 524-6686, Fax: (703) 524-6630.

Ryan, K. (1993). *Trails for the twenty-first century*. Covelo: Island Press.

This book introduces the concept of the multi-use trail and promotes bicycle and pedestrian travel.

Island Press, 24850 East Lane, P.O. Box 7, Covello, CA 95428,  
Telephone: (707) 983-6432, Fax: (707) 983-6414, Web site:  
www.islandpress.org, Email: ipwest@igc.apc.org.

Sanford, J.A. (1985). *Designing for orientation and safety*. Proceedings of the International Conference on Building Use and Safety Technology. (pp. 54-59). Atlanta, GA: Georgia Institute of Technology.

This study determines whether different surfaces are detectable by people with visual impairments, and how the properties of different surfaces affect their detectability. It also presents results of tests of the ability of people with visual impairments to stop after detecting a warning.

Sanford, J.A., Steinfeld, E. (1985). *Designing for orientation and safety*. Proceedings of the International Conference on Building Use and Safety Technology (pp. 54-59). Washington: National Institute of Building Sciences.

This study discusses the properties of different detectable warnings and how well people with visual disabilities are able to detect them. It also discusses the navigational techniques of people with visual impairments and how they interacted with the detectable warning, and the usage and interpretation of architectural space by visually impaired people versus sighted people.

San Francisco Bureau of Engineering. (1996). *Warning strips for the visually disabled and blind pedestrian*. San Francisco Bureau of Engineering internal report, San Francisco.

This study was conducted by the San Francisco Department of Public Works to determine whether guide strips used in crosswalks are durable enough to withstand the impact of heavy traffic use. This study tested a variety of different types of guide strips.

Joe Ovadia, Project Manager, San Francisco Bureau of Engineering,  
Telephone: (415) 558-4004. Richard Skaff, Disability Access Coordinator,  
San Francisco Department of Public Works, 30 Van Ness Avenue, 5th Floor,  
San Francisco, CA 94102, Email: richardskaff@amer.net.

Sawai, H., Takato, J., Tauchi, M. (1998). *Quantitative measurements of tactile contrast between dot and bar tiles used to constitute tactile pathway for the blind and visually impaired independent travelers*. In E. Sifferman, M. Williams, B.B. Blasch (Eds.), *Proceedings of the Ninth International Mobility Conference* (pp. 178-181). Decatur, GA: Rehabilitation Research and Development Center.

This study discusses the ability of people with visual impairments to detect the difference between the two types of detectable warnings — a dot tile served to alert pedestrians, and a bar tile served to guide pedestrians along a given path.

Schmid, J. (1997). *American trails: 1997 trails resource bibliography*. Prescott: American Trails.

A bibliography of 941 publications and videos containing information about trails.

American Trails, P.O. Box 11046, Prescott, AZ 86304-1046, Telephone: (520) 632-1140, Fax: (520) 632-1147, Email: Amtrails@lankaster.com, Web site: <http://www.outdoorlink.com/amtrails/>.

Seeing Eye, The (Producer). (1996). *Partners in travel [Videotape]*. Morristown, NJ: Independence and Dignity.

This video provides an overview of dog guides and how they can aid people with visual impairments.

Independence and Dignity, P.O. Box 375, Morristown, NJ 07963-0375.

Seiderman, C.B., Russell, R.A. (1997). *How better bicycle facilities can enhance local economies*. In O. Hatch (Ed.), *Velo-City Falco Lecture Prize Winning Papers*. (pp. 3-12). Vriezenveen: Falco bv.

This study examines the connection between the condition of bicycle facilities and local economies by analyzing existing data.

Oliver Hatch, Velo-City Conference Director, Thirty-One Arodene Road, London SW2 2BQ, England, UK, Telephone: +44 (181) 674-5916, Fax: +44 (181) 671-3386, Email: [oh@velo-city.org](mailto:oh@velo-city.org).

Shephard, R.J. (1990). *Fitness in special populations*. Champaign: Human Kinetics.

This document examines fitness status, training programs, personality, behavior, and biomechanical factors that influence fitness assessment and development.

Human Kinetics Publishers, Inc., Fulfillment Department, P.O. Box 5076, Champaign, IL 61825-5076, Telephone: (800) 747-4457, Fax: (217) 351-1549, Web site: [www.humankinetics.com](http://www.humankinetics.com).

Sherrill, C. (Fourth edition). (1993). *Adapted physical activity, recreation, and sport: Cross-disciplinary and lifespan*. Madison: WCB Brown and Benchmark.

Discusses the impact of disability on physical activity participation. Addresses behavioral, emotional, cognitive, and learning disabilities, as well as effective methods for including individuals with these conditions.

McGraw-Hill Companies, P.O. Box 182604, Columbus, OH 43272-3031, Telephone: (800) 262-4729, Fax: (614) 759-3644, Email: [customer.service@mcgraw-hill.com](mailto:customer.service@mcgraw-hill.com), Web site: [mhhe.com](http://mhhe.com).

Siwek, S.J., Associates. (1996). *Statewide transportation planning under ISTEA: A new framework for decision making*. Washington: Federal Highway Administration. Report # FHWA-PD-96-026A.

This guidebook describes how the Intermodal Surface Transportation Equity Act affects State departments of transportation. Long- and short-range plans are discussed in detail.

Federal Highway Administration, U.S. Department of Transportation, 400 Seventh Street, S.W., Washington, DC 20590.

Staplin, L., Lococo, K., Byington, S. (1998). *Older driver highway design handbook*. McLean: Office of Safety and Traffic Operations R&D.

This project included literature reviews and meta-analytic techniques in the areas of age-related functional capabilities, human factors, and highway safety. A User-Requirements Analysis to gauge the needs of highway design is also used in this study.

National Technical Information Service, Technology Administration,  
U.S. Department of Commerce, Springfield, VA 22161, Telephone:  
(703) 605-6000, Fax: (703) 321-8547.

Steinfeld, E., Schroeder, S., Bishop, M. (1979). *Accessible buildings for people with walking and reaching limitations*. Washington: U.S. Department of Housing and Urban Development.

This document presents research regarding the special needs of people with walking and reaching limitations in relation to building design and spatial layout.

HUD User, P.O. Box 6091, Rockville, MD 20849, Telephone:  
(301) 251-5154 or (800) 245-2691.

Templer, J.A. (1980a). *An implementation manual: Provisions for the elderly and handicapped pedestrians*. Washington: Federal Highway Administration.

This book identifies, defines, and gives solutions for the shortcomings of the pedestrian environment.

U.S. Government Printing Office, Superintendent of Documents,  
P.O. Box 371954, Pittsburgh, PA 15250-7954, Telephone: (202) 512-1800,  
Fax: (202) 512-2233.

Templer, J.A. (1980b). *Provisions for elderly and handicapped pedestrians: Volume 3: The development and evaluation of countermeasures*. Springfield: U.S. Department of Commerce.

This report presents the findings of several countermeasures designed to improve access for older pedestrians and people with disabilities in sidewalk environments.

National Technical Information Service, Springfield, VA 22161, Telephone:  
(703) 605-6000, Fax: (703) 321-8547.

Templer, J.A. (1980c). *Provisions for elderly and handicapped pedestrians: Volume 2: Hazards, barriers, problems, and the law*. Washington: Federal Highway Administration.

This survey was conducted to determine problems experienced by the elderly and pedestrians with disabilities.

National Technical Information Service, Technology Administration, U.S.  
Department of Commerce, Springfield, VA 22161, Telephone: (703) 605-6000,  
Fax: (703) 321-8547.

Templer, J.A. (1980d). *The feasibility of accommodating physically handicapped individuals on pedestrian over- and undercrossing structures*. Washington: Federal Highway Administration.

The objective of this study was to determine the problems faced by people with disabilities when they encounter over- and undercrossing structures.

National Technical Information Service, Technology Administration, U.S. Department of Commerce, Springfield VA 22161, Telephone: (703) 605-6000, Fax: (703) 321-8547.

Templer, J.A., Wineman, J., Zimring, C.M. (1982). *Design guidelines to make crossing structures accessible to the physically handicapped*. Washington: Offices of Research and Development, Federal Highway Administration.

Based on various studies, this book contains recommendations for ramp gradients, detectable materials, and techniques for providing nonvisual information.

National Technical Information Service, Technology Administration, U.S. Department of Commerce, Springfield, VA 22161, Telephone: (703) 605-6000, Fax: (703) 321-8547.

Templer, J.A. (1994a). *The staircase: History and times*. Cambridge: The MIT Press.

This book discusses the history of stairs, design ideas that have been used, and their ergonomic ability.

The MIT Press, Massachusetts Institute of Technology, Cambridge, MA 02142, Telephone: (617) 625-8569.

Templer, J.A. (1994b). *The staircase: Studies of hazards, falls, and safer design*. Cambridge: The MIT Press.

This book discusses the need for safer stair designs and focuses on the relationship between the physiological and behavioral usage of stairs by people.

The MIT Press, Massachusetts Institute of Technology, Cambridge, MA 02142, Telephone: (617) 625-8569.

Texas Department of Licensing and Regulation. (1997). *Architectural Barriers Act*. Austin.

The accessibility design guidelines for the State of Texas; covers the construction and reconstruction of public buildings, public accommodations, and commercial facilities.

Department of Licensing and Regulation, P.O. Box 12157, Austin, TX 78711, Telephone: 1-800-252-8026.

The Resources Agency, Department of Parks and Recreation. (1998). *Trails handbook*. Sacramento: California State Parks.

This handbook, which has not been published, provides guidance on designing, constructing, and maintaining outdoor trails.

Don Beers, North Coast Redwoods Headquarters, 600-A West Clark, Eureka, CA 95501, Telephone: (707) 445-6547 ext. 18, Fax: (707) 441-5737.

Transportation Equity Act for the Twenty-First Century. (1998). *Public Law 178, 105th Congress*. (June 6, 1998).



This law authorizes transportation funds to be spent on improving intermodal surface transportation alternatives for moving goods and people.

U.S. Government Printing Office, Superintendent of Documents, P.O. Box 371954, Pittsburgh, PA 15250-7954, Telephone: (202) 512-1800, Fax: (202) 512-2233.

Tranter, R.T., Slater, R., Vaughan, N. (1991). *Barriers to Mobility: Physically disabled and frail elderly people in their local outdoor environment*. International Journal of Rehabilitation Research, 14, pp. 303-312.

This paper reports the results of a 2-year project that investigated problems with the mobility of physically handicapped people in their external physical environment.

Welsh School of Architecture, University of Wales, P.O. Box 25, Cardiff CF1 3XE, Wales.

United Kingdom Department of the Environment, Transport, and the Regions, The Scottish Office. (Notified Draft, 1997). *Guidance on the use of tactile paving surfaces*. London, England.

These design guidelines discuss mobility for people with visual impairments and provide specifications for tactile delineator strips on segregated, shared cycle track/footways.

Sue Sharp, Mobility Policy Branch, Great Minister House Room 1/11, 76 Marsham House, London SW1P 4DR, Telephone: 0171-271-5256, Divisional inquiries: 0171-271-5252, Fax: 0171-271-5253, Email: mu.dot@gtnet.gov.uk.

University of North Carolina Highway Safety Research Center. (1996). *Florida pedestrian planning and design guidelines*. Tallahassee: State of Florida Department of Transportation.

This manual provides guidelines, standards, and criteria for the planning, design, construction, operation, and maintenance of pedestrian facilities.

Theo Petritsch, State Pedestrian and Bicycle Coordinator, Florida Department of Transportation, 605 Suwannee Street MS-82, Tallahassee, FL 32399, Telephone: (850) 487-1200, Fax: (850) 922-2935, Email: theopetritsch@dot.State.fl.us.

U.S. Architectural and Transportation Barriers Compliance Board. (1985). *Detectable tactile surface treatments: Phase 1: Introduction and laboratory testing: Final report*. Washington: U.S. Architectural and Transportation Barriers Compliance Board.

This is a study of the detectability of different types of surface warning systems, and it investigates how the different properties of these surface systems affect perceptions of people with visual disabilities.

U.S. Access Board, Recreation Report, 1331 F Street, N.W., Suite 1000, Washington, DC 20004-1111, Telephone: (202) 272-5434 or (800) 872-2253, TTY (202) 272-5449 or (800) 993-2822, Web site: <http://www.access-board.gov/rules/child.htm>.

U.S. Architectural and Transportation Barriers Compliance Board. (1991). *36 CFR part 1191: Americans with Disabilities Act (ADA): Accessibility guidelines for buildings and facilities: State and local government facilities*. (July 26, 1991). Washington, DC.

This document contains accessibility guidelines that should be used by Federal agencies seeking to comply with the Americans with Disabilities Act.

U.S. Government Printing Office, Superintendent of Documents, P.O. Box 371954, Pittsburgh, PA 15250-7954, Telephone: (202) 512-1800, Fax: (202) 512-2233.

U.S. Architectural and Transportation Barriers Compliance Board. (1994a). *Bulletin #4: Surfaces*. Washington.

This bulletin clarifies the requirements for accessible surfaces. It defines what is considered firm, stable, and slip-resistant; provides methods to assess firmness and slip resistance; and discusses what materials are considered to comply with ADAAG.

U.S. Access Board, Recreation Report, 1331 F Street, N.W., Suite 1000, Washington, DC 20004-1111, Telephone: (202) 272-5434 or (800) 872-2253, TTY (202) 272-5449 or (800) 993-2822, Web site: <http://www.access-board.gov/rules/child.htm>

U.S. Architectural and Transportation Barriers Compliance Board. (1994b). *36 CFR Part 1191: Americans with Disabilities Act (ADA) Accessibility guidelines for buildings and facilities; State and local government facilities: Interim final rule*. Federal Register, vol. 59, no. 117. (June 24, 1994). Washington, DC.

This document is the set of interim final guidelines published by the U.S. Access Board. It provides additional guidance to the existing ADA Accessibility Guidelines (ADAAG). Section 14, which covers accessibility for public rights-of-way, is included in this interim final rule.

U.S. Government Printing Office, Superintendent of Documents, P.O. Box 371954, Pittsburgh, PA 15250-7954, Telephone: (202) 512-1800, Fax: (202) 512-2233.

U.S. Architectural and Transportation Barriers Compliance Board. (1996). *Bulletin 1: Detectable Warnings*. Washington.

This bulletin was written to alert the public to the requirements of installing detectable warnings.

U.S. Access Board, Recreation Report, 1331 F Street, N.W., Suite 1000, Washington, DC 20004-1111, Telephone: (202) 272-5434 or (800) 872-2253, TTY (202) 272-5449 or (800) 993-2822, Web site: <http://www.access-board.gov/rules/child.htm>.

U.S. Architectural and Transportation Barriers Compliance Board. (1997a). *ADAAG manual: A guide to the Americans with Disabilities Act accessibility guidelines*. Washington.

This interpretive manual of the ADA accessibility guidelines (ADAAG) is intended to provide clarification and technical assistance for developing buildings and facilities.

U.S. Access Board, Recreation Report, 1331 F Street, N.W., Suite 1000, Washington, DC 20004-1111, Telephone: (202) 272-5434 or (800) 872-2253, TTY (202) 272-5449 or (800) 993-2822, Web site: <http://www.access-board.gov/rules/child.htm>.

U.S. Architectural and Transportation Barriers Compliance Board (Producer). (1997c). *Accessible sidewalks: Design issues for pedestrians with disabilities [Videotape]*. Washington: U.S. Architectural and Transportation Barriers Compliance Board.

This video presents design recommendations for making sidewalks accessible to pedestrians who use wheelchairs.

U.S. Access Board, Recreation Report, 1331 F Street, N.W., Suite 1000, Washington, DC 20004-1111, Telephone: (202) 272-5434 or (800) 872-2253, TTY (202) 272-5449 or (800) 993-2822, Web site: <http://www.access-board.gov/rules/child.htm>.

U.S. Architectural and Transportation Barriers Compliance Board. (1998a). *36 CFR part 1191: Americans with Disabilities Act (ADA): Accessibility guidelines for buildings and facilities: Building elements designed for children's use; Final rule*. Federal Register vol. 63, no. 8. (January 13, 1998). Washington, DC.

The U.S. Access Board's final guidelines providing additional guidance in establishing alternate specifications for building elements designed for use by children.

U.S. Access Board, Recreation Report, 1331 F Street, N.W., Suite 1000, Washington, DC 20004-1111, Telephone: (202) 272-5434 or (800) 872-2253, TTY (202) 272-5449 or (800) 993-2822, Web site: <http://www.access-board.gov/rules/child.htm>.

U.S. Architectural and Transportation Barriers Compliance Board (1998b). *36 CFR part 1191: Americans with Disabilities Act (ADA): Accessibility guidelines for buildings and facilities: State and local government facilities: Final rule*. Federal Register, vol. 63, no. 8. (January 13, 1998). Washington, DC.

The U.S. Access Board is issuing final guidelines to provide additional guidance with the new construction and alternations of State and local government facilities. This is to help ensure that government facilities are readily accessible to and usable by individuals with disabilities.

U.S. Access Board, Recreation Report, 1331 F Street, N.W., Suite 1000, Washington, DC 20004-1111, Telephone: (202) 272-5434 or (800) 872-2253, TTY (202) 272-5449 or (800) 993-2822, Web site: <http://www.access-board.gov/rules/child.htm>.

U.S. Architectural and Transportation Barriers Compliance Board. (1998c). *Transit facility design for persons with visual impairments*. Gopher://trace.wisc.edu/oo/ftp/pub/text/ATBCB/BLINDTRN.TXT (June 23, 1998).

This informational sheet provides an overview of the recommendations for making transit facilities more accessible for people with visual impairments.

U.S. Architectural and Transportation Barriers Compliance Board, 1111 18th Street, N.W., Suite 501, Washington, DC 20036, Telephone or TDD: (202) 653-7848.

U.S. Department of Agriculture, Alaska Region Forest Service. (1991). *Alaska region trails construction and maintenance guide*. Anchorage.

This document contains trail design and maintenance guidelines for the Forest Service in the Alaskan region.

Alaska Federal Office Building, 709 West Ninth Street, P.O. Box 21628, Juneau, AK 99802-1628, DG: Mailroom: R10A.

U.S. Department of Agriculture, Forest Service. (1984). *Standard specifications for construction of trails*. Washington: U.S. Government Printing Office.

These U.S. Forest Service design guidelines provide specifications for trail construction.

USDA Forest Service, Engineering Staff, Attn: Publications Specialist, P.O. Box 2417, Washington, DC 20013, Telephone: (202) 205-0957.

U.S. Department of Agriculture, Forest Service. (1985). *Trails management handbook*. Washington.

This handbook consists of guidelines used by the U.S. Forest Service to manage trails. Includes sections on trail planning, development, reconstruction and construction, trail operation and maintenance, and construction and maintenance exhibits.

Forest Service USDA, Engineering Staff, Attn: Publications Specialist, P.O. Box 2417, Washington, DC 20013, Telephone: (202) 205-0957.

U.S. Department of Agriculture, Forest Service. (1994). *Special use permits: The ADA and section 504*. Washington.

This document outlines how the ADA and Section 504 of the Rehabilitation Act apply to special use permits for the USDA Forest Service and its contractors.

USDA Forest Service, Engineering Staff, Attn: Publications Specialist, P.O. Box 2417, Washington, DC 20013, Telephone: (202) 205-0957.

U.S. Department of Commerce, Bureau of the Census. (1994). *Americans with disabilities*. [http://www.census.gov/apsd/www/statbrief/sb94\\_1.pdf](http://www.census.gov/apsd/www/statbrief/sb94_1.pdf). (July 9, 1998).

This is a summary of the 1990 U.S. Census data on people with disabilities.

Customer Services: (301) 763-4100, Persons with Disabilities Contact: John McNeil, (301) 763-8300, Statistical Briefs Contact: Robert Bernstein, (301) 763-1584.

U.S. Department of Defense, General Services Administration, Department of Housing and Urban Development, U.S. Postal Service. (1984). *Uniform Federal accessibility standards*. Washington.

This document contains accessibility guidelines that should be used by Federal agencies to comply with the Rehabilitation Act of 1973.

U.S. Access Board, Recreation Report, 1331 F Street, N.W., Suite 1000, Washington, DC 20004-1111, Telephone: (202) 272-5434 or (800) 872-2253, TTY (202) 272-5449 or (800) 993-2822, Web site: <http://www.access-board.gov/rules/child.htm>.

U.S. Department of Justice. (1991). *36 CFR part 1191: Americans with Disabilities Act (ADA): Accessibility guidelines for buildings and facilities: State and local government facilities*. (July 26, 1991). Washington, DC.

This document contains implementation regulations for Title III of the Americans with Disabilities Act. The ADA Standards for Accessible Design are contained within these regulations.

U.S. Government Printing Office, Superintendent of Documents,  
P.O. Box 371954, Pittsburgh, PA 15250-7954, Telephone: (202) 512-1800,  
Fax: (202) 512-2233.

U.S. Department of Justice. (1993a). *The Americans with Disabilities Act, Title III: Readily achievable: Background paper on accessibility of existing ski facilities*. Washington: Department of Justice.

This document outlines how the “readily achievable” standard set forth in Title III of the ADA applies to accessibility at existing ski facilities.

U.S. Department of Justice, Telephone: (202) 514-0301 or  
(800) 514-0301, TTY: (800) 514-0383.

U.S. Department of Justice. (1993b). *The Americans with Disabilities Act, Title II: Technical assistance manual: Covering State and local government programs and services: 1993*. Washington.

This manual presents the ADA’s requirements for State and local governments in a focused, systematic description. Questions, answers, and illustrations are used throughout to convey points.

U.S. Department of Justice, Telephone: (202) 514-0301 or  
(800) 514-0301, TTY: (800) 514-0383.

U.S. Department of Justice. (1993c). *The Americans with Disabilities Act, Title III: Technical assistance manual: Covering public accommodations and commercial facilities*. Washington: Author.

This manual presents the ADA’s requirements for public accommodations, commercial facilities, and private entities offering certain examinations and courses in a focused, systematic description. Questions, answers, and illustrations are used throughout to convey points.

U.S. Department of Justice, Telephone: (202) 514-0301 or  
(800) 514-0301, TTY: (800) 514-0383.

U.S. Department of Justice. (1994a). *The Americans with Disabilities Act, Title II: Technical assistance manual: 1994 supplement*. Washington.

This document contains material to be added to the Americans with Disabilities Act, Title II: Technical Assistance Manual. These supplements are to be inserted, as appropriate, at the end of each chapter of the manual.

U.S. Department of Justice, Telephone: (202) 514-0301 or  
(800) 514-0301, TTY: (800) 514-0383.

U.S. Department of Justice. (1994b). *28 CFR parts 35, 36, 37: Nondiscrimination on the basis of disability in State and local government services: Public accommodations and commercial facilities: Accessibility standards*. Federal Register, vol. 59, no. 117. (June 20, 1994). Washington, DC.

This document contains implementation regulations for Title II, Subpart A and Title III of the Americans with Disabilities Act.

U.S. Government Printing Office, Superintendent of Documents,  
P.O. Box 371954, Pittsburgh, PA 15250-7954, Telephone: (202) 512-1800,  
Fax: (202) 512-2233.

U.S. Department of Justice. (1996a). *A guide to disability rights laws*. Washington.

This bulletin lists settlements, agreements, and cases of ADA litigation; provides resources for entities seeking ADA technical assistance; lists other sources for ADA information; and provides an address to file complaints.

U.S. Department of Justice, Telephone: (202) 514-0301 or (800) 514-0301,  
TTY: (800) 514-0383.

U.S. Department of Justice. (1996b). *Enforcing the ADA: A status report from the Department of Justice: Issue three*. Washington.

This booklet provides a short overview of Federal civil rights laws that ensure equal opportunity for people with disabilities and lists contact agencies and organizations.

U.S. Department of Justice, Telephone: (202) 514-0301 or (800) 514-0301,  
TTY: (800) 514-0383.

U.S. Department of Justice. (1998a). *Proposed Rule, 28 CFR Part 35 — Requirement for Curb Ramps*. [www.usdoj.gov/crt/ada/newregs/curbrule.txt](http://www.usdoj.gov/crt/ada/newregs/curbrule.txt) (March 27, 1998).

This Web site posts the proposed rule to extend curb ramp requirements and provides background information regarding this issue.

U.S. Department of Justice. (1998b). *Final Rule for Extension of Detectable Warning Temporary Suspension until July 26, 1998*. <http://www.usdoj.gov/crt/ada/detwarns.htm> (March 27, 1998).

This Web site posts the final rule to extend the detectable warning suspension and provides background information regarding this issue.

U.S. Department of Justice, Architectural and Transportation Barriers Compliance Board, U.S. Department of Transportation. (1994). *28 CFR part 36, 36 CFR part 1191, 49 CFR part 37: Americans with Disabilities Act accessibility guidelines: Detectable warnings: Joint final rule*. Federal Register, vol. 59, no. 70. (April 12, 1994). Washington, DC.

This document sets forth the Department of Justice implementing regulations for ADAAG regarding detectable warnings.

U.S. Government Printing Office, Superintendent of Documents,  
P.O. Box 371954, Pittsburgh, PA 15250-7954, Telephone:  
(202) 512-1800, Fax: (202) 512-2233.

U.S. Department of Justice, Equal Employment Opportunity Commission. (1994). *28 CFR part 37, 29 CFR part 1640: Procedures for coordinating the investigation of complaints or charges of employment discrimination based on disability subject to the Americans with Disabilities Act and section 504 of the Rehabilitation Act of 1973: Final rule*. Federal Register, vol. 59, no. 149. (August 4, 1994). Washington, DC.

These regulations coordinate the processing of complaints that fall within the overlapping jurisdiction of the ADA and Section 504 and ensure that they are dealt with in a manner that avoids duplication of effort and prevents inconsistent or conflicting standards.

U.S. Government Printing Office, Superintendent of Documents,  
P.O. Box 371954, Pittsburgh, PA 15250-7954, Telephone: (202) 512-1800,  
Fax: (202) 512-2233.

U.S. Department of Transportation. (1988). *Manual on uniform traffic control devices*. Washington: Federal Highway Administration.

This text, including traffic lights and signage, lists National standards for traffic control devices, their colors, markings, dimensions, and placement. These guidelines must be followed by all public authorities having jurisdiction over traffic control. Numerous diagrams and signage examples are included.

U.S. Government Printing Office, Superintendent of Documents,  
P.O. Box 371954, Pittsburgh, PA 15250-7954, Telephone: (202) 512-1800,  
Fax: (202) 512-2233.

U.S. Department of Transportation. (1991). *49 CFR parts 27, 37, 38: Transportation for individuals with disabilities: Final rule*. Federal Register, vol. 56, no. 173. (September 6, 1991). Washington, DC.

This is the final rule implementing the transportation provisions of the ADA. The rule contains provisions on the acquisition of accessible vehicles by private and public entities and contains the amendment to the implementation of Section 504 of the Rehabilitation Act of 1973.

U.S. Government Printing Office, Superintendent of Documents,  
P.O. Box 371954, Pittsburgh, PA 15250-7954, Telephone: (202) 512-1800,  
Fax: (202) 512-2233.

U.S. Department of Transportation. (1994a). *49 CFR parts 27, 37: Transportation for individuals with disabilities: Proposed rule*. Federal Register, vol. 59, no. 117. (June 20, 1994). Washington, DC.

Regulations regarding transportation and transportation facilities imposed by the ADA Accessibility Guidelines for Buildings and Facilities.

U.S. Government Printing Office, Superintendent of Documents,  
P.O. Box 371954, Pittsburgh, PA 15250-7954, Telephone: (202) 512-1800,  
Fax: (202) 512-2233.

U.S. Department of Transportation. (1994b). *Glossary of transportation terms*. Washington: Federal Highway Administration.

This English/Spanish version is a translation of the Urban Public Transportation Glossary that was published by the Transportation Research Board (TRB).

Federal Highway Administration, U.S. Department of Transportation,  
400 Seventh Street, S.W., Washington, DC 20590.

U.S. Department of Transportation. (1994c). *Innovations in public involvement for transportation planning*. Washington: Federal Highway Administration.

This report provides synopses of different methods for involving the public in transportation planning. A description of each technique, the intended audience, the method of participation, how the output might be used, the costs, advantages, drawbacks, references, contacts to obtain more information, and issues of special concern are discussed for each technique.

Federal Highway Administration, U.S. Department of Transportation,  
400 Seventh Street, S.W., Washington, DC 20590.

U.S. Department of Transportation. (1995a). *49 CFR part 27: Nondiscrimination on the basis of handicap in programs and activities receiving or benefiting from Federal financial assistance*. Federal Register. (October 1, 1995). Washington, DC.

This is an excerpt of the Federal law prohibiting discrimination against people with disabilities involved in Federal assistance programs.

U.S. Government Printing Office, Superintendent of Documents,  
P.O. Box 371954, Pittsburgh, PA 15250-7954, Telephone: (202) 512-1800,  
Fax: (202) 512-2233.

U.S. Department of Transportation. (1995b). *49 CFR part 28: Enforcement of nondiscrimination on the basis of handicap in programs or activities conducted by the Department of Transportation*. Federal Register. (October 1, 1995). Washington, DC.

This is an excerpt of Federal law regarding the enforcement of nondiscrimination against people with disabilities in programs or activities conducted by the U.S. Department of Transportation.

U.S. Government Printing Office, Superintendent of Documents,  
P.O. Box 371954, Pittsburgh, PA 15250-7954, Telephone: (202) 512-1800,  
Fax: (202) 512-2233.

U.S. Department of Transportation. (1995c). *Working together on transportation planning: An approach to collaborative decision making*. Washington: Federal Highway Administration.

This report provides guidelines for planning transportation projects within a coalition of government agencies, community groups, special-interest groups, elected officials, minorities, and private-sector interests.

Federal Highway Administration, U.S. Department of Transportation,  
400 Seventh Street, S.W., Washington, DC 20590.

U.S. Department of Transportation. (1996a). *Public involvement techniques for transportation decision making*. Washington: Federal Highway Administration.

This reference lists techniques to involve the public in transportation planning, enumerating the pros and cons. One chapter is devoted to the Americans with Disabilities Act.

Federal Highway Administration, U.S. Department of Transportation,  
400 Seventh Street, S.W., Washington, DC 20590.

U.S. Department of Transportation. (Draft, 1996b). *Title II of the Americans with Disabilities Act (ADA): A draft primer for bicycle and pedestrian professionals adapted from the U.S. Department of Justice, Title II: Technical assistance manual*. Washington.



This document provides an explanation of the portions of Title II of the ADA that pertain to bicycle and pedestrian coordinators and planners.

Federal Highway Administration, U.S. Department of Transportation,  
400 Seventh Street, S.W., Washington, DC 20590.

U.S. District Court, Eastern District of Pennsylvania. (1993). *Civil Action 92-9101 Elizabeth Kinney vs. Howard Yerusolim.*

This is a Federal district appeals court case that determined that resurfacing affects the usability of the street. The court further ruled that because a street and its curbs are interdependent facilities, alteration of a street triggers the installation of a curb ramp.

Vic Roads Principal Traffic Engineer's Department Quality and Technical Resources Division. (1995). *Vic Roads: Providing for people with disabilities: Traffic engineering guidelines.* Kew: Vic Roads.

These guidelines can be used to improve existing road accessibility conditions.

Vic Roads Bookshop, Sixty Denmark Street, KEW Vic 3101,  
Telephone: (03) 854-2782, Fax: (03) 853-0084.

Viola, R. (1997). *Arlington County pedestrian transportation plan.* Arlington: Arlington County Department of Public Works.

This document revises the Arlington County Virginia Pedestrian Transportation Plan. It contains census materials and street diagrams.

Ritch Viola, 2100 Clarendon Boulevard, Suite 717, Arlington, VA 22201,  
Telephone: (703) 228-3699, Fax: (703) 228-3594, Email:  
rviola@co.arlington.va.us.

Virginia Department of Transportation. (1996). *Subdivision street requirements.* Richmond: Commonwealth of Virginia.

This reference establishes the minimum State requirements accepted by the Department of Transportation for all genres of subdivision development.

Virginia Department of Transportation, Secondary Roads Division,  
1401 East Broad Street, Richmond, VA 23219, Telephone: (804) 786-2576,  
Fax: (804) 7786-2603.

Volunteers for Outdoor Colorado. (Fourth edition). (1992). *Crew leader manual.* Denver.

This is a training manual for the Volunteers for Outdoor Colorado. It provides design guidelines and maintenance techniques for recreational trails.

Volunteers for Outdoor Colorado, 1410 Grant Street B105, Denver, CO 80203,  
Telephone: (303) 830-7792.

Walkable Communities, Inc. (1996). *Creating a more walkable Las Vegas.* High Springs.

This report documents a planning charrette that focuses on the pedestrian environment in Las Vegas, Nevada.

Walkable Communities, Inc., 320 South Main Street, High Springs, FL 32643,  
Telephone: (904) 454-3304, Fax: (904) 454-3306, Email: DBurden@aol.com.

Ward, K.H., Meyers, M.C. (April 1995). *Exercise performance of lower-extremity amputees*. *Sports Medicine*, 20, pp. 207-214.

This is a review of published literature relating to walking speed and energy cost during ambulation for individuals with lower-extremity amputation and able-bodied individuals.

Adis International Inc., 860 Town Center Drive, Langhorne, PA 19047,  
Telephone: (215) 741-5200, Fax: (215) 741-5251, Web site: [www.adis.com](http://www.adis.com).

Washington State Department of Transportation. (1989). *Design manual: M22-01*. Olympia.

This manual provides planning and design guidelines for bicycle facilities.

Washington Department of Transportation, Bike and Pedestrian Program,  
P.O. Box 47393, Olympia, WA 98504, Telephone: (360) 705-7505.

Washington State Department of Transportation, Puget Sound Regional Council, OTAK. (1997). *Pedestrian facilities guidebook: Incorporating pedestrians into Washington's transportation system*. Olympia: Washington State Department of Transportation.

This guidebook provides planning and design guidelines for pedestrian facilities used by the Washington State Department of Transportation.

Washington Department of Transportation, Bike and Pedestrian Program,  
P.O. Box 47393, Olympia, WA 98504, Telephone: (360) 705-7505.

Wernex, J. (1994). *Off-highway motorcycle and ATV trails: Guidelines for design, construction, maintenance, and user satisfaction: Second edition*. Westerville: American Motorcyclist Association.

This document outlines design guidelines for off-highway vehicle trails.

American Motorcyclist Association, P.O. Box 6114, Westerville,  
OH 43081-6114.

Whitstock, R.H., Franck, L., Haneline, R. (1997). *Dog Guides*. In B. Blasch, W. Wiener, R. Welsh (Eds.), *Foundations of orientation and mobility: Second edition* (pp. 260-283). New York, NY: AFB Press, American Foundation for the Blind.

This chapter from *Foundations of Orientation and Mobility* contains information pertaining to dog guides. It includes information on training and responsibilities, and a section on the growth of the dog-guide movement.

AFB Press, American Foundation for the Blind, 11 Penn Plaza, New York,  
NY 10001. Web site: [http://www.afb.org/r\\_dwrep.html](http://www.afb.org/r_dwrep.html).

Wilderness Inquiry, Inc. (1992). *Wilderness accessibility for people with disabilities*. Washington: National Council on Disability.

This report contains the findings of a study that examined the policies used by land management agencies to improve accessibility for people with disabilities. The National Council on Disability's recommendations for improving access to wilderness areas are also included in this report.

National Council on Disability, 800 Independence Avenue, S.W., Suite 814, Washington, DC 20591.

Wilderness Inquiry, Inc. (1995). *Wilderness access decision tool*. Washington: USDA Forest Service.

This document was designed to help all managers of Federal wilderness areas improve access to their trails.

Arthur Carhart National Wilderness Training Center, 20325 Remount Road, Huson, MT 59846, Telephone: (406) 626-5208, Fax: (406) 626-5395.

Wilkinson, W.C., III. (1993). *Case study no. 10: Trading off among the needs of motor vehicle users, pedestrians, and bicyclists*. Washington: Federal Highway Administration. Report # FHWA-PD-94-012.

This document is tenth in a series of case study reports published by the Federal Highway Administration reviewing the needs and conflicts of various roadway and sidewalk users.

Federal Highway Administration, U.S. Department of Transportation, 400 Seventh Street, S.W., Washington, DC 20590. Fax requests to FHWA R & T Report Center: (301) 577-1421.

Wisconsin Department of Natural Resources. (1994). *Department design standards handbook*. Madison.

This document outlines design standards for new outdoor recreation facilities.

Wisconsin Department of Natural Resources, Telephone: (608) 266-7356.

Woo, J., Ho, S.C., Lau, J., Chan, S.G., & Yuen, Y.K. (1995). *Age-associated gait changes in the elderly: Pathological or physiological?* *Neuroepidemiology*, 14, pp. 65-71.

In this study, the walking speed and stride length of men and women 70 years of age were evaluated to determine changes in gait associated with aging.

Publisher S. Karger AG, P.O. Box CH-4009, Basel, Switzerland, Web site: [www.karger.com](http://www.karger.com).

World Health Organization. (1980). *International classification of impairment, disability, and handicap*.

This document provides internationally accepted standard definitions to identify and distinguish among impairment, disability, and handicap.

The World Health Organization Headquarters, Avenue Appia 20, 1211 Geneva 27, Switzerland, Telephone: (+41 22) 791-21-11, Fax: (+41 22) 791-0746, Telex: 415-416, Telegraph: UNISANTE GENEVA, Email: [publications@who.ch](mailto:publications@who.ch).

Zimmerman, B. (Producer). (1994). *Home access solutions: Ramps and stairs [videotape]*. St. Paul: Metropolitan Center for Independent Living.

This video explains how to design ramps that meet the needs of people with disabilities.

St. Paul Metropolitan Center for Independent Living, 1600 University Ave., W., Suite 16, St. Paul, MN 55104-3825, Telephone: (612) 646-8342, TTY: (612) 603-2001, Fax: (612) 603-2006, Web site: [www.macil.org](http://www.macil.org).

# Designing Sidewalks and Trails for Access

## *Part II of II:* *Best Practices Design Guide*

---

***Program Manager:***

Barbara McMillen

***Authors:***

*Beneficial Designs, Inc.*

Julie B. Kirschbaum, B.A.

Peter W. Axelson, M.S.M.E., A.T.P.

Patricia E. Longmuir, M.S.C.

Kathleen M. Mispagel, M.S., C.T.R.S.

Julie A. Stein, B.A.

Denise A. Yamada, M.E., B.M.E.

***Illustrations:***

Clay Butler

September 2001

---



# Acknowledgements

There are numerous people who made significant contributions to the development of this guidebook as either reviewers or professional experts. We would like to take this opportunity to thank the following people:

Janet Barlow  
Center for the Visually Impaired

B.L. Bentzen  
Accessible Design for the Blind

Jim Coppock  
City of Cincinnati, Ohio  
Department of Public Works

Raymond Davis  
New York State Department of  
Environmental Conservation

Michelle DeRobertis  
Wilbur Smith Associates

Lukas Franck  
The Seeing Eye, Inc.

Michelle Holsopple  
Allegheny Intermediate Unit #3

Dolores Gonzales  
City of Austin, Texas

David Guth  
Department of Blind Rehabilitation  
Western Michigan University

Peter Lagerwey  
Pedestrian and Bicycle Program  
Seattle Engineering Department

John LaPlante  
T.Y. Lyn International, DASCOR, Inc.

Richard Long  
Department of Blind Rehabilitation,  
Western Michigan University

## ACKNOWLEDGEMENTS

Stuart MacDonald  
Colorado State Parks

William Prosser  
Federal Highway Administration

Michael Ronkin  
Bicycle and Pedestrian Program  
Oregon Department of Transportation

Arthur Ross  
Traffic Engineering Division  
Madison Department of Transportation

Dona Sauerburger

Richard Skaff  
San Francisco Department of Public Works

Lois Thibault  
U.S. Architectural & Transportation Barriers  
Compliance Board

Jennifer Toole  
Sprinkle Consulting, Inc.

Patti Voorhees

Ellen Vanderslice  
America Walks

Charles Zeeger  
Highway Safety Research Center at  
University at North Carolina at Chapel Hill



# Table of Contents

## UNDERSTANDING THE USER

### Chapter 1: Introduction

1.1	Guidebook overview .....	1-1
1.2	Metric verses English units .....	1-3
1.3	Benefits of sidewalks and trails .....	1-3
1.4	Legislation and standards .....	1-6
1.4.1	Accessibility standards for new construction and alterations .....	1-7
1.4.2	Developing accessibility standards for sidewalks .....	1-8
1.4.3	Developing accessibility standards for trails .....	1-9

### Chapter 2: Understanding Sidewalk and Trail Users

2.1	Function, activity and participation .....	2-1
2.1.1	Function .....	2-3
2.1.2	Activity .....	2-3
2.1.3	Participation .....	2-4
2.1.4	Contextual factors .....	2-5
2.2	Different abilities for sidewalks and trails .....	2-5

2.3	Designing for all abilities .....	2-7
2.3.1	The need for a new approach .....	2-8
2.3.2	Accessible environments through universal design .....	2-11
2.3.3	Natural and constructed environmental constraints .....	2-12
2.4	Barriers create activity and participation limitations .....	2-13
2.4.1	Movement barriers .....	2-13
2.4.2	Information barriers .....	2-15
2.5	Conflicting pedestrian needs .....	2-20
2.6	Function, activity, participation and technology .....	2-22
2.6.1	Personal technologies .....	2-23
2.6.2	Activity-specific technologies .....	2-24
2.6.3	Environmental technologies and design .....	2-26
2.6.4	How does technology influence design? .....	2-27
2.6.5	Limitations of technology .....	2-29

**SIDEWALK DEVELOPMENT**

**Chapter 3: Integrating Pedestrians into the Project Planning Process**

3.1 Recent legislation ..... 3-2

3.1.1 Americans with Disabilities Act (ADA) ..... 3-3

3.1.2 Federal transportation legislation (ISTEA and TEA-21) ..... 3-3

3.2 Prioritizing pedestrian access ..... 3-4

3.2.1 Sidewalk installation ..... 3-4

3.2.2 Pedestrian oriented detail ..... 3-6

3.2.3 National policy ..... 3-7

3.2.4 State and local sidewalk policies ..... 3-7

3.3 Local land use and zoning ..... 3-8

3.3.1 Traditional land use patterns ..... 3-9

3.3.2 Land use recommendations ..... 3-9

3.4 Comprehensive planning ..... 3-10

3.4.1 Pedestrian master plans ..... 3-11

3.4.2 Pedestrian design guides ..... 3-12

3.5 Prioritizing resources ..... 3-12

3.6 Funding strategies ..... 3-14

3.7 Site development ..... 3-16

3.7.1 Pedestrian level of service ..... 3-16

3.7.2 Access management ..... 3-17

3.7.3 Design constraints ..... 3-18

3.8 Public involvement ..... 3-19

3.8.1 Making accessibility provisions at public meetings ..... 3-20

3.8.2 Outreach strategies for initiating community involvement ..... 3-21

3.8.3 Public involvement strategies ... 3-22

3.8.4 Community involvement in sidewalk assessments ..... 3-25

**Chapter 4: Sidewalk Corridors**

4.1 Sidewalk corridor width ..... 4-2

4.1.2 The zone system ..... 4-3

4.1.2.1 Curb zone ..... 4-4

4.1.2.2 Planter/furniture zone ... 4-4

4.1.2.3 Pedestrian zone ..... 4-6

4.1.2.4 Frontage zone ..... 4-8

4.1.3 Protruding objects ..... 4-9

4.1.4 Improving access on narrow sidewalks ..... 4-11

4.2 Sidewalk grades and cross slopes ..... 4-16

4.2.1 Grade ..... 4-16

4.2.2 Cross slope ..... 4-20

4.2.2.1 Grade and cross slope construction tolerances ..... 4-21

4.2.2.2 Elevation difference between street and building ..... 4-22

4.3 Sidewalk surfaces .....	4-24	6.2 Pedestrian signs .....	6-3
4.3.1 Surface material .....	4-24	6.3 Detectable warnings .....	6-5
4.3.1.1 Firm and stable .....	4-24	6.3.1 Design specifications for	
4.3.1.2 Slip resistant .....	4-25	detectable warnings .....	6-6
4.3.1.3 Wet or icy surfaces .....	4-26	6.3.2 Installation recommendations	
4.3.1.4 Decorative surface		for detectable warnings .....	6-7
materials .....	4-26	6.3.3 Recommended locations .....	6-8
4.3.2 Changes in level .....	4-28	6.3.4 Grooves .....	6-10
4.3.3 Gaps, grates, and openings .....	4-30	6.4 Directional surfaces .....	6-10
4.4 The impact of trees on the		6.4.1 Raised directional	
sidewalk corridor .....	4-30	tiles and pavers .....	6-11
4.5 Well-lit sidewalks .....	4-33	6.4.2 Intersection guidestrips .....	6-11
4.6 Grade-separated crossings .....	4-33	6.5 Accessible pedestrian signals .....	6-12
4.7 Sidewalks in confined spaces .....	4-36	6.5.1 Installation	
		recommendations .....	6-13
		6.5.2 Fixed time signals (pedestrian	
		signal indicators with	
		automated signal phasing) .....	6-14
		6.5.3 Pedestrian actuated	
		signal devices .....	6-16
		6.5.3.1 Providing information	
		in multiple formats .....	6-17
		6.5.3.2 Physical design	
		characteristics .....	6-18
		6.5.4 Infrared or LED transmitters .....	6-20

**Chapter 6: Providing Information to Pedestrians**

6.1 Non-visual information .....	6-2
----------------------------------	-----

**Chapter 7: Curb Ramps**

7.1 The impact of curb ramps .....	7-1
------------------------------------	-----



# TABLE OF CONTENTS

7.1.1	Impact of curb ramps on people with mobility impairments.....	7-2	7.3.7.1	Impacts of change of grade on people who use wheelchairs .....	7-29
7.1.2	Impact of curb ramps on people with vision impairments .....	7-2	7.3.7.2	Recommendations for maximum change in grade.....	7-30
7.1.3	Ideal design characteristics .....	7-3	7.3.7.3	Street resurfacing.....	7-31
7.2	Curb ramp types.....	7-3	7.3.8	Transition height .....	7-32
7.2.1	Perpendicular curb ramps.....	7-5	7.3.9	Sidewalk approach width .....	7-33
7.2.2	Diagonal curb ramps .....	7-8	7.3.10	Landing dimension and slope ...	7-33
7.2.3	Parallel curb ramps.....	7-11	7.3.11	Returned curbs and flares .....	7-34
7.2.4	Combined parallel and perpendicular curb ramp .....	7-13	7.4	Design considerations for curb ramp installation .....	7-35
7.2.5	Built-up curb ramps .....	7-14	7.4.1	Curb ramp placement at an intersection .....	7-36
7.2.6	Depressed corners .....	7-16	7.4.2	Influence of turning radii on curb ramp design .....	7-38
7.2.7	Recommendations for selecting a curb ramp design.....	7-18	7.4.3	Determining sidewalk width at pedestrian crossings .....	7-40
7.3	Curb ramp specifications .....	7-18	7.4.3.1	Type of crossing .....	7-40
7.3.1	Ramp grade.....	7-23	7.4.3.2	Curb ramp design .....	7-40
7.3.2	Ramp cross slope .....	7-25	7.4.3.3	Steep terrain .....	7-41
7.3.3	Ramp length .....	7-25	7.4.3.4	Volume of pedestrian traffic.....	7-41
7.3.4	Ramp width .....	7-27	7.4.4	Curb ramps at high curbs .....	7-42
7.3.5	Gutter slope .....	7-27	7.4.5	Curb ramps on narrow sidewalks .....	7-43
7.3.5.1	Gutter slope at diagonal curb ramps ....	7-27			
7.3.6	Transition detection .....	7-28			
7.3.7	Change of grade .....	7-28			

7.4.6 Curb ramps on steep terrain ..... 7-45  
 7.5 Curb ramp drainage ..... 7-46

**Chapter 8: Pedestrian Crossings**

8.1 Barriers to pedestrian access..... 8-2  
 8.1.1 Movement barriers ..... 8-2  
 8.1.2 Information barriers ..... 8-3  
 8.1.3 Design solutions ..... 8-4  
 8.2 Midblock crossings ..... 8-6  
 8.3 Turning radius ..... 8-7  
 8.4 Right turn on red and turning vehicles ..... 8-9  
 8.5 Crosswalks ..... 8-10  
 8.5.1 Crosswalk markings ..... 8-10  
 8.5.2 Crosswalk research ..... 8-11  
 8.5.3 Recommendations for enhancing pedestrian safety and access ..... 8-13  
 8.5.3.1 Flashing signals ..... 8-15  
 8.5.3.2 Reducing motorist speeds ..... 8-15  
 8.6 Crossing times ..... 8-16  
 8.7 Medians ..... 8-18  
 8.8 Corner islands ..... 8-19  
 8.9 Improving sight lines at intersections ..... 8-21

8.10 Skewed intersections ..... 8-23  
 8.11 Railroad crossings ..... 8-25

**Chapter 9: Traffic Calming**

9.1 Volume control measures ..... 9-3  
 9.1.1 Full closures ..... 9-3  
 9.1.1.1 Impact on pedestrian access ..... 9-4  
 9.1.1.2 Recommendations ..... 9-4  
 9.1.2 Half closures ..... 9-4  
 9.1.2.1 Impact on pedestrian access ..... 9-4  
 9.1.2.2 Recommendations ..... 9-5  
 9.1.3 Median barriers ..... 9-5  
 9.1.3.1 Impact on pedestrian access ..... 9-5  
 9.1.3.2 Recommendations ..... 9-5  
 9.1.4 Forced turn islands ..... 9-6  
 9.1.4.1 Impact on pedestrian access ..... 9-6  
 9.1.4.2 Recommendations ..... 9-7  
 9.2 Speed control measures ..... 9-7  
 9.2.1 Speed humps ..... 9-8  
 9.2.1.1 Impact on pedestrian access ..... 9-9  
 9.2.1.2 Recommendations ..... 9-9

9.2.2	Speed tables and raised crosswalks .....	9-9
9.2.2.1	Impact on pedestrian access .....	9-10
9.2.2.2	Recommendations .....	9-11
9.2.3	Raised intersections .....	9-11
9.2.3.1	Impact on pedestrian access .....	9-11
9.2.3.2	Recommendations .....	9-12
9.2.4	Textured pavement .....	9-12
9.2.4.1	Impact on pedestrian access .....	9-13
9.2.4.2	Recommendations .....	9-13
9.2.5	Roundabouts .....	9-13
9.2.5.1	Impact on pedestrian access .....	9-14
9.2.5.2	Recommendations .....	9-15
9.2.6	Neighborhood traffic circles .....	9-16
9.2.6.1	Impact on pedestrian access .....	9-17
9.2.6.2	Recommendations .....	9-17
9.2.7	Chicanes, lateral shifts, and chokers .....	9-17
9.2.7.1	Impact on pedestrian access .....	9-18
9.2.7.2	Recommendations .....	9-18
9.2.8	Curb extensions at intersections .....	9-18
9.2.8.1	Impact on pedestrian access .....	9-18
9.2.8.2	Recommendations .....	9-19
9.2.9	Center island narrowings .....	9-19
9.2.9.1	Impact on pedestrian access .....	9-19
9.2.9.2	Recommendations .....	9-20
<b>Chapter 10: Sidewalk Maintenance and Construction Site Safety</b>		
10.1	Facility maintenance .....	10-1
10.1.1	Assessment techniques .....	10-2
10.1.2	Sidewalk maintenance problems .....	10-3
10.1.3	Maintenance responsibilities .....	10-4
10.2	Information maintenance .....	10-4
10.3	Citizen reporting .....	10-5
10.4	Construction safety .....	10-7
<b>Chapter 11: Sidewalk Assessment</b>		
11.1	Benefits of assessment .....	11-1
11.2	Sidewalk Assessment Process overview .....	11-2
11.3	Sidewalk access characteristics .....	11-3
11.4	Data collection .....	11-4



11.4.1 Stroll Sheet station measurements .....	11-5	12.5 Providing access and preserving the environment .....	12-10
11.4.2 Stroll Sheet feature measurements .....	11-6	12.5.1 Potential conflicts between access and preservation .....	12-11
11.4.3 Stroll Sheet curb ramp measurements .....	11-8	12.5.1.1 Cultural, historic, religious, or significant natural features .....	12-12
11.4.4 Intersection Checklist .....	11-9	12.5.1.2 Nature of the setting or purpose of the trail .....	12-13
11.4.5 Sidewalk Element Analysis Forms .....	11-11	12.5.1.3 Federal, State, or local regulations or statutes .....	12-14
11.5 Presentation of sidewalk assessment information .....	11-13	12.5.1.4 Terrain, conditions, or prevailing construction practices .....	12-16

**TRAIL DEVELOPMENT**

**Chapter 12: Trail Planning**

12.1 Commitment to universal design .....	12-2	12.5.2 Priorities for access to extreme environments .....	12-17
12.2 Key players in trail design .....	12-3	12.5.2.1 Single extreme condition limits access .....	12-18
12.3 Types of trails .....	12-3	12.5.2.2 Cumulative conditions limit access .....	12-20
12.4 Long-range planning .....	12-4	12.6 Trail components .....	12-21
12.4.1 Trails versus the built environment .....	12-4	12.6.1 Trail corridor .....	12-22
12.4.2 Developing accessibility standards for trails .....	12-5	12.6.2 Trail element access .....	12-22
12.4.3 New construction .....	12-6	12.6.3 Trailhead access .....	12-25
12.4.4 Alterations .....	12-7	12.6.3.1 Facilities and amenities at the trailhead .....	12-25
12.4.5 Routine maintenance .....	12-8		
12.4.6 Long-range planning for multiple trail systems .....	12-9		

12.6.3.2 Directing trailhead traffic .....	12-26	14.5.1 Grade .....	14-9
12.6.3.3 Information at the trailhead.....	12-29	14.5.2 Rest areas.....	14-11
		14.5.3 Cross slope and drainage .....	14-12
		14.6 Shared-use path width .....	14-13
		14.6.1 Passing space.....	14-13
		14.6.2 Protruding objects .....	14-13
		14.7 Railings .....	14-15
		14.8 Signs .....	14-15
		<b>Chapter 13: Universal Trail Assessment Process</b>	
13.1 Overview .....	13-1		
13.2 Benefits of assessment.....	13-3		
13.3 Trail assessment coordinators .....	13-4		
13.4 Data collection and processing .....	13-4		
13.5 Presenting trail access information ...	13-5		
		<b>Chapter 14: Shared-Use Path Design</b>	
14.1 Background information .....	14-2		
14.2 Access to shared-use paths .....	14-2		
14.2.1 Rail trails .....	14-3		
14.3 Conflicts between multiple user groups.....	14-4		
14.4 Shared-use path surfaces .....	14-5		
14.4.1 Surface material .....	14-6		
14.4.2 Surface firmness, stability, and slip resistance .....	14-6		
14.4.3 Changes in level .....	14-7		
14.4.4 Openings.....	14-8		
14.5 Shared-use path grade and cross slope .....	14-9		
		<b>Chapter 15: Recreation Trail Design</b>	
		15.1 Background information .....	15-2
		15.2 Outdoor recreation access routes.....	15-4
		15.3 Trail conflicts between multiple user groups.....	15-6
		15.4 Trail surfaces .....	15-7
		15.4.1 Surface material.....	15-8
		15.4.2 Surface firmness, stability, and slip resistance .....	15-8
		15.4.3 Changes in level and tread obstacles .....	15-13
		15.4.3.1 Changes in level .....	15-14
		15.4.3.2 Tread obstacles .....	15-15
		15.4.4 Openings .....	15-16
		15.5 Trail grades and cross slopes .....	15-17
		15.5.1 Grade.....	15-17
		15.5.1.1 Recommended grade specifications .....	15-18



15.5.1.2	Grades that do not meet accessibility recommendations .....	15-18
15.5.1.3	Grade transitions and rest intervals .....	15-21
15.5.1.4	Trails through steep terrain .....	15-21
15.5.1.5	Change of grade .....	15-22
15.5.1.6	Curvilinear trails .....	15-25
15.5.1.7	Trails with steps .....	15-25
15.5.2	Cross slope and drainage .....	15-27
15.5.2.1	Recommended cross slope specifications ...	15-27
15.5.2.2	Cross slopes that do not meet accessibility recommendations .....	15-27
15.5.2.3	Change of cross slope .....	15-29
15.5.2.4	Minimizing erosion through natural drainage patterns .....	15-30
15.5.2.5	Waterbars .....	15-31
15.5.2.6	Trails in regions with heavy rain .....	15-33
15.5.3	Rest areas .....	15-33
15.6	Trail tread width .....	15-35
15.6.1	Trails with vegetation .....	15-35
15.6.2	Passing space .....	15-36
15.6.3	Protruding objects and vertical obstructions .....	15-37
15.7	Edge protection .....	15-38
15.8	Signs .....	15-39
<b>Chapter 16: Trail Crossings</b>		
16.1	Trail crossing another trail .....	16-2
16.2	Bridges .....	16-3
16.3	Trail intersecting a roadway .....	16-5
16.3.1	Use of curb ramps on trails at intersections .....	16-6
16.4	Grade separated crossings .....	16-6
16.5	Trail intersecting a railroad .....	16-8
<b>Chapter 17: Specialized Trails</b>		
17.1	Viewpoints .....	17-1
17.2	Beach trails .....	17-3
17.2.1	Beach access route specifications .....	17-3
17.2.2	Selecting surface materials .....	17-5
17.2.3	Considering temporary paths .....	17-6
17.2.4	Providing beach wheelchairs .....	17-7
17.3	Trails in extreme climates .....	17-7
17.4	Interpretive trails .....	17-8

<b>Chapter 18: Trail Maintenance</b>	
18.1 Facility maintenance .....	18-2
18.1.1 Assessment techniques .....	18-2
18.1.2 Shared-use paths maintenance .....	18-2
18.1.3 Recreation trail maintenance .....	18-3
18.2 Information maintenance .....	18-5
18.3 Citizen reporting .....	18-5
<b>Chapter 19: Research Recommendations</b> .....	19-1
<b>APPENDICES</b>	
<b>Appendix A: Sidewalk Assessment Process Forms</b> .....	A-1
Stroll Sheet .....	A-2
Intersection Checklist .....	A-3
Curb Ramp Element Analysis Form .....	A-4
Driveway Crossing Element Analysis Form .....	A-5
Cut-Through Median Element Analysis Form .....	A-6
Ramped Median Element Analysis Form .....	A-7
<b>Appendix B: Sidewalk Accessibility Checklist</b> .....	B-1
<b>Appendix C: Contact Information</b> .....	C-1
<b>Appendix D: Detectable Warning Manufacturers</b> .....	D-1
<b>Appendix E: Slope Conversion Chart</b> .....	E-1
<b>Appendix F: Abbreviations and Acronyms</b> .....	F-1
<b>Appendix G: Glossary</b> .....	G-1
<b>Appendix H: Bibliography</b> .....	H-1
<b>Appendix I: Index</b> .....	I-1

# Understanding the User

Chapter 1: Introduction

Chapter 2: Understanding Sidewalk and Trail Users





# Introduction

This guidebook is the second part of a two-phase project focused on designing sidewalks and trails for access. It was



**Figure 1-1.** Designing sidewalks for access enhances the overall quality of the pedestrian experience and improves the mobility of people with disabilities.

literature search and site visits conducted throughout the United States (Axelson et al., 1998). Many of the recommendations provided in this guidebook are based on research gathered during Phase I.

**The information presented in this guidebook is meant to be used as guidance only and should not be construed as requirements or regulations.** The strategies presented cannot always be reproduced in real-world situations exactly as recommended; instead, the general design principles should be applied in the most appropriate manner for each situation. These recommendations are not meant to supersede or challenge existing standards, but to supplement and provide guidance where standards have yet to be adopted.

## 1.1 Guidebook overview

The Guidebook has been divided into four distinct segments:

- Understanding the User
- Sidewalk Development

- Trail Development

- Appendices

Understanding the User (Chapters 1 and 2) addresses the general benefits of sidewalks and trails, the history behind disability rights legislation, and the needs and abilities of sidewalk and trail users. Sidewalk Development (Chapters 3 through 11) provides a comprehensive approach to creating accessible sidewalk networks. It addresses a broad array of sidewalk topics including planning, design, and maintenance. Chapters 12 through 18 are contained within Trail Development, which provides planning, assessment, and design guidance for trails. For the purposes of this guidebook, a trail is defined as a path of travel for recreation and/or transportation within a park, natural environment, or designated corridor that is not classified as a highway, road, street, or sidewalk. In Chapter 12 (planning) and Chapter 13 (assessment), recreation trails and shared-use paths are discussed as one unified topic. However,

in the design chapters (Chapters 14 and 15), shared-use paths and recreation trails are discussed separately. Chapter 19 (research recommendations) identifies recommended research topics and provides several appendices containing supplemental information.

Although this guidebook emphasizes design for pedestrian access, the needs of all potential user groups should be addressed during the design process. For example, if a summer hiking trail will be utilized by cross country skiers in the winter, the needs of both groups should be considered in the construction and maintenance plans for the trail. In addition, because off-highway vehicle (OHV) riders, equestrians, and others may have disabilities, all facilities — such as toilets — provided along a trail should be accessible. The Americans with Disabilities Act requires that all new construction be designed and constructed to be accessible; thus it is not necessary to determine the possible needs of trail users with respect to access.



## I.2 Metric versus English units

Many of the current accessibility standards were established in English units because they are based on architectural standards. However, the transportation industry often uses metric units. This is problematic because the accessibility requirements are very precise and in some instances, converting units and rounding can alter the original requirement by almost 2 inches. For example, both 915 mm and 945 mm round to 0.9 m, even though 945 mm is over an inch longer than 915 mm. To avoid misrepresenting the accessibility standards, dimensions less than 10 feet but greater than 12 inches are rounded to the nearest 5 millimeters; dimensions less than 12 inches are rounded to the nearest millimeter in this manual. All recommendations in this guidebook are provided in metric units with English units in parentheses.

## I.3 Benefits of sidewalks and trails

Sidewalks and trails serve as critical links in the transportation network providing pedestrian access to commercial districts, schools, businesses, government offices, and recreation areas. Because sidewalks and trails provide such fundamental services to the public, they should be designed to meet the needs of the maximum number of potential users. Unfortunately, many sidewalks and trails do not adequately meet the needs of people with disabilities, who constitute nearly one-fifth of the American population (U.S. Census Bureau, 1994). People with disabilities who live in areas without accessible pedestrian networks and do not have access to automobiles face a greater risk of becoming isolated from the community and unnecessarily dependent upon others to perform routine activities such as grocery shopping. An all-inclusive approach to sidewalk and

trail design will ensure that the needs of all potential users are addressed, including people with disabilities.

Accessibility improvements to sidewalks and trails can enrich the livability of a community. Sidewalks and trails with pedestrian-friendly elements, such as curb ramps and benches, create inviting strolling and shopping areas while providing access to people with limited transportation options. Commercial districts with accessibility improvements will have a larger customer base that includes people with disabilities. In addition, people with disabilities will be able to participate more easily in the community if well-placed access improvements are available because they can reach their desired destinations more easily. People with temporary disabilities, such as a broken leg or foot, will also be able to continue their daily functions with less inconvenience. An increase of accessible sidewalks and trails also mean better pedestrian facilities for everyone. Neighborhoods that are pedestrian friendly encourage people to walk and

become safer because there are more people on the street. A broader range of consumer, social, and recreational opportunities are available in areas that are usable by pedestrians.

Access to sidewalks and trails must not be denied to people with disabilities. Unfortunately, accessibility is often seen as a “you have to,” rather than a desirable component of the planning, project development, design, and construction processes. This attitude is limiting and does not consider the many human and economic benefits that accessible environments bring to a community. When the environment meets the needs of the most vulnerable users, the system is better for everyone. In addition to people with disabilities, many other people benefit from accessible sidewalks and trails. For example:

- Pedestrians have an easier time pushing or pulling shopping carts, luggage, and other wheeled devices;
- All pedestrians are able to choose trail experiences that best suit their



- needs, skill level, and desired experience;
  - Parents are able to more easily push children in strollers on sidewalks and trails with accessible surfaces;
  - Young children can use curb ramps when riding their bicycles;
  - Children, parents, and school systems benefit from sidewalk networks with visible pedestrian crossings and other safety features;
  - Children learn independence by having a safer place to travel;
  - A good system of sidewalks may allow older pedestrians who no longer drive to walk to services and socialize in their community, while offering a continued independent lifestyle;
  - Businesses can load and unload goods more easily;
  - Wide sidewalks can be gathering places in neighborhoods and business districts, and offer space for families and friends to walk and socialize together;
  - Wide sidewalks in business communities offer an opportunity for trees, landscaping, and other amenities that create an inviting place for customers to shop and do business; and
  - Well-maintained sidewalks and trails encourage exercise and provide the benefits of a healthy lifestyle.
- Sidewalk and trail projects should be selected carefully to maximize their usefulness to the community. All potential users, including people with disabilities, should be included in the public involvement planning process. Pedestrian facilities should be developed that are safe, attractive, convenient, and easy to use. Facilities that are inadequate

or inappropriate to a community's needs discourage use and waste money and resources (OR DOT, 1995).

#### **1.4 Legislation and standards**

The Americans with Disabilities Act of 1990 (ADA) is a landmark law that recognizes and protects the civil rights of people with disabilities. The ADA prohibits discrimination on the basis of disability by covered entities. Title I of the ADA prohibits discrimination in employment on the basis of disability by covered entities. Title II of the ADA prohibits discrimination on the basis of disability in the provision of services, programs, and activities by State and local governments. Title III of the ADA prohibits discrimination on the basis of disability in the provision of goods, services, facilities, and accommodations by private entities that provide public accommodations or operate commercial facilities. Under the ADA, services and facilities must be accessible to be nondiscriminatory, and the requirements

for new construction and alterations are much more stringent than those for existing facilities. Sidewalks and trails associated with covered services, whether new or existing, are subject to the requirements of the ADA. A more detailed description of the scope and requirements of the ADA is contained in Section 1.2 of Chapter 1 of Part I of this report, A Review of Existing Guidelines & Practices. The Americans with Disabilities Act is enforced by the U.S. Department of Justice.

Newly constructed and altered sidewalks and trails should be accessible and usable by people with disabilities. In addition, covered entities are responsible for developing transition plans and implementing accessibility improvements, where needed, to existing facilities. High priority should be given to the accessibility of sidewalks and trails during long-range planning and site development.

Agencies and private organizations who use Federal funds are also obligated to address accessibility by the Architectural Barriers Act (ABA) of 1968 and the Rehabilitation Act of 1973. The ABA

requires that buildings and facilities designed, constructed, altered with Federal funds, or leased by a Federal agency comply with standards for physical accessibility. The Rehabilitation Act requires all federally conducted or assisted programs to be available to people with disabilities. Each Federal funding agency applies and enforces a unique set of regulations for the Rehabilitation Act. The U.S. Architectural and Transportation Barriers Compliance Board, also known as the U.S. Access Board, was created under the Rehabilitation Act of 1973 to enforce the ABA.

#### **1.4.1 Accessibility standards for new construction and alterations**

The U.S. Access Board first published Sections 1 through 9 of the ADA Accessibility Guidelines (ADAAG) in 1991. These guidelines were subsequently adopted by the Department of Justice (DOJ) as the ADA Standards for Accessible Design, which made them enforceable by law. ADAAG provides specific scoping

information and technical requirements for new construction and alterations. Modifications that affect usability are considered alterations under the ADA. For example, according to the US DOJ Technical Assistance Manual, resurfacing of a roadway beyond normal maintenance is an alteration. However, construction limited in scope to a spot repair, such as repainting markings or patching potholes, is considered routine maintenance and does not trigger additional access retrofit requirements (U.S. Department of Justice, 1994a).

The first nine sections of ADAAG are specific to the built environment, which includes building sites and university campuses. Guidelines for designing sidewalks and trails are not specifically addressed in the 1991 ADA Accessibility Guidelines. However, public and private entities who design and construct sidewalks and trails are still obligated under ADA to make them accessible to and usable by people with disabilities. Until specific standards are adopted as part of ADAAG, some of the existing scoping and technical



provisions for new construction and alterations can be applied to the design of pedestrian facilities, such as:

- Accessible routes (ADAAG 4.3);
- Parking (ADAAG 4.6);
- Curb ramps (ADAAG 4.7); and
- Ramps (ADAAG 4.8).

#### **1.4.2 Developing accessibility standards for sidewalks**

In 1994, the U.S. Access Board published an Interim Final Rule that contained proposed guidelines for public rights-of-way (proposed Section 14 of ADAAG, now reserved). However, after receiving public comments, they decided to withdraw the guidelines and focus on a public awareness campaign aimed at the transportation industry. As part of this effort, the U.S. Access Board recently published a design guide entitled, *Accessible Rights-of-Way: A Design Guide*, to promote accessible sidewalk

development (U.S. Access Board, 1999a). In addition, the U.S. Access Board has convened a committee of transportation and disability experts to readdress the issue of sidewalk guidelines and recommend design and technical provisions that can be adopted under the ADA.

The specifications in ADAAG are based on the needs of the majority of pedestrians with disabilities. However, no environment will ever be accessible to everyone because people with disabilities have a broad spectrum of abilities. The term “accessible” is used in this guidebook to refer to environments that meet the specifications defined by the U.S. Access Board. Specifications which define “accessible” environments include the current version of ADAAG, as well as the report of the Regulatory Negotiation Committee on Accessibility Guidelines for Outdoor Developed Areas and the U.S. Access Board’s recommendations for sidewalks contained in *Accessible Rights-of-Way: A Design Guide* (U.S. Access Board, 1999a).

### **I.4.3 Developing accessibility standards for trails**

Many people with disabilities and others with circumstances limiting their mobility enjoy traveling through natural environments. The U.S. Access Board created the Recreation Access Advisory Committee in 1993 to discuss accessibility guidelines needed for recreation facilities, including trails and other outdoor developed areas. The U.S. Access Board issued the Committee's work as an Advanced Notice of Proposed Rulemaking. Based on the feedback received, the U.S. Access Board created a Regulatory Negotiation Committee on Accessibility Guidelines for Outdoor Developed Areas. The Committee represented various interest groups, including organizations representing trail builders and people with disabilities. The authors of this guidebook participated in both the Recreation Access

Advisory Committee and the Regulatory Negotiation Committee on Accessibility Guidelines for Outdoor Developed Areas. Many of the recommendations in the Trail Development chapters of this guidebook are based on the work of the Regulatory Negotiation Committee on Accessibility Guidelines for Outdoor Developed Areas. The U.S. Access Board will use the Committee's report to develop a proposed rule that will be published for public comment and will become a special application section within ADAAG.

Many people with disabilities do not have the functional mobility to negotiate environments that meet "accessible" specifications without the aid of assistive technology, such as powered wheelchairs. However, most people with disabilities have the functional mobility to negotiate environments that meet "accessible" specifications with appropriate assistive technologies.





# Understanding Sidewalk and Trail Users

confident with their own needs and experiences, designers and engineers should attempt to create a connection between themselves and the broad range of people who will use the facilities that they create. A successful understanding between designers and those they are designing for will result in a future of more accessible facilities and higher quality experiences on public sidewalks and trails.

## 2.1 Function, activity and participation

In 1981, the World Health Organization published the International Classification of Impairment, Disability and Handicap (ICIDH) so that communication and terminology could be standardized and understood on an international level (World Health Organization, 1980). The ICIDH defined three terms for describing health-related restrictions of an individual's level of function:

In order to meet the needs of a broad group of sidewalk and trail users, designers and engineers must have a true understanding of the wide range of abilities that will occur within the population and how design parameters can influence those abilities. Since people are naturally most comfortable and



**Figure 2-1.** Accessible facilities and high quality experiences on sidewalks and trails result from an understanding of the wide range of abilities that exist within the population and how the design process can meet the needs of people of all abilities.

**Impairment** — a difference in the way a body is constructed or functions;

**Disability** — a limitation in the way daily functions in the community can be performed as a result of an impairment; and

**Handicap** — a limitation of function imposed by the beliefs of the community.

Recent revisions to the ICDH go even further in identifying disability as a function of the environment (World Health Organization, 1999). The new classification system (ICIDH-2) is designed to describe the health status of all individuals, with and without disabilities. The labels of “disability” and “handicap” have been removed from consideration. Using the ICDH-2, the functional status of each individual can be described using the following dimensions:

**Function** — the physiological or psychological functions of the body or the anatomical body parts;

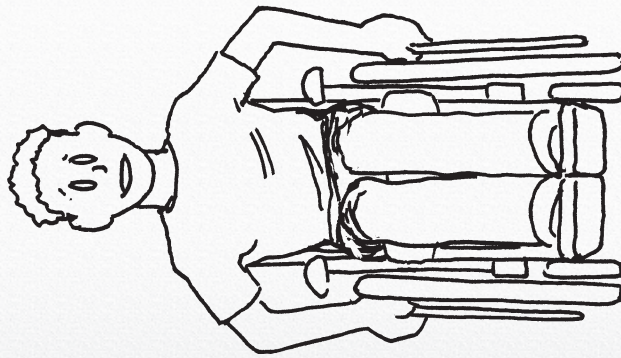
**Activity** — the performance of a task or action by an individual;

**Participation** — an individual’s involvement in life situations within his or her society;

**Contextual Factors** — environmental and personal factors that impact the individual’s functional state.

These definitions highlighted a basic premise that has been the foundation of accessibility issues and concerns during the past two decades:

An impairment is a function of the individual. A disability or handicap occurs because of limitations imposed on the individual by the community in which he or she lives. Thus, disability and handicap are functions of the environment rather than the individual and both are preventable through a combination of education, assistive technology, planning, and design.



**Figure 2-2.** This wheelchair user has a mobility impairment that may or may not create a disability depending on the design of his environment.



Using the ICIDH-2, the ability of each individual to use a sidewalk or trail environment can be described through a combination of the these dimensions. In addition, the barriers to sidewalk or trail use that may be encountered can also be described. Each of these dimensions is explained in greater detail in the following pages.

### 2.1.1 Function

Body functions describe the physiological or psychological functions of the various systems within the human body. Body structures identify the anatomical parts of the body, such as organs or limbs. Body functions and structures are used to describe the functional and structural integrity of all individuals. Impairments are problems in body function or structure.

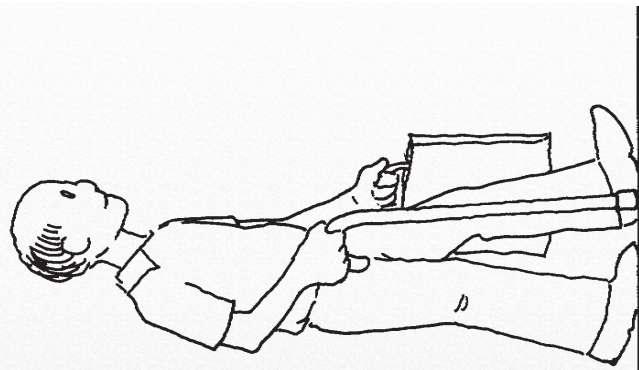
**Figure 2-3.** Impairments are problems in body function or structure.

Impairments may be a reduction, loss, addition, or deviation. Impairments can be temporary or permanent, progressive or static, intermittent or continuous, minor or severe. The presence of an impairment does not necessarily indicate the presence of a disease or disorder. Body function or structure can only be changed through interventions that restore the function (such as, a kidney transplant can restore a loss of kidney function) or structure (such as, a bone graft can be used to rebuild a shattered bone). However, an impairment may or may not limit a person's ability to perform activities or participate in society.

### 2.1.2 Activity

Activity is "what an individual does" (World Health Organization, 1999). It describes a task or action that can be performed by an individual within all aspects of human life. An activity limitation results from difficulties that an individual may have in the performance of an activity. For example, activity is limited when an individual has difficulty

**Impairment = Problem in Body Function or Body Structure**



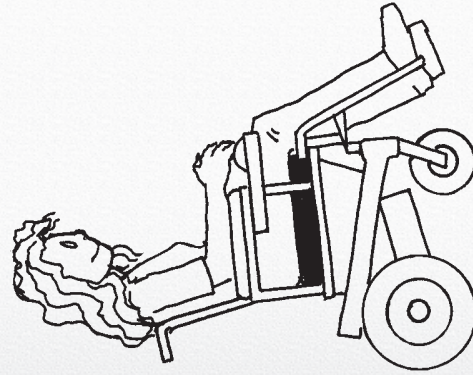
performing an activity in the expected manner or is unable to perform the activity at all. The limitation may relate to qualitative or quantitative differences in the way an activity is performed. The following examples demonstrate how activity limitations can be addressed:

**Assistive devices** — a larger handle can enable someone with limited grip to grasp a toothbrush and brush his/her teeth;

**Personal assistance** — a gardener can be hired to look after the exterior home environment if the individual is unable to do so; and

**Modifications to the environment** — replacing a set of steps with a ramp will enable someone using a wheelchair to enter a building.

Although these types of modifications cannot eliminate an impairment, they can be used to eliminate activity limitations.



**Figure 2-4.** A powered wheelchair is an example of an assistive device that helps to prevent a mobility impairment from causing an activity limitation.

### 2.1.3 Participation

Participation refers to the individual's involvement in life situations within his or her community. It describes the individual's degree of involvement, as well as society's response to the individual's level of functioning. Included within the societal context are all of the physical, social, and attitudinal factors that may be encountered. Involvement in life situations has objective and subjective aspects. Objective aspects include being engaged in an area of life, being accepted, or having access to the required resources. Subjective aspects include satisfaction, fulfillment, and enjoyment. Participation differs from activity in that it describes external factors rather than the "internal" abilities of the individual. Participation restrictions describe problems that an individual may encounter when they attempt to be active in life situations. Restrictions may result from the social environment, even when the individual has no impairment or activity restriction. For example, someone who is HIV



positive with no symptoms or functional impairment may be denied insurance or excluded from activities because of social attitudes.

- Services; and
- Systems and policies (Gray & Hendershot, 2000).

#### 2.1.4 Contextual factors

Contextual factors represent the complete background of an individual's life and living (World Health Organization, 1999). They include any environmental or personal factors that have either a positive or negative influence on the individual's function, activity, or participation.

Environmental factors are external to the individual, and include the physical, social, and attitudinal environments that exert an influence on individual functioning. Major categories of environmental factors include:

- Products and technology;
- Natural environments and human changes to the environment;
- Support and relationships;
- Attitudes, values, and beliefs;

Personal factors are attributes or features of the individual that are not related to the individual's functional state. These may include factors such as age, gender, educational background, socioeconomic status, personality, fitness, habits, social background, or coping traits.

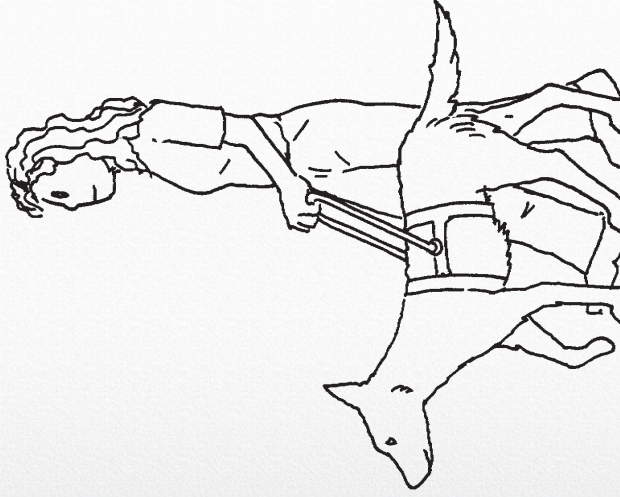
## 2.2 Different abilities for sidewalks and trails

People with and without impairments use a variety of methods to travel within their environment. Some people are fit and athletic, others less so. Some people rely primarily on automobiles for travel within their community, while others walk extensively, bicycle, or utilize public transportation. Most people are very familiar and comfortable with the "rules" and expectations for traveling within their community while others may have

difficulty understanding or following expected travel patterns. Children and older adults have different physical and cognitive abilities than young adults. People with disabilities often utilize different methods, skills, and abilities than those generally used by people without disabilities. In these and many other ways, each individual is unique.

The range of abilities among our population is also reflected in the wide variety of factors that might affect the use of sidewalks and trails. Whether a particular individual, or group of individuals, can safely and effectively access a sidewalk or trail will depend on a large number of functions, such as:

- Agility
- Balance
- Cognition
- Coordination
- Endurance
- Flexibility



**Figure 2-5.** For people who are blind, the use of sidewalks is essential to perform daily living activities. Sidewalks must be designed to meet the needs of all potential users across a full spectrum of abilities.

- Hearing
- Problem solving
- Required behavior(s)
- Sensory processing capacity
- Strength
- Vision
- Walking speed

Among any group of individuals, there will be a wide range of abilities for each of the functions that affect the accessibility or usability of the sidewalk or trail. For example, vision is often required to identify signs or directional information that enhance the safety of pedestrians. Vision abilities range along a continuum from 20/20 vision to no vision. Pedestrians using sidewalks and trails may have visual abilities at any point along the continuum. The greater the range of visual abilities that can be accommodated in sidewalk or trail designs, the larger the

### 2.3 Designing for all abilities

proportion of people who will be able to safely and effectively travel on the sidewalk or trail.

The ability to participate in community life depends on the ability to travel independently. Virtually every activity that requires people to venture outside of their homes requires the use of pedestrian travel paths, such as sidewalks and trails. Even when relying primarily on automobiles, people still must become pedestrians to get from their automobile into the building or destination. Since the use of sidewalks is essential for performing activities of daily living, such as grocery shopping or errands, access to sidewalks is a right of all individuals. Therefore, it is essential that sidewalk design parameters meet the needs of all potential users across the full spectrum of abilities. Sidewalks are basic to independent living and must meet the highest standards. The use of and access to trails must also be a high priority, particularly for those trails that provide access to essential services and facilities in outdoor environments (such as, visitor facilities and restrooms).

While function relates solely to the individual, most of the ICIDH-2 dimensions (activity, participation, and contextual factors) are influenced by the society or environment in which the individual lives. All individuals have the right to fully participate in their community. If neighborhoods do not have a safe, comfortable, and convenient pedestrian system, this can leave people isolated in their own homes and unable to participate in everyday activities. Given the broad influence of environmental factors on the individual's level of function, professionals who design or construct sidewalk or trail environments have a significant influence over whether individuals will be able to use and enjoy the sidewalk and trail environments that they create.

Historically, our society believed that the presence of a disability was a function of the attributes of the individual. As such, it was the responsibility of the individual to change or adapt in order to





**Figure 2-6.** Older adults rely on sidewalks to travel within their community to perform daily activities.

“fit” into the community.

For example, if an individual’s legs were paralyzed, the individual was expected to find a different way to walk up a flight of stairs and into a building. However, as the ICDH classification system demonstrates, activity and participation are not just a function of the individual but a reflection of the community environment in which they live. The installation of stairs with no alternate means of access creates activity and participation limitations for those who are unable to walk up the stairs. When a person’s independence is denied because of facilities not being accessible, the person, their family, and society pays the cost of their isolation and dependence.

### 2.3.1 The need for a new approach

Sidewalk and trail developers, engineers, and construction personnel build for the future. Since months or years can elapse while a project is developed, designed, and constructed, projects constructed today will not be replaced for many years. Therefore, sidewalk and trail developers must not only be prepared to solve current design problems, but to also be fully aware of how current solutions will meet user demands in the future.

The design of sidewalk and trail environments is important to all pedestrians, but is particularly important to those with activity limitations related to the use of pedestrian environments. Older adults, people with vision impairments, and children frequently rely on sidewalks to travel within their community. People with mobility impairments must also incorporate knowledge of barriers and the location of accessible routes of travel as they plan their participation within the community. For instance, someone using a wheelchair may want to go to the



**Figure 2-7.** Designers and engineers must meet the needs of people of all abilities. Different functional abilities may involve varying walking speeds and endurance.

bank, post office, and grocery store. The selection of where to go will be influenced by the accessibility of each facility, as well as the accessibility of the paths of travel between each facility. Barriers along a path of travel may actually force an individual with activity limitations to use different facilities than they would prefer.

Traditionally, the project development, design, and construction of pedestrian facilities have been based on the design

characteristics of a “standard pedestrian.” Oftentimes the parameters for the “standard pedestrian” were based on a young adult male of “normal” body function and structure. It has always been recognized that these design parameters

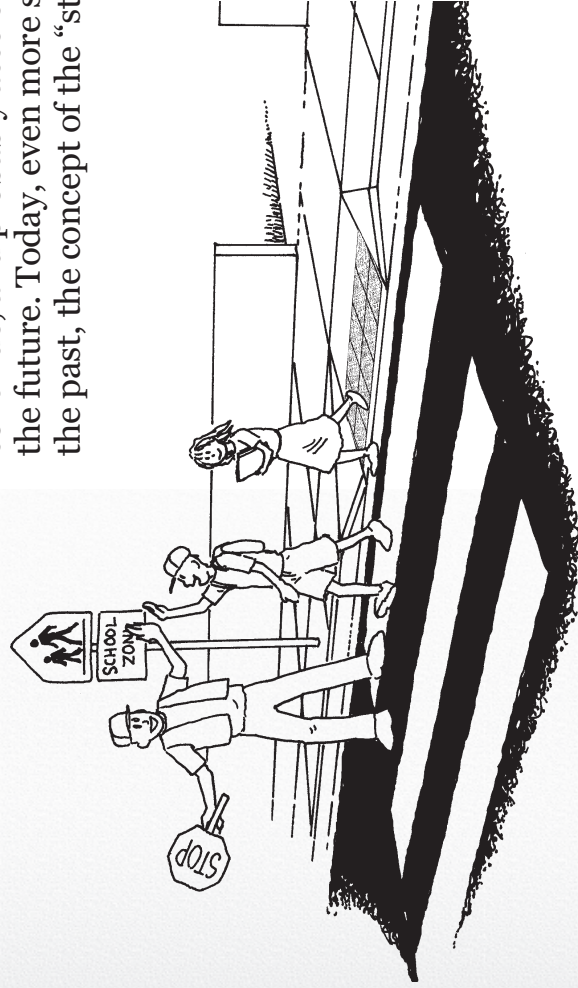
were meant to represent an average among the population. While these parameters may have been appropriate for pedestrian facilities in the past, the composition of our population has changed significantly in recent decades. Some examples of changes in the population that may affect sidewalk and trail design parameters include:

- There is an increasing proportion of older adults;
- Approximately 20 percent of Americans have a disability and the percentage of people with disabilities is increasing (U.S. Census Bureau, 1994);
- Decreasing mortality rates for a variety of disabling illnesses and injuries are resulting in an increase in the length of time that people live with functional limitations (i.e., people are living longer with less function);



- Over 50 percent of adults in the United States are now obese, making obesity the norm (Center for Disease Control, 1997);
- Many children travel on their own to and from school.

These changes are expected to continue, and probably accelerate, in the future. Today, even more so than in the past, the concept of the “standard



**Figure 2-8.** Signs, marked crosswalks, and crossing guards create accessible sidewalk environments for children who travel on their own to and from school.

pedestrian” is detrimental rather than helpful in creating high quality pedestrian facilities. In reality, the travel speeds, endurance limits, physical strength, stature, and judgment abilities of pedestrians vary tremendously, and the range of abilities is increasing as our population changes. For example, the average pedestrian as defined in the Manual on Uniform Traffic Control Devices has a walking speed of 1.2 m/s (4 ft/s) (U.S. Department of Transportation, 1988). In contrast, research with older adults indicates an average walking speed of 0.85 m/s (2.8 ft/s) (Staplin, Lococo, Byington, 1998).

Use of a “standard pedestrian” may create unnecessary barriers because the associated design parameters no longer reflect the abilities and needs of our population. In order to meet the needs of our changing population, designers should use the knowledge and awareness of the range of abilities among our population to develop sidewalk and trail environments that do not impose activity or participation limitations because of artificial or unnecessary barriers.



### 2.3.2 Accessible environments through universal design

Our society now recognizes that everyone has the right to have and use pedestrian facilities. Society's recognition of these rights is supported by legislation prohibiting discrimination, such as the Americans with Disabilities Act, which prohibits discrimination on the basis of disability. Designing sidewalk and trail environments to meet the current and future needs of our changing population requires an inclusive design approach. Building pedestrian facilities now and for the future means beginning to address the needs of a broader range of sidewalk and trail users, including older pedestrians, people with disabilities, and children. Just as roadways are designed to suit the needs of all types of vehicles, sidewalks and trails should be designed to accommodate the needs of all pedestrians (Washington State Department of Transportation, 1997).

Universal design is “an approach to creating environments and products that are usable by all people to the greatest

extent possible” (Mace, Hardie & Place, 1991). Instead of designing solutions that benefit only a small target audience (such as, the “standard pedestrian”), universal design emphasizes meeting the needs of all potential users to the greatest extent possible. In addition, universal designs take into consideration the physical, cognitive, emotional, and social changes that each individual experiences over the course of a lifetime.

Universal design encourages and supports the development of facilities that include and are usable by people of all abilities. Providing a ramped entrance to a building at the back door when the front entrance has stairs is not a universal design. Although considered accessible, this solution separates users by their abilities. A universally designed solution would seek to meet the needs of all users by creating access for all through the primary entrance. Successfully addressing the current and future needs of our changing population means incorporating the principles of universal design into all aspects of sidewalk and trail development.

### 2.3.3 Natural and constructed environmental constraints

The benefits of universal design are not specific to people with disabilities. The key to creating high quality pedestrian environments is to recognize that all individuals have different abilities for using sidewalks and trails. No one is “standard.” Everyone has strengths, weaknesses, and differences in abilities along a continuum from very high to very low levels of function. Whether these differences result in an activity or participation limitation depends, in large part, on the demands or constraints found within the sidewalk or trail environment. Activity and participation limitations in sidewalk and trail environments can result from a variety of factors. In general, these factors relate to either the constructed or natural environment. Limitations in the constructed environment are created when built facilities do not meet the needs of users. For example, offices at the top of a tall building would have a tremendous disadvantage for attracting clients if an

elevator was not provided. Limitations imposed by the natural environment are not caused by human efforts but may need to be mitigated through human changes. For example, a landslide can make travel along a trail difficult or impossible, particularly for individuals that are not very fit or agile.

The goal of sidewalk and trail design and construction is to ameliorate the constraints within the natural environment and to avoid constraints in the constructed environment to enable effective pedestrian travel. Sidewalk and trail developers should:

- Ensure that the environments that they design and construct do not create activity or participation limitations; and
- Minimize the activity or participation limitations that result from existing natural conditions.

It is only through a universal design approach that activity and participation limitations can be minimized and the



barriers within the constructed environment can be eliminated.

physically move along or within an environment. It may limit the individual's movement from one place to the next (e.g., travel from one side of an intersection to the other), or the ability of the individual to position his or her body within one location (e.g., move the arm and hand in order to use a pedestrian actuated signal device or to get close enough to push it).

The movement barrier may create a physical barrier to movement (e.g., soft, unstable surfaces), or it may result in a barrier because of the type of movement the individual is required to perform (e.g., short signal times require rapid analysis and very fast positioning and movement to cross and may not provide enough time for decisionmaking before crossing). Movement barriers result from a variety of factors within the environment and/or the individual.

- Movement barriers; and
- Information barriers.

Movement barriers within the environment can occur in both natural and constructed environments. Examples of movement barriers within the environment include:

## 2.4 Barriers create activity and participation limitations

Activity and participation limitations can result from an almost limitless range of factors. Within the scope of this guidebook, it is not possible to discuss the full range of potential factors that may result in activity or participation limitations for an individual. Therefore, the following discussion will focus on the most common barriers found within sidewalk and trail environments. In general, the ability of an individual to participate in sidewalk and trail environments is influenced by two types of barriers:

### 2.4.1 Movement barriers

A movement barrier is anything that restricts an individual's ability to

- Difficult terrain (e.g., steep slopes or cross slopes and soft, unstable, or uneven surfaces);
- Travel path designs that require high speed movements and/or sudden or frequent changes of direction (e.g., short signal phases that do not provide sufficient crossing time);
- Travel paths without areas for rest or shelter;
- Obstacles within the path of travel (e.g., lamp posts, benches, rocks, railings, or barrier);
- Sidewalk/trail design that exposes the user to potential hazards (e.g., unregulated at-grade crossing of a multi-lane highway);
- Environmental designs that require unusual movements or coordination (e.g., placement of pedestrian actuated signal devices in a location that cannot be accessed by all pedestrians); or

- Over and under passes with stairs or steep ramps.

Movement barriers within the individual are determined by the individual's body function and structure. Examples of movement barriers within an individual are:

- Limited agility (e.g., ability to negotiate obstacles, steps, or curbs);
- Limited endurance (e.g., inability to increase heart rate or breathing, quick onset of fatigue, or increased energy expenditure for ambulation with crutches or canes);
- Limited speed (e.g., limited coordination or lack of strength for quick movements);
- Unpredictable movement patterns (e.g., children often go from “start” to “stop” or may change directions or plans on the spur of the moment); and

- Deliberations in decisionmaking (e.g., people with vision impairments or older pedestrians with cognitive disabilities may take longer to start and determine when to cross).

Design recommendations on how to achieve these objectives are discussed in more detail in the Sidewalk Development and Trail Development sections.

#### 2.4.2 Information barriers

Table 2-1 provides examples of how some sidewalk and trail users may experience activity or participation limitations because of environmental or individual movement barriers.

Professionals who design or build sidewalk and trail environments should ensure that they:

- Do not create movement barriers within the environment;
  - Eliminate or at least minimize the movement barriers that naturally occur within the environment; and
  - Design environments that do not impose a barrier that results in movement barriers for an individual; thus creating a disability from an environment that doesn't function (see Table 2-1).
- Information barriers restrict the individual's ability to use information contained within the sidewalk or trail environment. An information barrier may limit the individual's ability to:
- Recognize or receive information (e.g., a loss of vision and loss of hearing and vision together prevents an individual from utilizing visual signs);
  - Understand the information received (e.g., a person with a cognitive impairment may see a flashing "WALK" or a "DON'T WALK" signal but not understand what it means; children have difficulty judging the speed of an approaching vehicle);



**Table 2-1. Movement Barriers**

The following table provides examples of how some sidewalk and trail users may experience activity or participation limitations because of environmental or individual movement barriers.

User Description	Environmental Movement Barriers				Individual Movement Barriers				
	Difficult terrain	Soft surface	Obstacles	Signal actuation	Complex decisions	Limited agility	Limited endurance	Limited speed	Unpredictable movement patterns
Stroller User	X	X	X				X		
Wheelchair User	X	X	X			X	X	X	
Inline skater	X	X	X			X			X
Individual with limited balance	X	X	X			X			X
Individual with a vision impairment			X	X			X	X	X
Older adult						X	X	X	X
Child	X				X	X	X		X
Individual who is obese	X					X	X	X	X
Crutch or support cane user	X	X	X			X	X	X	
Individual with low fitness levels	X						X	X	
Individual with a cognitive impairment				X	X			X	X
Individual with an emotional impairment					X				X

- Decide on a course of action quickly (such as, picking a gap), align themselves properly, and start to cross within the signal phase; or
  - Act upon the information in the anticipated manner (e.g., young children believe that adults will protect them from harm, so they may ignore a stop sign for pedestrians to stop on trails or shared-use paths, even though they see and understand the sign).
- Inaccessible formats for pedestrian information;
  - Ambiguous or unclear signs or signals;
  - Information available through only one format (e.g., visual but not auditory);
  - Unclear or missing information about the appropriate pedestrian path of travel; and
  - Decisions (e.g., selecting a gap) requiring vision.

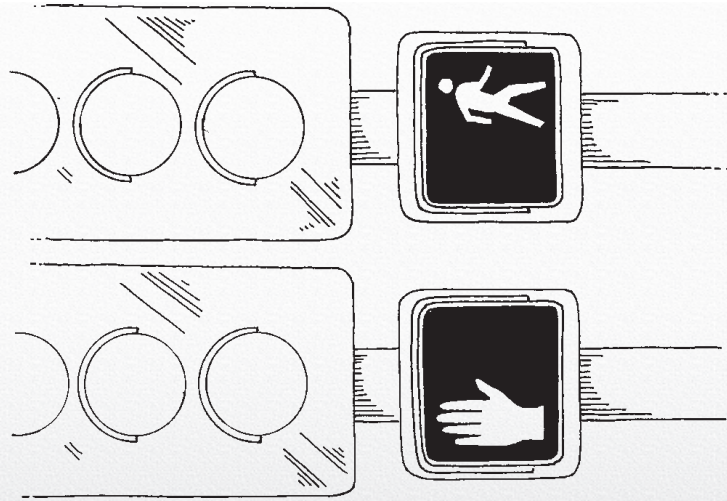
Information barriers may result from factors within the environment and/or the individual. The design of high quality, accessible pedestrian environments includes measures to ensure that information about the environment is available to all pedestrians.

Information barriers within the environment include:

- Limited sight lines;
- Complex paths of travel;

Information barriers for some individuals can also be addressed through the design of the sidewalk or trail environment. Examples of information barriers for some individuals include:

- Limited ability to receive information (e.g., limited vision may prevent a person from receiving visual information, and loss of hearing will prevent a person from receiving auditory information);



**Figure 2-9.** Pictorial symbols are easier for people with cognitive impairments or limited English language skills to understand.

- Limited ability to process or understand the information received (e.g., an individual with a brain injury may see a traffic sign but be unable to understand the meaning of the text);
- Limited ability to act in accordance with information received (e.g., a person with an emotional impairment may be so overwhelmed with the desire to get to a different location that they ignore a red light even though it can be seen and understood); and
- Decreased speed for processing information, making decisions, and implementing action (e.g., an individual with a cognitive or vision impairment may require more time to decide that it is safe to cross an intersection and, by then, the conditions may have changed or the light may be red for the pedestrian).

Table 2-2 provides examples of how some sidewalk and trail users may

experience activity or participation limitations because of environmental or individual information barriers.

Those who design sidewalk and trail environments must ensure that they:

- Do not create information barriers within the environment;
- Eliminate or at least minimize the information barriers that naturally occur within the environment; and
- Design environments that do not impose a barrier that results in information barriers that occur for specific people thus creating a disability from an environment which doesn't function (see 2.2).

Design recommendations for creating sidewalk and trail environments with information accessible to all pedestrians are discussed in more detail in the Sidewalk Development and Trail Development chapters of this guidebook.



**Table 2-2.** The following table provides examples of how some sidewalk and trail users may experience participation limitations because of environmental or individual information barriers.

User Description	Environmental Information Barriers			Individual Information Barriers				
	Sight lines	Inaccessible formats	Irregular and skewed intersections	Complex signage	Limited ability to receive	Limited ability to process	Slower speed to process	Limited ability to have an expected response
Individual with a vision impairment	X	X	X		X			
Individual with a hearing impairment	X	X	X		X			
Individuals with brain injury				X			X	
Individual with a mobility impairment	X		X				X	
Individual with limited English language skills		X		X	X		X	X
Older adult			X	X			X	X
Child	X		X	X	X		X	X
Individual with limited concentration abilities			X	X			X	X
Individual with a cognitive impairment		X	X	X			X	X
Individual with an emotional impairment			X				X	X

## 2.5 Conflicting pedestrian needs

All pedestrians will have different needs; therefore, changing a design to enhance access for one group can create additional barriers for other individuals. It must be recognized that it is not possible to create an environment that provides equal levels of accessibility to every individual. However, the goal should be to make all sidewalk and trail environments accessible to the largest possible number of potential users.

In order to create high quality sidewalk and trail environments that are usable by the highest proportion of pedestrians, designers should understand how a user's abilities are impacted either positively or negatively by any given design feature. The following examples illustrate the need for designers to be aware of the impact of design features on all potential users:

- **Walking on slopes** — A ramp installed to permit access into a building without the use of steps may impede access for someone who

has a limited ability to walk on sloped surfaces. People who use walking aids or have limited balance may have greater access via a set of stairs than can be provided if they are required to use a sloped surface, such as a ramp or graded terrain.

- **Detection of the sidewalk-to-street transition** — Curb ramps are critical access features for people who use wheeled forms of mobility (e.g., wheelchairs, strollers, bicycles, and inline skates). However, they make it much more difficult for people with vision impairments to detect the transition between the sidewalk and the street. It is very difficult to detect differences between gradual slopes in the absence of visual cues. Individuals who have reduced sensory capacity in the extremities experience similar barriers. These problems are enhanced further among individuals with sensory and other impairments (e.g., diabetes can lead to vision and sensory function loss).

- **Knowledge of traffic movement**
  - Roundabouts and right turn slip lanes are used to improve intersection efficiency for automobiles. However, they also disrupt the “stop and go” traffic patterns that are typically found at an intersection and force pedestrians to rely on visual cues to identify gaps available for crossing. The traffic sounds that people with vision impairments use to identify the gap for a safe crossing are disrupted or absent when there is a continuous traffic flow. Furthermore, if the traffic does not yield to the pedestrian, problems may be created for people with slower walking speeds and starting times, as well as for those who have difficulty determining the appropriate crossing time or location.
- **Different abilities among users on the same path** — Along a shared-use path, different user groups may compete for the same space. Differences in factors such as travel speed, type of technology, noise or anticipated experience may

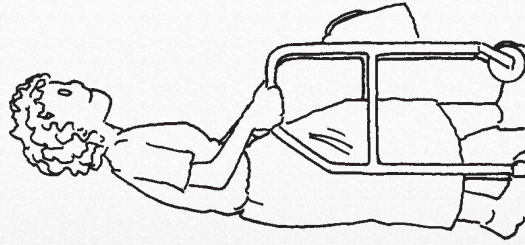
create conflicts between users. In addition, when people of different abilities use the same travel space, improving access for one user group may reduce the accessibility provided to other users. Examples of conflicts between users of different abilities include:

1. Grade reductions through elongated, winding trails to enhance accessibility for pedestrians with movement limitations may decrease the usability and desirability of the trail for cyclists commuting to work who are looking for optimal speed and efficient paths of travel;
2. Individuals with limited agility may have difficulty avoiding cyclists traveling at higher speeds if cyclists are not easily detected;
3. Road cyclists and pedestrians generally prefer a firm and stable surface, while runners and equestrians prefer a softer surface; or



4. Mountain bike riders may prefer a trail with many obstacles while runners, wheelchair users, and road bike riders prefer a smooth trail surface.

When addressing the conflicting needs of users, designers should focus on making improvements to include use of the widest range of potential users. Maximizing use may mean employing additional design tools. For example, a detectable warning (see Chapter 6) located at the bottom of a curb ramp can improve curb ramp detectability by persons with vision impairments. Users traveling at various speeds can be accommodated by splitting shared-use paths to provide separate travel paths for slower users. The needs and capabilities of all potential users should be considered and balanced when designing pedestrian facilities.



**Figure 2-10.** Some ambulatory pedestrians with mobility impairments benefit from walking aids, such as walkers, to minimize the effects of their impairment.

constantly and rapidly changing the way we do things. Technology allows us to travel farther and faster, communicate information instantly, and do activities and perform feats that were previously extremely difficult or impossible.

One facet of the technological revolution is the development of assistive technology to enhance function, activity and participation. There is an ever-increasing array of technology available to individuals. Some types of assistive technology, such as the gears on a bicycle, are widely known and understood. Other types of assistive technology, such as the devices used by many individuals with disabilities, are not widely recognized.

While it is not possible for every designer to have detailed knowledge of every type of assistive device, a general understanding of the functions and uses associated with the more common types of assistive technology used by people with impairments is an important factor for enhancing activity and participation.

Assistive technologies play a valuable role in enhancing the ability of people with

## 2.6 Function, activity, and technology participation, and technology

We are living in the “technology and information” age, and technology is

disabilities to navigate independently through indoor and outdoor environments. These devices can sometimes be used to minimize or eliminate the activity limitations and participation restrictions that exist within sidewalk and trail environments.

The broad range of assistive technologies for people with disabilities is often discussed in terms of a continuum of technologies that include (Axelson, 1988):

- Personal technologies;
- Activity-specific technologies; and
- Environmental technologies.

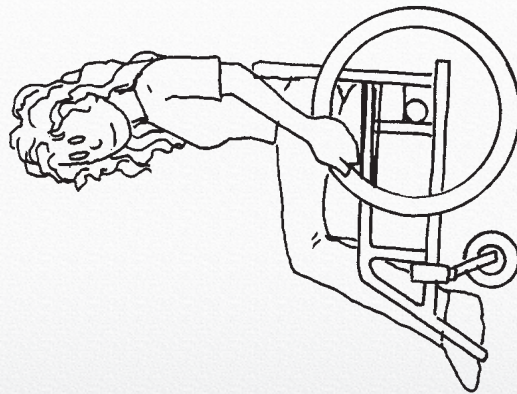
### 2.6.1 Personal technologies

Personal technologies are things that are closely associated with, and usually connected to, the individual. They include things that you utilize, such as a long white cane, eye glass, wheelchair, or guide dog, as well as things you wear, such as eyeglasses, a hearing aid, or prosthesis.

Personal technologies enhance the body's function or structure with the goal of enhancing the individual's ability to accomplish a variety of day-to-day activities.

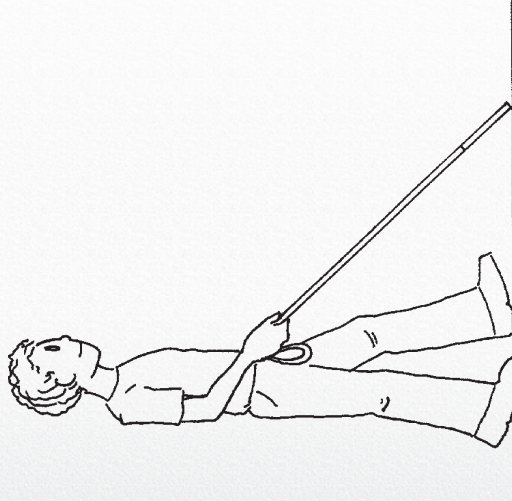
Personal technologies generally only benefit the owner of the technology, and require the individual or the individual's health care or insurance provider to bear the cost of purchasing and maintaining the device. In addition, each type of technology will have positive and negative aspects. For example:

- A **wheelchair** provides easy mobility on flat, firm surfaces. However, it is much more difficult to maneuver on slopes. Traversing steps or curbs is extremely difficult if not impossible.
- A missing leg can be replaced with a **prosthetic leg**. Current technology works quite well if the individual retains his or her own knee. However, a prosthetic leg does not provide the sensory feedback that is needed to ensure stable foot placement, detect obstacles, or maintain balance.



**Figure 2-11.** A wheelchair is an example of a personal technology that allows a person with a mobility impairment to accomplish all types of daily activities.





**Figure 2-12.** A long white cane is an example of a personal technology that allows a person with a vision impairment to independently accomplish many daily activities.

- **Eyeglasses** are a very common type of technology used to correct mild to moderate vision impairments. However, eyeglasses are cumbersome to use in rain, fog or cold weather conditions, and special “safety” frames are required for sports or activities that might result in impact to the device.

- Individuals with severe vision loss often use a **long white cane** or **guide dog**. A long white cane provides advance warning about obstacles on the path ahead, but it is not effective at detecting other visual cues, including obstacles above 685 mm (27 in). Guide dogs can get around obstacles, but their owners must provide instructions and directions as to where they want to travel.

- A **hearing aid** can be used by individuals who are deaf or hard of hearing to magnify the sounds in their environment. However, the magnification is not selective, so a

pedestrian using a hearing aid hears the sounds of traffic and audible pedestrian signal magnified.

### 2.6.2 Activity-specific technologies

Activity-specific technologies are devices that enhance an individual’s ability to perform a specific activity. They include all types of sports equipment (e.g., bicycles and inline skates), equipment for activities of daily living (e.g., pots and pans, toothbrush, and hairbrush), as well as devices designed specifically for one individual (e.g., knee brace and custom ski boots). Activity-specific technologies can also be used to compensate for an impairment.

As with personal technologies, activity-specific technologies often benefit the owner of the technology and require the individual or provider to bear the cost of purchasing and maintaining the device. However, many private and trail organizations make activity-specific technologies available to a broader spectrum of users. For example,

Vail Mountain in Colorado rents mountain bikes and mountain-bike wheelchairs.

The best products work for everyone, but in some instances, activity-specific technologies may need to be modified or new technologies may need to be developed in order to assist people with impairments. For example, most people would use a pair of alpine skis to go skiing. People who are unable to stand could use a sit-ski, mono-ski, or bi-ski, which would allow them to ski while seated. Similarly, bicycles are designed to allow people to travel at greater speeds and distances using human power. People without the use of their legs could use a handbike to perform a cycling activity using only their upper body.

Each type of activity-specific technology will have both positive and negative impacts on the individual's function, activity and participation. For example:

- **Hand bicycles** allow individuals to participate in cycling activities without the use of their legs, but the small muscles of the arms require a much finer gradation of gearing and current designs require a low seating position with less visibility. Scenic lookout points on multi-use trails often do not take the inability of hand bike riders to walk into consideration.
- A **saddle with back supports** can enable people with paralysis or limited strength or balance to ride horses. However, they may be unable to dismount during the ride. For example, someone who uses a wheelchair may not be able to dismount and walk while they traverse a steep hill or very narrow trail.
- Biathlon is a combination of cross-country skiing and shooting. Individuals with a vision impairment participate in the target shooting phase by using **headphones connected to a laser light** that generates audible tones to identify the target.



**Figure 2-13.** Hand bicycles are an example of an activity-specific technology that allows a person with a mobility impairment to participate in cycling.



- **Mountain-bike tires** make it much easier to ride on unpaved surfaces. However, they also increase the rolling resistance of a bicycle or wheelchair and, therefore, increase the amount of energy that will be needed to pedal or push a given distance.

and an at-grade entrance will ensure that the restroom is accessible to a broader spectrum of users.

Examples of sidewalk and trail environmental technologies that benefit individuals with impairments include accessible pedestrian signals, curb ramps, elimination of glare, stabilized trail surfacing, and detectable warnings. The use of environmental technologies and the principles of universal design are the cornerstones for designing high quality pedestrian facilities. Incorporating environmental technologies, particularly those that benefit the broadest spectrum of users, into the sidewalk or trail environment should be every designer's priority.

As with all types of technology, environmental technologies may have a positive or negative impact on a particular user. For example:

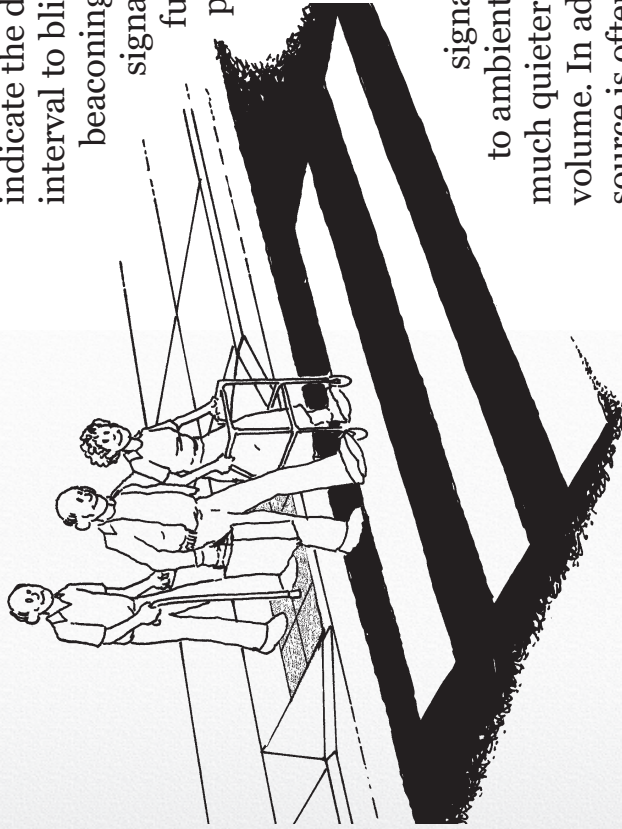
- Traditional **audible pedestrian signals** in the U.S. emit loud tones, bells, buzzes, or bird calls from the pedestrian signal head during

### 2.6.3 Environmental technologies and design

Environmental technologies are modifications or designs of a space or environment to increase its usability. Universal design requires the insightful use of environmental technologies to create environments with greater access for everyone. The application of universal design principles focuses on the use of environmental technologies that enhance the participation of users with a broad range of abilities. For example, toilet facilities may be provided on a trail for the comfort of users and protection of the environment. The use of environmental technologies and designs such as a larger clear floor space, accessible door handles,



the walk interval that are intended to serve as audible beacons to the opposite corner, as well as to indicate the duration of the walk interval to blind pedestrians. The beaconing function of these loud signals has been found to function relatively poorly, and their noise is often annoying to people living and working in the area.



**Figure 2-14.** Curb ramps in the sidewalk environment provide for an easier transition from the curb to the street for people with mobility impairments, and detectable warnings placed appropriately at the bottom of the ramp aid people with visual impairments in recognizing the transition from the sidewalk to the street.

harder to negotiate for people who use crutches or canes, or who have limited balance on sloped surfaces.

- **Bulletin boards** are often used to convey information to users at the trailhead. However, posting documents with regular size print makes it difficult for people with low vision or people standing at a distance to read the information. Similar problems may be encountered by individuals with limited English language skills (e.g., people who do not speak English or people with cognitive impairments) if the written language is very complex.

#### 2.6.4 How does technology influence design?

In order to design high quality, accessible environments, it is necessary to have an understanding of the types of environmental technologies that can be incorporated into the universal design process, and how the use of personal or

activity-specific technologies may impact the abilities of the user.

The knowledgeable and thoughtful use of environmental technologies will create pedestrian environments with universal access to people of all abilities. This practice of universal design is

increasingly recognized and encouraged to allow all persons, with or without disabilities, to move more freely, independently, and safely in outdoor environments.

The impact of some types of impairment can be mitigated to a certain extent through the use of personal or activity-specific assistive technologies. While it is recognized that an environment can never be fully and independently accessible to every possible user, many pedestrians can utilize personal or activity-specific technologies to

enhance their ability to function within the environments that designers create. These types of technology can assist people with impairments to become more independent, however individuals may not have access to these technologies and, therefore, the first priority should always be the use of environmental technologies and the universal design process.

Many types of assistive technologies, such as walking aids, improve mobility but do not eliminate the need to design and construct accessible environments. During the design process, it is helpful to have knowledge about the many types of assistive technologies that could be used on sidewalks and trails. The needs and abilities of each user will vary depending on the performance characteristics of any particular type of technology. The benefits obtained from a particular type of technology will also be influenced by the skill, experience, and ability of the user, as well as the characteristics of the environment. For example, there are a wide variety of wheelchairs for individuals with mobility impairments. The outdoor



**Figure 2-15.** This manual mountain bike wheelchair, with its longer wheel base, is significantly more effective on rugged terrain than a traditional hospital style manual wheelchair.



environment performance characteristics of the traditional, hospital-style manual wheelchair are very different from the mobility that can be achieved using a powered wheelchair specifically designed for rugged, outdoor environments.

Personal, activity-specific, and environmental technologies are interdependent. The choice of a personal, activity-specific, or environmental solution will depend on specific parameters of the barrier, such as its location or availability for public use. For instance, a person who is paralyzed may use a wheelchair as a personal technology. However, to use a sidewalk or shared-use path effectively, environmental modifications, such as curb ramps also need to be provided.

If the same person chose to use a more rugged recreation trail, an activity-specific technology, such as a mountain-bike wheelchair might be required. Understanding the interdependent relationship between the environment, the required activity, and the abilities of the person is an important fundamental step in the ability to design effectively for the future.

Selecting a wheel design and technology is a decision based on ability, type of usage, and, often, cost. Manual chairs and power chairs maneuver differently in turns and changes in level. Manual chairs have advantages of being portable, generally smaller, lighter in weight, require less maintenance, and generally cost less. A manual chair allows the person with the upper body ability to stay physically active, but power chairs can be more effective on steeper grades.

### 2.6.5 Limitations of technology

Despite the tremendous benefits provided by assistive technology, there are major limitations related to the essential use of assistive devices to overcome barriers within the environment.

- The cost of most assistive devices makes them unavailable to many people, especially for the disproportionate number of people who have disabilities that do not have jobs and/or live in poverty;

- Even with the use of the most sophisticated forms of assistive technology, the individual still needs many skills and abilities to have independent mobility in the community. For example, a person who uses a power wheelchair for mobility must have the cognitive and physical abilities to operate the wheelchair safely and effectively;
- The usability of the technology must also be considered. In many cases, existing technology can perform a similar but somewhat different function than the function that has been lost as a result of the impairment. For example, a long white cane can be used to avoid obstacles on a sidewalk, but cannot actually replace the functions of human vision;
- Reliability is also a major factor for consideration. It is relatively unlikely that your legs will suddenly and completely stop functioning. However, a flat tire or a loss of battery power can instantly immobilize some types of technology; and
- Portability is a significant factor for individuals who drive, ride as passengers, or take taxis. Powerchairs weigh hundreds of pounds and do not fold.
  - For these reasons, and many others, the use of personal or activity-specific assistive technology cannot be assumed and should not be considered to be an alternative to appropriate, high quality, and accessible designs.

# Sidewalk Development

- Chapter 3: Integrating Pedestrians into the Project Planning Process
- Chapter 4: Sidewalk Corridors
- Chapter 5: Driveway Crossings
- Chapter 6: Providing Information to Pedestrians
- Chapter 7: Curb Ramps
- Chapter 8: Pedestrian Crossings
- Chapter 9: Traffic Calming
- Chapter 10: Sidewalk Maintenance and Construction Site Safety
- Chapter 11: Sidewalk Assessment





# 3 INTEGRATING PEDESTRIANS INTO THE PROJECT PLANNING PROCESS

## CHAPTER

# Integrating Pedestrians into the Project Planning Process

Sidewalks are critical transportation routes for communities. They allow pedestrians to travel from one place to another, stimulate business districts by encouraging leisure shopping, and keep communities safe by providing more activity on the street. Integrating pedestrians, including pedestrians with disabilities, into the project planning

process is critical to the success of a transportation network. Too often transportation policies focus on the needs of motorists and do not consider the needs of pedestrians. Similarly, accessibility is often thought of as a separate issue to be addressed after the planning and development process is complete.

In order to improve transportation systems for people with disabilities, accessibility should be integrated into the project planning process. Access should be addressed at the beginning of the public involvement process and throughout project development. Transportation agencies must carefully reexamine existing



**Figure 3-1.** People with and without disabilities should be actively involved throughout the entire project planning process.



# 3 INTEGRATING PEDESTRIANS INTO THE PROJECT PLANNING PROCESS

## CHAPTER

policies and programs to determine if they are discriminatory. Furthermore, accessibility issues need to be addressed throughout an organization. Changes are difficult in bureaucracies, but unless accessibility issues are institutionalized throughout an organization, people with disabilities will be denied the mobility that the rest of the population takes for granted. Mobility is a basic right and it is the responsibility of transportation agencies to guarantee this right by ensuring that physical barriers are removed, audible and visual information is provided, and facilities are maintained to be fully accessible. Accessible design is the basic tenet pedestrian design, and all project design should apply accessible design fundamentals and overlay best practices. This principle assures that facilities will be usable and safer for all pedestrians. If a facility is not accessible, it is most likely not safe.

The planning process, referred to in this chapter, pertains to project development planning, including pedestrian system planning, public

outreach, land use considerations, and preliminary facility designs. Many transportation projects involve not only the decisions of transportation agencies, but associated agencies, politicians, developers, local businesses, and citizens. In order to ensure that all pedestrians are considered throughout the planning, development, and installation processes, interested parties must redefine internal goals and allocate the necessary resources to integrate accessibility into all transportation programs and projects.

### 3.1 Recent legislation

During the 1990s, several key pieces of legislation were passed that impacted transportation planning. The first piece of legislation was the Americans with Disabilities Act (ADA) of 1990, which protects the civil rights of people with disabilities. Secondly, the 1991 reauthorization of the Federal transportation policy, the Intermodal Surface Transportation Efficiency Act (ISTEA), specifically called for

# 3 INTEGRATING PEDESTRIANS INTO THE PROJECT PLANNING PROCESS

## CHAPTER

mainstreaming pedestrian travel into the transportation system. ISTEA increased the Federal-aid funding options for pedestrian facilities and programs. This allowed communities the ability to make a wide range of planning and funding decisions regarding the allocation of their Federal transportation dollars. In 1998, the Transportation Equity Act for the 21st Century (TEA-21) extended the opportunities established in ISTEA and increased funding for pedestrian facilities. However, even with these landmark laws, there are still gaps at the local level (where transportation decisions are made) between increased Federal-aid funding and the ADA requirements for pedestrian accessibility.

### 3.1.1 Americans with Disabilities Act (ADA)

As public entities covered under Title II of the Americans with Disabilities Act (ADA), transportation agencies are required and have a major responsibility to implement accessibility in their facilities

and programs. Although some cities have developed innovative approaches to upgrading their facilities to meet the needs of people with disabilities, many cities still lack accessible transportation networks.

The Title II Implementing Regulations for the ADA require all newly constructed and altered facilities (including sidewalks) must be readily accessible to people with disabilities (Section 1.4.1). Transportation agencies are responsible for developing a transition plan for existing sidewalk networks to identify accessibility deficiencies in the facilities and establish a schedule for improvements. In order to be effective, a transition plan (required to be completed by January 1995) should be integrated into the transportation element of a city's capital improvement program (CIP), and other local improvement and funding programs.

### 3.1.2 Federal transportation legislation (ISTEA and TEA-21)

ISTEA called for a more balanced focus of transportation planning and



# 3 INTEGRATING PEDESTRIANS INTO THE PROJECT PLANNING PROCESS

## CHAPTER

investment decisions. TEA-21, signed into law June 1998, builds on the many changes made by ISTEA. Because of ISTEA and TEA-21, planners have started to obtain more input from local users, which has led to the development of transportation facilities that better meet the needs of local users, including underserved communities, such as people with disabilities.

### 3.2 Prioritizing pedestrian access

Pedestrians are an integral part of the transportation system and should be equally prioritized with other modes, such as automobiles. For example, the decision to design a corner with a wide turning radius to benefit trucks should be carefully weighed against the negative impacts that wide turning radii have on pedestrians. Institutionalized standards, policies, design guidelines, and public participation should provide all pedestrians equal service within the transportation system.

There is a lack of knowledge on the part of transportation providers and public

policy sectors regarding the needs of pedestrians. Transportation planners and engineers often do not receive formal training on pedestrian issues and designs. This has contributed to transportation systems that encourage motor vehicle use and discourage walking. University courses should be developed that teach students how to balance the needs of all users and to design universally accessible pedestrian environments. Workshops and training materials should identify pedestrian needs at the beginning and the end of transportation planning in order to create accessible pedestrian networks. Agency employees and decisionmakers have a responsibility for raising awareness and educating the public about the need for accessible facilities.

#### 3.2.1 Sidewalk installation

When landuse plans have development activities (e.g., business and residential areas and school trips), pedestrian activities should be anticipated. Accessible design is a requirement and

# 3 INTEGRATING PEDESTRIANS INTO THE PROJECT PLANNING PROCESS

## CHAPTER

does not depend on the number of users.

Practice in accessible design should be as advanced as vehicle usage design.

When sidewalks are not available, pedestrians are forced to share the street with motorists, access to public transportation is restricted, and children have fewer play areas that are safe. Therefore, whenever possible, accessible sidewalks should be provided. The following guidelines have been established to assist local jurisdictions with determining when and where pedestrian facilities are needed (*Planning, Design, and Operation of Pedestrian Facilities: Unpublished Draft Final Report* (2000), NCHRP, Project 15-20, TRB, Washington, D.C.):

- Develop sidewalks as integral parts of all city streets;
- If landuse plans anticipate pedestrian activity, construct sidewalks as part of street development;
- Sidewalks should connect nearby urban communities;

- Provide sidewalks in rural and suburban areas at schools, local businesses, and industrial plants that result in pedestrian concentrations;
- Provide sidewalks whenever the roadside and land development conditions are such that pedestrians regularly move along a main or high-speed highway;
- Incorporate sidewalks in rural areas with higher traffic speeds and general absence of lighting; and
- Construct sidewalks along any street or highway without shoulders, even if there is light pedestrian traffic.

To initiate the sidewalk installation guidelines above, and to promote accessible sidewalk facilities, municipalities should consider the following recommendations:

- Agencies should only accept bids from contractors who understand and construct accessible facilities;



# 3 INTEGRATING PEDESTRIANS INTO THE PROJECT PLANNING PROCESS

## CHAPTER

- Require employees and contractors to demonstrate their knowledge of accessibility topics. If at any stage of the development process (i.e., planning, design, or installation) accessibility is not addressed, hold the responsible party accountable, and make improvements;
- Engineering, transportation, and public policy decision makers should partner with transit providers on projects and programs, and require that transit systems include accessible pedestrian facilities;
- Consult with representatives from disability agencies and organizations during all phases of project development;
- Include people with disabilities in the first phases of programming, planning, designing, operating, and constructing pedestrian facilities (see Section 3.8); and

- Agencies should ensure that accessible guidelines are followed throughout planning, the project development, and construction of pedestrian facilities.

### 3.2.2 Pedestrian oriented detail

Installing sidewalks is critical to providing pedestrian access. However, prioritizing the needs of pedestrians extends beyond the basic step of providing a sidewalk network. The quality of the pedestrian experience should also be addressed during the project planning process. The first step towards providing a quality pedestrian experience is to provide a buffer zone that separates the pedestrian from the motorist. This can be accomplished by providing a wide sidewalk or a sidewalk setback, such as a planting strip. In addition, planners and designers should consider the following pedestrian oriented details:

- Attractive building facades (e.g., pedestrian scale, street oriented windows and building entrances);

# 3 INTEGRATING PEDESTRIANS INTO THE PROJECT PLANNING PROCESS

## CHAPTER

- Street trees and landscaping;
- Benches;
- Pedestrian oriented signs and traffic control devices; and
- Public art.

When pedestrian details are included, pedestrians are more comfortable using the sidewalk facilities, neighborhoods are safer because there are more people out in the community, and commercial areas thrive.

### 3.2.3 National policy

To address the goal of effective transportation networks, Federal transportation legislation calls for the mainstreaming of pedestrian projects into the planning, design, and construction of the national transportation system. As a result, the Federal Highway Administration (FHWA) has developed a policy statement regarding the integration of walking into the transportation

infrastructure. The policy statement was developed in cooperation with other agencies and organizations that address pedestrian issues, such as the American Association of State Highway and Transportation Officials (AASHTO) and the Institute of Transportation Engineers (ITE). The key principle included in the policy statement specifies that “bicycling and walking facilities will be incorporated into all transportation projects unless exceptional circumstances exist” (Federal Highway Administration, 2000). This is the principle for Federal-aid Highway Programs that State, regional, and local transportation agencies should use in their planning process.

### 3.2.4 State and local sidewalk policies

There is significant work to be done to ensure that the recent FHWA policy on mainstreaming nonmotorized transportation is institutionalized at the State and local levels. Transportation policies should be reexamined by State and local governments, and programs should



# 3 INTEGRATING PEDESTRIANS INTO THE PROJECT PLANNING PROCESS

## CHAPTER

be developed that provide resources for constructing and maintaining an accessible pedestrian network.

Within many State and local agencies, it is difficult for pedestrian projects to compete with the priorities that have been placed on automobile travel. Some States do not allow State transportation funds to be used for sidewalk construction or maintenance, reserving the funds for roadway use only.

At the local level, many cities do not systematically require sidewalk installations on new roadway projects, or they may leave installation details to the discretion of local developers. This lack of guidance often leads to narrow walkways, obstacles in the path of travel, and other design practices that do not adequately meet pedestrian needs. To address this issue, local standards for sidewalk design guidelines should be created and must be followed by developers and others responsible for sidewalk installation.

Maintenance of sidewalk facilities is also a significant problem in many localities. While some transportation

agencies take responsibility for sidewalk maintenance, others hold property owners accountable. It is recommended that sidewalk maintenance should be the responsibility of the transportation agency and should be carried out using strategies similar to road maintenance.

### 3.3 Local land use and zoning

There is a strong connection between transportation planning and land use regulations. The content of land use regulations can encourage an accessible pedestrian network if pedestrian needs and mobility issues are incorporated into the development of local zoning and subdivision ordinances. Land use decisions are most often made at the local level. Although State regulations impact zoning, town and city regulations generally allow local decisionmakers to guide development.

The following sections are based on a report prepared for the Transportation Research Board entitled, *Planning, Design, and Operation of Pedestrian Facilities: Unpublished Draft Final Report* (2000).



# 3 INTEGRATING PEDESTRIANS INTO THE PROJECT PLANNING PROCESS

## CHAPTER

### 3.3.1 Traditional land use patterns

Traditionally, zoning ordinances have eliminated mixed-use developments and separated urban and suburban areas based on designated use and specified allowable densities. These practices have led to increased dependency on automobiles and longer trip distances. Similarly, subdivision ordinances have focused on the motor vehicle as the primary mode of transportation. Typically, subdivision ordinances lack requirements for sidewalks on streets and pedestrian connections between the street and building entrances.

Also, the zoning and subdivision restrictions of a locality may limit a designer's ability to maximize sidewalk accessibility. For example, a designer of a new sidewalk may intend to create an accessible facility. However, the designer may be unable to do so if the subdivision regulations do not allocate sufficient right-of-way to make pedestrian facility accessible. Municipalities have an obligation under Title II of the ADA to

make the newly constructed and altered facilities readily accessible. According to the ADA Title II Implementing Regulations, "a public entity shall make reasonable modifications in policies, practices, or procedures when the modifications are necessary to avoid discrimination on the basis of disability."

### 3.3.2 Land use recommendations

The following recommendations promote an accessible pedestrian environment and should be considered during a locality's review of its zoning ordinance:

- Consider the needs and functions of pedestrians, including pedestrians with disabilities, during the development of zoning regulations;
- Allow mixed use developments with higher densities so that trip distances are decreased and walking is promoted as a mode of transportation;

# 3

# INTEGRATING PEDESTRIANS INTO THE PROJECT PLANNING PROCESS

## CHAPTER

- Increase the allowable densities near major destination points and transit lines to discourage the use of vehicles as the primary mode of transportation; and
- Require all commercial districts containing shopping and employment centers to have accessible building entrances and an on-site circulation system of accessible walkways.

The following recommendations promote an accessible pedestrian environment and should be considered during a locality's review of its subdivision ordinance:

- Require site developers to include accessible pedestrian facilities early in the site planning process, so local planners can coordinate with other planned transportation improvements;
- Include pedestrian-friendly street design principles and accessible sidewalk design principles as

- required components of a pedestrian network;
- Encourage enhanced connectivity between adjacent residential, commercial, and institutional developments;
- Develop specific design principles for accessible pedestrian connections between the street, buildings on site, and adjacent properties; and
- Require commercial developments to locate parking in the rear of building sites and to provide direct access to the front of the building from sidewalks and nearby transit connections.

### 3.4 Comprehensive planning

The transportation component of a region's comprehensive master plan (CMP) has a significant impact on transportation policy. If an assumption is made that individuals prefer to drive,



# 3 INTEGRATING PEDESTRIANS INTO THE PROJECT PLANNING PROCESS

## CHAPTER

communities will only be designed to accommodate motorists. Transportation systems that neglect pedestrian needs guarantee increased automobile use within the community, define the layout of the community, and determine local quality-of-life patterns.

Unless there is a specific strategy for funding new pedestrian projects, the need for these projects will often not be recognized. Therefore, for pedestrian projects to be implemented, they must be included in a city's capital improvement plan (CIP). Projects listed in the CIP are ranked for priority according to a specific scoring system. Accessibility projects can be listed in the CIP and should be included as part of larger projects. Traditionally, pedestrian projects have not ranked well because they are often small in scale. However, existing ranking systems should be reevaluated to consider areas where pedestrian projects rank very highly, such as public health and safety, maintenance, socio-economic impact, neighborhood impact, social justice, coordination with other projects, and land use.

### 3.4.1 Pedestrian master plans

To help guide long-term pedestrian planning, many municipalities are developing pedestrian master plans. Pedestrian master plans outline the framework of the pedestrian network and identify improvements that will enhance the pedestrian environment and increase opportunities to choose walking (with and without assistive devices) as a mode of transportation. Pedestrian master plans, such as the one adopted by the City of Portland in April 1998, outline policies, street classifications, design guidelines, capital projects, and funding strategies that affect pedestrians.

Transportation agencies should address accessibility in all components of a pedestrian master plan. The goal of the pedestrian master plan is to encourage walking as the preferred mode of transportation and, therefore, must consider the mobility and travel needs of all people. Integrating accessibility into pedestrian master plans is required by law and will avoid costly and time-consuming modifications to designs and installations

that provide pedestrian networks that work for people of all abilities.

### 3.4.2 Pedestrian design guides

Pedestrian design guides are a complementary component of the pedestrian master plan intended to ensure that all sidewalk facilities promote the objectives identified in pedestrian master plans. Pedestrian design guides are developed by transportation engineers to provide a uniform set of guidelines that are applicable to most situations and to further promote walking as a mode of transportation. Without thoughtful design guidelines, conflicts between competing functions may produce conditions that are less than ideal for pedestrians and, particularly, for people with disabilities.

Accessibility should be an integrated topic within pedestrian design guides. Every design specification should be consistent with the needs of people with disabilities. If accessibility is not integrated into the design guide, it will continue to be addressed as an afterthought.

### 3.5 Prioritizing resources

While all new construction should be planned and designed to meet accessibility standards, improvements to existing infrastructure that enhance accessible pedestrian networks should be prioritized by transportation planners, engineers, and agencies. Pedestrian improvements should be designed to achieve the maximum benefit for their cost, including initial cost and maintenance cost, as well as reduced reliance on more expensive modes of transportation. Where possible, improvements in the right-of-way should stimulate, reinforce, and connect with accessible transportation networks.

A good model is *Accessible Rights of Way: A Design Guide* (U.S. Access Board, 1999).

Redefining transportation planning to include pedestrian needs and accessibility requires new systems for prioritizing resources. An evaluation of existing conditions and feedback from public involvement sessions should provide planners with useful information about



# 3 INTEGRATING PEDESTRIANS INTO THE PROJECT PLANNING PROCESS

## CHAPTER

the community's pedestrian needs. This information should then be prioritized to ensure that the most beneficial improvements are made first. The following principles provide guidance to designers when planning access improvements and establishing priorities:

- Immediately address maintenance and safety problems, such as potholes or debris, in crosswalks and sidewalks;
- Immediately implement simple and inexpensive solutions, such as removing newspaper stands, trash receptacles, and other movable obstacles from the path of travel;
- Make accessibility improvements to existing facilities before other types of improvements, such as landscaping, because accessibility improvements are required by law;
- Review planned and funded projects to ensure that access has been included as required by the ADA;

- Add accessibility improvements to projects that are already planned and funded. Fixing everything at once saves money because equipment is deployed and contractors are hired on a one-time basis. In addition, pedestrian disruptions in construction areas can be minimized;
- Distribute funds among several less expensive projects that would have a greater overall impact on an area's accessibility, instead of consuming all allotted accessibility improvement money on one ideal but very expensive improvement;
- Make accessibility improvements whenever possible, not just when complete accessibility can be achieved. For example, if funding is available to improve the accessibility of one corner at an intersection, that corner should be improved even if the other corners are not accessible. Eventually, funding will be available to improve the accessibility of the remaining three corners;

# 3 INTEGRATING PEDESTRIANS INTO THE PROJECT PLANNING PROCESS

## CHAPTER

- Make it a priority to improve routes with high volumes of pedestrian traffic;
- Make it a priority to improve routes that serve as important links between key destinations;
- Make it a priority to improve areas with high population densities; and
- Prioritize specific request programs that respond to individual requests.

Many cities, such as Austin, Texas; Seattle, Washington; San Francisco, California; and Portland, Oregon, have extensive programs to improve accessibility in their communities. The Portland program focuses on adding access improvements to existing projects and making additional improvements to locations receiving heavy pedestrian use. Portland also takes about 100 specific requests per year for improvements from people with disabilities.

The City of West Palm Beach, Florida, has developed a long-range transportation plan based on the hierarchy of users. The needs of pedestrians are the number one priority in the West Palm Beach model. The goal of this project is to “reverse the current transportation paradigm, which has to a great extent neglected all users except the automobile, and begin a shift toward balance and equity” (Transportation Division, City of West Palm Beach, 1999).

### 3.6 Funding strategies

Almost every Federal-aid highway funding category may be used for building, altering, or improving accessible pedestrian facilities. It is up to each State’s Metropolitan Planning Organizations (MPOs) and localities to set priorities on how Federal-aid Highway funds are used. The following is a list of some of the provisions included in the Federal-aid Highway Program as amended by the Transportation Equity Act for the 21st Century (TEA-21) (U.S. Department of Transportation, 1998):

# 3 INTEGRATING PEDESTRIANS INTO THE PROJECT PLANNING PROCESS

## CHAPTER

- Surface Transportation Program (STP) funds may be used to construct pedestrian walkways or non-construction projects such as maps, brochures, and public service announcements related to safe pedestrian activities. Modification of public sidewalks to comply with the ADA is identified as an activity that is eligible for these funds.

- Transportation Enhancement Activities (TEAs) make up ten percent of each State's annual STP funds. TEAs are designated projects that will provide facilities for pedestrians, pedestrian safety, educational activities, and the conversion of abandoned railway corridors to pedestrian trails.

- Hazard Elimination and Railway-Highway Crossing programs, which also utilize ten percent of set-aside STP funds, may be used to correct locations that constitute a danger to pedestrians. States are required to implement this program, and

funding is applicable to survey hazardous locations, construct projects on any publicly-owned pedestrian pathway, or install safety-related traffic calming measures.

- National Highway System funds may be used to install pedestrian walkways on land adjacent to any highway on the National Highway System including Interstate highways.

Accessible pedestrian projects can also be funded through other Federal-aid Highway Programs including Federal Lands Highway Program, National Scenic Byways Program, Congestion Mitigation and Air Quality Improvement Program, Transportation and Community Systems Preservation Pilot Program (TCSP), and Job Access and Reverse Commute Grants. In addition, TEA-21 allows Federal transit funds to be used for pedestrian access improvement projects. These funds are to be used for investments that provide



“pedestrian and bicycle access to a mass transportation facility” for the establishment and enhancement of coordination between mass transit and other forms of transportation (U.S. Department of Transportation, 1998).

A identifies facilities that are free flowing with very efficient travel speeds and few interruptions. Level F represents streets with high congestion, low speeds, and many signalized interruptions.

Some transportation agencies are addressing the discrepancies in evaluating only the level of service for motorists. The Florida Department of Transportation is in the process of developing a multimodal level of service plan with guidelines for pedestrians. Streets that best serve motorists often do not serve pedestrians at all. For example, a Level A street for motorists could be a Level F for pedestrians, especially for people with disabilities.

To address the discrepancies between the needs of motorists and pedestrians, a balance should be created between the two modes. Pedestrian level of service models should be developed that include the following factors in addition to capacity:

- Accessibility
- Pedestrian safety and security on the sidewalk and in the crossing environment;

### 3.7 Site development

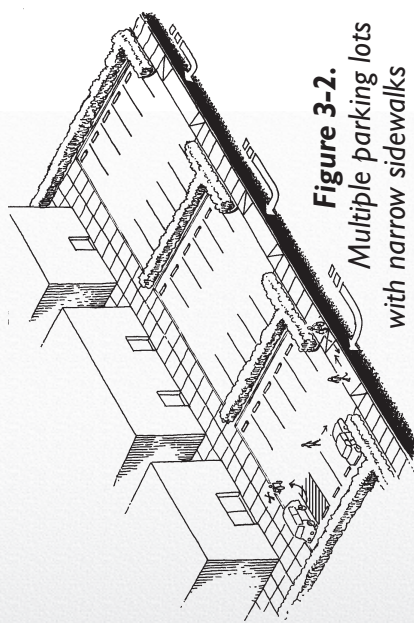
Site development focuses on planning and design issues on an individual project basis. Developing accessible sidewalk facilities at the project level is most effective when the needs of pedestrians are institutionalized into the planning process. If broader elements, such as land use and regional coordination, do not support pedestrian planning, individual projects become very challenging.

#### 3.7.1 Pedestrian level of service

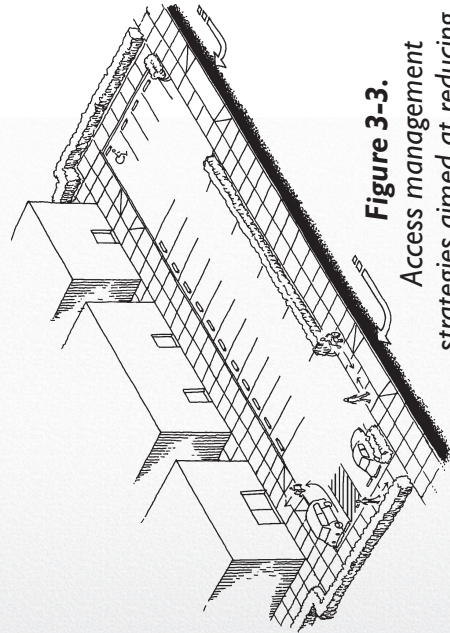
When developing a specific transportation project, the level of service for motor vehicles is often evaluated. The effectiveness of a transportation facility is evaluated on an A–F grading system. Level

# 3 INTEGRATING PEDESTRIANS INTO THE PROJECT PLANNING PROCESS

## CHAPTER



**Figure 3-2.**  
Multiple parking lots with narrow sidewalks provide a low quality pedestrian experience and increase the number of potential conflict points between motorists and pedestrians.



**Figure 3-3.**  
Access management strategies aimed at reducing the number of driveway crossings and increasing the width of the sidewalk corridor significantly improve the pedestrian experience.

- Convenience and connectivity to community destinations such as stores, businesses, transit, and other pedestrian linkages and attractions;
- Amenities such as aesthetically pleasing buildings and landscaping, shade, well-maintained and adequate sidewalks, and street furniture; and
- Comfortable street and sidewalk activity.

### 3.7.2 Access management

Access management regulates the movement of a variety of modes at key locations such as intersections, parking facilities, and alleys. Successful access management programs reduce or consolidate the number of driveways to parking areas and

businesses and provide raised medians to control vehicular turning movements (Washington State Department of Transportation, 1997).

Pedestrians benefit from access management policies because (Washington State Department of Transportation, 1997):

- The number of potential conflict points is reduced;
- Pedestrian crossing opportunities are enhanced;
- The number of driveway crossings is reduced; and
- Improved traffic flow may reduce the need for road widening, which, in turn, reduces crossing distances and allows more space for sidewalk facilities.

People with disabilities gain particular benefits from access management policies that reduce the number of driveway crossings in parking areas. In many suburban and some urban



shopping centers, commercial facilities are designed with parking lots in front of the store for the convenience of automobile drivers. Oftentimes, these parking lots are designed for the maximum parking needs (e.g., holiday shopping) and are larger than necessary for most of the year. In some locations, a row of stores may each have their own parking lot entrances and exits. Such locations seldom provide sidewalks. When sidewalks are provided, they are generally narrow, which forces wheelchair users to negotiate rapidly changing cross slopes at driveway crossings.

Access management policies aimed to improve a parking area should consider placing parking lots behind the building whenever possible. By doing this, people using the sidewalks do not have to travel through a parking lot of cars. Furthermore, pedestrian and automobile conflict points are reduced because the cars are not crossing over the sidewalk as they enter the parking facility. If parking in the back is not possible, access management policies should:

- Design accessible driveway crossings with level landings (see Chapter 5 for further details);
- Combine parking lots to limit the number of entrances and exits;
- Prioritize sidewalk construction;
- Provide a raised walkway between the sidewalk and entrances to reduce pedestrian exposure to automobile movement; and
- Control curb radius to keep turning speeds low.

### 3.7.3 Design constraints

Because sidewalks are located outdoors, they are influenced by more factors than if they were located in controlled indoor environments. Topography, weather conditions, and other unavoidable environmental constraints are among the many factors that influence site development. Although environmental constraints complicate

# 3 INTEGRATING PEDESTRIANS INTO THE PROJECT PLANNING PROCESS

## CHAPTER

design, they should not be used as an excuse to avoid making facilities accessible to people with disabilities. During the design stage of a project, each environmental factor should be carefully considered and creative solutions should be employed.

If environmental constraints are not addressed, the accessibility, usability, and funding of a facility will be compromised. For example, if a designer does not understand the topography of a site and fails to include a base map or profile of existing conditions in the construction plans, the sidewalk installer who may have no understanding of pedestrian and access issues may be making design decisions.

The ADA requires that alterations be accessible. Existing infrastructure and environmental constraints complicate the ability to create an accessible facility. Building and street design, as well as previously installed structures such as traffic poles and fire hydrants, all impact how easily designers can make accessibility improvements. The same creative engineering necessary to make improvements for motorists (e.g.,

add a vehicle lane, reconstructing an intersection) must be applied to accessible sidewalk and crosswalk design.

### 3.8 Public involvement

Both ISTEA and TEA-21 (Federal Transportation Legislation) encourage State and local governments to involve citizens in the transportation planning process. This allows the community to be involved in economic, environmental, and quality of life decisions. Involving pedestrians with disabilities in the planning process helps to improve accessibility in the community. Although citizens are not directly responsible for construction on public rights-of-way, they add a unique local perspective and personal experience to the planning process. For example, a resident might know of a better site for a playground or sidewalk than a regional planner who is less familiar with the area. In addition, citizens who live and travel in an area are often the best equipped to identify where transportation network problems exist.

# 3 INTEGRATING PEDESTRIANS INTO THE PROJECT PLANNING PROCESS

## CHAPTER

Benefits of involving the community early on and throughout the planning process, include:

- Plans that are more appropriate to the community can be developed;
- Community support for projects increases;
- Public opposition can be detected in the early planning stages;
- Possible conflicts can be mitigated through enhancements or compromises;
- Competing interest groups are able to better understand and resolve differences;
- Closer ties are forged between the agency and the community; and
- The threat of litigation is minimized.

### 3.8.1 Making accessibility provisions at public meetings

For public involvement to be successful, it is important to provide

opportunities for all segments of the community to participate in the process. The ADA requires that public agencies convene all meetings or breakout groups in accessible buildings. The following accommodations encourage participation:

- Provide assistance and/or greeters to help people with vision impairments locate the room within the building and sign in at the meeting;
- Provide sign language interpreters and/or assistive learning systems;
- Make written material, including maps, slides, or displays, available in Braille, large print (18 point font), electronic format, and/or audio cassette tapes;
- Position microphones and speaker platforms to accommodate wheelchair users;
- Locate meetings in a central area near public transportation routes whenever possible to accommodate



# 3 INTEGRATING PEDESTRIANS INTO THE PROJECT PLANNING PROCESS

## CHAPTER

- the large percentage of people with disabilities who rely on public transportation;
- Schedule meetings either early in the morning or in the evening to maximize the number of attendees; and
  - Notify agencies and organizations representing people with disabilities about meeting times, locations, and agendas.

### 3.8.2 Outreach strategies for initiating community involvement

People with disabilities can provide valuable input to all types of transportation projects. Their assistance is particularly crucial to ensure that mobility and accessibility needs are addressed. Even people with disabilities who may not have an understanding of accessibility requirements under the law can provide valuable descriptions regarding what has proven to be accessible or inaccessible for them. They can identify where linkages

and connections will serve their transportation needs and where existing improvements may be deficient. To increase participation by people with disabilities, agencies should use proactive outreach techniques. Good sources for contacting people with disabilities include:

- **ADA Coordinator/Citizen's Commission on Disabilities** — Every city is required to have an ADA coordinator who is often part of the mayor's office or human resources department. Most cities have a citizen's commission on disability.
- **National advocacy groups** — These groups are National organizations that represent the needs of people with disabilities. Many national advocacy groups represent people with disabilities as a whole, such as the Disability Rights Educational Defense Fund, while others represent specific disability groups such as the American Council of the Blind.



# 3 INTEGRATING PEDESTRIANS INTO THE PROJECT PLANNING PROCESS

## CHAPTER

- **Local advocacy groups** — Local organizations or local chapters of national advocacy groups that represent the needs of people with disabilities.
- **Veterans Administration (VA) offices** — Organizations located throughout the United States that provide medical and rehabilitation services to veterans of the U.S. Armed Forces.
- **Independent living centers (ILCs)** — Centers that help people with disabilities live more independently within society. Some also provide consulting services to people with disabilities and local agencies on access renovations and other accessibility improvements.
- **Rehabilitation centers** — Centers that provide ongoing rehabilitation services including physical, occupational, and speech therapy for people with vision, hearing, and mobility impairments.

Rehabilitation centers also prescribe and provide assistive technologies such as wheelchairs.

- **Retirement communities** — Independent or semi-independent housing communities catering to older residents. Some retirement communities provide residents with meal services, health care, and transportation.

Contact information for a variety of national organizations and advocacy groups representing people with disabilities is provided in Appendix C. Many of the organizations have local and regional branches and may serve as key resources for identifying local users.

### 3.8.3 Public involvement strategies

ISTEA's promotion of public involvement became the impetus for the development of more innovative and user friendly public involvement strategies. TEA-21 continued the emphasis on

# 3 INTEGRATING PEDESTRIANS INTO THE PROJECT PLANNING PROCESS

## CHAPTER

developing creative public involvement techniques. Participation by people with disabilities should be included in every public involvement strategy. Summaries of useful strategies are listed below (U.S. Department of Transportation, 1996).

**Transportation fair** — A one-day event used to generate citizens' interest in transportation issues and in specific projects and programs.

**Citizen surveys** — A written or verbal questionnaire distributed to a sample group of citizens representative of a larger group. Citizen surveys are effective because they are short and simple and do not require significant resources from the sponsor or participant. They provide agencies with an understanding of citizen perceptions and preferences. They can also provide agencies with a preliminary understanding of how the public will react to a proposed project. Transportation agencies can develop surveys targeted towards accessibility issues to gain a better understanding of the needs of local people with disabilities.

**Visual preference surveys** — A series of visuals showing various types of development and amenities used to obtain feedback about the aesthetic preferences of the community.

**Facilitation** — A group in which a neutral facilitator guides the members through the problem-solving process. To be effective, the facilitator should possess or obtain the following information:

- Past history of community and actions that have been controversial;
- An understanding of what is important to the community and neighborhoods;
- Knowledge of economic issues in the community; and
- An understanding of the current, aspiring, and transitional politicians' views.

During the planning process, the facilitator should:

- Meet with community and neighborhood leaders first;



# 3 INTEGRATING PEDESTRIANS INTO THE PROJECT PLANNING PROCESS

## CHAPTER

- Re-direct inappropriate issues to the appropriate office or person;
- Explain the time and reasonable outcome(s) of projects to avoid unrealistic expectations; and
- Synthesize the meeting information and repeat back to the community in a timely manner.

**Charrette** — A meeting focused on addressing a specific problem or issue. Participants work as a group to develop solutions to issues (e.g., new developments, traffic calming installations, pedestrian transportation improvements). Charrettes are effective community tools because all participants work through issues and create final solutions.

**Focus groups** — A small discussion group convened by transportation agencies to gauge public opinion on a specific issue. Because focus groups are generally informal and all ideas and opinions are accepted without criticism, they often generate fresh concepts and energy. Focus group members are selected

by the sponsor depending on the issue being discussed. For example, an agency needing to learn more about how people with visual impairments feel about detectable warnings on curb ramps would only invite people with visual impairments to participate (then would be surprised if wheelchair users later expressed concerns about decisions), but an agency interested in how accessibility should be incorporated into an agency's long-range plan would be more likely to convene a group consisting of people with and without disabilities.

### **Collaborative task force** —

A committee established to resolve a specific issue within a restricted time limit. Citizens are able to directly influence an agency's policies and provide officials with an understanding of the values and needs of the participants. Collaborative task forces are also helpful ways to resolve an impasse or controversy related to a project. Creating a collaborative task force regarding accessibility would be a unique way to empower people with disabilities and ensure they have a voice in the planning process.

# 3 INTEGRATING PEDESTRIANS INTO THE PROJECT PLANNING PROCESS

## CHAPTER

**Citizens' advisory committee** — A committee of interested parties that meets regularly to address common issues and concerns. Because participants meet on a regular basis, they are familiar with one another and the discussion topic. Citizens' advisory committees foster positive interactions between citizens and government, and provide a forum for agencies to present new goals and programs. Citizens' advisory committees are especially useful to agencies that are low on staff. Citizens' advisory committees are most successful when an agency liaison participates and the representatives are very dedicated and hold a variety of opinions. Citizens volunteering their time to an advisory board need to feel that their input is valuable; therefore, agencies should incorporate their feedback into the decisionmaking process. In some communities, citizens' advisory committees have been established to address ADA compliance and other accessibility issues.

The selection of the most appropriate public involvement technique depends on where the agency is in the planning process

and what type of feedback the agency needs. For example, a public survey might provide useful information in the early planning stages of a project, whereas an advisory committee might be more appropriate for in-depth planning discussions further into the development process.

### 3.8.4 Community involvement in sidewalk assessments

Sidewalk assessments that evaluate existing conditions can be useful in prioritizing future improvements. For detailed information, agencies should collect objective measurements using a methodology such as the Sidewalk Assessment Process, which is outlined in Chapter 11. However, if an agency's time or resources are limited, less intensive assessment strategies should be considered. For example, a subjective or objective accessibility checklist can be developed by the agency, that may include elements of the Sidewalk Assessment Process (Chapter 11). Citizens working individually or in organized groups can assist with the assessment of sidewalks



by participating in either the Sidewalk Assessment Process or by using agency checklists. Areas identified as problematic should be reevaluated by the agency at a later date. Regardless of the technique employed, it is very important for community participants to see changes made as a direct result of their assistance. It is extremely frustrating for citizens to identify problems that an agency has no intention of improving.

An example of a subjective accessibility checklist based on the *Walkability Checklist* developed for the U.S. Department of Transportation in 1997 is presented in Appendix B. This accessibility checklist may be reproduced or reorganized to meet the needs of

specific agencies. The accessibility checklist is intended to identify areas within the community that provide less than adequate pedestrian access. Anyone who has an interest in pedestrian facilities can provide valuable information using the checklist. However, people with disabilities may be able to provide the most useful information because they have firsthand knowledge of accessibility issues. Checklists should be translated into large text, Braille, and/or electronic format to accommodate people with vision impairments.

Many communities provide a telephone number where sidewalk problems can be reported and improvements requested. This source of assessment can be valuable to a Public Works department.

# 4 SIDEWALK CORRIDORS

## CHAPTER

### Sidewalk Corridors

“The Sidewalk Corridor is the portion of the pedestrian system from the edge of the roadway to the edge of the right-of-way (i.e., property line), generally along the sides of streets, between street corners” (Portland, Oregon, 1998). For the purpose of this guidebook, the width of the sidewalk corridor extends to the edge of the roadway, even if part of that area is not paved. Some other terms for the sidewalk corridor used in design manuals and legal documents include *border area*, *border width*, and *sidewalk*. Sidewalk corridors that promote access include the following characteristics:

- Clearly defined pedestrian, furniture, and frontage zones;
- Minimal obstacles;
- Minimal protruding objects;
- Moderate grades and cross slopes;
- Rest areas outside of the pedestrian zone;
- Minimal changes in level;
- Firm, stable, and slip resistant surfaces; and
- Good lighting.

In new construction, the commitment to create sidewalk corridors that meet the needs of people with disabilities should be made during the planning stages of the development process. For example, if sufficient right-of-way is not allocated to the sidewalk corridor during the planning process, it is harder for designers to construct curb ramps with level landings.



**Figure 4-1.** Wide sidewalk corridors significantly enhance pedestrian networks.

- Wide pathways;



# 4 SIDEWALK CORRIDORS

## CHAPTER

When access improvements are made to existing sidewalk corridors, designers should prioritize needs with available resources and try to make the most significant changes possible with the funds available.

### 4.1 Sidewalk corridor width

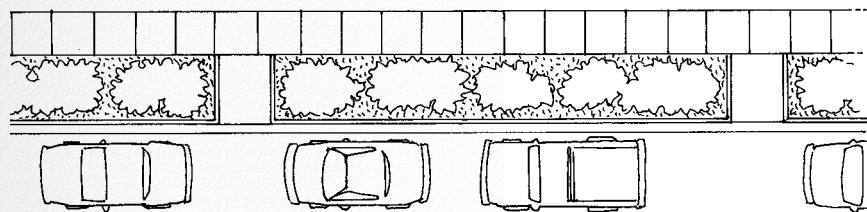
The width of the sidewalk corridor is one of the most significant factors in determining the type of pedestrian experience that the sidewalk provides (see Section 3.7.1). In many locations, the sidewalk corridor is paved from the curb to the property line. In other areas, the paved portion of the sidewalk corridor is set back from the street by a surface, such as grass,

which is not intended for pedestrian travel. Planting strips (sidewalk setbacks that are grass or another type of vegetative cover) provide:

- Shade
- Space for utilities and traffic control equipment and signs
- Space for trash cans and newspaper boxes
- Separation from roadway; and
- Aesthetic relief

Communities and individual property owners within residential areas are often willing to take responsibility for maintaining planting strips. However, if routine maintenance cannot be arranged, alternatives to planting strips, such as rock installations, are often used. Curb ramps should be provided along the planting strip accessible to on-street parking spaces.

Narrow sidewalk corridors are unsatisfactory because they limit the number of pedestrians that can use the area, require pedestrians to travel single file, and force pedestrians to travel uncomfortably close to buildings and/or automobile traffic. Access is easily



**Figure 4-2.** If on-street parking is permitted, periodic curb ramps along a planting strip can facilitate pedestrian access onto the sidewalk.

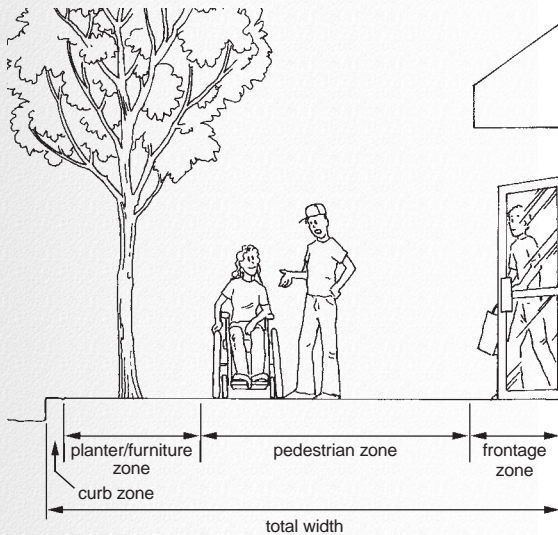
# 4 SIDEWALK CORRIDORS

## CHAPTER



**Figure 4-3.** Permanent obstacles, such as fire hydrants and street signs, should be relocated to improve a narrow sidewalk.

compromised on narrow sidewalk corridors by objects, such as utility poles, that create even narrower spaces. Sometimes, narrow sidewalks do not provide enough clear space for people who use walking aids or wheelchairs to travel down the length of the sidewalk. In addition, narrow sidewalk corridors often have driveway crossings with steep cross slopes and curb ramps with insufficient landings and/or steep ramp grades. Sidewalk corridor width is determined during the planning stage of a project. To develop a successful pedestrian network, that includes wide sidewalk corridors, the needs of pedestrians should be institutionalized into the project planning process (Chapter 3).



**Figure 4-4.** The zone system divides the sidewalk corridor into four zones to ensure that pedestrians have a sufficient amount of clear space to travel.

### 4.1.2 The zone system

To ensure that the needs of the pedestrian are prioritized, Portland, Oregon, has developed a design system that divides the sidewalk corridor into four zones (Portland Pedestrian Design Guide, 1998).

The zone system should be used to determine the width of the sidewalk corridor and to ensure that obstacles, such as newspaper boxes or utility poles, will not limit pedestrian access. The four zones within the sidewalk corridor are the:

1. Curb zone;
2. Planter/furniture zone;
3. Pedestrian zone; and
4. Frontage zone.

The width of the sidewalk corridor will be determined primarily by the width of the planter/furniture, pedestrian, and frontage zones. The size of the curb zone is generally constant throughout a municipality. Taking into account the minimum width of each zone, at least 2.59 m (8.5 ft) of right-of-way should be allocated to the sidewalk corridor. However, additional space is often needed to accommodate items such as pedestrian crossings, on-street parking, street cafés, and high pedestrian volumes. Table 4-1 contains recommendations for the minimum widths of each zone.

# 4 SIDEWALK CORRIDORS

## CHAPTER

**Table 4-1**

<b>Zone</b>	<b>Minimum Width</b>
Curb Zone	152 mm (6 in)
Planter/Furniture Zone	610 mm (24 in) [1.22 m (48 in) if planting trees]
Pedestrian Zone	1.525 m (60 in)
Frontage Zone	760 mm (30 in) *
Total Sidewalk Corridor	3.10 m (10 ft) *

\* If at least 760 mm (2.5 ft) of open space is available between the sidewalk corridor and the property line, no frontage zone is needed and the minimum recommended width for the sidewalk corridor is 2.285 m (7.5 ft).

At pedestrian crossings (e.g., midblock crossing or street intersections), the sidewalk corridor should be wide enough to install curb ramps with level landings. If the ramp is primarily in the planter/furniture zone, the pedestrian zone remains level. Although a variety of designs may be considered, a perpendicular curb ramp

that is oriented at a 90 degree angle to the curb is recommended for access from the pedestrian zone to the street (see Section 7.2.1).

### **4.1.2.1 Curb zone**

The curb zone is the first 152 mm (6 in) of the sidewalk corridor immediately adjacent to the roadway. It is an integral part of the drainage system and prevents excess water from collecting in the sidewalk corridor. The curb zone also discourages motor vehicles from driving onto the sidewalk corridor and is a valuable cue used by people with vision impairments to identify the border between the sidewalk corridor and the roadway.

### **4.1.2.2 Planter/furniture zone**

The planter/furniture zone lies between the curb and pedestrian zones and is intended to house utilities, such as traffic poles and fire hydrants, and pedestrian amenities, such as benches and bus shelters. The purpose of the

# 4

# SIDEWALK CORRIDORS

## CHAPTER



**Figure 4-5.** A minimum width of 1.525 m (60 in) is recommended for the pedestrian zone. This width should be completely free of obstacles and protruding objects.

planter/furniture zone is to ensure that the pedestrian zone will be free of obstacles. Depending on the design of the sidewalk corridor, the planter/furniture zone may or may not be paved. On sidewalk corridors where the sidewalk is set back from the street, such as when a planting strip is provided, the planter/furniture zone consists of the width of the unpaved area. On sidewalks that are paved from the curb to the property line, the planter/furniture zone is not as clearly defined.

If movable objects are originally placed in the planter/furniture zone, they may migrate into the pedestrian zone. Therefore, any movable objects should be chained or otherwise secured in place so that they cannot impede the flow of pedestrian traffic.

In addition to providing a location for sidewalk infrastructure, the planter/furniture zone also serves as a buffer between the pedestrian zone and the roadway. As a rule, pedestrians tend to avoid this area, even when it is free of obstacles, because it is uncomfortable for most people to walk near traffic.

To provide a sufficient buffer for pedestrians, the minimum recommended width is 610 mm (24 in). However, many cities with on-street parking allocate at least 915 mm (36 in) to the planter/furniture zone to separate objects from the curb face and to allow car doors to open and people to exit from the vehicle without entering or blocking the pedestrian zone. The planter/furniture zone next to on-street parking should have the areas adjacent to the vehicle doors free of obstacles.

If the sidewalk corridor is large enough or additional space is required for infrastructure, the width of the planter/furniture zone should be increased. Locations with transit stops will also require a larger planter/furniture zone. Transit requirements vary, however, the boarding pad is typically 1.525 m x 2.44 m (60 in x 96 in) and should be connected to an accessible pedestrian path of travel. Additional space may be required because wheelchair lifts on transit vehicles may extend up to 1.22 m (48 in) beyond the side of the vehicle. In addition to the boarding pad, an accessible bus shelter

# 4

# SIDEWALK CORRIDORS

## CHAPTER

**The planter/furniture zone buffers pedestrians from traffic and provides space for:**

- Utilities;
- Sidewalk furniture;
- Trees and grass; and
- Other sidewalk amenities.

may require an additional space up to 2.44 m x 3.96 m (96 in x 156 in) in size.

Areas that have significant accumulations of snow during the winter will also require a wider planter/furniture zone. A minimum width of 1.83 m (72 in) is recommended for areas where significant amounts of snow will be plowed onto the planter/furniture zone. This additional width will help keep the pedestrian zone free of obstacles, such as piles of snow.

In areas where all of the street planter/furniture and utilities can be placed away from the street in the adjacent property (e.g., on the front lawn in a residential area), the size of the planter/furniture zone may be reduced to 610 mm (24 in). The planter/furniture zone should not be completely eliminated because many pedestrians are not comfortable walking directly adjacent to the roadway. At a pedestrian crossing area, a planter/furniture zone is needed to ensure sufficient space between the curb and pedestrian zones for two perpendicular curb ramps. In very confined existing facilities, a reduction in the width of the

planter/furniture zone can be combined with the installation of parallel curb ramps (see Section 7.2.3 for information on parallel curb ramps). Trees need room to grow and spread roots (minimum 48 in). Trees should be selected for the space provided, and surface roots should not be removed. Realigning the sidewalk (see Figure 4-42) or ramping over the roots will provide access and protect the tree. See Section 4.4 for more information on trees.

### 4.1.2.3 Pedestrian zone

The pedestrian zone is the area of the sidewalk corridor that is specifically reserved for pedestrian travel. It should be completely free of obstacles, protruding objects, and vertical obstructions because they can be hazardous to pedestrians, particularly for individuals with vision impairments who may not be able to detect or avoid the hazard.

The pedestrian zone should be at least 1.525 m (60 in) wide. This provides sufficient space for two pedestrians to travel side by side without passing other



# 4 SIDEWALK CORRIDORS

## CHAPTER

**Table 4 - 2. Guidelines for New Sidewalk Installation**

Roadway Classification and Land Use	Sidewalk Requirements	Future Phasing
Highway (rural)	Min. of 1.525 m (60 m) shoulders required.	Secure/preserve ROW for future sidewalks.
Highway (rural/suburban – less than 1 d.u./acre)	One side preferred. Min. of 1.525 m (60 m) shoulders required.	Secure/preserve ROW for future sidewalks.
Suburban Highway (1 to 4 d.u./acre)	Both sides preferred. One side required.	Second side required if density becomes greater than 4 d.u./acre.
Major Arterial (residential)	Both sides required.	
Collector and Minor Arterial (residential)	Both sides required.	1.525 m (60 in)
Local Street (Residential – less than 1 d.u./acre)	One side preferred. Min. of 1.525 m (60 m) shoulders required.	Secure/preserve ROW for future sidewalks.
Local Street (Residential – 1 to 4 d.u./acre)	Both sides preferred. One side required.	Second side required if density becomes greater than 4 d.u./acre.
Local Street (Residential – more than 4 d.u./acre)	Both sides required.	
All Streets (commercial areas)	Both sides required.	
All Streets (industrial areas)	Both sides preferred. One side required.	

Final Draft: *Priorities and Guidelines for Providing Places for Pedestrians to Walk Along Streets and Highways.* FHWA (1999).



# 4

# SIDEWALK CORRIDORS

## CHAPTER

### Case Study 4-1

In New York City, if a new building is installed, the property owner is responsible for allocating a sidewalk area in front of the building that will accommodate the increased pedestrian traffic the new building will generate.

pedestrians, or for two people going in opposite directions to pass one another. In commercial and urban areas, pedestrian volumes are often much higher than in residential areas. The pedestrian zone should be expanded according to the Highway Capacity Manual based on the anticipated volume of users. In areas with heavy pedestrian traffic, the sidewalks should be wide enough to accommodate groups of pedestrians traveling in both directions. The expanded area should still remain free of obstacles. If additional utilities are necessary in an urban setting, the planter/furniture zone should also be expanded.

The pedestrian zone should never be less than 915 mm (36 in), which is the minimum width required for an accessible route (ADAAG 4.3.3, U.S. Access Board, 1991). The minimum width provides sufficient space for people who use mobility aids to travel within the restricted space, since most mobility devices have a maximum width of 710 mm (28 in). However, restricting the pedestrian zone to 915 mm (36 in) prevents passing and

does not account for two-way travel, traveling with a sighted guide 1.22 m (48 in) or with a guide animal. This minimum width is only acceptable when:

1. A wider width is impossible;
2. The narrow width continues for as short a distance as possible; and
3. Passing spaces are provided at intervals of no more than 61.0 m (200 ft).

### 4.1.2.4 Frontage zone

The frontage zone is the area between the pedestrian zone and the property line. Pedestrians tend to avoid walking close to barriers at the property line, such as buildings, storefronts, walls, or fences, in the same way that they tend to avoid walking close to the roadway. This is especially true in areas with many doorways that swing open into the sidewalk corridor. In most situations, the width of the frontage zone should be at least 305 mm (12 in). However, if the sidewalk corridor is adjacent to a wide open or landscaped space, such as in

# 4

# SIDEWALK CORRIDORS

## CHAPTER

### **Minimum Clear Width:**

*At least 915 mm (36 in) of clear space is necessary for people who use assistive devices such as wheelchairs, walkers, and crutches to maneuver along the sidewalk.*

### **The frontage zone separates pedestrians from store fronts and provides space for:**

- Sidewalk cafes;
- Window sills;
- Store entrances;
- Street vendors; and
- Doorways.

residential areas, the frontage zone can be eliminated.

Typically, the frontage zone is also the area in which sidewalk entertainment, such as street cafes and vendors, are located. Unless the frontage zone is physically separated from the pedestrian zone, it should be free of obstacles and protruding objects. People with vision impairments often travel in the frontage zone in order to use sound from the adjacent building for orientation. In general, pedestrians with vision impairments travel between 305 mm and 1.22 m (12 in and 48 in) from the building. Older pedestrians with vision impairments may travel closer to the building as their hearing deteriorates.

Any items in the frontage zone should be detectable by people with vision impairments who use long white canes for mobility. Obstacles that cannot be detected may result in a loss of balance or embarrassment when they are encountered unexpectedly. In the worst case, the collision could result in serious injury to the pedestrian. It is preferable for sandwich boards or other objects to

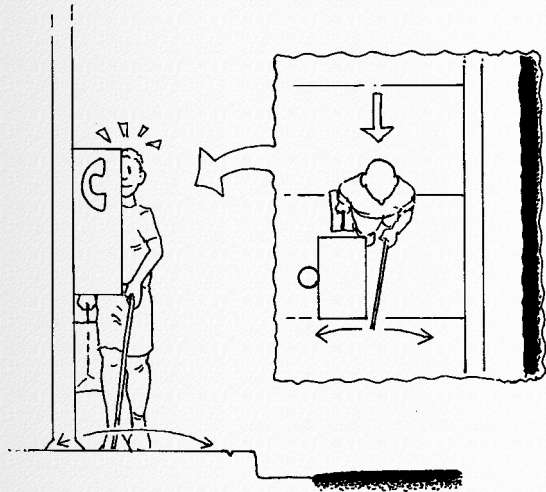
be solid and continuous with the ground surface throughout their length. In addition, solid barriers should be provided around street planter/furniture such as café umbrellas, tables, and chairs. Small chains suspended from intermittent posts are not sufficient because the long white cane can easily pass under the chain and between the posts. People using canes will detect barriers at ground level. These barriers should extend up from ground level less than 305 mm (12 in) and continue around the obstacle without any breaks or openings. Items that are wall or pole mounted must comply with ADAAG specifications for protruding objects (see Section 4.1.3).

### **4.1.3 Protruding objects**

Objects that protrude into the sidewalk corridor but are higher than 2.03 m (80 in) are not a problem for people with vision impairments because most pedestrians require less than 2.03 m (80 in) of headroom. In addition, people with vision impairments who use long white canes to navigate (if they are of adult

# 4 SIDEWALK CORRIDORS

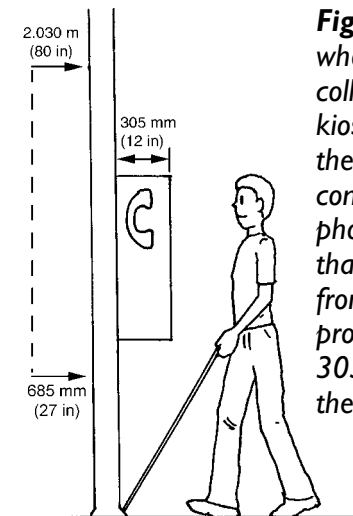
## CHAPTER



**Figure 4-6. POTENTIAL PROBLEM:** This pedestrian who is blind is approaching the telephone kiosk from the side. When obstacles mounted on posts can be approached from the side they should not protrude more than 101 mm (4 in). This pedestrian does not detect the obstacle, which could cause him to collide with the obstacle.

stature and using their canes skillfully) will usually detect and avoid objects on the sidewalk that extend below 685 mm (27 in). However, obstacles that protrude into the sidewalk between 685 mm (27 in) and 2.03 m (80 in) and do not extend to the ground, are more difficult to avoid because the long white cane is unlikely to contact the object before the person contacts the object. Guide dogs take their owners around obstacles.

Pedestrians with vision impairments often travel close to the building line.



**Figure 4-7.** This pedestrian who is blind is able to avoid colliding with this telephone kiosk because he detects the pole with a cane before coming in contact with the phone. Pole mounted objects that can only be approached from the front should not protrude more than 305 mm (12 in) into the sidewalk corridor.

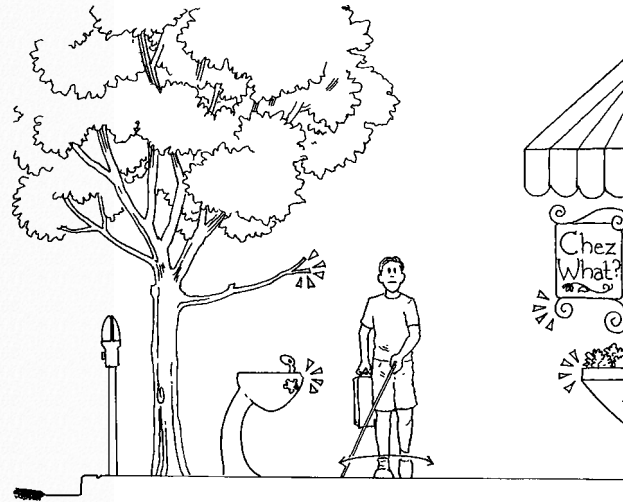
Therefore, according to ADAAG Section 4.4, if an object is mounted on a wall or the side of a building, it should not protrude more than 101 mm (4 in) into the sidewalk corridor (ADAAG 4.4, U.S. Access Board, 1991). If an object is mounted on a post that can only be approached from the front, it can protrude up to 305 mm (12 in) because the angle of the long white cane allows a pedestrian who is blind to identify the post before bumping into the protruding object. However, if the post-mounted object can be approached from the side, it should protrude no more than 101 mm (4 in) into the sidewalk corridor. Signs mounted on two posts should have a crossbar at 305 mm (12 in) above the walking surface so that a pedestrian using a long white cane can readily detect the sign. Stop signs mounted on a single post should be no lower than 2.03 m (80 in) or be placed outside of the paved portion of the sidewalk corridor (e.g., in a planting strip).

The least possible amount of protrusion should be used in each situation. Furthermore, because pedestrians with

# 4 SIDEWALK CORRIDORS

## CHAPTER

**Figure 4-8.** This pedestrian, who is blind, is walking down a sidewalk that contains a number of obstacles that are difficult to detect using a long white cane, because they protrude into the path of travel between 685 mm (27 in) up from ground level and below 2.03 m (80 in) in height.

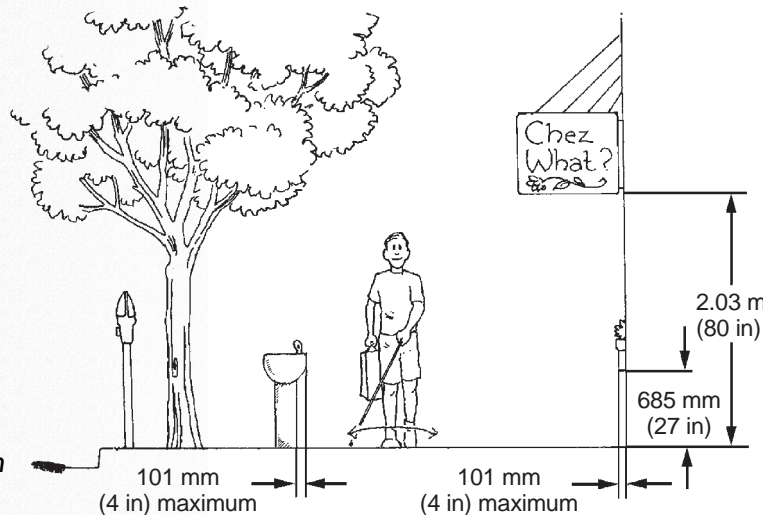


vision impairments do not always travel in the pedestrian zone, protruding objects should be eliminated from the entire paved portion of the sidewalk corridor. Protruding objects do not need to be eliminated from the planter/furniture zone if it is separated from the sidewalk with a planting strip or other type of setback.

### 4.1.4 Improving access on narrow sidewalks

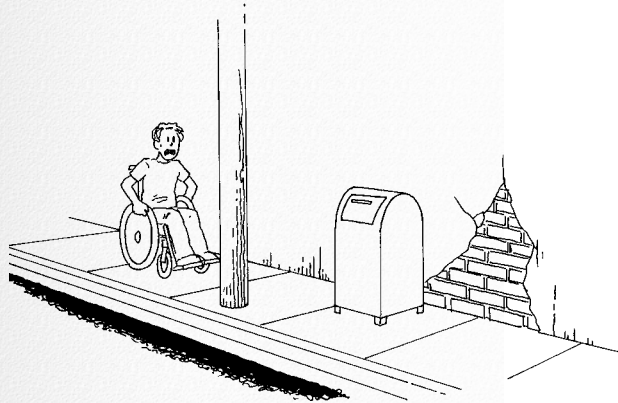
During new construction, at least 2.59 m (102 in) of public right-of-way should be dedicated to the sidewalk corridor. A minimum width of 2.285 m (90 in) should be allocated if at least 760 mm (30 in) of open space is available between the property line and the sidewalk corridor. However, if a narrow sidewalk corridor already exists, it can be improved. The highest priority should be to increase the pedestrian zone to at least 915 mm (36 in). The following solutions can help improve conditions for pedestrians with mobility and vision impairments. Additional solutions for installing curb ramps on narrow sidewalks are included in Section 7.4.5.

**Figure 4-9.** This pedestrian, who is blind, will have a much easier time traveling on this sidewalk because there are no walls or post-mounted obstacles that protrude more than 101 mm (4 in).

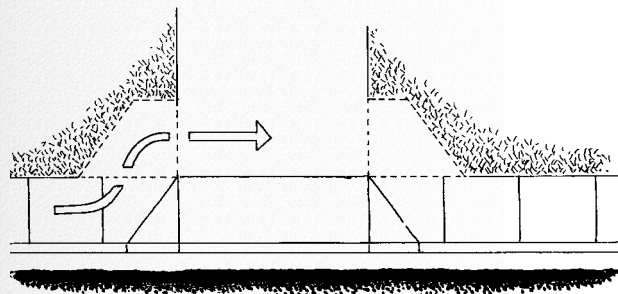


# 4 SIDEWALK CORRIDORS

## CHAPTER



**Figure 4-10.** Obstacles in the pedestrian zone limit the clearance width of the sidewalk.



**Figure 4-11.** Additional right-of-way allows the sidewalk to be jogged back, providing level landings at driveway crossings and curb ramps.

**SOLUTION 1** — Eliminate any removable and protruding obstacles, such as newspaper stands or tree branches, that limit the clear width of the sidewalk and/or protrude into the path of travel.

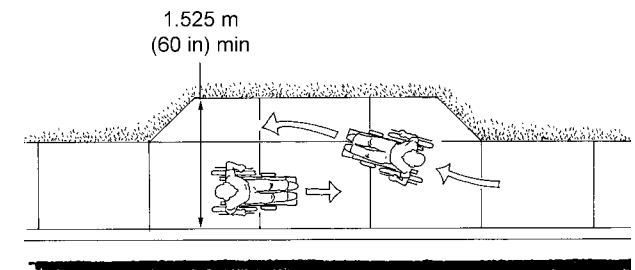
The first priority for improving a narrow sidewalk should be to eliminate any removable obstacles, such as trash receptacles and newspaper stands, from the pedestrian zone. Tree branches, overgrown shrubs, and other protruding objects should also be eliminated. Objects that are removed should be secured in their new location to prevent them from being moved back into the pedestrian zone.

**SOLUTION 2** — Eliminate permanent obstacles and protruding objects that limit the clear width of the sidewalk and/or protrude into the path of travel.

Whenever possible, permanent obstacles and protruding objects should be removed from the pedestrian zone. Locations where the passage width is less than 915 mm (36 in) should be prioritized.

**SOLUTION 3** — Secure additional right-of-way at driveway crossings and curb ramps to provide jogged landings.

Narrow sidewalks tend to have driveway crossings and curb ramps without level landings. These types of ramps are very difficult for people with mobility impairments to negotiate because of the severe change in cross slope across the flare (Section 5.1). Therefore, whenever possible, additional right-of-way should be purchased, or an easement should be



**Figure 4-12.** Additional right-of-ways provide passing spaces on narrow sidewalks.



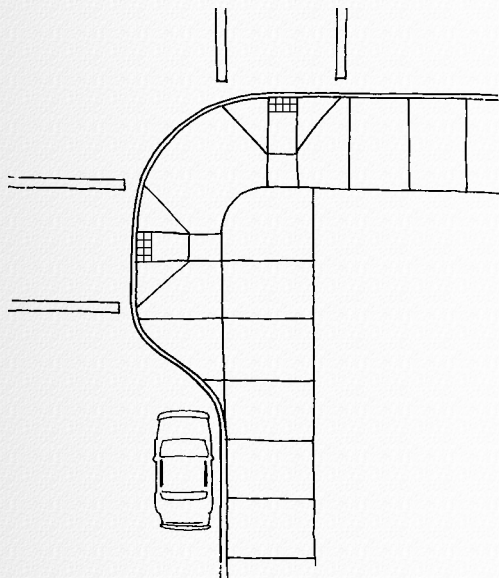
# 4

# SIDEWALK CORRIDORS

## CHAPTER

### Passing Space:

Passing spaces should be provided at intervals no less than 61.0 m (200 ft) apart and should be at least 1.525 m x 1.525 m (60 in x 60 in).



**Figure 4-13.** Curb extensions improve pedestrian visibility and provide additional space for level landings at curb ramps.

obtained from the property owner, at driveway crossings and curb ramps to add a level landing to existing elements. The purchase of additional right-of-way should also be considered at all locations where the pedestrian corridor is not large enough to provide an accessible path of travel.

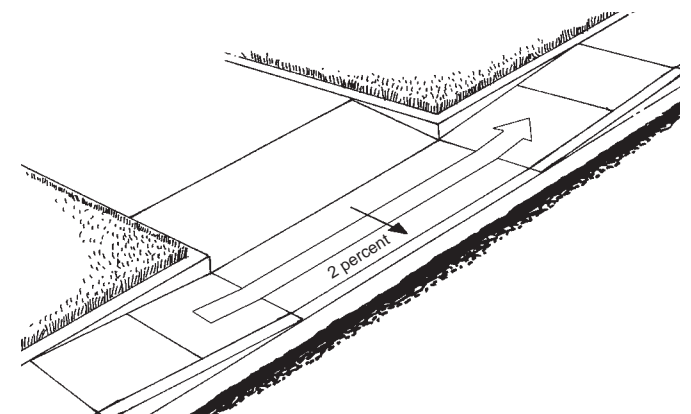
**SOLUTION 4** — Secure additional right-of-way to create periodic passing spaces which are at least 1.525 m x 1.525 m (60 in x 60 in).

If the sidewalk is less than 1.525 m (60 in) for an extended length, periodic passing spaces should be added to allow two wheelchair users to pass one another or to allow a single wheelchair user to turn around. Passing spaces should be provided at intervals no less than 61.0 m (200 ft) apart and should be at least 1.525 m x 1.525 m (60 in x 60 in). Driveway crossings and curb ramps with level landings can also serve as passing spaces.

**SOLUTION 5** — Extend the curb into the parking lane to generate more space for curb ramps.

Curb extensions provide a location for curb ramps on narrow sidewalks by expanding the width of the sidewalk at the corner. Curb extensions also prevent cars from parking in front of the curb ramp and improve visibility between motorists and pedestrians waiting to cross the street. Table 7-1 and Section 8.9 contain more information about curb extensions.

**SOLUTION 6** — Replace curb ramps and driveway crossings without level landings with parallel ramps.



**Figure 4-14.** Parallel ramps are an effective way to improve access at curb ramps and driveway crossings if additional right-of-way cannot be purchased. There needs to be adequate drainage for this type of installation.



# 4 SIDEWALK CORRIDORS

## CHAPTER

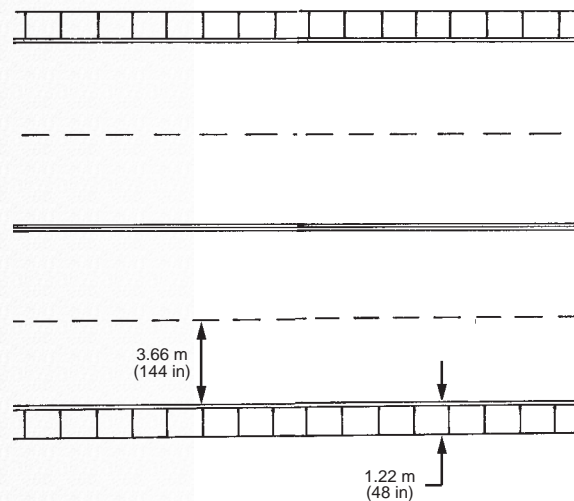
If additional right-of-way cannot be obtained, designers should consider replacing driveway crossings and curb ramps that do not have level landings with a style of ramp that is parallel to the curb. Although parallel ramps are more desirable than curb ramps or driveway crossings without level landings, they are not an ideal solution because they force users to go down and then up a ramp just to continue along the sidewalk. In addition, parallel ramps do not drain as well as other types of ramps. Section 7.2.3

contains more information about parallel curb ramps and Section 5.5 contains information about parallel driveway crossings.

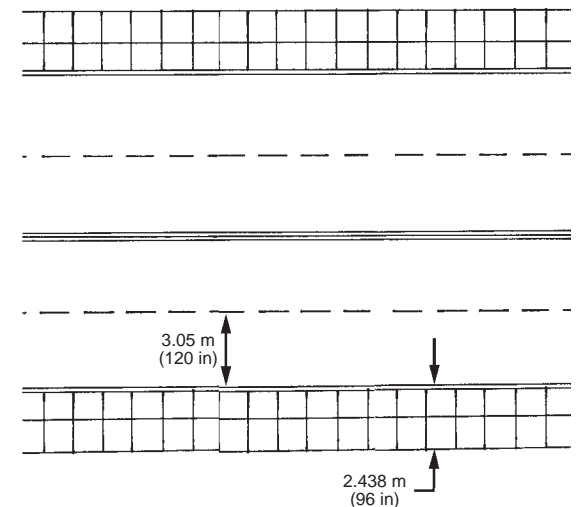
**SOLUTION 7** — Borrow from the street width to extend the sidewalk and create a wider path of travel for pedestrians.

Occasionally, additional width for a sidewalk can be created by reducing the width of the motor vehicle lanes. This

**Figure 4-15.**  
*BEFORE:* This roadway has very narrow sidewalks with wide motor vehicle lanes.



**Figure 4-16.**  
*AFTER:* If the motor vehicle lanes are narrowed, additional right-of-way can be added to the sidewalk. However, narrowing the outside lane is not recommended on streets used by bicyclists.



# 4 SIDEWALK CORRIDORS

## CHAPTER

### Case Study 4-2

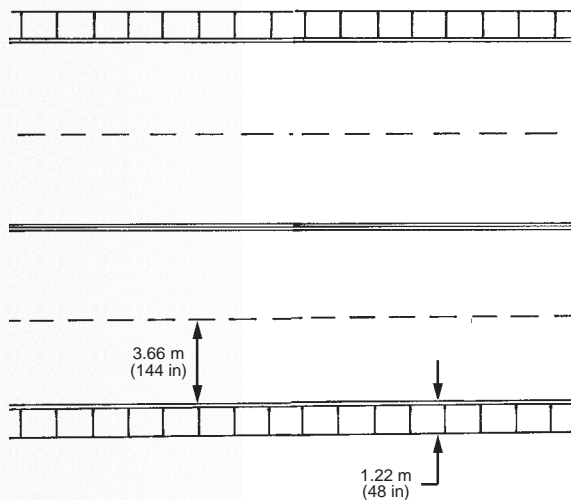
Seattle, Washington, has recently evaluated a series of four-lane to three-lane conversions to determine if traffic volumes were reduced. The results of the study showed that traffic volumes were not reduced and in several instances traffic volumes even increased.

solution should not be done without a careful operational analysis. On a four-lane road, reducing each traffic lane from 3.66 m to 3.05 m (12 ft to 10 ft) generates 2.44 m (8 ft) of additional space for the sidewalk. In addition, in residential areas, reducing the lane width will have a traffic calming effect because motorists tend to travel slower on narrower streets. In some situations, it may not be appropriate to reduce the outside lane to 3.05 m (10 ft) because of the negative impact on bicyclists.

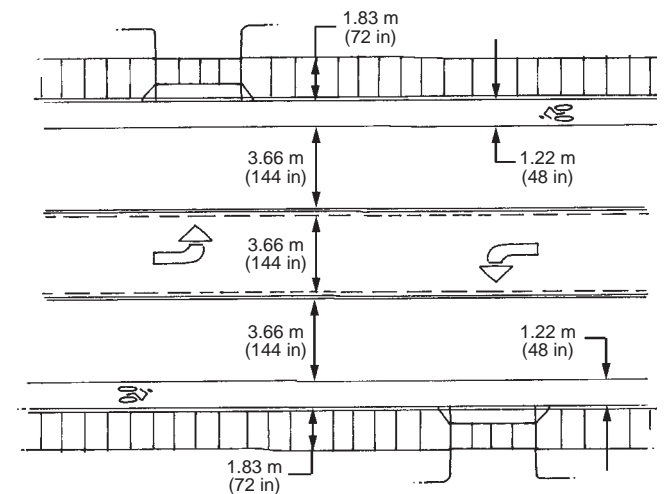
**SOLUTION 8** — Convert a four-lane road to a three-lane road and create a bike lane and a wider sidewalk.

A few cities have begun to experiment with four-lane to three-lane conversions to improve traffic flow and generate additional right-of-way for other users, such as bicyclists and pedestrians. This solution should not be done without a careful operational analysis. Converting to a three-lane road may not reduce the level of service the road provides to

**Figure 4-17.**  
*BEFORE:* This roadway has very narrow sidewalks with wide motor vehicle lanes.



**Figure 4-18.**  
*AFTER:* Converting the four-lane road to a three-lane road will allow for the addition of bicycle lanes and the widening of sidewalks.



# 4

# SIDEWALK CORRIDORS

## CHAPTER

### **Grade:**

*The grade of the sidewalk corridor is often determined by the grade of the street. Whenever possible, however, the grade of the sidewalk corridor should not exceed 5.0 percent.*

motorists. In addition, the extra lane width can be used to expand existing sidewalks that are too narrow and to add bicycle lanes. It is often beneficial to provide a median within the center lane where vehicles will not be making left turns to provide refuge for pedestrians crossing the street and to break up the lane so that it will not be used as a through lane.

chair. Both powered and manual wheelchairs can become unstable and/or difficult to control on sloped surfaces. Whenever possible, slopes should be minimized to improve access for people with mobility impairments.

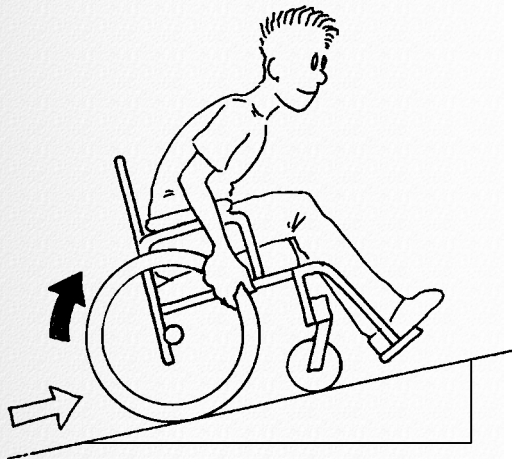
### **4.2.1 Grade**

Additional effort is required for mobility on steep grades. Manual wheelchair users may travel very rapidly on downhill pathways, but will be significantly slower on uphill segments. Steep running grades can be better tolerated by providing level segments at intervals. In addition, less severe grades that extend over longer distances may not tire users as much as shorter, steeper grades.

Grades are often difficult to control in the sidewalk environment because sidewalks follow the path of the street. In new construction, pedestrian use should be factored into the design plans. Where possible, routes should be designed with the least amount of grade in the terrain to minimize regrading. Sidewalk grades

## **4.2 Sidewalk grades and cross slopes**

Grades and cross slopes are very difficult for some people with mobility impairments to negotiate because it is harder to travel across sloped surfaces than horizontal surfaces. People with mobility impairments who are ambulatory or use manual wheelchairs must exert significantly more energy than other pedestrians to traverse sloped surfaces. Powered wheelchairs are affected by the additional work required on steep grades because more battery power is used. This reduces the travel range of a powered

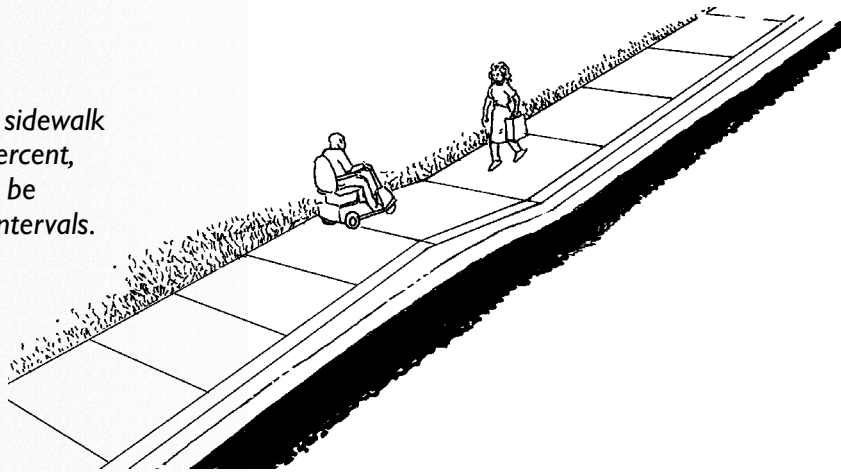


**Figure 4-19.** Steep sidewalk grades are a significant barrier to access for many pedestrians.

# 4 SIDEWALK CORRIDORS

## CHAPTER

**Figure 4-20.** If the sidewalk grade exceeds 5.0 percent, level landings should be provided at regular intervals.

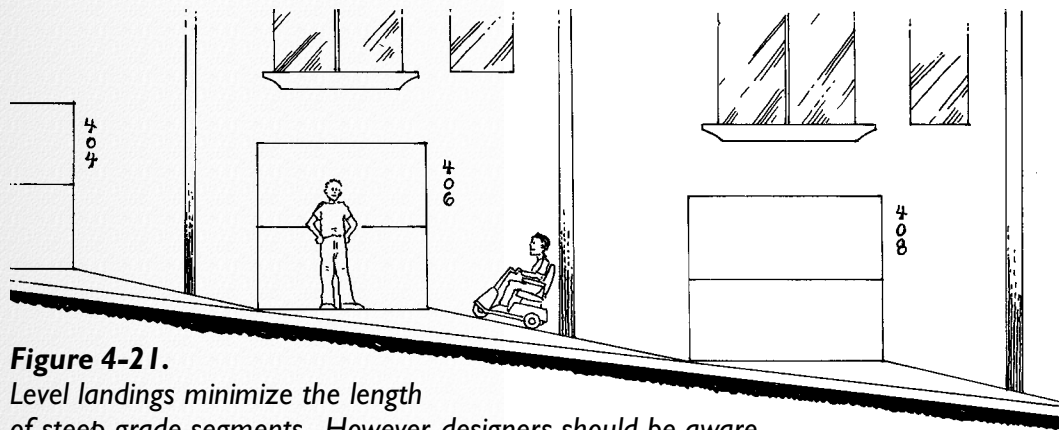


ideally should not exceed 5.0 percent, and the most gradual possible slope should be used at all times.

If excessive grades cannot be avoided, the following steps will help reduce the negative impacts of steep terrain:

**SOLUTION 1** — Limit the distance and magnitude of the grade segment and provide periodic level landings between segments of steep grades.

The distance and the magnitude of the grade segment are significant factors in determining who will be able to access the sidewalk. At a site, ADAAG allows a maximum ramp grade of 8.3 percent for a distance of 9.14 m (30 ft) before a level landing must be installed (ADAAG, U.S. Access Board, 1991). On sidewalks, however, it may not be possible to limit the sidewalk grade to 8.3 percent. At a building entrance, elevation changes are small and the duration of a maximum grade is relatively short. Maximum grades on sidewalks often continue for several blocks. Even if pedestrians can negotiate an 8.3 percent grade for short distances, they may not be able to continue on this grade for longer distances.



**Figure 4-21.** Level landings minimize the length of steep grade segments. However, designers should be aware that level landings will increase the grade in between landings and, as a result, the sidewalk grade will be greater than the grade of the street.



# 4

# SIDEWALK CORRIDORS

## CHAPTER

### **Level Landings:**

*The slope of a level landing should not exceed 2.0 percent in any direction and should be installed at the top and bottom of steep grade segments.*

To limit the length of a grade segment, level landings should be provided periodically. The slope of a level landing should not exceed 2.0 percent in any direction. Level landings provide users with a place to rest and gain relief from the demands of the prevailing grade and cross slope. Although providing this resting space between steep grades is important, designers should be aware that level landings will increase the magnitude of the grade segments between the level landings. This problem can be avoided if the level landings are placed adjacent to the pedestrian zone (see Solution 3 in this chapter) and are required at building entrances, bus stops, and intersections.

Pedestrians who have low stamina also rely heavily on level landings to negotiate steep sidewalks. When installing level landings, the following criteria should be met:

- The width of the landing should extend across the full width of the pedestrian zone. On narrow sidewalks, extra width is recommended to allow faster travelers to pass slower travelers.

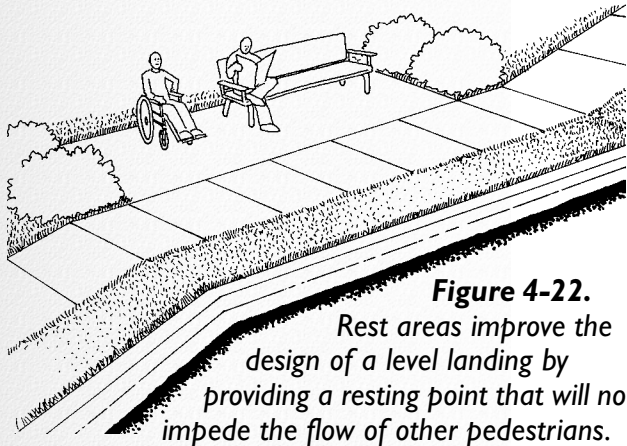
- The landing should be at least 1.525 m x 1.525 m (60 in x 60 in) to allow enough space for a wheelchair user to stop and rest without blocking the flow of other pedestrians who may or may not be using wheelchairs. It is also necessary if a pedestrian is expected to change directions or maneuver around objects.
- The slope of the landing should be designed to be 2.0 percent in any direction to facilitate drainage and to prevent water and debris from collecting on the landing surface.

If level landings are added to existing facilities with narrow pathways, additional right-of-way may need to be purchased or the sidewalk may need to be extended into the roadway.

**SOLUTION 2** — Avoid other factors such as minimum clear widths and cross slope over 2.0 percent. This combination of conditions compound the impact of the steep grade and make the sidewalk more difficult to negotiate.

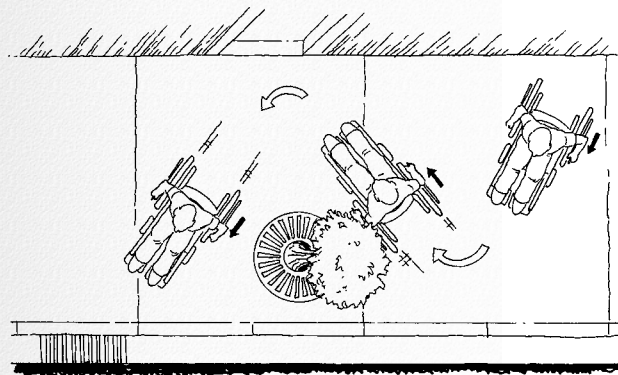
# 4 SIDEWALK CORRIDORS

## CHAPTER



**Figure 4-22.**

Rest areas improve the design of a level landing by providing a resting point that will not impede the flow of other pedestrians.



**Figure 4-23.** In areas of steep terrain, a wide sidewalk allows wheelchair users to travel in a zigzag motion which reduces the grade they must travel, although the overall distance of their trip is increased.

The effects of steep terrain are often compounded because of other factors such as cross slope, narrow widths, and changes in level. Whenever possible, these other factors that impact access for people with mobility impairments should be minimized, but especially when steeper grades can not be completely eliminated. When the grade is steep, surfaces should be firm, stable, and free of changes in level. The pedestrian corridor should be wide enough to allow users to pass one another, and cross slopes should be no greater than 2.0 percent.

**SOLUTION 3** — Provide rest areas with benches and spaces for wheelchair users.

Rest areas are level landings located outside of the pedestrian zone that house additional pedestrian amenities such as benches, shade, and drinking

fountains. Rest areas provide users on steep or exposed sidewalks with an opportunity to rest from their exertions. Benches are the most common amenity for rest areas on sidewalks. Benches should be installed according to ADAAG Section 4.32 in order to accommodate wheelchair users and other people with mobility impairments. In regions with very hot or cold climates, shade and shelter are important rest area amenities because many types of impairments cause people to have difficulty tolerating extreme climates.

**SOLUTION 4** — Install wide sidewalk corridors whenever possible.

Wide sidewalk corridors ensure that people can travel at slower speeds and still feel comfortable knowing that other sidewalk users can easily pass by. In addition, installing wider sidewalk corridors in areas with steep terrain allows wheelchair users to travel in a zigzag pattern. This reduces the grades over which wheelchair users must travel. However, this is not an ideal solution because the added distance a wheelchair user must travel using this technique also requires extra work.



# 4

# SIDEWALK CORRIDORS

## CHAPTER



**Figure 4-24.** Pedestrian sign indicating upcoming steep grade.<sup>1</sup> This could be useful for determining least grade route. This information could be combined with information on alternative routes.

<sup>1</sup>This sign is not currently included in the Manual on Uniform Traffic Control Devices (MUTCD). Before using any traffic control device that is not included in the MUTCD, the interested State or locality should submit a request for permission to experiment to FHWA's Office of Transportation Operations, 400 Seventh Street, SW, Washington, DC 20590 (see [www.mutcd.fhwa.dot.gov](http://www.mutcd.fhwa.dot.gov)). Guidelines for conducting an experiment can be found in Part 1A-6 of the MUTCD.

**SOLUTION 5** — Provide handrails where appropriate.

ADAAG specifies that any accessible route with a slope greater than 5.0 percent is a ramp and must have handrails. In the sidewalk environment, it is not common practice to install handrails. However, handrails may be a viable solution in some situations; for example, where steep grades occur over very short distances, at drop-offs, or near built facilities such as transit stops.

**SOLUTION 6** — Provide signs that indicate the sidewalk grade and inform users of alternate routes with lesser grades.

In addition to making architectural modifications on sidewalks with steep grades, transportation agencies should consider providing users with objective information about existing grades. This type of information is most effective when it is supplemented with information about alternative routes. Information should only be provided in addition to, rather than instead of, architectural

improvements. More information on pedestrian signs is located in Section 6.2.

### 4.2.2 Cross slope

Severe cross slopes make it difficult for wheelchair users and other pedestrians to maintain their lateral balance because they must work against the force of gravity. People using crutches or canes may be forced to turn sideways in order to keep their base of support at a manageable angle. Cross slopes can also cause wheelchairs to veer to the side which increases their risk of rolling into the street. The impacts of cross slopes are compounded when combined with steep grades and uneven surfaces.

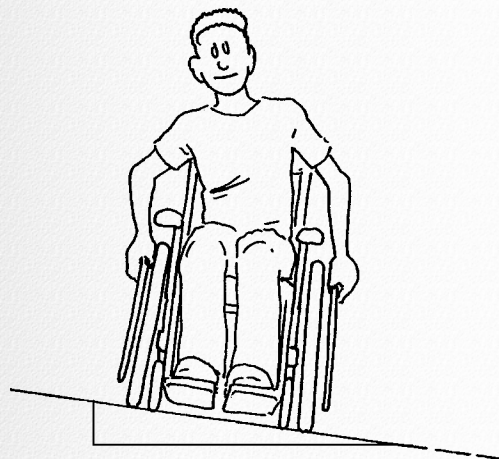
Designers must balance the negative effects that cross slopes have on pedestrian mobility against the necessity of including cross slopes to provide adequate drainage. The recommended cross slope for sidewalks is 2.0 percent. The ADA Accessibility Guidelines confirms the need for construction tolerances by specifying that “all dimensions are

# 4 SIDEWALK CORRIDORS

## CHAPTER

subject to conventional building industry tolerances for field conditions” (ADAAG 3.2, U.S. Access Board, 1991). Contractors must understand the impact of cross slope on people with disabilities to ensure that sidewalk cross slope stays within the recommended 2.0 percent during the installation process.

Once the sidewalk has been constructed, an objective review process needs to be in place to verify that the installed cross slope matches the design plans. Simply eyeballing a project to see if the cross slopes appear to be in compliance is not sufficient. Oftentimes, sidewalk cross slopes are not built to the engineer’s design specifications, and the resulting sidewalk has a greater cross slope than the designer intended. Cross slopes designed to be 2.0 percent that end up as 4.0 percent, are not acceptable. To verify that the cross slope does not exceed the design specification, an objective measurement device, such as a digital level, should be used to check the cross slope after the installation process is complete. It may be advisable to calibrate digital levels before each inspection to maintain accuracy.



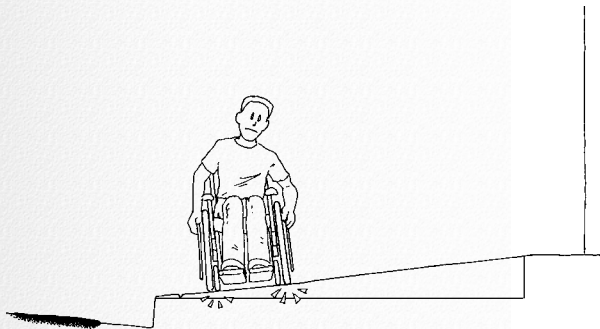
**Figure 4-25.** Wheelchair users traveling on a sidewalk with a cross slope have to use more energy to travel in a straight line to offset the force of gravity that directs them sideways.

### 4.2.2.1 Grade and cross slope construction tolerances

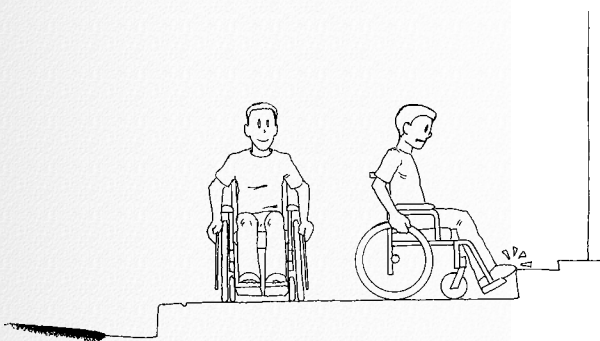
The ADA Guidelines confirm the need for construction tolerances by specifying that “all dimensions are subject to conventional building industry tolerances for field conditions” (ADAAG 3.2, U.S. Access Board, 1991). Contractors must understand the impact of grade and cross slope on people with disabilities to ensure that sidewalk and curb ramp grades and cross slopes stay within the recommended construction tolerances during the installation process. The construction tolerance for Portland Cement Concrete is based on 1/4 inch per 10 ft. (+ 0.2 percent). Research, done by Space Options® in Hawaii, has concluded that failure to build ADA compliant curb ramps is not due to problems with concrete but the lack of training of masons and form carpenters in the precision needed to build accessible curb ramps. Masons and carpenters may need to employ digital levels such as Smartool, and masons a digital level and trowel at the same time to achieve accuracy.

# 4 SIDEWALK CORRIDORS

## CHAPTER



**Figure 4-26. POTENTIAL PROBLEM:** Using steep cross slopes to mitigate between building and street elevations should be avoided because steep cross slopes make it difficult for wheelchair users and others to travel on the sidewalk.



**Figure 4-27.** When the street elevation is lower than the building elevation, buildings often have stairs which prevent people who use wheelchairs from accessing the building.

### 4.2.2.2 Elevation difference between street and building

In new construction, the elevation of the street should be coordinated with the elevation of the sidewalk and surrounding buildings. If the elevations are not coordinated, the buildings may be at a higher elevation than the street, and a ramp will be necessary to bridge the elevation difference to provide the required level landing at the entrance. If a step system is installed, people who use wheelchairs will not have access into the building.

During new construction, transportation agencies can avoid elevation differences by coordinating their efforts with other key parties including site developers and building architects. A review process that includes input from a variety of interest groups should also be in place to ensure that construction plans for sidewalks will meet the needs of pedestrians.

In many existing situations, the building entrance elevation was not coordinated with the street elevation. The results are either:

- Sidewalks with excessive cross slopes; or
- Building entrances with steps.

Either scenario impedes access. Therefore, whenever possible, locations with elevation differences should be retrofitted. The ADA requires both private and public sector entities to mitigate inaccessible entrances.

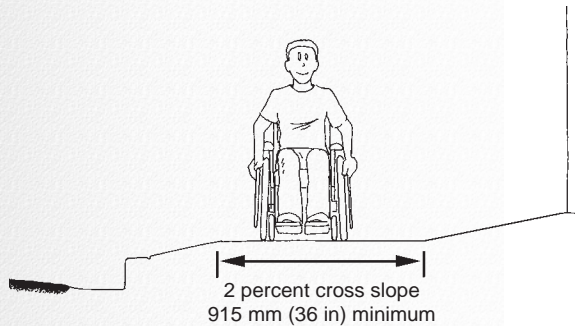
Solutions for improving situations where the street elevation is different than the building elevation include:

**SOLUTION 1** — Create a level area at least 915 mm (36 in) in the center of the sidewalk and slope the edges to make up the elevation difference.

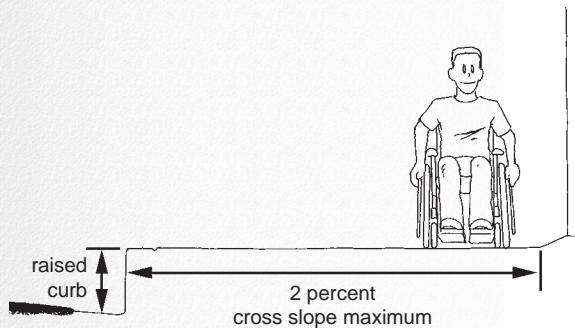
The best way to improve a sidewalk with a steep cross slope is to create a level area at least 915 mm (36 in) wide within

# 4 SIDEWALK CORRIDORS

## CHAPTER



**Figure 4-28. GOOD DESIGN:** A level area at least 915 mm (36 in) wide improves access when the street elevation is lower than the building elevation.

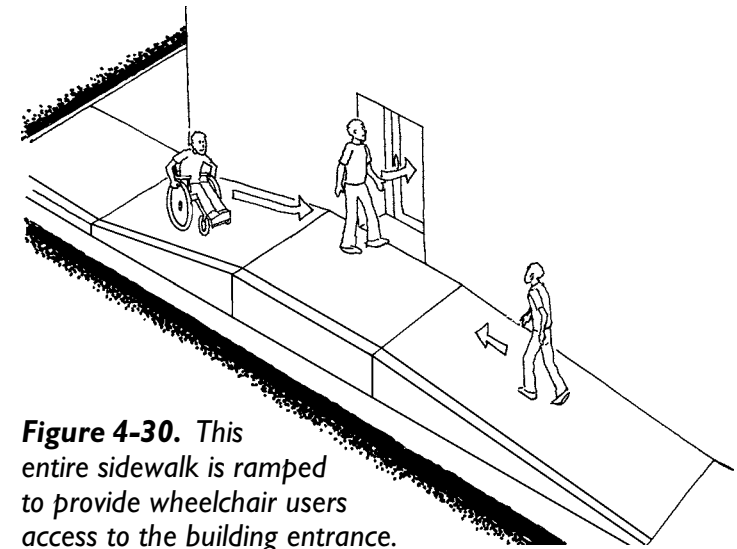


**Figure 4-29. ACCEPTABLE DESIGN:** Increasing the height of the curb provides a level pathway when the street elevation is lower than the building elevation. This solution is not ideal because it is more difficult to install well-designed curb ramps at corners with high curbs.

the pedestrian zone. The slope of the frontage and the planter/furniture zones may be increased to accommodate the additional elevation change. However, these slopes should be minimized in areas where pedestrian travel is anticipated, such as at doorways. This solution works best when the sidewalk corridor is wide because the additional width helps to keep the overall cross slopes to a minimum. Using this method on narrower sidewalks may cause the slope of the planter/furniture and the frontage zones to be too steep.

**SOLUTION 2** — Raise the sidewalk and create a higher curb.

Another possible solution for a sidewalk with a severe cross slope is to raise the curb height to level the sidewalk. This solution is desirable because it works on both narrow and wide sidewalks. However, high curbs can make curb ramp design more



**Figure 4-30.** This entire sidewalk is ramped to provide wheelchair users access to the building entrance.

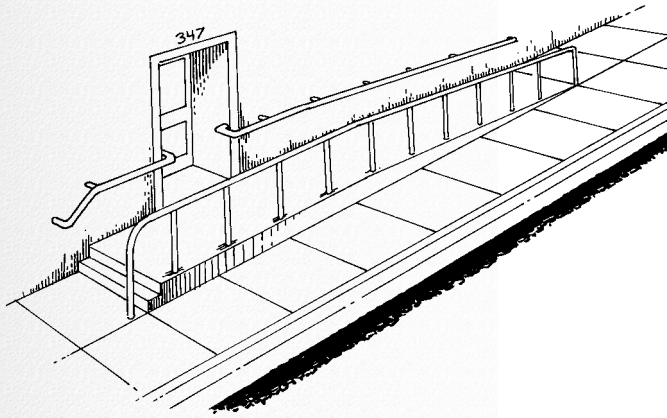
difficult (see Section 7.4.4). A curb higher than 200 mm (8 in) also creates a problem for on-street parking because car doors cannot swing over the curb.

**SOLUTION 3** — Retrofit the building entrance by replacing the steps with a ramp.

Ramps should replace stairs at building entrances to allow people who use wheelchairs access into the building.

# 4 SIDEWALK CORRIDORS

## CHAPTER



**Figure 4-31. GOOD DESIGN:** This sidewalk has been ramped to provide access to the building entrance. This creative design is possible only on wide sidewalks where pedestrians will be given the option to either continue in a straight path or enter the building using the ramp or stairs.

On wider sidewalks, the ramps should not interfere with the pedestrian zone. On narrower sidewalks, designers may have to employ creative solutions, such as ramping the entire sidewalk up to the building to allow for wheelchair access. In most situations, on-street parking will have to be restricted if the entire sidewalk is raised.

### 4.3 Sidewalk surfaces

Factors that affect the usability of the sidewalk surface are:

- Surface material;
- Firmness, stability, and slip resistance;
- Changes in level; and
- Dimensions of gaps, grates, and openings.

Each of these surface factors work in conjunction with the other to determine how easily pedestrians can use the sidewalk.

#### 4.3.1 Surface material

Sidewalk surfaces generally consist of concrete or asphalt; however, tile, stone, and brick are also common. Most common sidewalk materials are firm, stable, and slip resistant when dry.

##### 4.3.1.1 Firm and stable

Typically, sidewalks constructed of asphalt or concrete are firm and stable.

**Firmness** is the degree to which the surface resists deformation by indentation when, in this case, a person walks or wheels across it. A firm surface would not compress significantly under the forces exerted as a person walks or wheels on it.

**Stability** is the degree to which the surface remains unchanged by contaminants or applied force, so



# 4

# SIDEWALK CORRIDORS

## CHAPTER

### **Surface Material:**

*Sidewalk surfaces should be firm and stable. They should also be slip resistant under dry conditions.*

when the contaminant or force is removed, the surface returns to its original condition. A stable surface would not be significantly altered by a person walking or maneuvering a wheelchair on it.

Surfaces that are firm and stable resist deformation, especially by indentation or the movement of objects. For example, a firm and stable surface such as concrete resists indentation from the forces applied by an ambulatory pedestrian's feet or a wheelchair user's wheel; it also reduces the rolling resistance experienced by a wheelchair user.

### **4.3.1.2 Slip resistant**

Under dry conditions, most asphalt and concrete surfaces are fairly slip resistant.

**Slip resistance** is based on the frictional force necessary to permit a person to ambulate without slipping. A slip resistant surface does not allow a shoe heel, a wheelchair tire, or a

crutch tip to slip when ambulating on the surface.

A broom finish should be used on concrete sidewalks to increase the slip resistance for pedestrians. Decorative paints and surfaces, such as polished stones or exposed aggregate rock, are not as slip resistant and should be avoided.

Some asphalt sealants decrease the slip resistance of asphalt. In addition, the specification of the aggregate sieve spectrum has a significant impact on the slip resistance of the final surface. In general, brushed concrete is more slip resistant than asphalt, depending on the type of aggregate used. The U.S. Access Board Technical Bulletin #4 (1994a) addresses slip resistance in further detail.

Thermoplastic materials, commonly used to mark lines on asphalt or concrete at crosswalks, are generally not as slip resistant as the roadway surface. The problem is exaggerated when the surface is wet. Whenever possible, a texture should be added to thermoplastic materials to improve slip resistance. Some research suggests that additives, such as crushed



# 4

# SIDEWALK CORRIDORS

## CHAPTER

### **Slip Resistant Surface:**

*A broom finish should be added to concrete sidewalks to create a slip resistant surface.*

glass will improve the slip resistance of thermoplastics. Further research is necessary to identify more effective materials to mark crosswalks. More information about crosswalks is included in Section 8.5.

### **4.3.1.3 Wet or icy surfaces**

Slip resistant surfaces are more difficult to achieve when the sidewalk material is wet or icy. Surfaces that are wet or icy are difficult for all pedestrians to travel across, but they are especially difficult for people who use wheelchairs or walking aids. Crutch users, for example, rely on being able to securely plant their crutch tip to travel effectively on the sidewalk. If the surface is icy, it creates a major safety problem.

Solutions for preventing water and ice from collecting on the sidewalk include:

**SOLUTION 1** — Design the sidewalk so that only water that falls directly onto the sidewalk and not water that falls onto adjacent surfaces requires management;

**SOLUTION 2** — Create drainage systems to prevent water from settling on the sidewalk; or

**SOLUTION 3** — Establish a regular maintenance program to remove snow and add salt or sand to slippery sidewalk areas.

### **4.3.1.4 Decorative surface materials**

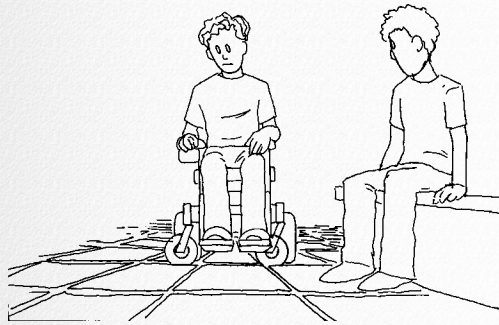
Asphalt and concrete are the most common surfaces for sidewalks; however, some sidewalks are designed using decorative materials, such as brick or cobblestone. Although these surfaces may improve the aesthetic quality of the sidewalk, they may also increase the amount of work required for mobility. For example, tiles that are not spaced tightly together can create grooves that catch wheelchair casters. These decorative surfaces may also create a vibrating bumpy ride that can be uncomfortable and painful for those in wheelchairs. Thus, the surface texture should be vibration free with a limit of 1/4 inch or less of rise not more than every 30 inches. In addition, brick and



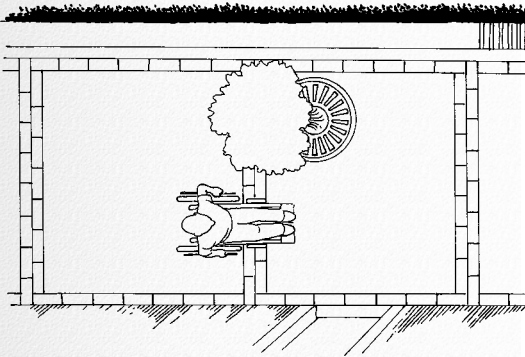
**Figure 4-32.** *Bad weather conditions create wet and slippery surfaces that can be hazardous for pedestrians.*

# 4 SIDEWALK CORRIDORS

## CHAPTER



**Figure 4-33.** This wheelchair user is having difficulty negotiating this decorative surface because his wheelchair caster is stuck between the tiles.



**Figure 4-34.** Cement with brick trim is an alternative to decorative sidewalk materials that are difficult for people with mobility impairments to negotiate.

cobblestone have a tendency to buckle creating changes in level. This creates a tripping hazard for people with vision impairments and for ambulatory pedestrians with mobility impairments. Finally, decorative surface materials can make it more difficult for pedestrians with vision impairments to identify detectable warnings which provide critical information about the transition from the sidewalk to the street.

For these reasons, brick and cobblestone sidewalks are not recommended. Creative alternatives to brick sidewalks include:

- Concrete sidewalks with brick trim, which preserves the decorative quality of brick but is an easier surface to negotiate; or
- Colored asphalt or concrete (stamped to look like brick). Although preferred in comparison to using actual decorative surface material, this option can also create a bumpy surface. Consequently, people with mobility impairments may experience some difficulty when traveling over these surfaces. The

surface texture should be vibration free with a limit of 1/4 inch or less rise not more than every 30 inches.

Many historic districts use decorative surface materials for pathways. Access to historic districts is critical, because they provide cultural enrichment and a sense of connection with the past. Oftentimes, historic districts are not accessible to people with disabilities and therefore require novel solutions to improve access. In downtown Seattle, for example, Pioneer Square is designated as a historic



**Figure 4-35.** In Pioneer Square in Seattle, Washington, an additional pathway was created using smoother and larger pavers with fewer changes in level.

# 4

# SIDEWALK CORRIDORS

## CHAPTER



**Figure 4-36.** Changes of level in sidewalks caused by tree roots are potentially hazardous for pedestrians.

district. The majority of pathways are surfaced with an uneven cobblestone. To accommodate people with mobility impairments in this park, an additional pathway was created using smoother and larger pavers with fewer changes in level. The look of the park was preserved and people with mobility impairments are accommodated.

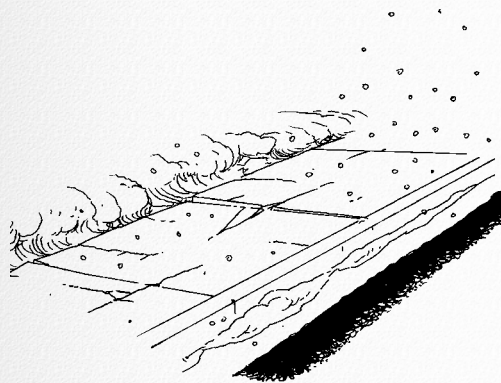
### 4.3.2 Changes in level

Changes in level are vertical elevation differences between adjacent surfaces. Changes in level are relatively common on sidewalks, particularly in residential areas. Causes of changes in level in the sidewalk environment include:

- Tree roots pushing up from beneath the pavement;
- Heaving and settling due to frost;
- Brick surfaces buckling;
- Uneven transitions between streets, gutters, and curb ramps; and
- Lips at the bottom of curb ramps (not allowed by ADAAG).

Changes in level can cause the following difficulties for people with disabilities:

- Many ambulatory pedestrians with mobility impairments have difficulty lifting their feet off the ground. Abrupt changes in level can easily cause these users to trip or fall.
- People with low vision may have difficulty detecting changes in level, such as a buckling sidewalk, which puts these pedestrians at risk of tripping. Some people with vision impairments manage changes in level through cane techniques that detect small changes.
- People using wheeled devices, such as wheelchairs and scooters, can catch their wheels in a sidewalk crack, lose their balance, and propel forward.
- Wheelchair users may also have a difficult time rolling over larger changes in level because of the work required to propel the wheelchair up and over the elevation change.



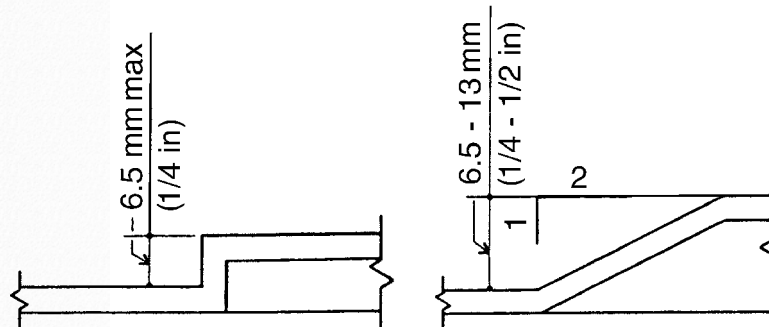
**Figure 4-37.** Changes of level in sidewalks can be caused from heaving and settling due to frost.



# 4 SIDEWALK CORRIDORS

## CHAPTER

**Figure 4-38.** Beveling or ramping changes in level that exceed 6 mm (0.25 in) can minimize the work a wheelchair user must exert during travel.



### Changes in Level:

- Up to 6 mm (0.25 in) — no treatment
- 6 to 13 mm (0.25 to 0.5 in) — bevel the surface with a maximum grade of 50 percent
- Greater than 13 mm (0.5 in) — install a ramp with a maximum grade of 8.3 percent

Most changes in level are a result of poor maintenance. Some changes in level, such as a lip at the bottom of a curb ramp, are no longer recommended as a detection of the street ending and the sidewalk beginning. Any existing elevation changes should be ramped with smooth transition points. In addition, maintenance programs should be established for new construction to address future changes in level as they occur.

Changes in level that currently exist should be addressed through a maintenance program. Whenever possible, the cause

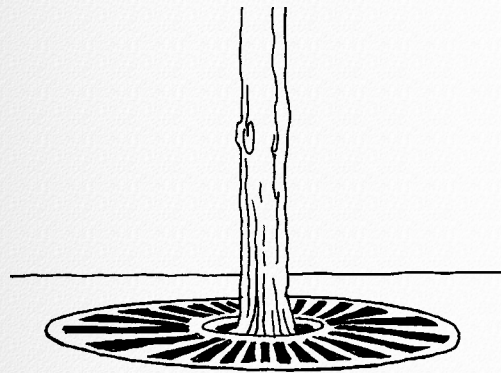
of the change in level should be removed. For example, if the cause of the change in level is an overgrown tree root, the sidewalk should be rerouted around the tree with additional right-of-way or ramp up and over the roots. (Section 4.4 contains information on how to plant trees so that they will not push up through the sidewalk.) If rerouting is not a viable solution, changes of level should be ramped to provide a smooth surface. The following ADAAG guidelines for buildings should be used when addressing changes in level for sidewalks:

- Small changes in level up to 6 mm (0.25 in) may remain vertical and without edge treatment;
- A beveled surface with a maximum slope of 50 percent should be added to small changes in level between 6 mm (0.25 in) and 13 mm (0.5 in); and
- Changes in level such as curbs that exceed 13 mm (0.5 in) should be ramped or removed.

# 4

# SIDEWALK CORRIDORS

## CHAPTER



**Figure 4-39.** Grates around sidewalk trees allow water to reach tree roots and should be located outside the pedestrian zone.

### 4.3.3 Gaps, grates, and openings

A gap is a single opening embedded in the travel surface. Railroad tracks are a common gap that pedestrians must negotiate (see Section 8.11). Other examples include sections of the sidewalk where the surface material has broken off over time. A grate is an open framework of latticed or parallel bars embedded in the travel surface designed to prevent large objects from falling through the opening. Grates are also placed over vents in the sidewalk corridor, over drainage inlets to permit water and some sediment to fall through the slots, and around sidewalk trees to allow water to reach the tree roots.

Wheelchair casters, inline skating wheels, and bicycle tires can all easily get caught in poorly placed openings. If a wheel gets caught suddenly, the user will be pitched forward. The tips of walking aids, such as canes, can also get caught in grates and gaps. When a cane tip slips through an opening, the user can become unstable and risks falling.

Many grates and gaps serve a vital purpose in the transportation system.

However, they should always be located in areas where they will have the least impact on pedestrians. All tree and storm water grates should be sited in the planter/furniture zone and should never be placed in the pedestrian zone. Designers and engineers should also avoid placing grates in a crosswalk or at the bottom of a curb ramp. Gaps that can be repaired should be improved through a maintenance program. Gaps and grates should be designed using the following guidelines:

- Openings should not allow the passage of a 13 mm (0.5 in) sphere; and
- Openings should be oriented so that the long dimension is perpendicular or diagonal to the dominant direction of travel.

### 4.4 The impact of trees on the sidewalk corridor

Trees are generally installed because they improve the pedestrian experience

#### Gaps and Grates:

- Openings should not allow the passage of a 13 mm (0.5 in) sphere
- The long dimension of the opening should be perpendicular or diagonal to the dominant direction of travel

# 4

# SIDEWALK CORRIDORS

## CHAPTER



**Figure 4-40.** *If tree roots cannot be removed, the sidewalk should be rerouted around the tree.*

along the street. Trees serve as a visual and auditory buffer between pedestrians and automobile traffic. They also improve the aesthetic appearance of a street and provide shade or shelter in warm or windy regions. In urban areas, trees provide needed green space and break up the monotony of the public right-of-way. In some residential areas, large trees that extend over the street may have a traffic calming effect by creating a sense of enclosure. According to urban design research, visual enclosure is required to transform streets into pedestrian places, which results in increased comfort for pedestrians and decreased comfort for speeding motorists (Institute of Transportation Engineers, 1999).

Trees need a minimum of 1.22 m x 1.22 m (48 in x 48 in) planting area (Craul, Phillip J., 1999). If improperly planted or maintained, trees can be very problematic in the sidewalk environment. Tree roots are one of the most common causes of sidewalk cracks and small changes in level. Trees that are planted too close together, or without grates or grass,

will have insufficient water. When water is limited, tree roots tend to push through the surface and spread out rather than down to look for new water sources. Sidewalks and curbs should not be installed too close to the tree, which will hamper the tree's natural trunk and root growth.

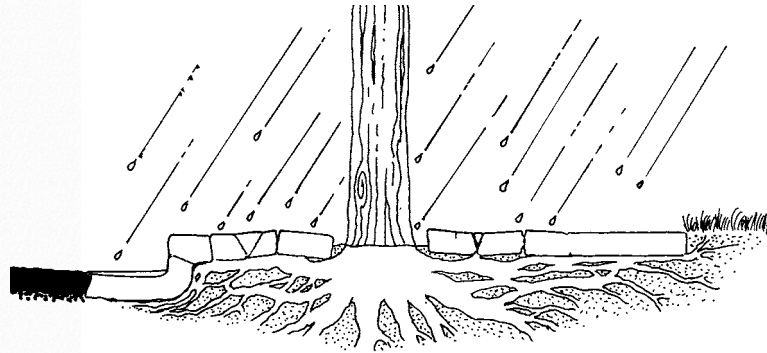
Trees should be chosen with care for their branch patterns, leaf and fruit litter (some fruits and leaves are slippery when dropped). Choose trees that are appropriate for the site with the assistance of a certified arborist or urban forester.

Above the surface, tree branches can be vertical obstructions and protruding objects if they extend horizontally into the sidewalk corridor. People with vision impairments may not be able to detect tree branches that protrude into the travel route. Some people with mobility impairments who have difficulty bending may also have problems with low tree branches. In addition, taller pedestrians are inconvenienced by poorly maintained trees. Tree branches hanging lower than 2.03 m (80 in) should be trimmed away.

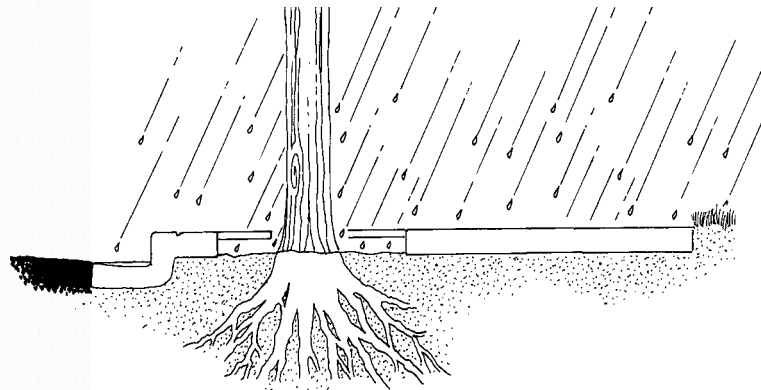


# 4 SIDEWALK CORRIDORS

## CHAPTER



**Figure 4-41.** When trees do not get enough water they tend to spread their roots out, which can break up the surface of the sidewalk.



**Figure 4-42.** Trees planted with grates are less likely to cause sidewalk cracks than trees planted without grates because the grate allows a sufficient amount of water to reach the tree roots. When trees do not get enough water, they tend to spread their roots out which can break up the surface of the sidewalk.

The following recommendations should be considered when installing new sidewalk trees or addressing problems with existing sidewalk trees:

**SOLUTION 1** – Plant trees whose roots tend to grow down rather than out or use root control systems to guide the direction of root growth;

**SOLUTION 2** – Use tree gratings or planting strips to allow enough water to reach the tree roots;

**SOLUTION 3** – Avoid planting trees near intersections because they may decrease visibility between pedestrians and drivers;

**SOLUTION 4** – Trim tree branches regularly to less than 2.03 m (80 in);  
or

**SOLUTION 5** – Place trees far enough apart for roots and trunk to grow and provide open space for food, air, and water.

# 4

# SIDEWALK CORRIDORS

## CHAPTER



**Figure 4-43.** Well lit sidewalks improve accessibility at night for all pedestrians.

### 4.5 Well-lit sidewalks

Because many people have low vision, and because everyone's vision is diminished after dark, increasing the lighting in a sidewalk corridor can significantly improve pedestrian access. The transition between poorly-lit and well-lit areas requires people to adjust their vision to the change in light. This is particularly difficult for people with vision impairments. Improving street lighting makes locations appear friendlier and will encourage people to use the area at night. An increase in the number of people using a particular area reinforces general safety by eliminating opportunities for crimes to occur.

Street lighting is designed to serve a variety of purposes. Some designers use lamp styles to provide a sense of neighborhood continuity or preserve the atmosphere of a historic district. Others use lights to improve visibility for motorists and discourage crime. Lights along public rights-of-way that are directed toward the road provide little benefit to pedestrians.

Some lights only increase the overall light level and do not improve the quality of the pedestrian environment.

Lighting should be evenly distributed to avoid alternating bright and shadowed areas. The best type of lighting for pedestrians focuses on the sidewalk and shines down rather than out. The benefits of lighting can be amplified by reflective material such as yellow paint or reflective markings on the sidewalk that help pedestrians anticipate and avoid obstacles such as curbs.

### 4.6 Grade-separated crossings

Grade-separated crossings are facilities that allow pedestrians and motor vehicles to cross at different levels. They can significantly reduce pedestrian-vehicle conflicts and potential collisions by allowing pedestrians to avoid crossing the motorist's path of travel. Appropriately located and designed grade-separated crossings can reduce vehicle delay, increase highway capacity, and eliminate the likelihood of collisions with vehicles.

# 4

# SIDEWALK CORRIDORS

## CHAPTER



**Figure 4-44.** Providing sidewalks on bridges maintains the continuity of the pedestrian network.

The Florida Pedestrian Planning and Design Guidelines indicate that grade-separated midblock crossings can also reduce pedestrian travel time and help to maintain the continuity of a neighborhood by providing a connection over major arterials or freeways (University of North Carolina, 1996). However, depending on their design, grade-separated crossings often have significant drawbacks. Some grade-separated crossings are very steep and are difficult for people with mobility impairments to negotiate. They are often not considered pedestrian friendly because users are frequently forced to travel out of their way to use the structures.

The effectiveness of a grade-separated crossing depends on whether or not pedestrians perceive that it is easier to use than a street crossing (ibid.). Grade-separated crossings are also extremely costly to construct, can encourage crime, vandalism, and often are not well utilized. Grade-separated crossings should be designed to minimize the change in the pedestrians' path to allow the most direct route of travel.

Examples of grade-separated crossings include:

- **Overpasses** — bridges, elevated walkways, and skywalks/skyways; and
- **Underpasses** — pedestrian tunnels and below-grade pedestrian networks.

Underpasses can be more expensive to install than other pedestrian facilities because a tunnel must be dug and utility lines may have to be relocated. However, underpass approaches can generally be designed with less severe grades than overpass approaches making them preferable for pedestrians. If the needs of pedestrians are a high priority, the grade-separated crossing will be designed so that the vehicular traffic negotiates the change in level while the pedestrian path of travel remains nearly level.

Grade-separated crossings are most efficient in areas where pedestrian attractions, such as shopping centers, large schools, recreational facilities, parking garages, and other activity centers, are



# 4

## SIDEWALK CORRIDORS

### CHAPTER

separated from parking garages or transit stops by high volume and/or high speed arterial streets. The following steps should be taken to increase pedestrian safety and access at grade-separated crossings:

- Provide good sight distances in underpasses, preferably with the open ends of the tunnel in view at all times. This increases the user's sense of security and prevents the user from feeling like other people are lurking in the tunnel;
- Provide good lighting and ventilation in tunnels;
- Include an accessible turning space [at least 1.525 m x 1.525 m (60 in x 60 in)] at the top and bottom of the ramps to the grade-separated crossing;
- Make pathways wide enough to permit two-way pedestrian traffic;
- Install barriers or landscaping to prevent pedestrians from making at-grade and at-risk crossings;

- Provide handrails on overpasses; and
- Minimize grades, cross slopes, and additional travel distances.

Minimizing the slope of a grade-separated crossing is often difficult, particularly for overpasses, because a significant rise [generally between 4.27 m and 5.49 m (14 ft and 18 ft)] must be accommodated. Grade-separated crossings should be designed with level landings 1.525 m x 1.525 m (60 in x 60 in) at every 9.30 m (30 ft) rise and a maximum grade of 8.33 percent. Grade-separated crossings that are not accessible by people with disabilities should not be constructed, since all facilities built after January 26, 1992, are required to be accessible to people with disabilities (U.S. Department of Justice, 1991a). Many manual wheelchair users, ambulatory pedestrians with walkers and other aids, and people with low stamina will not find ramped overpasses usable because of the extreme ramp lengths. A 5.49 m (18 ft) rise

# 4 SIDEWALK CORRIDORS

## CHAPTER

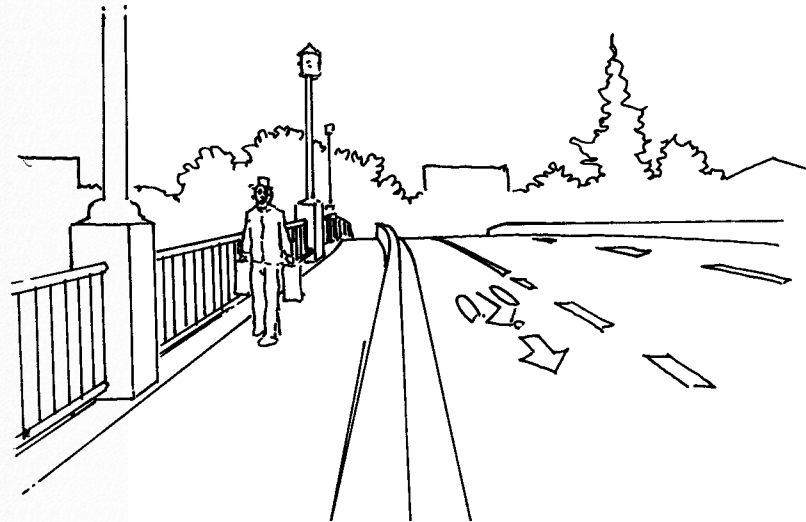
require 64.88 m (216 ft) of ramp run and 8 landings at each approach [each landing being 1.525 m (60 in)]. In addition, existing structures should be prioritized for access improvements. The installation of elevators could provide access for people with mobility impairments and improve use-rates for all pedestrians. Elevators are only effective, however, if they are properly maintained.

### 4.7 Sidewalks in confined spaces

Sidewalks along bridges and in tunnels are more difficult to design than sidewalks along streets because overall space is at a premium, and the edges of the sidewalk are limited by the roadway and a wall or drop-off. For this reason, pedestrians often feel less protected from traffic when crossing bridges and tunnels. Whenever possible, pedestrians should not be forced to walk uncomfortably close to a wall or drop-off. In addition, a protective barrier should be provided at a drop-off.

To increase access and improve the pedestrian environment, designers should employ the following techniques for sidewalks in tunnels and on bridges:

- Separate pedestrian and street traffic with a railing or barrier that measures at least 1.065 m (42 in), because of the proximity and difference in speed between the vehicular and pedestrian traffic that is magnified by the more confined space in a tunnel or on a bridge;



**Figure 4-45.** This bridge provides a comfortable pedestrian environment because there is a clear separation between the sidewalk corridor and the street and the sidewalk corridor is wide enough to allow users to travel side-by-side.

# 4

## SIDEWALK CORRIDORS

### CHAPTER

- Provide a wide pedestrian zone whenever possible, since pedestrians are unable to move off of the sidewalk onto the adjacent property in order to pass or be passed by other pedestrians; and
- Provide a protective barrier to prevent pedestrians from the drop-off at the side of the bridge.

Bridges require additional drainage consideration because moisture has a tendency to freeze more quickly on bridges. If the bridge is located in a colder climate, cross slopes must be carefully designed to quickly drain water off of the sidewalk surface in order to avoid freezing.





# Driveway Crossings

Driveway crossings permit cars to cross the sidewalk and enter the street. They serve the same basic purpose for cars

as curb ramps serve for pedestrians. Therefore, they consist of many of the same components found in curb ramps.

It is the driver's responsibility to yield to the pedestrian at the driveway-sidewalk interface. Unfortunately, this does not always happen, and pedestrians are put at risk. Minimizing the number of driveway crossings in



**Figure 5-1.** To enhance pedestrian access, a driveway crossing should maintain a level pedestrian zone.

a sidewalk significantly improves pedestrian safety.

Driveway crossings should be designed so that both the pedestrians and the drivers are able to use them effectively. However, a driveway crossing must provide a way for cars to negotiate the elevation change between the street and the sidewalk. This is generally achieved by ramping all or a portion of the driveway crossing. When the ramp for the motorist crosses the pedestrian's path of travel, significant cross slopes and changes in cross slope must be negotiated by the pedestrian. The cross slope problem at driveway crossings along with several innovative solutions will be discussed in this chapter. Supplemental information about good design principles and specifications is contained in Table 5-1.

## 5.1 Change in cross slope

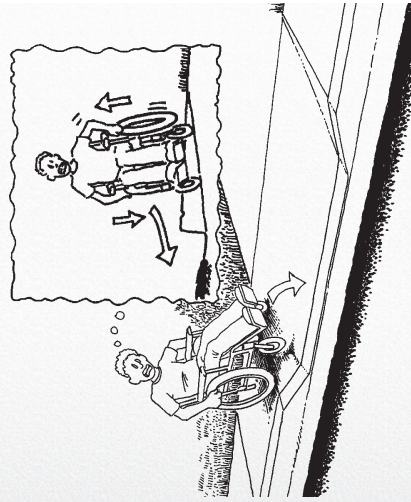
A change in cross slope is an abrupt difference between the cross slope of two adjacent surfaces. ADAAG does not permit cross slope to exceed 2 percent

(changes in cross slope are allowed between 0–2 percent only). Changes in cross slope are commonly found at driveway crossings without level crossings. When considering the needs of pedestrians, change in cross slope is evaluated over a 610 mm (24 in) interval, which represents the approximate length of a single walking pace and the base of support of assistive devices, such as wheelchairs or walkers. The design recommendations for change of cross slope specify the relationship between two adjacent surfaces, not the actual cross slope of either surface.

If the surfaces are sloped in opposite directions, the change in cross slope can be determined by adding together the cross slope of each surface. For example, if the cross slope of the sidewalk was 2 percent in the direction of the property line and the cross slope of the driveway crossing was 10 percent toward the street, the change in cross slope would equal 12 percent. If the surfaces are sloped in the same direction, the change in cross slope can be determined by subtracting the cross slope of the two surfaces.

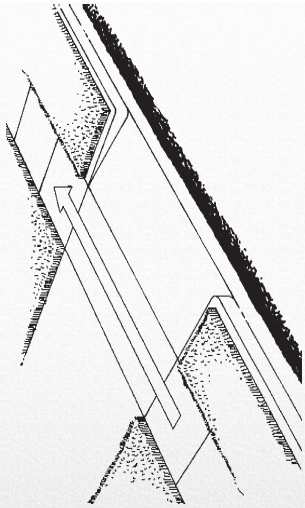
Driveway crossings are the most common location for changes in cross slope within the sidewalk corridor. When the change of cross slope is severe, one wheel of a wheelchair or one leg of a walker may lose contact with the ground causing the user to fall. Other walking pedestrians are also more prone to stumble or fall on surfaces with rapidly changing cross slopes. As the wheelchair moves from the level surface of the sidewalk to the sloped surface of the driveway ramp, it will first balance on the two rear wheels and one front caster. As the wheelchair moves forward, it then tips onto both front casters and one rear wheel. During the transition from the rear wheels to the front wheels, the chair is only on one front wheel and one rear wheel. Since hard contact with both rear wheels is necessary to steer the wheelchair, this transition may cause the wheelchair user to lose control and possibly tip over. Therefore, whenever possible, driveway crossings without level landings should be replaced.

In addition to driveway crossings, changes in cross slope may occur on older sidewalks and occasionally on newer

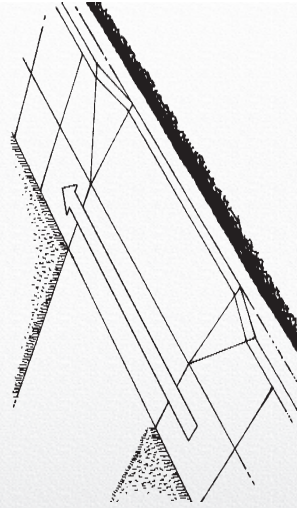


**Figure 5-2. PROBLEM:** This driveway design is not allowed by ADAAG. Driveway crossings without level landings force users to travel over the sidewalk flare. This design results in rapid changes in cross slope, which compromises balance and stability for people who use wheelchairs.





**Figure 5-3. GOOD DESIGN:** Driveway crossings on sidewalks with planting strips should be designed with level landings and returned curbs. Using returned curbs instead of flares benefits pedestrians by forcing motorists to enter the driveway crossing at more of a right angle and thus at a slower speed.



**Figure 5-4. GOOD DESIGN:** Driveway crossings on a wide sidewalk corridor should be designed to include level landings.

sidewalks, where tree roots and other environmental conditions warp the sidewalk surface and create difficult changes in level. Warped sidewalks create a situation of changing cross slopes because there is no planar surface over a 610 mm (24 in) interval. Routine maintenance should replace warped segments of the sidewalk to ensure continual access.

## 5.2 Driveway crossings on wide sidewalk corridors

Driveway crossings should be wide enough to accommodate both the driveway ramp and a level pedestrian zone. This can be easily accomplished on wide sidewalk corridors where either the entire sidewalk is paved or a planting strip is included between the sidewalk and the street. The ramp of the driveway on a sidewalk with a planting strip should be installed with a returned curb rather than a flare. In general, a flare is installed to prevent ambulatory pedestrians from tripping. However, if the ramp is not part of the pedestrian walkway, a returned curb is

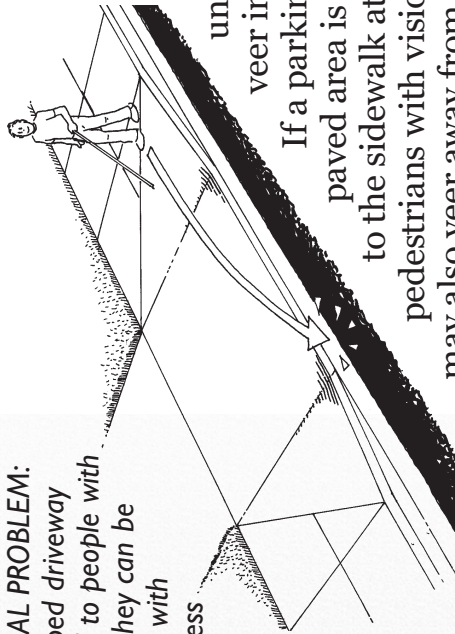
better for drainage and has the added affect of slowing drivers because of the tighter turning radius.

Wide sidewalk corridors provide enough space to maintain a level path of travel along the pedestrian pathway before the driveway ramp resumes sloping toward the street. This type of crossing also serves as a speed table to slow down cars and protect pedestrians. In addition, people with vision impairments can identify the driveway crossing more easily because they can usually detect the steep section of the driveway crossing at the side of the pedestrian zone. Steep driveway crossings designed without a level sidewalk result in severe cross slopes.

In some situations, the entire width of the sidewalk corridor is gradually sloped and offers a good travel area for pedestrians with mobility impairments but can pose safety issues for individuals with vision impairments. Without a graded segment leading from the sidewalk toward the street, the boundary of the driveway crossing is more difficult to detect for pedestrians with vision impairments.

### Figure 5-5. POTENTIAL PROBLEM:

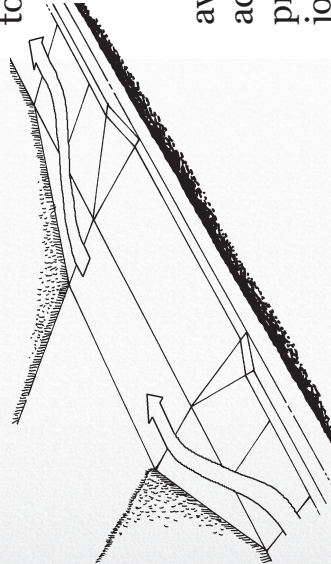
Although gradually sloped driveway crossings are beneficial to people with mobility impairments, they can be problematic for people with vision impairments unless there is a detectable difference in slope at the edge of the street. If a visually impaired person veers toward the street and isn't able to recognize where the driveway ends and the street begins, they may enter the street without realizing it.



This design flaw can make it difficult for users to realize when they unintentionally veer into the street.

If a parking lot or other paved area is provided adjacent to the sidewalk at the property line, pedestrians with vision impairments may also veer away from the street.

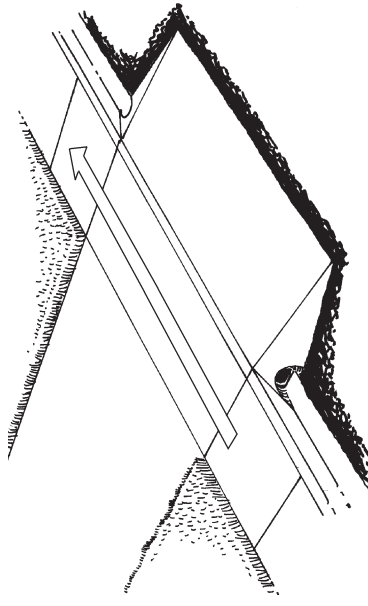
Including steeper grades on either side of the sidewalk at a driveway crossing makes driveway crossings more identifiable to users with vision impairments.



**Figure 5-6. GOOD DESIGN:** Securing additional right-of-way from the adjacent property is a good strategy for improving pedestrian access on narrow sidewalks.

### 5.4 Built-up driveway crossing

Additional right-of-way may also be secured from the gutter or roadway. This design is similar to a built-up curb ramp (Section 8.2.5) because the driveway ramp is projected into the street. Built-up driveway crossings are only appropriate on streets with parking. To promote good drainage for a built-up driveway crossing, a drainage pipe should be placed under the ramp, or drainage inlets should be

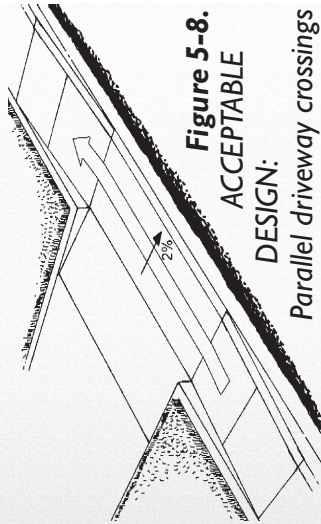


**Figure 5-7. SATISFACTORY DESIGN:** Built-up driveway crossings promote pedestrian access on narrow sidewalks by extending the ramp into the roadway and allowing the sidewalk to remain level. This ramp works better on roadways with on-street parking and in areas with no snow.

### 5.3 Jogged driveway crossing

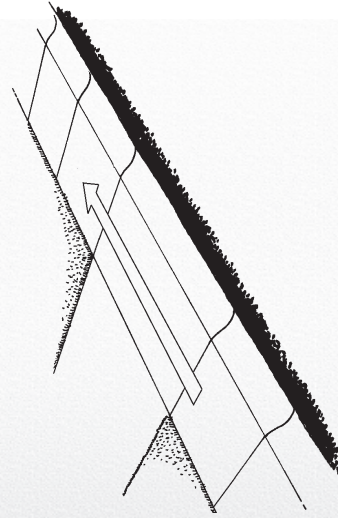
If a wide sidewalk corridor is not available, planners should secure additional right-of-way from the adjacent property so that the sidewalk can be jogged away from the street. This will allow pedestrians to maintain a level path as they cross the driveway. Additional land can be purchased or obtained through an easement from the property owner.





**Figure 5-8.**  
ACCEPTABLE  
DESIGN:

*Parallel driveway crossings enhance pedestrian access at a driveway crossing when there is no room to provide a level landing. Parallel driveway crossings are not as desirable as other accessible driveway crossings because users are forced to negotiate two ramps instead of a level surface.*



**Figure 5-9.** ACCEPTABLE DESIGN:  
Rolled curbs enable drivers to travel over the curb and eliminate the need for a driveway ramp.

positioned on either side of the ramp. If these precautions are not taken, the driveway crossing will act like a dam, causing water to build up behind it.

### 5.5 Parallel ramped driveway crossing

If additional land cannot be secured to jog the sidewalk away from the street, another option would involve a retrofit situation. The sidewalk can be lowered to the elevation of the gutter where it crosses the driveway. The driveway ramp, which is needed to bridge the elevation change between the street and the sidewalk, is located behind the sidewalk. This design is very similar to a parallel curb ramp and requires the sidewalk to ramp down to the elevation of the gutter and then to ramp back up on the other side of the driveway. The landing between the two ramps must have a slight cross slope toward the gutter to prevent ponding and poor drainage.

Although parallel driveway crossings are preferable to driveway crossings with

severe cross slopes, they are less desirable than jogged or built-up driveway crossings with level landings because pedestrians are forced to travel down and then up a ramp. Parallel curb ramps are also problematic because pedestrians with vision impairments may mistake a parallel driveway crossing for a curb ramp. Furthermore, drivers crossing the sidewalk at grade with the roadway have a tendency to travel at a faster speed than when the sidewalk is raised. Keeping the entrance width narrow on this type of driveway crossing forces the driver entering from the roadway to slow down, which improves conditions for pedestrians.

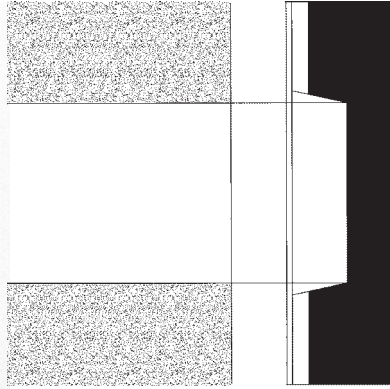
### 5.6 Rolled curbs

A final option for providing a level pedestrian zone on a narrow sidewalk is to design a rolled curb and eliminate the driveway ramp. Drivers are able to travel over the curb, so the sidewalk corridor can remain level. Rolled curbs are most common in residential neighborhoods.



**Table 5-1: Driveway Crossings**

	<p><b>Good Design:</b> Driveway crossings with level landings on wide sidewalks.</p> <p><b>Design Specifications:</b> Landing slope = 2.0 percent Changes in level = flush Landing width = 915 mm (36 in) minimum Flare slope = 10 percent maximum</p> <p><b>Recommendations:</b> A level path of travel is maintained along the sidewalk corridor before the driveway ramp resumes sloping toward the street. If the ramp is located in the path of pedestrian travel, flares should be installed to prevent ambulatory pedestrians from tripping.</p>		<p><b>Good Design:</b> Driveway crossings with level landings and returned curb on sidewalk with a planting strip.</p> <p><b>Design Specifications:</b> Landing slope = 2.0 percent Changes in level = flush Landing width = 915 mm (36 in) minimum</p> <p><b>Recommendations:</b> A level path of travel is maintained along the sidewalk corridor before the driveway ramp resumes sloping toward the street. Wide sidewalk corridors with planting strips should be designed with a returned curb that allows for drainage and has the added effect of slowing drivers because of the tighter turning radius.</p>		<p><b>Good Design:</b> Driveway crossing with a level landing jogged away from the street.</p> <p><b>Design Specifications:</b> Landing slope = 2.0 percent Changes in level = flush Landing width = 915 mm (36 in) minimum Flare slope = 10 percent maximum</p> <p><b>Recommendations:</b> Existing narrow sidewalk corridors, without level pedestrian zones, can be improved if additional right-of-way is secured from the adjacent property and the landing is jogged away from the street.</p>
--	---	--	--	--	--



### Accessible Design/Not Recommended:

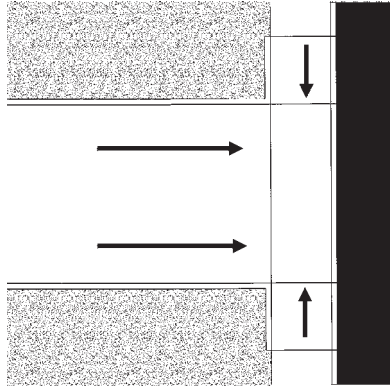
Driveway crossings with motorist ramp built-up into the street.

### Design Specifications:

The design of the sidewalk corridor at a built-up driveway crossing is not influenced by the driveway crossing.

### Recommendations:

Built-up driveway crossings are only appropriate on streets with parking. A drainage pipe should be placed under the ramp, or drainage inlets should be positioned on either side of the ramp. If these precautions are not taken, the driveway crossing will act like a dam, causing water and debris to build up behind it.



### Acceptable Design:

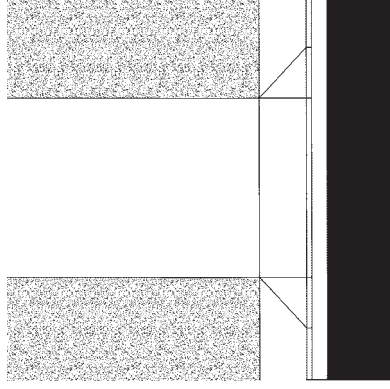
Driveway crossings with ramps parallel to the sidewalk and landing at grade with the street.

### Design Specifications:

Landing slope = 2.0 percent  
Changes in level = flush  
Landing width = 915 mm (36 in) minimum

### Recommendations:

Parallel driveway crossings are acceptable but not ideal because pedestrians are required to travel over two ramps. The landing between the two ramps should have a slight cross slope toward the gutter to prevent ponding and poor drainage. The entrance width should be kept narrow to force drivers entering from the roadway at a slower speed.



### Inaccessible Design:

Driveway crossing without a level crossing.

### Recommendations:

Driveway crossings without level landings create severe cross slopes and are particularly problematic for wheelchair users. Whenever possible, driveway crossings without level landings should be replaced. If a wide sidewalk corridor is not available, an additional right-of-way should be secured from the adjacent property so that the sidewalk can be jogged away from the street or a built-up driveway crossing should be installed.

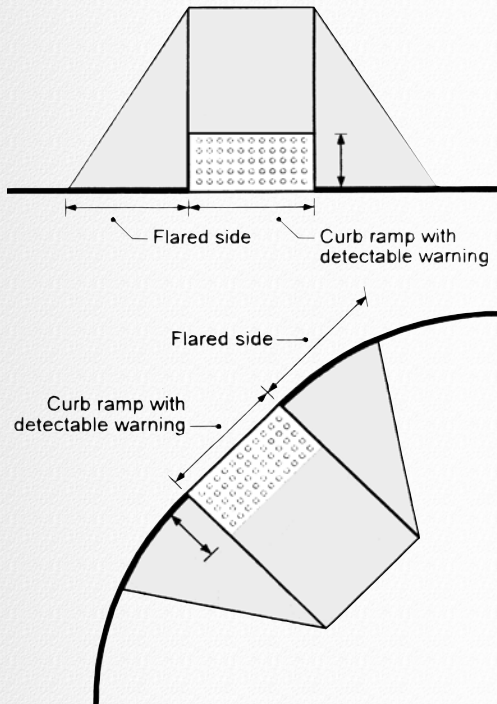


# 6

# PROVIDING INFORMATION TO PEDESTRIANS

## CHAPTER

## Providing Information to Pedestrians



**Figure 6-1.** Curb ramp designs showing 610 mm (24 in) detectable warning (U.S. Access Board — Detectable Warnings: Synthesis).

To accommodate the information needs of all pedestrians, it is important to provide information that can be assimilated using more than one sense. For example, placing a detectable warning at the bottom of a curb ramp identifies the transition between the sidewalk and the street for people with vision impairments. The detectable warnings also provide an unmistakable stopping place to children and people with cognitive impairments. An accessible pedestrian signal with a locator tone responsive to ambient sound, that is quiet in the context of the environment, lets approaching pedestrians who are blind

know there is a push-button and tells them where it is located. When pushed, the information on the walk signal phase can include audible tones, verbal messages, and vibrotactile information. It also reminds sighted pedestrians to use the button. When the tone changes, indicating the onset of the WALK interval, people who are not watching the pedestrian signal, or who cannot see it because of glare, know that the WALK signal has begun. Redundancy and multiplicity of formats increase the likelihood that all users, including people with vision impairments, will be able to make informed traveling decisions.

Examples of pedestrian information range from pedestrian signage to accessible pedestrian signals. Whenever possible, transportation agencies should standardize the information formats used to provide information to pedestrians. If the information formats vary among locations, pedestrians may become confused and place themselves in dangerous situations. For example, pedestrians with vision

# 6

# PROVIDING INFORMATION TO PEDESTRIANS

## CHAPTER

impairments may be misled if similar sounds are used to convey different meanings at different locations (e.g., beep indicates a North–South crossing in one area and an East–West crossing in another area). Ideally, all pedestrian information formats should be standardized nationally. For example, the newest revision of the Manual on Uniform Traffic Control Devices (MUTCD) will contain standardized guidance for accessible pedestrian signals. Where national standards have not been developed, transportation agencies are strongly encouraged to develop and implement State, regional, or local standards. The Institute of Transportation Engineers (ITE) is developing a toolbox that will take advantage of ongoing research to provide additional guidance to engineers and planners.

### 6.1 Non-visual information

All pedestrians must obtain a certain amount of information from the environment to travel along sidewalks safely and efficiently. Most pedestrians

obtain this essential information visually, by seeing such cues as intersections, traffic lights, street signs, and traffic movements. People with vision impairments also use cues in the environment to travel along sidewalks. For example, the sound of traffic, the presence of curb ramps, and the absence of buildings can identify an upcoming intersection for people with vision impairments. Some pedestrians who are blind have also learned how to estimate distances and directions that they have walked to determine their location relative to desired destinations (Long and Hill, in Blasch et al., 1997).

Good design in the form of regularly aligned streets, simple crossing patterns, and easy to understand city layouts is generally the best method to provide good orientation cues for pedestrians with vision impairments. However, accessible information is sometimes needed to supplement existing information.

Some forms of non-visual information are permanent, such as the edge of the curb; other cues, such as the sound of traffic, are intermittent. Although the



# 6

# PROVIDING INFORMATION TO PEDESTRIANS

## CHAPTER

sound of traffic is a very effective way for people with vision impairments to identify an intersection, it is unreliable, because cars are not always present. Another issue that affects the usefulness of non-visual information is related to how familiar a person is with the environment. For example, people who live near a midblock crossing with raised directional tiles may be able to easily identify the information because they have used it repeatedly and are familiar with its presence (Section 6.4.1). However, people who are unfamiliar with the area would be less likely to understand such a surface unless it has been standardized for such a purpose. The most effective information is easy to locate and intuitive to understand even for pedestrians who are unfamiliar with an area. People with vision impairments stress the importance of consistency in design because accessible information added to the environment is most useful “when used in consistent locations so that travelers can rely on its existence” and find it easily (Peck & Bentzen, 1987).

## 6.2 Pedestrian signs

The majority of pedestrian information is conveyed through signs and signals in the public right-of-way that are directed primarily at motorists. Although these signs and signals often affect pedestrians, they are usually not intended or positioned for pedestrian use. For example, the street name signs on many arterials are hung in the center of the intersection, and traffic signals on a one-way street are often missing for pedestrians traveling in the opposite direction. Pedestrians require information that is specifically directed to their own needs because their sight lines, viewpoints, and travel speeds are substantially different from motorists. Pedestrians may even be endangered when important safety information, such as a stop or yield sign, is not easily seen or detected from the sidewalk corridor. Pedestrian signage should be consistent in format and in location. This enables people with cognitive impairments to learn to identify the information and understand the meaning. Without consistency,



# 6

# PROVIDING INFORMATION TO PEDESTRIANS

## CHAPTER

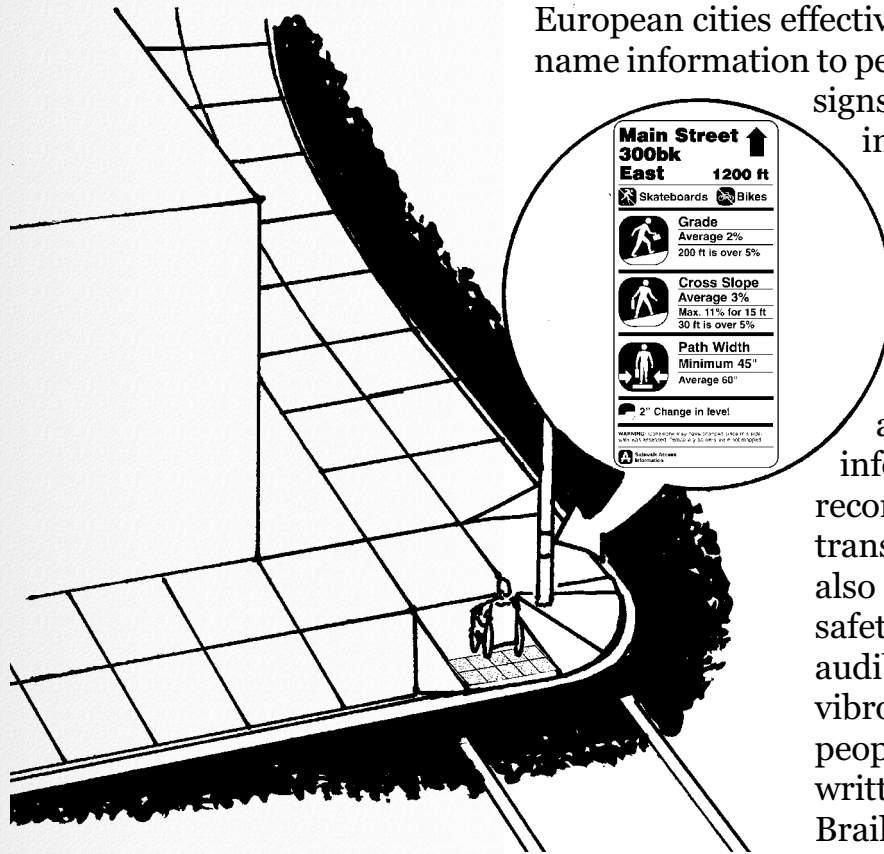
pedestrian signs are difficult for many people to use and fully understand. Many European cities effectively provide street name information to pedestrians by placing signs on building walls in standard locations at each corner.

People with hearing impairments rely heavily on signs for navigational and safety information. It is recommended that transportation agencies also provide pedestrian safety information in audible, tactile, and/or vibrotactile formats for people who cannot use written information. Braille information may also be provided but is not a suitable substitute for more universally understood formats of

pedestrian information such as accessible pedestrian signals. Braille is less than ideal because users will have a hard time identifying the location of the information and because only about 10 percent of people who have vision impairments can read Braille. Indoors, the placement of Braille information signs should be standardized relative to doorways or other easily recognized features. In outdoor environments, the placement of Braille information signs should be standardized relative to doorways and other easily recognized features, following ADAAG. The standardized placement of Braille information in outdoor environments, however, is much more difficult to achieve than indoors, and thus, the use of an audible locator tone in conjunction with Braille information is almost always essential.

To improve safety for all pedestrians, information conveyed through graphics and written signs should be:

- Highly legible to pedestrians, including people with low vision;



**Figure 6-2.** This sign containing sidewalk access information is mounted to a post at a height and location that does not protrude into the pedestrian zone. As a result, this wheelchair user is provided with helpful information about the steep grade ahead.

# 6

# PROVIDING INFORMATION TO PEDESTRIANS

## CHAPTER



**Figure 6-3.** Pedestrians would benefit from signage that objectively describes upcoming conditions such as steep grades. Currently, this type of information is provided to motorists only.



**Figure 6-4.** This type of sign is provided in some trail environments. Pedestrians could benefit from objective sidewalk information such as this sign that indicates an upcoming steep grade.

- Designed using simple standardized formats;
- Placed in locations, such as on building walls, that do not limit the effective width of the sidewalk or block the clear path of travel for pedestrians including those who use assistive devices for mobility;
- Provided in alternative formats to be useable and accessible to all pedestrians, with or without disabilities;
- Placed at locations and at heights that do not protrude into the pathway and create obstructions; and
- Designed according to the MUTCD and ADAAG sign standards to ensure visibility and usability by pedestrians.

Strong consideration should also be given to including signs specifically designed to assist pedestrians. For example, warning signs, similar to

standard traffic warning signs, could provide information about potentially difficult sidewalk characteristics such as steep grades. Motor vehicle signs are not sufficient because the conditions that are significant for pedestrians (e.g., steep grades) may differ from those that affect vehicular traffic. Providing more accurate and objective information to pedestrians about the conditions that they will encounter enables them to make more informed decisions about which routes of travel are most appropriate to their own abilities. The pedestrian oriented signs containing access information (shown in Figure 6-2) were developed as part of a prototype Sidewalk Assessment Process (see Chapter 11). To date, these types of signs have not been introduced into the MUTCD. Inclusion of these signs in this guide does not constitute FHWA endorsement.

### 6.3 Detectable warnings

All people obtain information about the environment in a variety of ways. Therefore, the most accessible information

# 6

# PROVIDING INFORMATION TO PEDESTRIANS

## CHAPTER

is conveyed in more than one format. For example, detectable warnings can generally be identified by texture. However, if they are made with a material that differs in resiliency and color from the surrounding surface, detectable warnings can also be detected visually or by the sound of the cane or foot contacting the surface. The color contrast of a detectable warning can help people of short stature, children, and wheelchair users to locate the curb on the opposite corner (McAuley, Hauger, Safewright, & Rigby, 1995).

A detectable warning is defined in ADAAG Section 3.5 as, “a standardized surface feature built in or applied to walking surfaces or other elements to warn visually impaired people of hazards on a circulation path” (ADAAG, U.S. Access Board, 1991). Research shows that detectable warnings designed according to ADAAG are highly detectable by people with vision impairments (Peck & Bentzen, 1987). Other surfaces, such as aggregate and grooves, are less detectable and less easily understood by people with vision impairments. Consistency and uniqueness

are key factors in how effective a warning is to the user. Detectable warnings are only beneficial to people with vision impairments if they convey a unique message and are placed in a standardized location. Therefore, detectable warnings should always be designed according to ADAAG specifications. Truncated domes (detectable warnings) are required at transit facility platform edges and are familiar to users as an underfoot warning of impending change.

### 6.3.1 Design specifications for detectable warnings

According to ADAAG, detectable warnings should consist of raised truncated domes with a:

- Bottom diameter of 23 mm (0.9 in);
- Top diameter of 10 mm (0.4 in);
- Height of 5 mm (0.2 in);
- Center-to-center spacing of 60 mm (2.35 in); and
- Visual contrast.

#### **Detectable Warnings:**

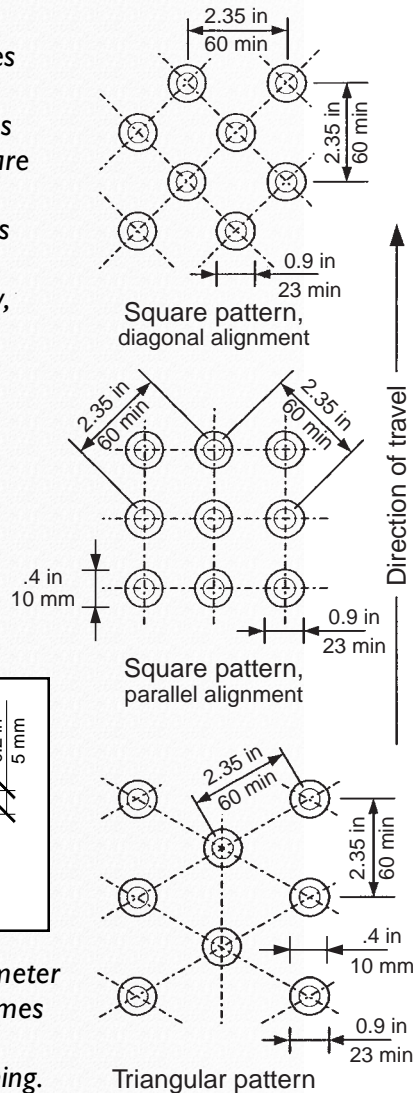
- Diameter of 23 mm (0.9 in) at the bottom of the dome
- Diameter of 10 mm (0.4 in) at the top of the dome
- Height of 5 mm (0.2 in)
- Center-to-center spacing of 60 mm (2.35 in) with visual contrast
- Visual contrast

# 6

# PROVIDING INFORMATION TO PEDESTRIANS

## CHAPTER

**Figure 6-5.** Truncated domes aligned so that wheels may pass between them are easier for some wheelchair users to negotiate (Bentzen, Barlow, & Tabor, 2000).



Height and diameter of truncated domes used in ADAAG detectable warning.

ADAAG specifies truncated domes over rounded domes because they provide greater access to people with mobility impairments. In addition, the color of the detectable warning should contrast visually with adjoining surfaces; either light on dark, or dark on light. The ADAAG Appendix, Section A29.2 recommends that the material used to provide contrast should contrast by at least 70 percent. Contrast is determined by the following formula (ADAAG, U.S. Access Board, 1991):

$$\text{Contrast} = [(B1 - B2)]/B1 \times 100$$

Where,

B1 = light reflectance value (LRV) of lighter area

B2 = light reflectance value (LRV) of darker area

Detectable warnings that are installed indoors should also differ

in resiliency. This stipulation only applies to indoor surfaces, because many materials, such as rubber, that are used to provide contrasting resiliency do not wear well in outdoor areas, especially in harsh winter environments. However, where environmental conditions are favorable, differences in resiliency should also be incorporated in outdoor locations.

Detectable warnings can be laid out on a diagonal grid, a triangular grid, or a square grid. All three designs are equally detectable by people with vision impairments. However, square or triangular grids are recommended because they allow enough space for wheelchair users to roll between the domes. A list of companies that manufacture detectable warnings is compiled in Appendix D.

### 6.3.2 Installation recommendations for detectable warnings

Care should be taken when selecting and installing detectable warnings. Truncated domes that are uneven or too high will cause some pedestrians, including



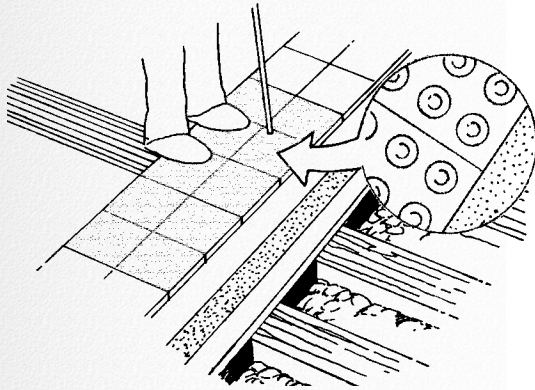
# 6

# PROVIDING INFORMATION TO PEDESTRIANS

## CHAPTER



**Figure 6-6.** A snowplow with a brush that is used to remove snow from sidewalks in Anchorage effectively removes snow from truncated dome surfaces.



**Figure 6-7.** ADAAG requires truncated domes to be installed at all transit platforms.

people who use wheelchairs or walking aids as well as inline skaters, to become unstable.

Some models of truncated domes cannot withstand snow plowing or the destructive effects of snow and ice. Therefore, the successful installation will require some creativity.

For example, in Anchorage, Alaska, a snowplow with a brush is used to clear sidewalks with detectable warnings. The durability

and practical application of truncated domes is a topic in need of further research.

### 6.3.3 Recommended locations

A 610 mm (24 in) strip of detectable warnings should be used in the following locations to improve access for people with vision impairments:

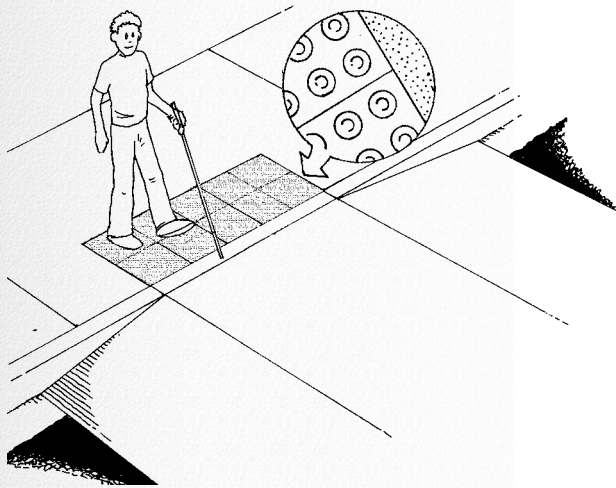
- At the edge of depressed corners;
- At the border of raised crosswalks and raised intersections;
- At the base of curb ramps;
- At the border of medians and islands; and
- At the edge of transit platforms and where railroad tracks cross the sidewalk.

These locations warrant detectable warnings because if unidentified, they represent potential hazards for pedestrians with vision impairments. Detectable warnings are intended to let people with vision impairments know that they are approaching a potentially hazardous situation. For this reason, it would not be appropriate to use detectable warnings to convey other information such as the location of a midblock crossing. It's recommended that truncated domes be placed 152 mm to 200 mm (6 in to 8 in) from the bottom of the ramp. This placement may be more usable by pedestrians in wheelchairs.

# 6

# PROVIDING INFORMATION TO PEDESTRIANS

## CHAPTER

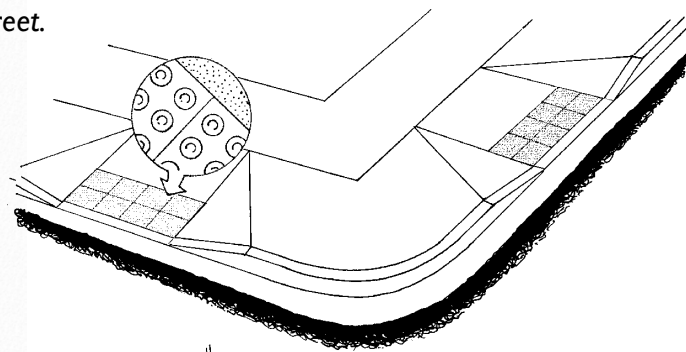


**Figure 6-8.** A 610 mm (24 in) strip of detectable warnings should be installed at the edge of a raised crosswalk to identify the transition between the sidewalk and street.

### Case Study 6-1

Austin, Texas, has a long standing commitment to installing detectable warnings at curb ramps primarily in response to feedback from community organizations representing people with vision impairments.

Currently, only transit platforms are required by ADAAG to include detectable warnings. The requirement for detectable warnings at curb ramps has been temporarily suspended. However, detectable warnings are also needed at the edge of depressed corners, and at the border of raised crosswalks, raised intersections, cut-through medians, and cut-through islands because the transition from the sidewalk to the street is difficult for people with vision impairments to identify.



**Figure 6-9. GOOD DESIGN:** A 610 mm (24 in) strip of detectable warnings should be installed at the bottom of a curb ramp to indicate the transition from the sidewalk to the street.

Detectable warnings are also strongly recommended at the base of curb ramps, as well as at the edge of ramped medians and islands (see Sections 8.7 and 8.8), because ramped surfaces are more difficult to identify than a hard curb. Research to determine the impact of curb ramps on people with vision impairments has shown that on curb ramps that comply with ADAAG 4.7 (i.e., have a maximum grade of 8.3 percent), 48 percent of people with vision impairments cannot reliably detect the ramp to street transition (Bentzen and Barlow, 1995).

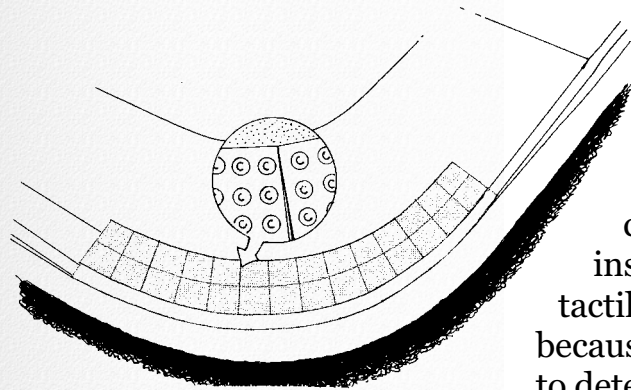
When detectable warnings are installed on curb ramps, only the lower 610 mm (2 ft) of the curb ramp should be covered rather than the entire ramp to maximize detectability and minimize the negative impacts on people who rely on wheeled devices for mobility. In some cases, it may be beneficial to set the detectable warning back 152 mm to 200 mm (6 in to 8 in) from the curb. This allows wheelchair users to gain momentum before traveling over the truncated domes. It also gives people with vision impairments additional



# 6

# PROVIDING INFORMATION TO PEDESTRIANS

## CHAPTER

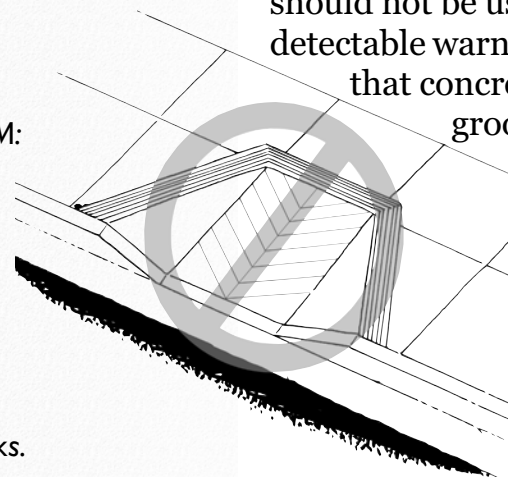


**Figure 6-10. GOOD DESIGN:**  
A 610 mm (24 in) strip of detectable warnings should be installed at the boarder of a depressed corner to identify the transition between the sidewalk and the street.

time to react to the detectable warning before they reach the street. Smooth surfaces should be provided adjoining to the detectable warning to maximize contrast. For example, it is better to install smooth concrete next to raised tactile surfaces than aggregate concrete because the change in texture is easier to detect.

### 6.3.4 Grooves

Grooves cannot be reliably detected by people with vision impairments and should not be used as a substitute for detectable warnings. One study determined that concrete panels with various groove configurations had only a 9 to 40 percent rate of detectability (Templer, Wineman, and Zimring, 1982). Cane users may confuse them with the grooves between sidewalk panels and cracks in the sidewalk.



**Figure 6-11. POTENTIAL PROBLEM:**  
Grooves are not the equivalent of a detectable warning because people with visual impairments can easily confuse them with sidewalk expansion joints or cracks in the sidewalks.

Long white cane users often travel using a tapping technique and only scrape the tip of the cane along the ground when more in-depth exploration of an area is warranted. Other times they may use a technique of keeping the cane in constant contact with the ground. However, canes can generally only detect grooves if the constant contact technique is used to scan the environment. For this reason, grooves are generally ineffective to warn of a potentially hazardous situation, such as an intersection. In addition, dirt, snow, ice, weeds, and other debris in the sidewalk environment are likely to collect in grooves and obscure any warning intended. For these reasons, grooves should not be relied upon to warn pedestrians of potentially hazardous situations, such as the approach of an intersection.

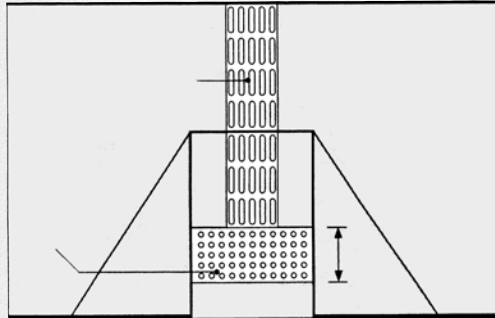
### 6.4 Directional surfaces

Directional surfaces, which are distinct from detectable warning surfaces, may be used to convey wayfinding information

# 6

# PROVIDING INFORMATION TO PEDESTRIANS

## CHAPTER



**Figure 6-12.** Diagram showing requirements for guidance surface and detectable warning on curb ramps in New Zealand.

to pedestrians with vision impairments. Wayfinding information provides orientation clues for people with vision impairments. This type of information can be used to delineate paths across open plazas, crosswalks, and complex indoor environments, such as transit stations or the location of a crossing that may not be in an expected location such as at roundabouts and midblock crossings. Directional surfaces are only useful to pedestrians with vision impairments if the information is identifiable and easy to understand. In addition, each type of surface should be used in a unique and standardized format. The International Organization for Standardization (ISO) committee is currently developing standards for directional surfaces.

### 6.4.1 Raised directional tiles and pavers

Raised directional textures, such as raised directional tiles or pavers, are a common type of wayfinding information used in Europe and Asia. At the present

time, they are less common in the United States. The design of raised directional textures uses a truncated surface, similar to detectable warnings; however, rather than domes, long raised bars are laid out in parallel rows. Raised directional tiles/pavers can be used to identify crossing locations, such as midblock crossings or roundabout crossings, which are often set three to four car lengths back from the actual intersection. On a sidewalk, directional tactile tiles/pavers are laid across the entire sidewalk corridor with the long raised bars perpendicular to the user's path of travel. When the pedestrian crosses the bars, they are an indication that the long raised bars lead to a pedestrian crossing.

Truncated dome surfaces should be used only as a warning, not to provide orientation information.

### 6.4.2 Intersection guidestrips

Another form of wayfinding information is the intersection guidestrip. This device is installed in the center of

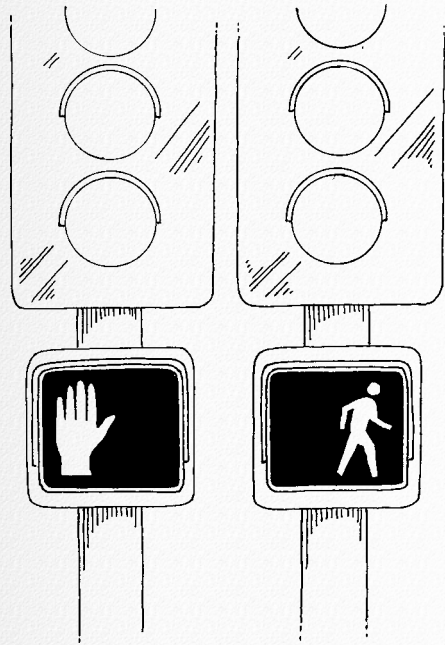
#### Case Study 6-2

Many countries in Europe have begun to experiment with tactile surfaces for wayfinding. France, for example, has begun using tactile surfaces to mark businesses in commercial districts.

# 6

# PROVIDING INFORMATION TO PEDESTRIANS

## CHAPTER



**Figure 6-13. GOOD DESIGN:** Pictorial symbols are easier to understand for people with cognitive impairments, children, and people who do not speak English.

the crosswalk to help users maintain the proper crossing alignment. Guidestrips can be raised or indented depending on the design. Guidestrips improve orientation for people with vision impairments at complex intersections where travel patterns are unusual (San Francisco Bureau of Engineering, 1996). Guidestrips are only beneficial to people who know they are there and understand how to use them. Additional research is needed to determine if intersection guidestrips have a negative impact on bicyclists.

## 6.5 Accessible pedestrian signals

Pedestrian signal indications are special types of traffic signals that are used to control pedestrian traffic patterns and movements (U.S. Department of Transportation, 1988). They consist of a series of signals to indicate:

- WALK interval — the interval designated for pedestrians to cross;
- Clearance interval — the interval designated for pedestrians who are

already crossing to complete their crossing. Pedestrians at corners should not start a new crossing; and

- DON'T WALK interval — the interval when pedestrians are not permitted to cross.

Where deemed necessary to provide visible pedestrian signals, audible or vibrotactile information should also be used. Accessible pedestrian signals (APS) provide redundant audible, vibrotactile, and/or transmitted information about the status of the coinciding visual pedestrian signal. Providing crossing information in a variety of formats enhances recognition and understanding of the information by all pedestrians, particularly individuals with vision or cognitive impairments and young children. Accessible pedestrian signals can provide a variety of information in addition to timing (when the signal cycle allows pedestrians to cross the street). Audible wayfinding tells which roads intersect at the junction and orientation information such as the directional

# 6

# PROVIDING INFORMATION TO PEDESTRIANS

## CHAPTER

heading of each crosswalk. If the accessible pedestrian signal includes a pedestrian actuated control device, it should be easy to manipulate and readily identifiable and accessible by all pedestrians. New standard pedestrian signals use icons rather than words to convey information, which is easier to understand for most pedestrians, especially those with cognitive impairments and people who do not understand English.

There are three main types of accessible pedestrian signals that rely on a variety of information formats including audible broadcast, tactile, vibrotactile, and receiver-based systems. The following sections will evaluate three primary types of accessible pedestrian signals:

- Pedestrian signal indicators with automated signal phasing (fixed time signals);
- Pedestrian actuated signal devices; and
- Signals transmitted from the vicinity of the pedestrian signal to a personal receiver.

More detailed information about accessible pedestrian signals is available in a 1998 review by Bentzen and Tabor. The report provides an analysis of different types of accessible pedestrian signals, contains information regarding manufacturers, and is available from the U.S. Access Board (Bentzen & Tabor, 1998).

### 6.5.1 Installation recommendations

At many signalized intersections, people with vision impairments rely on the surge of parallel traffic to indicate the onset of the WALK interval. However, this method is unreliable at intersections with low traffic volumes, where there are unreliable auditory cues, high volumes of turning vehicles, or complex pedestrian crossings.

The implementing regulation under Title II of the Americans with Disabilities Act requires that all facilities constructed or altered after January 26, 1992 be designed and constructed to be accessible to people with disabilities (U.S. Department of Justice, 1991a). Therefore, all newly installed

# 6

# PROVIDING INFORMATION TO PEDESTRIANS

## CHAPTER

pedestrian signals should have accessible design features. The Transportation Equity Act for the 21st Century (TEA-21) further supports the installation of accessible pedestrian signals by stipulating that the installation of audible signals and signs be included in new transportation plans and projects, where necessary, for safety (TEA-21, 1999).

In addition to including accessible pedestrian signals in all new construction, it is also recommended that existing signal devices that are not accessible be prioritized for replacement. The priorities for determining where existing pedestrian signals should be improved include:

- Complex or irregularly shaped intersections;
- Intersections experiencing high volumes of turning traffic;
- Signalized intersections where traffic sounds are sporadic or masked by ambient noise;
- Intersections that have vehicular actuation of the traffic signals;

- Intersections with complex signal phasing;
- Major corridors leading to areas of fundamental importance such as post offices, courthouses, and hospitals;
- Exclusive pedestrian phase areas, such as motorists stopped in all directions; and
- Locations requested by people with vision impairments (Bentzen & Tabor, 1998).

### **6.5.2 Fixed timed signals (pedestrian signal indicators with automated signal phasing)**

Audible pedestrian signals mounted on pedestrian signal indicators with automated signal phasing are the most common type of accessible pedestrian signal in the United States today. They emit sounds such as a bell, buzz, tone, or bird call (typically “cuckoo” and “chirp”) to alert pedestrians to the WALK interval

# 6

# PROVIDING INFORMATION TO PEDESTRIANS

## CHAPTER



**Figure 6-14. GOOD DESIGN:** In addition to providing audible and vibrotactile information, Swedish pedestrian signals include a simple tactile map of the pedestrian crossing. This intersection has a median and three lanes of traffic.

(i.e., during the steady WALK signal). Some models use one sound to indicate North/South crossings and another sound to indicate East/West crossings. The different sounds alert pedestrians with vision impairments to which crosswalk at an intersection has the WALK interval. However, the success of this system requires that the streets be oriented according to cardinal directions, that users know the orientation of the desired crosswalk, and that they remember the sound associated with crossing in the desired location. Even in areas where such signals are standardized, confusion is reported in the *ITE Journal* (Bentzen, B.L., Barlow, J.M., and Franck, L., September 2000).

An accessible pedestrian signal should provide the best possible information to pedestrians, particularly those who have vision impairments. It must also be acceptable to others in the neighborhood and should not be vulnerable to weather or vandalism. When choosing an accessible pedestrian signal that uses tones, it is important to choose sounds that will not

be easily masked by wind and rain or confused with other sounds, such as birds or vehicle back-up tones.

Most of the accessible pedestrian signal technologies available in the United States today are equipped with volume control that responds automatically to ambient sound. Tones that are 2–5 dB above ambient sound at intersections can be heard 1.830 m to 3.66 m (72 in to 144 in) away by most people. This is loud enough for a locator tone and for a WALK signal at simple, regular intersections of moderate width. At such intersections, the pedestrian who is blind needs to know the onset of the WALK interval but does not normally require a beacon for guidance. Some devices are able to broadcast prerecorded speech messages from the pedestrian head telling the name of the street being crossed and the status of the signal cycle. However, it has been difficult to achieve good speech intelligibility in times of high traffic (Bentzen & Tabor, 1998).

At irregular or exceptionally wide intersections, some pedestrians with vision



# 6

# PROVIDING INFORMATION TO PEDESTRIANS

## CHAPTER

impairments like to use the audible signal as a beacon to help them align and travel directly toward the opposite corner. Audible pedestrian signals that are currently available do not provide this beaconing very well because it comes simultaneously from both ends of the crosswalk. On-going research in Canada (C. LaRoache, University of Ottawa) is directed toward developing a signal that alternates between speakers at both ends of a crosswalk to provide directional information. Transmitted signals can also provide excellent directional information if they are designed and tuned so that real-time signal information can be picked up only when receivers are oriented in line with the crosswalk.

### 6.5.3 Pedestrian actuated signal devices

Pedestrian actuated signal devices are part of many traffic signals and require the user to push a button in order to activate a walk signal indicator and initiate a WALK

interval. Use of pushbuttons may also lengthen a WALK interval to provide adequate crossing time. Where pedestrian interaction with a pushbutton is necessary to initiate or lengthen a walk interval, a locator tone is necessary to inform blind pedestrians that pedestrian actuation is required and to indicate the location of the pushbutton. According to the MUTCD, pedestrian actuated signal devices should be installed:

- When a traffic signal is installed under the Pedestrian Volume or School Crossing warrant;
- When an exclusive pedestrian phase is provided (when motorists are stopped in all directions);
- When vehicular indications are not visible to pedestrians; and
- At any established school crossing with a signalized intersection (U.S. DOT, 1988).

# 6

# PROVIDING INFORMATION TO PEDESTRIANS

## CHAPTER

### 6.5.3.1 Providing information in multiple formats

People with vision impairments are at a disadvantage at an intersection if they are unaware of the presence of pedestrian actuated signal devices. Even if they are aware of the signal, they may have slower starting times because of the time it takes to identify the pedestrian actuated control device, activate the signal, return to the curb, and realign themselves for crossing. Information needs to be accessible and usable by all pedestrians, including those with vision impairments. In addition, all pedestrians benefit from receiving safety information in multiple formats.

Audible, vibrotactile, and visual information can all be provided as part of the pedestrian actuated signal device. The preferred type of device in Australia, common also in many European countries, is an audio-vibrotactile pushbutton with a tactile arrow. This type of signal is now available in the United States.

The audible component of the pedestrian signal has a quiet, slowly

repeating tone or ticking sound throughout the DON'T WALK phase and the clearance interval. This locator tone informs pedestrians that they need to push a button to request a WALK interval, and the sound itself guides the pedestrian to the location of the pedestrian actuated signal device. The WALK interval is signaled by a much faster tone. Another option includes verbal information indicating the name of the street controlled by the pedestrian actuated signal device. One manufacturer has developed an audio-vibrotactile pedestrian actuated signal device with the WALK signal and locator tone at the same volume, except when a pedestrian pushes the button for more than three seconds. The long button press requests a louder signal during the next pedestrian phase. Thus the pedestrian who is blind has louder information available on request, but other people in the neighborhood rarely hear a loud signal.

The tactile component of the pedestrian signal is most commonly presented as a raised arrow on the pedestrian actuated signal device.



**Figure 6-15. GOOD DESIGN:** This pedestrian actuated signal device, used widely in Australia, provides information to pedestrians in audible, visual, vibrotactile, and tactile formats.

# 6

# PROVIDING INFORMATION TO PEDESTRIANS

## CHAPTER

The arrow indicates which street is controlled by the push button. Tactile pedestrian signals can also provide map information using raised circle and line symbols to indicate details such as the number of lanes to be crossed, the direction of traffic in each lane, and whether there is a median (Bentzen & Tabor, 1998).

The vibrotactile component of the pedestrian actuated signal device vibrates synchronously with the slow or fast repeating tone or tick. This vibrotactile signal communicates pedestrian signal information to pedestrians who have both hearing and vision impairments. Vibrotactile signals can also be installed at medians to prevent “signal message overlap” when audible broadcast signals are used on corners of the crosswalk.

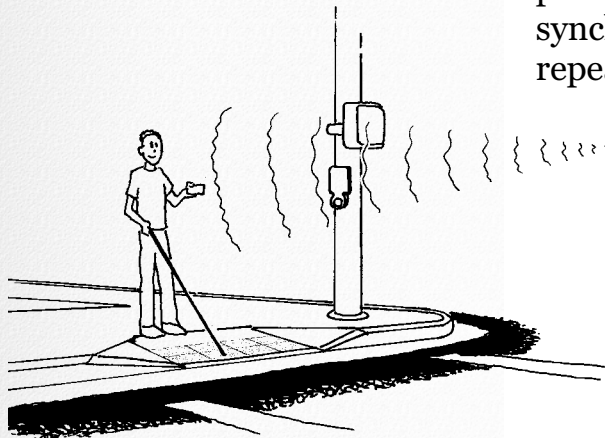
Some designs of pedestrian actuated signal devices have only tactile or vibrotactile information and do not provide an audible element. These designs are not recommended because the

information is only available to pedestrians who are aware of it and can independently locate the device. Table 6-1 outlines the information that should be provided at a pedestrian actuated signal device.

### 6.5.3.2 Physical design characteristics

In addition to providing information in multiple formats, the physical design of the pedestrian actuated control device should be carefully considered. The following steps should be taken to ensure that pedestrian actuated signal devices are accessible to all pedestrians including those with vision and mobility impairments:

- Locate the device as close as possible to the curb ramp without interfering with clear space;
- Install the device so that it can be operated from a level segment of the sidewalk rather than having to be on the curb ramp itself;



**Figure 6-16.** Receiver-base pedestrian systems pick up infrared signals from receiver on the other side of the crosswalk and play them back as audible messages, such as when the “WALK” signal phase is activated or street location.

# 6

# PROVIDING INFORMATION TO PEDESTRIANS

## CHAPTER

**Table 6-1. Summary of information at a pedestrian-activated signal device that can be perceived through a variety of senses.**

	Types of Information at Pedestrian-Activated Signal Devices				
	Visible at the Pushbutton	Visible at the Signal Head	Audible	Vibrotactile	Tactile*
<b>DON'T WALK Interval</b> (Pushbutton not activated)	Bright light above button	"DON'T WALK" text or hand	Slow locator tick*	Slow vibration	Raised tactile arrow points in crossing direction
<b>WALK Interval</b>	Bright light above button flashes on and off	"WALK" text or person walking steady illumination	Rapid tick/tone*	Rapid, regular vibration	
<b>Clearance Interval</b>	Bright light above button	"DON'T WALK" text or hand icon flashes	Slow locator tick/tone*	Slow vibration	

\* Pushbutton must be accurately positioned on the pole to provide accurate directional information.

# 6

# PROVIDING INFORMATION TO PEDESTRIANS

## CHAPTER

- Center the device at the button, providing a level (less than 2.0 percent slope) clear space at least 36 in x 48 in, or 60 in x 60 in if pedestrians will be required to turn or maneuver in order to use the device;
- Mount the device no higher than 1.065 m (42 in) above the sidewalk so that children, people of short stature, and people who use wheelchairs can easily reach and operate it;
- The control face of the button shall be parallel to the direction of the marked crosswalk.
- One button per pole, separated by 3 m is preferred.
- Place the device no closer than 760 mm (30 in) to the curb, no more than 1.5 m (5 ft) from the crosswalk, NES, extended and within 3 m (10 ft) of curb, unless curb ramp is longer than 3 m (10 ft);
- Design the device activation button so that it can be easily operated by people with limited hand function. Small or difficult to manipulate button designs should be avoided. Larger buttons are good for people wearing gloves;
- Design the activation button to require a minimum amount of force, no greater than 15.5 N (3.5 lbf) for people with limited hand and arm strength; and
- Avoid button designs that are activated through conductivity because they are unusable by people with prosthetic hands.

### 6.5.4 Infrared or LED transmitters

Infrared or LED transmitters can transmit speech messages to personal receivers carried by some pedestrians with vision impairments. The speech messages give standardized information about the status of the signal cycle — either WALK



# 6

# PROVIDING INFORMATION TO PEDESTRIANS

## CHAPTER

### Case Study 6-3

The City and County of San Francisco are committed to making intersection and sidewalk environments accessible to pedestrians with vision impairments through the use of remote, infrared, audible signals that label intersections, public buildings, bus stops, transit stations, the ferry terminal, and public toilets.

or WAIT. This pair of messages has been found to be less likely to be misunderstood in noisy intersections than WALK and WAIT, or WALK and DON'T WALK (Crandall, Bentzen & Myers, 1998). Messages may also give the pedestrian's location, direction of travel, and the name of the street to be crossed. Messages may also label streets, bus stops, transit platforms, and other priority areas for

pedestrians. The transmitters may be mounted on traffic poles, buildings, and other significant locations. Signal information can be obtained only when the user is pointing the receiver in line with the crosswalk. Thus, these systems provide excellent directional information. Although the information is being transmitted continuously, only people who are using receivers hear it.





# 7

# CURB RAMPS

## CHAPTER

## Curb Ramps

According to the Title II implementing regulations, priorities for the installation of curb ramps in existing facilities should include access to government facilities, transportation, public accommodations, and for employees to their place of employment (U.S. Department of Justice, 1991a).

### 7.1 The impact of curb ramps

Curb ramps provide access for people who use wheelchairs, who would otherwise be excluded from the sidewalk because of the barrier created by the curb. However, curb ramps can create major information barriers for people with vision impairments who rely on the curb to identify the transition point between the sidewalk and the street. The following section evaluates the impact of curb ramps on these two user groups and provides design strategies to enhance the benefits of curb ramps for people with mobility impairments while minimizing the drawbacks for people with vision impairments.

Curb ramps are critical to providing access between the sidewalk and the street for people who use wheelchairs. Curb ramps are most commonly found at intersections, but they may also be used at other locations such as on-street parking, loading zones, bus stops, and midblock crossings. The implementing regulations under Title II of the ADA specifically identify curb ramps as requirements for existing facilities, as well as all new construction. Curb ramps for existing facilities must be included in Transition Plans.



**Figure 7-1.** Curb ramps should be designed to provide access to people with mobility limitations and vision impairments.

# 7

## CURB RAMPS

### CHAPTER

#### **7.1.1 Impact of curb ramps on people with mobility impairments**

Curb ramps are designed to provide access to people who use wheeled forms of mobility. Without curb ramps, people who use wheelchairs would not be able to independently access the sidewalk and street. However, not all wheelchairs perform the same on a curb ramp. Common types of wheeled mobility devices include manual and powered wheelchairs, as well as powered scooters. Each type of technology will benefit from different aspects of the curb ramp design. For example, most powered mobility devices are maneuverable in small spaces due to their short wheelbase. Scooters have a longer wheelbase but have manual steering, and most can perform a three-point turn in tight spaces. Manual wheelchairs can turn on their own wheelbase but are difficult to steer on a cross slope as they tend to turn downhill.

For many people with mobility impairments, curb ramps are not critical to access. In fact, in some situations curb

ramps make it more difficult for some people with mobility impairments to navigate. Crutches and canes are sized to fit the individual user so that the energy required for ambulation is minimized on a hard, level surface. Use of these types of walking aids is more difficult on sloped surfaces such as curb ramps. Cane, walker, or crutch users must lower their body forward when going downhill. On uphill slopes, the cane or crutch must be lifted higher and placed on the surface. The user must have the strength to lift his or her body up over the supporting device. Widening the crosswalk to allow people to use either the curb or the curb ramp will enhance access for cane and crutch users who are not comfortable traveling on a sloped surface.

#### **7.1.2 Impact of curb ramps on people with vision impairments**

The curb is the most reliable cue that people with vision impairments use to identify the transition between the sidewalk and the street. The installation

# 7

# CURB RAMPS

## CHAPTER

of curb ramps removes this cue and replaces it with a ramp which is much more difficult to detect. Therefore, it is important that as curb ramps are installed to create access for people who use wheelchairs, they are installed in such a way as to maximize detectability for people with vision impairments. Where gradual slopes are desirable for people who use wheelchairs, a detectable warning at the bottom of the curb ramp can provide the information blind pedestrians can rely on. Some localities have installed 12.3 mm (1/2 in) unbeveled lips at the bottom of curb cuts as an information cue for blind pedestrians. This is not reliable information because it is not discernable from cracks, seams, and defects in the pedestrian environment. Also, ADAAG does not allow 12.3 mm (1/2 in) unbeveled changes in level because of the climbing difficulty for wheelchairs.

### 7.1.3 Ideal design characteristics

An accessible connection between the sidewalk and the street can be provided

through a variety of curb ramp designs (see Section 7.2). Designers who have a clear understanding of the needs of pedestrians, with and without disabilities, will be better positioned to select appropriate curb ramp types and locations within the existing site constraints. To maximize accessibility and safety for all pedestrians, curb ramp designs should attempt to meet all of the best practices for curb ramp design shown in Table 7-1. Depending on site constraints, it may not be possible to incorporate all of the best practices within each curb ramp. However, the remainder of this chapter will identify the best curb ramp designs to meet the needs of a broad range of people with disabilities under a variety of site conditions. In addition, mitigating solutions will be provided to improve existing scenarios that hinder access.

## 7.2 Curb ramp types

Curb ramps are usually categorized by their structural design and how it is positioned relative to the sidewalk or

# 7

# CURB RAMPS

## CHAPTER

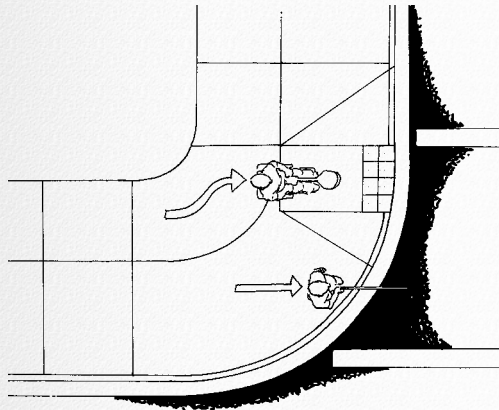
**Table 7-1. Best Practices for Curb Ramp Design**

Best Practice	Rationale
Provide a level maneuvering area or landing at the top of the curb ramp.	Landings are critical to allow wheelchair users space to maneuver on or off of the ramp. Furthermore, people who are continuing along the sidewalk will not have to negotiate a surface with a changing grade or cross slope.
Clearly identify the boundary between the bottom of the curb ramp and the street with a detectable warning.	Without a detectable warning, people with vision impairments may not be able to identify the boundary between the sidewalk and the street.
Design ramp grades that are perpendicular to the curb.	Assistive devices for mobility are unstable if one side of the device is lower than the other or if the full base of support (e.g., all four wheels on a wheelchair) are not in contact with the surface. This commonly occurs when the bottom of a curb ramp is not perpendicular to the curb.
Place the curb ramp within the marked crosswalk area.	Pedestrians outside of the marked crosswalk are less likely to be seen by drivers because they are not in an expected location.
Avoid changes of grade that exceed 11 percent over a 610 mm (24 in) interval.	Severe or sudden grade changes may not provide sufficient clearance for the frame of the wheelchair causing the user to tip forward or backward.
Design the ramp that doesn't require turning or maneuvering on the ramp surface.	Maneuvering on a steep grade can be very hazardous for people with mobility impairments.
Provide a curb ramp grade that can be easily distinguished from surrounding terrain; otherwise, use detectable warnings.	Gradual slopes make it difficult for people with vision impairments to detect the presence of a curb ramp.
Design the ramp with a grade of $7.1 \pm 1.2$ percent. [Do not exceed 8.33 percent (1:12).]	Shallow grades are difficult for people with vision impairments to detect but steep grades are difficult for those using assistive devices for mobility.
Design the ramp and gutter with a cross slope of 2.0 percent.	Ramps should have minimal cross slope so users do not have to negotiate a steep grade and cross slope simultaneously.
Provide adequate drainage to prevent the accumulation of water or debris on or at the bottom of the ramp.	Water, ice, or debris accumulation will decrease the slip resistance of the curb ramp surface.
Transitions from ramps to gutter and streets should be flush and free of level changes.	Maneuvering over any vertical rise such as lips and defects can cause wheelchair users to propel forward when wheels hit this barrier.
Align the curb ramp with the crosswalk, so there is a straight path of travel from the top of the ramp to the center of the roadway to the curb ramp on the other side.	Where curb ramps can be ahead, people using wheelchairs often build up momentum in the crosswalk in order to get up the curb ramp grade (i.e., they "take a run at it"). This alignment may be useful for people with vision impairments.
Provide clearly defined and easily identified edges or transitions on both sides of the ramp to contrast with sidewalk.	Clearly defined edges assist users with vision impairments to identify the presence of the ramp when it is approached from the side.

# 7

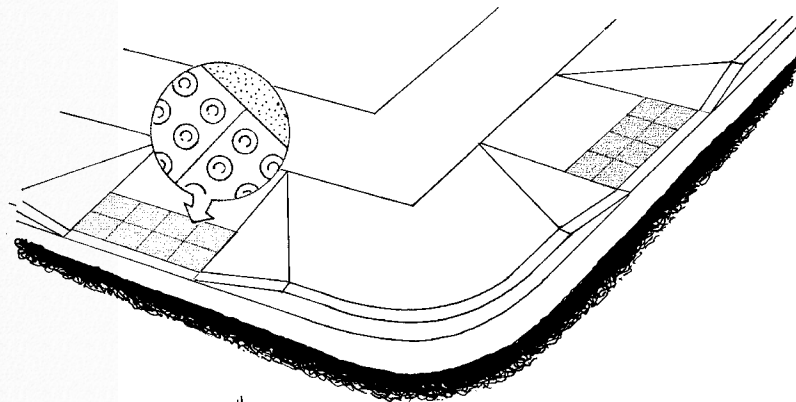
# CURB RAMPS

## CHAPTER



**Figure 7-2. GOOD DESIGN:** When a portion of the curb is included in the crosswalk, it is easier for people with vision impairments to detect the transition between the sidewalk and the street.

**Figure 7-3. GOOD DESIGN:** A level landing of at least 1.220 m (48 in) and a 610 mm (24 in) strip of detectable warnings should be installed at the bottom of a perpendicular curb ramp.



street. The structure of a curb ramp is determined by how the components, such as ramps and flares, are assembled. The type of curb ramp and the installation site will determine its accessibility and safety for pedestrians with and without disabilities. The following types of curb ramps will be reviewed in this guidebook:

- Perpendicular curb ramps;
- Diagonal curb ramps;
- Parallel curb ramps;

- Combination curb ramps;
- Built-up curb ramps; and
- Depressed corners.

Each type of curb ramp has advantages and disadvantages. Some advantages and disadvantages are fundamental to the type of curb ramp. Others result from changes to the configuration of the components within each type or the curb ramp placement on the site. To help designers and engineers sort through the large quantity of potential designs, each type of curb ramp will be described, its advantages and disadvantages discussed, and key issues related to accessibility highlighted through the accompanying illustrations.

### 7.2.1 Perpendicular curb ramps

A perpendicular curb ramp is one that is aligned so that:

- The ramp is generally perpendicular to the curb, and



# 7

# CURB RAMPS

## CHAPTER

### **Level landings:**

*If it is not possible to provide a top level landing, perpendicular curb ramps should not be installed.*

- Users will generally be traveling perpendicular to vehicular traffic when they enter the street at the bottom of the ramp.

Whenever possible, the ramp path should also be aligned with the crosswalk. However, this is difficult to do at intersections with wide turning radii.

Perpendicular curb ramps are easier to design if the sidewalk corridor is wide because the curb ramp can be contained within the furniture zone. This design strategy allows the pedestrian zone to

remain unobstructed. For example, if the curb height is 101 mm (4 in), the ramp slope is 7.1 percent, and the sidewalk has a 2 percent cross slope towards the street, the installation of a perpendicular curb ramp requires a planter/furniture zone that is a minimum of 1.98 m (78 in) wide. If the curb was higher, additional right-of-way would be needed and the curb ramp might have to extend into the pedestrian zone. For details on determining ramp length, refer to Section 7.3.3.

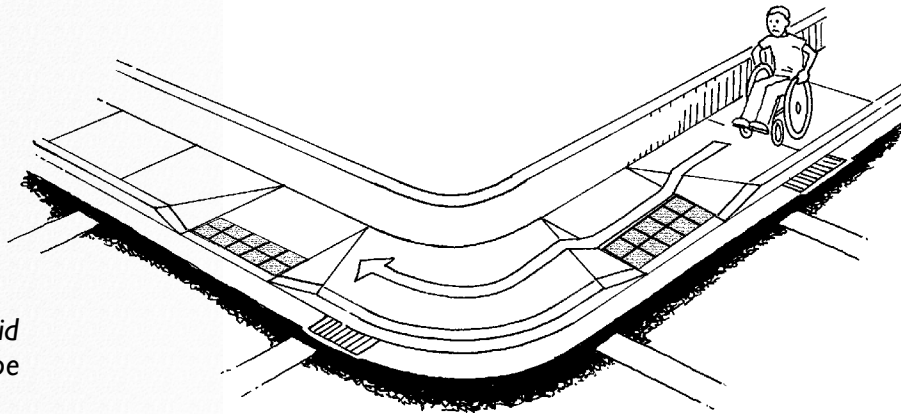
If possible, perpendicular curb ramps should be located outside of the pedestrian walkway, such as in a planting strip or similar location where pedestrians would not normally walk. Placing the curb ramp outside of the pedestrian path of travel allows the flares to be replaced with returned curbs. Returned curbs are more detectable to people with vision impairments than flares (Section 7.3.11). Perpendicular curb ramps within the pedestrian walkway should have flared sides.

All perpendicular curb ramps should include a 610 mm (24 in) detectable

**Figure 7-4.**

### **PROBLEM:**

*Perpendicular curb ramps without level landings are not allowed because they cause severe cross slopes and rapid changes in cross slope over short distances.*



# 7

## CURB RAMPS

### CHAPTER

warning (Section 6.3). In addition, all perpendicular curb ramps should be installed with level landings at the top of the ramp. Landings allow pedestrians to move completely off the curb ramp before turning to proceed along the sidewalk. Perpendicular curb ramps without landings create barriers because they force people to travel over the ramp flares. The path across the flares is not accessible because it creates a severe change in cross slope for a pedestrian on the sidewalk. Wheelchair users and others are very unstable on surfaces with changing cross slopes. Chapter 5 on Driveway Crossings contains additional information on rapidly changing cross slopes.

If it is not possible to provide a level landing of at least 915 mm (36 in), perpendicular curb ramps should not be installed. New construction should always provide adequate right of way for perpendicular curb ramps. If a sidewalk is too narrow for a perpendicular curb ramp to be installed with a landing, a curb extension should be installed or additional

right-of-way should be secured around the curb ramp to create a jogged landing. (See Figures 4-1 and 5-6 for example of jogged space.) A parallel curb ramp may be necessary on very narrow sidewalks with limited row.

At the bottom of a perpendicular curb ramp, the slope of the gutter should not exceed 5 percent. A level landing is not necessary at the bottom of a perpendicular curb ramp for the following reasons:

- No turning is required because users will be oriented in the desired direction of travel (i.e., perpendicular to vehicular traffic) when they enter the street; and
- The bottom of the ramp is contained within the crosswalk. This ensures that the user is not required to maneuver immediately upon entering the street. Placing the curb ramp within the crosswalk will also help people with vision impairments determine the crossing location. Pedestrians with vision

# 7

# CURB RAMPS

## CHAPTER

impairments will only be able to rely on this information if curb ramps are consistently located within the crosswalk.

The following lists summarize the advantages and disadvantages of perpendicular curb ramps:

### Advantages of perpendicular curb ramps

- Are aligned perpendicular to vehicular traffic;
- Provide a straight path of travel on tight radius corners;
- Are aligned with the crossing direction on tight radius corners;
- Are usually positioned within crosswalk; and
- Are at the expected crossing location for all pedestrians.

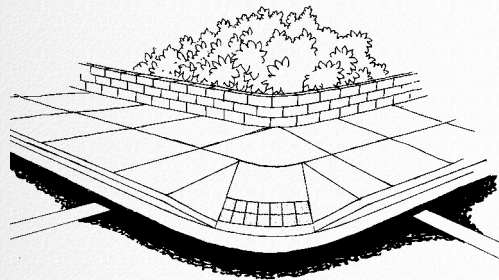
### Disadvantages of perpendicular curb ramps

- Are more expensive than a single diagonal curb ramp;
- Do not provide a straight path of travel on large radius corners;
- Require a level landing that takes up additional right-of-way; and
- Require a wide sidewalk corridor or a curb extension to accommodate the curb ramp and the level landing.

### 7.2.2 Diagonal curb ramps

A diagonal curb ramp is a single curb ramp that is located at the apex of the corner at an intersection. It is aligned so that:

- A straight path of travel down the ramp will lead diagonally into the center of the intersection;



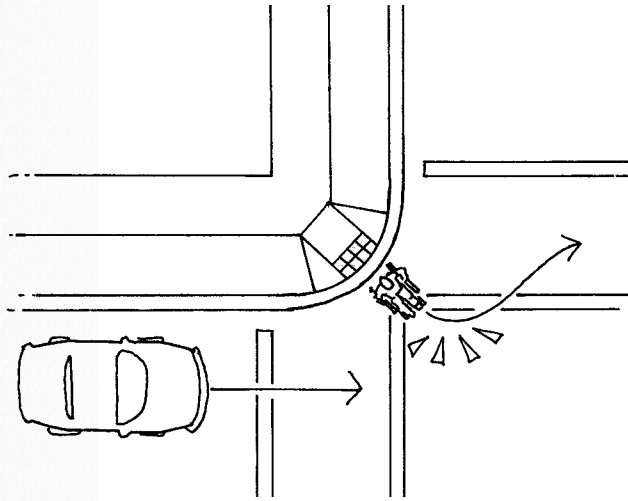
**Figure 7-5.** When designed to promote access, diagonal curb ramps include a detectable warning, a clear space of at least 1.220 m (48 in) within the crosswalk, and a level maneuvering area at the street/gutter approach.

# 7

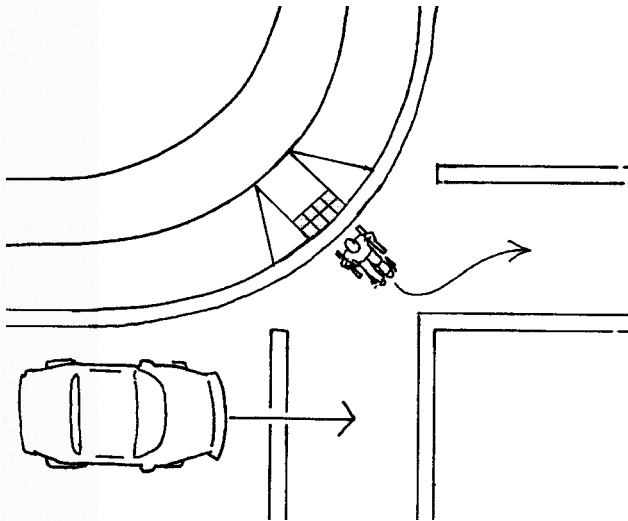
# CURB RAMPS

## CHAPTER

**Figure 7-6. PROBLEM:** If a diagonal curb ramp is located at a corner with a tight turning radius, it may not be possible to provide a 1.22 m (48 in) clear space.



**Figure 7-7. ACCEPTABLE DESIGN:** Although diagonal curb ramps are never ideal at a corner with a wide turning radius, users have enough room to maneuver towards the direction of the crosswalk. There must be a 1.22 m x 1.22 m (48 in x 48 in) bottom level landing.



- The ramp is diagonal to the users' path of travel; and
- Users will be traveling diagonal to the vehicular traffic when they enter the street at the bottom of the ramp.

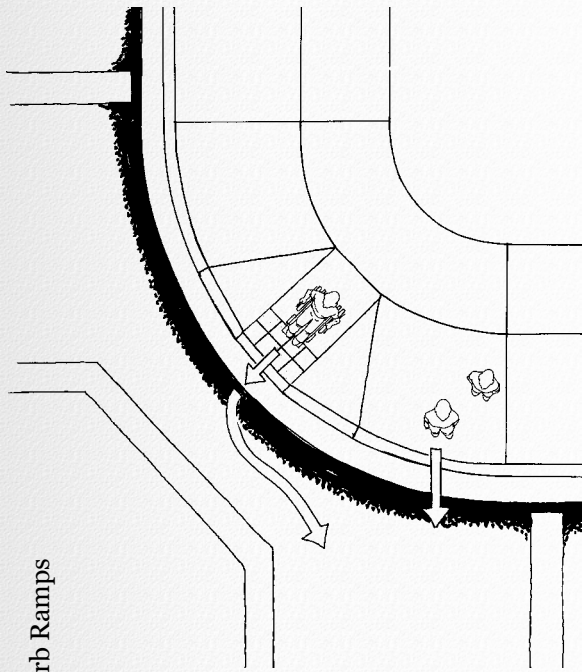
The structure of diagonal curb ramps is usually similar to that of perpendicular curb ramps, but diagonal curb ramps can also have the structure of a parallel or combined curb ramp (Section 7.2.3 and 7.2.4). Because these ramps are diagonal to the path of travel, they are only accessible if a level landing or maneuvering space (e.g., 2.0 percent in any direction) is provided at the top and bottom of the ramp.

In many situations, diagonal curb ramps are not recommended. Diagonal curb ramps force pedestrians descending the ramp to proceed into the intersection before turning to the left or right to cross the street. This problem is worse at intersections with a tight turning radius and without on-street parking because wheelchair users are exposed to moving traffic at the bottom of the curb ramp. Furthermore, diagonal

# 7

# CURB RAMPS

## CHAPTER



Chapter 7. Curb Ramps

**Figure 7-8.** When a single diagonal curb ramp is provided, wheelchair users cross in a different location than other pedestrians.

curb ramps can make it more difficult for individuals with vision impairments to determine the correct crossing location and direction.

When designed to promote access, diagonal curb ramps include at least 1.22 m (48 in) of clear space at the bottom of the curb ramp. However, providing 1.22 m (48 in) of clear space is often not possible at intersections with tight turning radii without exposing the pedestrian to vehicular traffic. In addition, the clear space should be level with a slope that is not more than 2.0 percent in any direction. The level area is necessary so users are not required to turn on a sloped surface. For existing facilities, designing a level landing at the bottom of a curb ramp is difficult because the cross slope of the gutter and the roadway usually exceed 2.0 percent. Limiting the slope of the gutter and roadway to 2.0 percent may interfere with the proper operation of drainage structures and will complicate street resurfacing. If creating level landings is too difficult or a 1.220 m (48 in) clear space cannot be provided,

diagonal curb ramps should not be considered.

The following lists summarize the advantages and disadvantages of diagonal curb ramps:

### **Advantages of diagonal curb ramps**

- Require less space because there is only one curb ramp per corner;
- Are less expensive for alterations because there is only one curb ramp per corner; and
- Allow a pedestrian's normal path of travel to intersect a curb rather than a curb ramp, which enhances detectability of the intersection by people with vision impairments who use the curb to identify the transition from the sidewalk to the street. Street furniture and vegetation should be kept out of this area.

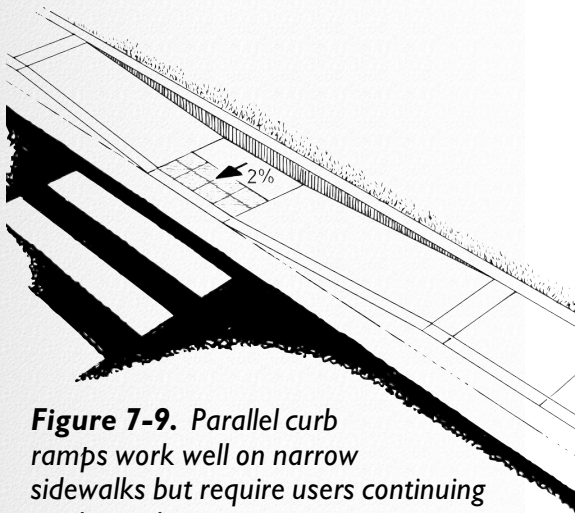
# 7

# CURB RAMPS

## CHAPTER

### Disadvantages of diagonal curb ramps

- Put pedestrians into a potential area of conflict with motorists who are traveling straight and turning;
- Require turning at the top and bottom of the ramp;
- Provide no alignment with the proper crossing direction, which is difficult for most people with disabilities;
- Make the essential level maneuvering area difficult to achieve at the bottom of the curb ramp; and
- Can cause a person with a vision impairment to mistake a diagonal curb ramp for a perpendicular curb ramp and unintentionally travel into the middle of the intersection due to the lack of, or ambiguous, audible cues from the surge of traffic.



**Figure 7-9.** Parallel curb ramps work well on narrow sidewalks but require users continuing on the pathway to negotiate two ramp grades.

### 7.2.3 Parallel curb ramps

A parallel curb ramp has two ramps leading down towards a center level landing at the bottom between both ramps with a level landing at the top of each ramp. A parallel curb ramp is one that is oriented so that the path of travel on the ramp is parallel to the:

- Vehicular path of travel on the adjacent street; and
- Users' path of travel on the sidewalk.

Parallel ramps can be installed on very narrow sidewalks because the landing at the top of the ramp does not require additional right-of-way. Parallel curb ramps are also effective on steep terrain and locations with high curbs because the ramps can easily be lengthened to reduce the grades. The landing at the bottom of a parallel curb ramp is essentially at street level and must be sloped towards the street to limit ponding and poor drainage. Detectable warnings on parallel



# 7

# CURB RAMPS

## CHAPTER

curb ramps should be contained within the lower landing and should border the roadway. Detectable warnings should not be placed at the bottom of each ramp.

Parallel curb ramps are usually designed across the full width of the sidewalk and do not require returned curbs or flares. This eliminates rapid

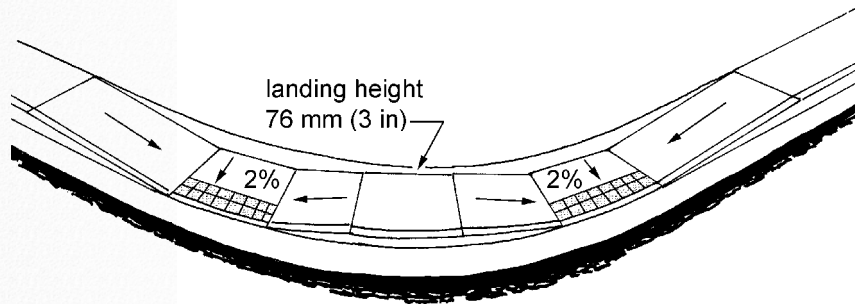
grade and cross slope changes that are potentially difficult for pedestrians. Parallel curb ramps require people continuing along the sidewalk to travel down one ramp and up the other ramp. For this reason, parallel curb ramps should not be installed on sites where it is possible to install two well-designed perpendicular curb ramps.

The following lists summarize the advantages and disadvantages of parallel curb ramps:

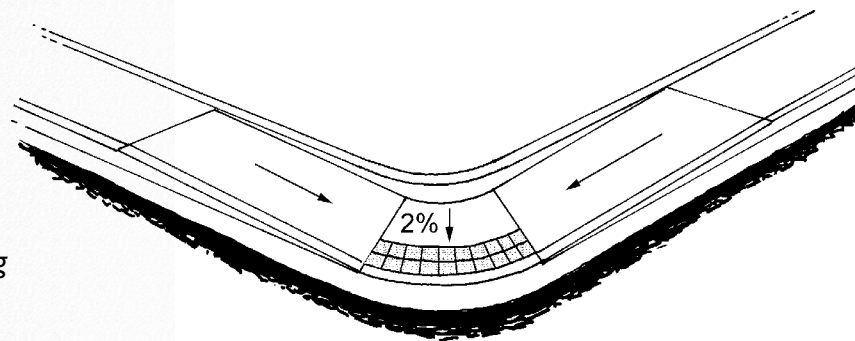
### Advantages of parallel curb ramps

- Require minimal right-of-way;
- Enhance the detectability of the boundary between the curb ramp and the roadway because the ramp ends at a landing, not in the street;
- Allow ramps to be extended to reduce ramp grades;
- Does not require turning or maneuvering on the ramp;

**Figure 7-10.** At intersections with narrow sidewalks and wide turning radii, two parallel curb ramps should be considered.



**Figure 7-11.** On narrow sidewalks with tight turning radii, a single parallel curb ramp may be considered.



# 7

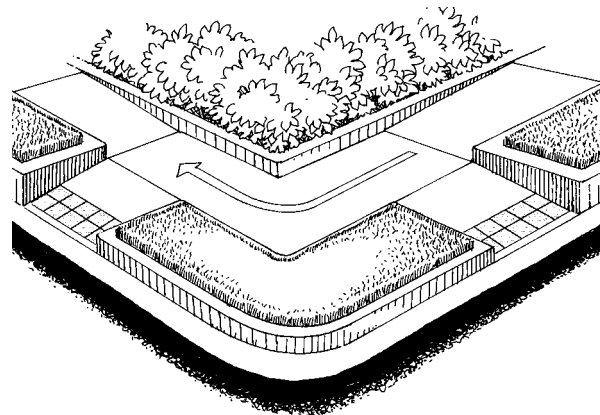
## CURB RAMPS

### CHAPTER

- Provide the connection to the street within the crosswalk;
- Provide a level maneuvering area at the top and bottom of the ramp; and
- Provide edges on the sides of the ramp that are clearly defined for people with visual impairments.

#### Disadvantages of parallel curb ramps

- Require users continuing along the sidewalk to negotiate two ramp grades; and



**Figure 7-12.** Combined parallel and perpendicular curb ramps lowers the elevation of level landings while bridging the remaining elevation gap. This recommended design is very accessible but can be expensive to install in some retrofit installations.

- Require careful attention to the construction of the landing at the bottom of the ramp in order to limit the accumulation of water and/or debris.

#### 7.2.4 Combined parallel and perpendicular curb ramp

A combined parallel and perpendicular curb ramp utilizes the best characteristics of both parallel and perpendicular curb ramps. A combined curb ramp uses the concept of the parallel ramp to lower the elevation level of the landing and then uses a perpendicular ramp to bridge the remaining elevation gap between the landing and the street. This design is particularly helpful for enhancing access in problematic situations where the sidewalk is narrow, has a steep grade, or a high curb.

Combined ramps may be more expensive to install during an alteration than other types of ramps because they require more of the existing sidewalk to be replaced. Combined curb ramps on setback

# 7

# CURB RAMPS

## CHAPTER

sidewalks can be designed with returned curbs because the ramps are out of the pedestrian path of travel.

The following lists are intended to summarize the advantages and disadvantages of combination curb ramps:

### **Advantages of combined parallel and perpendicular curb ramps**

- Do not require turning or maneuvering on the ramp surface;
- Provide the connection to the street within the marked crosswalk;
- Are aligned with the proper crossing direction;
- Provide level maneuvering areas at the top and bottom of the ramps; and
- They provide adequate drainage to limit the accumulation of water or debris.

### **Disadvantages of combined parallel and perpendicular curb ramps**

- Generally require more space than a parallel curb ramp;
- Require more extensive alterations for installation in retrofit situations; and
- Require users continuing along the sidewalk to negotiate the parallel ramps.

### **7.2.5 Built-up curb ramps**

Built-up curb ramps are curb ramps that project from the curb into the gutter and street. They are usually oriented in the same direction as perpendicular curb ramps.

Built-up curb ramps are not commonly installed on sidewalks but are frequently installed in parking lots, but they are not permitted in the access isles of accessible parking spaces. If it is not desired to have the entire built-up curb ramp in the roadway, a partial built-up curb ramp may be used.

# 7

# CURB RAMPS

## CHAPTER

A partial built-up curb ramp begins sloping within the sidewalk corridor but only extends to the end of the gutter.

There are a number of maintenance, design and pedestrian safety problems with the installation of built-up curb ramps. They should not be the first choice of curb ramp application and various considerations should be examined before installing built-up ramps. Curb extensions are more appropriate curb ramp applications, and built-up curb ramps should be used when other applications will not work such as parallel curb ramps.

### **Disadvantages of built-up curb ramps**

- Users are more exposed to cars in the roadway;
- No clear boundary exists between the ramp and the street;
- Adequate drainage may be difficult to achieve or may require more extensive alteration to the gutter and street;

- Must be protected by a parking lane, while protecting the exposed pedestrian to cars parking (bollards and concrete curbing should be placed around the curb ramp flares);
- Must not intrude on space for bicyclists nor interfere with bicycle travel; and
- If flares are built-up, they can require more maintenance, especially if driven over by cars parking.

### **Design recommendations for built-up curb ramps**

- Drop the sidewalk and/or elevate the roadway at the ramp to minimize the grade, length of ramp, and the need for steep flares;
- Blend the flares into the gutter and roadway to minimize the dropoff at the ramp;

# 7

# CURB RAMPS

## CHAPTER

- If possible, keep the ramp inside the edge of gutter to decrease the exposure of users in the roadway;
- Use a high contrast, non-slip material, such as inlaid reflective tape, to outline the edges of the ramp and flares in the roadway to alert pedestrians, bicyclists, and motorists;
- Allocate additional roadway space for bicyclists if the curb ramp is placed where bicyclists would ride; and
- Align the ramp with the pedestrian crossing direction.

### Consider marked crosswalks

- Allow 1.22 m (48 in) or more for the width of the ramp to prevent users from traveling over flares and ending up in the street; and
- Do not place ramps where motorists are able to drive over them; a protective parking lane should be part of the roadway design.

### 7.2.6 Depressed corners

Depressed corners gradually lower the level of the sidewalk, through an almost undetectable change in slope, to meet the grade of the street. Depressed corners are often designed as an expanded diagonal curb ramp that extends around the entire corner at the intersection. In addition, a decorative pattern is often used in downtown urban areas to visually blend the sidewalk and the street, giving the effect of one smooth pathway.

Although depressed corners eliminate the need for a curb ramp, there are very significant drawbacks to the use of depressed corners by pedestrians. Typically, depressed corners:

### Advantages of depressed corners

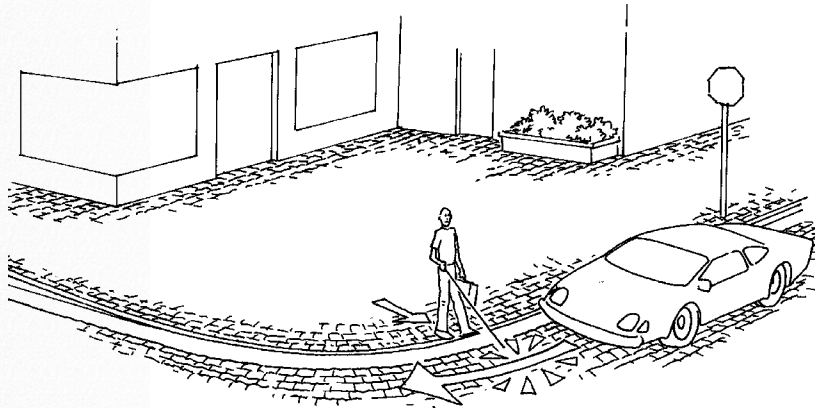
- Give children and people with cognitive impairments the illusion that the sidewalk and street are a unified pedestrian space (i.e., safe).

# 7

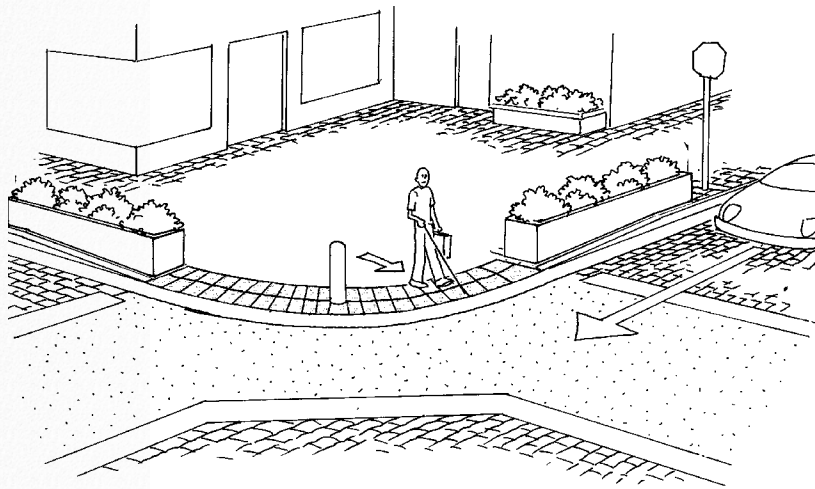
# CURB RAMPS

## CHAPTER

**Figure 7-13. PROBLEM:** Decorative patterns used at depressed corners, such as this brick pattern, create a continuous pathway. People with vision and cognitive impairments have difficulty detecting where the street begins and ends.



**Figure 7-14. Detectable** warnings, contrasting surface materials, and barrier posts are measures that can be utilized to convey the transition between the street and sidewalk at depressed corners. This corner would be a good location for accessible signals.



### Disadvantages of depressed corners

- Enable large trucks to travel onto the sidewalk to make tight turns, which puts pedestrians at risk;
- Make it much more difficult to detect the boundary between the sidewalk and the street for persons with vision impairments;
- Guide animals may not distinguish the boundary and continue walking; and
- May encourage motorists to drive on the sidewalk, enabling them to turn at higher speeds and making it less likely that they will notice or be able to quickly stop for pedestrians on the sidewalk or in the crosswalk.

Given the significant amount of potential problems with depressed corners, this design is not recommended in new construction. If a depressed curb already exists, the following steps should



# 7

# CURB RAMPS

## CHAPTER

be taken to improve pedestrian access and safety:

- Install detectable warnings at the edge of the sidewalk to clearly identify the pedestrian/vehicular boundary;
- Use distinct colors and materials to outline or edge the crosswalk, the sidewalk, and the roadway; and
- Add intermittent barriers, such as planting boxes or bollards, next to the curb to prevent cars from traveling onto the sidewalk when turning the corner. Space the barriers at least 915 mm (36 in) apart to permit wheelchair users to pass. If bollards are used, they should be installed from the centerline out to encourage pedestrian directional flow and to prevent pedestrian congestion. See Section 12.6.3.2.1 in Chapter 12 for more information on installing bollards.

### 7.2.7 Recommendations for selecting a curb ramp design

Determining which curb ramp is most appropriate depends on the exact conditions of the site. Designers that understand the advantages and disadvantages of each type of curb ramp are best qualified to make this decision. A general set of recommendations is contained in Table 7-2 to assist sidewalk developers in their decisionmaking process.

### 7.3 Curb ramp specifications

There are a variety of curb ramp designs, and designers can work with the various features to maximize access. Most curb ramps contain combinations of the following features:

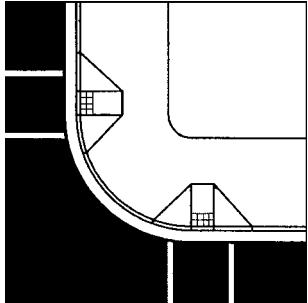
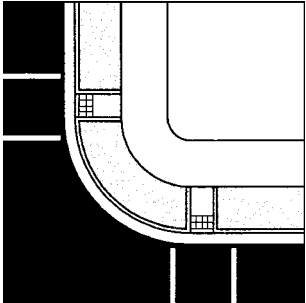
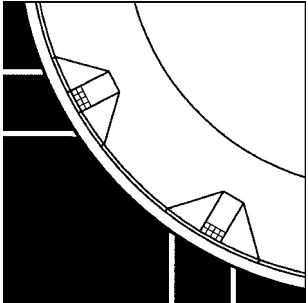
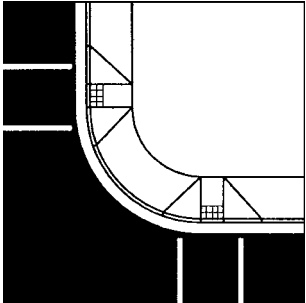
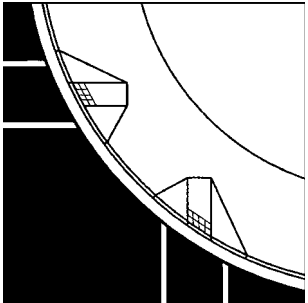
- Ramp grade;
- Ramp cross slope;
- Ramp length;
- Ramp width;

# 7

# CURB RAMPS

## CHAPTER

**Table 7 - 2. Curb Ramps: Perpendicular**

<p><b>Good Design:</b> Perpendicular curb ramps with flares and a level landing</p> 	<p><b>Good Design:</b> Perpendicular curb ramps with returned curbs and a level landing</p> 	<p><b>Inaccessible:</b> Perpendicular curb ramps without a landing</p> 
<p><b>Design Specifications:</b> Ramp slope = 7.1 ± 1.2 percent Gutter slope = 5% maximum Changes in level = flush Ramp width = 1.22 m (48 in) recommended minimum Landing width = 1.22 m (48 in) recommended minimum Flare slope = 10 percent maximum Cross slope = 2 percent maximum Truncated Domes = 610 mm (24 in)</p> <p><b>Recommendations:</b> Perpendicular curb ramps require wide sidewalks that permit a level landing; consider using in the following situations:</p> <ol style="list-style-type: none"> <li>1. In new construction;</li> <li>2. In urban areas;</li> <li>3. At signalized intersections; or</li> <li>4. On arterials and other roads with moderate to heavy traffic volumes</li> </ol>	<p><b>Recommendations:</b> Returned curbs should only be installed on sidewalks with wide plant-ing strips. Otherwise, this design is similar to two perpendicular curb ramps on a wide sidewalk.</p> <hr/> <p><b>Acceptable Design:</b> Perpendicular curb ramps designed perpendicular to the curb on a corner with a wide turning radius</p>  <p><b>Recommendations:</b> This design should be used at corners with wide turning radii and wide sidewalks. Wide turning radii are sometimes necessary but are never ideal for pedestrians.</p>	<p><b>Recommendations:</b> Perpendicular curb ramps without level landings should not be installed and existing curb ramps should be replaced.</p> <hr/> <p><b>Inaccessible:</b> On a corner with a wide turning radius, curb ramps are aligned parallel with the crosswalk.</p>  <p><b>Recommendations:</b> On corners with wide turning radii, curb ramps that are not perpendicular to the curb create problems for wheelchair users because they require users to negotiate rapid changes in grade and cross slope with two wheels leaving the ground. A wider ramp will allow a wheelchair user to turn onto the landing while traveling over less of the flare.</p>

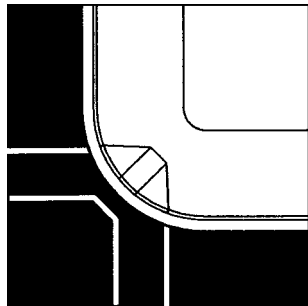
# 7

# CURB RAMPS

## CHAPTER

**Table 7 - 2. Curb Ramps: Diagonal**

**Acceptable Design:**  
Diagonal curb ramp with flares and a level landing, in addition to at least 1.22 m (48 in) of clear space.



**Design Specifications:**

Ramp slope = 8.33 percent

Gutter slope = 2.0 percent maximum

Changes in level = none

Ramp width = 1.22 m (48 in) recommended minimum

Landing width = 1.22 m (48 in) recommended minimum

Flare slope = 10 percent maximum

Cross slope = 2 percent maximum

Truncated domes = 610 mm (24 in)

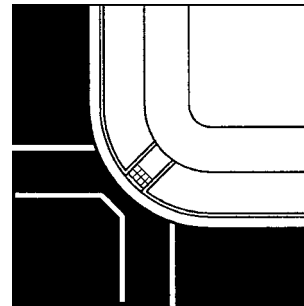
Clear space = 1.22 m (48 in) minimum

**Recommendations:**

Diagonal curb ramps are never ideal and should be avoided in new construction. They should only be considered during retrofitting where the following circumstances apply:

1. Where utilities prevent the installation of two perpendicular ramps;
2. At intersections that are not signalized; or
3. In some residential areas, where traffic volumes are very low.

**Acceptable Design:**  
Diagonal curb ramp with returned curbs, a level landing, and sufficient clear space in the crosswalk.

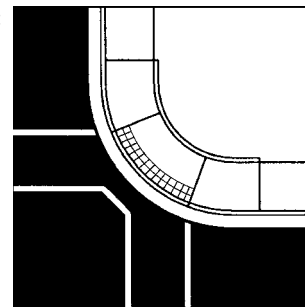


**Recommendations:**

Returned curbs should only be installed on sidewalks with wide planting strips. Otherwise, this design is similar to a diagonal curb ramp with a level landing.

**Acceptable Design:**

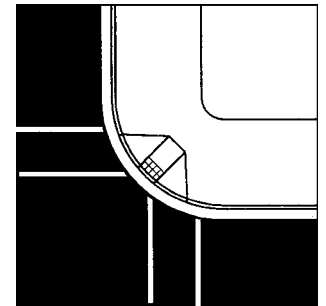
Single parallel curb ramp with at least 1.22 m (48 in) clear space.



**Recommendations:**

If a diagonal curb ramp is warranted and the sidewalk width is limited, a single parallel curb ramp should be considered.

**Inaccessible:**  
Diagonal curb ramp with no clear space or no level area at the bottom of the curb ramp.

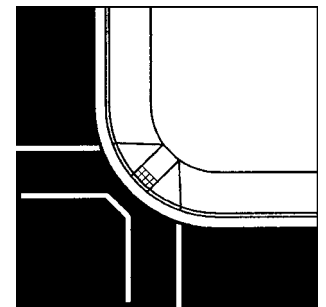


**Recommendations:**

If a level landing or a clear space of 1.22 m (48 in) cannot be provided at the bottom of the curb ramp, a diagonal curb ramp should not be installed.

**Inaccessible:**

Diagonal curb ramps without a level landing.



**Recommendations:**

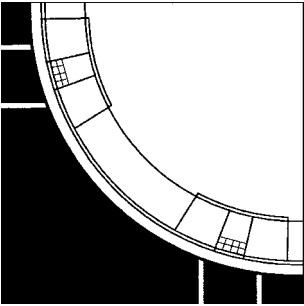
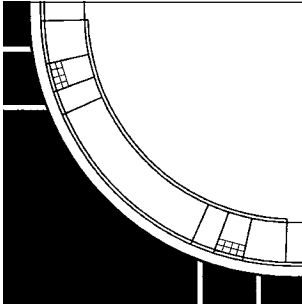
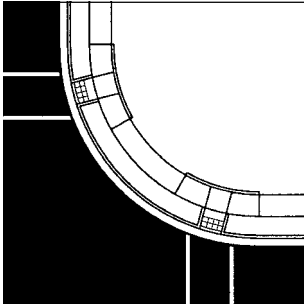
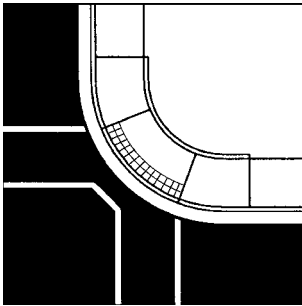
Diagonal curb ramps without level landings should be replaced because they force users to travel over flares.

# 7

# CURB RAMPS

## CHAPTER

**Table 7 - 2. Curb Ramps: Parallel and Combination**

<p><b>Good Design:</b> Two parallel curb ramps on a wide turning radius.</p> 	<p><b>Good Design:</b> Two parallel curb ramps with a lowered curb.</p> 	<p><b>Good Design:</b> Two combination curb ramps on a corner with a wide turning radius.</p> 
<p><b>Design Specifications:</b> Ramp slope = 7.1 percent Gutter slope = 5 percent maximum Changes in level = none Ramp width = 1.22 m (48 in) recommended minimum Landing width = 1.22 m (48 in) recommended minimum Landing slope = 2 percent maximum towards the gutter Cross slope = 2 percent maximum Truncated domes = 610 mm (24 in)</p> <p><b>Recommendations:</b> Parallel curb ramps are a good design on narrow sidewalks and on sidewalks where a longer ramp length is needed, such as on sidewalks with high curbs. Two parallel curb ramps are less desirable than two perpendicular curb ramps because people traveling around the corner have to travel over four ramps. The landing should be sloped 2.0 percent towards the gutter.</p>	<p><b>Recommendations:</b> If the curb between the two parallel curb ramps is lowered, the length or slope of the inside ramps can be reduced because of the reduced elevation change between the sidewalk and the street.</p> <hr/> <p><b>Acceptable Design:</b> Single parallel curb ramp with at least 1.22 m (48 in) clear space.</p>  <p><b>Recommendations:</b> If the sidewalk is narrow and has a tight turning radius, there may not be room for two parallel curb ramps. In this situation, a single parallel curb ramp should be considered.</p>	<p><b>Design Specifications:</b> Ramp slope = 7.1 percent Gutter slope = 5 percent maximum Changes in level = none Ramp width = 1.22 m (48 in) recommended minimum Landing width = 1.22 m (48 in) recommended minimum Landing slope = 2 percent maximum towards the gutter Cross slope = 2 percent maximum Detectable warning = 610 mm (24 in)</p> <p><b>Recommendations:</b> A combined curb ramp uses the concept of the parallel ramp to lower the elevation level of the landing and then uses a perpendicular ramp to bridge the remaining elevation gap. This ramp works well on narrow sidewalks because each ramp is relatively short. Combination curb ramps are sometimes designed as a single ramp at the corner if the turning radius of the corner is small.</p>

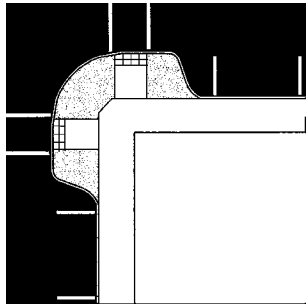
# 7

# CURB RAMPS

## CHAPTER

**Table 7 - 2. Curb Ramps: Curb Extensions and Built-up**

**Good Design:**  
A curb extension with two perpendicular curb ramps with returned curbs and level landings.



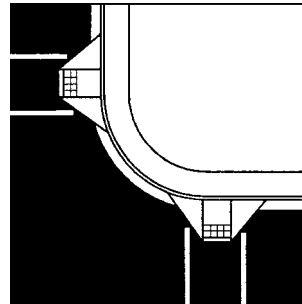
**Design Specifications:**

- Ramp slope =  $7.1 \pm 1.2$  percent
- Gutter slope = 5 percent maximum
- Changes in level = flush
- Ramp width = 1.22 m (48 in) recommended minimum
- Landing width = 1.22 m (48 in) recommended minimum
- Flare slope = 10 percent maximum
- Cross slope =  $2 \pm 0.9$  percent maximum
- Detectable warning = 610 mm (24 in)

**Recommendations:**

Two perpendicular curb ramps built on a curb extension should be installed whenever possible. The curb extension provides additional room for a level landing, increases pedestrian visibility, and reduces motorist turning speeds. Curb extensions also prevent parked cars from blocking the curb ramp.

**Acceptable Design:**  
Two built-up curb ramps.



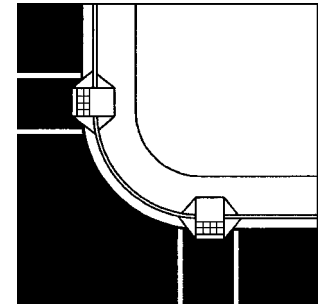
**Design Specifications:**

- Ramp slope and roadway = 8.33 percent
- Gutter slope = 2 percent maximum
- Changes in level = flush
- Ramp width = 1.22 m (48 in) recommended minimum
- Landing width = 1.22 m (48 in) recommended minimum
- Flare slope = 10 percent maximum
- Cross slope = 2 percent maximum
- Detectable warning = 610 mm (24 in)

**Recommendations:**

Two built-up curb ramps work well on narrow sidewalks when parallel ramps and curb extensions will not work. However, the pedestrian is more exposed and less visible to motorists. If built-up curb ramps are used, they should only be installed on streets with a parking lane and must not interfere with bicycle travel. More designing and retrofitting of this curb ramp style may be required, such as dropping the sidewalk, building up the crosswalk area, and blending the flares into the gutter area.

**Acceptable Design:**  
Partially built-up curb ramps.



**Design Specifications:**

- Ramp slope and roadway = 8.33 percent
- Gutter slope = 2 percent maximum
- Changes in level = flush
- Ramp width = 1.22 m (48 in) recommended minimum
- Landing width = 1.22 m (48 in) recommended minimum
- Flare slope = 10 percent maximum
- Cross slope = 2 percent maximum
- Detectable warning = 610 mm (24 in)

**Recommendations:**

Partial built-up curb ramps are similar to built-up curb ramps, but the ramp is installed partially on the sidewalk and partially in the gutter. This type of ramp is primarily recommended for use on sidewalks where available space is lacking and a slightly longer ramp is needed.

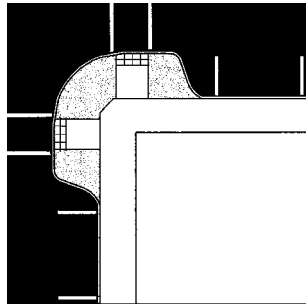
# 7

# CURB RAMPS

## CHAPTER

### Good Design:

A curb extension with two perpendicular curb ramps with returned curbs and level landings.



### Design Specifications:

Ramp slope = 7.1 percent

Gutter slope = 5 percent maximum

Changes in level = none

Ramp width = 1.22 m (48 in) recommended minimum

Landing width = 1.22 m (48 in) recommended minimum

Flare slope = 10 percent maximum

Cross slope = 2 percent maximum

Detectable warning = 610 mm (24 in)

### Recommendations:

Two perpendicular curb ramps built on a curb extension should be installed whenever possible. The curb extension provides additional room for a level landing. The bottom of the ramp is often in a more level landing area, increases pedestrian visibility, and reduces motorist turning speeds. Curb extensions also prevent parked cars from blocking the curb ramp.

- Gutter slope;
- Truncated domes;
- Curb height;
- Change of grade;
- Sidewalk approach width;
- Landing dimension and slope; and
- Flare slope.

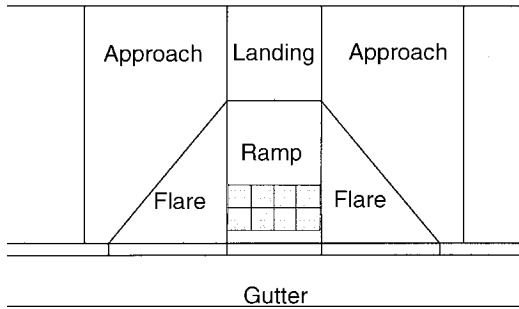


Figure 7-15. Curb ramp components.

The slopes, dimensions, and location of a curb ramp significantly impact the ability of people with disabilities to use the sidewalk independently. The following section describes the recommendations for designing accessible curb ramps. It also discusses potential barriers to pedestrian access that can result when dealing with problematic design situations.

### 7.3.1 Ramp grade

Steep grades are difficult for people who use walking aids and manual wheelchairs to negotiate because significantly more energy is needed to begin and travel on sloped surfaces. In outdoor environments, wearing heavy winter clothes or carrying packages are frequent activities that further limit an individual's ability to negotiate steep grades. Conversely, gradual grades are problematic for people with vision impairments because the transition between the sidewalk and the street is difficult to detect.

For new construction, ADAAG 4.7 permits a maximum curb ramp slope



# 7

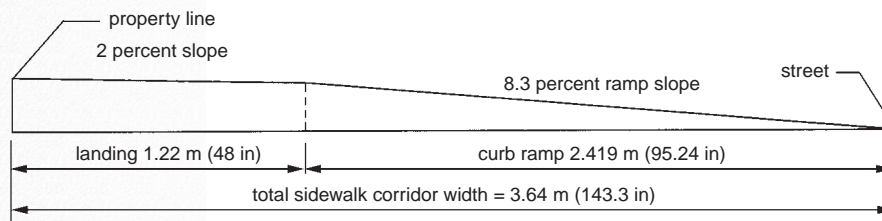
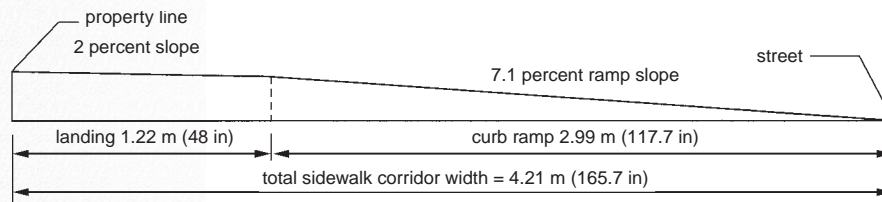
# CURB RAMPS

## CHAPTER

of 8.3 percent. However, in practice, 8.3 percent is rarely treated as a maximum but is used as the design standard that does not allow for construction tolerances. Therefore, rather than using 8.3 percent for designing curb ramp grade, a grade of 7.1 percent is recommended to allow a construction tolerance.

In some retrofitting situations, it may not be possible to design a curb ramp with a slope less than 8.3 percent.

In order to address this problem, there is an exception in ADAAG 4.1.6(3)(a) that applies only to the alteration of existing facilities that cannot meet the new construction requirements. The steeper slope specifications should also not be used for alterations where an alternate curb ramp design, such as a parallel curb ramp, would enable the ramp to be installed with a grade of less than 8.3 percent. For alterations only, ADAAG specifies that the following slopes are acceptable but only for short distances (ADAAG, U.S. Access Board, 1991):



- A slope between 8.3 percent and 10 percent is permitted for a maximum rise of 152 mm (6 in);
- A slope between 10 percent and 12.5 percent is permitted for a maximum rise of 76 mm (3 in); and
- A slope steeper than 12.5 percent should be avoided regardless of the length of the ramp.

**Figure 7-16.** A wider sidewalk corridor is needed to design a perpendicular curb ramp with a 7.1 percent slope than an 8.3 percent slope.

# 7

## CURB RAMPS

### CHAPTER

These specifications for steeper curb ramps should not be used in new construction.

#### 7.3.2 Ramp cross slope

A curb ramp allows people who use wheelchairs and other wheeled devices to negotiate the elevation change between the roadway and the sidewalk without having to negotiate the curb. People with mobility impairments often have difficulty negotiating a grade and cross slope simultaneously. Since the grade of the ramp will be significant, the cross slope should be minimized. The design specification for cross slope on the ramp should not exceed 2.0 percent.

#### 7.3.3 Ramp length

Curb ramp length is determined by the vertical change in elevation between the roadway and the sidewalk. The greater the vertical change, the longer the ramp will have to be in order to meet

the recommended grade specification. Lower curb heights enable shorter curb ramps to be used. However, if a curb height is less than the standard 152 mm (6 in), there is the potential for water to rise above the level of the curb up onto the sidewalk. Drainage inlets may have to be modified to take in more water or may need to be installed more frequently to prevent water from flowing onto the sidewalk with lower curb heights.

Table 7-3 calculates the minimum ramp length required for a 7.1 percent and an 8.3 percent ramp, based on the height of the required vertical change. The vertical change is determined as the difference between the level of the roadway and the level of the sidewalk and includes any elevation gain that occurs on the sidewalk corridor. Assuming the cross slope of the sidewalk corridor is constant at 2 percent, the formula for determining ramp length is:

$$\text{ramp length} = \frac{\text{curb height}}{(\text{ramp slope} - \text{sidewalk corridor cross slope})}$$

# 7

# CURB RAMPS

## CHAPTER

In a retrofit situation, the cross slope of the sidewalk corridor should be measured using a digital inclinometer. Once the cross slope is known, the length needed for the ramp can be accurately

determined. If the desired ramp slope is 7.1 percent and the cross slope of the sidewalk is 2 percent, the length of the ramp can be determined by the following simplified formula:

$$\text{ramp length} = \text{curb height} \times 19.6$$

If the desired ramp slope is 8.3 percent and the cross slope of the sidewalk is 2 percent, the length of the ramp can be determined as follows:

$$\text{ramp length} = \text{curb height} \times 15.9$$

**Table 7-3. Ramp length for perpendicular curb ramps based on ramp slope**

Change in Elevation	Ramp Length for 7.1 Percent Slope	Ramp Length for 8.3 Percent Slope
203 mm (8 in)	3.99 m (13.1 ft)	3.23 m (10.7 ft)
178 mm (7 in)	3.48 m (11.4 ft)	2.82 m (9.3 ft)
152 mm (6 in)	3.00 m (9.8 ft)	2.42 m (7.9 ft)
127 mm (5 in)	2.49 m (8.2 ft)	2.01 m (6.6 ft)
101 mm (4 in)	1.98 m (6.5 ft)	1.60 m (5.3 ft)

This table assumes that the sidewalk corridor has a 2 percent slope and that the corner is level.

Table 7-3 assumes a 2 percent cross slope for the sidewalk corridor, however, the actual cross slope of the sidewalk corridor will vary between sites. The table also assumes that the sidewalk is not on a hill. For steep terrain, if the curb ramp and landing are not level, the grade of the sidewalk will increase the length of the ramp. For more information about designing curb ramps on steep terrain, see Section 7.4.6.

# 7

# CURB RAMPS

## CHAPTER

### 7.3.4 Ramp width

The recommended minimum curb ramp width is 1.22 m (48 in). Where space is restricted, the width of the ramp can be reduced to 915 mm (36 in). Curb ramp width should never be less than 915 mm (36 in) because there is not enough space for people using assistive devices (e.g., wheelchairs, scooters, and crutches) to travel.

### 7.3.5 Gutter slope

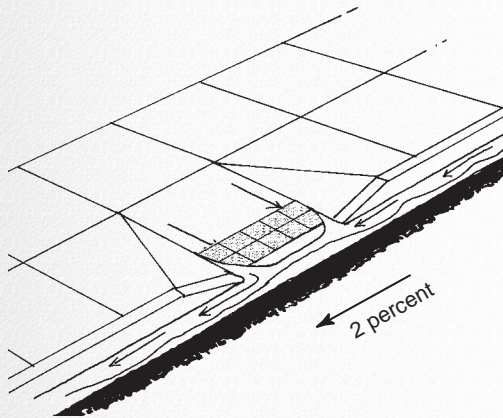
The gutter is the trough or dip that is provided for drainage purposes between the edge of the street and the curb or curb ramp. The drainage slope of the gutter is the slope parallel to the curb and roadway. The purpose of the drainage slope is to channel water down the street. Because pedestrians generally enter the roadway by crossing perpendicularly over the gutter, pedestrians experience the drainage slope of the gutter as a cross slope. Likewise, after pedestrians go down the curb ramp towards the street, they experience the cross slope of the

gutter as an uphill grade that often continues until the middle of the street because of the crown of the roadway.

If the drainage slope of the gutter is too steep, pedestrians will be required to negotiate a surface with a steep cross slope as they transition from the curb ramp to the roadway. Therefore, the drainage slope of the installed gutter should not exceed 2 percent. The cross slope of the gutter should also be considered in relation to the installation of curb ramps. If the gutter cross slope is significant, the change of grade experienced by pedestrians as they travel from the downhill slope of the curb ramp to the uphill slope of the gutter will be problematic for wheelchair users (see Section 7.3.7). On most curb ramps, to avoid rapidly changing grades, the cross slope of the street and gutter approach to the curb ramp should not exceed 5 percent.

#### 7.3.5.1 Gutter slope at diagonal curb ramps

At the bottom of a diagonal curb ramp, the slope of the gutter and adjoining roadway should not exceed 2 percent in



**Figure 7-17.** The gutter slope should be designed to direct water across rather than towards the bottom of the curb ramp.



# 7

# CURB RAMPS

## CHAPTER



**Figure 7-18.** Detectable warnings at the bottom of curb ramps enhance access for people with vision impairments (Austin, Texas).

### Case Study 7-1

Austin, Texas, has a long standing commitment to installing detectable warnings on the surface of curb ramps.

any direction. The level area should extend for a minimum distance of 1.22 m (48 in) in all directions to provide adequate maneuvering space. The difficulty of achieving a level area at the bottom of a diagonal curb ramp is one of the primary reasons that this design does not work well in many pedestrian environments.

### 7.3.6 Transition detection

Steep ramp grades are difficult for people with mobility impairments to negotiate. However, gradual grades make it more difficult for people with vision impairments to detect the transition between the sidewalk and the street. Research to determine the impact of curb ramps on people with vision impairments has shown that on ramps that comply with ADAAG 4.7 (i.e., have a maximum grade of 8.3 percent), 48 percent of people with vision impairments cannot reliably detect the ramp to street transition (Bentzen and Barlow, 1995). For this reason, a 610 mm (24 in) detectable warning (see Section 7.3) across the bottom of the curb

ramp, at the boundary between the ramp and the street, is recommended on all curb ramps. Detection of the curb ramp by people with visual impairments can be further enhanced if the change of grade between the sidewalk and ramp is abrupt, but this is not a reliable detection tool and can cause hazardous tipping for wheelchair users. However, designers should take care to ensure that the change of grade between the sidewalk and the ramp does not exceed 11 percent. See Section 7.3.7 for additional information on change of grade.

### 7.3.7 Change of grade

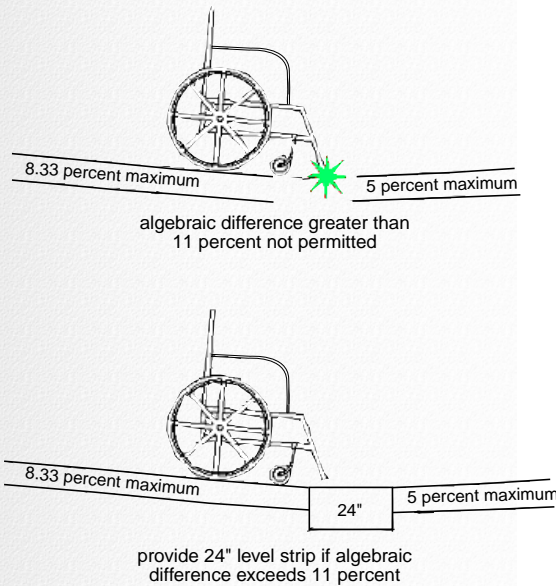
A change of grade is an abrupt difference between the grade of two adjacent surfaces or planes. When considering the needs of pedestrians, change of grade can be evaluated over a 610 mm (24 in) interval, which represents the approximate length of a single walking pace and the base of support of assistive devices such as wheelchairs or walkers.

In the sidewalk environment, the change of grade can be determined by:

# 7

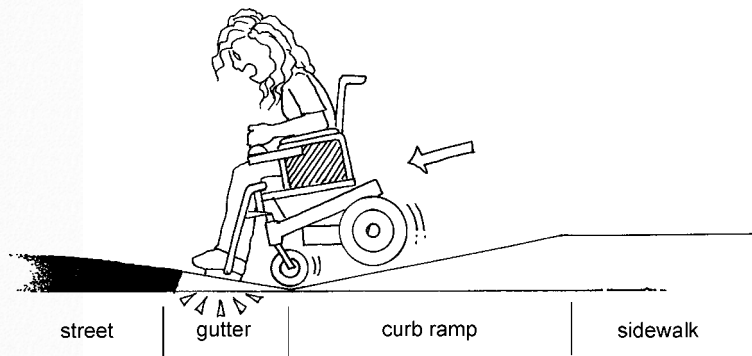
# CURB RAMPS

## CHAPTER



**Figure 7-19.** Change of grade. Transitions should have minimum grade changes (less than 11%) for a gradual transition for wheelchair users.

**Figure 7-20.** Grade changes that happen over a short interval, such as between the gutter and ramp, can cause wheelchair users to fall forward.



- Adding the two grades together if the pre- and post-transition grades are in opposite directions (e.g., one uphill and one downhill). For example, if the slope of the curb ramp is 7 percent and the inward slope of the gutter is 3 percent, the change of grade is 10 percent ( $7 + 3 = 10$ ).
- Subtracting one grade from the other if the pre- and post-transition grades are in the same direction (e.g., an uphill followed by a significantly steeper uphill). For example, if a curb ramp with an 8 percent grade leads up to a

sidewalk with a 15 percent grade, the change of grade is 7 percent ( $15 - 8 = 7$ ).

### 7.3.7.1 Impacts of change of grade on people who use wheelchairs

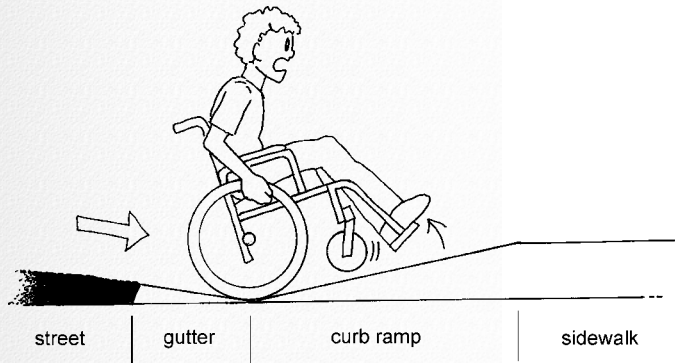
A rapid change of grade, such as what might be found between the base of a curb ramp and the gutter, may be difficult to negotiate because the wheelchair's footrests or anti-tip wheels cannot clear the ground surface. In general, footrests are positioned low to the ground and extend beyond the front casters. Anti-tip wheels are placed on the back of some wheelchairs, behind the rear axle, to improve stability. Both the footrests and anti-tip wheels limit the clearance height of the wheelchair. Clearance may be a particular problem at an abrupt change of grade because the footrests or anti-tip wheels extend beyond the wheelbase of the wheelchair and therefore may contact the surface across the transition point from where the wheels are located.



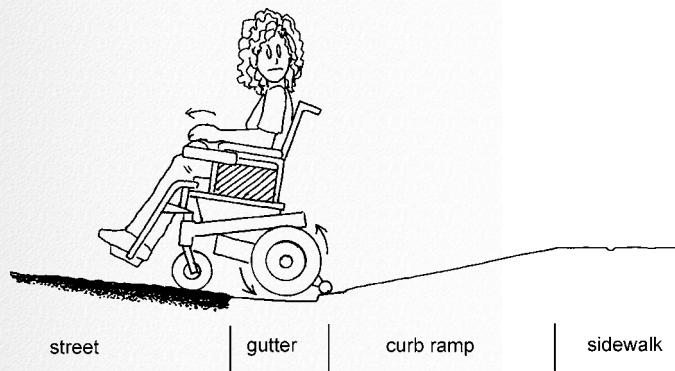
# 7

# CURB RAMPS

## CHAPTER



**Figure 7-21.** Grade changes that happen over a short interval, such as between the gutter and ramp, can cause wheelchairs to flip over backwards.



**Figure 7-22.** Anti-tip wheels and devices in the back bottom of the wheelchair can get caught when traveling over a significant change in grade.

A further complication associated with severe changes in grade is the increased risk of tipping if the wheelchair user is traveling with speed such as when going down the slope of a curb ramp. If the footrests catch on the ground, the wheelchair will come to an abrupt stop; the forward momentum of the individual and wheelchair is interrupted and can cause the wheelchair user's upper body to fall forward or can cause the user and the wheelchair to tip forward.

If the user moves quickly through the change in grade, without compromising the ground clearance of the wheelchair, the dynamic stability of the wheelchair may still be compromised. Dynamic stability can be compromised because the momentum of the wheelchair will rotate backwards as the

wheelchair climbs up the gutter slope. If there is a severe change in grade, this may cause the wheelchair to tip over backwards. Any amount of height transition such as lips between the curb ramp and the gutter can further contribute to the stability problems experienced by wheelchair users (Section 7.3.8).

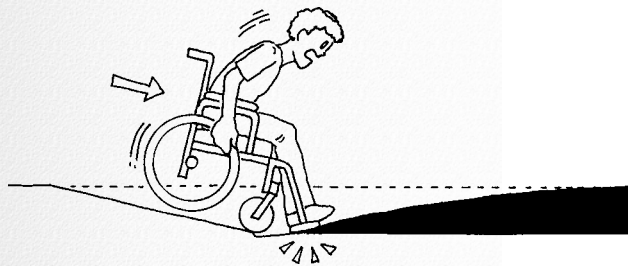
### **7.3.7.2 Recommendations for maximum change in grade**

In order to avoid difficult or potentially hazardous changes in grade, sidewalks and curb ramps should be designed with gradual grade changes whenever possible. Where abrupt changes are required, the difference in grade between adjacent surfaces should be minimized. The exact change of grade that will be problematic varies among wheelchair users and is dependent on a variety of factors including the design of the wheelchair and the speed at which the user is traveling. Additional research is needed to provide a more comprehensive evaluation of the impact of change of grade on wheelchair users.

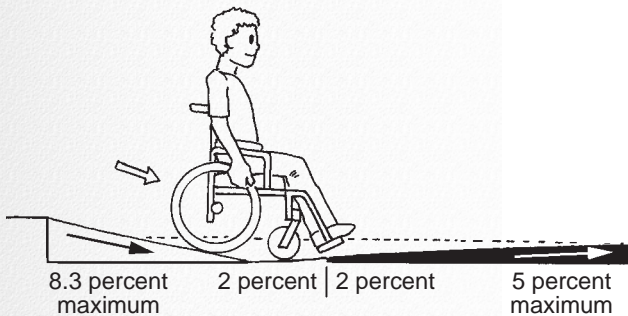
# 7

# CURB RAMPS

## CHAPTER



**Figure 7-23.** Overlaying existing asphalt without milling away the old asphalt can create steep slopes on either side of the centerline.



**Figure 7-24.** Milling away asphalt before resurfacing results in a smooth transition between curb ramps, gutters, and streets.

The maximum recommended change of grade is 11 percent. Whenever possible, sidewalks and curb ramps should be designed with a maximum grade change that is less than 11 percent to ensure that the maximum grade change between the installed surfaces will remain less than 11 percent after street resurfacing or other roadway maintenance activities. Change of grade can be minimized by an addition of 2.75 m (9 in) of 2 percent ramp and 2.75 m (9 in) of 2 percent gutter. The 5.50 m (18 in) of gradual change of grade can prevent wheelchair users from flipping forward or backward.

### 7.3.7.3 Street resurfacing

The manner in which streets are maintained significantly impacts the slope of the curb ramp approach from the street. Asphalt is an economical and

durable material used to pave most roads. In the past, repairing damage to asphalt roads typically entailed overlaying the existing pavement with more asphalt. Then, as the asphalt layers built up, the roadway crown created steep slopes on either side of the centerline. This also created an abrupt transition between the gutter and the asphalt surface. These slopes significantly exaggerate the intended change of grade.

Recent advances in street repaving allow recycled asphalt to be used in new resurfacing projects. To take advantage of the old material, roads are milled before being resurfaced. Milling should be completed from gutter to gutter. Furthermore, if the road has maintained its original crown, the amount of asphalt removed from the road for recycling should equal the amount of asphalt being added to the road for resurfacing. However, if the road has not been milled during past resurfacing, it may be necessary to remove more asphalt than is being added to restore the crown to its original slope.

# 7

# CURB RAMPS

## CHAPTER

When resurfacing is done to a road, access improvements must be made to the curb ramp and driveway crossings that are adjacent to the roadway surface. The Department of Justice mandates that “resurfacing beyond normal maintenance is an alteration” (U.S. Department of Justice, 1994a). In contrast to maintenance activities, alterations such as resurfacing trigger the requirements to provide accessibility improvements such as curb ramps.

likelihood of problems for individuals with balance limitations.

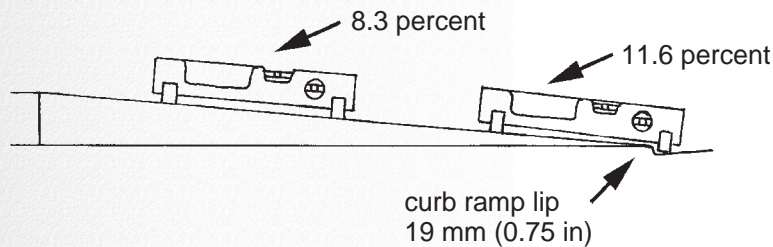
Transition points found within the curb ramp area include:

- Street and gutter;
- Gutter and ramp;
- Ramp and landing; and
- Landing and sidewalk approach.

The two most problematic transition points occur between the street and the gutter and the gutter and the curb ramp. In these situations, it is critical that the combination of change in grade and transition height be minimized. In addition to contributing to a user’s dynamic instability, curb ramp lips will also change the angle of the wheelchair, as if the wheelchair were on an increased grade. For example, if a ramp is designed with an 8.3 percent slope and has a 19 mm (0.75 in) lip at the bottom of the ramp, the actual grade the wheelchair user has to negotiate is 11.6 percent. Curb ramp lips are not allowed by ADAAG.

### 7.3.8 Transition height

Transition points between adjacent curb ramp surfaces should be flush. Even a 13 mm (0.5 in) change in level combined with a change in grade is significant, a height transition may also increase the



**Figure 7-25.** The actual slope a wheelchair user will have to negotiate on an 8.3 percent slope with a 0.75 mm lip is 11.6 percent.

# 7

## CURB RAMPS

### CHAPTER

#### 7.3.9 Sidewalk approach width

Sidewalk approaches are the sections of sidewalk to the right and left of the landing of a curb ramp. The sidewalk approach should reflect the same design qualities as the sidewalk corridor leading up to it. At a minimum, the approach should have at least 915 mm (36 in) of clear space. If the approach is not clear of obstacles, the curb ramp may be rendered useless to people with mobility impairments. If included as part of a combination curb ramp, the approach may be slightly graded because the level landing is below the elevation of the adjoining sidewalk.

#### 7.3.10 Landing dimension and slope

A landing is the level area that allows users to maneuver on and off of the curb ramp. The provision of a landing is also important for people who are continuing along the sidewalk and do not want to cross the street. On a perpendicular or diagonal curb ramp, a landing is located at the top of the ramp facing the ramp path.

On a diagonal curb ramp, a level maneuvering area should also be located in the roadway at the bottom of the ramp. When a parallel curb ramp design is used, landings are located within the sidewalk at the top of each ramp and at street level between the two ramps.

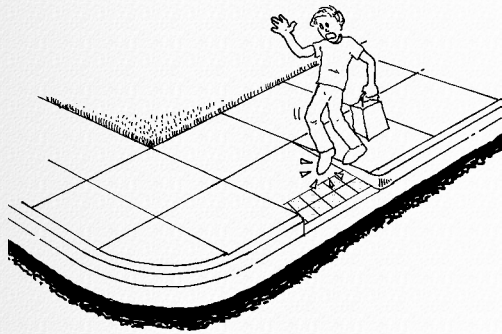
When installed, the slope of a landing should not exceed 2 percent in any direction because of the maneuvering required on the landing. Furthermore, the landing should extend at least 1.22 m (48 in) minimum beyond the top of the curb ramp to allow people to maneuver off of the ramp and onto the path of travel within the pedestrian zone. If space is limited and a 1.22 m (48 in) landing absolutely cannot be provided, the landing length and space should be as large as possible, with an absolute minimum width of 915 mm (36 in). If the width of the landing is reduced to 915 mm (36 in), wheelchair users may have to travel over a portion of the flare in order to move off of the ramp and onto the sidewalk. To compensate, the slope at the top of the flare should be blended to allow for easier



# 7

# CURB RAMPS

## CHAPTER



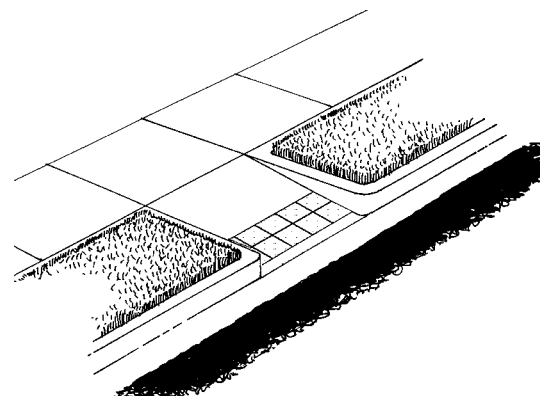
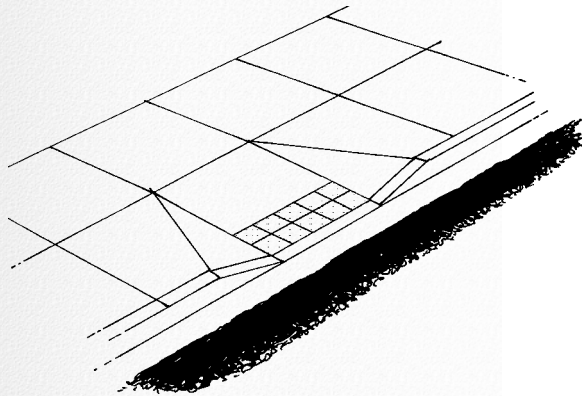
**Figure 7-26.** Returned curbs become a tripping hazard when located in the pedestrian path of travel.

travel across the flare surface (see Section 7.3.11), and the width of the curb ramp should be widened up to 1.22 m (48 in) to maneuver a wheelchair over a smaller portion of the flare (see Figure 7-32).

### 7.3.11 Returned curbs and flares

A returned curb or flare is the transition area between the curb ramp and the sidewalk. A returned curb is the preferred transition because:

- The edges of the curb ramp are more clearly delineated;
- It enables the posts for pedestrian signals to be positioned closer to the curb ramp;
- The sides of the curb ramp are easier to detect by people with vision impairments who use a long white cane for navigation;
- The returned curb channels water and debris to the bottom of the curb ramp more effectively; and
- A returned curb is less expensive and easier to construct.



**Figure 7-27.** Flares provide a gradual transition between the sidewalk and the ramp. Returned curbs transition much more abruptly and should only be used in areas that pedestrians would not normally travel such as planting strips.

Returned curbs should only be used where pedestrians cannot or do not have to walk across the ramp. For example, when the curb ramp is located in a planting strip or the clear path of travel is not adjacent to the side of the ramp (e.g., if a traffic signal is in front of the returned curb).

In areas where there is a potential for pedestrians to travel across the curb

# 7

## CURB RAMPS

### CHAPTER

ramp, a flare should be used instead of a returned curb. The flare provides a gradual transition between the curb ramp and the sidewalk so that the tripping hazard for pedestrians is minimized. Although some pedestrians may choose to travel over the flare, it should not be considered part of the pedestrian's path of travel because of the severe change of cross slope.

Improving detectability for people with vision impairments is another reason to design with returned curbs rather than flares. At the sidewalk-to-flare transition, it is difficult for some users to determine if they are at the beginning of a flare or at the top of a curb ramp. If the user mistakes the flare for the ramp, he or she will travel down the sloped surface and reach the curb ramp mistakenly thinking he or she is at the street. The lack of traffic immediately adjacent to the individual standing at the ramp is not always a clear indication of the user's location because a similar situation would occur at the edge of a roadway with a parking lane adjacent to the curb. Skillful blind travelers understand this dilemma,

but distinguishing the landing/ramp from the ramp/roadway remains difficult.

If a flare is provided, the following recommendations should be applied:

- If the landing is at least 1.22 m (48 in), the flares should have a maximum slope of 10 percent;
- If the landing is between 915 mm (36 in) and 1.22 m (48 in), the maximum slope of the flares should be 8.3 percent because wheelchair users may have to travel over a small portion of the flare to maneuver onto the narrow landing; and
- Landings should not be narrower than 915 mm (36 in).

#### 7.4 Design considerations for curb ramp installation

The conditions at the intersection often have a significant influence on the type of curb ramp that is most appropriate. The following sections examine a range of installation considerations including:



# 7

# CURB RAMPS

## CHAPTER

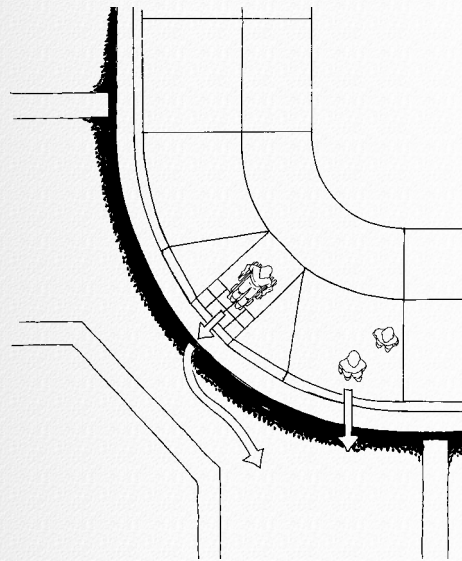
- Curb ramp placement at an intersection;
- Influence of turning radii on curb ramp design;
- Determining sidewalk width at pedestrian crossings;

- Curb ramps at high curbs;
- Curb ramps on narrow sidewalks; and
- Curb ramps on steep terrain.

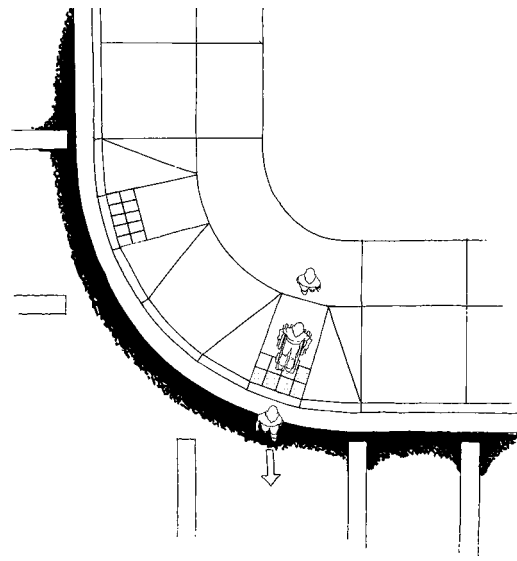
### 7.4.1 Curb ramp placement at an intersection

Curb ramp placement should be determined by the design constraints of the sidewalk, street, and intersection. The preferred design is to have a separate curb ramp aligned with each crossing direction to allow all pedestrians to cross at the same location. When pedestrians using a curb ramp are forced to cross at a different location, it makes them less visible to drivers and increases the potential for vehicle contact. At most intersections, a pair of perpendicular curb ramps placed at 90 degree angles to one another is the optimal design for meeting these criteria.

The design requirements of diagonal curb ramps, such as providing a level



**Figure 7-28.** When a single diagonal curb ramp is provided, wheelchair users cross in a different location than other pedestrians and are vulnerable to turning traffic.



**Figure 7-29.** When two perpendicular curb ramps are provided, all users cross in the same location as shown here.

# 7

## CURB RAMPS

### CHAPTER

area at the bottom of the ramp, are often difficult to achieve. Furthermore, a single diagonal curb ramp at the apex of each corner creates a variety of problems because pedestrians using the ramp are directed towards the center of the intersection. Pedestrians using the ramp must maneuver at the bottom of the ramp to cross in the proper direction.

People with vision impairments are trained (or learn from experience) not to rely on the direction of the curb ramp as a cue for determining the direction of the destination curb because of the abundance of curb ramps that are not aligned with the crosswalk. Instead they align themselves with their destination curb using traffic sounds and other clues. Nevertheless, if they are standing on a curb ramp that slopes toward the center of the intersection, they may still veer towards the center of the intersection while completing their crossing. This situation is most likely to occur if the pedestrian with a vision impairment is distracted, new to an area, or inexperienced with his or her impairment.

In new construction, the installation of two ramps should be the norm. Two curb ramps should also be the norm when alterations are performed:

- In urban areas;
- At signalized intersections;
- On arterials and other roads with moderate to heavy traffic volumes; and
- Where the placement of utilities does not interfere with the installation of two curb ramps.

A diagonal curb ramp or a single parallel curb ramp may be acceptable in retrofitting situations to help conserve resources. For example, if sidewalk width is limited, a single parallel curb ramp will often be the best design. Situations in which diagonal curb ramps may be considered include:

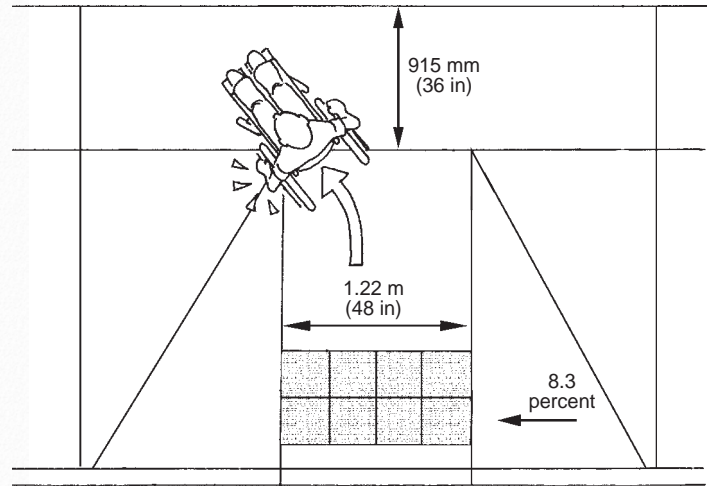
- Some residential areas, where traffic volumes are very low and

# 7

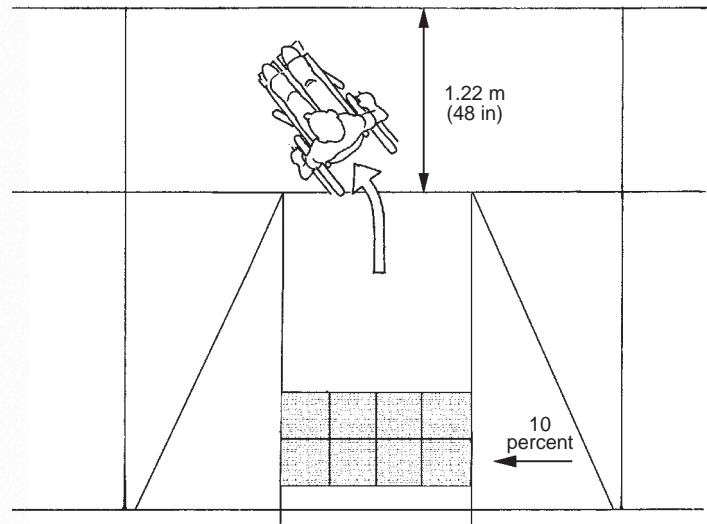
# CURB RAMPS

## CHAPTER

**Figure 7-30.** The 1.22 m (48 in) width of this curb ramp provides sufficient turning space for this wheelchair user. The maximum slope of the flares at this curb ramp should be 10 percent.



**Figure 7-31.** The 915 mm (36 in) width of this landing forces this wheelchair user to travel over a portion of the flare to maneuver onto the narrow landing. For this reason, the maximum slope of the flare should not exceed 8.3 percent and should be blended at the top apex. The ramp width should be widened up to 1.22 m (48 in) to allow for a tighter turn onto the landing.



intersections do not require signalization; and

- Where utilities prevent the installation of two perpendicular curb ramps.

### 7.4.2 Influence of turning radii on curb ramp design

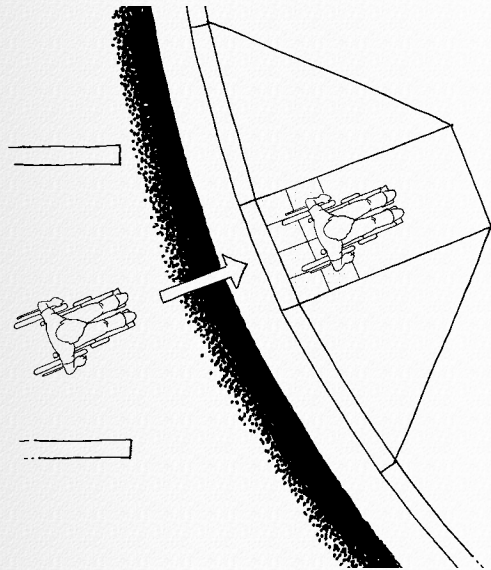
Curb ramps should be built so that the beginning of the sloped area is perpendicular to the user's path of travel. At a corner with a tight turning radius, the ramp of a perpendicular curb ramp will be at a 90 degree angle to the curb and will be oriented parallel to the crosswalk. This is helpful to users because they can follow the ramp path directly across the street. Curb ramps aligned with the crosswalk also minimize the maneuvering that wheelchair users must perform to use the ramp.

At corners with larger turning radii, the curb ramp cannot always be parallel to the direction of the crosswalk while the ramp slope is perpendicular to the curb. In this situation, priority should

# 7

## CURB RAMPS

### CHAPTER

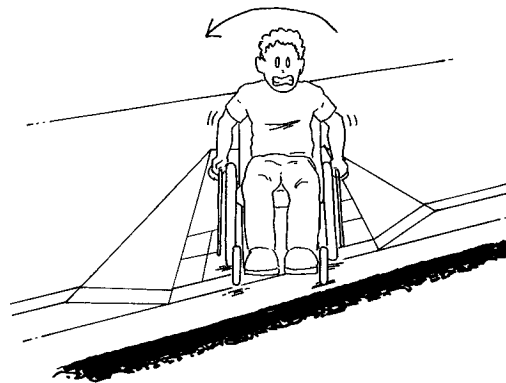


**Figure 7-32.** Sidewalks are easier for wheelchair users to travel on if the ramp slope is perpendicular to the curb because the chair does not become unstable as it does when one front wheel strikes a curb ramp before the other.

be given to ensuring that the ramp slope is perpendicular to the curb. However, because the curb ramp is not aligned with the crosswalk, the crosswalk must be sufficiently wide enough to allow the user to line up with the curb ramp while still in the street.

If the ramp slope is not perpendicular to the curb, wheelchair users either have to:

- Negotiate changing cross slopes and changing grades simultaneously since one side of the chair will be in the gutter while the other is still on the ramp; or



**Figure 7-33. PROBLEM:** Wheelchair users can be very unstable when traveling down a narrow ramp with a slope that is not perpendicular to the curb, because all four wheels are not touching the ground at all times.

- Turn on the ramp in order to have both wheels move from the ramp to the gutter at the same time. When traveling down a curb ramp, the turn must be completed while on a significant grade and within a narrow space.

Both of these situations significantly reduce the accessibility of the curb ramp for wheelchair users.

In some cities, designers have chosen to align curb ramps on large radii curves parallel to the crosswalk, even though the curb ramp is not perpendicular to the curb. As a result, the change of grade between the ramp and street becomes skewed relative to the path of travel. The theoretical advantage of this design is that people with vision impairments could use the path of the curb ramp to direct them across the street. However, this benefit has limited impact because people with vision impairments tend not to rely on curb ramps for directional information due to the abundance of curb ramps that are not aligned with the proper crossing direction.

# 7

# CURB RAMPS

## CHAPTER

### 7.4.3 Determining sidewalk width at pedestrian crossings

A wider sidewalk corridor is often needed at a pedestrian crossing than at other locations. For this reason, the width of the sidewalk corridor at the pedestrian crossing should be determined separately from the width of the sidewalk corridor at other locations. The width required at the pedestrian crossing will depend on the:

- Type of crossing;
- Curb ramp design;
- Elevation change between the roadway and sidewalk;
- Terrain on the site; and
- Volume of pedestrian traffic.

Each of these factors should be carefully considered when making a decision on the width of the sidewalk corridor at a pedestrian crossing. In addition, conditions on the site, such as utilities or buildings, will also influence

the width of the sidewalk corridor during alterations to existing facilities. Making an isolated decision on one factor may unnecessarily restrict the options available for other factors. For example, selecting a narrow corridor width based on a low volume of pedestrian traffic may limit the types of curb ramps that will fit within the sidewalk corridor.

#### 7.4.3.1 Type of crossing

The width of the sidewalk corridor will depend on the type of pedestrian crossing. At a midblock crossing, traffic volumes are generally less. At a corner intersection, pedestrian traffic volumes are generally higher, and two ramps should be provided at each corner. Therefore, depending on the other factors at the site, a corner intersection will generally require more right-of-way than a midblock crossing.

#### 7.4.3.2 Curb ramp design

In new construction, curb ramp design is a primary factor in determining the width required for the sidewalk



# 7

## CURB RAMPS

### CHAPTER

corridor at a pedestrian crossing. Each type of curb ramp will require a different width, depending on the slope of the ramp and the width needed for a landing (see Section 7.2). For example, a perpendicular curb ramp with a landing will require a wider sidewalk corridor than a parallel curb ramp. In existing facilities, the selection of curb ramp design is often constrained by the width of the available right-of-way.

If perpendicular curb ramps are being installed, the length of the ramp significantly impacts the width of the pedestrian corridor. The elevation change between the roadway and the sidewalk is primarily determined by the height of the curb. However, the cross slope of the sidewalk corridor should also be included in elevation calculations. Consider this example of a perpendicular curb installed at an intersection with a standard curb height of 152 mm (6 in) and a sidewalk corridor cross slope of 2 percent. The sidewalk corridor will have to be approximately 4.22 m (13.8 ft) wide to install a ramp with a 7.1 percent slope

and a 1.22 m (48 in) landing. For more information on determining ramp length, see Section 7.3.3.

#### **7.4.3.3 Steep terrain**

If a perpendicular curb ramp is used on a steep sidewalk, the terrain will also influence the width of the sidewalk corridor at the pedestrian crossing. If the terrain slopes steeply up from the street, the vertical change between the sidewalk and street will be much larger and therefore the curb ramp will need to be longer. This design problem can be avoided if the sidewalk grade is slightly increased to allow the curb ramp and landing area to be level. Section 7.4.6 contains additional information on designing curb ramps on steep slopes.

#### **7.4.3.4 Volume of pedestrian traffic**

The anticipated volume of pedestrian traffic must also be considered when determining the width of the sidewalk corridor at a pedestrian crossing. Areas with higher volumes of pedestrian traffic

# 7

# CURB RAMPS

## CHAPTER

### Case Study 8-3

To mitigate tall curbs built for flash flooding, the town of Silver City, New Mexico installed a unique combination of short steps and long, parallel ramps to meet the needs of both wheelchair users and walking pedestrians.

will require wider ramps and larger landings to enable a continuous, two-way flow of traffic and provide sufficient space for pedestrians to collect while waiting to cross. Additional information about pedestrian capacity should be obtained from the Highway Capacity Manual (Transportation Research Board, 2000).

### 7.4.4 Curb ramps at high curbs

In some areas of the United States, flash floods and heavy rains add an additional challenge for sidewalk

designers. To prevent water from coming up onto the sidewalk, high curbs are often installed. When high curbs are used, it is difficult to build curb ramps that are not excessively steep or long.

In areas with curbs that are higher than the standard 152 mm (6 in), a combined parallel and perpendicular curb ramp may be a viable option. The parallel ramps gradually slope down as they approach the pedestrian

crossing so that the vertical change between the sidewalk and street is reduced. This reduction in vertical change enables the installation of a shorter perpendicular curb ramp than would otherwise be required for a curb of the same height (see Section 7.1.3). The addition of a partially built-up curb ramp in the gutter area can also be used to increase the length of the curb ramp resulting in a more gradual slope.

In a response to the problem of very steep curbs, Silver City, New Mexico, created the following solution:

- Short stairs were installed at the apex of the corner for most pedestrians who can negotiate short steps more easily than ramps; and
- Side ramps similar to the ramps used in front of buildings were installed with hand railings.

If the Silver City model is followed, a level landing should be provided at intervals of not more than 9.14 m (30 ft). In addition, the landing dimensions should



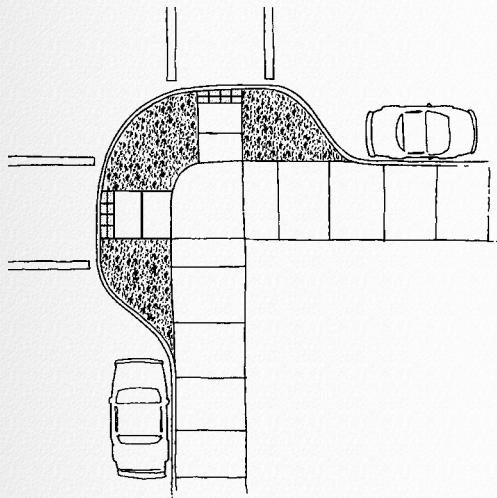
**Figure 7-34.** High curbs should be designed to provide access for both walking pedestrians and wheelchair users.

# 7

# CURB RAMPS

## CHAPTER

be a minimum of 1.525 m x 1.525 m (60 in x 60 in) where there is a significant change in direction, such as at the apex of a switchback (ADAAG 4.8). State or local regulations may require a larger landing. For example, California requires a minimum landing dimension of 1.830 m x 1.830 m (72 in x 72 in) for a change in direction greater than 30 degrees. In general, the landing dimensions for a switch back are larger than the landing dimensions of a standard curb ramp because the T-shaped intersection that is traditionally found between the sidewalk and the curb ramp is not available.



**Figure 7-35.** Curb extensions extend corners into parking lanes and provide space for curb ramps.

### 7.4.5 Curb ramps on narrow sidewalks

Narrow sidewalk corridors are problematic because the preferred design of two perpendicular curb ramps cannot be provided in conjunction with level landings within the available space. In new construction, curb ramps at all pedestrian crossings must be considered when determining the width of the sidewalk corridor.

To retrofit narrow sidewalks with accessible curb ramps, designers should consider the following solutions:

**SOLUTION 1** — Add curb extensions to extend the corner to the outer edge of the parking lane.

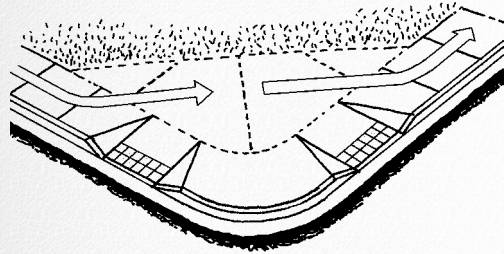
The curb extension is an excellent design strategy for providing additional space to enable the installation of perpendicular curb ramps while maintaining a level path of travel on the sidewalk that also serves as a landing. The curb extension provides pedestrians more protection from vehicular traffic than that of a built-up curb ramp. Furthermore, if a curb extension is installed on an existing road, the height of the curb can be significantly reduced due to the crown of the road that causes the edge of the curb extension to be at a higher elevation than the edge of the sidewalk. A lower curb at the corner is beneficial because it allows for the installation of shorter curb ramps. Depending on the slope of the roadway crown, the curb may be totally eliminated, creating a raised crosswalk. Detectable



# 7

# CURB RAMPS

## CHAPTER



**Figure 7-36.** Additional right-of-ways to widen sidewalks can be obtained either through purchase, an easement, or donation of fee title.



**Figure 7-37.** Parallel curb ramps work well on narrow sidewalks but require users continuing on the pathway to negotiate two ramp grades.

warnings are critical at raised crosswalks. For more information about curb extensions, see Section 8.9.

**SOLUTION 2** — Widen the entire sidewalk either by securing additional right-of-way from the adjacent property owner or by taking right-of-way from the roadway.

Widening the entire sidewalk corridor is an effective solution because it allows the most direct path of travel for pedestrians traveling along the sidewalk. If widening the entire sidewalk corridor is not possible, securing additional right-of-way only at the corner will enable the installation of a jogged landing at the curb ramp. For additional information about widening sidewalks, refer to Section 4.1.4 on improving access on narrow sidewalks.

**SOLUTION 3** — Install a parallel curb ramp or a combined parallel and perpendicular curb ramp.

Because the ramps are parallel to the sidewalk, these designs permit an increase in the length of the ramp without having to increase the width of the sidewalk corridor. See Sections 7.2.3 and 7.2.4 for more information about parallel or combined curb ramps in solution 2.

**SOLUTION 4** — Manipulate the height of the curb for a short distance on either side of the curb ramp.

Lowering the curb height and the area for curb ramp placement from the standard 152 mm (6 in) height to a 75 mm (3 in) height, for example, would significantly reduce the space required to install a perpendicular curb ramp. If the curb height and ramp replacement area are lowered, careful planning is needed to ensure that there is adequate drainage so that water does not flood onto the sidewalk at the point where the curb

# 7

# CURB RAMPS

## CHAPTER

height is reduced. To prevent ponding, drainage inlets along the gutter should be located on either side of the curb ramp and uphill of the area with a reduced curb height.

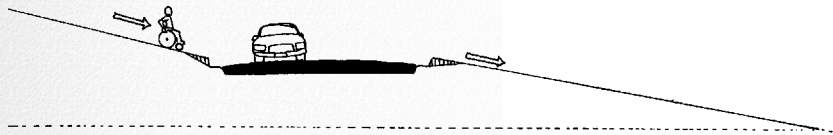
### 7.4.6 Curb ramps on steep terrain

Sidewalks built on steep terrain make access difficult for people with mobility impairments. Although some design strategies can be employed to improve access, steep grades will always present difficulties for people with mobility impairments and should be avoided whenever possible. In the past, some designers have decided not to provide curb ramps on steep sidewalks because of the

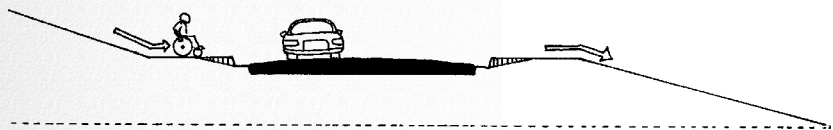
erroneous assumption that individuals with mobility impairments could not travel on significant grades. However, even if the terrain is extremely steep, curb ramps should be provided so individuals using powered mobility devices (e.g., a scooter) or traveling with assistance will be able to access the sidewalk.

When addressing steep grades at an intersection, it is best to extend the level area of the intersection to include the curb ramp and the landing. Although this significantly increases the grade of the path leading toward or away from the intersection, it is recommended because it enables people to cross the roadway and transition from the roadway to the sidewalk on a level surface. If this segment of the sidewalk corridor is not level, the problems caused by steep terrain are often magnified because:

- The slope of the curb ramp is compounded by the slope of the sidewalk; and
- The steep slope of the curb ramp, which people with vision



**Figure 7-38. POTENTIAL PROBLEM:** When the curb ramp section of the sidewalk corridor is not level, curb ramp grades are significantly increased and users cannot quickly move out of the street.



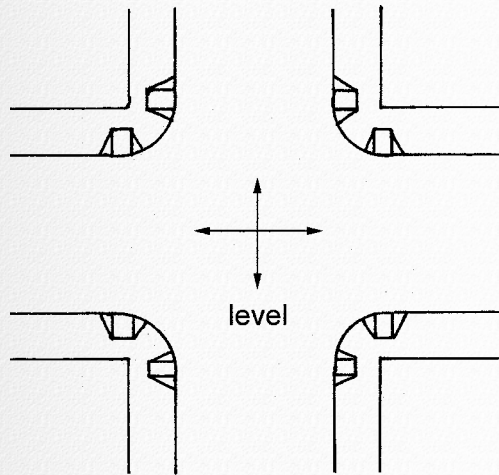
**Figure 7-39. GOOD DESIGN:** The level area of an intersection should be extended to include the curb ramps and the level landings above them.



# 7

# CURB RAMPS

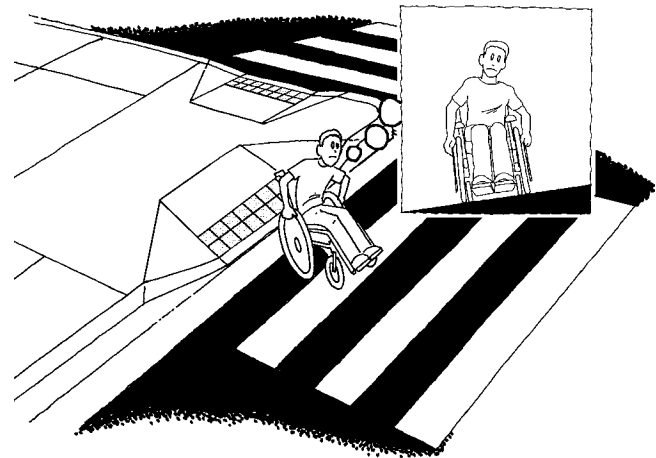
## CHAPTER



**Figure 7-40.** The shaded area represents the portion of the intersection that should be level for pedestrian travel.

impairments would normally be able to detect, may become “invisible” in relation to the generally steep terrain.

In addition to providing well-designed curb ramps, extending the level area of the street intersection into the crosswalk areas will also ensure that the crosswalks are level. If the grade of the street slopes up or down, the slope of the street becomes a cross slope for pedestrians (in the crosswalk).



**Figure 7-41.** If intersections are not level, the slope of the roadway translates into a difficult cross slope for wheelchair users to travel across.

In a retrofit situation, where only the roadway is level, curb extensions can be used to ensure that the sidewalk to roadway transition area (e.g., curb and ramp) is not located on a steep slope. When designing curb extensions, it is preferable to include landscaping, such as grass, to make the location of the curb ramp easier to detect (see Figure 7-38). The width of the curb ramp can also be expanded so that all pedestrians use the ramp instead of traveling on the landscaped areas of the curb extension. Flares should be used only in situations where the entire surface of the curb extension is paved.

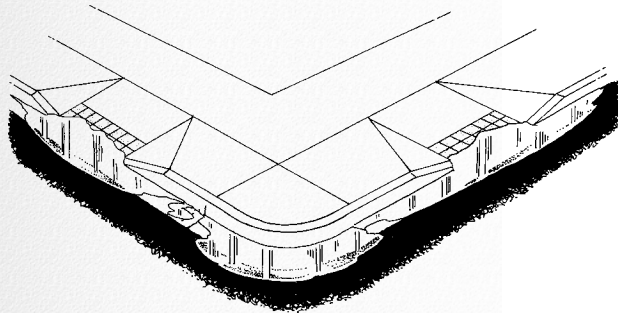
### 7.5 Curb ramp drainage

Poor drainage at the bottom of a curb ramp is inconvenient to all pedestrians. It is a particular nuisance for people who rely on the curb ramp for access and who will, therefore, not be able to avoid the area. When the water eventually dries up, debris, which further impedes access, is usually left at the base of the ramp.

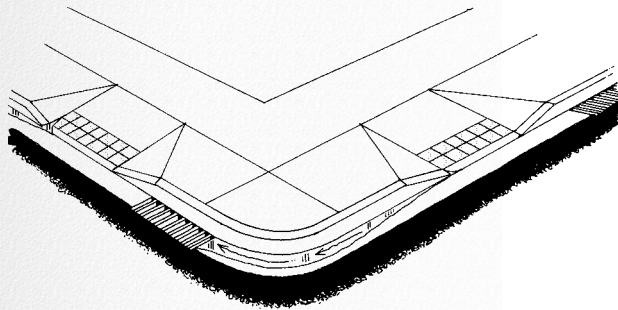
# 7

# CURB RAMPS

## CHAPTER



**Figure 7-42. POTENTIAL PROBLEM:** Curb ramps that are susceptible to pond formation are inconvenient and unsafe (especially when water freezes) for all sidewalk users.



**Figure 7-43. GOOD DESIGN:** Locating drainage inlets uphill from curb ramps prevents puddles and debris from blocking the path of travel.

In cold-weather locations, water that does not drain away can turn into slush or ice, creating a more hazardous situation.

Most drainage systems focus on channeling water to the corner of the street. However, care must be taken in development of the grading plan to ensure that drainage off the sidewalk is directed across and down towards the bottom of a curb ramp and away from curb ramp. The grading plan should specify:

- Dimensioned distances, elevations, and inlet/catch basin locations;
- Curb/gutter elevation (the ends, center, and quarter points are normally needed in each curve); and
- Sidewalk, pavement, ramp, and gutter slopes.

Designers, surveyors, contractors, and construction inspectors all have a role in ensuring adequate drainage at the bottom of all curb ramps. The following design strategies are recommended:

- Drainage inlets should be located adjacent to the uphill side of a curb ramp;
- Gutter slopes should be designed to guide water flow away from the curb ramp;
- The gutter should be smooth with a continuous slope to prevent water from ponding on more level areas;
- Maintenance programs should be established to periodically remove gutter debris;
- The installed slope of the gutter around the base of the curb ramp should be a minimum of 0.5 percent

# 7

## CURB RAMPS

### CHAPTER

and a maximum of 2 percent. A pedestrian experiences the slope of the gutter as a cross slope. This range of slopes is designed to ensure adequate drainage on a paved surface but still allow as level a surface as possible for pedestrians

who will be negotiating a change in grade in addition to the cross slope at the gutter; and

- Height transitions associated with cracks or expansion joints should be avoided.

# 8

# PEDESTRIAN CROSSINGS

## CHAPTER

## Pedestrian Crossings

Designing an effective pedestrian crossing involves the correct layout of a variety of elements including:

- Information/signs, signals and markings;
- The turning radius;
- Crosswalks;
- Crossing times;
- Medians;
- Refuge islands and slip lanes;
- Curb ramps;
- Sight lines;
- Traffic patterns; and
- Onset of signal phases.



**Figure 8-1.** Pedestrian crossings should be designed to be accessible to all pedestrians.

A pedestrian crossing is defined as any location where the pedestrian leaves the sidewalk and enters the roadway. At a pedestrian crossing, the pedestrian's path of travel crosses the motorist's path of travel. Pedestrian crossings include midblock crossings and street intersections. At midblock crossings, pedestrians generally encounter traffic moving in two directions. At signal phasing, traffic is usually moving in multiple directions because of turning vehicles. Overpasses and underpasses route pedestrians above or below vehicular traffic and therefore are addressed as variations in the design of the sidewalk corridor and are included as part of Chapter 4.

A design that carefully considers each of these elements is the first step in the creation of an effective pedestrian

# 8

# PEDESTRIAN CROSSINGS

## CHAPTER

crossing. Equally important, however, is the way in which these elements are combined. Sometimes variations in the design will be necessary in order for elements to be combined appropriately. More complicated pedestrian crossings, including roundabouts, skewed intersections, and streets with rail tracks are discussed in this chapter and in Chapter 9.

### 8.1 Barriers to pedestrian access

Pedestrians are at risk whenever they cross the roadway. The degree of risk depends on the complexity of the vehicular and pedestrian traffic patterns and the effectiveness of supplementary information provided regarding the crossing location, direction, and duration. At street intersections, turning vehicles and the speed at which they travel pose the greatest threat to pedestrians because the motorist's attention is focused primarily on other motorists.

In addition to the geometric design of the intersection, pedestrian safety also

relies heavily on the information that is provided to pedestrians (e.g., signs or signals). All pedestrians, including people with vision impairments, need the same information at an intersection. Providing vital information in multiple, accessible formats (e.g., visual, auditory, tactile) also benefits all pedestrians since information is better recognized and remembered if it is understood by multiple senses. Generally, the more complex the crossing, the more important it is to have accessible information about the crossing location, direction, and duration. More detailed information about accessible pedestrian information is provided in Chapter 6.

#### 8.1.1 Movement barriers

A movement barrier is anything that restricts an individual's ability to physically move along or within the sidewalk and crosswalk environment. The greatest movement barriers for pedestrians at pedestrian crossings are:

- Long crossing distances;



# 8

# PEDESTRIAN CROSSINGS

## CHAPTER

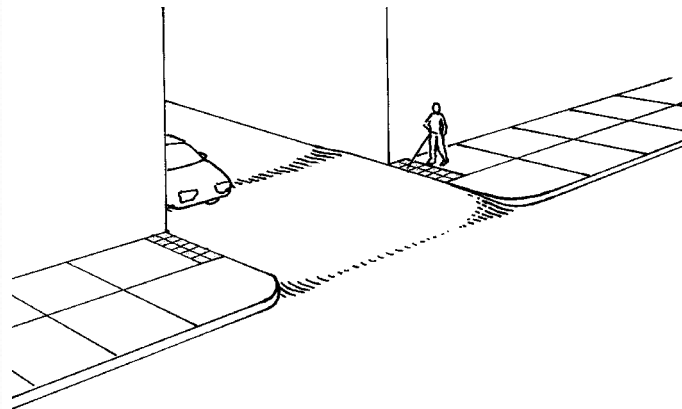
- Short signal timing;
- Medians and islands without ramps or cut-throughs;
- Curbs without curb ramps;
- Curb ramps without level landing;
- Pedestrian actuated signal devices that are difficult to activate or in hard to reach locations; and
- Lack of information during pedestrian signal phase.

### 8.1.2 Information barriers

Information barriers restrict an individual's ability to utilize information contained within the sidewalk environment. The greatest information barriers for pedestrians at crossing locations are:

- Conditions that make it difficult to identify the boundary between the sidewalk and street;
- Blocked sight lines;
- Signal devices (including actuated) that do not provide accessible information;
- Lack of accessible information about the pedestrian crossing location, direction, or interval;
- Crosswalk locations that are only detectable by sight;
- Vehicular actuation mechanisms that make the onset and duration of signal phases unpredictable without accessible pedestrian signal information;

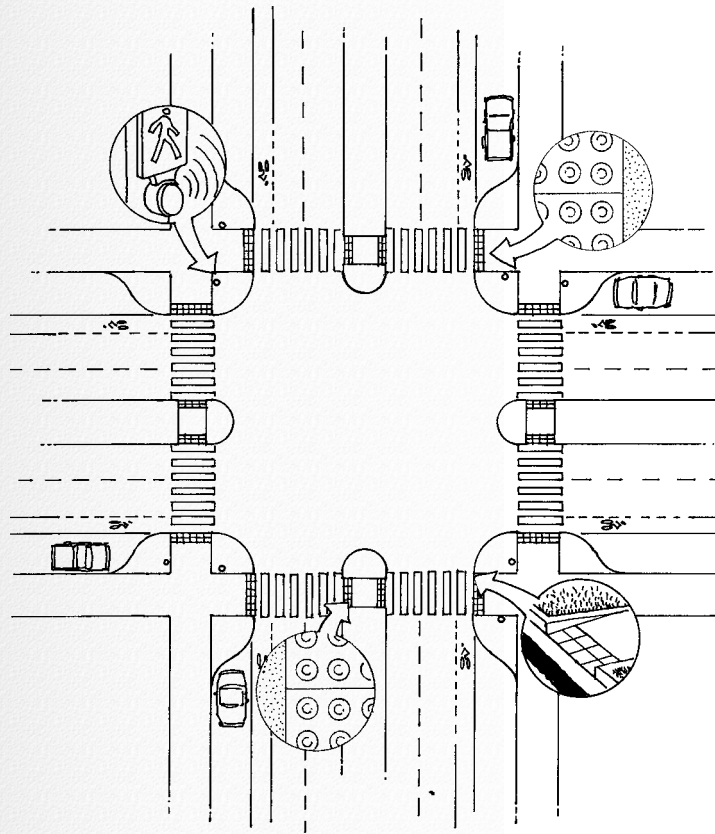
**Figure 8-2.** Crossing an alley is difficult for people with vision impairments if the motorist's sight lines are short and the crosswalk is raised to enhance access for people with mobility impairments. Detectable warnings are critical whenever the crosswalk is flush with the curb.



# 8

# PEDESTRIAN CROSSINGS

## CHAPTER



**Figure 8-3. GOOD DESIGN:** At wide intersections, pedestrian access can be enhanced through a variety of features including ladder marking of crosswalks, perpendicular curb ramps, curb extensions with landscaping, detectable warnings, medians, and accessible pedestrian signals.

- Exclusive pedestrian phases (i.e., motorists stopped in all directions), without accessible pedestrian signal information for people with vision impairments to determine the crossing phase;
- Motorists making right turns during a red light;
- Nonsignalized slip lanes or roundabouts that permit a continuous flow of vehicular traffic;
- Rectilinear or unusual geometrics in the design of the intersection where the crossing location and correct direction of travel is not clear;
- Small signage or pedestrian signals at intersections with long crossing distances; and
- Short WALK intervals that do not provide pedestrians with slower starting times sufficient time to verify that the WALK interval has begun.

### 8.1.3 Design solutions

Techniques that can help improve pedestrian conditions and access at intersections are outlined in the following list and expanded in the subsequent sections:

- Install a center median to provide a refuge for slower pedestrians;
- Install accessible pedestrian signals to assist in providing people with vision impairments enough time to cross the street;
- Increase crossing times so that people who walk slowly will have sufficient time to cross before the signal indication changes;

# 8

# PEDESTRIAN CROSSINGS

## CHAPTER

- Increase the crossing times so that people who delay the start of their crossing to confirm the WALK interval will have sufficient time to cross before the signal indication changes;
- Restrict right turns on red;
- Enhance the visibility of the crosswalk markings or consider a raised crosswalk with detectable warnings (truncated domes) at both ends;
- Reduce crossing distances and increase visibility through the construction of curb extensions;
- Reduce traffic speed;
- Clarify the pedestrian crossing area by installing raised crosswalks with detectable warnings (truncated domes) installed at both ends;
- Provide pedestrian lead time and an accessible pedestrian signal so pedestrians, including those with

vision impairments, can assert themselves in the crosswalk before motorists start making right and left turns;

- Provide midblock signalized crossing with accessible pedestrian signal opportunities at busy intersections to encourage people to cross where there are fewer potential points of conflict between pedestrians and motorists;
- Provide a curb extension to decrease crossing distances and increase pedestrian visibility; and
- Add traffic and pedestrian signal indications if they do not already exist.

In addition, if commercial facilities are primarily located on one side of a very busy street, public transportation, such as buses, should drop people off on the commercial side of the street whenever feasible to reduce the number of crossings.

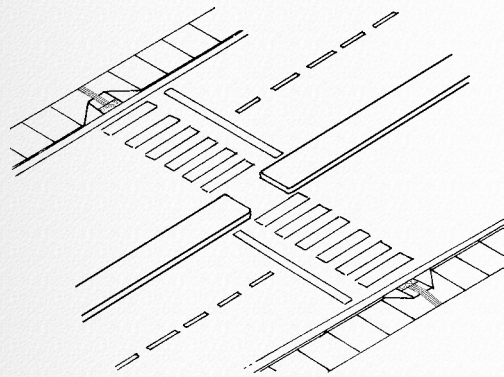
### Case Study 8-1

Eagle Point, Oregon, improved access to its downtown intersections by moving utility poles, constructing new sidewalks, and implementing other accessibility features.

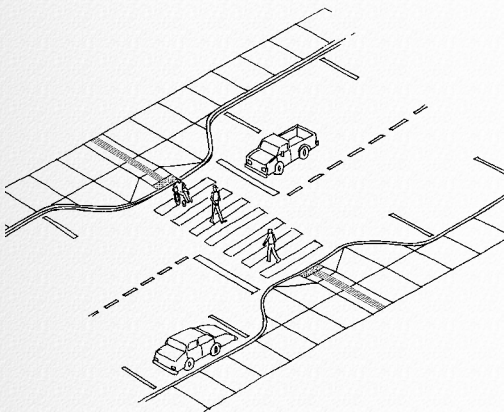
# 8

# PEDESTRIAN CROSSINGS

## CHAPTER



**Figure 8-4.** Medians improve pedestrian access at midblock crossings by allowing pedestrians to negotiate traffic in only one direction at a time.



**Figure 8-5.** Curb extensions and highly visible crosswalks improve pedestrian access at midblock crossings.

## 8.2 Midblock crossings

Midblock crossings are locations between intersections where a marked crosswalk has been provided. Midblock crossings are often installed in areas with heavy pedestrian traffic to provide more frequent crossing opportunities. They may also be added near major pedestrian destinations, such as schools, where people might otherwise cross at unmarked locations.

Midblock crossings may or may not be regulated. In many situations, midblock crossings are easier for pedestrians to use because traffic is flowing in no more than two directions. However, midblock crossings present some design challenges because motorists often do not expect pedestrians to be crossing at a midblock location. In addition, midblock crossings are difficult for pedestrians with vision impairments to locate; if signalized, pedestrians with vision impairments are often unable to identify when it is their turn to cross because their customary cue,

the surge of traffic in the street beside them, isn't present. If not signalized, they are often unable to tell when there is a gap in traffic or whether all approaching cars have stopped (the sound of one idling car can mask the sound of approaching cars).

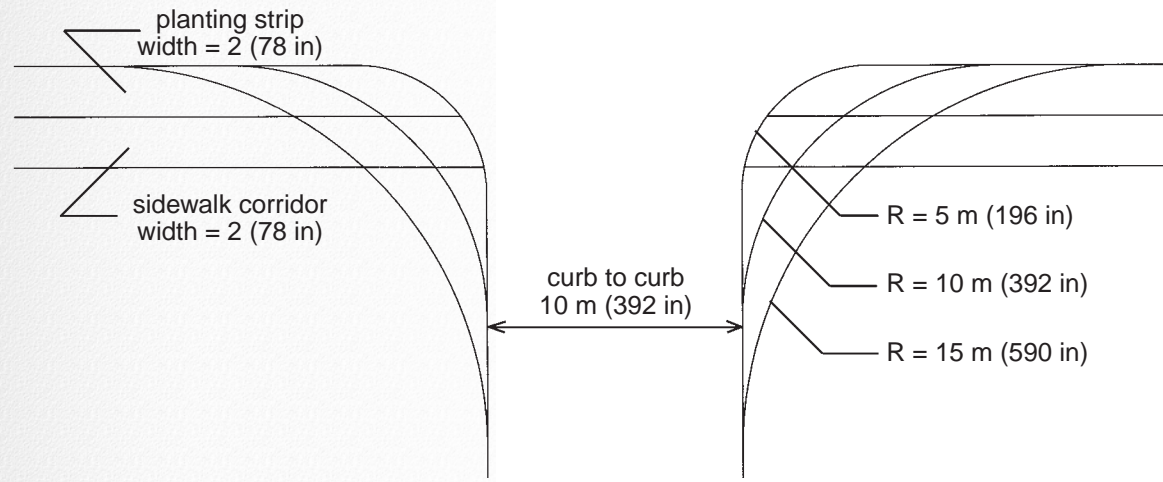
A variety of strategies can be employed to identify midblock crossings to people with vision impairments. If the crossing is signalized, an accessible pedestrian actuated signal device with a locator tone should be provided. Another strategy is to include raised directional wayfinding surfaces across the width of the sidewalk (perpendicular to the sidewalk path of travel). This alerts the pedestrian with visual impairments to the midblock crossing, and they are able to follow the directional surface to the curb on the other side of crossing. In the United States, relatively few midblock crossings incorporate raised directional surfaces, although they are more widely used in other countries, including Japan and England.

# 8

# PEDESTRIAN CROSSINGS

## CHAPTER

**Table 8-1**



### 8.3 Turning radius

Designing intersections with smaller turning radii slows traffic speeds and allows perpendicular curb ramps to be positioned parallel to the crosswalk path of travel, as well as perpendicular to the curb (Section 7.2.1). In addition, smaller turning radii significantly decrease crossing distances for pedestrians, as shown in Table 8-1. Smaller radii also enhance detection of the crosswalk and improve crossing conditions for people with vision impairments because there is a greater distinction between the perpendicular and parallel traffic flows.

Unfortunately, the turning radius at intersections has gradually increased in order to accommodate larger vehicles and more continuous traffic flow. Current practice dictates that the turning radius be determined by the types of vehicles that travel on the road and the intended speeds for drivers to make right turns. Larger trucks and buses benefit from larger turning radii because they have a longer wheelbase than smaller passenger vehicles.

Turning Radius	Crossing Distance*	Increased Crossing Distance**
5 m (16.4 ft = 196 in)	10.8 m (35.4 ft = 424 in)	0.8 m (2.6 ft = 30 in)
10 m (32.8 ft = 392 in)	15.7 m (51.5 ft = 617 in)	5.7 m (18.7 ft = 223 in)
15 m (32.8 ft = 392 in)	22 m (72.2 ft = 866 in)	12 m (39.4 ft = 472 in)

\*Measured from the center of the paved portion of the sidewalk corridor

\*\*Based on a curb-to-curb distance of 10.0 m (32.8 ft)



# 8

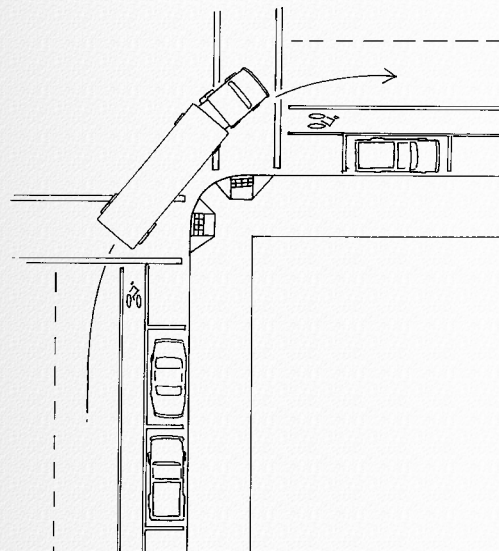
# PEDESTRIAN CROSSINGS

## CHAPTER

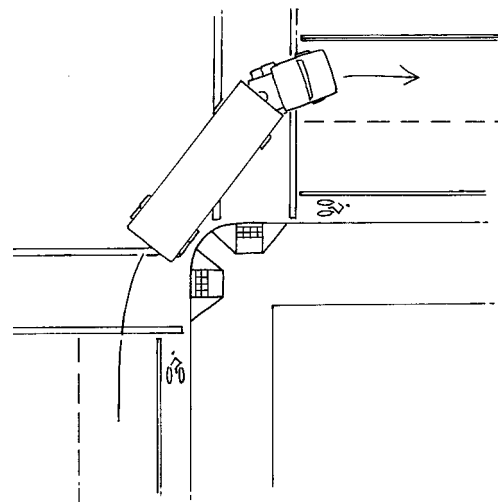
However, pedestrian access is significantly compromised at intersections with larger turning radii, for the following reasons:

- Cars can make right turns at higher speeds;
- Curb ramp designs may be compromised;

- Pedestrian crossing distances are increased (this also results in increased vehicle signal phasing delays and reduced roadway capacity from the delays);
- Less space is available on the corner for pedestrians to collect;
- Less space is available on the corner for utilities;
- It is more difficult for pedestrians, especially those with vision impairments, to claim the right of way when crossing;
- Greater numbers of conflicts arise between pedestrians and motorists; and
- Pedestrians are located outside of a driver's line of vision.



**Figure 8-6.** Adding bike and parking lanes increases the potential turning radius for oversized vehicles, while maintaining the benefits of smaller turning radii for pedestrians.



**Figure 8-7.** Allowing trucks to turn into the second lane of traffic increases the potential turning radius for oversized vehicles.

Minimum recommendations for turning radius are contained in A Policy on Geometric Design of Highways and Streets (AASHTO, 1996). However,

# 8

# PEDESTRIAN CROSSINGS

## CHAPTER

designers rarely adhere to the minimum recommendation. Pedestrians would be better served if designers balanced the needs of larger vehicles with the needs of pedestrians.

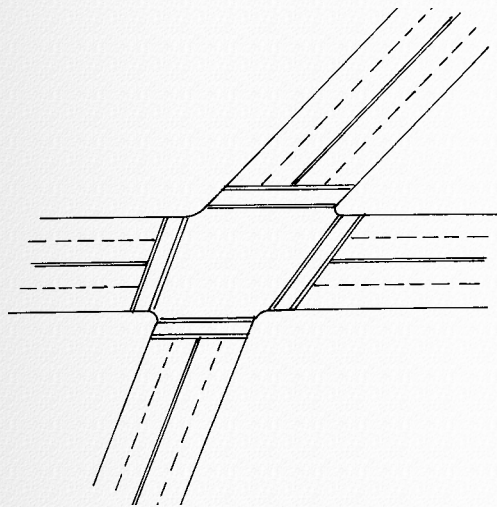
Whenever possible, creative designs should be used to minimize turning radii at an intersection. Alternatives to building intersections with large turning radii include:

**SOLUTION 1** — Add a parking lane to increase the relative turning radius of the corner.

**SOLUTION 2** — Allow trucks that cannot make it around a tight corner to turn into the out-of-lane roadway as necessary and put stoplines farther back from the intersection.

**SOLUTION 3** — Design intersections with right angles or as close to right angles as the site permits since skewed intersections inherently have some corners with wider turning radii.

**SOLUTION 4** — Consider a design that uses a compound curve. This design allows the use of larger turning radii where required and yet pedestrians still benefit from the positive aspects of tight corners wherever possible. For example, one corner section of the intersection may have a very large radius which then transitions to a much smaller radius at another corner. The combination of the initially large radius with the small radius on the opposite side of the crosswalk may benefit truck traffic at corners that they use most. At the same time, it forces other motorists making turns at smaller radii to slow down significantly as they turn.



**Figure 8-8.** Skewed intersections always have some corners with wide turning radii.

### 8.4 Right turn on red and turning vehicles

Right turns on red create a significant information barrier for individuals with vision impairments. Traffic sounds are a valuable orientation cue for people with vision impairments. Irregular sound

# 8

# PEDESTRIAN CROSSINGS

## CHAPTER

patterns, such as cars pulling constantly through the intersection, can provide conflicting and unreliable information about the pedestrian crossing interval. Additional research is needed to establish guidelines for when right turn on red should be prohibited at intersections because of the negative impact it has on the safety of all pedestrians, especially those with vision impairments.

Turning traffic also has a significant impact on pedestrian travel in general. Motorists who are turning left have their concentration focused on the oncoming traffic. As a result, the attention paid to pedestrians in the crosswalk is decreased. The effect is compounded for drivers who are turning right on a red light. They are not only concentrating on identifying a suitable gap in automobile traffic traveling on a perpendicular path, they often pull into the pedestrian crossing area in order to improve their sight lines and decrease the distance required to merge. When this happens, pedestrians are forced to walk between cars or significantly delay the start of their crossing.

## 8.5 Crosswalks

Crosswalks are a critical part of the pedestrian network. A crosswalk is defined as “the portion of a roadway designated for pedestrians to use in crossing the street” (Institute of Transportation Engineers, 1998). Crosswalks are implied at all intersections whether or not they are marked. Midblock crossings include all marked crosswalks that do not occur at intersections. Midblock crossings are only created if a marked crosswalk is provided. The agency responsible for the roadway must ensure that all marked and unmarked crosswalks and midblock crossings are optimized for the safety and accessibility of all pedestrians.

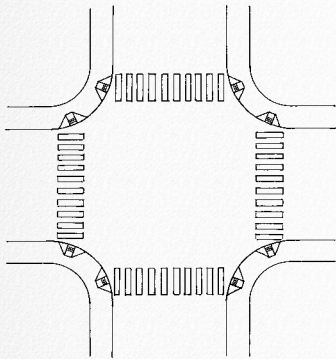
### 8.5.1 Crosswalk markings

Crosswalk markings, if provided, are used to define the pedestrian path of travel across the roadway and alert drivers to the crosswalk location. Marked crosswalks should be designed in accordance with the Manual of Uniform Traffic Control Devices (MUTCD). Although the MUTCD provides

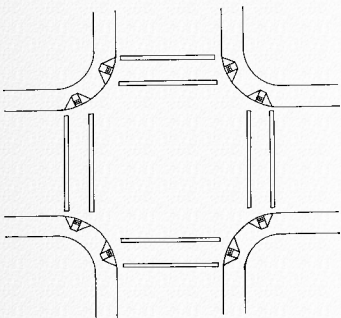
# 8

# PEDESTRIAN CROSSINGS

## CHAPTER



**Figure 8-9. GOOD DESIGN:** Continental markings should be used at all pedestrian crossings because research has determined that they are most visible to motorists.



**Figure 8-10. ACCEPTABLE DESIGN:** Although crosswalks with parallel markings are permitted by the MUTCD, they are less visible to motorists than crosswalks with ladder striping.

options for crosswalk markings, the continental design is recommended because research indicates that it is the most visible to drivers (Knoblauch et al., 1988). The ladder design is created with white longitudinal lines at a 90 degree angle to the line of the crosswalk. The lines should be approximately 305 mm to 610 mm (12 in to 24 in) wide and spaced 305 mm to 610 mm (12 in to 24 in) apart (USDOT, 1988). The continental design can also be installed so that the primary paths for vehicular tires are between the crosswalk markings, which helps to reduce wear and maintenance. Use of the continental design for crosswalk markings also improves crosswalk detection for people with low vision and cognitive impairments. It is recommended that the continental design be used consistently to mark all crosswalks; otherwise the impact of less visible markings may be weakened by comparison.

### 8.5.2 Crosswalk research

In recent years, there has been much debate surrounding the safety implications

of marking crosswalks at uncontrolled intersections. Previous research results were contradictory in terms of whether pedestrian vehicle crashes were occurring with more, less, or the same frequency at marked and unmarked crosswalks. The contradictory findings can be attributed to limitations of the research project designs, which contained many confounding variables and small, potentially biased sample sizes and sites.

A large study entitled Evaluation of Pedestrian Facilities was completed by the Federal Highway Administration to address the limitations found in previous research (Zeeger, Stewart, & Huang, 1999). None of the sites in the study had traffic signals or stop signs on the approach to the crosswalk. The study examined the safety of marked and unmarked crosswalks and the impact of additional pedestrian treatments, such as signal indications, lights, and traffic calming measures. The study evaluated 1,000 marked crosswalks at uncontrolled locations or locations with no traffic control devices and 1,000 matched but unmarked sites

# 8

# PEDESTRIAN CROSSINGS

## CHAPTER

in 30 geographically dispersed cities in the United States. Detailed information collected for each site included pedestrian crash history, pedestrian and traffic volumes, number of lanes, speed limit, type of median, type and condition of crosswalk markings, and crosswalk location. Results of the study indicated that:

- Higher pedestrian volumes, higher average daily traffic (ADT) rates, and a greater number of roadway lanes are related to a higher incidence of pedestrian crashes;
- Crosswalk location, speed limit, direction of traffic flow, crosswalk condition, and crosswalk marking pattern were not related to the incidence of pedestrian crashes;
- The presence of a median decreased the pedestrian crash risk;
- Marked crossings had a higher incidence of pedestrian crashes on multi-lane (4 or more lanes) roads with high ADTs;
- Marked and unmarked crossings had similar incidences of pedestrian crashes on all 2-, 3-, and multi-lane roads with lower ADTs;
- Pedestrians ages 65 and above were over represented in crashes; and
- The installation of marked crossings did not alter motorist behavior (e.g., stop or yield to pedestrians) or pedestrian behavior (e.g., crossing without looking).

According to the research, on smaller roadways with lighter traffic volumes, markings do not decrease the pedestrian crash risk; conversely, on large, high-volume roadways, the risk actually increases. However, Zegeer, Stuart and Huang (1999) indicated that the higher risk observed on multi-lane roadways with high ADT rates results from:

- An overall higher risk as the number of lanes or ADT rate increases regardless of markings;



# 8

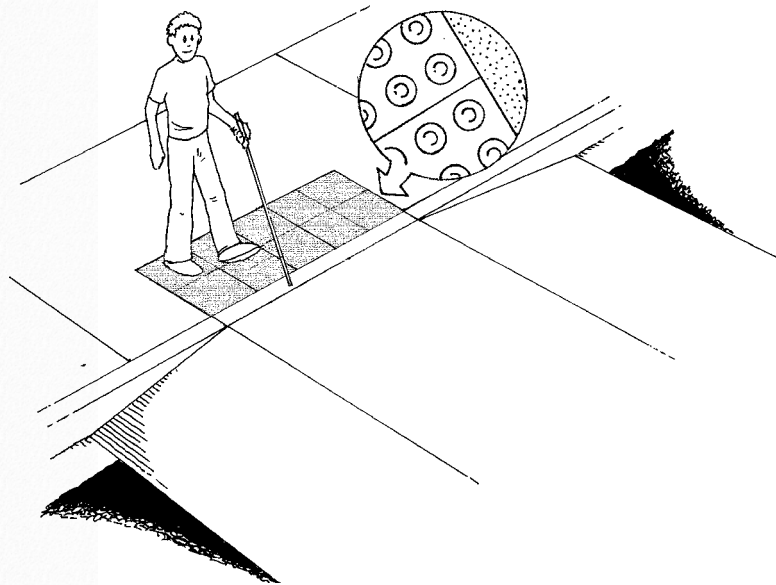
# PEDESTRIAN CROSSINGS

## CHAPTER



**Figure 8-11.** Continental crosswalks combined with alternative measures, such as pedestrian actuated traffic controls, enhance pedestrian crossing.

- Recognition that multi-lane roadways with high ADT rates represent the most difficult scenarios for pedestrian crossings, and
- The fact that marked crossings draw pedestrians to cross in that location, particularly in areas where the crossing is perceived to be difficult.



**Figure 8-12.** Detectable warnings should be provided at the edge of a raised crosswalk to identify the transition between the sidewalk and the street for people with vision impairments.

### 8.5.3 Recommendations for enhancing pedestrian safety and access

Zegeer, Stuart, and Huang emphasized that the needs of pedestrians to safely cross streets cannot be ignored and that engineering and roadway treatments should be used to minimize the pedestrian crash risk. Based on these recommendations, it is not appropriate to always remove crosswalk markings from multi-lane roadways with high average daily traffic. Instead, the markings should be enhanced with appropriate additional pedestrian treatments such as signing, traffic calming, signalization, or other countermeasures.

Zegeer, Stuart and Huang (1999) offered a variety of recommendations based on the results of their research. Although the study was focused on safety issues, it is interesting to note that the majority of their recommendations for improving pedestrian safety would improve access for people with disabilities. Based on these research results and recommendations for enhancing access to pedestrian rights-of-way (U.S.

# 8

# PEDESTRIAN CROSSINGS

## CHAPTER

Access Board, 1999a), the following recommendations are made for the design of pedestrian crosswalks:

- Design crosswalks as enhanced crossings that combine highly visible markings (ladder striping) with additional pedestrian treatments, such as shorter crossing distances, traffic calming, and medians;
- Design crosswalks so that all pedestrians can travel within the marked area throughout the entire crossing. Crosswalk designs should provide for a 1.22 m (48 in) clear space at the bottom of diagonal curb ramps;
- Avoid restrictions for pedestrians to cross on only one leg of an intersection unless a solid barrier and accessible information about the restricted crossing pattern is provided to pedestrians with visual impairments;
- Ensure that midblock crossings will be detectable by and accessible to pedestrians with vision impairments;
- Maintain crosswalk markings and consider additional treatments whenever a street is resurfaced;
- Do not install marked crosswalks without additional treatments, such as traffic calming and signing, on multi-lane roadways with high average daily traffic;
- Provide raised medians and curb extensions on multi-lane roads;
- Consider traffic signals and pedestrian actuated signal devices at difficult or problematic pedestrian crossings;
- Consider flashing signals and lights and advanced warning signs to increase the visibility of the crosswalk;
- Install traffic calming measures to reduce vehicle speeds (see Chapter 10);
- Increase the crossing time if the crossing is signalized;

# 8

# PEDESTRIAN CROSSINGS

## CHAPTER

- Maintain the expected pedestrian travel pattern;
- Design corners with smaller turning radii; and
- Provide generous sight distances and unobstructed sight lines between vehicles and pedestrians.

### 8.5.3.1 Flashing signals

Pedestrian safety is maximized when drivers are aware of the crosswalk location and know when a pedestrian is attempting to cross. People who use wheelchairs are at a lower height than other pedestrians and may be more difficult for motorists to detect. People with vision impairments cannot establish eye contact with an approaching motorist, which may also decrease the probability that they will be seen or that the motorist will know that a crossing will be attempted. Flashing lights that are activated only when a pedestrian is attempting to cross can enhance crosswalk detection by motorists. The flashing lights, in conjunction with

advanced warning signs for the lights, can provide the motorists with more warning of the crossing. A variety of intermittent lighting styles may be used, including:

- Flashing traffic signals over the crosswalk;
- Imbedded flashing lights in the crosswalk surface; and
- Flashing signals to warn motorists if pedestrians are present.

Overhead flashing signals should be installed according to the MUTCD standards. The flashing in-pavement crosswalk lights are currently being tested for their effectiveness by FHWA as a new device and are not currently included in the MUTCD standards.

### 8.5.3.2 Reducing motorist speeds

Ultimately, the pedestrian in the roadway is dependent on the motorist's ability to detect the pedestrian with sufficient time to stop given the vehicle's



**Figure 8-13.** Imbedding lights in the asphalt at the edge of a crosswalk is an experimental method for making crosswalks more visible to motorists.

# 8

# PEDESTRIAN CROSSINGS

## CHAPTER

speed. The faster a motorist is traveling, the longer the stopping distance will be. The required vehicle deceleration may be difficult for motorists to judge accurately, if the pedestrian is moving slower than expected. For example, a motorist may see a pedestrian start to cross from a distance and slow their vehicle so that it will approach the crosswalk after the pedestrian has finished crossing. However, if the pedestrian actually moves at a slower pace than anticipated, the motorist may not immediately recognize that greater deceleration or a full stop will be required. Likewise, pedestrians may not be able to judge vehicle approach speed and gap size effectively, especially at night.

Raised crosswalks (and other traffic calming devices) can reduce vehicle speeds and improve the crosswalk for individuals with mobility impairments because they eliminate the need to negotiate a curb or ramp. However, if raised crosswalks are installed, the edge of the street must be marked with detectable warnings so people with vision impairments can easily determine when they are leaving the

sidewalk and entering the street. Raised intersections are an alternative design but may not reduce vehicular speeds to the same extent. More detailed information on traffic calming techniques can be found in Chapter 9.

## 8.6 Crossing times

People's decision and reaction times before they start walking, as well as their walking pace, vary depending on several factors. Older pedestrians and pedestrians with vision or cognitive impairments may all require longer starting times to verify that cars have stopped. They may also have slower reaction times and slower walking speeds. Both powered and manual wheelchair users on level or downhill slopes may travel faster than other pedestrians. But on uphill slopes, manual wheelchair users have slower travel speeds. At intersections without accessible information to indicate the onset and direction of the WALK interval, people with vision impairments require longer starting times to verify that their



# 8

# PEDESTRIAN CROSSINGS

## CHAPTER

pedestrian interval has started and it is appropriate to cross safely. Additional information about accessible pedestrian signals can be found in Chapter 6.

The MUTCD standard identifies a “normal” walking speed as 1.22 m/s (4 ft/s). However, research indicates that the majority of pedestrians walk at a speed that is slower than this and that 15 percent of pedestrians walk at speeds less than 1.065 m/s (3.5 ft/s) (Kell and Fullerton, 1982). The latter group includes a large proportion of people with ambulatory impairments and older adults. As the population ages, the number of pedestrians traveling at slower walking speeds is increasing. Therefore, it is recommended that the calculation of all crossing times be based on a walking speed of no more than 1.065 m (3.5 ft/s). The City of San Francisco calculates pedestrian crossing times based on a walking speed of 855 mm/s (2.8 ft/s).

In the past, transportation manuals have recommended longer crossing times at intersections with high volumes of older adults or people with mobility impairments.

However, every intersection will be used by a variety of pedestrians including some individuals who walk slowly and others who walk quickly. Therefore, adjusting crossing times based on 3.5 ft/s should be considered at all intersections. Longer pedestrian signal cycles are strongly recommended at crossings that are unusually long or difficult to negotiate. Longer signal cycles are also recommended for crossings, such as those that provide access to a rehabilitation or senior center, where a higher proportion of the potential users may have a slower walking speed. Engineers are also encouraged to consider recent advancements in technology that can detect pedestrians in the crosswalk and extend the pedestrian interval as needed. Note that accessible pedestrian signals may be necessary since pedestrians who are blind may not know how the signals cycle.

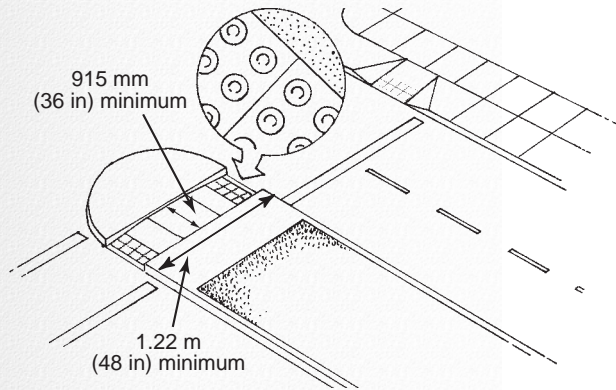
If crossing times cannot be reduced, crossing distance should be decreased to benefit pedestrians who need more time to cross or who may require a rest or break during long or complex crossings.



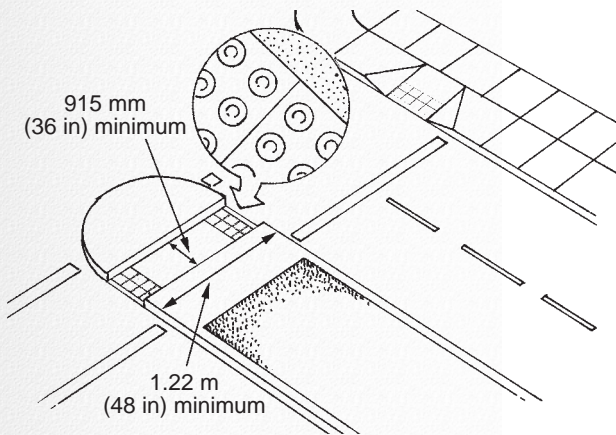
# 8

# PEDESTRIAN CROSSINGS

## CHAPTER



**Figure 8-14.** A ramped median should have a level landing that is at least 915 mm (36 in) wide and 1.22 m (48 in) long.



**Figure 8-15.** Cut-through medians should be at least 915 mm (36 in) wide and should include 610 mm (24 in) strips of detectable warnings at both ends.

Crossing distances can be reduced by extending the sidewalk into the parking lane, by narrowing the existing lanes, or by providing medians to divide the crossing into two segments.

### 8.7 Medians

Medians are the portion of a divided roadway that separates traffic flows heading in opposite directions (US DOT, 1994b). At roundabouts, these are called splitter islands. Medians help pedestrians cross intersections by reducing the crossing distance from the curb to a protected area. This allows pedestrians to cross during smaller gaps in traffic. For this reason, medians are especially helpful for pedestrians who are unable to judge distances accurately. In addition, medians also help people with slow walking speeds to cross wide intersections during a

short signal cycle. Medians are also useful at irregularly-shaped intersections, such as sites where two roads converge into one (Earnhart & Simon, 1987). In commercial districts, medians provide pedestrians with valuable protection from oncoming traffic. In residential areas, they serve as traffic calming devices and green space.

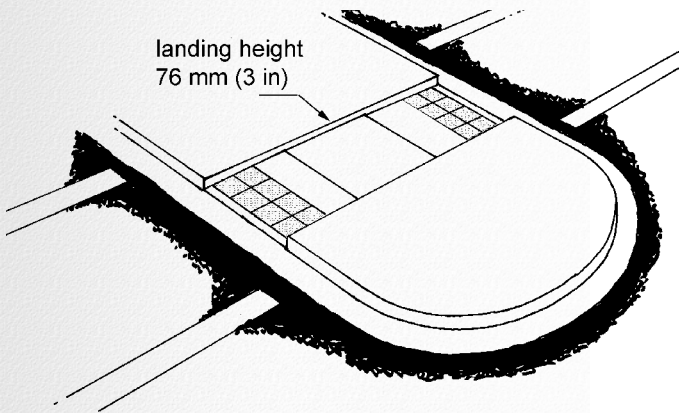
Whenever possible, medians should be raised to separate pedestrians and motorists. Raised medians make the pedestrian more visible to motorists and they are easier for people with vision impairments to detect. Raised medians should be designed with a cut-through at street level or a ramp. This provides pedestrian access to individuals who cannot travel over a curb. Detectable warning surfaces should be placed at the edge of both ends of the median in order for the streets to be recognized by pedestrians who are visually impaired. If the corner includes a pedestrian actuated control device, one should also be located at the median. (See Chapter 6.5 for more information.)

If a median is ramped (see Figure 8-14), the slope of the ramps must not

# 8

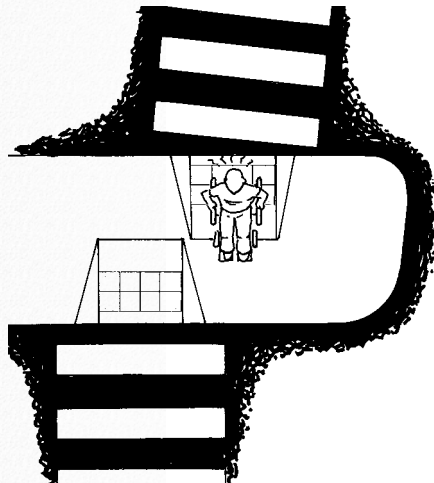
# PEDESTRIAN CROSSINGS

## CHAPTER



**Figure 8-16. GOOD DESIGN:** The height of this median does not exceed 76 mm (3 in). This design allows for the construction of shorter curb ramps and a longer level landing.

**Figure 8-17. PROBLEM:** Offsetting median ramps is a common mistake made by designers who do not understand the mobility limitations of wheelchair users. Providing a level landing is not sufficient if the landing does not connect to the subsequent ramp.



exceed 8.33 percent. In addition, a level area at least 915 mm (36 in) wide and 1.22 m (48 in) long is required. If space allows, a level area at least 1.525 m x 1.525 m (60 in x 60 in) is preferred. This is often difficult to achieve where the available space is restricted. One creative solution is presented in Figure 8-16. Rather than raising the landing the full height of the median

[e.g., a full 152 mm (6 in)], the landing is only raised 76 mm (3 in), which allows for much shorter ramp lengths and a longer landing. A 610 mm (24 in) strip

of detectable warnings should be provided at the end of both curb ramps. If the raised median is cut-through level with the street (see Figure 8-15), it should be at least 915 mm (36 in) wide and 1.22 m (48 in) long. If space permits, the length of the cut-through should

be increased to 1.53 m (60 in). A slight crowning of the asphalt (no greater than 5 percent) may be necessary for drainage. Cut-through medians should have a 610 mm (24 in) wide detectable warning at each end to identify the edge of the street.

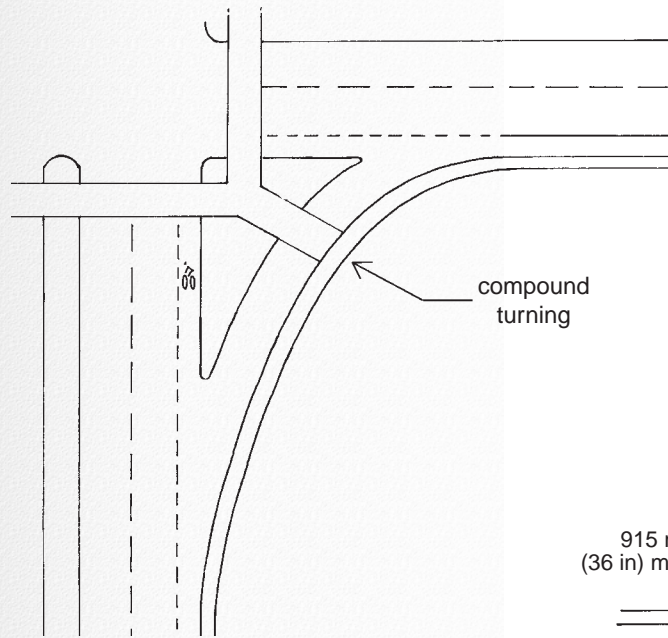
## 8.8 Corner islands

In addition to medians, raised pedestrian refuge areas are sometimes installed between the independent right turn lane and the intersection through lanes. The right turn lane is often called a right slip lane because motorists are not expected to come to a complete stop at the intersection. Right slip lanes are designed to improve traffic flow by minimizing the drivers' need to stop at an intersection; therefore, driver speeds through the crosswalk tend to increase. To limit motorist speeds, a compound curve radius

# 8

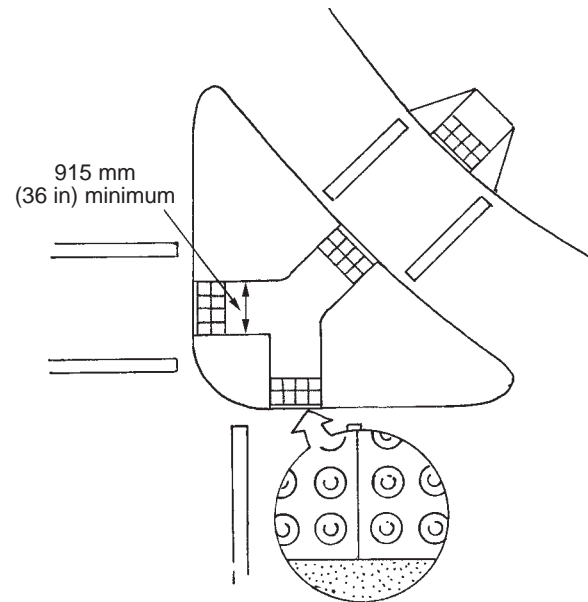
# PEDESTRIAN CROSSINGS

## CHAPTER



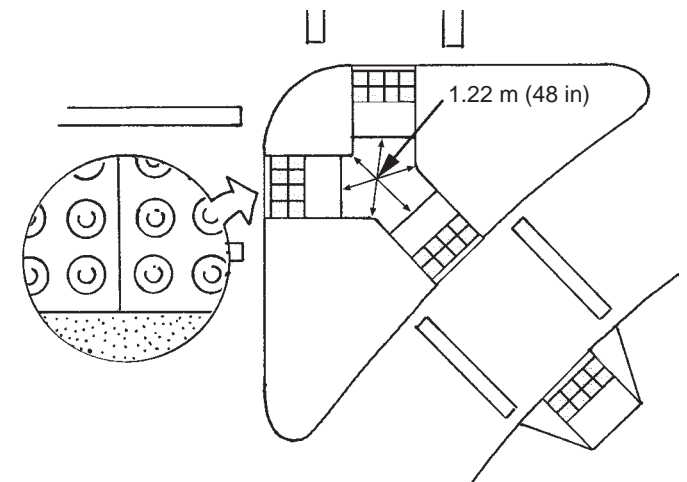
**Figure 8-18.** This corner island was installed at a corner with a compound curve radius. This design allows the use of larger turning radii where required, and pedestrians benefit from the positive aspects of a tight corner that forces drivers to decrease speeds.

should be used (see Section 8.3 for details). Even if vehicle speeds are somewhat controlled by the radius of the corner, a right turn slip lane still creates significant access barriers for pedestrians. For example:



**Figure 8-19.** Corner islands with cut-throughs should be at least 915 mm (36 in) wide at all locations and include 610 mm (24 in) strips of detectable warnings.

- Typical corner flow patterns are altered, which make it difficult for those with vision or cognitive impairments to detect and understand crossing locations;
- The area available at the corner for pedestrians waiting to cross is reduced and drivers' advance views of pedestrians waiting to cross is very short;



**Figure 8-20.** Ramped islands should include detectable warnings and have a level.

# 8

# PEDESTRIAN CROSSINGS

## CHAPTER

- Traffic flow crossing cues for people with vision impairments are reduced because turning traffic masks the sounds of stop and go flows at the intersection; and
- Drivers often fail to yield the right-of-way to pedestrians waiting to cross, particularly individuals with vision impairments who cannot establish eye contact with the driver.

The benefits of right turn slip lanes are focused on improving the flow of vehicular traffic. However, given the significant drawbacks of right turn lanes separated by a corner island (see Figure 8-18) for pedestrians with and without disabilities, designers and engineers are challenged to develop alternate solutions that will not compromise access or safety. If a right turn slip lane is deemed necessary despite the drawbacks, the island should be raised and contain cut-throughs or ramps. In addition, design features

should be installed to control or calm the traffic, such as pedestrian-activated signals, or raised crosswalks with detectable warnings. If cut-throughs are used, they should be at least 915 mm (36 in) wide. If ramps are provided, they should be at least 915 mm (36 in) with a center landing of 1.22 m (36 in) and a maximum slope of 8.3 percent. Both ramps and cut-throughs should include a 610 mm (24 in) strip of detectable warnings at the island/street interface.

### 8.9 Improving sight lines at intersections

At pedestrian crossings, generous sight distances and unobstructed sight lines will allow motorists and pedestrians to detect each other in time to avoid collisions. Motorists also need appropriate sight distances to see traffic signals in time to stop. Sight lines should be designed so that the motorist can observe the movement of the pedestrian for a long enough period of time to accurately determine the pedestrian's speed. If the

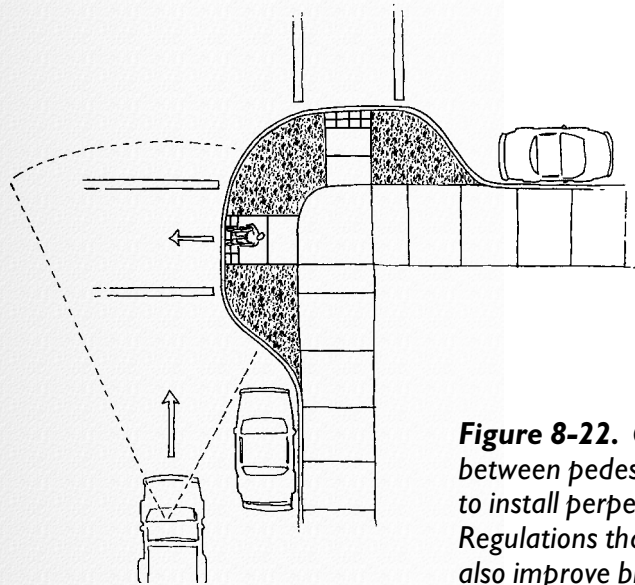
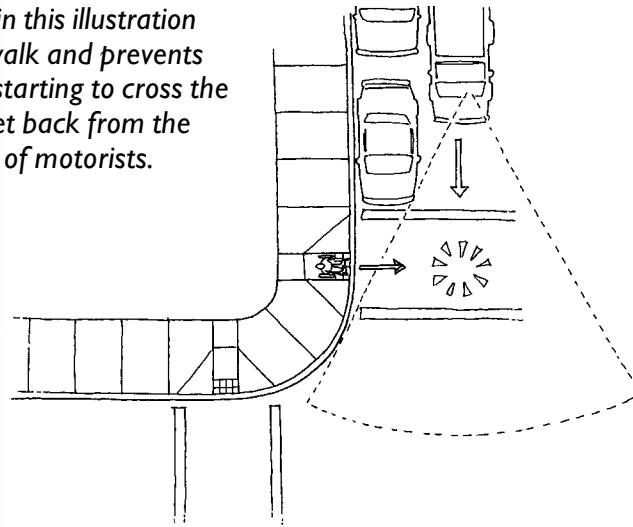


# 8

# PEDESTRIAN CROSSINGS

## CHAPTER

**Figure 8-21.** The parking lane in this illustration extends all the way to the crosswalk and prevents drivers from seeing pedestrians starting to cross the street. Parking lanes should be set back from the corner to increase the sight lines of motorists.



**Figure 8-22.** Curb extensions improve visibility between pedestrians and motorists and make it easier to install perpendicular curb ramps with level landings. Regulations that prohibit parking at the corner can also improve blocked sight lines.

motorist has only a brief glimpse of the pedestrian, as at right turn slip lanes, and cannot observe the pedestrian's speed, he or she may overestimate the speed of slower pedestrians and not sufficiently slow his or her approach to the crosswalk.

While bollards, landscaping, benches, and bus shelters make pedestrian areas more inviting by calming traffic and providing amenities, they can also clutter the environment and limit the sight distance for motorists and pedestrians waiting to cross the intersection. Small children and people in wheelchairs are particularly vulnerable when sight lines are blocked. They may be unable to see over the obstacles and are at lower heights than drivers anticipate.

The best way to improve pedestrian visibility at an intersection is to install curb extensions to prevent parking at intersection corners and improve the visibility of pedestrians to motorists. Low landscaping or grass can be added to the curb extension to clarify the appropriate path of travel for individuals with vision impairments. In addition, the following steps should be considered:



# 8

# PEDESTRIAN CROSSINGS

## CHAPTER

- Trim vegetation, relocate signs and utilities, and eliminate visual clutter;
- Prohibit parking near the intersection corner;
- Provide raised medians and crosswalks; and
- Provide an advance stop line before a marked crosswalk on a multi-lane road.

### 8.10 Skewed intersections

Streets planned on a grid are generally easiest for pedestrians to negotiate because they result in intersections at 90 degree angles. Perpendicular intersections are easier to negotiate because the path of travel is clear and direct, and sight lines are good in all directions. Skewed intersections occur when streets cross at angles other than 90 degrees and create complicated scenarios for both pedestrians and drivers.

Skewed intersections should be avoided whenever possible during the planning stages of the development process. However, in some areas site constraints prevent the installation of perpendicular intersections. When skewed intersections are unavoidable, the intersection should be designed so that the angle between intersecting streets is as close to 90 degrees as possible. In addition, if major alterations are being done to an existing skewed intersection, transportation agencies should consider whether it is possible to reconfigure the intersection so that the crossings are more perpendicular.

At some skewed intersections, the crosswalks are moved back from the intersection to allow the crossing distance to be shorter and more perpendicular to the sidewalk. However, this design is only recommended if pedestrians with vision impairments can identify the unusual crossing location. People with vision impairments rely on predictable pedestrian travel paths to determine their crossing direction and location. Therefore,

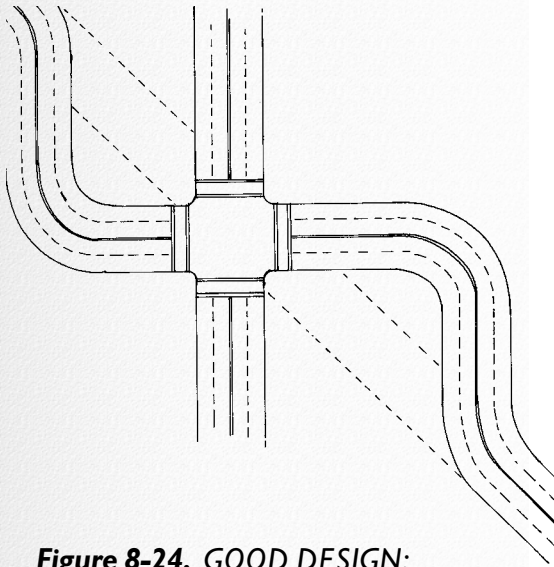


**Figure 8-23.** Skewed intersections create longer crossing distances, which significantly compromise pedestrian access.

# 8

# PEDESTRIAN CROSSINGS

## CHAPTER



**Figure 8-24. GOOD DESIGN:** Transportation agencies should consider reconfiguring skewed intersections during alterations so that pedestrian crossings are perpendicular.

they are likely to experience difficulty locating crosswalk paths that are not aligned with the sidewalk path of travel. To enhance detection, a barrier or landscaping can be installed at the expected crossing location and an accessible pedestrian signal with a locator tone should be provided to identify the crosswalk location. Including raised directional surfaces (tiles to help locate the crosswalk) may also be useful for pedestrians with vision impairments. In addition to the drawbacks for pedestrians with vision impairments, other potential problems for this layout include:

- Pedestrians will use the most direct route to cross regardless of the crosswalk markings;
- Sight lines needed by turning motorists are decreased if the crosswalk is pushed too far back;
- Pedestrian visibility is decreased because they are crossing in a location that is different from what motorists expect;

- Motorists are often accelerating as they pass through the crosswalk;
- Cars may miss the stop line in advance of the intersection and have to stop suddenly in the middle of the crosswalk; and
- Cars may pull into the crosswalk to enhance their sight lines, which will block the pedestrian path of travel.

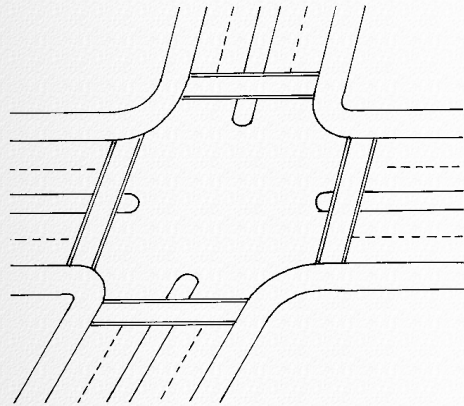
Permitting pedestrians to cross in the expected location is preferred to pushing the crosswalks back from the intersection, although this design increase the crossing distance. The following strategies are recommended to improve skewed intersections with this design:

- Install curb ramps perpendicular to the curb;
- Provide longer crossing times and accessible pedestrian signals if the intersection is signalized;
- Provide marked crosswalks delineated with the continental pattern;

# 8

# PEDESTRIAN CROSSINGS

## CHAPTER

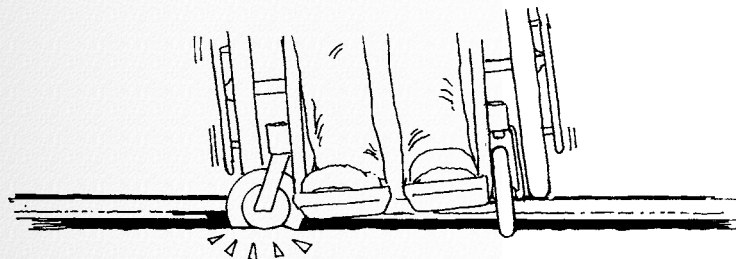


**Figure 8-25. GOOD DESIGN:** When skewed intersections are unavoidable, crosswalks should be placed at the expected location, and accessible medians should be installed to break up the long crossing distances.

- Add medians with truncated domes to reduce crossing distances; and
- Consider installing intersection guidestrips which provide directional information for pedestrians with vision impairments. When intersection guidestrips are installed, it would be beneficial to inform the community of their presence so that pedestrians with visual disabilities know they are there and understand how they should be used.

### 8.11 Railroad crossings

Tracks for trains, light rail vehicles, or trolleys cross the streets of many urban communities as well as in rural areas. Railroad crossings have flangeway gaps that allow passage of the wheels of the train. The flangeway gaps are often large exceeding the 13 mm (0.5 in) limit for openings. Railroad



**Figure 8-26. PROBLEM:** Wheelchair casters may get stuck in railroad flangeways.

crossings are hazardous for all pedestrians and bicyclists. They are particularly hazardous to those who rely on wheeled devices for mobility. Wheelchair and scooter casters, as well as the tires of bicycles can easily get caught in the flangeway gap. In addition, rails or ties that are not embedded in the travel surface create a tripping hazard. Pedestrian safety and accessibility at railroad crossings can be enhanced by:

- Raising the approaches to the track and the area between the tracks to the level of the top of the rail creating flat level areas to cross. When casters on wheelchairs hit changes in level, they rotate and may drop into the flangeway gap;
- Utilizing a surface material that will not buckle, expand, or contract significantly (e.g., textured rubber railroad crossing pads) in all areas adjacent to the tracks so that the surface material will not interfere with railway function or degrade with use;



# 8

# PEDESTRIAN CROSSINGS

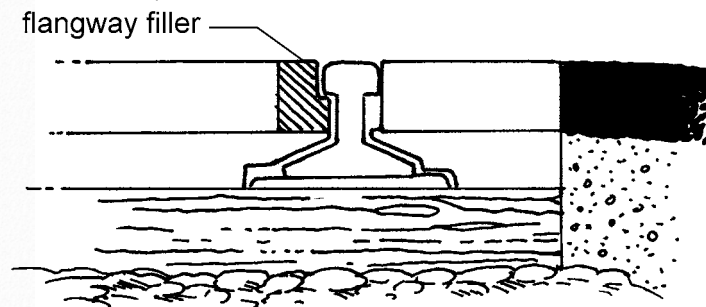
## CHAPTER



**Figure 8-27.** Installing a rubber surface rather than asphalt around railroad flangeways reduces changes in level and other maintenance problems for pedestrians.

- Designing crossings so that the pedestrian paths of travel intersect the railroad track at a 90 degree angle, which minimizes problems with the flange-way gap width;
- Widening the crosswalk when a perpendicular crossing cannot be provided so that pedestrians have room to maneuver and position themselves to cross the tracks at a 90 degree angle;
- Installing detectable warnings similar to a transit platform if the railroad crosses the sidewalk; and
- Providing railroad crossing information in multiple formats, including signs, flashing lights, and audible sounds. The MUTCD requires railroad crossing signs whenever railroad tracks intersect the street.

The flangeway gap is essential to the function of the railroad system. Currently, a rubber insert is available to fill the flangeway gap for light rail tracks that have trains traveling at low speeds (e.g., approaching a transit stop). These “flangeway fillers” provide a level surface for pedestrians but deflect downward with the weight of the train. In this way, pedestrians can cross a “gap free” surface and rail function is unaffected. At the present time, there are no similar products on the market for high speed and heavy freight lines. Further research is needed to develop a product that works for all types of trains.



**Figure 8-28.** The “flangeway filler” eliminates the gap in the path of travel for pedestrians crossing railroad tracks. The filler, consisting of a rubber insert, will deflect downward with the weight of a train and does not affect railway function.

# 9

# TRAFFIC CALMING

## CHAPTER

## Traffic Calming

*The Institute of Transportation Engineers defines traffic calming as “the combination of mainly physical measures that reduce the negative effects of motor vehicle use, alter driver behavior, and improve conditions for nonmotorized street users” (Institute of Transportation Engineers, 1999).*



**Figure 9-1.** Half closures placed at intersections are a traffic calming technique intended to divert motorists off of residential streets by closing one-half the roadway and allowing one-way traffic. Half closures reduce crossing distances for pedestrians.

Traffic calming utilizes design strategies to slow down cars and increase the visibility of pedestrians and bicyclists. The tools of traffic calming are small in scale and, as a result, are able to be tested, photographed, and evaluated easily. Traffic calming has proven to reduce traffic speeds and, consequently, reduce the number of pedestrian deaths. Traffic calming tools particularly complement areas that already have well-designed sidewalks. If adequate sidewalks are not provided and pedestrians are forced to travel in the street, traffic calming tools can be problematic for people with impairments. For example, vertical installations, such as speed humps, force



# 9

# TRAFFIC CALMING

## CHAPTER

pedestrians to negotiate an elevation change. Horizontal installations, such as neighborhood traffic circles, may cause pedestrians to be “squeezed” by vehicles. To best serve the needs of pedestrians, sidewalk facilities should be improved in conjunction with traffic calming projects.

The goals of traffic calming are to:

- Apply physical, engineered measures to compel drivers to slow down and to decrease traffic volumes;
- Implement self-enforcing rather than regulatory measures;
- Reduce cut-through traffic;
- Increase the safety of children, pedestrians, bicyclists, and motorists;
- Maximize street life and pedestrian activity;
- Prevent crime; and
- Enhance urban redevelopment.

In most localities, the immediate and long-term goals of traffic calming are directly related to the concerns of the residents. Parents and citizens are demanding that speeds be reduced and cut-through traffic eliminated, particularly on residential streets near schools and parks. In many communities, citizens have conveyed their traffic-related concerns to local leaders who, in turn, have sought direction from transportation experts to implement traffic calming measures.

Increased pedestrian awareness, slower moving traffic, and fewer vehicles on the road are the direct benefits of traffic calming. These benefits may allow people with disabilities to achieve greater access to roadways and pedestrian facilities. For example, the implementation of traffic calming techniques at pedestrian crossings to reduce crossing distances improves conditions for pedestrians, especially those with mobility, cognitive, and vision impairments. Pedestrians benefit from reduction in traffic speed and volume control measures, which can create entirely traffic-free sections of communities and urban areas.

# 9

# TRAFFIC CALMING

## CHAPTER

Although many traffic calming techniques benefit people with disabilities, some techniques can have a negative impact especially if their needs are not addressed during the planning process. For example, tools such as roundabouts and raised crosswalks can eliminate the crossing gap and sidewalk to street transition information for people with vision impairments. Other methods such as speed humps and textured pavement can be problematic for people with mobility impairments. Fortunately, many of these traffic calming tools can be designed and implemented with accessible

modifications that should become the universal standard for constructing these devices.

The following sections briefly describe each device, discuss the impacts the device has on pedestrian access, and make recommendations for enhancing pedestrian accessibility.

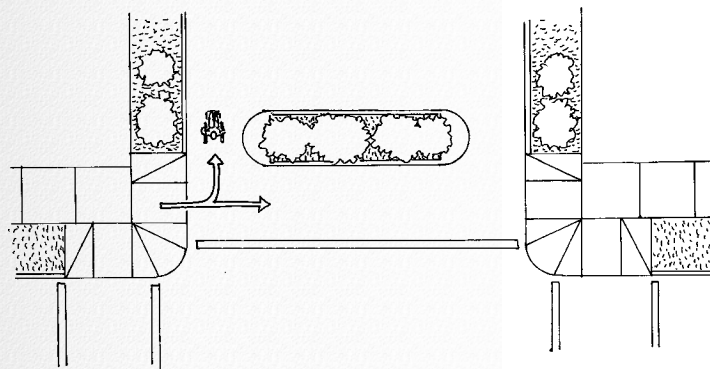
## 9.1 Volume control measures

The primary purpose of volume control measures is to discourage or eliminate cut-through traffic. When a detour through a residential neighborhood allows motorists to avoid traffic, save time, or shorten their travel distance, they will use the residential cut-through as their normal route of travel. The traffic calming tools that have proven to be successful in diverting traffic and reducing cut-through traffic include:

- Full street closures;
- Half street closures;
- Median barriers; and
- Forced turn islands.

### 9.1.1 Full closures

Full street closures are barriers placed across the entire width of the street. Consequently, through traffic is diverted from using the street, and the street is

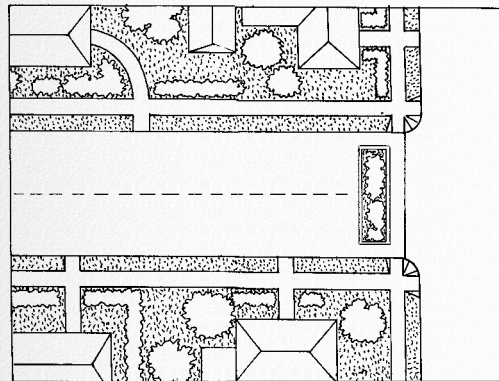


**Figure 9-2.** Full closures eliminate cut-through traffic enabling pedestrians to travel in the street.

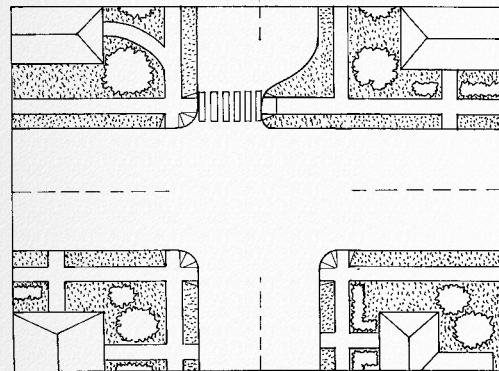
# 9

# TRAFFIC CALMING

## CHAPTER



**Figure 9-3.** Full closures divert traffic off the street, creating pedestrian and bicycle friendly areas.



**Figure 9-4.** Half closures, similar to full closures, are barricades located in the street and constructed of landscaped walls, gates, side-bollards, or other obstructions.

only open to pedestrians, bicyclists, and the residents living on the street. A full closure functions similar to a cul-de-sac or dead-end because these designs include only one point of entry/exit minimizing cut-through traffic. Full closure barricades are usually landscaped walls, gates, side-by-side bollards, or other constructed obstructions. Full closures should be designed to allow access for bicyclists.

### 9.1.1.1 Impact on pedestrian access

Full closures do not have a specific impact on pedestrian access; however, they improve conditions for pedestrians in general by creating a street where only motor vehicles traveling on the street are owned by people living on the closed street.

### 9.1.1.2 Design recommendations for full closures

The following recommendations are intended to enhance access at a full closure:

- Provide pedestrian and bicycle pathways between the street closures to maintain an efficient network of walkways; and
- Design the constructed obstruction to permit pedestrian and bicycle access. For example, if the obstruction uses landscaping, the access routes through that landscaping should have a minimum clear width of 915 mm (36 in).

### 9.1.2 Half closures

Half street closures are similar to full closures and consist of constructed obstructions to block one side of the street. One direction of traffic is diverted to another route. Half closures are often called partial closures or one-way closures. They are constructed using the same materials and designs as full closures.

#### 9.1.2.1 Impact on pedestrian access

Half closures generally benefit pedestrian access as follows:

# 9

# TRAFFIC CALMING

## CHAPTER

### Positive impacts

- Half closures in the form of curb extensions reduce pedestrian crossing distances and enhance pedestrian visibility; and
- Pedestrians only have to be aware of motorists traveling in one direction.

#### 9.1.2.2 Design recommendations for half closures

Half closures should always be designed as curb extensions to reduce pedestrian crossing distances.

### 9.1.3 Median barriers

Median barriers are raised islands located in the middle of a street and continuing through an intersection. Median barriers are implemented to block cut-through movement of motor vehicle traffic at a cross street. Median barriers can block left turning motorists, which can benefit pedestrians. They are also called median diverters or island diverters. For general information about medians, see Section 8.7.

#### 9.1.3.1 Impact on pedestrian access

Median barriers generally benefit pedestrian access as follows:

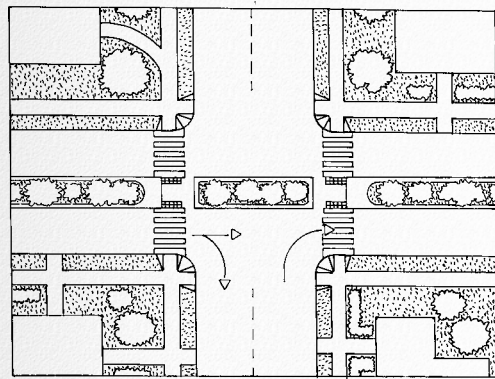
##### Positive impacts

- People with mobility impairments benefit from divided and decreased crossing distances due to the presence of a pedestrian refuge in the center of the street; and
- Pedestrians with slower walking speeds are able to cross one leg of traffic and then wait on a pedestrian refuge before crossing a second leg of traffic.

#### 9.1.3.2 Design recommendations for median barriers

The following recommendations are intended to enhance pedestrian access at median barriers:

- Raise medians to increase pedestrian visibility, to separate pedestrians and motorists, and to improve detectability for people with vision impairments; and



**Figure 9-5.** Median barriers block cut-through movement at a cross street and divert traffic in one direction. There should be an open passageway for bicyclists.

# 9

# TRAFFIC CALMING

## CHAPTER

- Design median barriers to include access for bicyclists and accessible features, such as cut-throughs with detectable warnings. Median barriers should have a minimum clear width of 915 mm (36 in).

### 9.1.4 Forced turn islands

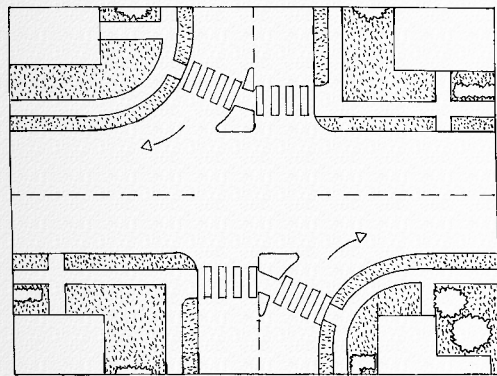
Forced turn islands are also called forced turn channelizations, pork chops, or right turn islands. They prevent traffic from certain movements when approaching an intersection. For general information about islands, see Section 8.8.

#### 9.1.4.1 Impact on pedestrian access

Although forced turn islands have some benefits for people with mobility impairments, they are not as desirable as median barriers for diverting traffic because they complicate the intersection for people with vision impairments. Forced turn islands impact pedestrian access as follows:

### Negative impacts

- The sound of traffic patterns is modified, and the required path of travel can be difficult for people with vision impairments to detect and analyze;
- Forced turn islands minimize the motorist's need to stop at an intersection, and therefore driver speeds through the crosswalk area are increased. In addition, motorists often fail to yield the right-of-way to pedestrians, particularly individuals with vision impairments, because of the lack of pedestrian to driver eye contact;
- Cars must yield to oncoming traffic in the path of pedestrian crossings;
- Motorists are positioned to look for traffic and not pedestrians entering the crosswalk; and
- Bicyclists will find it difficult to maintain a through traffic position.



**Figure 9-6.** Forced turn islands should be designed to include features that promote access such as cut-through medians with detectable warnings and a minimum width of 915 mm (36 in).



# 9

# TRAFFIC CALMING

## CHAPTER

### Positive impacts

- Pedestrians benefit from divided and decreased crossing distances due to the presence of a pedestrian refuge; and
- Pedestrians with slower walking speeds are able to cross one leg of traffic and then wait on a pedestrian refuge before crossing a second leg of traffic.

detectable warnings and a minimum clear width of 915 mm (36 in); and

- Provide space for bicyclists to share the road with motorists.

### 9.2 Speed Control Measures

Two types of traffic calming measures that control the speed of vehicles on streets and impact pedestrian access are (Institute of Transportation Engineers, 1999):

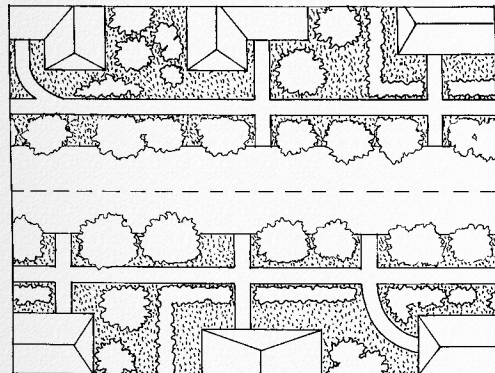
- Vertical measures, which rely on forces of vertical rise acceleration to discourage speeding; and
- Horizontal measures, which rely on forces of lateral shift acceleration to discourage speeding.

A third form of speed control is a narrowing measure, which relies on a psycho-perceptive sense of enclosure to discourage speeding. Installing a tree canopy to create a sense of enclosure is an example of a narrowing measure. This type of traffic calming does not impact

#### 9.1.4.2 Design recommendations for forced turn islands

The following recommendations are intended to enhance pedestrian access at forced turn islands:

- Minimize lane widths to slow vehicle speeds;
- Minimize vehicle speeds by tightening the angle of deflection used for the forced turn island;
- Design islands to include accessible features, such as cut-throughs with



**Figure 9-7.** Trees, when located on both sides of the street, create a sense of enclosure that discourages drivers from speeding.

# 9 TRAFFIC CALMING

## CHAPTER

pedestrian access if a sidewalk is provided. A 915 mm (36 in) clear space on both sides of the street allows for bicyclists to travel through. The general benefits of slower motorist speeds benefits all pedestrians.

Vertical speed control measures that will be evaluated in the following sections include:

- Speed humps;
- Speed tables;
- Raised crosswalks;
- Raised intersections; and
- Textured pavement.

Horizontal measures that will be evaluated in the following sections include:

- Roundabouts;
- Neighborhood traffic circles;
- Chicanes, lateral shifts, and chokers;
- Curb extensions; and,
- Center island narrowings.



**Figure 9-8.** Speed humps are a common vertical measure for controlling the speed of motorists in residential neighborhoods.

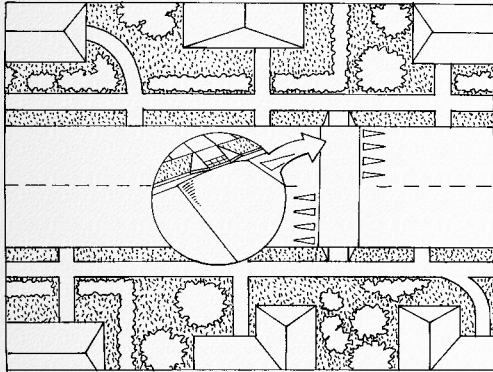
### 9.2.1 Speed humps

Speed humps are raised sections of pavement that are placed across the street to force motorists to travel at reduced speeds. Speed humps have a more gradual slope than traditional speed bumps, which

# 9

# TRAFFIC CALMING

## CHAPTER



**Figure 9-9.** A 3.66 m (12 ft) long speed hump with a 101 mm (4 in) vertical elevation change minimizes the jarring effect and potential vehicle damage experienced with traditionally designed speed bumps.

are often found in parking lots. Speed humps are more effective at slowing traffic than speed bumps because the driver actually benefits from traveling at slower speeds. Speed bumps typically jar the motorist regardless of speed. The best speed hump designs employ a very gradual slope, such as a 3.66 m (12 ft) long speed hump with a 101 mm (4 in) vertical elevation change, to reduce jarring and potential vehicle damage. Speed humps are effective in reducing traffic speeds and are a low cost tool. However, speed humps may be controversial in some localities due to their appearance and jarring effects on vehicles and passengers.

### 9.2.1.1 Impact on pedestrian access

In general, speed humps effectively slow traffic and benefit all pedestrians including people with disabilities. However, people with mobility impairments may experience problems on speed humps. For example, people with back or neck problems may experience pain or discomfort caused by the jarring effect when traveling over

speed humps in an automobile. This is further complicated if the person relies on para or public transit and does not have control over the speed of the vehicle.

### 9.2.1.2 Design recommendations speed humps

The following recommendations are intended to enhance pedestrian access at speed humps:

- Design speed humps with gradual slopes and minimal changes in elevation to limit jarring; and
- Do not install speed humps in the path of a pedestrian crossing or curb ramp.

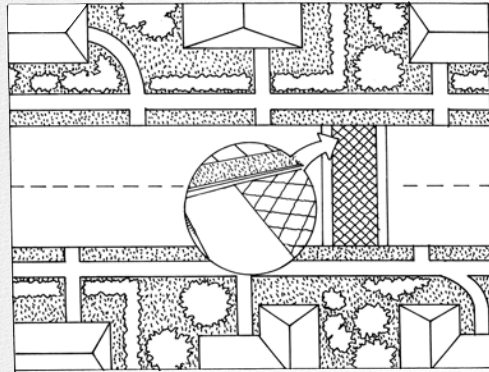
### 9.2.2 Speed tables and raised crosswalks

Speed tables are similar to speed humps; however, they include a flat section on top. Oftentimes, the top of the speed table is constructed with a

# 9

# TRAFFIC CALMING

## CHAPTER



**Figure 9-10.** Speed tables and raised crosswalks are flush with the curb and do not provide a clear distinction for people with vision impairments unless detectable warnings are installed.

decorative surface material. When marked as a pedestrian crossing, speed tables are called raised crosswalks. The length of speed tables or raised crosswalks allow all four wheels of a vehicle to rest on the raised section at the same time. Combined with gently sloped ramps, speed tables permit slightly higher motorist speeds and smoother transitions than speed humps. Additional information about raised crosswalks is contained in Sections 6.3 and 8.5.

### 9.2.2.1 Impact on pedestrian access

Speed tables resolve some of the access problems for people with mobility impairments. However, they can be problematic for people with vision impairments if their needs are not considered. Speed tables impact pedestrian access as follows:

#### Negative impacts

- People with back and neck problems may experience pain or discomfort when traveling over speed tables in

motor vehicles (though less jarring than traveling over speed humps); and

- When used as a crosswalk, unless detectable warnings are provided, there is no distinction between the sidewalk and the street for people with vision impairments.

Note: When used as a crosswalk, there is no negative impact on pedestrians with visual impairments when detectable warnings are installed.

#### Positive impacts

- Speed tables used as raised crosswalks increase pedestrian visibility; and
- Speed tables used as crosswalks eliminate the need for a curb ramp, which improves access for people with mobility impairments and increases the sidewalk area available to pedestrians waiting to cross the street.



# 9

# TRAFFIC CALMING

## CHAPTER

### 9.2.2.2 *Design recommendations for speed tables*

The following recommendations are intended to enhance pedestrian access at speed tables and raised crosswalks:

- Install detectable warnings whenever speed tables are used as raised crosswalks to identify the transition between the sidewalk and the street; and
- Select colored asphalt rather than brick or other decorative surface materials to enhance rollibility for people with mobility impairments. Brick trim may be used in outlining the pedestrian travel path, but not in the pathway. (See Section 4.3.1.4).

### 9.2.3 **Raised intersections**

A raised intersection refers to a roadway intersection that is entirely elevated to the sidewalk level. Raised intersections are designed with ramps for the motorist and often include decorative

surface materials on the flat raised section. Raised intersections are usually the same height as the sidewalk creating a pedestrian territory that includes the sidewalk and crosswalks.

### 9.2.3.1 *Impact on pedestrian access*

Raised intersections have benefits and drawbacks that are similar to raised crosswalks. For example:

#### **Negative impacts**

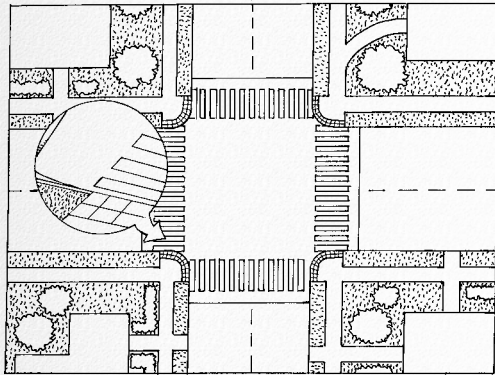
- People with back and neck problems can experience additional pain or discomfort caused by the jarring effect when traveling over raised intersections in motor vehicles (though less jarring than traveling over raised crosswalks or speed humps); and
- If detectable warnings are not included, people with vision impairments are not able to make the distinction between the sidewalk and the street.



# 9

# TRAFFIC CALMING

## CHAPTER



**Figure 9-11.** When raised intersections are installed, detectable warnings should be included at the edge of the curb so people with vision impairments can identify the transition between the sidewalk and the street.

### Positive impacts

- Raised intersections increase pedestrian visibility;
- Raised intersections eliminate the need for a curb ramp at an intersection, which improves access for people with mobility impairments and increases the sidewalk area available to pedestrians waiting to cross the street; and
- Raised intersections can provide accessibility solutions for narrow sidewalks.

### 9.2.3.2 Design recommendations for raised intersections

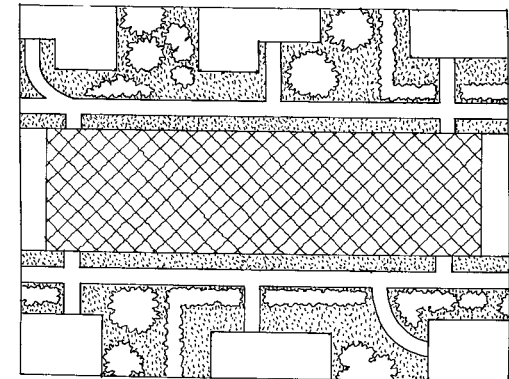
The following recommendations are intended to enhance pedestrian access at raised intersections:

- Install detectable warnings to identify the transition between the sidewalk and the street; and
- Select a smooth surface, such as colored asphalt, rather than brick or

other decorative surface materials to enhance access for people with mobility impairments (See Section 4.3.1.4).

### 9.2.4 Textured pavement

Textured pavement is a surface material on the roadway, such as brick, concrete pavers, and stamped asphalt, which is installed to produce small, constant changes in vertical alignment.

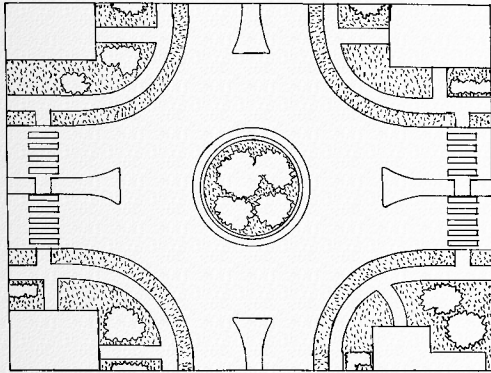


**Figure 9-12.** When textured pavements are used, wheelchair users experience discomfort during travel and people with vision impairments have difficulty identifying detectable warnings.

# 9

# TRAFFIC CALMING

## CHAPTER



**Figure 9-13.** A modern roundabout should have set back crosswalks and splitter islands to better accommodate pedestrians. However, even with these design improvements, people with visual impairments experience difficulty negotiating roundabouts.

Textured pavements do reduce travel speeds; however, they are difficult for bicyclists and some pedestrians to negotiate (see Section 4.3.1.4).

### 9.2.4.1 Impact on pedestrian access

Textured pavement is problematic for people with disabilities. For example:

#### Negative impacts

- Amount of work is increased for people with mobility impairments to travel over textured pavements.
- Wheelchair users experience a bumpy ride and there is a potential for wheelchair casters to catch and swivel in grooves.
- Decorative materials often lift, settle, and buckle over time which creates a tripping hazard for all people, especially people with low vision.
- Decorative surface materials may make it more difficult for

pedestrians with vision impairments to identify detectable warnings which provide critical information about the transition from the sidewalk to the street.

### 9.2.4.2 Design recommendations for textured pavement

Due to negative impacts on pedestrians and access, the installation of large areas with textured pavement at intersections and midblock crossings should be avoided as a traffic calming tool.

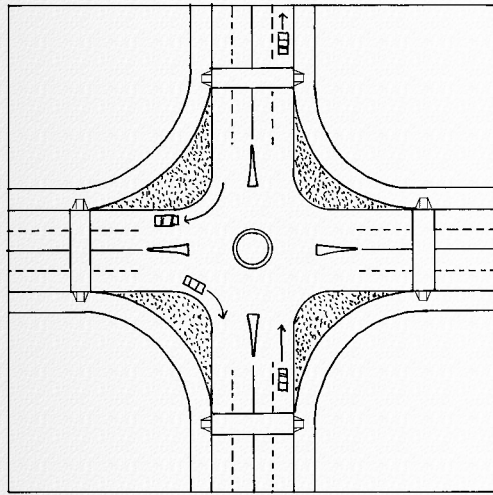
### 9.2.5 Roundabouts

Roundabouts require vehicles to circulate counterclockwise around a center island. Roundabouts may eliminate the need for traffic signals for motorists. Unlike many other forms of traffic calming, roundabout benefits are aimed primarily at motorists. The installation of roundabouts prioritizes improving traffic flow, maximizing vehicular capacity, and eliminating the need for stop signs and

# 9

# TRAFFIC CALMING

## CHAPTER



**Figure 9-14.** This drawing illustrates a common roundabout design found in Sweden that includes large grass buffers that separate pedestrians and motorists at exit and entry points. The crosswalks are set back about four car lengths to reduce pedestrian and motorist conflicts.

traffic signals. When designed correctly, roundabouts include raised splitter islands to channel incoming traffic approaching from the right. Although roundabouts are gaining popularity in the United States, they can be problematic in pedestrian areas until designs can include cues needed by pedestrians with vision impairments and cognitive disabilities.

### 9.2.5.1 Impact on pedestrian access

Roundabouts significantly complicate travel for people with vision and cognitive impairments. For example:

#### Negative impacts

- Motorists exiting the roundabout are often not required to yield to pedestrians. This is a particular problem at designs where exiting design speed is increased;
- If properly designed, the crosswalk locations are set back from the intersection, to enhance pedestrian visibility and to prevent drivers from

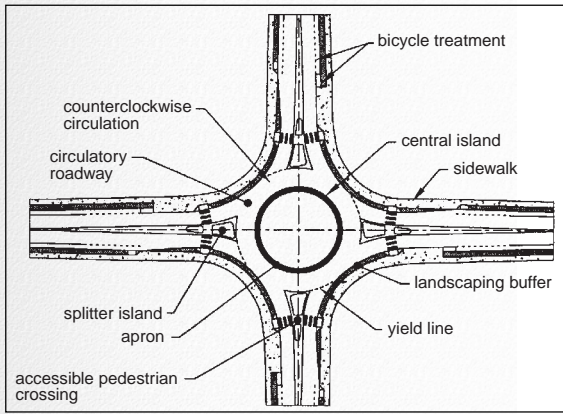
stopping at the entrance of the roundabout. This design has safety benefits for most pedestrians at the entering leg because vehicles are required to yield to vehicles in the roundabout. Pedestrians crossing the existing leg may be at a greater disadvantage because exiting speeds are usually increased. Setback crosswalks are difficult for people with vision impairments to identify because they are not at the roundabout itself;

- Busy roundabouts provide very few gaps long enough to cross. This can be especially problematic and unsafe for pedestrians such as children, elderly with mobility and cognitive impairments, and people with vision impairments;
- Pedestrians with vision impairments experience difficulty seizing the right-of-way from exiting drivers due to the lack of pedestrian to driver eye contact;

# 9

# TRAFFIC CALMING

## CHAPTER



**Figure 9-15.** Urban single lane roundabout with splitter island for pedestrian refuge. Truncated domes need to be placed at the curb ramps and splitter island. Landscape barrier, guidance cue at curb ramps, and APS are needed for crossing information, safety, and accessibility.

- For persons with vision impairments, vehicles exiting the circle sound the same as motorists continuing around the circle;
- Due to the wide turning radii at the corner, pedestrians with vision impairments may fail to identify the intersection;
- Roundabouts are confusing for people with cognitive impairments due to the irregular design of the intersection. People with cognitive impairments may not be able to travel independently if these intersections exist in routes that are traveled in order to conduct daily functions and activities; and
- When a crosswalk is setback from the intersection, pedestrians have to walk longer distances out of their way to cross the street. Some pedestrians will use the most direct route regardless of the crosswalk placement.

### 9.2.5.2 Design recommendations for roundabouts

Designing roundabouts for people with vision impairments is a topic that warrants significant future research. Some smaller roundabouts may prove to pose few problems for people with vision impairments, but that depends on how busy or quiet it is. Some smaller roundabouts in quiet or isolated environments may prove to pose fewer problems for people with vision impairments. However, other roundabouts, in busy and noisy environments, may be identified as unusable by people with vision impairments regardless of the additional treatments used. The following recommendations could potentially improve conditions for pedestrians at roundabouts:

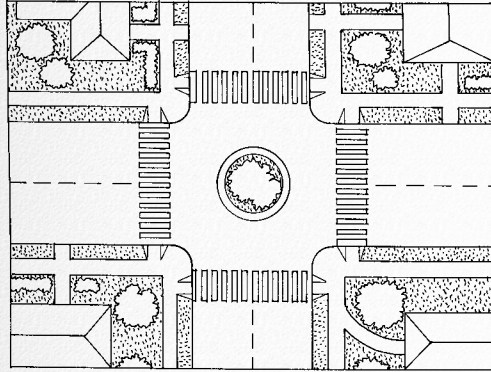
- Install setback, highly-visible crosswalks with detectable warnings and tactile indicators to identify the crossing for pedestrians with vision impairments and accessible pedestrian signals (including locator tones) to enable pedestrians to



# 9

# TRAFFIC CALMING

## CHAPTER



**Figure 9-16.** Access at neighborhood traffic circles can be improved by installing highly visible and/or raised crosswalks.

have sufficient crossing time. An accessible pedestrian signal can be provided to initiate the crossing phase;

- Install single lane roundabouts with single entry lanes, rather than multi-lane roundabouts, to shorten the crossing distance and enhance pedestrian visibility at the entry and exiting lanes;

- Add accessible medians and splitter islands to reduce crossing distances and allow pedestrians to negotiate one direction of traffic at a time; and
- Add rumble strips or some other noise-generating device to increase the sound of cars making them more detectable and reduce the speed of cars as they exit the roundabout. Use slip resistant material for bicyclists.



**Figure 9-17.** Neighborhood traffic circles are a common horizontal measure for controlling the speed of motorists at a low volume intersection.

### 9.2.6 Neighborhood traffic circles

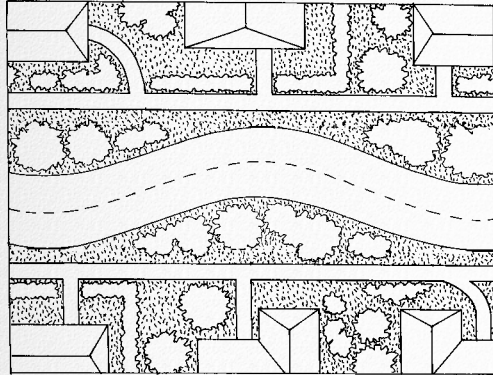
Neighborhood traffic circles are similar to roundabouts in that traffic is required to circle around a center island counterclockwise. Neighborhood traffic circles are typically controlled by YIELD signs but may be controlled by STOP signs. Traffic circles are often located on lower volume residential streets. Traffic circles are the most common horizontal measure of traffic calming.



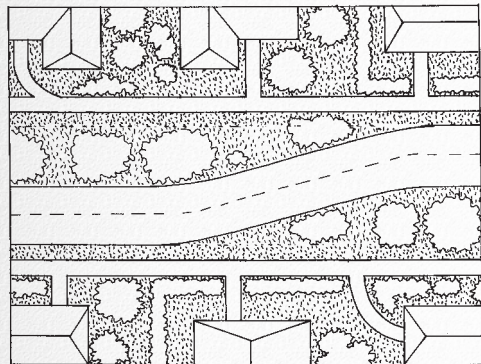
# 9

# TRAFFIC CALMING

## CHAPTER



**Figure 9-18.** Chicanes have lateral shifts that alternate on both sides of the street creating an S-shaped path of travel.



**Figure 9-19.** Lateral shifts break up long sections of roadway. When motorists cannot see what is ahead, they tend to travel at slower speeds.

### 9.2.6.1 Impact on pedestrian access

Although they are not as problematic as roundabouts, neighborhood traffic circles still have a negative impact on pedestrian access:

#### Negative impacts

- Motorists exiting the traffic circle often fail or are not required to yield to pedestrians;
- If the angle of deflection is significant, the motorists' path of travel will extend into the pedestrian crosswalk;
- People with vision impairments use the sound of parallel traffic to align themselves, which becomes a challenge at roundabouts because of the unusual configuration; and
- At intersections where motorists yield and stop, pedestrians with vision impairments experience difficulty assessing whether they have the right-of-way from drivers due to the lack of pedestrian and driver eye contact.

### 9.2.6.2 Design recommendations for neighborhood traffic circles

The following recommendations are intended to enhance pedestrian access at neighborhood traffic circles:

- Set back crosswalks slightly to accommodate for the motorists extended path of travel; and
- Install highly visible or raised crosswalks to make the pedestrian more visible and to further slow motorists.

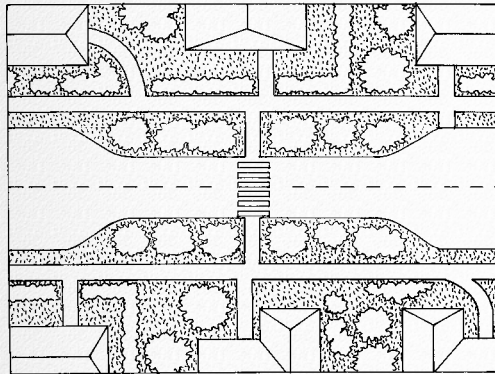
### 9.2.7 Chicanes, lateral shifts, and chokers

Chicanes, lateral shifts, and chokers are all curb extensions installed away from an intersection to create a narrow two-lane gap or a single lane. Chicanes shift traffic alternately from side to side of the street to create an S-shaped path of travel. Lateral shifts are curb extensions that cause travel lanes to bend one way and then back the other way. Chokers are midblock curb

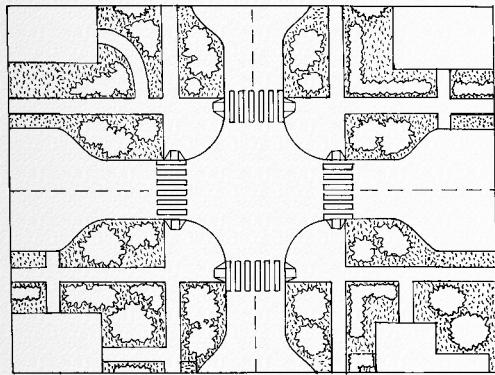
# 9

# TRAFFIC CALMING

## CHAPTER



**Figure 9-20.** Chokers reduce pedestrian crossing distances and enhance pedestrian visibility at a midblock crossing.



**Figure 9-21.** Curb extensions at medians should include low landscaping to clarify the path of travel for pedestrians with vision impairments. High landscaping would block sight lines for motorists and pedestrians.

extensions that narrow the street by expanding the sidewalk or adding a planting strip and often are installed at midblock crossings.

### 9.2.7.1 Impact on pedestrian access

In general, chicanes, lateral shifts, and chokers have positive impacts on pedestrian access. When designed as curb extensions, chokers reduce pedestrian crossing distances and enhance pedestrian visibility when installed at midblock crossings.

### 9.2.7.2 Design recommendations for chicanes, lateral shifts, and chokers

The following recommendations are intended to enhance access at chicanes, lateral shifts, and chokers:

- Install sidewalks that continue in a straight path rather than following the path of the chicane, lateral shift, or choker; and

- Design chokers to include curb extensions with landscaping when designed at midblock crossings.

## 9.2.8 Curb extensions at intersections

Curb extensions at intersections are installed to reduce the roadway width from curb to curb at an intersection. Other names for curb extensions include neckdowns and bulbouts.

### 9.2.8.1 Impact on pedestrian access

Curb extensions at intersections are the most common type of street narrowing and are primarily used to make intersections more pedestrian friendly. Curb extensions benefit pedestrians by creating shorter crossing distances, increased pedestrian visibility, and tighter curb radii that reduce the speeds of turning vehicles. On existing narrow sidewalks, curb extensions can provide an area necessary for curb ramps.

# 9

# TRAFFIC CALMING

## CHAPTER

### 9.2.8.2 Design recommendations for curb extensions

The following recommendations are intended to enhance access at curb extensions:

- Design curb extensions so that they do not extend past the parking lane;
- Include a narrow passage for bicyclists to prevent vehicle conflicts;
- Design all curb extensions to include features such as well-designed curb ramps with detectable warnings; and
- Include landscaping on the curb extension to distinguish the path of travel for pedestrians with vision impairments.

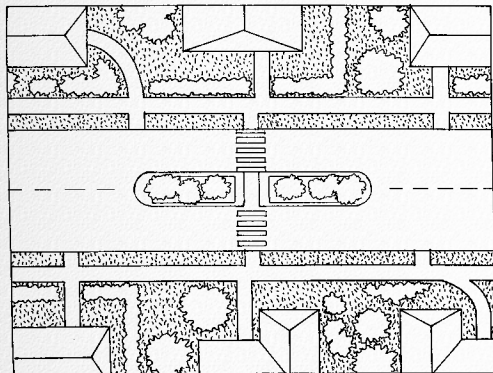
Other names for center island narrowings include midblock medians, median slow points, or median chokers. Travel speeds are reduced due to the narrow path of travel at that location and are particularly effective on curves. Center islands also act as effective pedestrian refuge locations.

### 9.2.9.1 Impact on pedestrian access

Center island narrowings have the following positive impacts on access:

#### Positive impacts

- People with disabilities benefit from decreased crossing distances; and
- Pedestrians with slower walking speeds are able to cross one leg of traffic and then wait on a pedestrian refuge before crossing a second leg of traffic.



**Figure 9-22.** Center island narrowings provide pedestrians with reduced crossing distances due to the presence of a pedestrian refuge area.

### 9.2.9 Center island narrowings

Center island narrowings are raised islands located at the centerline of a street.

# 9

# TRAFFIC CALMING

## CHAPTER

### **9.2.9.2 Design recommendations for center island narrowings**

The following recommendations are intended to enhance access at center island narrowings:

- Raise medians to better separate pedestrians and motorists;
- Design median barriers to include accessible features such as cut-throughs with detectable warnings for people with vision impairments and a minimum clear width of 915 mm (36 in);
- Center island narrowing can narrow lanes to lower vehicle speed which enhances the safety of roadway crossings for pedestrians; and
- Consider bicycle travel when reducing lane width and provide a way for bicyclists to share the road with motorists.



# Sidewalk Maintenance and Construction Site Safety



**Figure 10-1.** Regular sidewalk maintenance can prevent or correct sidewalk conditions, such as changes in level.

All facilities, including sidewalks, require regular maintenance to reduce the damage caused over time by the effects of weather and use. However, many maintenance issues can be reduced if properly addressed in the planning and designing phases before construction even begins. Proper maintenance is essential to promote user safety, to ensure ease of access, and

to encourage the use of a designated route. The implementing regulations under Title II of the Americans with Disabilities Act require all features and equipment that are required to be accessible to be maintained in operable working condition for use by individuals with disabilities (U.S. Department of Justice, 1991a).

## 10.1 Facility maintenance

Accessible designs are useless if maintenance is neglected and sidewalks are allowed to degrade to a state where they cannot be used or must be avoided



during travel. Frequently identified roadway safety and sidewalk design problems include:

- Sidewalk surfaces in poor repair, such as uneven or broken concrete and slabs uplifted by tree roots; and
- Lack of regular sidewalk maintenance, including overhanging trees and excessive snow on sidewalks.

Maintenance strategies should be included in the preliminary planning stages of new construction and alterations. Maintenance plans should also address existing facilities. The extent and frequency of maintenance schedules will vary greatly depending on the location, amount of use, and resources available. It is recommended that a plan be developed that clearly specifies the frequency of maintenance activities and how reported maintenance concerns will be addressed.

### 10.1.1 Assessment techniques

In order to maintain passable sidewalk conditions, current and potential problems must be identified through an objective assessment process. There are many methods available for identifying maintenance needs on existing sidewalks. For example:

- Large cities may devote a branch of their Public Works department solely to sidewalk inspection and repair;
- The Sidewalk Assessment Process (SWAP) records and prioritizes maintenance needs on sidewalks (see Chapter 11);
- Pedestrians may identify and report maintenance problems (see Section 10.3); and
- A city may establish an improvement program that identifies sites requiring improvements, access, or maintenance.

For a maintenance program to be effective, it must identify conditions that can impede pedestrian access and quickly respond with prompt repairs. Any citizen complaints reported should be given first consideration for improvement or repair if the reporting involves a safety or access issue.

### 10.1.2 Sidewalk maintenance problems

Sidewalk inspectors should look for conditions likely to inhibit pedestrian access or cause injuries. The following list of common sidewalk maintenance problems was generated from promotional material created for homeowners by the Bureau of Maintenance in the City of Portland, Oregon (1996) and the Division of Engineering for the Lexington–Fayette County Urban Government (1993):

- **Badly cracked concrete** – Holes and rough spots ranging from hairline cracks to indentations wider than 13 mm (0.5 in);
- **Spalled areas** – Fragments of concrete or other building material detached from larger structures;
- **Settled areas that trap water** – Sidewalk segments with depressions, reverse cross slopes, or other indentations that make the sidewalk path lower than the curb. These depressions trap silt and water on the sidewalk and reduce the slip resistant nature of the surface;
- **Tree root damage** – Roots from trees growing in adjacent landscaping that cause the walkway surface to buckle and crack;
- **Vegetation overgrowth** – Ground cover, trees, or shrubs on properties or setbacks adjacent to the path that have not been pruned can encroach onto the path and create obstacles;
- **Step separation** – A vertical displacement of 13 mm (0.5 in) or greater at any point on the walkway that could cause pedestrians to trip or prevent the wheels of a wheelchair or stroller from rolling smoothly;



**Figure 10-2.** Sidewalk cracks and broken concrete are common sidewalk maintenance problems that inhibit pedestrian access to sidewalks.



- **Obstacles** – Objects located on the sidewalk, in setbacks, or on properties adjacent to the sidewalk that obstruct the passage space. Obstacles commonly include trash receptacles, utility poles, newspaper vending machines, and mailboxes;
- **General Safety** – Any safety issue that a pedestrian or sidewalk inspector believes should merit attention;
- Blocked drainage inlets and inadequate flow planning;
- Temporary construction interruptions; and
- Inadequate patching after utility installation.

### 10.1.3 Maintenance responsibilities

Although sidewalks are usually elements of the public right-of-way, some city charters assign the responsibility for sidewalk upkeep to the owner of the adjacent property. City charters commonly

specify that the city cannot be held liable for any accidents or injuries incurred due to sidewalk conditions.

When homeowners and businesses are responsible for sidewalk maintenance, they are allowed to decide whether to hire a contractor, perform repairs on their own, or have the city do the repair. Homeowner associations in some neighborhoods address right-of-way maintenance as a group to minimize the cost to individual members. In some areas, the city will subsidize property owners for sidewalk repairs. Local laws may also dictate whether or not a homeowner must hire a professional contractor to undertake sidewalk repair. Regardless of the approach for sidewalk maintenance, municipal inspectors should review and approve all repairs to guarantee that the improved sidewalk meets pedestrian access needs.

## 10.2 Information maintenance

In addition to maintaining the physical characteristics of sidewalks,

agencies should also maintain signs, signals, and other information regarding crossing construction and general pedestrian facility conditions. Periodic reassessment of sidewalks should be conducted to verify that conditions have not changed. Assessment data should also be verified after a catastrophic event, such as a flood or an earthquake.

Signs should comply with MUTCD and ADAAG specifications. In general, signs

should also be reevaluated periodically and replaced when age and weathering reduces legibility. The design of the sign and signal should consider the information that is being displayed, as well as actions taken to reduce theft or vandalism. Signs should be removed or replaced when messages are no longer needed, the content of the information has changed, or information is not being provided for people with visual impairments.

**Figure 10-3.** Residents of Seattle can request the installation of a wheelchair ramp at an intersection by completing this form and submitting it to the City's Wheelchair Ramp Program.

### CITIZEN WHEELCHAIR RAMP REQUEST

City of Seattle Wheelchair Ramp Program

**Please provide a written description or sketch of the location(s) where wheelchair ramps would make your travel more safe and convenient.**

**LOCATION:** NE NW SE SW All \_\_\_\_\_ corner(s) of the \_\_\_\_\_  
(please circle appropriate locations) ↑ N

intersection between \_\_\_\_\_  
(please list intersecting streets above)

**PLEASE PROVIDE BELOW**  
Comments, Suggestions or Other Information that may assist us in providing a better service to you!

Please mark intersection corners needing wheelchair ramps with an "X".

(Street Name)

(Street Name)

---

**REPORTED BY:** Name \_\_\_\_\_ Day Phone \_\_\_\_\_  
Address \_\_\_\_\_ Zip \_\_\_\_\_ Date \_\_\_\_\_

---

Please return to: Wheelchair Ramp Program  
Rm 708 Municipal Building  
Seattle, WA 98104

For more information,  
Contact Pam Hamlin  
at 684-5377

### 10.3 Citizen reporting

Those responsible for sidewalk maintenance should provide users with a convenient means to report sites in need of maintenance. The following techniques have been used successfully by a variety of municipalities to obtain maintenance input from users:


- Publishing a comprehensive maintenance guide with easy to follow guidelines that highlight the local maintenance goals and procedures;

- Using mass mailings to send self-addressed stamped forms for requesting a repair. For

example, the Maine Department of Transportation's "Spot Me" program sends residents a postcard asking for small repair/improvement suggestions along bikeways. This type of a program could also be used to improve sidewalk access;


- Using additional signs or adhesive stickers attached to existing signs, to instruct pedestrians on how to submit maintenance/improvement requests;
- Periodically placing information flyers in local newspapers; and
- Making maintenance information available at public and school libraries.

Citizens' Request programs can provide local maintenance agencies with an efficient way of repairing facilities. Residents living in an area can often identify issues quicker than a centralized agency.



### SPOT ME

Maine Department of Transportation



Bicycle Coalition of Maine

The Spot ME Program is designed to address low cost road improvements to State roads that will enhance bicycle safety and access (maintenance work, signs and striping, and small construction projects)

---

**Location:** Roadway name \_\_\_\_\_

**Landmarks:** (cross street, address, etc). Be specific! \_\_\_\_\_

**Description of Problem:** (What is it, and why is it a problem) \_\_\_\_\_

---

Name \_\_\_\_\_ Day phone \_\_\_\_\_ Date \_\_\_\_\_

Address \_\_\_\_\_ Zip \_\_\_\_\_

Sent to: \_\_\_\_\_ Div/Bureau \_\_\_\_\_ On \_\_\_\_\_

Resolution: \_\_\_\_\_

By: \_\_\_\_\_ On \_\_\_\_\_ Letter \_\_\_\_\_

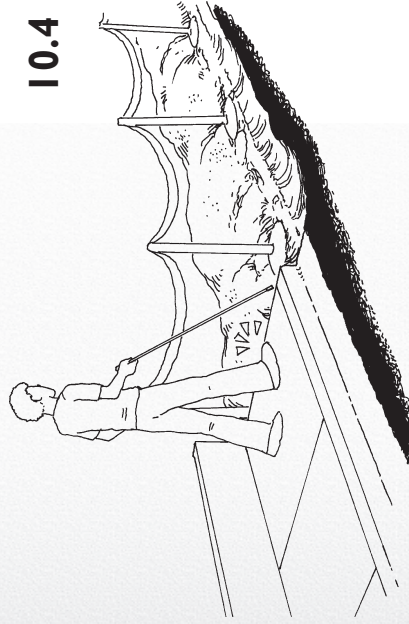
Working for Safe Bicycling  
Bicycle Coalition of Maine P.O. Box 5275, Augusta, Maine 04332 Tel: (207) 865-4842

**Figure 10-4.** The Maine Department of Transportation sends to its residents this "Spot Me" postcard. Residents use the postcard to suggest small repairs and improvements along streets and sidewalks.



Pedestrians who take the time to submit problems to the appropriate agency need to receive a timely written response or see quick results to feel their efforts were worthwhile. If timely action or notification of pending action is not taken, participants could become frustrated and be less likely to spend time in the future identifying problems. If problems are to be resolved in an upcoming project, then the citizen can be notified of the plan.

- Removing entire street sections and/or sidewalks from public circulation;
- Failing to provide a continuous, accessible path of travel around or through construction;
- Not providing adequate warning and rerouting signs so that pedestrians can avoid the affected area;
- Placing potentially dangerous equipment and machines in close proximity to pedestrians;
- Reducing or blocking the pedestrian zone with materials or equipment;
- Failing to ensure that people with vision impairments can easily detect and avoid the construction site;
- Restricting the use of crosswalks by blocking access to available curb ramps;
- Not providing a safe and accessible alternative route around the construction site to adjacent businesses and destinations; and



**Figure 10-5. PROBLEM:** Construction sites should include temporary ramps and should be blocked off with solid fencing. The thin tape in this illustration is not detectable using a long white cane.

#### 10.4 Construction safety

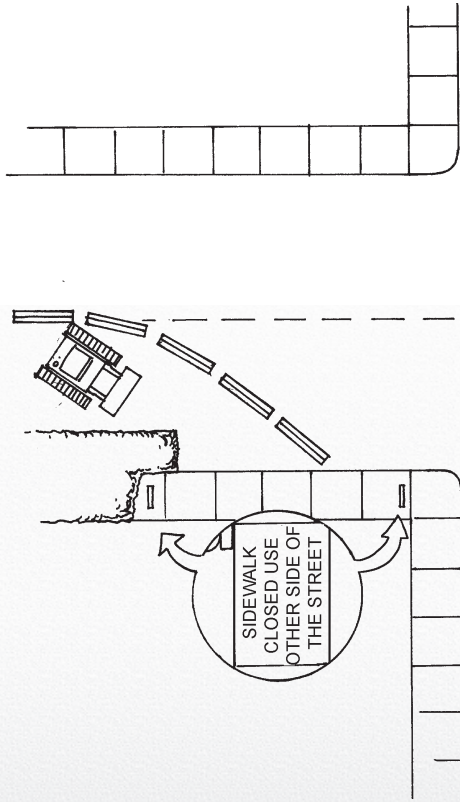
Construction sites contain a variety of hazardous conditions such as work areas, workers, tools, equipment, machines, and stockpiles of materials that are potential obstacles and dangers to pedestrians when not correctly cordoned off from public use.

Roadway and sidewalk maintenance and construction activities can adversely affect pedestrian access by:

- Using ineffective or unusable barriers such as plastic tape around the site.

A variety of measures can be taken to reduce potential safety and access problems at or near construction sites. A continuous route for all pedestrians must be maintained at all times. It is not acceptable to simply close a sidewalk

without identifying an alternate circulation route. The alternate route must enable pedestrians to bypass the construction site without retracing their steps or going significantly out of their way. Additional consideration should be given to the needs of pedestrians with disabilities since they may not have the ability to improvise (e.g., balancing along



**Figure 10-6.** Signs notifying pedestrians of damaged sites or construction work should be located at the corner to prevent pedestrians from reaching the problem and having to turn around. Note: When technology improves, audible information of sidewalk closures should be provided for pedestrians with visual impairments.

the curb or a very narrow path) or use unofficial alternatives (e.g., using an adjacent grass surface). When a temporary route is established, it must be accessible to people with disabilities.

Information sources should be used to provide advance warning to pedestrians of the presence of the sidewalk construction site and to clearly mark the alternate circulation routes available. Information sources should use a variety of methods (e.g., signs, audible information, and electronic information sources) to convey this information to pedestrians. It is particularly important to ensure that all information sources are accessible to people with vision and cognitive impairments that may not be able to access signs or written information sources that have traditionally been used. To ensure the highest level of accessibility, information sources should:

- Conform to ADAAG for items such as finish and contrast, raised and Braille characters, character proportion and height, pictorial symbol signs (pictograms), and mounting height;



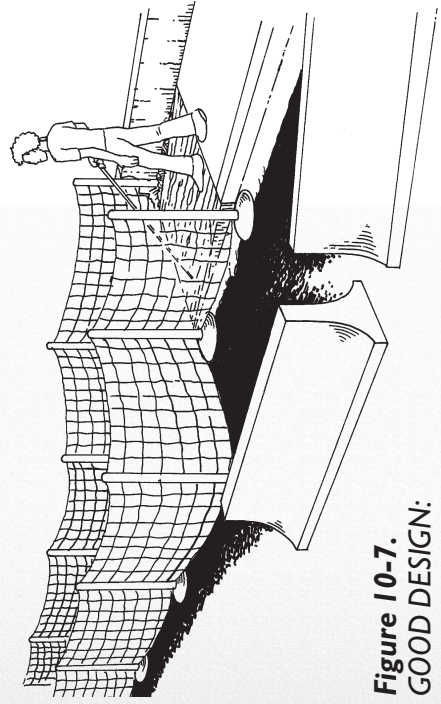
- Recognize that many people with cognitive impairments will be unable to read or understand written text and graphics;
- Utilize simple language and graphics that are easily understood;
- Make pedestrians aware of the sidewalk construction site location and the impact on the circulation route at each intersection or cross street location prior to the construction site, so pedestrians can alter their route before they arrive at the site;
- Make all pedestrians, including those with vision impairments, aware of the problem site and intended repairs as soon as identification of the problem has been recognized by the municipality before the repair or construction work begins;
- Discourage contractors from blocking sidewalks and parking lane to provide contractor parking;
- Indicate the duration of the construction work and any changes to the regular circulation route at the proposed site a reasonable amount of time before the construction takes place so that pedestrians who use the route on a regular basis have sufficient time to plan and learn alternate routes to their destination;
- Clearly delineate the alternate circulation route location and any instructions required for its use (e.g., altered crosswalk signal locations);
- When it becomes available, use technology that provides audible information to people with vision impairments at construction sites. A small broadcasting device that gives recorded instructions when activated by a motion sensor is one method of providing effective audible information to people with vision impairments; and

- Consider using traffic lanes to continue pedestrian access since most pedestrians will walk in the street. Jersey barriers can provide protection for pedestrians from traffic, while parking lanes can provide a temporary pathway.

Additional information can be provided via off-site information sources, including the internet or a telephone information line. However, these should be used only to supplement on-site information sources. Off-site information

sources are beneficial since they allow pedestrians to obtain information in advance of their travel to or near the construction site. Advance information makes it easier for pedestrians to plan an alternate route to avoid the construction site.

It is essential that ground level, solid, continuous barriers be



**Figure 10-7.**  
**GOOD DESIGN:**  
Mesh fencing and temporary ramps are critical features at construction sights.

constructed to prevent pedestrians from entering the construction site either intentionally or unintentionally. Pedestrian safety is compromised because of the obstacles and hazards that will be present if access to the construction site is permitted. The use of flagging tape, ribbon, or signs to identify a site without a solid barrier is inappropriate. Barriers should also be used for all temporary closures, such as window cleaners and painters working overhead.

Barriers defining the alternate route should:

- Be a minimum of 915 mm (36 in) in height and continuous with the ground surface;
- Extend around the entire perimeter of the construction site or the entire length of the alternate circulation route;
- Have no breaks or gaps along the full length of the barrier;

- Have a solid, continuous bottom rail between 10 mm (4 in) and 305 mm (12 in) in height;
- Be of a high contrast color and material;
- Provide temporary ramps and boardwalks as required to ensure a smooth and continuous surface that complies with ADAAG;
- Have a level landing, at least 1.525 m x 1.525 m (60 in x 60 in) in size, at the top and bottom of any slopes greater than 5 percent; and
- Include the area encompassing a smooth transition from the permanent to the temporary route.

Strong consideration should be given to closing off one lane of the street to traffic if pedestrians need to be diverted off of the sidewalk at a site location. This allows the outside (curb) lane for motorists to be used as the alternate pedestrian circulation route. It is easier and quicker for vehicles to find an alternate route than pedestrians, especially those with vision, cognitive, or mobility impairments. Construction contractors should also ensure that supervisors, contractors, and workers at the site are sensitized to the potential pedestrian conflicts that may occur. In this way, they can be alert to changing hazards and conditions that might impact pedestrian safety (e.g., the delivery of a new load of materials) and provide any assistance that pedestrians may require.



# Sidewalk Assessment

Sidewalk planners and designers need an objective method to assess the conditions of sidewalks. With such information, sidewalk professionals can evaluate conditions experienced by pedestrians in the public right-of-way and identify sites requiring accessibility and maintenance improvements. The information can also be used to develop transition plans, verify compliance with design guidelines, provide information to pedestrians, and continue improving sidewalk conditions for all users.



**Figure 11-1.** Collecting objective information about sidewalk conditions is a critical step towards improving the accessibility of existing pedestrian networks.

## 11.1 Benefits of assessment

Inventorying the existing pedestrian facilities and assessing the accessibility of the travelway is the first step towards providing access for all pedestrians. Objective data obtained from sidewalk assessments enables managers to create signs and other informational guides that will assist users in selecting the best routes for travel. Conducting sidewalk assessments is also beneficial because they allow managers to inventory sidewalk conditions and plan for projects, in order to:

- Determine if the sidewalk meets intended design specifications and guidelines;
- Prioritize sidewalk maintenance projects;
- Revise and update Americans with Disabilities Act (ADA) transition plans;

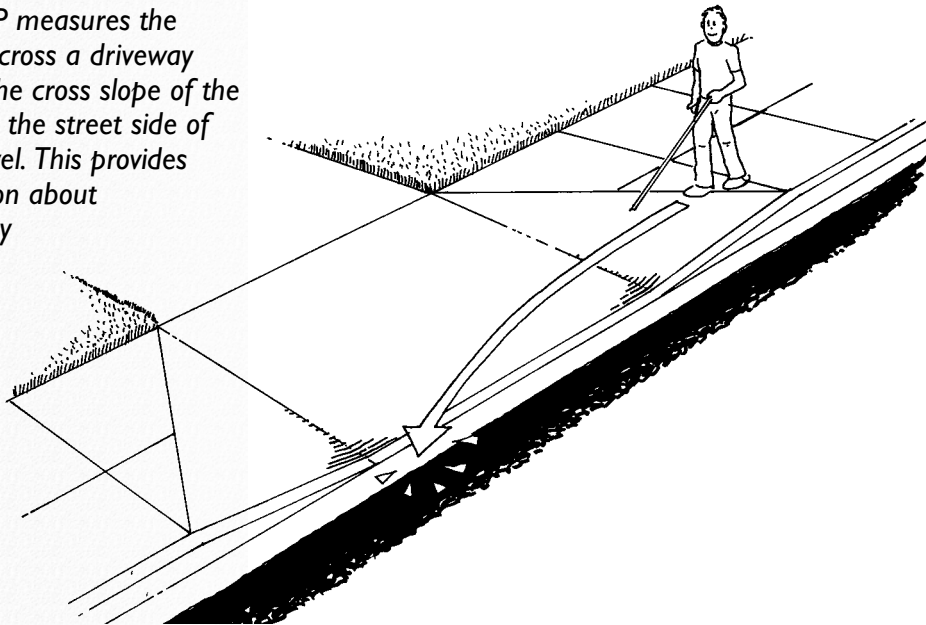
# 11

# SIDEWALK ASSESSMENT

## CHAPTER

- Budget for sidewalk projects;
- Identify portions of sidewalks needing accessibility improvements;
- Develop maintenance schedules;
- Quantify the extent of the work required;
- Catalog feature and maintenance information;
- Share data and project plans with disability focus groups;
- Create objective sidewalk information that can be provided to users in various formats such as signage, maps, and Websites;
- Add pedestrian information to Geographic Information Systems (GIS) mapping and inventories; and
- Justify maintenance funding.

**Figure 11-2.** SWAP measures the best path of travel across a driveway crossing, as well as the cross slope of the driveway crossing on the street side of the best path of travel. This provides important information about whether the driveway crossing has a cross slope that will be detectable by people with vision impairments.



## 11.2 Sidewalk Assessment Process overview

The Sidewalk Assessment Process (SWAP) is a prototype system developed to inventory the dimensions, locations, and conditions experienced by pedestrians in the public right-of-way in a reliable, consistent, and comprehensive manner. Measurement techniques from the Universal Trail Assessment Process (Chapter 12) were modified and adapted to record sidewalk conditions.

Pedestrian coordinators, sidewalk designers, and ADA experts were enlisted to ensure that the Sidewalk Assessment Process accurately recorded information in a usable format about all sidewalk features and dimensions affecting pedestrian access. Conditions identified in accessibility guidelines, pedestrian facility guidelines, and municipal transportation planning documents were also used. The terminology and measurement procedures for the SWAP were developed to ensure consistency in assessments.

Quick measurements of sidewalk components that impact access are recorded on a *Stroll Sheet*, which contains *Station*, *Features*, and *Curb Ramp* forms. Intersections are evaluated using the Intersection Checklist. Complex sidewalk elements such as curb ramps, driveway crossings, and medians identified on the *Stroll Sheet* are measured in more detail and recorded on the *Sidewalk Element Analysis* form. A complete set of the Sidewalk Assessment Process forms is contained in Appendix A.

The Sidewalk Assessment Process is intended to be a modular system. Transportation agencies should identify the components that are most appropriate to their assessment needs. For example, if an agency wanted to determine where access improvements are needed, they would use the basic evaluation recorded on the *Stroll Sheet*. However, if an agency has already determined that a driveway crossing is problematic, they would conduct a complete evaluation using the *Sidewalk Element Analysis* form for driveway crossings.

### 11.3 Sidewalk access characteristics

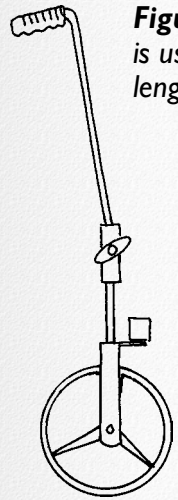
During the development of the Sidewalk Assessment Process, the following characteristics were identified to be most critical to sidewalk access:

- Grade;
- Cross slope;
- Changes in grade and cross slope;

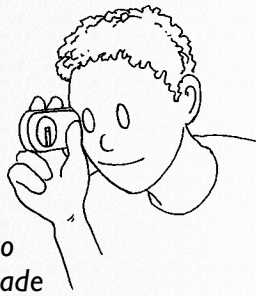
# 11

# SIDEWALK ASSESSMENT

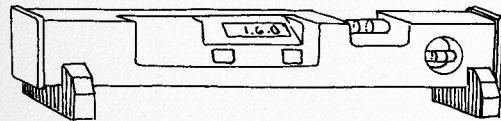
## CHAPTER



**Figure 11-3.** A rolatape is used to measure the length of the sidewalk.



**Figure 11-4.** A clinometer is used to measure running grade between stations.



**Figure 11-5.** A digital inclinometer (level) is used to measure maximum grades, cross slopes, and changes in grade and cross slopes.

- Sidewalk design width;
- Minimum clear width;
- Vertical clearance;
- Location of protruding objects;
- Detectable warnings; and
- Changes in level.

General information about these characteristics including type, dimensions, and location with respect to other sidewalk elements are recorded on the *Stroll Sheet*.

The following complex elements are measured in more detail on the *Element Analysis* forms:

- Curb Ramps;
- Medians;
- Refuge Islands; and
- Driveway Crossings.

## 11.4 Data collection

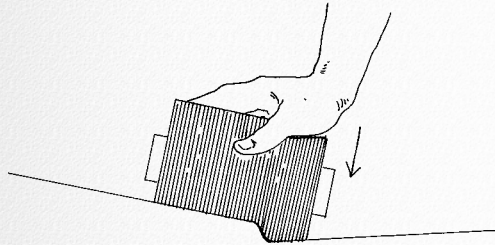
Inexpensive and easy-to-use tools have been selected to simplify the process of measuring sidewalk access characteristics. The tool kit should include a rolatape, tape measure, clinometer, inclinometer, and profile gauge. It is recommended that the assessment team wear safety vests to increase their visibility to motorists. A brief description of each tool follows:

1. A **rolatape**, which is a wheeled measurement device, is used to roll down the center of the sidewalk for measuring the length of the sidewalk.
2. A hand-held **clinometer** is used to measure running grade between stations (the measurement reference points).
3. A **digital inclinometer** (level) is used to measure cross slope, maximum cross slope, maximum grade, and changes in grade and

# 11

# SIDEWALK ASSESSMENT

## CHAPTER



**Figure 11-6.** A profile gauge is used to measure small changes in level, such as shifts in sidewalk cracks and the lip of driveway and crosswalk crossings.

### Station Measurements:

Distance	Design Width	Cross Slope	Running Grade
m	cm	%	%

**Figure 11-7.** Station measurements are recorded on this form that is contained within the Stroll Sheet form.

cross slope. The inclinometer is 610 mm (24 in) long, and it provides measurements over the same distance covered by the length and width of an average wheelchair, walker, crutch span, or pedestrian stance.

4. A **tape measure** is used to record:
  - Sidewalk width at each station;
  - Width and length of segments narrower than specified for the sidewalk (minimum clear width); and
  - Dimensions of features, obstacles, and protruding objects that might obstruct passage or require maintenance or repair.
5. A **profile gauge** is used to measure small changes in level, such as sidewalk cracks, and to record the shape and spacing of truncated domes (i.e., detectable warnings).

### 11.4.1 Stroll Sheet station measurements

Stations are established as reference points along the block for taking sidewalk measurements. The rolatape measures the length of the sidewalk between stations. The distance of each station is recorded on the *Station Measurements* form that is contained within the *Stroll Sheet*. Stations are established frequently to increase the number of data points and ensure a higher degree of accuracy.

The first station along each block is established 2.030 m (80 in) from the curb edge of the intersection at an area not considered part of a curb ramp (such as flares and landing). Establishing a station directly at the corner is avoided to prevent atypical measurements created by the presence of a curb ramp and to exclude the corner from the average grade measurement and calculation because the corner is generally more level than the rest of the sidewalk. Subsequent stations are established at regular intervals no greater than 50 m (164 ft) apart. The last station along a block is established approximately



# 11

# SIDEWALK ASSESSMENT

## CHAPTER

2.030 m (80 in) from the edge of the intersection at a point not considered part of a curb ramp. Stations should not be established at a point considered part of a driveway crossing; instead, the station is set up before or after the driveway crossing. This is also done to exclude the generally level section of the driveway crossing from decreasing the average grade calculation of the sidewalk. It also prevents poorly designed driveway crossings with steep cross

slopes from impacting the average cross slope calculations.

Sidewalk design width, cross slope, and running grade between stations are measured at each station and recorded in the *Station Measurements* form. Only the portions of the sidewalk that are available for travel are included in width measurements; elements such as grass planting strips should not be measured.

### 11.4.2 Stroll Sheet feature measurements

The measurements for features encountered between stations are recorded on the *Feature Measurements* form, which is part of the *Stroll Sheet*. A standard set of abbreviations is used to identify the type of feature. The distance to each feature, its dimensions, and any comments are recorded.

- The cross slopes of **driveway crossings (DC)** are measured within the best path of travel as well as adjacent to the roadway and the property line. The best path of travel is the space that has the least cross slope and is therefore the area that most people will use for walking. However, it is also important to measure the cross slope of the driveway crossing on the street side of the best path of travel. This will provide information about whether the driveway crossing has a cross slope that will be identifiable by individuals with vision impairments.

#### Feature Measurements:

Feature Distance m	Feature	Dimension	Units	Comments

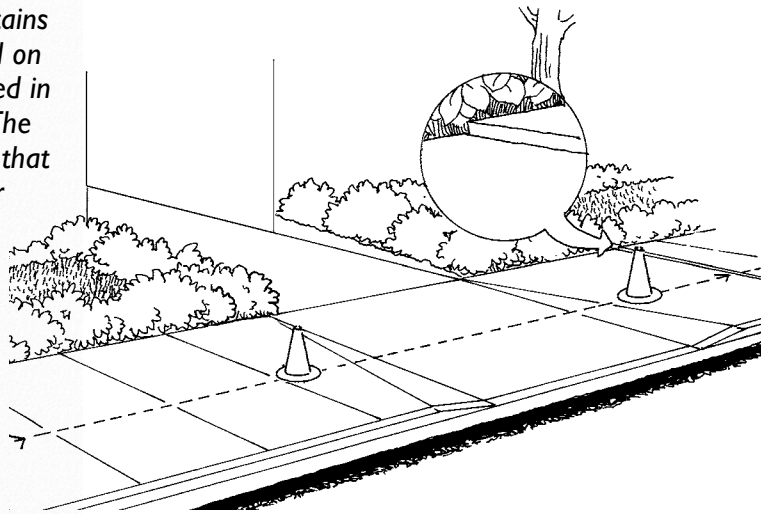
**Figure 11-8.** Feature measurements are recorded in this form which is contained within the *Stroll Sheet* form.

# 11

## SIDEWALK ASSESSMENT

### CHAPTER

**Figure 11-9.** This illustration contains two features that might be located on the sidewalk and would be recorded in the Feature Measurement Form. The first feature is a driveway crossing that creates a significant cross slope for pedestrians; both the cross slope and change of cross slope would be recorded. The second feature is a sidewalk crack which would be recorded as a change in level and would be measured using the profile gauge.



In addition, if the driveway crossing leads into a parking lot or some other open area, the cross slope should also be recorded on the property line side of the best path of travel. Gradual cross slopes at driveway crossings make it difficult for people with vision impairments to realize when they accidentally drift into the street or parking lot. However, if the cross slope at the best path of travel is greater than 2.0 percent, driveway crossings may cause people who use wheelchairs

to lose control, veer into the street, and/or tip over.

- **Maximum grades (MG)** are recorded if they exceed the running grade by more than 5 percent. The distance over which the maximum grade occurs is also recorded.
- **Maximum cross slopes (MCS)** are recorded if they exceed the station cross slope by more than 2 percent. The distance over which the maximum cross slope occurs is also recorded.
- **Changes in cross slope (CCS)** are recorded in conjunction with maximum cross slope. Changes in cross slopes are calculated by recording the measurements of cross slope 610 mm (24 in) in front of and behind the maximum cross slope. This is done at steep driveway crossings and sidewalk segments with cross slopes greater than 5 percent.

# 11

# SIDEWALK ASSESSMENT

## CHAPTER

- **Minimum clear width (MCW)** is measured with the tape measure when the clear space is narrower than 915 mm (36 in).
- **Minimum vertical clearance (MVC)** is measured with a tape measure when the vertical clear space is less than 2.030 m (80 in).
- The distance **protruding objects (PO)** intrude into the pathway is recorded if the object protrudes more than 101 mm (4 in) into the sidewalk between a height interval

are recorded anywhere a pedestrian could potentially walk because pedestrians with vision impairments often do not travel along the intended path of travel.

- **Changes in level (CL)** greater than 13 mm (0.5 in) are recorded with a profile gauge. The profile is traced from the profile gauge to paper and then measured to record the height transition and any surface beveling.

### 11.4.3 Stroll Sheet curb ramp measurements

#### Curb Ramp Measurements:

CR Distance m	Number of Ramps #	Type (L I D C B)	Approach Slope %	Ramp Slope %	Ramp Length cm	Landing Length cm	Detectable Warning y/n

**Figure 11-10.** Curb ramp measurements are recorded in this form, which is contained within the Stroll Sheet form.

of 685 mm to 2.030 m (27 in to 80 in). Protruding objects are things such as tree branches and hedges, low street and business signs, and telephones mounted on posts and walls. Protruding objects

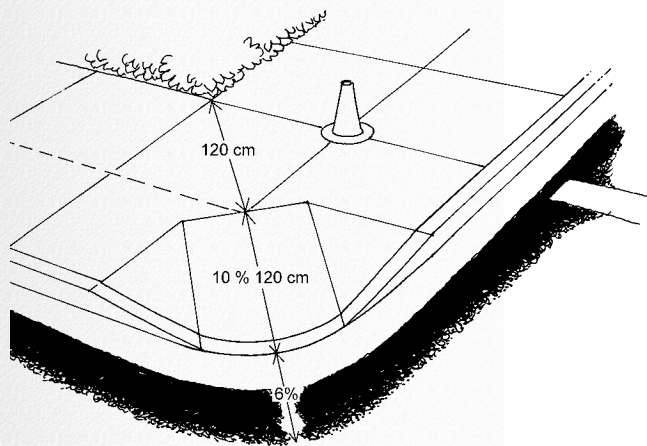
Aspects of curb ramps critical for determining whether or not a ramp is accessible are recorded on the *Curb Ramp Measurements* form, which is part of the *Stroll Sheet*. If information is recorded during the stroll that identifies a major element of a curb ramp should be replaced, the curb ramp is reevaluated using the *Curb Ramp Element Analysis* form. Both the *Stroll Sheet* and the *Element Analysis* forms capture information to

determine how the curb ramp can be retrofitted. The following curb ramp characteristics are recorded on the *Stroll Sheet* between stations:

- Distance to the curb ramp (CR);
- Number of curb ramps (0, 1, 2) at every corner. When there are no curb ramps at an intersection, a zero is recorded and no additional information is included on that line of the data form. If there are two curb ramps at the corner, each curb ramp is evaluated and two separate lines are completed on the data form;
- Type of curb ramp (parallel, perpendicular, diagonal, combination, built-up);
- Street approach slope (generally the gutter and part of the street) over a

610 mm (24 in) distance and the slope of the ramp in the upward direction;

- Ramp slope parallel to the ramp path;
- Ramp length if the ramp slope exceeds 8.3 percent.
- Landing length; and
- The presence or absence of a detectable warning as defined in ADAAG 4.29.2. Other attempts at providing tactile information on the surface are noted and identified for replacement as they provide limited benefits to people with vision impairments.



**Figure 11-11.** Some curb ramp measurements are recorded as part of the *Stroll Sheet*. More detailed measurements for curb ramps are recorded using the *Element Analysis Form*. As part of the stroll, the slope of the ramp, the slope of the roadway approach, the length of the ramp, and the length of the landing are all recorded. If the ramp slope is less than 8.3 percent, the length of the ramp should not be measured.

### 11.4.4 Intersection Checklist

The conditions at an intersection are a key factor in determining how usable the pedestrian network is for people with disabilities. If renovations are planned for

# 11

# SIDEWALK ASSESSMENT

## CHAPTER

### Intersection Checklist:

Name of primary street:	
Name of cross street:	
Total number of lanes on primary street:	
Total distance across primary street (measure with rolatape):	
Total number of lanes on cross street:	
Total distance across street (measure with rolatape):	
Are there any left turn only lanes?	yes--no
Are there any right turn only lanes?	yes--no
Is a right turn on red permitted?	yes--no
Is there a right turn island?	yes--no
Is parking permitted on the primary street?	yes--no
Is parking permitted on the cross street?	yes--no
How many corners have curb extensions (bulbouts)?	
Is there a median?	yes--no
If so, is it designed as a pedestrian refuge?	yes--no
Is it identifiable to people with vision impairments?	yes--no
Is it accessible to people with mobility impairments?	yes--no
Does the intersection have four way stop signs?	yes--no
Does the intersection have two way stop signs?	yes--no
Is the intersection signalized?	yes--no
Is there a pedestrian actuated control signal?	yes--no
Location of control:	
Information emitted: audible    vibrotactile    infrared	
Is there a high contrast between the button and post color?	yes--no
Is there a tactile arrow indicating the street crossing direction?	yes--no
Height of control:	
Dimension of pedestrian button?	
Is 5 lbs of force or less required to operate the signal?	yes--no
Is the crosswalk marked?	yes--no
If so, what are the conditions of the markings?	
Duration of WALK interval:	
Comments:	

**Figure 11-12.** The Intersection Checklist allows an assessment team to quickly evaluate an intersection based on the availability of accessible information and the probability of a safe crossing for people with disabilities.

an intersection, engineers should use the *Intersection Checklist* that is available as part of the SWAP to identify areas that need improvement. The *Intersection Checklist* consists of a brief series of questions that focus on the availability of information to assist in safe crossings. Most of the questions on the checklist are recorded as “yes” or “no” to allow the assessment team to quickly evaluate the intersection. Evaluators are also encouraged to sketch a map of the intersection at the bottom of the checklist to facilitate future evaluations of the same site.

The primary street is defined on the checklist as the street from which the assessment team approached the intersection; the cross street is defined as the street perpendicular to the primary street. The total number of lanes and the crossing distance are recorded for both the primary street and the cross street. The presence of traffic

signals, stop signs, parked cars, medians, and marked crosswalks are recorded to gain a better understanding of how difficult the intersection would be to cross for people with slower walking speeds. The length of the walk interval is also recorded if a pedestrian signal is located at the corner. The accessibility of pedestrian actuated control signals and the patterns of right and left turning automobiles are recorded to evaluate the information available to people with vision impairments. The sound of automobile traffic is another important cue used by people with vision impairments at intersections; however, the presence of traffic is not recorded because it often fluctuates based on a variety of factors including the time of day and the weather conditions at the intersection. Additional intersection observations should be recorded as comments at the bottom of the checklist. Signal types, timing, and crosswalk configuration all affect usability of a pedestrian route. TEA-21 requires consideration of accessible (audible and vibrotactile) pedestrian signals.

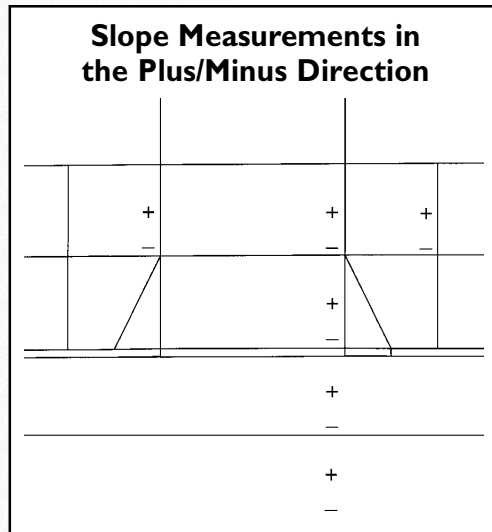


# 11

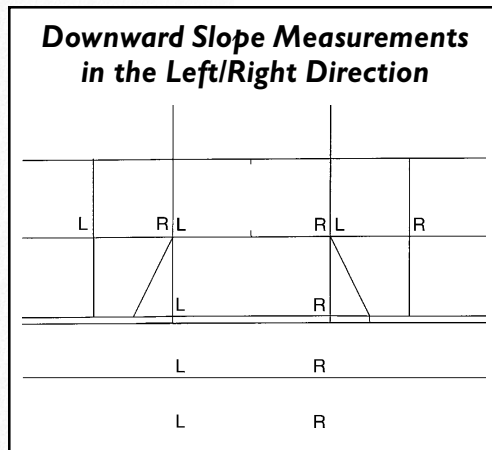
# SIDEWALK ASSESSMENT

## CHAPTER

**Figure 11-13.** Segment of the Element Analysis Form for driveway crossings used to measure slope in the plus/minus direction (see Appendix A).



**Figure 11-14.** Segment of the Element Analysis Form for driveway crossings used to measure slope in the left/right direction (see Appendix A).



### 11.4.5 Sidewalk Element Analysis Forms

*Sidewalk Element Analysis* Forms are used to record information about complex sidewalk elements, such as medians and curb ramps, that are identified by the *Stroll Sheet* measurements as warranting further evaluation. Depending on the element being evaluated, dimensions are recorded on forms depicting schematic diagrams of:

- Curb ramps;
- Driveway crossings;
- Medians; and
- Islands.

A complete set of Sidewalk Element Analysis forms is included in Appendix A. The following example reviews the Driveway Crossing Sidewalk Element Analysis form. To completely analyze a driveway crossing, each of the following measurements are recorded. Some of the measurements explained below may not be applicable to every complex element. Furthermore, some additional measurements that are not applicable to driveway crossings may be recorded for some of the other complex elements. For example, the location of a detectable warning would be recorded for a curb ramp but is not recorded for driveway crossings.

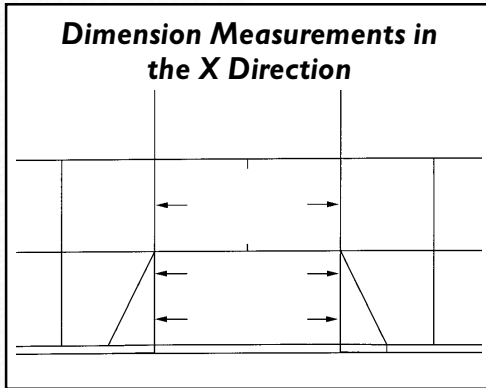
- **Slope measurements parallel to ramp path** — The slope parallel to the driveway ramp path is recorded with an inclinometer for the street, gutter, ramp, landing, and approaches. The surface is considered to have a positive slope when it slopes up from the street. (These measurements are recorded

# 11

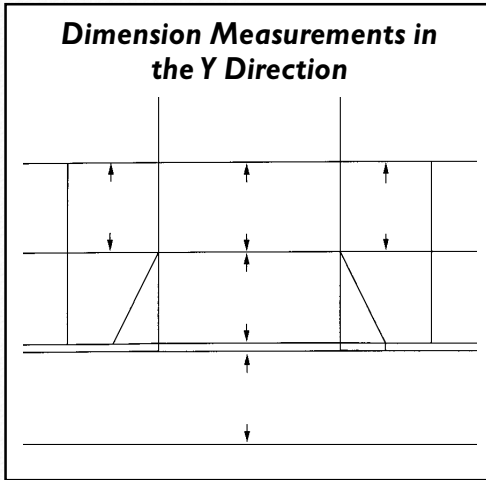
# SIDEWALK ASSESSMENT

## CHAPTER

**Figure 11-15.**  
Segment of the  
Element Analysis  
Form for driveway  
crossings used to  
measure dimension  
in the X direction  
(see Appendix A).



**Figure 11-16.**  
Segment of the  
Element Analysis  
Form for driveway  
crossings used to  
measure dimension  
in the Y direction  
(see Appendix A).



on the Slope  
Measurements in the  
Plus/Minus Direction  
segment.)

- **Slope measurements perpendicular to ramp path** — the slope perpendicular to the driveway ramp path is recorded with an inclinometer for the street, gutter, ramp, landing, and approaches. The measurements are taken facing the driveway from the street, and slope direction is recorded as left or right to correspond with the surface sloping down to the left or down to the right. (These measurements are recorded in the Downward Slope Measurements in the Left/Right Direction segment.)

- **Dimension measurements in the X direction** — The dimensions of the top of the driveway ramp, bottom of the driveway ramp, and landing are recorded with a tape measure. The “X” direction is typically measured as the width with respect to a person facing the driveway.
- **Dimension measurements in the Y direction** — Dimensions of the gutter, driveway ramp, landing, and approach parallel to the ramp length are recorded with a tape measure. The “Y” direction is typically measured as the length with respect to a person facing the driveway.
- **Height of transition points** — The transition points between street and gutter, gutter and ramp, ramp and landing, and landing and approaches are measured with a profile gauge. The transition is quickly traced from the edge of the profile gauge onto the back of the data form.

# 11

## SIDEWALK ASSESSMENT

### CHAPTER



**Figure 11-17.** The curb ramp slope is being measured for positive slope with a digital inclinometer.

- **Flare slopes** — The flare slope is measured along the steepest part of the flare and parallel to the sidewalk path of travel.
- **Change of cross slope** — When the slope of the driveway crossing exceeds 5 percent and a level landing is not provided, or the width of the level landing is less than 915 mm (36 in), users will be forced to travel over a significant cross slope. Furthermore, as the user transitions from the level sidewalk to the cross slope, they will encounter a rapid change in cross slope. The change in cross slope is measured at the flare when the landing is less than 915 mm (36 in) wide and the cross slope exceeds 5 percent. Change in cross slope is measured with an inclinometer by recording the cross slope 610 mm (24 in) in front of and behind the maximum cross slope.
- **Curb height** — The height of the curb is measured with a tape measure.

### 11.5 Presentation of sidewalk assessment information

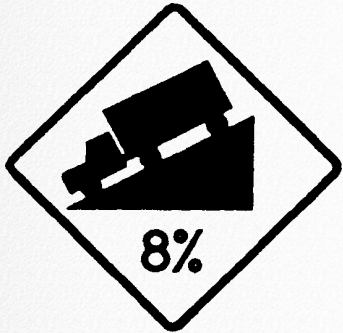
The SWAP is a tool that produces valuable data and may assist designers and planners to make targeted access improvements to bring their communities into compliance with the ADA. Sidewalk assessment data can also be used to create useful information for pedestrians. The following ideas are based on Universal Trail Assessment Process products, such as the Trail Access Information strip, and have not yet been developed for sidewalks. Additional information about Universal Trail Assessment Products is contained in Section 12.5. The following information formats should be considered for future development because they would benefit many sidewalk users:

- **Geographic Information Systems (GIS) maps** — Maps that integrate sidewalk assessment data into existing GIS systems. GIS maps could serve as a valuable planning tool for evaluating accessibility

# 11

# SIDEWALK ASSESSMENT

## CHAPTER



**Figure 11-18.** Grade information that is provided to motorists would also be beneficial to pedestrians.



**Figure 11-19.** Potential sidewalk signage indicating upcoming steep grades. This sign is not currently included in the Manual on Uniform Traffic Control Devices (MUTCD).

improvements through public involvement. GIS maps could also serve transportation agencies with internal planning for the improvement of sidewalk facilities;

- **Sidewalk signage** — Signs (similar to those for motorists) directed at pedestrians to communicate audible and visual information of sidewalk construction and closures providing alternative routes;
- **Universally designed street maps** — Street maps that integrate grade information into standard maps to improve route planning for people with disabilities;
- **District accessibility directory** — A directory sign similar to those found in shopping malls containing a top view map of the district highlighting potential barriers and identifying commercial services. Information that is

**Main Street** ↑  
**300bk**  
**East**      **1200 ft**

---

Skateboards    Bikes

---

**Grade**  
**Average 2%**  
 200 ft is over 5%

---

**Cross Slope**  
**Average 3%**  
 Max. 11% for 15 ft  
 30 ft is over 5%

---

**Path Width**  
**Minimum 45"**  
 Average 60"

---

**2" Change in level**

---

WARNING: Conditions may have changed since this sidewalk was assessed. Temporary barriers were not mapped.

---

**A** Sidewalk Access Information

**Figure 11-20.** This type of sign has been used in trail settings. Pedestrians could benefit from objective information about sidewalk conditions, such as steep grades and cross slopes.

# 11

# SIDEWALK ASSESSMENT

## CHAPTER

**Figure 11-21.** Street maps that include grade information would improve route planning for people with mobility impairments.



provided in text format should also be provided in an audible format;

- **Computer kiosks** — Information on the accessibility of specific routes could be integrated into existing computer kiosks that are currently installed in many locations such as transit stations. Standards for making kiosks accessible to people with vision impairments are available from the U.S. Access Board; and
- **Website** — A site where Internet users could obtain accessibility information about a given municipality. Websites should be designed to accommodate speech access.





# Trail Development

- Chapter 12: Trail Planning
- Chapter 13: Universal Trail Assessment Process
- Chapter 14: Shared-Use Path Design
- Chapter 15: Recreation Trail Design
- Chapter 16: Trail Crossings
- Chapter 17: Specialized Trails
- Chapter 18: Trail Maintenance
- Chapter 19: Research Recommendations



# 12

# TRAIL PLANNING

## CHAPTER

## Trail Planning



**Figure 12-1.** The needs of a broad range of trail users should be addressed during the planning stages of trail projects.

Trails provide a wide variety of transportation and recreational experiences, ranging from a casual afternoon stroll in the local park, to a daily commute to work, to a demanding wilderness expedition. People with and without disabilities should have access to the full range of transportation and recreational experiences provided by trails. Therefore, the design of a new trail or trail network, as well as the alteration

network, must always include provisions for accessibility.

The recommendations provided within the Trail Development chapters are intended to promote the accessibility of trails for all potential trail users. Trails that are developed in accordance with these recommendations will provide access to a large proportion of the population. However, since every individual has unique abilities and interests, there is no one specific trail design that will meet every user's desired experiences. Providing signage with objective information about the actual, on-trail conditions can help ensure that each user will be aware of existing trail conditions before they find themselves in frustrating or potentially hazardous situations.

# 12

# TRAIL PLANNING

## CHAPTER

### Case Study 12-1

Built on the historic trail to Herring Cove in Sitka, Alaska, Whale Park provides access to the attractions of the community. Its accessible design has directly increased the number of visitors, length of their stay, and is an economic benefit for the community.

## 12.1 Commitment to universal design

For user safety and satisfaction, the skills and abilities required to negotiate a trail must match the user's interests and expectations. All trail users, both with and without disabilities, tend to select experiences that suit their interests and abilities. Factors that influence the match between an individual and a particular trail include:

- The desired trail experience;
- The individual's abilities, skills, and expertise;
- The availability of equipment or assistive technology needed to use the trail;
- The availability of additional expertise such as guides; and
- Whether the individual will be alone or with companions.

Many trail users seek experiences that are beyond the capabilities of most people.

There are trails within existing trail systems that provide more than a significant challenge to such users. The challenge is to design trails that provide a unique experience without unique challenges.

The ability to plan, design, construct, and maintain trail experiences that match user needs for access is based on a strong commitment to integrate universal design strategies into every aspect of the trail development process. Focusing on only one aspect, such as the trail tread, is not sufficient. Every aspect of the trail experience must be considered, including the trail corridor, trailhead, and built facilities or amenities.

When planning trails, land management agencies should strive to create environments and experiences that are inclusive of people with and without disabilities. In some instances, this may require looking at the trail from another person's perspective. Designers should consider whether they would be able to enjoy the trail and benefit from all aspects of the trail experience if they were:



# 12

# TRAIL PLANNING

## CHAPTER

- Unable to hear;
- Using crutches;
- Unable to see;
- Using a wheelchair for mobility;
- Using a powered scooter for mobility;
- 90 years old;
- Lacking in energy;
- Not physically fit;
- 8 years old;
- Unable to concentrate; or
- Unable to read or not able to read the local language.

For newly constructed trails, the commitment to address accessibility issues should begin during the planning stages of the trail development process. For example, if sufficient right-of-way is not allocated to a trail during the initial

stages of development, it is harder for designers to construct a trail that is safe for users traveling at different speeds. When access improvements are made to existing trails, designers should prioritize resources and try to make the most significant changes possible with the resources that are available.

### 12.2 Key players in trail design

Trails are designed, built, and managed by a variety of entities. There are trails managed by Federal, State, or local agencies and organizations that may be government, nonprofit, or private. Trail planners and designers should be aware of regulations or guidelines that impact trail design. It is imperative that all involved in the trail project are knowledgeable of the design criteria that will provide access to all people.

### 12.3 Types of trails

There are many types of trails and each provides different experiences for

# 12

# TRAIL PLANNING

## CHAPTER

different users. Trails may lead along a mountain ridge, coastline, metropolitan district, or along a historic route that crosses several States. Trails may be used for a variety of reasons including exercise, transportation, recreation, or education. Trail users may include hikers, cyclists, skaters, equestrians, or pedestrians. Trails that are designed to provide a transportation function while supporting multiple users are called shared-use paths. Trails that are designed primarily for a recreational experience are recreation trails. Designing trails to meet the various needs of all user groups and types of experiences desired is a challenge but can be achieved with planning.

In this document, the term trails includes both shared-use paths and recreation trails. For the most part, the information presented will apply to both types of trails. If information is specific to either shared-use paths or recreation trails, the text will identify the specific application. For example, Chapter 14 contains design recommendations that are specific to shared-use paths.

## 12.4 Long-range planning

The use of a trail is a matter of individual choice. Some individuals, with or without disabilities, will choose not to use any type of trail, regardless of its design. Other individuals will choose to use a variety of trails. Shared-use path or recreation trail use means that the individual has made a choice to leave the roads and sidewalks behind.

### 12.4.1 Trails versus the built environment

Traditionally, much of the focus on trails for people with disabilities has been on building or providing an accessible trail with “accessibility” defined in terms of the Americans with Disabilities Act Accessibility Guidelines (ADAAG) for access routes in the built environment. Accessibility recommendations specific to pedestrian use trails are only now being developed.

The direct application to trails of the ADAAG provisions for access routes is inappropriate in most environments.

# 12

## TRAIL PLANNING

### CHAPTER

Often, a primary goal in choosing to use a trail is the opportunity to experience a different, and usually more natural or less developed environment. Even a highly developed shared-use path in an urban area presents a “less developed” environment in that the presence of motorized vehicles is limited. Limiting the development of trails only to those that can fully comply with ADAAG regulations for built environments is neither feasible for the range of conditions found in the natural environment, nor desirable in terms of the broad spectrum of interests and desires among trail users.

#### **12.4.2 Developing accessibility standards for trails**

The U.S. Access Board recognizes that the planning, design, construction, and maintenance of outdoor, natural environments differ considerably from that appropriate to the indoor, built environment. Since passage of the ADA, the U.S. Access Board, which is responsible for developing accessibility

guidelines, has been moving in the direction of providing specific accessibility guidelines for outdoor facilities. Ultimately, the construction or alteration of outdoor recreation facilities will be governed by specific regulations designed to maximize accessibility in outdoor environments. In the interim, planners are encouraged to become knowledgeable about the proposed regulations and to use the proposed design standards to maximize the accessibility of the trails and facilities that they create.

Initially, the U.S. Access Board’s report, *Recommendations of Accessibility Guidelines: Recreational Facilities and Outdoor Developed Areas* for trails was issued as part of an Advanced Notice of Proposed Rulemaking and made available for public comment (U.S. Access Board, 1994). Due to a lack of consensus in the feedback received, the U.S. Access Board created a Regulatory Negotiation Committee on Accessibility Guidelines for Outdoor Developed Areas to address this issue in more detail. This committee represented various interest groups

# 12

# TRAIL PLANNING

## CHAPTER

that would be affected by the guidelines including people with disabilities; facility owners and operators; Federal, State, and local land management agencies; designers, and trails groups. The committee began its work in 1997 and met for two years. Their conclusions were published in a report that will be used by the U.S. Access Board to develop a proposed rule for the ADA Accessibility Guidelines that will be published for public comment.

A summary of the committee's work and information on the status of regulations for accessibility in outdoor areas is available through the U.S. Access Board. The proposed guidelines provide design standards for the construction of new facilities and the alteration of existing facilities. They also identify trail maintenance activities that should be used to incorporate accessibility whenever possible but will not trigger a legal requirement for accessibility modifications. As such, a thorough knowledge of the proposed guidelines and the status of their implementation is essential to the effective design of trails, both now and in the future.

### 12.4.3 New construction

The needs of people with disabilities should be considered in every aspect of trail design, development, and maintenance. Expanding trail access for people with disabilities also provides a wider variety of opportunities for all users. Although this is true for all types of trail construction alterations and some maintenance activities, it is particularly important during new construction. In new construction, the opportunity to optimize trail access is maximized because there are no, or very few, pre-existing constraints due to existing facilities.

Trail managers should adhere to the following design principles when planning, designing, and maintaining their facilities:

- Incorporate and address accessibility concerns in all planning, design, construction, and maintenance activities;
- Provide facilities and trails that are accessible in highly developed areas;

# 12

## TRAIL PLANNING

### CHAPTER

- Ensure that accessible designs are always used for recreation amenities. For example, fire grills should be designed with sufficient clear space for wheelchair users;
- Ensure that access routes are provided that connect facilities such as restrooms and parking;
- Actively seek opportunities to enhance the accessibility of existing trails and facilities through alterations and maintenance activities; and
- Ensure that construction/reconstruction of a portion of a trail incorporates accessible design criteria whenever feasible.

#### 12.4.4 Alterations

Activities that change the original purpose, usability, intent, or design of the trail or fundamentally alter the experience or amenities are considered an alteration

rather than maintenance. In these situations, the trail should be designed to incorporate accessibility to the greatest extent feasible.

Developing trails that provide access to people with disabilities should also be a priority for all work on existing trails and in areas with multiple trails. It is recommended that when an existing trail is altered or reconstructed, design and construction should follow the recommendations for accessible trails and new construction contained in Chapters 14 and 15. The Regulatory Negotiation Committee on Accessibility Guidelines for Outdoor Developed Areas identified the following examples as actions that would be considered alterations or reconstruction:

- Installation of a new trail tread surface;
- Creating new elements, such as bridges, boardwalks, railings or safety barriers, signage, and/or puncheons;



# 12

# TRAIL PLANNING

## CHAPTER

- Construction on or reconstruction of a new trail;
- Remodeling or reconstruction of built features, such as restrooms, picnic areas, gates, benches, and/or steps;
- Installing hardening materials on a trail surface; and
- Rerouting or widening a significant portion of an existing trail (U.S. Access Board, 1999b).

Incorporating accessible features during alterations may be a lower priority when:

- There are specific conditions, such as a designated historic property, that allow for some departures from the recommendations (see Section 12.5.1);
- Work to be done on the trail is limited to routine or periodic maintenance, such as erosion control, and the incorporation

of accessible design features would require alteration or reconstruction of the trail; and

- The section of trail to be altered is not connected to a trailhead or accessible trail, and it is very unlikely that those connecting sections of the trail will be reconstructed in the future. Such a trail segment would effectively be “in the middle of nowhere,” and the effort and resources used in making such a remote segment accessible would be much more effectively spent in areas where there is a reasonable expectation of increasing the overall trail access.

### 12.4.5 Routine maintenance

Routine maintenance that is designed to return the trail to its previous condition does not require the full implementation of accessible trail designs. However, maintenance and repair activities should be carefully considered to identify those activities that have a potential for

enhancing accessibility. For example, if a crew is clearing the vegetative growth from a trail, the opportunity to clear the trail to provide a 915 mm (36 in) clear tread width should be considered.

Maintenance and repair activities include:

- Removing debris or vegetation, such as downed trees or broken branches on the trail, clearing the trail of encroaching brush or grasses, and removing rock slides;
- Maintaining the trail tread, such as filling of ruts and entrenchments, reshaping the trail bed, repairing the trail surface and washouts, installing rip rap, and constructing retaining walls or cribbing to support the tread;
- Erosion control and drainage, replacing or installing necessary drainage structures (e.g., drainage dips, water bars, or culverts), and realigning sections of trail to deter erosion or avoid boggy or marshy areas;

- Repairing the structures on the trail, such as replacing deteriorated, damaged, or vandalized parts of bridges, boardwalks, fencing or railings, painting existing structures, and removing graffiti and anything that affects the usability of the trail.

#### 12.4.6 Long-range planning for multiple trail systems

Land managers responsible for large networks of trails should consider the overall reason(s) for the site's existence and the programmatic nature of the site when planning the trail opportunities that will be provided. Does the site have historical, cultural, or natural features? Does it offer multiple opportunities to experience diverse environments such as rainforests, mountains, or deserts? If so, is there an accessible trail opportunity for each of these key features or programs?

Priority should be given to making access improvements on trails or trail segments to areas such as:

- Prominent or outstanding features;

# 12

# TRAIL PLANNING

## CHAPTER

- Popular or higher usage areas;
- Shorter, day-use trails and trails designed for inexperienced or unskilled trail users; and
- Trails that represent the range of trail experiences available at the site.

As part of their transition plan, land managers should document the range of trail experiences provided and the conditions of the trails that provide those experiences. At a minimum, trail planners should provide one trail that meets all of the recommendations to provide access for people with disabilities for each type of experience within the site. For example, consider a site that has:

- One trail that leads to the bottom of a river valley, providing access to the river for fishing;
- Another trail that loops away from the river through a variety of forest ecosystems; and

- A third trail that climbs to an open ridge overlooking the entire valley.

If the trail along the river and the trail to the open ridge already provide access to people with disabilities, priority should be given to enhancing access on the trail through the forest ecosystems. In this way, each type of trail experience can be made available. If the accessibility on all of the trails is very limited, priority should be given to the trail with the highest use or that leads to a significant feature. In this situation, ensuring that accessible trails were provided for all three opportunities should be the priority over the creation of any new trails that would have limited or no accessible elements.

### **12.5 Providing access and preserving the environment**

People, with and without disabilities, use trails for a wide variety of reasons. One of the most common reasons is the opportunity to enjoy the outdoors. Enhancing access to a wide variety of

# 12

## TRAIL PLANNING

### CHAPTER

outdoor environments enables all individuals to have the same opportunity to enjoy the benefits that they provide. However, it is equally important to protect the outdoor environment and the experience it provides. In most situations, designing a trail that provides greater access for people with disabilities can be achieved without any or only minimal additional impact on the natural resources beyond that which results from the presence of any trail. The recommendations presented in this section are intended to give guidance regarding trail planning for those relatively unusual situations when designing an accessible trail may have a negative impact on the preservation or protection of the outdoor environment.

When trail designers encounter any of these situations, it is very important that people with disabilities be included in the planning process (Section 3.8). Solutions will be easier to reach if people with disabilities are part of the planning process. The meaningful involvement of people with disabilities in the planning process requires that their feedback be

sought as early as possible (i.e., as soon as the potential limitation is recognized) and as often as necessary (i.e., at each step of the planning process).

### **12.5.1 Potential conflicts between access and preservation**

Outdoor environments vary tremendously in terms of their need for preservation or protection. A green space in the center of a large city is unlikely to represent a truly “natural” (i.e., unaltered by development) environment. Yesterday’s parking lot may be tomorrow’s city park. In these situations, creating trails that provide access to people with disabilities is rarely difficult. For example, if heavy equipment is used to create a paved trail there is virtually no difference in the environmental impact that will result from a 1.220 m (48 in) or 1.525 m (60 in) width. However unlike the 1.220 m (48 in) width, the 1.525 m (60 in) width provides a trail where two individuals using assistive devices can easily pass one another.

In contrast to highly developed urban environments, the creation of any type of

# 12

# TRAIL PLANNING

## CHAPTER

trail can have a significant impact on the preservation of federally designated Wilderness Areas. Highly urban areas and designated Wilderness Areas represent the extremes on a continuum of outdoor environments. While decisions regarding trail design and development are usually quite clear within these extreme environments, the most appropriate way to balance concerns about accessibility and protection is often more ambiguous. Some of the conditions that are found in outdoor environments that make it difficult to build accessible trails are:

- The presence of cultural, historic, religious, or significant natural features or characteristics (Section 12.5.1.1);
- The nature of the setting or purpose of the trail (Section 12.5.1.2);
- Limitations or prohibitions in land ownership or use agreements, or Federal, State, or local regulations or statutes (Section 12.5.1.3); and

- Terrain conditions or prevailing construction practices (Section 12.5.1.4).

Any of these conditions may or may not impact the ability to develop a specific trail within a particular environment. Therefore, the impact of each of these factors must be considered in terms of the site being developed. Most trails pass through a variety of environments from the trailhead to the destination. The ability to provide an accessible trail should be evaluated separately for each trail section or environment.

### ***12.5.1.1 Cultural, historic, religious, or significant natural features***

Preserving our heritage is a high priority for all individuals. Therefore, it is important that the trail planning process consider the potential impact of the trail on cultural, historic, religious, or significant natural features or characteristics of the trail environment. In most situations, it is inappropriate to develop a trail in such a



# 12

## TRAIL PLANNING

### CHAPTER

way that the natural, cultural, historic, or religious heritage of the environment may be threatened or destroyed.

For example, a trail is being designed to enable visitors to experience an important archeological site. The most valued features within the site are located away from the site entrance and therefore cannot be accessed from a trail that leads only to the edge of the site. Therefore, the trail through the site may have to be narrower than 815 mm (32 in) in areas where the archeological features are located close together.

Another example would be the use of an unused, historic bridge for a shared-use path. If the bridge was originally designed with a high center arch to allow the free passage of boats underneath, the grade in the center arch may exceed accessibility recommendations. The historic designation of the bridge does not allow the center arch to be rebuilt, so the grade of the shared-use path will have to exceed the recommendations for an accessible trail.

Significant cultural features can include archaeological sites, sacred lands,

burial grounds and cemeteries, or Indian tribal protected sites. Significant historical features include properties such as those on or eligible for the National Register of Historic Places or other places of recognized historic value. Significant religious features can include Indian sacred sites and other properties designated or held sacred by an organized religion or church.

Significant natural features include areas such as those protected under Federal or State laws, areas with threatened or endangered species, or designated wetlands that could be threatened or destroyed. It also includes natural habitat or vegetation areas, as well as specific natural features that are particularly important to the heritage of the environment or area, such as a very high waterfall.

#### **12.5.1.2 Nature of the setting or purpose of the trail**

Nature of the setting refers to the type of experience and environment that can be accessed from the trail. For example, if a trail is planned to provide a rustic, back

# 12

## TRAIL PLANNING

### CHAPTER

country experience, the development of a 4.57 m (15 ft) wide, paved shared-use path would not be compatible with the intended experience.

The purpose of the trail is similar to the nature of the setting but refers primarily to the intended use and/or user groups for the trail. For example, if the desire is to create a recreational trail for off-highway vehicle users, it would be inappropriate to provide a firm and stable surface, with less than a 5 percent running grade and obstacles less than 51 mm (2 in) in height.

Understanding the nature of the setting and the intended purpose of the trail is one of the first steps in the trail planning process. Equal consideration must be given to how the setting and purpose of the trail can be provided to all potential trail users. It is not appropriate to make decisions regarding the setting or purpose of the trail without considering the impact of those decisions on trail users with different abilities. Consideration of the needs of all potential trail users throughout the trail planning process is

the most effective way to ensure that all potential trail users can enjoy a range of trail experiences.

### ***12.5.1.3 Federal, State, or local regulations or statutes***

It may appear self-evident that trails are required to comply with legal restrictions affecting the trail and its environment. However, in terms of trail accessibility and the right of people with disabilities to have equal access to trail opportunities under the ADA, there is often some confusion over which laws take precedence. In some instances restrictions to protect or address environmental concerns imposed by Federal, State, or local statutes may require departure from one or more of the components of accessible design. For example, it may not be possible to create a firm and stable surface if a local conservation easement program prohibits the use of imported surfaces. However, local regulations or statutes should never be developed with the sole intention of preventing access by

# 12

# TRAIL PLANNING

## CHAPTER

people with disabilities. For example, it would be unacceptable to initiate a new regulation that “arbitrarily restricts trail width to a dimension that would not allow passage of wheelchairs or other mobility devices” (U.S. Access Board, 1999b).

Potential legal restrictions for land use within the trail corridor should be identified during the earliest stages of the planning process. Early recognition of potential conflicts between various regulations enables designers to consider alternative trail locations or innovative design solutions so that an accessible trail can be created. In general, most regulations or statutes on land or trail use or construction will not affect the ability to provide trails that are accessible to people with disabilities. However, in cases where there are specific legal restrictions that impact designing an accessible trail, efforts should be made to provide access to people with disabilities where feasible.



**Figure 12-2.** Trails in designated wilderness areas must be maintained and improved without using powered tools.

### 12.5.1.3.1 The Wilderness Act

In 1964, Congress passed the Wilderness Act to ensure the protection

of federally owned lands that would remain undeveloped, and preserve natural conditions that could be used for the benefit of present and future generations. Such wilderness lands were identified by Congress and designated the National Wilderness Preservation System (NWPS). The Wilderness Act does not apply to non-Federal lands.

The effect of the Wilderness Act on accessibility is often misunderstood. As described more fully in Section 1.3.3 of Part I of this guideline, when taken together with Section 507(c) of the ADA, the Wilderness Act permits wheelchairs or scooters suitable for indoor use to enter wilderness areas while it prohibits the use of motorcycles, all-terrain vehicles, off-highway vehicles, and other vehicles with internal combustion engines. In addition, under these laws, land management agencies are not required to construct facilities, such as toilets, to facilitate use by persons with disabilities, but they are encouraged to use accessible designs when modifications (such as the addition of toilets) are made.

# 12

## TRAIL PLANNING

### CHAPTER

The accessibility of a trail for all potential users should always be considered during the planning, design, and construction stages for trails within a wilderness area. Consideration of trail accessibility throughout the development process will provide the greatest opportunity to ensure that people with disabilities have access to wilderness experiences. However, since the ability to develop a fully accessible trail may be limited in wilderness areas, providing accurate information at the trailhead about existing trail conditions is crucial.

#### ***12.5.1.4 Terrain, conditions, or prevailing construction practices***

The terrain in some environments will limit the ability of trail designers to develop a trail that is accessible to some people with disabilities. For example, reducing running slope in areas of steep terrain may require extensive cuts or fills that would be difficult to construct and maintain, or cause drainage or erosion problems. Also, in order to construct a

trail on some steep slopes, the trail may become significantly longer causing a much greater impact on the environment. Another potential condition is that certain soils are highly susceptible to erosion. Other soils expand and contract along with water content. If compliance requires techniques that conflict with the natural drainage or existing soil, the trail would be difficult, if not impossible, to maintain. While trail designers and land managers should strive to maximize all opportunities for enhancing trail access, they are not expected to implement designs that are not reasonable.

This condition may also apply where construction methods for particularly difficult terrain or for an obstacle that would require the use of equipment other than that typically used throughout the length of the trail. Trail construction practices vary greatly, from the use of volunteer labor with hand tools to professional construction with heavy, mechanized equipment. The responsibility for enhancing trail accessibility does not require the use of construction practices

# 12

## TRAIL PLANNING

### CHAPTER

that may be above and beyond what is commonly used. For alterations to an existing trail, the prevailing construction practices are defined as the methods typically used for construction or maintenance of the trail. The intent of this conditional departure is to ensure that compliance with the technical provisions does not require the use of construction practices that are above and beyond the skills and resources of the trail building organization. It is not intended to automatically exempt organizations from the technical provisions simply because of a particular construction practice (e.g. the use of hand tools) or to suggest that these practices should be used to avoid compliance when more expedient methods and resources are available. In new construction, trail designers should consider the trail construction practices when they plan and design the trail route. By knowing the construction and maintenance practices that will be employed, trail designers can ensure that the selected route will be suitable for the creation of an accessible trail using these practices.

The intent of this conditional departure is to recognize that the effort and resources required to comply would not be disproportionately high relative to the level of access created. Although technically feasible to achieve these efforts, the effort and resources required are not reasonable.

#### **12.5.2 Priorities for access to extreme environments**

There are two extreme conditions where the development of an accessible trail is not recommended or should have the lowest priority. These conditions occur most frequently on recreation trails rather than shared-use paths. These extreme conditions are only considered to exclude the possibility of an accessible trail when there is no alternative option (e.g., reroute trail, use different construction practices, or allow different trail users) that could be used to avoid such extreme conditions. The two extreme conditions are:

- Where one section of the trail has such extreme conditions that access



# 12

## TRAIL PLANNING

### CHAPTER

beyond the restriction would be severely limited; and

- Where more than 15 percent of the total trail length cannot be built as an accessible trail.

When either of these conditions occurs, the trail beyond the first point that is not accessible does not need to be of an accessible design. Although making the remainder of the trail accessible is a low priority, trail designers are strongly encouraged to continue to provide design characteristics throughout the trail that enhance trail accessibility and can be readily incorporated into the trail. For example, a trail through an open meadow could easily be built with a 915 mm (36 in) minimum clear width.

The trail segment from each trailhead to the first inaccessible point should be accessible. The lack of an accessible trail design from the trailhead should only be a low priority when that segment is less than 152.4 m (500 ft) in length and does not lead to a destination or prominent feature.

For loop trails or trails with multiple trailheads, the trail should be accessible from each trailhead to the first inaccessible section of trail in each direction of travel.

#### **12.5.2.1 Single extreme condition limits access**

When there are single features or conditions that are extremely difficult, it is not essential to design the sections of trail beyond the extreme conditions with accessible features. The allocation of resources to the creation of an accessible trail beyond these extreme conditions is considered to be a low priority. This exception is based on two factors:

- If an individual has the capability to negotiate such extreme conditions, they are unlikely to require the benefits of a trail that is designed to be accessible over the balance of the trail; and
- The resources required to create an accessible trail beyond the extreme conditions would be better

# 12

## TRAIL PLANNING

### CHAPTER

spent in other areas where a higher proportion of people with varying abilities would benefit.

The Regulatory Negotiation Committee for Outdoor Developed Areas (U.S. Access Board, 1999b) identified four extreme features or conditions that, if they cannot be avoided, may trigger the provision for a low priority for the design of an accessible trail. The extreme conditions are:

- A segment of trail where the total of the grade and cross slope measurements exceeds 40 percent for 6.10 m (20 ft) or more;
- An obstacle 760 mm (30 in) in height or higher that extends across the full tread width;
- A section of soft or unstable surface which continues for 13.72 m (45 ft) or more; and
- A tread width that is less than 305 mm (12 in) for 7.62 m (25 ft) or more.

For example, 305 m (1000 ft) from the trailhead, a trail leads diagonally up a steep slope. The best possible alignment of the trail tread results in a section of trail that has a grade of 25 percent and a cross slope of 20 percent and these conditions continue for a distance of 15.25 m (50 ft). Since the total grade and cross slope exceeds 40 percent (25 percent plus 20 percent equals 45 percent) and the length of the section exceeds 6.10 m (20 ft), the trail beyond this point would be a low priority for accessible design. However, designers are encouraged to continue to provide accessible conditions wherever they can be readily achieved. In addition, the first 305 m (1000 ft) of the trail should be designed and built to provide access to people with disabilities.

A second example is a trail that goes up over a 1.525 m (60 in) high rock ledge that is located 137 m (450 ft) from the trailhead. There is no way to re-align the trail to avoid going over the ledge. Again, designing the trail to be accessible beyond the rock ledge would be a low priority, but accessible designs should be incorporated

# 12

# TRAIL PLANNING

## CHAPTER

wherever feasible. Since the ledge is located less than 152.4 m (500 ft) from the trailhead, the priority for making the first 137 m (450 ft) of the trail accessible would depend on whether there was a destination or prominent feature within that section of the trail. If there were no prominent features within the first 137 m (450 ft) of trail, the section from the trailhead to the rock ledge would also be a low priority for accessible design. In this case, the resources that would be required to make the first 137 m (450 ft) of trail accessible would be better applied to designing another trail that could provide access to a meaningful trail experience for people with disabilities. However, if there was a prominent feature or destination within the first section of the trail, such as a waterfall 76 m (250 ft) from the trailhead, the portion of the trail from the trailhead to that feature should be accessible.

### **12.5.2.2 Cumulative conditions limit access**

Each trail should be designed so that the opportunities for access are

maximized. Alternative routes, construction techniques, and permitted user groups are just a few of the factors that should be considered in order to maximize the opportunities for an accessible trail. However, after all of these options have been considered, if sections of the trail cannot be made accessible, because of the conditions described in Section 12.5.1, the length of each inaccessible section should be determined. If the total length of all of the inaccessible sections is greater than 15 percent of the total trail length, the overall trail environment is considered to be so difficult that the development of an accessible trail is considered a low priority. However, accessibility features should continue to be incorporated throughout the trail wherever it is reasonable to do so. The segment from the trailhead to the first segment of inaccessible trail should still be designed to be accessible, unless the segment is less than 152.4 m (500 ft) in length and does not provide access to a destination or prominent feature.

For example, an interpretive trail is 457 m (1500 ft) in length from the

# 12

## TRAIL PLANNING

### CHAPTER

trailhead to the destination. On the trail there are:

- Two 15.25 m (50 ft) sections of trail where the tread width is 760 mm (30 in);
- A 22.86 m (75 ft) section of the trail that has a cross slope of 10 percent;
- A 15.25 m (50 ft) section of the trail with a grade of 15 percent; and
- Obstacles which are 152 mm (6 in) in height over a 22.86 m (75 ft) section of the trail.

In this example, these conditions have occurred even though every possible alternative design was considered. Therefore, the relatively large proportion of the trail that cannot be built as accessible [91.4 m (300 ft) or 20 percent of the total trail length] makes the creation of accessible conditions on the remainder of the trail a low priority. The first section of the trail, from each trailhead to the first area that could not be made accessible

would continue to be designed as accessible. The first section(s) of trail would only be considered a low priority for an accessible design if it was less than 152.4 m (500 feet) in length and did not contain a destination or prominent feature.

### 12.6 Trail components

A variety of design features combine to create trail experiences, including:

- The trailhead;
- The trail corridor; and
- Trail elements.

Those designing and building trails should address each trail component as part of a unified system because each component is critical to the recreation experience. Considering accessibility for the entire trail system will help to avoid design and construction practices that inadvertently limit the opportunities provided.

# 12

# TRAIL PLANNING

## CHAPTER

### 12.6.1 Trail corridor

The trail corridor is defined as the entire design width and height of the trail right-of-way. It extends from the trail entrance to the destination. The key to providing access within the trail corridor is to remember that it is not defined only by the trail tread. Accessibility within the entire area on, over, or beside the trail tread must be planned with the needs of all potential users in mind.

Although many factors impact the accessibility of the trail corridor, the following characteristics are most directly related to access for people with disabilities:

- Surface;
- Grade;
- Cross slope;
- Clear tread width;
- Protruding objects; and
- Vertical clearance.

The information provided at the trailhead is an extremely important factor in trail access. Each trail user is unique and has different abilities depending on personal fitness, endurance, and the suitability of any adaptive equipment being used to access the trail. It is essential that all trail users have accurate information about the conditions that they will encounter on the trail in order to identify trails that best suit their needs.

### 12.6.2 Trail element access

The accessibility of the trail experience depends not only on the conditions encountered on the trail itself but also the accessibility and availability of trail elements. Trail elements are the facilities and features that are found along a trail, in addition to the trail itself. Examples of trail elements include:

- Trail destinations such as waterfalls, lakes, and meadows;
- Campsites with picnic tables, fire rings, and tent pads;



# 12

## TRAIL PLANNING

### CHAPTER

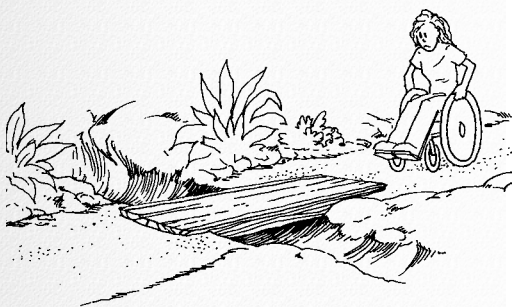
- Scenic viewpoints;
- Interpretive information displays;
- Built facilities, such as restrooms, shelters, cooking facilities, and bicycle racks; and
- Water access or supply points.

The scope and design of constructed or altered trail elements should be planned to correspond with the on-trail conditions, user needs and expectations, and the desired trail experience. The overall trail experience may be compromised if the accessibility of the trail elements does not match the accessibility provided by the trail itself. The lack of accessible elements such as camping or toilet facilities can be especially frustrating to users who have invested time and energy in reaching a particular destination. This is particularly true if the trail created the expectation of an environment that would provide access to people with disabilities.

For example, most people negotiating a paved, level trail would expect to use a

bridge, not wade through the water, in order to cross a stream. The frustration of the user who reaches this type of crossing and then has to turn back before reaching the destination impacts the enjoyment of the trail experience. If the frustration leads the individual to attempt a crossing for which he/she is unprepared, the safety of the trail user may be jeopardized.

The ADA Accessibility Guidelines Sections 1 through 9 provide design standards for numerous elements normally found in a trail environment, such as drinking fountains, restrooms, parking areas, and assembly areas that are found in the built environment. When these elements are located in an outdoor environment their design should follow the same design principles. On a highly developed, shared-use path, the elements should meet all of the ADAAG requirements for the built environment. In very rustic, undeveloped areas, every attempt should be made to, at a minimum, maintain the clear space required around the element and provide a surface that is firm and stable. It is also recognized that in outdoor



**Figure 12-3. PROBLEM:** The design of a trail crossing should be consistent with the trail leading up to it. In this illustration, a split log crossing is provided, but a bridge would be more appropriate.

# 12

## TRAIL PLANNING

### CHAPTER

environments additional ground slope may be required, depending on the terrain and surface material, to provide adequate drainage.

In addition to the standards for the built environment, design standards have been recommended to the Access Board by the Regulatory Negotiation Committee for Outdoor Developed Areas to address the following elements when they are located in outdoor recreation areas:

- Picnic tables;
- Fire rings;
- Cooking surfaces, grills, and pedestal grills;
- Trash and recycling containers;
- Wood stoves and fireplaces;
- Overlooks and viewing areas;
- Telescopes and periscopes;
- Benches;

- Utility sinks;
- Storage facilities;
- Pit toilets;
- Utilities;
- Camping facilities;
- Warming huts; and
- Outdoor rinsing showers.

In the absence of applicable regulations, the committee's recommendations provide helpful guidance for the design of outdoor facilities. For more information about the committee report, contact the U.S. Access Board (listed in Appendix C).

When designing elements that are not specifically addressed in the outdoor recreation guidelines, use the best available information for similar elements that have outdoor recreation guidelines or obtain guidelines for the element within a built environment and then adapt the design guidelines accordingly.

### 12.6.3 Trailhead access

A trailhead is any point, designated by a land management agency, at which a trail user can enter or exit from a shared-use path or a recreation trail. Designated trailheads may also include elements such as parking, restrooms, kiosks, and other built facilities. Gates, bollards, or other trail entrance designs may be used to prevent access of motorized trail users, but they should not prevent access to wheelchair users or handcycle riders. These elements should be designed so that access to the pedestrian trail is not compromised. For recreation trails, an outdoor recreation access route should connect accessible elements, such as camping areas or picnic areas, to designated trailheads.

#### 12.6.3.1 Facilities and amenities at the trailhead

It is important that designers recognize that people with disabilities enjoy all types of trails including trails that are not intended for pedestrian access.

They participate in all types of trail activities at a wide range of skill levels, and may be a member of any user group. For example, a person with a mobility impairment may be an advanced equestrian, drive a motorized device such as an off-highway vehicle (OHV), or ride a hand-powered or tandem bicycle. Therefore, it is recommended that the built facilities and amenities, such as restrooms and parking lots, at all trailheads and on all trails be constructed using accessible designs. Someone who rides a horse to a beautiful lake may still need the benefits of an accessible dock, picnic table, or restroom once they arrive.

The needs of all potential user groups should be addressed during the planning, design, and construction of the trailhead area to ensure that adequate amenities are available. Different types of users have distinct needs for trailhead amenities whether or not they have a disability. For example, bicyclists may need bike racks that are easy to use and secure. Equestrians need staging and rest areas large enough to accommodate the movements of a horse. Off-highway vehicle users require

# 12

# TRAIL PLANNING

## CHAPTER

a testing circle, or “landing,” at the trailhead to determine if their equipment is operating correctly. People with and without disabilities may be included in each of the trail user groups, and therefore amenities should be designed for the needs of all users.

### **12.6.3.2 Directing trailhead traffic**

In many situations, trailhead traffic may need to be controlled by restricting the size or configuration of the trailhead area. Situations where restrictions might be needed include:

- Trails that do not permit motorized use;
- Areas where animals, such as cattle, must be contained; and
- Trails where some uses are permitted but others prohibited.

The need for trailhead restrictions and the optimal designs to be used will depend on a variety of factors, such as the user

groups designated for trail use, ownership of the land, and the acceptable degree of development or modification.

Typically, to restrict access by particular user groups, a barrier is installed that is difficult or impossible for the prohibited users to negotiate. Common barrier types include:

- Intermittent objects, such as vertical posts (bollards) or large rocks;
- Vegetation;
- Fencing; and
- Gates or stiles.

Restricting access by limiting the trail width can effectively prevent most vehicles from entering onto a trail. However, installing gates, barriers, or fencing to prevent trail access by motorcycles, horses, or cyclists often results in the unintentional exclusion of people who use mobility devices, such as a wheelchair, handcycle, scooter, or walking aids. Similarly, stiles, stairs, or ladders may

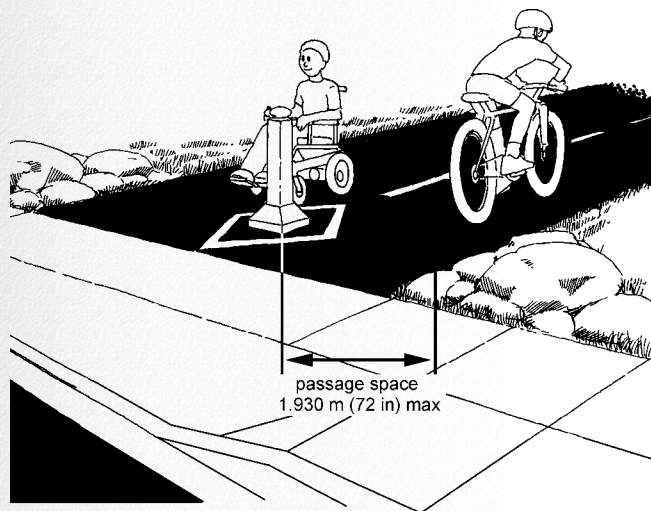
# 12

# TRAIL PLANNING

## CHAPTER

deter trail use by cyclists or equestrians, but also pose significant barriers to access. Therefore, the devices used to restrict access by specific user groups must be carefully planned and designed to ensure that they do not limit access to pedestrians with disabilities. Further research is needed to determine the best designs or solutions that do not prohibit access by people with disabilities. For example, if the trail crosses a cattle field, the designer

would need to provide a trail entrance that restricted the movement of the cattle but was suitable for all trail users, including people with disabilities.



**Figure 12-4.** Bollards should be at least 915 mm (36 in) apart for pedestrian only trails and at least 1.525 m (60 in) apart for trails that allow bicyclists.

### 12.6.3.2.1 Intermittent barriers

If intermittent barriers, such as bollards, are installed on a shared-use path or a recreation trail that permits bicycles, they should be spaced at least 1.525 m (60 in) apart. This distance is needed to

accommodate the width of any type of bicycle that may be used on the trail. Bicycles with panniers, bicycles pulling trailers, and adult tricycles are examples of bicycles that require a 1.525 m (60 in) width. Barriers installed with this spacing will also accommodate assistive mobility devices, such as a wheelchair, scooter, or walker.

If pedestrians are the only anticipated users of a recreation trail, the minimum passage space between barriers should be 915 mm (36 in). While this width will not prevent all cyclists from accessing the trail, a narrower width is inappropriate because it would be too narrow to permit passage by a person using a wheelchair or walker.

It is recommended that one barrier be installed in the center of the trail. The barrier will divide the tread width in half, and serve to divert traffic flow to one side or the other, creating one-way traffic flow as users move to either side of the bollard. If the trailhead area or trail tread is large and it is necessary to install more than one barrier, installing an odd number of barriers is recommended so that a center

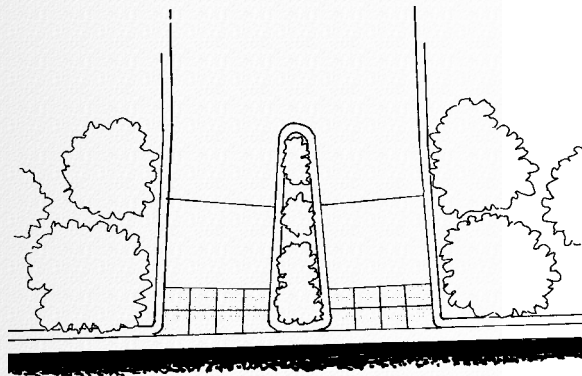


# 12

# TRAIL PLANNING

## CHAPTER

barrier will be maintained. The flow of traffic on either side of the center barrier will assist in reducing user collisions. When even numbers of barriers are installed, users will tend to travel between the center barriers causing a choking effect and increasing the potential for collisions. If a barrier is needed at the intersection of a trail with a street or another trail, designers should set the barrier back from the intersection so that users do not have to negotiate the barrier at the same time they are negotiating the intersection.



**Figure 12-5.** Providing a center median with low landscaping to restrict the width of the trail entrance is an effective alternative if installing a bollard is not desirable.

### 12.6.3.2.2 Medians

An alternative method for restricting motor vehicle traffic is to split the trail into two sections separated by a median or splitter island. Motor vehicles are less likely to travel on two parallel trails than one wide, continuous trail surface. If the median has a very low height or is paved, emergency or maintenance vehicles can have access to the trail, via the trail tread and median, when needed.

### 12.6.3.2.3 Gates, stiles, and fences

Gates, stiles, and fences are most effective when the purpose is to exclude large vehicles. Gates that comply with ADAAG in terms of size, force to operate, and with a latch mechanism that is considered accessible to users with disabilities should be installed instead of designs that limit access. Trails that do not permit bicycles or equestrians should consider gates with zigzag mazes. Other creative designs might include a maze with maneuvering space for a wheelchair user at lower heights with a narrower passage above the lap height of the wheelchair user.

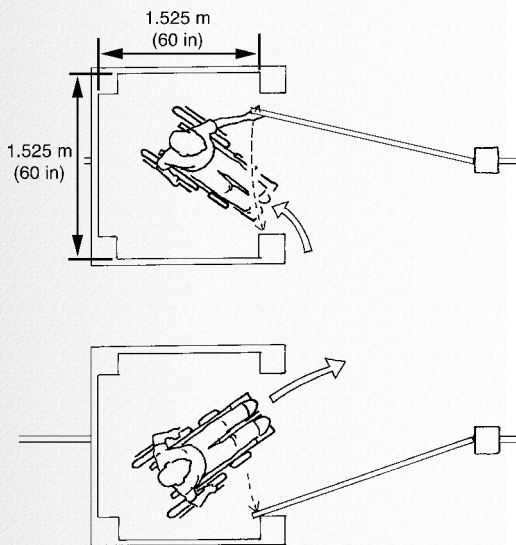
Gates are often used in rural settings on trails that cross private property especially in areas where a trail may cross pastureland. A kissing gate is one solution that can be used by people who use wheelchairs and other pedestrians, but prevents animals from exiting. The design requires the user to push the gate in front of them, enter a small holding area, and then push the gate behind them in order

# 12

# TRAIL PLANNING

## CHAPTER

to leave the holding area. An animal that entered the holding area will get stuck because it will not have the dexterity or the knowledge to operate the gate. The holding area must be designed to be at least 1.525 m x 1.525 m (60 in x 60 in) to allow maneuvering space for a wheelchair user.



**Figure 12-6. GOOD DESIGN:** The kissing gate allows pedestrian access, but prevents animals from leaving the fenced area. In this design, the user pushes the gate in front of them, enters the holding area, and then swings the gate over to pass through.

### 12.6.3.3 Information at the trailhead

Objective information about the condition of the trail should be available to trail users before they embark on the trail. Usually, the information is conveyed at designated trailheads through signage. However, other information formats (e.g., maps, guidebooks, or large print, audiotape, or Braille trail descriptions) may be preferred depending on the number of users, level of development, and availability of trail personnel. Information that is provided in a written format should also be provided in an audible format. This allows users who are unable to read text, such as those with vision impairments, learning disabilities, or individuals whose first language is not

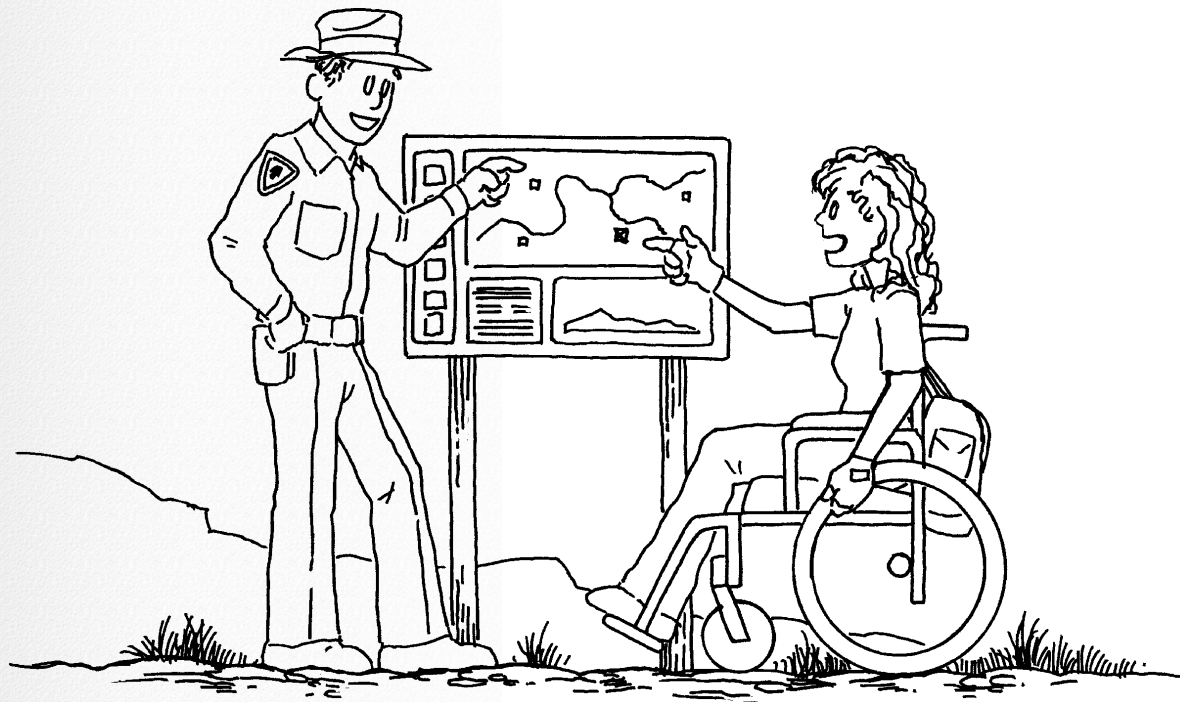
English, to have independent access to the same information provided to other trail users. See Chapters 14 and 15 for a more detailed description of the type of information that is recommended for trail users.

Information about the trail is also conveyed to the user through indirect methods of communication. For example, the trailhead provides users with their first impression of the trail's condition. A wide level trailhead area with a hardened surface and accessible parking and facilities may suggest a highly developed trail environment. If trail conditions become dramatically more challenging a short distance from the entrance, users may find themselves in unsatisfactory or potentially hazardous situations. Conversely, a narrow, undeveloped trailhead may discourage users from attempting to use a trail that does follow accessibility recommendations. When using indirect methods, such as the design of the trailhead, to convey information, it is important to provide the trail information in alternative formats,

# 12

# TRAIL PLANNING

## CHAPTER



**Figure 12-7.** Signs at the trailhead should provide objective information about the trail conditions.

so a person with an impairment can have access to this practical information.

Ideally, the trailhead should be representative of the conditions provided in the trail environment and in nearby facilities such as picnic areas. When the conditions on the trail and at the trailhead are not consistent, it becomes even more important to provide accurate information about the on-trail conditions, through signs or other direct information sources, at the trailhead.

# Universal Trail Assessment Process

Information provided about trails has traditionally been very limited. It usually consists of trail length and a subjective rating such as “easy” or “difficult.”

Subjective ratings reveal very little about the actual conditions of the trail. For example, a hiker who uses a wheelchair cannot determine from an “easy” rating whether a trail is wide enough throughout to permit the wheelchair to pass. If the trail is too narrow, the user may have to turn back. This is frustrating for both the hiker using a wheelchair and any hiking companions.

## 13.1 Overview

The Universal Trail Assessment Process (UTAP) is an inventory tool that

records accessibility and maintenance information on a trail. The UTAP was designed to meet the information needs of both trail users and land management agencies. The assessment process was developed over a four-year period through the collaboration of Federal, State, and local land management agencies, as well as trail organizations. The UTAP has been implemented by several agencies and organizations to record trail conditions for access and maintenance information, including:

- USDA Forest Service;
- USDI Bureau of Land Management;
- USDI National Park Service;



**Figure 13-1.** The Universal Trail Assessment Process (UTAP) Tool Kit.

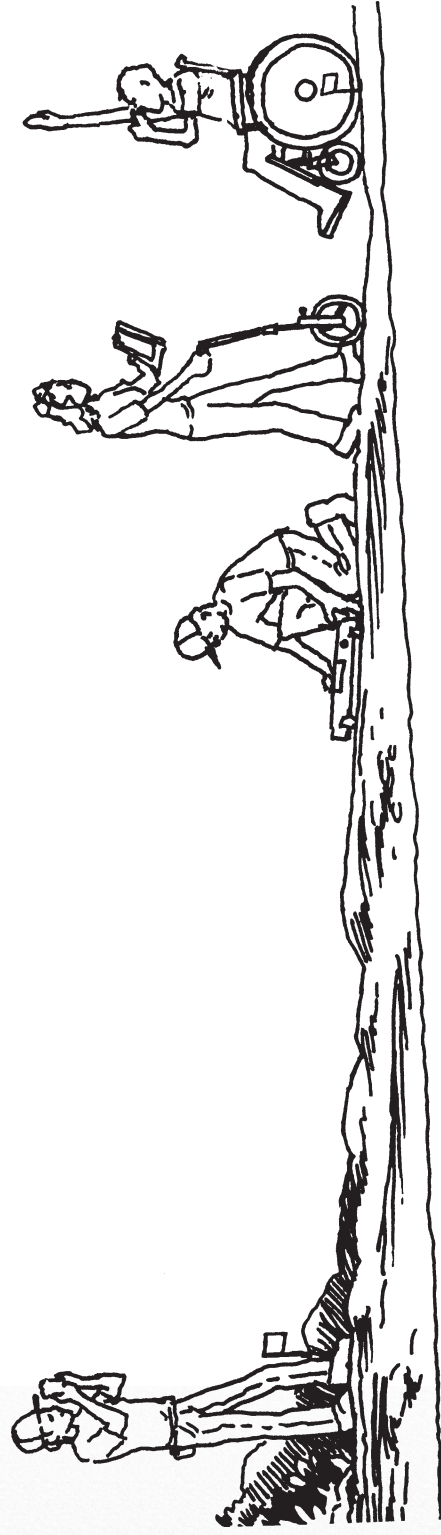


- California State Parks;
  - Florida Trail Association;
  - Indiana Department of Natural Resources; and
  - Minnesota Department of Natural Resources.
- Trail length;
  - Maximum and average cross slopes;
  - Maximum and average grades;
  - Surface type and firmness;
  - Minimum clear width; and
  - Average tread width.

### The Universal Trail Assessment

Process (UTAP) is used to collect data that can be used to provide objective information to users about the conditions of trails. The primary accessibility information recorded for trails includes:

- The primary maintenance information recorded about a trail includes:
- Tread condition;
  - Obstacle locations and magnitude;



**Figure 13-2.** The Universal Trail Assessment Process can be completed by a team of volunteers under the leadership of a trail assessment coordinator.



- Vegetation within the trail corridor;
- Condition of drainage structures;
- Presence of downed trees;
- Washed out sections of the trail;
- Condition of signage; and
- Condition of benches, tables, and other amenities, as well as whether or not these are accessible designs.

in selecting the best routes for travel. Conducting trail assessments are also beneficial because they allow trail managers to inventory trail conditions and plan for trail projects including:

- Determining if the trail meets intended design specifications and guidelines;
- Prioritizing trail maintenance projects;
- Budgeting for trail projects;
- Identifying portions of trails that can be made more accessible;
- Developing maintenance schedules;
- Quantifying the extent of repair work required;
- Cataloging feature and maintenance information;
- Sharing trail data and project plans with disability focus groups; and
- Creating objective trail information for users, such as signing, maps, and websites.

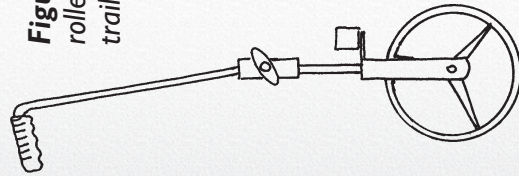
### 13.2 Benefits of assessment

Assessing the content and condition of existing trails is the first step towards providing access for all users. One of the greatest obstacles people face when trying to select a trail to hike is the lack of objective information regarding trail access. With enough specific information, people will be better able to travel independently with confidence in their ability to reach their destination safely.

Objective data obtained from trail assessments enables trail managers to create maps, signage, and other informational guides that will assist users



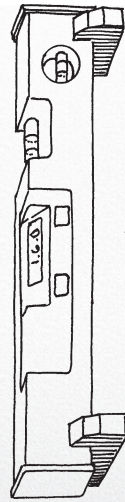
**Figure 13-3.** A member of the trail assessment team uses a hand-held clinometer to measure the running grade between two stations.



**Figure 13-4.** A rolatape is rolled down the center of the trail to measure trail length.



**Figure 13-5.** A clinometer is used to measure running grade between stations.



**Figure 13-6.** A digital inclinometer is used to measure maximum grades, cross slopes, and maximum cross slopes.

### 13.3 Trail assessment coordinators

The Universal Trail Assessment Process (UTAP) should be conducted by a certified Trail Assessment Coordinator. UTAP Coordinator Workshops are offered to teach the assessment process and to train people to become Trail Assessment Coordinators. The workshop involves two days of training that is conducted through classroom and on-trail learning experiences. Upon completion of the workshop, participants have the knowledge and experience that is needed to conduct assessments. Approximately 350 people have been trained to lead the Universal Trail Assessment Process. For more information about training opportunities, contact Beneficial Designs, Inc. (contact information listed in Appendix C).

### 13.4 Data collection and processing

The Universal Trail Assessment Process relies on inexpensive and easy-to-

use tools to reduce costs and to simplify the process. An overview of the tools used to conduct the UTAP is provided below. For more specific information about how measurements are collected, it is recommended that an individual attend a UTAP Coordinator Workshop.

1. A **rolatape**, which is a wheeled measurement device, is rolled down the center of the trail to measure trail length.
2. **Stations** are marked to provide a location for trail measurements to be taken.
3. A hand-held **clinometer** is used to measure running grade between stations.
4. A **digital inclinometer (level)** is used to measure maximum grades, cross slopes, and maximum cross slopes. The inclinometer is 610 mm (24 in) long, and it provides measurements over the same distance spanned by the length and width of the wheelbase of an average wheelchair, walker, or crutch span.





**Figure 13-7.** A tape measure is used to record trail width and the magnitude of obstacles.

5. A **tape measure** is used to record:

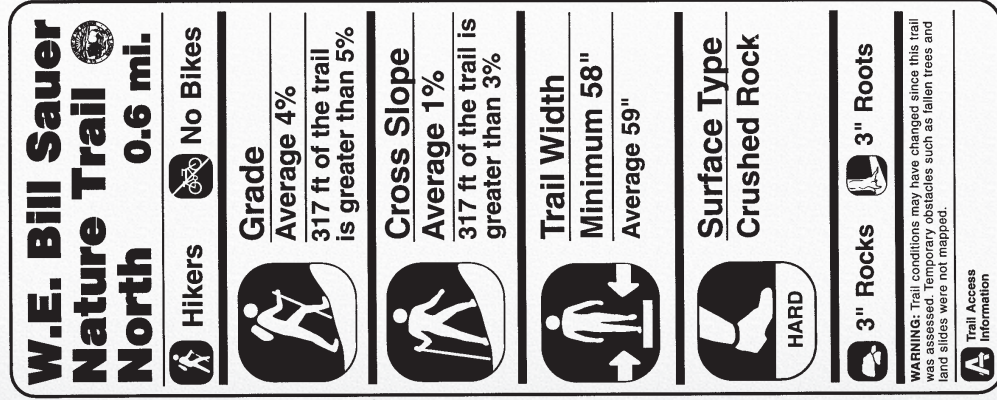
- Trail width at each station;
- Height of the clear vertical passage when it is less than the specified design for the trail (vertical clearance);
- Distance and magnitude of trail segments narrower than specified for the trail (minimum clear width); and
- Dimensions of features, obstacles, and protruding objects, that might obstruct passage or require maintenance or repair.

Trail surfaces are subjectively classified as paved, hard, firm, soft, or very soft. The trail data collected during the UTAP can be processed and summarized into Trail Access Information (TAI) by a computer software program called TrailWare™. The program creates tables listing the most severe measurements of each trail characteristic, calculates

average trail grade, cross slope and width, tabulates surface type percentages, and produces a trail grade profile. In addition, the program provides a list of features and potential maintenance items that can be sorted and used to prioritize work projects. The program also generates reports, complete with graphics, that can be used as trail signage or information sheets. For more information about TrailWare™, contact Beneficial Designs, Inc. (listed in Appendix C).

### 13.5 Presenting trail access information

Trail Access Information (TAI) on signs, maps, and other trail guide products provides potential users with the information needed to determine which trails can best meet their desired experiences, interests, and abilities. A system of symbols and trail signage layouts has been developed to convey TAI in attractive and easy-to-use formats. Providing the information in multiple formats, such as large print or audible

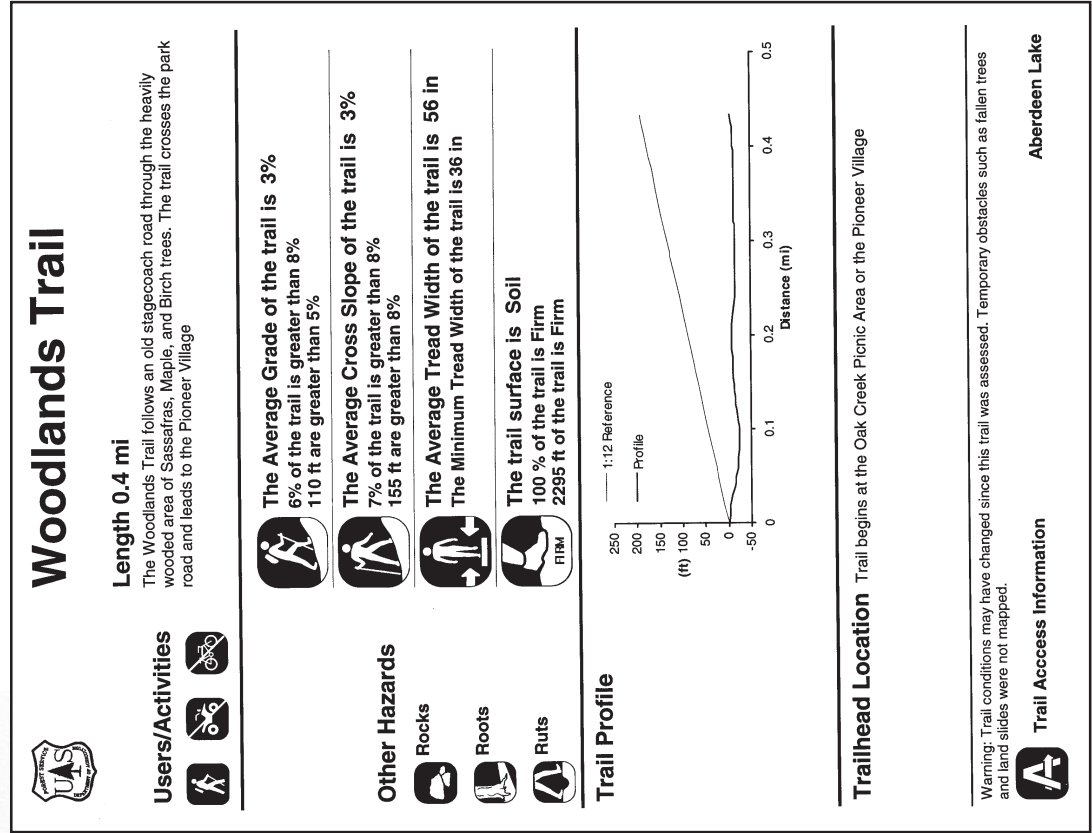


**Figure 13-8.** Example of a Trail Access Information strip.

formats, will benefit people of all abilities. The following formats are examples of how Trail Access Information can be disseminated:

- **Trailhead signage** — A trailhead map containing text, grade profiles with surface information, a top view map with symbols showing the location of major obstacles, and Trail Access Information.
- **Trail Access Information strip** — A trail map summarizing critical Trail Access Information with symbols and measurement numbers formatted as a slim strip that can be attached to trail posts and located at trailheads or trail intersections.
- **Trail Information Sheets** — An informational sheet that can be provided at the trailhead or visitor center summarizing Trail Access Information with symbols and measurement numbers, a trail grade profile, description of the trail, and location of trailhead.
- **Audio descriptions** — A short audible narrative with descriptions of trail conditions and details about the trail environment. This format may benefit individuals who have vision impairments or who have limitations reading in English.
- **Pocket map** — A trail map featuring trail descriptions, Trail Access Information, and a grade profile that folds up to fit into a pocket.
- **Guidebook** — A trail manual containing Trail Access Information, interpretive information, scenic photographs, directions to the trailhead, and other information about trails within a given recreational area.
- **Computerized visitor kiosk** — An interactive accessible computer display at a visitor center providing trail selection tools, Trail Access Information, and visual and audio descriptions of images at

**Figure 13-9.** Example of a Trail Information Sheet.



selected destinations. Guidelines recommended for making kiosks accessible to people with mobility and vision impairments are available through the U.S. Access Board; and

- **Website** – Trailexplorer.org is an Internet site containing Trail Access Information about recreation trails in a variety of regions throughout the United States.





# Shared-Use Path Design

A shared-use path serves as part of a transportation circulation system and supports multiple recreation opportunities, such as walking, bicycling, and inline skating. A shared-use path typically has a surface that is asphalt, concrete, or firmly packed crushed aggregate. The 1999 AASHTO Guide for the Development of Bicycle Facilities defines a shared-use path as being physically separated from motor vehicular traffic

with an open space or barrier (AASHTO, 1999). Shared-use paths should always be designed to include pedestrians even if the primary anticipated users are bicyclists.

Shared-use paths provide a transportation function. All newly constructed shared-use paths should be built to provide access for people with disabilities. In addition, existing shared-use paths should be improved to enhance access whenever possible. If improvements to existing facilities cannot be made immediately, it is recommended that information, including signage, be provided at all path entrances. This information should clearly convey objective information to trail users, including data about grade, cross slope, surface, and width.



**Figure 14-1.** Shared-use paths provide recreation and transportation opportunities for a variety of user groups including pedestrians and bicyclists.

### 14.1 Background information

For most shared-use paths, bicyclists are the primary user group. Cyclists include tandem, recumbent, and hand powered three-wheelers. Road racing wheelchairs may use shared-use paths, reaching speeds of over 30 mph on downhill sections, and should have the same rights and privileges as cyclists. In many cases, the design requirements for bicyclists are similar, if not more stringent, than the design requirements for pedestrians with disabilities. For example, people who use wheelchairs can travel over small changes in level. However, because bicyclists are often traveling at faster speeds, smooth surfaces are needed. Although people with vision impairments can identify an edge protection in a trail environment if it is more than 76 mm (3 in) high, an edge protection lower than a 1.065 m (42 in) railing can be dangerous for a bicyclist.

For this report, the majority of the accessibility recommendations for shared-use paths are based on the 1999

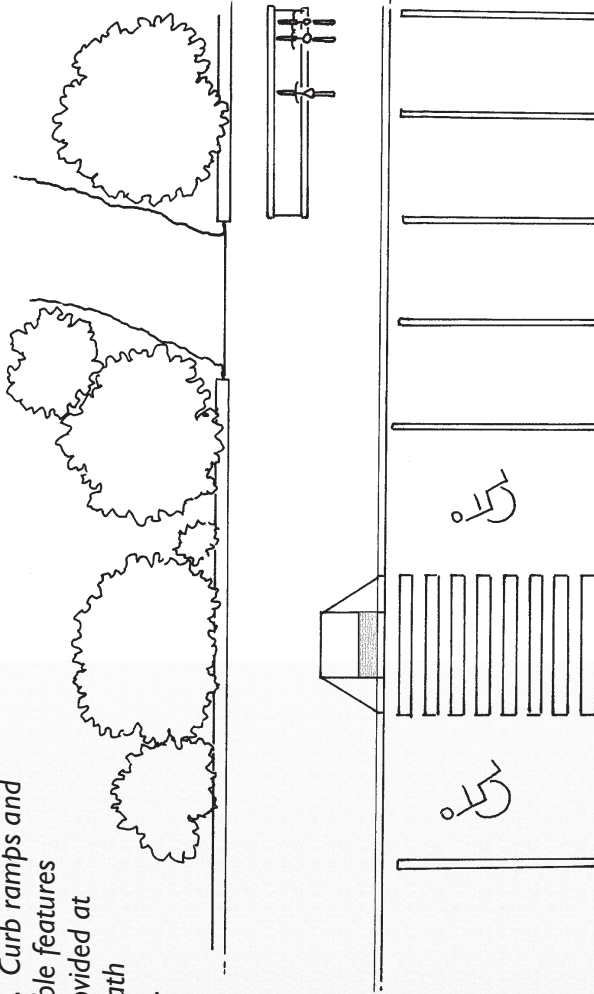
AASHTO Guide for the Development of Bicycle Facilities (AASHTO, 1999). Additional issues, such as protruding objects (that are not addressed in the AASHTO bicycle facility guide) are also included in this report. However, the recommendations for grade in this report are based on the work by the Regulatory Negotiation Committee for Outdoor Developed Areas because the maximum grades identified for bicyclists in the AASHTO bicycle facility guide do not provide access to many people with mobility impairments.

### 14.2 Access to shared-use paths

Creating a shared-use path that provides access for people with disabilities involves more than the trail itself. Ensuring that an accessible pathway leads up to the shared-use path must also be considered. In addition, all access points along the shared-use path should be accessible to people with disabilities. Furthermore, the facilities around the trail should also be designed for access. For example:



**Figure 14-2.** Curb ramps and other accessible features should be provided at shared-use path access points.



recommendations for shared-use paths;

- Road access points should meet the recommendations in Chapter 16; and

- Signage at the access point should conform to ADAAG requirements for font size, font type, and contrast.

As previously indicated, the design of pathways leading up to shared-use paths should provide the same standard of accessibility as is provided on the path itself. However, the full 3.05 m (10 ft) that is recommended for tread width may not be necessary unless traffic is expected to be heavy.

### 14.2.1 Rail trails

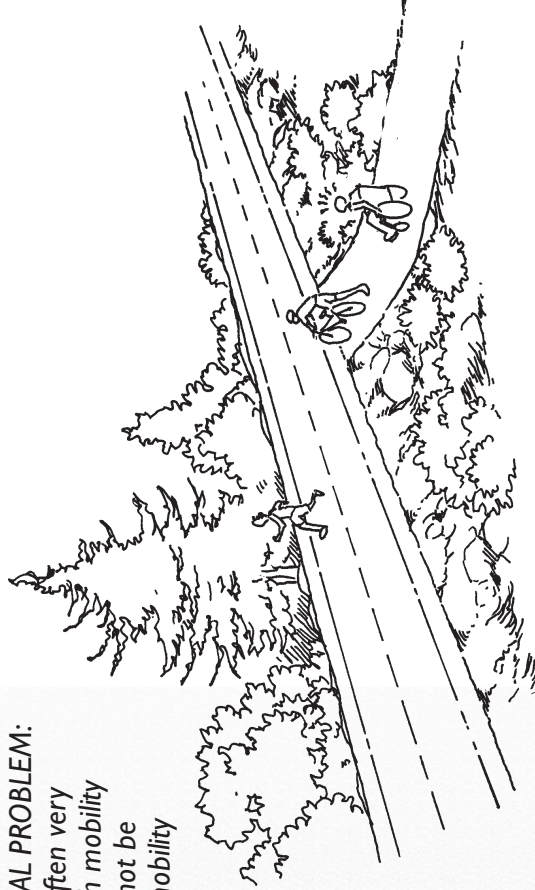
Rail trails are an example of shared-use paths that are created from the right-of-way of abandoned railroad lines. Because railroad beds have gradual grades and turns, relatively few barriers exist in

- Trailhead and destination areas with parking and bathrooms should conform to ADAAG requirements for accessible parking and bathrooms;
- Elements, such as picnic areas, should be connected with a pathway that meets the accessible design

#### Case Study 14-1

Anticipated to span eight counties between Chadron and Norfolk, Nebraska, the 550 km (321 mile) Cowboy Trail will be the longest rails to trails conversion in the United States when it is complete.

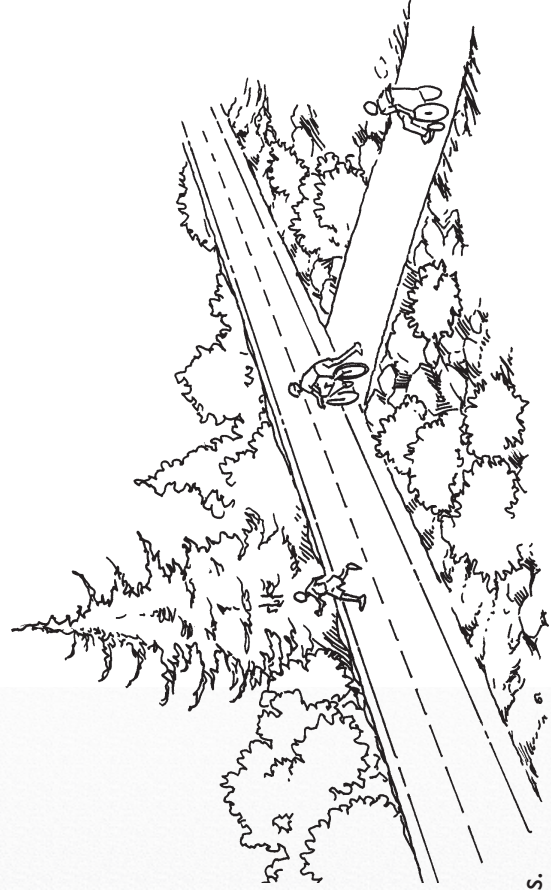
**Figure 14-3. POTENTIAL PROBLEM:** Although rail trails are often very accessible to people with mobility impairments, they may not be usable by people with mobility impairments if the path leading up to the trail is very steep or includes unstable surfaces.



making this type of trail accessible. The greatest challenge is typically designing an accessible pathway to the shared-use path. If the rail bed is raised high above the surrounding areas, providing access for people with mobility impairments may involve changes in design, such as reducing grade through the use of switchbacks or building ramped surfaces.

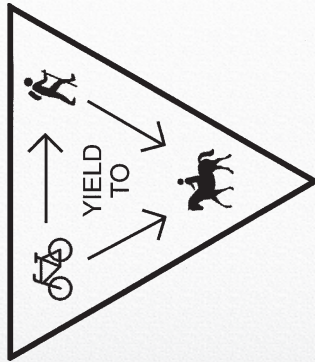
### 14.3 Conflicts between multiple user groups

Shared-use paths attract a variety of user groups who often have conflicting needs. All pedestrians are affected by sudden changes in the environment and by other trail users, such as bicyclists, who travel at high speeds. However, the conflicts on shared-use paths are especially significant for people who cannot react quickly to hazards, such as some people with mobility impairments. To improve the shared-use path experience for all users, including people with disabilities, designers and planners should be aware of potential conflicts and employ innovative

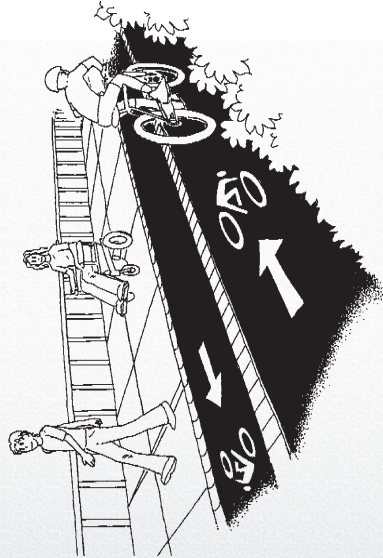


**Figure 14-4.** GOOD DESIGN: Access to rail trails can be improved by replacing steep grades with more gradual slopes.





**Figure 14-5.** Shared-use paths attract a variety of user groups. Providing signs that clearly indicate which users have the right of way will help avoid conflict.



**Figure 14-6.** GOOD DESIGN: Shared-use paths that provide different lanes for users who travel at different speeds prevent conflicts between user groups on high use trails.

solutions whenever possible. Basic conflicts can be reduced by:

- Providing information, including signage, in multiple formats that clearly indicates permitted users and rules of conduct;
- Ensuring that the shared-use path provides sufficient width and an appropriate surface for everyone, or providing alternate paths for different types of users;
- Providing sufficient separation for users traveling at different speeds. For example, if volume and space permits, bicyclists and pedestrians should have different lanes or pathways;

- Providing the necessary amenities for all users. For example, bicyclists require bike racks or lockers; and
- Considering the needs of people with disabilities within all of the user groups permitted on the path. For example, many individuals with

disabilities may use a longer hand cycle or wider tricycle design that may not be compatible with bike racks, bathroom stalls, or lockers of limited width. Longer and wider equipment may need additional maneuvering space in restrooms and when transferring from the chair to benches.

### 14.4 Shared-use path surfaces

The condition of the surface is a significant factor in determining how easily a person with a disability can travel along a shared-use path. The accessibility of the shared-use path surface is determined by a variety of factors including:

- Surface material;
- Surface firmness and stability;
- Slip-resistance;
- Changes in level; and
- Size and design of surface openings.

#### 14.4.1 Surface material

There are various surface materials that can be used in outdoor environments. Shared-use paths are generally paved with asphalt or concrete, but may also use prepared surfaces such as crushed stone or soil stabilizing agents mixed with native soils or aggregates. High use trails passing through developed areas or fragile environments are commonly surfaced with asphalt or concrete to maximize the longevity of the shared-use path surface and promote bicycle and inline skating use.

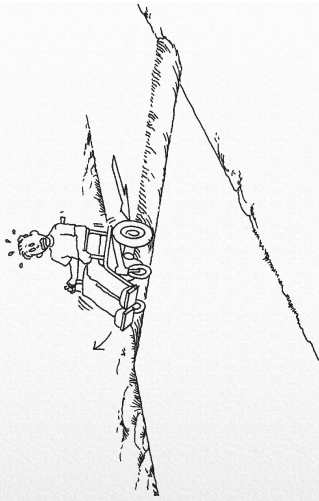
The surfacing material on the shared-use path significantly affects which user groups will be capable of negotiating the terrain. Shared-use paths that have been built using crushed aggregate generally are unusable by inline skaters and slow down the speed of bicyclists. Paved surfaces should be provided in areas that are subject to flooding or drainage problems, in areas with steep terrain, and in areas where bicyclists or inline skaters are the primary users.

#### 14.4.2 Surface firmness, stability, and slip resistance

The firmness, stability, and slip resistance of the shared-use path surface affects all users but is particularly important for people using mobility devices such as canes, crutches, wheelchairs, or walkers.

- **Firmness** is the degree to which a surface resists deformation by indentation when a person walks or wheels across it. A firm surface would not compress significantly under the forces exerted as a person walks or wheels on it.
- **Stability** is the degree to which a surface remains unchanged by contaminants or applied force so that when the contaminant or force is removed, the surface returns to its original condition. A stable surface would not be significantly altered by a person walking or maneuvering a wheelchair on it.

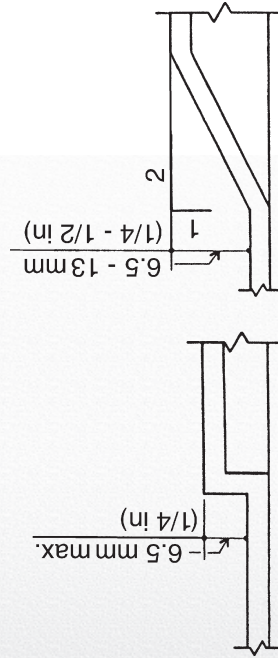




**Figure 14-7.** Oftentimes, surface maintenance issues are addressed in small segments rather than resurfacing the entire path. Improperly recompacted trenching can contribute to loss of control and cause the wheelchair to flip over backwards.

- **Slip resistance** is based on the frictional force necessary to permit a person to ambulate without slipping. A slip resistant surface does not allow a shoe heel, wheelchair tires, or a crutch tip to slip when ambulating on the surface.

Shared-use paths should have a firm and stable surface. When a person walks or wheels across a surface that is not firm and stable, energy that would otherwise cause forward motion instead deforms or displaces the surface or is lost through slipping. Asphalt and concrete are firm and stable in all conditions. Other shared-



**Figure 14-8.** Vertical changes in level on shared use paths should not exceed 6 mm (0.25 in). A bevel should be applied to changes in level between 6 mm (0.25 in) and 13 mm (0.5 in).

with a surface that is slip resistant during typical weather conditions. A slip-resistant surface reduces the possibility of a person's shoes, crutch tips, or tires sliding across the surface. The U.S. Access Board Technical Bulletin #4 addresses slip resistance in further detail (U.S. Access Board, 1994a).

### 14.4.3 Changes in level

Changes in level are defined as the maximum vertical change between two adjacent surfaces. Examples of changes in level that may be seen on shared-use paths include uneven transitions from the shared-use path surface to a bridge or walkway, cracks caused by freezing and thawing, or a sudden change in the natural ground level (often caused by earthquakes or nearby trees).

Although changes in level are not desirable for people with mobility impairments, they are most harmful to bicyclists and inline skaters. Abrupt changes in level can cause pedestrians to trip and fall. The risk is particularly acute

for individuals who have difficulty lifting their feet high up off the ground or who have limited vision and may be unable to detect the change in level. Catching a wheel on an obstacle or change in level can easily tip wheeled devices over as the individual's momentum continues despite the wheel having suddenly stopped. Minimizing or eliminating changes in level will greatly improve shared-use path safety for all users.

For shared-use paths, the following recommendations should be followed:

- Vertical changes in level should not be incorporated in new construction;
- If unavoidable, small changes in level up to 6 mm (0.25 in) may remain vertical and without edge treatment;
- A beveled surface with a maximum slope of 50 percent should be added to small level changes in levels between 6 mm (0.25 in) and 13 mm (0.5 in); and

- Changes in level such as curbs that exceed 13 mm (0.5 in) should be ramped or removed.

#### 14.4.4 Openings

Openings are spaces or holes in the tread surface. On recreation trails, openings may occur naturally, such as a crack in a rock surface. On shared-use paths, however, openings are usually constructed, such as spaces between the planks of a boardwalk that allow water to drain from the surface. A grate is an example of an opening that is a framework of latticed or parallel bars that prevents large obstacles from falling through a drainage inlet but permits water and some sediment to pass through. Another example of an opening is a flangeway gap at a railroad crossing.

If at all possible, openings should not be within the shared-use path surface. Openings, such as drainage grates, should be located outside the shared-use path tread. Wheelchair casters or walkers, crutch and cane tips, inline skate wheels,



and the tires of road bicycles can get caught in poorly placed grates or gaps creating a serious safety hazard.

When designers cannot avoid placing openings in the shared-use path, they employ the following specifications:

- **Opening Width** — The size of the open space should not permit a 13 mm (0.5 in) diameter sphere to pass through the opening. If a wider gap is unavoidable because of existing design constraints, it may be acceptable to extend the width to a maximum of 19 mm (0.75 in); and
- **Opening Orientation** — If the open space is elongated, it must be oriented so that the long dimension is perpendicular to the dominant direction of travel.

### 14.5 Shared-use path grade and cross slope

Steep grades and cross slopes have significant drawbacks for people with mobility impairments. For example, more

energy is required to traverse sloped surfaces than level surfaces. Powered wheelchairs use more battery power on steep grades because the chair compensates for the difficult terrain. Furthermore, both powered and manual wheelchairs are less stable on sloped surfaces, particularly if wet or frozen.

#### 14.5.1 Grade

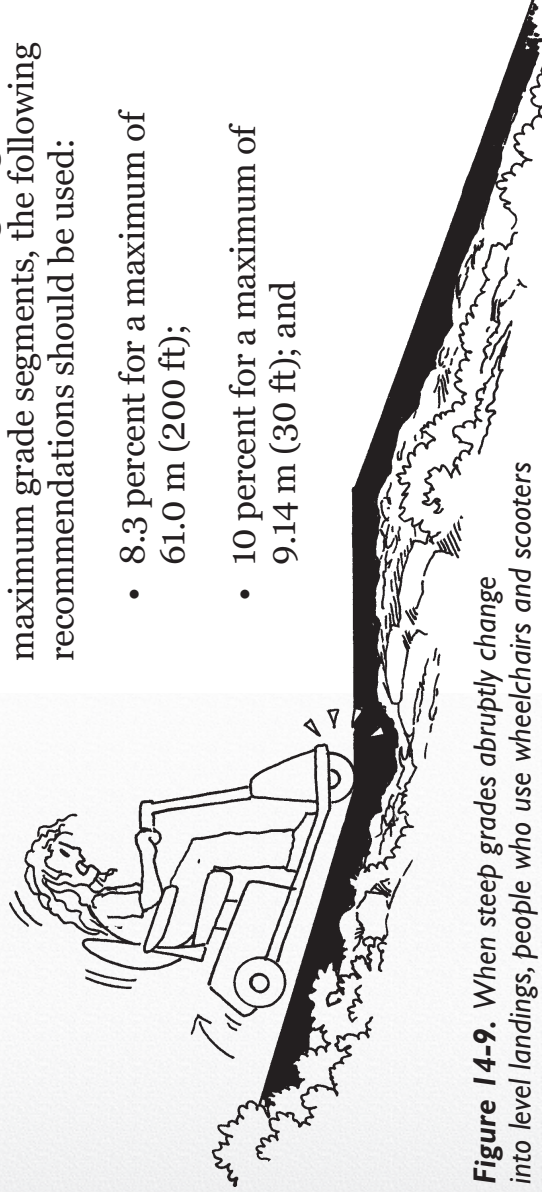
People with mobility impairments have a difficult time negotiating steep grades because of the additional effort required to travel over sloped surfaces. Manual wheelchair users may travel very rapidly on downhill pathways but will be significantly slower on uphill segments. Steep running grades are particularly difficult for users with mobility impairments when resting opportunities are not provided. Less severe grades that extend over longer distances may tire users as much as shorter, steeper grades. In general, running grades on shared-use paths should not exceed 5 percent and the most gradual slope possible should be used at all times.



If steeper segments are incorporated into the shared-use path, the total running grade that exceeds 8.33 percent should be less than 30 percent of the total trail length. In addition, it is essential that the lengths of the steep sections are minimized and are free of other access barriers.

Negotiating a steep grade requires considerable effort. Users should not be required to exert additional energy to simultaneously deal with other factors, such as steep cross slopes and change in vertical levels. When designing maximum grade segments, the following recommendations should be used:

- 8.3 percent for a maximum of 61.0 m (200 ft);
- 10 percent for a maximum of 9.14 m (30 ft); and



**Figure 14-9.** When steep grades abruptly change into level landings, people who use wheelchairs and scooters are put at risk of falling forward or losing control of their device.

- 12.5 percent for a maximum of 3.05 m (10 ft).

Although the recommended maximum grades are similar to those recommended in the 1999 AASHTO Guide for the Development of Bicycle Facilities, the maximum distances are significantly shorter.

Near the top and bottom of the maximum grade segments, the grade should gradually transition to less than 5 percent. In addition, rest intervals should be provided within 7.6 m (25 ft) of the top and bottom of a maximum grade segment. Rest intervals may be located on the shared-use path but should ideally be located adjacent to the path for the safety of all users (see Section 14.5.2). Well-designed rest intervals should have the following characteristics:

- Grades that do not exceed 5 percent;
- Cross slopes on paved surfaces that do not exceed 2 percent and cross slopes on non-paved surfaces that do not exceed 5 percent;

- A firm and stable surface;
- A width equal to or greater than the width of the path segment leading to and from the rest interval;
- A minimum length of 1.525 m (60 in); and
- A minimum change of grade and cross slope on the segment connecting the rest interval with the shared-use path.

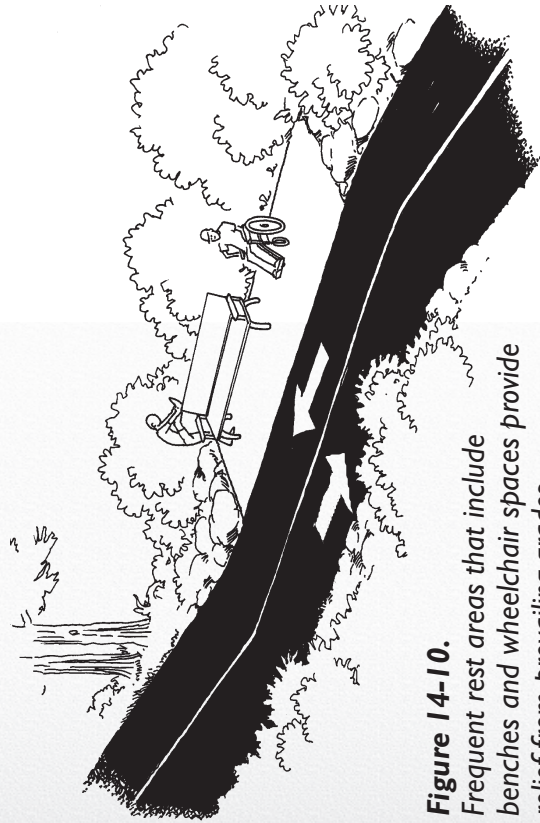
increase. The frequency of rest areas should vary depending on the terrain and intended use. For example, heavily used shared-use paths should have more frequent opportunities for rest. Rest areas provide an opportunity for users to move off the trail, instead of remaining on the trail to stop and rest. If a rest area is only provided on one side of the trail, it should be on the uphill side. Having separate rest areas on both sides of the trail is preferred when there is a higher volume or higher traffic speed. This reduces trail users from having to cross in front of other trail users moving in the opposite direction.

A rest area will have many of the same characteristics as a rest interval (see Section 15.5.1.3). However the additional space allows for more amenities. In general, rest areas should have the following design characteristics:

- Grades that do not exceed 5 percent;
- Cross slopes on paved surfaces that do not exceed 2 percent and cross slopes on non-paved surfaces that do not exceed 5 percent;

### 14.5.2 Rest areas

Periodic rest areas are beneficial for all shared-use path users, particularly for people with mobility impairments that expend more effort to walk than other pedestrians. Rest areas are especially crucial when grade or cross slope demands



**Figure 14-10.** Frequent rest areas that include benches and wheelchair spaces provide relief from prevailing grades.



- A firm and stable surface;
- A width equal to or greater than the width of the trail segment leading to and from the rest area;
- A minimum length of 1.525 m (60 in);
- A minimal change of grade and cross slope on the segment connecting the rest area with the main pathway; and
- Accessible designs for amenities such as benches, where provided.

Benches can be particularly important for people with disabilities, who may have difficulty getting up from a seated position on the ground. Some benches should have backrests to provide support when resting, and at least one armrest to provide support as the user resumes a standing position. Accessible seating should provide the same benefits as seating for users without disabilities. For example, providing a wheelchair space facing away from the intended view would not be appropriate.

### 14.5.3 Cross slope and drainage

Severe cross slopes can make it difficult for wheelchair users and other pedestrians to maintain their lateral balance because they must work against the force of gravity. Cross slopes can cause wheelchairs to veer downhill and create problems for individuals using crutches who cannot compensate for the height differential that cross slopes create. The impacts of cross slopes are compounded when combined with steep grades or surfaces that are not firm and stable.

Cross slope can be a barrier to people with mobility impairments. However, some cross slope is necessary to drain water quickly off of shared-use paths. Designers must balance the negative effect cross slopes have on pedestrian mobility against the necessity of including cross slopes to provide adequate drainage. Designers should use the minimum cross slope necessary for the shared-use path. For asphalt and concrete, a cross slope of 2.0 percent should be adequate. For non-paved surfaces, such as crushed

aggregate, the maximum recommended cross slope is 5 percent.

### 14.6 Shared-use path width

The width of the shared-use path tread not only affects pedestrian usability but also determines the types of users who can use the path. Factors, such as the movement patterns of designated user groups, should be considered. For example, skaters may use a lateral foot motion for propulsion that is wider than the stride of most pedestrians. In addition, shared-use

paths should be designed to accommodate high-speed users in both directions.

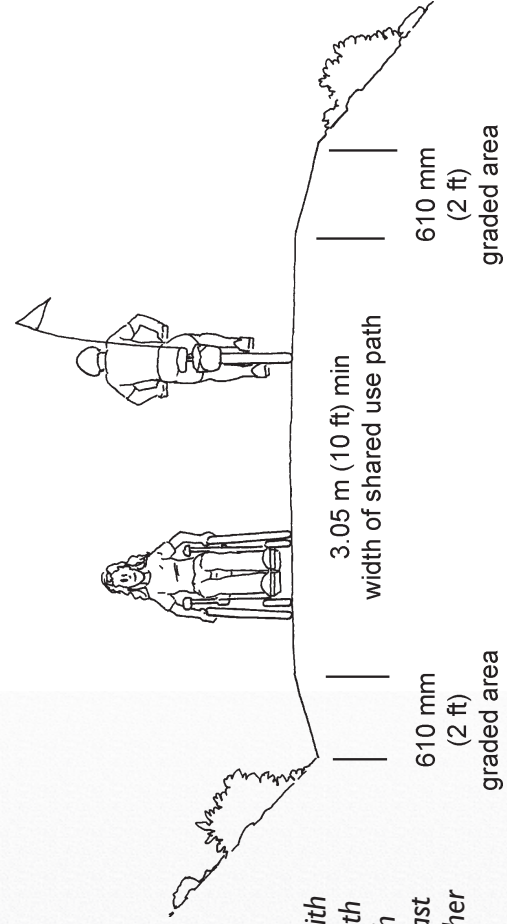
The tread of a shared-use path should be at least 3.05 m (10 ft) wide. A minimum of 2.44 m (8 ft) may be used on shared-use paths that will have limited use. Shared-use paths should also have graded areas at least 610 mm (2 ft) on either side of the path. On shared-use paths with heavy volumes of users, tread width should be increased to a range from 3.66 m to 4.27 m (12 ft to 14 ft).

#### 14.6.1 Passing space

Generally, passing spaces are not necessary on shared-use paths because the width of the shared-use path exceeds the recommended dimensions that require a passing space. If a shared-use path is narrow, periodic passing spaces of at least 1.525 m x 1.525 m (60 in x 60 in) should be provided.

#### 14.6.2 Protruding objects

Protruding objects are anything that overhangs or protrudes into the

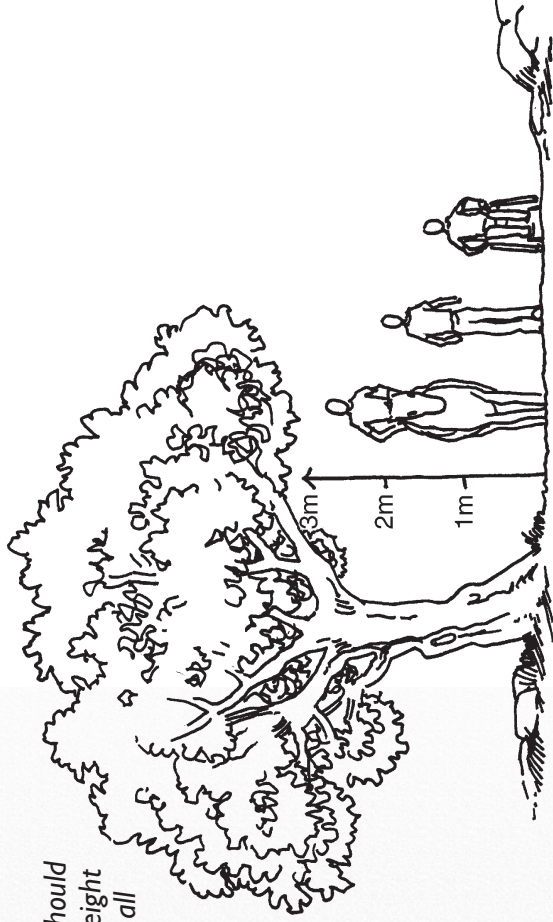


**Figure 14-11.** Shared-use paths should be designed with a minimum tread width of 3.05 m (10 ft) with graded areas of at least 610 mm (2 ft) on either side of the path.



**Figure 14-12.**

Overhead branches should be maintained to a height which is sufficient for all expected users of a shared-use path.



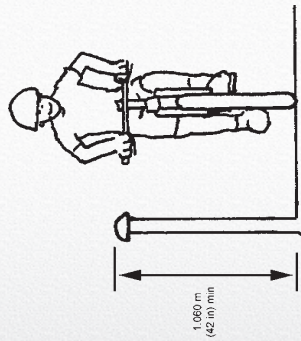
with vision impairments who use long white canes to navigate can easily detect objects on the shared-use path that are below 685 mm (27 in). However, objects that protrude into the pathway between 685 mm (27 in) and 2.030 m (80 in) are more difficult because the cane will not always come in contact with the object before the pedestrian comes in contact with the object.

Ideally, objects should not protrude into any portion of the clear tread width of a shared-use path. If an object must protrude into the travel space, it should not extend more than 101 mm (4 in). Furthermore, a vertical clearance of 2.44 (8 ft) should be provided rather than the 2.030 m (80 in) needed for pedestrians, to accommodate other shared-use path users, such as bicyclists. On shared-use paths where there is the potential for emergency or maintenance vehicles to gain access to areas, it may be necessary to increase the vertical clearance. In addition, when an underpass such as a tunnel is used, 3.05 m (10 ft) of vertical clearance is recommended (Section 16.4).

shared-use path tread whether or not the object touches the surface. Examples of protruding objects include lighting posts, poorly maintained vegetation, and signs.

People with vision impairments who use guide dogs for navigation are able to avoid obstacles in the pathway up to 2.030 m (80 in). Objects that protrude into a shared-use path but are higher than 2.030 m (80 in) tend to go unnoticed because most pedestrians require less than 2.030 m (80 in) of headroom. People





**Figure 14-13.** Railings on shared use paths should be at least 1.065 m (42 in) high to prevent bicycle riders from flipping over the top. AVOID protrusions at handlebar height.

### 14.7 Railings

Low forms of edge protection, such as curbs, are not recommended on shared-use paths because of the negative impact they have on bicyclists. If edge protection is needed, it should take the form of a railing. The minimum railing height on a shared-use path should be 1.065 m (42 in). In some situations, it may also be beneficial to provide a gripping surface for pedestrian use in addition to the protective railing. If

a handrail is included as part of the railing design, it should meet the specifications in ADAAG 4.26.

### 14.8 Signs

Signs that clearly describe the shared-use path conditions are an essential component to enhance pedestrian access. Signs should be provided in an easy to understand format with limited text and graphics that are understood by all users. Providing accurate, objective information about actual shared-use path conditions will allow people to assess their own interests, experience, and skills in order to determine whether a particular shared-use path is appropriate or provides access to them with their assistive devices. Providing information about the condition of the shared-use path to users is strongly recommended for the following reasons:

- Users are less likely to find themselves in unsafe situations if they understand the demands of the shared-use path before beginning;



**Figure 14-14.** Signs that provide objective information about shared-use paths using simplified text and graphics benefit all users.

- Frustration is reduced and people are less likely to have to turn around on a shared-use path because they can identify impassible situations, such as steep grades, before they begin;
- Users can select shared-use paths that meet their skill level and desired experience;
- The level of satisfaction increases because the user is able to select a shared-use path that meets his or her expectations; and
- If more difficult conditions will be encountered, users can prepare for the skill level and equipment required.

Objective information about the shared-use path conditions (e.g., grade, cross slope, surface, width, obstacles) is preferable to subjective difficulty ratings (e.g., easier, most difficult). Because subjective ratings of difficulty typically

represent the perceptions of the person making the assessment, the ratings cannot be accurate or appropriate for the range of shared-use path users. Individuals with respiratory or heart conditions, as well as individuals with mobility impairments, are more likely to have different interpretations of shared-use path difficulty than other users.

A variety of information formats may be used to convey objective shared-use path information. The type of format should conform to the policy of the management agency. Written information should also be provided in alternative formats, such as Braille, large print, or an audible format. For example, the text of a shared-use trailhead sign can also be made available on audiocassette or using a digital voice recorder. In addition, simplified text and reliance on universal graphic symbols will provide information to individuals with limited reading abilities.

The type and extent of the information provided will vary depending on the shared-use path, environmental conditions, and expected users. It is recommended

that the following information be objectively measured and conveyed to the user through appropriate information formats:

- Shared-use path name;
- Permitted users;
- Path length;
- Change in elevation over the total length and maximum elevation obtained;
- Average running grade and maximum grades that will be encountered;
- Average and maximum cross slopes;
- Average tread width and minimum clear width;
- Type of surface; and
- Firmness, stability, and slip resistance of surface.





# 15

# RECREATION TRAIL DESIGN

## CHAPTER

## Recreation Trail Design



**Figure 15-1.** Pedestrians of all abilities enjoy the opportunity to be out in nature, which recreation trails provide.

Recreation trails are designed to provide a recreational experience. Use of a recreation trail is a choice made by those individuals who desire the experience that the trail provides. Recreation trails should provide users with disabilities with access to the same range of trail experiences offered to other users at the site. This means that trails should be designed to reach destinations or points of interest and travel through various environments. Providing

access to people with disabilities is best achieved by providing trail information in multiple formats and by minimizing grade, cross slope, barriers, and the presence of surfaces that are soft or unstable.

Any trail that is specifically designed for pedestrian use should also be designed to provide access to people with disabilities. Trails that are not designed to provide access for pedestrians, such as single-user mountain bicycling, horseback riding, or off highway vehicle trails, do not need to be designed to provide access to pedestrians with disabilities. However, these trails should be designed to provide access to people with disabilities who will be using the equipment associated with the intended trail use, such as a mounting area or platform for equestrians who use



# 15

# RECREATION TRAIL DESIGN

## CHAPTER

wheelchairs, and amenities such as parking and restrooms should also be accessible.

### 15.1 Background information

In the past, many “accessible” recreation trails were designed with a length less than a quarter mile, no grade or cross slope, and with a wide, paved surface that made a loop around or near the parking lot, picnic area, or nature center. Individuals looking for a short, easy stroll, such as travelers who need to stretch after driving long distances, often enjoy these trails. Although these types of trails may meet the needs of some users, they usually do not provide a complete experience of the environment or elements available at the site. Therefore, it is not desirable to design all trails to these same standards. Trails that are intended to provide access to people with disabilities should be designed to provide a range of opportunities so that all trail users can experience the various environments offered at the site.

The design recommendations presented here primarily reflect the work of the Regulatory Negotiation Committee on Accessibility Guidelines for Outdoor Developed Areas (U.S. Access Board, 1999b). These recommendations, or a slightly modified version, will form the basis of a proposed rule that will be published by the Access Board for public comment. Although no trail can provide access to all individuals, trails that meet the Committee’s recommendations are considered accessible under the ADA.

It is critical that designers recognize that these specifications do not represent an exact point, beyond which the trail will be completely inaccessible to all individuals with disabilities. People with disabilities can and do use all types of trails. Some people, with and without disabilities, choose to travel on extreme trails, such as to the summit of Mt. Everest or the South Pole. Others rarely, if ever, venture off of the sidewalk, or some people have disabilities that prevent them from even going outdoors. Therefore, designers should keep in mind that some people

# 15

## RECREATION TRAIL DESIGN

### CHAPTER

with disabilities will always be able and interested in using a trail regardless of its exact design specifications. Furthermore, more people are able to enjoy different trail experiences because of advances in adaptive equipment.

Trail designers and builders should strive for maximum accessibility. However, in situations where it is not possible to fully comply with the recommended specifications for trails, designers are encouraged to comply with the recommendations to the greatest extent possible. It is essential that designers recognize the continuum of abilities among recreation trail users. The more the trail conditions vary from the recommended specifications, the larger the proportion of people who will not be able to access the trail. On trails where it is not possible to fully comply with the design recommendations, designers should ensure that the non-compliant sections are minimized in length and severity. For example:

- The trail should be free of constructed barriers, and natural

barriers should be removed if feasible.

- If the steepest grade on the trail cannot be less than 20 percent, the segment should be as short as possible and the remainder of the trail should comply with the recommendations;
- If there is a segment of trail that has a 10 percent grade for more than 9.14 m (30 ft), a level rest interval should be provided as soon as possible, and the remainder of the trail should be designed according to the recommendations;
- If there is a segment of trail that has a cross slope of more than 5 percent, the segment should be as short as possible and the remainder of the trail should follow the recommended specifications; or
- If the trail travels along a cliff, and a drop-off creates a tread width less than 915 mm (36 in), the narrow

# 15

# RECREATION TRAIL DESIGN

## CHAPTER

section should be made as wide as possible and the trail on either side of the narrow section should be designed according to the recommendations.

The proposed Accessibility Guidelines for Outdoor Developed Areas would require newly designed or newly constructed and altered portions of existing trails connecting to designated trailheads or accessible trails to comply with the proposed guidelines. The guidelines recognize that the natural environment often will prevent full compliance with certain technical provisions. Departures are permitted from certain technical provisions where at least one of four conditions is present:

- Where compliance would cause substantial harm to cultural, historic, religious, or significant natural features or characteristics;
- Where compliance would substantially alter the nature of

the setting or the purpose of the facility, or portion of the facility;

- Where compliance would require construction methods or materials that are prohibited by Federal, State, or local regulations or statutes; or
- Where compliance would not be feasible due to terrain or the prevailing construction practices.

## 15.2 Outdoor recreation access routes

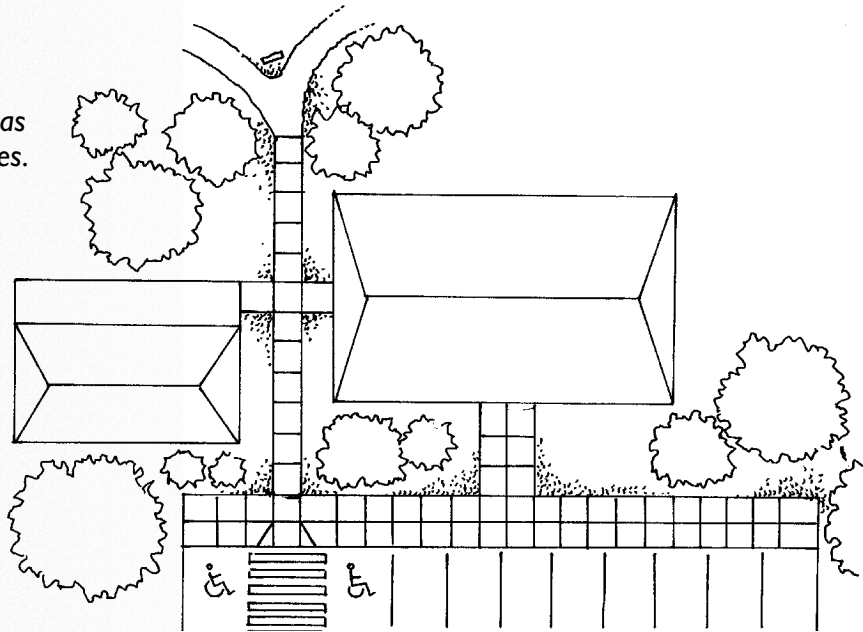
Outdoor Recreation Access Routes (ORARs) are paths that connect accessible elements within a picnic area, campground, or designated trailhead. These paths provide a means of access for people with disabilities to reach built elements that are part of the recreation experience. For example, the paths leading from the parking lot to the visitor center or to a picnic area from a campground would be considered ORARs.

# 15

# RECREATION TRAIL DESIGN

## CHAPTER

**Figure 15-2.** Outdoor Recreation Access Routes (ORARs) link together accessible elements, such as picnic areas and camp sites.



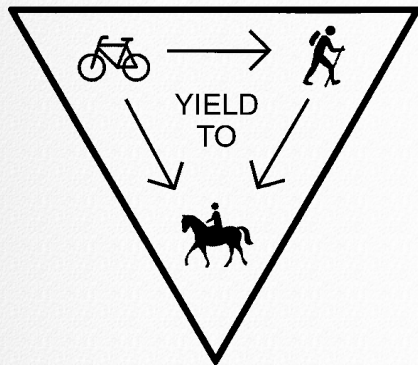
The U.S. Access Board has addressed design considerations for ORARs through the work completed by the Regulatory Negotiation Committee on Accessibility Guidelines for Outdoor Developed Areas. According to the Committee, ORARs should be designed within the following specifications:

- **Surface** — Firm and stable;
- **Clear tread width** — Minimum of 915 mm (36 in);
- **Openings** — Do not permit the passage of a 13 mm (0.5 in) diameter sphere. Elongated openings should be placed so that the long dimension is perpendicular or diagonal to the dominant direction of travel;
- **Tread obstacles** — Maximum height of 25 mm (1 in);
- **Protruding objects** — Objects between 685 mm (27 in) and 2.030 m (80 in) above the surface may not protrude into the route more than 101 mm (4 in);
- **Passing space** — 1.525 m x 1.525 m (60 in x 60 in) provided at maximum intervals of 61 m (200 ft) whenever the clear tread width is less than 1.525 m (60 in);
- **Cross slope** — Maximum of 3 percent;

# 15

# RECREATION TRAIL DESIGN

## CHAPTER



**Figure 15-3.** Recreation trails attract a variety of user groups. Providing signs that clearly indicate which users have the right of way will help mitigate conflict. Motorized recreation vehicles should be required to yield to other users.

- **Running grade** — 5 percent or less for any distance; 8.33 percent for a maximum of 15.24 m (50 ft); and 10 percent for a maximum of 9.14 m (30 ft). If the running grade exceeds 5 percent, resting intervals should be provided before and after the maximum grade segment;
- **Resting intervals** — 1.525 m (60 in) minimum in length and at least as wide as the widest portion of the trail segment leading to the resting interval with a cross slope that does not exceed 3 percent in any direction; and
- **Edge protection** — Where provided, should be a minimum of 75 mm (3 in).

### 15.3 Trail conflicts between multiple user groups

Many recreation trails attract a variety of user groups. Some trails are designed for multiple user groups; others attract a variety of users in addition to those for

whom the trail was designed. Each trail group has specific interests and needs in terms of trail design. Therefore, whenever there are multiple users on the same trail, there is the potential for conflict.

People with disabilities may be particularly affected by trail conflicts if they do not have the ability to quickly detect or react to hazards or sudden changes in the environment. To improve the trail experience for all users, including people with disabilities, designers and planners should be aware of potential trail conflicts and attempt to minimize the probability that conflicts will occur by employing innovative trail solutions. Basic conflicts can be reduced by:

- Providing information, including signage, in multiple formats that clearly indicates permitted trail users and rules;
- Ensuring that the trail provides sufficient width and an appropriate surface for all users, or providing alternate trails for some user groups,



# 15

## CHAPTER

# RECREATION TRAIL DESIGN

such as equestrians, who may have specific needs;

- Providing sufficient separation for users traveling at different speeds. For example, if volume and space permits, bicyclists and pedestrians should have different lanes or areas;
- Providing the necessary amenities for all trail users. For example, bicyclists require bicycle parking or lockers, equestrians require hitching posts and water troughs, and off highway vehicle (OHV) users require a testing circle or “landing” at the trailhead to determine if their equipment is operating correctly; and
- Considering the needs of people with disabilities within all of the user groups that are permitted on the trail. For example, individuals with disabilities may use a hand cycle or tricycle design that may not be compatible with some bicycle parking or lockers of limited width.

Similarly, an individual who uses a wheelchair may ride a horse but may be unable to dismount in order to go around or under obstacles.

## 15.4 Trail surfaces

In many situations, the condition of the surface is the most important factor in determining how easily a person with a disability can travel along a recreation trail. Surfaces that are very soft or filled with obstacles are difficult for all trail users and often exclude people with disabilities. The accessibility of the trail surface is determined by a variety of factors including:

- Surface material;
- Surface firmness and stability;
- Surface slip resistance;
- Changes in level and tread obstacles; and
- Size and design of openings.

# 15

# RECREATION TRAIL DESIGN

## CHAPTER

### 15.4.1 Surface material

There are various surface materials that can be used in outdoor environments. Recreation trail surfaces are most commonly composed of naturally occurring materials such as packed soil, grass, or rock. Some trails may use crushed stone or native soils mixed with soil stabilizing agents. However, surfaces ranging from concrete to sand may be used depending on the designated user types, the anticipated volume of traffic, the climate, and the conditions in the surrounding environment. High use trails passing through developed areas or fragile environments are commonly surfaced with asphalt, concrete, or soils mixed with stabilizing agents to maximize the longevity of the trail surface, minimize the maintenance requirements, and limit the environmental impact of the trail.

Selection of a trail surface material should be based on the type of user groups, the distance of the trail, the type of setting or experience desired, and the

characteristics of the natural environment. The surfacing material on the trail significantly affects which user groups will be capable of negotiating the terrain. Soft surfaces, such as dry sand or pea gravel, are more difficult for all users to negotiate and present particular hazards for those using wheeled devices including road bicycles, walkers, and wheelchairs not designed for rugged terrain. In contrast, other users, such as equestrians, joggers, and some people who walk with assistive devices, prefer surfaces that are not paved or very hard. Ultimately, trail designers must consider the needs of users in conjunction with the local conditions in order to determine the most appropriate surface material(s) for a trail.

### 15.4.2 Surface firmness, stability, and slip resistance

The firmness, stability, and slip resistance of the trail surface affects all users, but it is particularly important for people using mobility devices such as canes, crutches, wheelchairs or walkers.

# 15

## RECREATION TRAIL DESIGN

### CHAPTER

- **Firmness** is the degree to which the surface resists deformation by indentation when, in this case, a person walks or wheels across it. A firm surface would not compress significantly under the forces exerted as a person walks or wheels on it.
- **Stability** is the degree to which the surface remains unchanged by contaminants or applied force, so when the contaminant or force is removed, the surface returns to its original condition. A stable surface would not be significantly altered by a person walking or maneuvering a wheelchair on it.
- **Slip resistance** is based on the frictional force necessary to permit a person to ambulate without slipping. A slip resistant surface does not allow a shoe heel, wheelchair tires, or a crutch tip to slip when ambulating on the surface.

All recreation trails should be surfaced with a material that is firm and stable.

When a person walks or wheels across a surface that is not firm and stable, energy that would normally cause forward motion instead deforms or displaces the surface, so the energy is lost through slipping. Providing a firm and stable surface does not mean that only paved trails are acceptable. Crushed stone or fines, packed soil, and other natural materials can provide surfaces that are firm and stable (Table 15-1). To provide a firm and stable surface, the base material should be laid over a geotextile fabric to prevent vegetation growth. The base material must be compacted with the correct moisture content similar to the preparation of a roadbed. Finally, the proper trail surfacing material should be used. Depending on the distribution of particle sizes and the clay content of the material, a surface stabilizer may be needed to create a firm and stable surface.

Providing a slip resistant surface is also desirable, although not always possible to achieve on recreation trails. Brushed concrete and asphalt are slip resistant under dry conditions. Many soil

# 15

# RECREATION TRAIL DESIGN

## CHAPTER

**Table 15-1. Firmness, Stability, and Slip Resistance for a Variety of Common Trail Surfacing Materials**

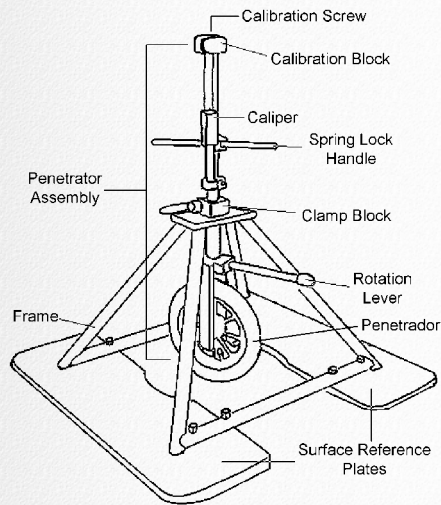
<b>Surface Material</b>	<b>Firmness</b>	<b>Stability</b>	<b>Slip Resistance (dry conditions)</b>
Asphalt	firm	stable	slip resistant
Concrete	firm	stable	slip resistant*
Soil with Stabilizer	firm	stable	slip resistant
Packed Soil without Stabilizer	firm	stable	not slip resistant
Soil with High Organic Content	soft	unstable	not slip resistant
Crushed rock (3/4" minus) with Stabilizer	firm	stable	slip resistant
Crushed rock without Stabilizer	firm	stable	not slip resistant
Wood Planks	firm	stable	slip resistant
Engineered Wood Fibers that comply with ASTM F1951	moderately firm	moderately stable	not slip resistant
Grass or Vegetative Ground Cover	moderately firm	moderately stable	not slip resistant
Engineered Wood Fibers that do not comply with ASTM F1951	soft	unstable	not slip resistant
Wood Chips (bark, cedar, generic)	moderately firm to soft	moderately stable to unstable	not slip resistant
Pea Gravel or 1-1/2" Minus Aggregate	soft	unstable	not slip resistant
Sand	soft	unstable	not slip resistant

\*A broom finish significantly improves the slip resistance of concrete.

# 15

# RECREATION TRAIL DESIGN

## CHAPTER



**Figure 15-4.** A rotational penetrometer is a portable measurement device for determining firmness and stability of trail surfaces.



**Figure 15-5.** This rotational penetrometer is testing the firmness and stability of sand.

stabilization products that are mixed with natural surfacing materials will also create a surface that is slip resistant under typical weather conditions. The U.S. Access Board (1994a) Technical Bulletin #4 addresses slip resistance in further detail.

If a firm and stable surface cannot be provided throughout the trail, the following recommendations should be considered for short distances:

- For travel over a very limited distance [less than 0.16 km (0.1 miles)] on a relatively level trail (less than 5 percent slope), a moderately firm surface may be used; and
- For travel that is primarily linear [less than 0.8 km (0.5 miles) in length], and relatively level (less than 5 percent slope), a firm but moderately stable surface may be used.

Until recently, there was not a simple, objective method for measuring trail surface firmness and stability in the field.

To address this issue, the National Institutes of Health funded a research project to develop a portable surface measurement tool. This device, the rotational penetrometer, measures surface firmness by pressing an indenter into the surface with a specified amount of force and recording the amount of displacement into the surface.

The device measures the stability of the surface by then rotating the indenter back and forth while the force is applied and recording the total amount of displacement of the indenter into the surface. The U.S. Access Board funded additional research to determine the physiological effects of surface firmness and stability on trail users. The studies led to recommendations for an objective definition of trail surface firmness (Table 15-2) and stability (Table 15-3) (Axelson, P.W. & Chesney, D., 1999). For more information about the rotational penetrometer, contact Beneficial Designs, Inc.

Ideally, all surfaces should be firm and stable under most weather conditions.



# 15

# RECREATION TRAIL DESIGN

## CHAPTER

**Table 15-2. Recommendations for Surface Firmness**

<b>Surface Rating for Firmness</b>	<b>Displacement of Caster on Portable Wheelchair Measuring Device</b>
Firm	0.3 in or less
Moderately firm	0.4 in to 0.5 in
Not firm	greater than 0.5 in

**Table 15-3. Recommendations for Surface Stability**

<b>Surface Rating for Firmness</b>	<b>Displacement of Caster on Portable Wheelchair Measuring Device</b>
Stable	0.5 in or less
Moderately stable	0.6 in to 1.0 in
Not stable	greater than 1.0 in

In general, paved recreation trail surfaces, such as asphalt, concrete, or soils or aggregates with stabilizing agents, will be firm and stable in both wet and dry conditions. Natural materials can also be bonded with synthetic materials to provide a firm and stable surface in most weather conditions. If the natural surface of the trail is not firm and stable even under dry conditions (e.g., sand, bog), the use of soil stabilizers or the construction of an imported or artificial trail surface is needed to create a more accessible surface.

In extreme climates, surfaces should provide a firm and stable surface under the predominant conditions. For example:

- Environments that are predominantly dry, such as the Sonoran Desert, should be firm and stable under dry conditions; or
- Environments that are predominantly wet, such as the rain forests of the Pacific Northwest, should provide a firm and stable surface under wet conditions.

# 15

# RECREATION TRAIL DESIGN

## CHAPTER

Soft trail surfaces should be avoided whenever possible. Not only do they limit the accessibility of the trail, but they generally require more maintenance and create a greater impact on the environment. Existing surfaces that are not firm and stable can be improved through the following recommendations:

- Improve the design of trail surfaces so that water quickly runs off to the side of the trail rather than being absorbed into the trail surface;
- If it is possible to excavate the natural trail surface, install a layer of drain rock under the surface material;
- Use a soil stabilizer or construct a raised rock surface, such as riprap or turnpike, to maintain the firmness and stability of wet areas;
- Construct a raised surface such as a boardwalk or puncheon; or
- If possible, avoid dry, sandy soils. As an alternative, consider maintaining

vegetative ground cover or building a boardwalk over the sandy surface. If trails are located on beaches, provide a beach access route and make tide information available to users so that they can travel at lower tides and make use of the firmer surface below the high water mark (see Section 17.2).

### 15.4.3 Changes in level and tread obstacles

Changes in level and tread obstacles are a safety hazard for people who use assistive devices, such as crutches, canes, scooters, bicycles, inline skates, wheelchairs, or walkers. Abrupt changes in level can cause people to trip and fall. The risk is particularly acute for individuals who have difficulty lifting their feet up off the ground, or for those who have limited vision and may be unable to detect the change in level. Catching a wheel on an obstacle or change in level can easily tip over wheeled devices as the individual's momentum continues even though the



**Figure 15-6.** This recreation trail contains many tread obstacles including tree roots and rocks.

# 15

# RECREATION TRAIL DESIGN

## CHAPTER

wheel has suddenly stopped. Minimizing or eliminating changes in level and tread obstacles will greatly improve trail safety for all users.

If changes in level or tread obstacles cannot be removed, they should be conveyed to trail users through signs, maps, or other information formats. The information should be provided at all trail access points, and should include the size, type, and location of the obstacles and any changes in level that will be encountered. Making this information available at trail entrances enables users to determine, prior to using the trail, whether they have the interest or ability to contend with the difficult environment created by the obstructions.

- Differences in the height of adjacent planks on a boardwalk;
- Uneven transitions from the trail surface to a bridge or walkway; and
- A sudden change in the natural ground level (often caused by rock outcroppings, earthquakes, or frost heaves).

Traditionally, changes in level have only been addressed when they extend across the full width of the trail so that the user is required to negotiate the change. However, any change in level is problematic for people with vision impairments because they may not detect the change in time to avoid it.

For recreation trails that have surfaces of concrete or asphalt, the changes in level should meet the recommendations used for shared-use paths. These include:

- Changes in level should not be incorporated in new construction;



**Figure 15-7.** This sudden change in the natural ground level is a potential safety hazard for hikers and other trail users.

### 15.4.3.1 Changes in level

Changes in level are defined as a difference in vertical elevation between adjacent surfaces. Examples of changes in level commonly seen on unpaved recreation trails include:

# 15

## RECREATION TRAIL DESIGN

### CHAPTER

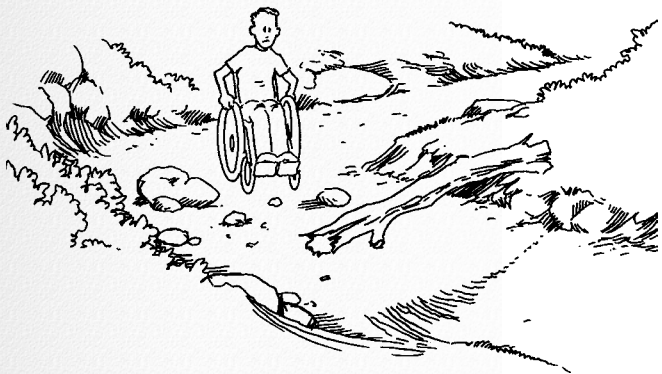
- Small changes in level up to 6 mm (0.25 in) may remain vertical and without edge treatment;
- A beveled surface with a maximum slope of 50 percent should be added to small changes in level between 6 mm (0.25 in) and 13 mm (0.5 in); and
- Changes in level such as curbs that exceed 13 mm (0.5 in) should be ramped or removed.

where a maximum height of 51 mm (2 in) cannot be attained, and the slope of the trail is 5 percent or less in any direction.

#### 15.4.3.2 Tread obstacles

Tread obstacles are objects within the trail tread, such as rocks, roots, or ruts. They differ from changes in level (e.g., stairs) in that the surfaces around the obstacle may not differ in vertical elevation. Most obstacles do not extend across the full width of the trail tread. Trail users who can move onto, over, or around the obstacle will be able to continue down the trail.

Tread obstacles on the trail surface pose a significant barrier to access. All tread obstacles are potentially hazardous for people with vision impairments who may not be able to detect the obstacle or may be unsure of the most appropriate way to avoid the obstacle. Even if an obstacle can be avoided, the maneuvering that is required means that some trail users will have to expend significantly more energy



**Figure 15-8.** The tread obstacles on this trail surface do not allow this hiker to continue travel on the trail. Even when obstacles are avoidable, maneuvering around them requires trail users to expend more energy and time.

For unpaved recreation trails, changes in level:

- Should not be created during new development or construction;
- Should not exceed 51 mm (2 in) in height on existing trails; and
- May be up to a maximum of 76 mm (3 in) in areas

# 15

## RECREATION TRAIL DESIGN

### CHAPTER

and time. The problems associated with multiple obstacles are magnified on narrow trails because the maneuvering room and clear path of travel are significantly reduced.

Most obstacles on a trail, such as rocks, occur naturally. They often develop into access barriers as a result of the soil compaction and erosion that accompanies continued trail use. Proper trail layout and alignment, with particular attention to natural drainage patterns, can minimize the development of obstacles such as ruts, entrenchments, and exposed roots and rocks. Removal of existing obstacles should be accomplished through a regular maintenance program.

Paved recreation trails should not have obstacles within the trail tread. On unpaved recreation trails, the trail tread should be maintained to provide a minimum clear (i.e., obstacle free) path of travel at least 915 mm (36 in) in width. For short distances, a minimum clear width of 815 mm (32 in) is acceptable. Obstacles over 51 mm (2 in) in height should be removed.

#### 15.4.4 Openings

Openings are spaces or holes in the tread surface. Openings may occur naturally such as a crack in a rock surface, or they may be created during construction such as spaces between the planks of a boardwalk to allow water to drain from the surface. A grate is an example of an opening that is a framework of latticed or parallel bars that prevents large obstacles from falling through a drainage inlet but permits water and some sediment to pass through. Another example of an opening is the flangeway gap at a railroad crossing.

Whenever possible, openings should not be located within the trail tread because wheelchair casters, cane tips, inline skate wheels, and bicycle tires can all get caught in trail openings. When placing openings in the trail tread is unavoidable, they should be designed according to the following recommendations:

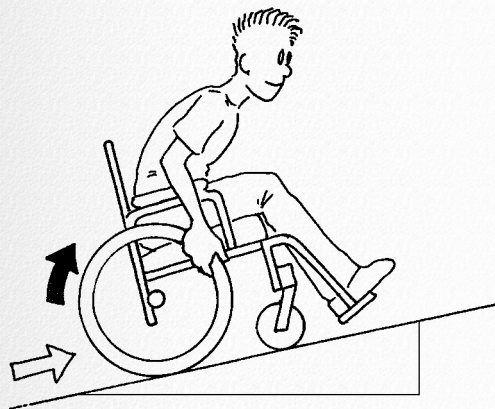
- Opening width — The size of the open space should not permit a



# 15

# RECREATION TRAIL DESIGN

## CHAPTER



**Figure 15-9.** Steep trail grades are a significant barrier to access for many pedestrians with mobility impairments.

13 mm (0.5 in) diameter sphere to pass through the opening. When the size of an opening must exceed 13 mm (0.5 in), a slightly wider gap may be created. The size of the gap should not exceed 19 mm (0.75 in.) under any circumstances.

- Opening orientation — If the open space is elongated, it should be oriented so that the long dimension is perpendicular or diagonal to the dominant direction of travel. An elongated opening may be parallel to the dominant direction of travel if the opening does not permit the passage of a 6 mm (0.25 in) diameter sphere.

## 15.5 Trail grades and cross slopes

All individuals, with and without disabilities, must exert more energy to traverse upward on sloped surfaces than on level surfaces. For some individuals, such as those who use manual wheelchairs,

the difference in energy for sloped versus level surfaces is significant. In contrast, powered wheelchair users do not exert more energy on sloped surfaces; however, they do use more battery power on steep grades and end up with reduced travel range as a result. In addition, many individuals with mobility impairments, including both powered and manual wheelchair users, are less stable on sloped surfaces.

### 15.5.1 Grade

People with mobility impairments have a difficult time negotiating steep grades because of the additional effort required for mobility. Manual wheelchair users may travel very rapidly on downhill pathways, but will be significantly slower on uphill segments. Steep running grades are particularly difficult for users with mobility impairments when resting opportunities are not provided. Furthermore, less severe grades that extend over longer distances may tire users as much as shorter, steeper grades.

# 15

## RECREATION TRAIL DESIGN

### CHAPTER

#### **15.5.1.1 Recommended grade specifications**

In general, running grades on recreation trails should not exceed 5 percent, and the most gradual slope possible should be used at all times. When trails must be built with steeper grades, it is essential that the lengths of the maximum grade segments are minimized to enhance accessibility and grade segments are free of other access barriers. Users should not be required to expend additional efforts to simultaneously deal with factors such as soft surfaces, steep cross slopes, narrow tread widths, or obstacles.

When it is not possible to have running grades that are 5 percent or less, the following recommended guidelines should be used for designing maximum grades over short intervals:

- 8.3 percent for a maximum of 61.0 m (200 ft);
- 10 percent for a maximum of 9.14 m (30 ft); and

- 12.5 percent for a maximum of 3.05 m (10 ft).

On recreation trails, a 14 percent maximum grade is acceptable for open drains when resting intervals are provided every 1.525 m (5 ft), and the maximum cross slope is 5 percent. Furthermore, the total running slope should not exceed 8.3 percent for 30 percent or more of the trail.

#### **15.5.1.2 Grades that do not meet accessibility recommendations**

Research evaluating the impact of grade on trail accessibility is extremely limited. The National Center on Accessibility supported a pilot study to examine the slopes that people with disabilities are capable of negotiating and those slopes perceived as easy to moderate (Axelson, Chesney, and Longmuir, 1995). Results of the study must be interpreted with caution because of the wide range of disabilities (none, vision impairment, ambulatory with mobility impairments,

# 15

## RECREATION TRAIL DESIGN

### CHAPTER

manual wheelchair user) among the small group of 12 participants.

Results of this research showed that participants were capable of negotiating grades of 20 percent or more for a short distance of 2.5 m (8 ft). However, while it may be possible for individuals with disabilities to negotiate a 20 percent grade with an “all out” effort, it is inappropriate for a trail to be designed with such a steep slope.

In designing trails where it is not possible to comply with the recommendations for average and maximum grade, consideration should be given to grades that the largest proportion of users will be able to negotiate. The 1995 pilot research project by Axelson, Chesney, and Longmuir was conducted over a distance of 2.5 m (8 ft) on a firm and stable (plywood) surface. The results indicated that slopes over a short distance of 2.5 m (8 ft) were rated as easy if they had a:

- Grade of 10 percent or less with no cross slope;

- Grade of 8 percent or less with a cross slope of 5 percent or less; or
- Grade of 5 percent or less with a cross slope of 8 percent or less.

Slopes over a short distance of 2.5 m (8 ft) were rated as moderate if they had a:

- Grade of 14 percent or less with a cross slope of 8 percent or less; or
- Grade of 10 percent or less with a cross slope of 12 percent or less.

Based on this information, it is clear that an 8 percent grade with a 5 percent cross slope would be considered “easy” over a very short distance [2.5 m (8 ft)]. The proposed design guidelines from the Regulatory Negotiation Committee on Accessibility Guidelines for Outdoor Developed Areas (U.S. Access Board, 1999b) allow this combination of slopes for a much longer distance [maximum of 61.0 m (200 ft)]. The perceived difficulty would be expected to increase as the distance increased.

# 15

## RECREATION TRAIL DESIGN

### CHAPTER

To further examine the effects of trail length with grade and cross slope, additional research was completed with support from the National Institutes of Health (Axelson, et al, 1998). 38 volunteers with disabilities (7 manual wheelchairs, 3 power wheelchairs, 2 crutches/canes, 8 vision impairments) and 18 volunteers without disabilities hiked sections of trail that were between 213 m and 305 m (700 ft and 1000 ft) in length. The trail sections were selected because they had relatively consistent grade and cross slope conditions. All trail sections had a non-paved but relatively firm and stable surface. The results of this research indicate that:

- Trail sections were rated as easy if they had a grade of 5 percent or less with cross slope less than 1 percent;
- Trail sections were rated as moderate if they had a grade of 8 percent or less with a cross slope of 2 percent or less; and

- Grades of 8 percent or less with a cross slope of 6 percent or less were considered moderate by most trail users, but difficult by individuals using a manual wheelchair; and
- Grades exceeding 15 percent were considered difficult by all trail users.

Comparing the results from these two studies indicates that trails designed within the proposed U.S. Access Board recommendations [i.e., grades of up to 8 percent with cross slopes of up to 5 percent for up to 61.0 m (200 ft)] would be considered moderate to difficult for most trail users. These results also indicate that the same grade and cross slope is perceived as more difficult if it continues over a long distance.

In designing trails where it is not possible to comply with the recommendations for average and maximum grade, consideration should be given to grades that the largest proportion of users will be able to comfortably negotiate.

# 15

## CHAPTER

# RECREATION TRAIL DESIGN

### **15.5.1.3 Grade transitions and rest intervals**

Before and after segments of steep grades, within 7.62 m (25 ft) of the top or bottom of a maximum grade segment, a rest interval should be provided where the running grade gradually transitions to a slope of less than 5 percent. The rest interval is not expected to be located immediately adjacent to the maximum grade segment to avoid an abrupt or rapid change in grade (see Section 15.5.1.5). Rest intervals may overlap the trail tread, but a preferable design is to have the rest interval located adjacent to the trail to enhance the safety and convenience of all trail users. A rest interval should be designed as follows:

- With a slope not exceeding 5 percent in any direction;
- On a firm and stable surface;
- With a width equal to or greater than the width of the trail segment leading to and from the rest interval;

- With a minimum length of 1.525 m (60 in); and
- With a gradual change of grade and cross slope on the segment connecting the rest interval with the trail.

### **15.5.1.4 Trails through steep terrain**

Switchbacks are commonly used in steep terrain to minimize the trail grade by increasing the length of the trail. To enhance access, the trail grades should be designed using the recommendations for maximum grade (see Section 15.5.1.1) and the turning area should have a slope not greater than 5 percent in any direction. Switchbacks should be designed to work with the natural drainage patterns of the terrain. If a switchback does not drain well, the surface will become soft or eroded, and the efforts intended to reduce the grade will actually create additional access barriers.

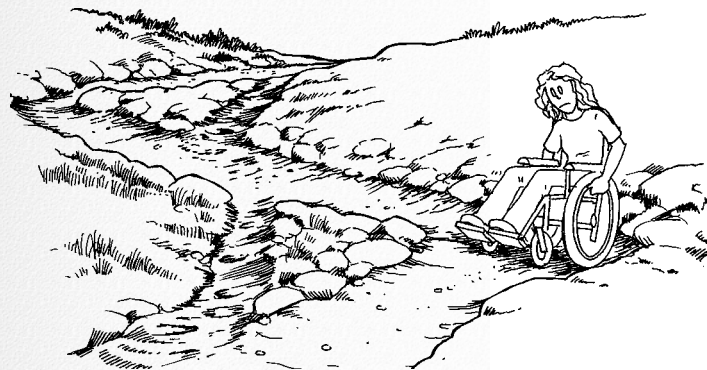
When long switchbacks are installed, natural barriers, such as rocks or thick



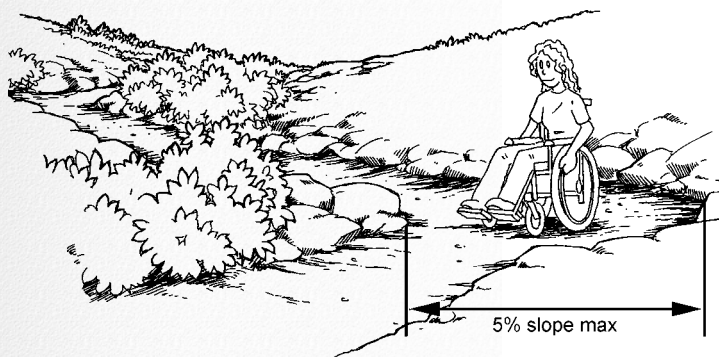
# 15

# RECREATION TRAIL DESIGN

## CHAPTER



**Figure 15-10. POTENTIAL PROBLEM:** This switchback will result in difficult travel for wheelchair users because the slope is greater than 5 percent at the turning area.



**Figure 15-11. GOOD DESIGN:** A turning area with a slope equal to or less than 5 percent in any direction enhances access on a trail with switchbacks.

vegetation, should be strategically located to prevent users who do not have difficulties with steep grades from carving a shorter path. If natural barriers are not available, installing landscaping, such as shrubs, along switchbacks is also an effective method to prevent hikers from creating way trails. A way trail is an informal path created by users that allows them to travel a shorter distance by cutting across the land between the switchbacks. Short switchbacks should be avoided because they encourage users to create way trails to avoid traversing the entire switchback. Way trails between switchbacks hasten soil erosion and destroy the surrounding vegetation.

On narrow switchbacks where bicycles are not permitted, edge protection should be provided wherever there is a severe drop off adjacent to the trail. Edge protection should be replaced with a railing if the recreation trail serves high-speed users such as mountain bicyclists. A smooth transition and a gradual change of grade from the trail grade to the switchback will also benefit users traveling at faster speeds.

### 15.5.1.5 Change of grade

A change of grade is an abrupt difference between the grades of two adjacent surfaces. When considering the needs of pedestrians, change of grade can be evaluated over a 610 mm (2 ft) interval, which represents the approximate length of a single walking pace and the base of support of assistive devices, such as a wheelchair or walker. The design recommendations for change of grade specify the relationship between two adjacent surfaces — not the actual grade of either surface.

# 15

## RECREATION TRAIL DESIGN

### CHAPTER

The exact change of grade that will be problematic varies between wheelchair users and is dependent on a variety of factors including the wheelchair design and the user's speed. Additional research is needed to provide a more comprehensive evaluation of the impact of change of grade on wheelchair users. Until more research is completed, the recommended maximum for change of grade is 11 percent. This value corresponds to the maximum change of grade permitted for the transition from the curb ramp through the gutter and onto the street (Section 7.3.7).

In the trail environment, a good understanding of the change of grade can be determined by:

- Adding the two grades together if the pre- and post-transition grades are in opposite directions (e.g., one uphill and one downhill). For example, if the first segment of trail is 8 percent and the second segment of trail is 6 percent, the change of grade would be 14 percent ( $8 + 6 = 14$ ); or
- Subtracting one grade from the other if the pre- and post-transition grades are in the same direction (e.g., an uphill followed by a significantly steeper uphill). For example, if a trail segment with an 8 percent grade leads up to a trail segment with a 15 percent grade, the change of grade would be 7 percent ( $15 - 8 = 7$ ).

A rapid change of grade may be difficult to negotiate because the footrests or anti-tip devices of a wheelchair cannot clear the ground surface. In general, wheelchair footrests are positioned low to the ground and extend beyond the front casters. Anti-tip devices are placed behind the rear axle of some wheelchairs to prevent the wheelchair from tipping over backwards. Both devices limit the clearance height of the wheelchair. At an abrupt change of grade, the footrests or anti-tip devices may contact the surface causing the wheelchair to stop suddenly or the rear wheels may lose contact with the ground.

# 15

## RECREATION TRAIL DESIGN

### CHAPTER

A further complication associated with severe changes in grade is the increased risk of tipping if the wheelchair user is traveling fast. If the footrests catch on the ground while the user is traveling fast, the momentum of the individual and wheelchair may cause the wheelchair to tip forward.

If the user moves quickly through the change in grade, the dynamic stability of the wheelchair may be compromised. Dynamic stability can be compromised because the momentum of the wheelchair will rotate backwards as the wheelchair climbs uphill. If there is a severe change in grade, this could cause the wheelchair to tip over backwards. Any amount of height difference between the two graded segments can further contribute to the stability problems experienced by wheelchair users.

An abrupt change of grade from an uphill to a downhill surface is also potentially hazardous. Although in this situation there is little or no risk of inadequate ground clearance for the footrests or anti-tip devices, an uphill

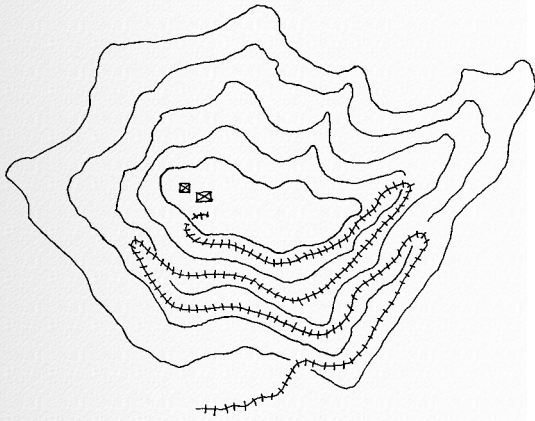
to downhill grade transition can also compromise the dynamic stability of the wheelchair. For example, when an individual travels up a steep slope, their weight is pushed back onto the rear wheels of the wheelchair. As the wheelchair transitions to the downhill slope, the weight and momentum shifts forward and down onto the smaller front caster wheels. The more abrupt the change of grade, the more sudden and forceful the transfer of momentum. If the transition is too severe, the wheelchair could tip forward.

The actual change of grade that will become problematic or potentially hazardous for any given user will depend on a number of factors including the type and setup of the wheelchair. Mountain-bike wheelchairs have a longer wheelbase and higher ground clearance resulting in greater stability and a lower probability of the footrests contacting the ground on changing surfaces. In contrast, movement of a sports wheelchair with a short wheelbase, small front caster wheels, and anti-tip devices may be compromised even when the change of grade is less than 13 percent.

# 15

## CHAPTER

# RECREATION TRAIL DESIGN



**Figure 15-12. GOOD DESIGN:** Curvilinear trails, such as converted railbeds to railtrails, follow the natural path of the environment and generally have more gradual grades.

### 15.5.1.6 Curvilinear trails

Trails should be designed so that they cross contour lines at a small angle. A curvilinear trail is one aligned to follow the natural contours of the environment. A curvilinear trail alignment will allow the trail to gain elevation gradually in conjunction with the natural contours of the terrain. This type of design generally:

- Minimizes maintenance;
- Preserves the natural resource; and
- Makes use of natural drainage patterns.

In contrast to trails that cut across natural contours, curvilinear trails usually feature natural and gradual changes in trail grade and direction. A curvilinear trail alignment is usually the best path for access.

### 15.5.1.7 Trails with steps

Steps are used in areas where the trail gains elevation quickly. A series of steps allows the remainder of the trail to have a less steep grade and reduces the risk of trail erosion or washouts. Steps may be preferred to steeply graded trail sections by individuals who use crutches or canes. However, steps create a significant barrier to individuals who use wheelchairs and should be used minimally, if at all. Steps must not be included in new construction. If steps are already incorporated into the design of existing trails, the following best practices should be implemented:

- Install a switchback or alternate side trail to allow users to avoid the steps;
- Provide signage indicating the size, number, and location of the steps along the trail at the trail entrance or trailhead; and

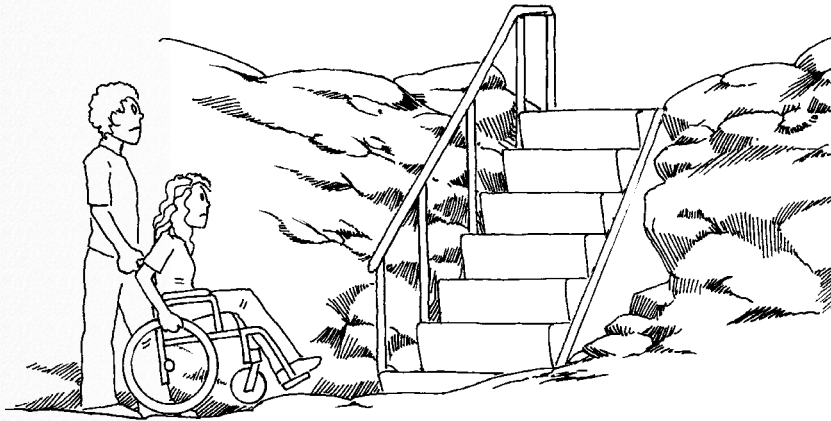
# 15

# RECREATION TRAIL DESIGN

## CHAPTER

**Figure 15-13.**

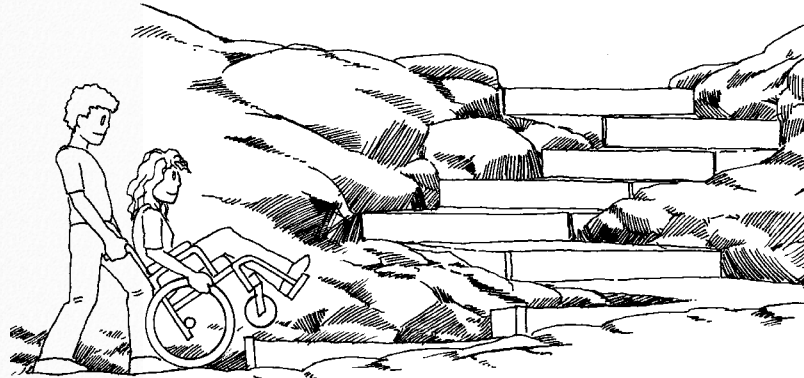
**PROBLEM:** While steps enhance access for some users, they are an access barrier for wheelchair users. If stairs are used, an alternative accessible route should be provided. A bike track should be added to stairs on multi-use paths.



- Install barriers or brush at the edge of the trail to ensure that trail users travel over the steps. If the trail is not designed to require people to use the steps, some trail users, such as bicyclists, may find ways to travel around the steps. A wheel track along the side of the stairs will encourage bicyclists to use the stairs. If many people travel around the steps, it will increase erosion, increase trail width, and decrease drainage efficiency, all of which may reduce the accessibility of the trail over the long term.

**Figure 15-14.**

**ACCEPTABLE DESIGN:** Stairs should only be installed if they serve a vital trail requirement and no alternative design will work. If stairs are installed on the trail, designers should try to minimize the height of steps and placing steps far apart. Wheelchair users will rarely be able to negotiate steps without assistance.



Most wheelchair users will not be able to traverse steps independently. Powered wheelchairs are significantly heavier than manual wheelchairs, which makes step negotiation almost impossible, even with assistance. Although all steps are problematic for wheelchair users, the design of the steps can improve access for other trail users. While stairs should not be incorporated into the design of new trails, if stairs do exist it is recommended that



# 15

## CHAPTER

# RECREATION TRAIL DESIGN

they be redesigned to increase usability. Stair access can be maximized for wheelchair users by:

- Minimizing the height of each riser; and
- Spacing risers at least 1.525 m (60 in) apart so wheelchair users and others only need to negotiate one step at a time.

### 15.5.2 Cross slope and drainage

Severe cross slopes can make it difficult for wheelchair users and other hikers to maintain their lateral balance because they must work against the force of gravity. Cross slopes can also cause wheelchairs to veer downhill. In addition, individuals using crutches often cannot compensate for the height differential created by severe cross slopes.

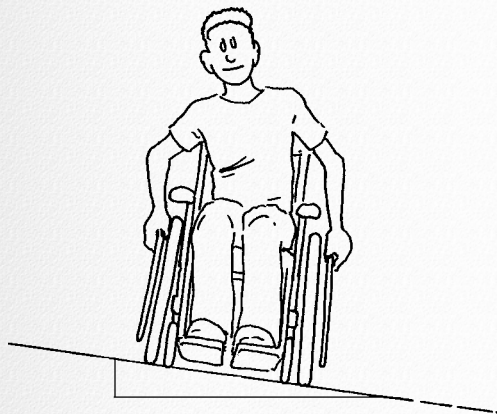
#### 15.5.2.1 Recommended cross slope specifications

Designers must balance the negative effect cross slope has on pedestrian

mobility against the necessity of including cross slope to provide adequate drainage. On most paved surfaces, 2 percent is adequate for drainage. However, cross slopes up to 5 percent may be necessary for drainage on non-paved surfaces, such as crushed limestone. Particular attention should be paid to drainage in steep terrain because the velocity of the water flow will be significant and more cross slope will be required to direct the water to the side of the trail rather than down the center of the path. If water cannot be adequately routed off an unpaved trail using a 5 percent cross slope, a more significant cross slope may be needed. Cross slopes may increase to 10 percent at the bottom of an open drain if the trail path width is a minimum of 1.065 m (42 in).

#### 15.5.2.2 Cross slopes that do not meet accessibility recommendations

Research evaluating the impact of cross slope on trail accessibility is extremely limited. Results of the pilot research supported by the National Center



**Figure 15-15.** Wheelchair users traveling on a trail with a cross slope have to use more energy to travel in a straight line to offset the force of gravity that directs them sideways.

# 15

## RECREATION TRAIL DESIGN

### CHAPTER

on Accessibility indicate that some people with disabilities are capable of negotiating cross slopes of 15 percent or more for distances of 2.5 m (8 ft) or less depending on the type of mobility impairment and assistive device used (Axelson, Chesney, and Longmuir, 1995). Recreation trails are seldom designed with cross slopes as steep as 15 percent. Therefore, designers should expect that people with disabilities will utilize every trail that they design. However, while it may be possible for some individuals with disabilities to negotiate a 15 percent cross slope over a short distance with an “all out” effort, it is inappropriate for a trail to be designed to such a standard.

In designing trails where it is not possible to comply with the recommended standards for cross slope, consideration should be given to cross slopes that the largest proportion of users will be able to comfortably negotiate. The 1995 pilot research project by Axelson, Chesney, and Longmuir was conducted over a distance of 2.5 m (8 ft) on a firm and stable (plywood) surface. The results indicated the following:

Slopes for a distance of 2.5 m (8 ft) were rated as easy if they had a:

- Cross slope of 8 percent or less with a grade of 5 percent or less;
- Cross slope of 5 percent or less with a grade of 8 percent or less; or
- Cross slope of 3 percent or less with a grade of 10 percent or less.

Slopes for a distance of 2.5 m (8 ft) were rated as moderate if they had a:

- Cross slope of 12 percent or less with a grade of 10 percent or less; or
- Cross slope of 8 percent or less with a grade of 14 percent or less.

Based on this information, a 5 percent cross slope with an 8 percent grade would be considered “easy” over a very short distance [2.5 m (8 ft)]. The proposed design guidelines from the Regulatory Negotiation Committee on Accessibility Guidelines for Outdoor Developed Areas

# 15

## RECREATION TRAIL DESIGN

### CHAPTER

(U.S. Access Board, 1999b) allow this combination of slopes for a much longer distance [maximum of 61 m (200 ft)]. The perceived difficulty would be expected to increase as the distance increased.

#### **15.5.2.3 Change of cross slope**

A change of cross slope is an abrupt difference between the cross slope of two adjacent surfaces. When considering the needs of pedestrians, change of cross slope is evaluated over a 610 mm (2 ft) interval, which represents the approximate length of a single walking pace and the base of support of assistive devices such as a wheelchair or walker. The design recommendations for change of cross slope specify the relationship between two adjacent surfaces, not the actual cross slope of either surface.

The exact change of cross slope that will be problematic varies between wheelchair users and is dependent on a variety of factors, including the wheelchair design and the user's speed. Additional research is needed to provide a more

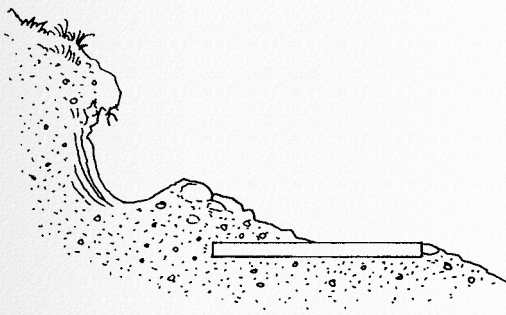
comprehensive evaluation of the impact of change of cross slope on wheelchair users. Until more research is completed, the change of cross slope should not exceed 5 percent. This means that a cross slope that changed from 2 percent to 8 percent over an interval shorter than 610 mm (2 ft) would not be acceptable. For open drains with cross slopes up to 10 percent, the change should happen gradually so that no 610 mm (2 ft) interval changes more than 5 percent.

When the change of cross slope is severe, one wheel of a wheelchair or one leg of a walker may lose contact with the ground causing the user to fall. Other walking pedestrians are also more prone to stumbling or falling on surfaces with rapidly changing cross slopes. An example of a situation where the change of cross slope might exceed 5 percent occurs at a washed out trail segment where the outslope of the trail has significantly increased due to erosion. As the wheelchair moves from the level surface of the trail to the outsloped surface, it will first balance on the two rear wheels and

# 15

# RECREATION TRAIL DESIGN

## CHAPTER



**Figure 15-16.** Erosion reduces the clear tread width of a trail limiting access for all users.

one front caster. As the wheelchair moves forward, it then tips onto both front casters and one rear wheel. During the transition, the wheelchair is only on one front wheel and one rear wheel. This transition may cause the wheelchair user to lose directional control because both rear wheels are not on the ground. This is especially dangerous at a drop-off, where the user may be at risk of falling off the edge of the trail.

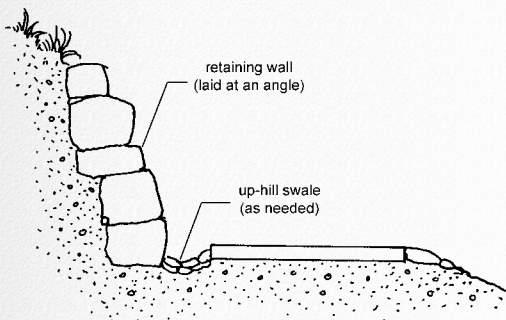
### 15.5.2.4 Minimizing erosion through natural drainage patterns

Natural drainage paths should be maintained and encouraged whenever possible. Trails should be designed to incorporate natural drainage patterns rather than trying to construct drainage channels. Trails that limit natural drainage patterns will quickly become the drainage channel, as water always seeks the path of least resistance. The trail surface provides an excellent channel for drainage because the soil is often compacted so that the trail surface is lower than the surrounding

terrain. In addition, the trail surface is relatively free of obstacles providing a clear path of travel for surface water. For these reasons, when the natural drainage channel is obstructed, the trail is where the water channels. The resulting erosion, surface saturation, and high frequency of water flow on the trail will significantly limit trail access for all users.

Erosion on a trail is usually a function of poor trail design or construction. Inaccurate consideration of soil types and natural drainage patterns are the most common causes of trail erosion. Erosion and drainage problems create barriers for all users but may be particularly hazardous for people with disabilities, who may have more difficulty avoiding the problem area. Trail designs that ensure adequate drainage and the installation of appropriate drainage control mechanisms are the most effective means of maximizing trail access.

In many instances, trail managers are left to minimize the impact of poor trail designs if there is not an opportunity to reconstruct or redesign the trail.



**Figure 15-17.** Retaining walls prevent debris from building up on the trail surface and stabilize the width of the trail.

# 15

# RECREATION TRAIL DESIGN

## CHAPTER

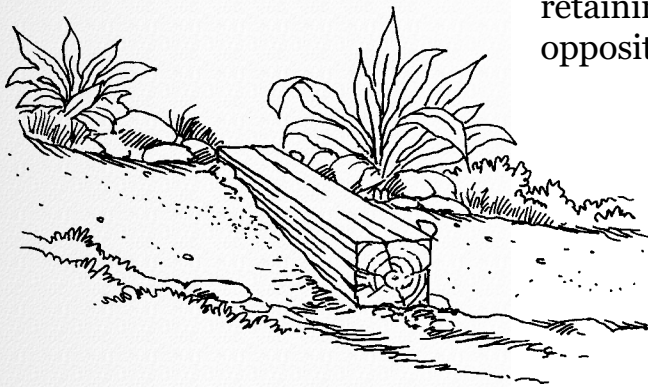
Accumulated soil or other debris on the trail poses a hazard for all users and significantly reduces the accessibility of the trail. The use of retaining walls and planting vegetation to stabilize the affected area can help to reduce the build up of debris.

Retaining walls are an effective means of preventing trail degradation. To meet the needs of people with disabilities, retaining walls should be located outside of the trail tread. Retaining walls inherently limit the ability of the trail user to move off of the beaten path. The combination of a retaining wall with a large obstacle on the opposite side of the trail bed (e.g., drop off, tree) will create a minimum passage space and may restrict access for people who require a wider trail tread, such as those who use wheelchairs. Whenever possible, the usable trail tread should be at least 915 mm (36 in) for a pedestrian trail (see Section 15.6). If the minimum passage space cannot be modified and is less than 915 mm (36 in),

information about the size and location of the minimum clear width should be provided to potential trail users so that they can avoid this frustrating or hazardous situation. The trail width information should be made available to users before they access the trail and may be provided in a variety of formats, such as signage or maps (see Section 15.8).

### 15.5.2.5 Waterbars

Waterbars are drainage structures that stretch across the width of the trail and direct water to the edge of the path. Traditionally, they have been built using a log or a piece of wood. Other designs use materials such as rocks or flexible rubber. With the exception of the rubber material, water bars tend to be obstacles for people using wheeled devices, such as bicycles or wheelchairs, because they are raised as much as 152 mm (6 in) above the tread and extend across the full width of the path. A need for waterbars indicates that the natural drainage of the terrain was not adequately considered during trail design, layout, and construction. The use of



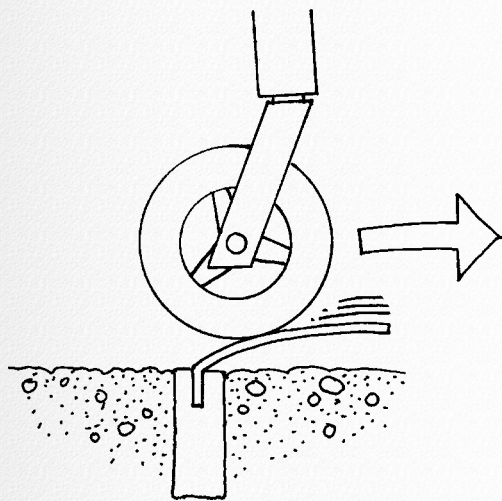
**Figure 15-18.** Non-flexible waterbars, such as a piece of wood or a log, are barriers for people with mobility impairments.



# 15

# RECREATION TRAIL DESIGN

## CHAPTER



**Figure 15-19.** Flexible waterbars control drainage on a trail and are easier for wheelchair users to travel over.

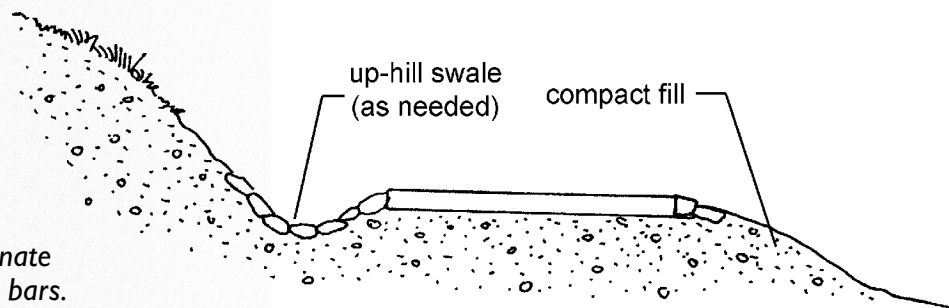
waterbars to control drainage on a trail should be minimized whenever possible with the following alternatives:

- Redesign the trail with strategic increases in grades and cross slopes to direct or sheet the water off of the trail;
- Realign the trail to take advantage of natural drainage patterns; and
- Install drainage swales or mounds (see Figure 15-22) to channel water off the trail.

At best, waterbars are a temporary solution to drainage problems. Most users will choose to travel around waterbars whenever possible, particularly if their stability or mobility is limited. Once

enough users have cut around both sides of the waterbar, it will no longer effectively drain water off the trail. In addition, all waterbars require significant maintenance to function properly. Without appropriate maintenance, deposits of sediment on the uphill side of the waterbar will increase until water can flow over the waterbar. When this occurs, water running over the bar will actually increase erosion on the downhill side.

If a waterbar is installed, the best waterbar design, from an access perspective, is the rubber waterbar. This waterbar deflects water off the trail in the same way as other waterbars, but when a user encounters it, the bar is flexible enough to collapse. Waterbars made of flexible rubber will bend under the user's weight and therefore provide greater accessibility. Rather than having to travel over a 152 mm (6 in) obstacle, a pedestrian or cyclist can travel over a nearly flattened rubber surface. To be effective, rubber water bars must be flexible enough to be pushed down easily by all users from either direction of travel.

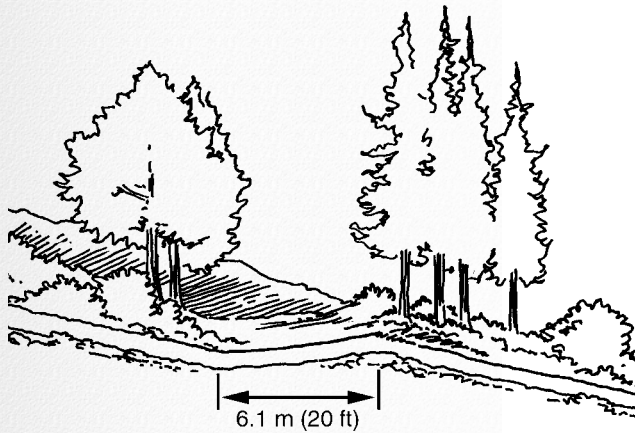


**Figure 15-20.** Swales can control drainage and eliminate the need for water bars.

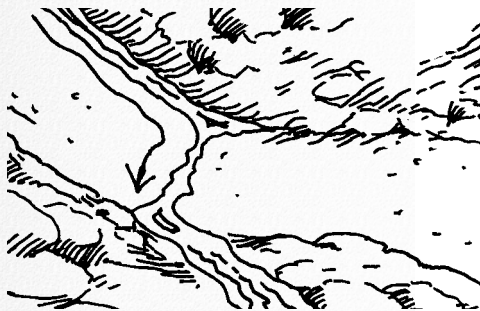
# 15

# RECREATION TRAIL DESIGN

## CHAPTER



**Figure 15-21.** When included in new construction or alterations, drainage dips can significantly improve drainage without placing an obstacle, such as waterbars, in the trail tread.



**Figure 15-22.** Drainage dips on recreation trails act as open drains. The cross slope of the open drain should not exceed 10 percent, and the clear tread width should be at least 1.065 m (42 in) minimum.

### 15.5.2.6 Trails in regions with heavy rain

Although drainage is a critical issue for the design and maintenance of all trails, it is particularly important in areas that receive high amounts of precipitation. Of greatest concern are areas that receive heavy rain events, although the effects of the spring melt in regions with significant snow accumulation can create similar problems. The following techniques can improve the accessibility of trails that receive heavy rain events:

- Installing drainage structures, such as culverts or bridges;
- Using drainage dips;
- Using swales;
- Elevating the trail on a boardwalk to ensure that

users have access to a firm and stable surface under all conditions; and

- Incorporating maximum cross slopes (no greater than 10 percent) for short distances at open drains, provided that the clear tread width is at least 1.065 m (42 in) wide.

It is vital that areas that receive large amounts of water address drainage issues during the development stage of a trail to avoid having to make retrofit improvements.

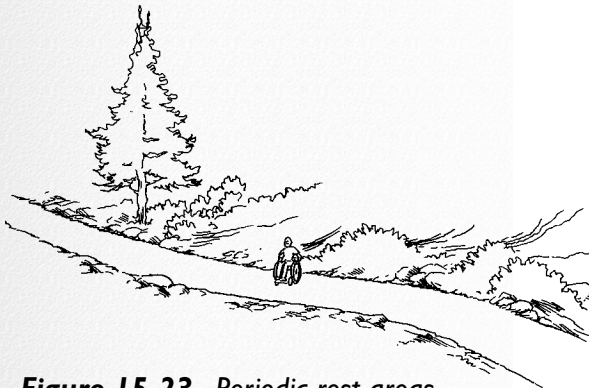
### 15.5.3 Rest areas

Periodic rest areas are beneficial for all recreation trail users, particularly for people with mobility impairments who expend more effort to walk than other pedestrians. Rest areas are especially crucial when grade or cross slope demands increase. The frequency of rest areas should vary depending on the terrain and intended use. For example, heavily used recreation trails should have more frequent opportunities for rest than

# 15

# RECREATION TRAIL DESIGN

## CHAPTER



**Figure 15-23.** Periodic rest areas are particularly beneficial to people with mobility impairments who expend more effort to walk than other pedestrians. Rest areas should be created where there is an increase in grade or cross slope.

backcountry trails with fewer users. Rest areas provide an opportunity for users to move off the trail in order to stop and rest. If a rest area is only provided on one side of the trail, it should be on the uphill side. However, separate rest areas on both sides of the trail is preferred when there is a higher volume or speed of traffic. This discourages users from crossing in front of users moving in the opposite direction.

A rest area will have many of the same characteristics as a rest interval (see 15.5.1.3), however the additional space allows for more amenities. In general, rest areas should have the following design characteristics:

- Grades that do not exceed 5 percent;
- Cross slopes on paved surfaces that do not exceed 2 percent and cross slopes on unpaved surfaces that do not exceed 5 percent;
- A firm and stable surface;

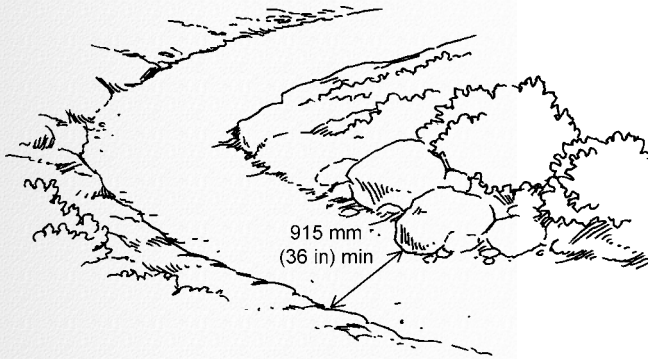
- A width equal to or greater than the width of the trail segment leading to and from the rest area;
- A minimum length of 1.525 m (60 in);
- A minimal change of grade and cross slope on the segment connecting the rest area with the main pathway; and
- Accessible designs for amenities such as benches, where provided.

Benches can be particularly important for people with disabilities, who may have difficulty getting up from a seated position on the ground. Some benches should have backrests to provide support when resting, and at least one armrest to provide support as the user resumes a standing position. Accessible seating should have the same benefits as seating for users without disabilities. For example, providing a wheelchair space facing away from the intended view would not be appropriate.

# 15

# RECREATION TRAIL DESIGN

## CHAPTER



**Figure 15-24.** If an object must protrude into the travel space, it must not extend past the minimum 915 mm (36 in) clear tread width.

### 15.6 Trail tread width

The width of the trail tread not only affects pedestrian usability but also determines the types of users that will have access. Recreation trails designed for pedestrian use should have a minimum tread width of 915 mm (36 in).

However, it is recommended that the tread width be at least 1.525 m (60 in) wide when possible. This allows space for people using assistive devices, such as a wheelchair, stroller, or walker, to easily pass one another. If a narrower passage space is unavoidable, for example between two rock beds, the trail width may be reduced to 815 mm (32 in) for short distances.

In addition to providing for clear passage, designers should also consider that most pedestrians tend to avoid path edges. They chose to travel in the center of the trail to avoid drop-offs and untrimmed vegetation. The tendency of pedestrians

to avoid the edges of a path increases the width required for a given path to be usable. In contrast, individuals with limited vision who use a cane for guidance tend to travel primarily along the edge of the trail surface, using the difference between the trail and the surrounding brush to provide direction. The movement patterns of other designated user groups should also be considered when designing the width of a trail. For example, cross-country skiers may use a lateral foot motion for propulsion that is wider than the stride of most pedestrians. The width required to accommodate this motion increases when skiers ascend grades or pick up speed. As a result, trails permitting these users should be wider than trails that are designated solely for pedestrians.

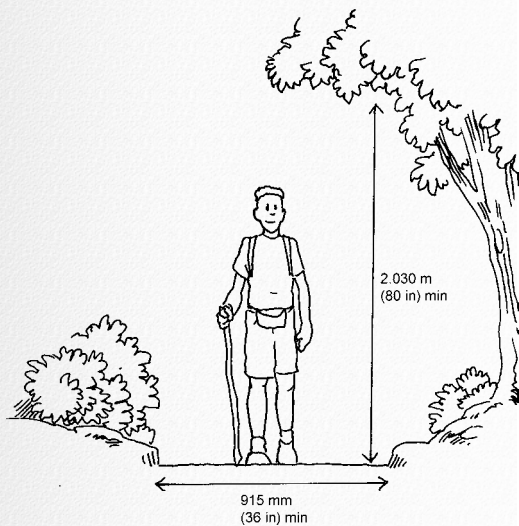
#### 15.6.1 Trails with vegetation

For all trails, the section cleared on either side of the tread width should be wide enough to prevent vegetation from encroaching on the trail between periods

# 15

# RECREATION TRAIL DESIGN

## CHAPTER



**Figure 15-25.** A clear area that is wider and taller than the trail tread width should be created to prevent vegetation, such as tree limbs, from encroaching into the trail and creating protruding objects.

of scheduled maintenance. Trails in areas with heavy vegetation require additional width on either side of the trail tread to prevent the growth of grasses or ground cover from significantly increasing the energy required to traverse the trail. Overgrowth can also hinder a user's ability to see other trail users, increasing the possibility of collisions. Overgrowth also limits a user's awareness of minor changes in the ground surface, increasing the risk of falls.

Although the extent of vegetation that must be cleared will depend on the type of vegetation, frequency of maintenance, and permitted trail user groups, the following recommendations should be considered:

- Whenever possible, the path should be cleared beyond the trail tread and above the required vertical clearance height to reduce maintenance requirements;
- At a minimum, vegetation should be cleared to the width of the beaten path and the height of the tallest user group; and

- On trails that accumulate a significant amount of snow in the winter, the clearance height should be measured from the height of the maximum snow level rather than from ground level to accommodate cross country skiers and other winter trail users.

### 15.6.2 Passing space

Periodic passing spaces allow trail users to pass one another and provide wheelchair users enough maneuvering room to turn around. Slower pedestrians benefit from passing spaces because faster users can travel by them with less disruption. On recreation trails that are narrower than 1.525 m (60 in), passing spaces should be at least 1.525 m x 1.525 m (60 in x 60 in) and should be provided at least every 305 m (1000 ft). Passing spaces should be provided more frequently if the terrain is challenging and there is no space to pull off of the trail to allow others to pass. Passing spaces should also be provided more frequently if the trail is



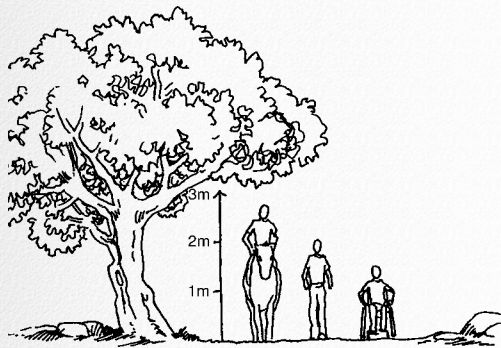
# 15

## CHAPTER

# RECREATION TRAIL DESIGN



**Figure 15-26.** Objects, such as tree limbs, that protrude into the recreation trail tread more than 101 mm (4 in) should be removed.



**Figure 15-27.** Overhead branches should be maintained to a height that is sufficient for all expected users of a recreation trail.

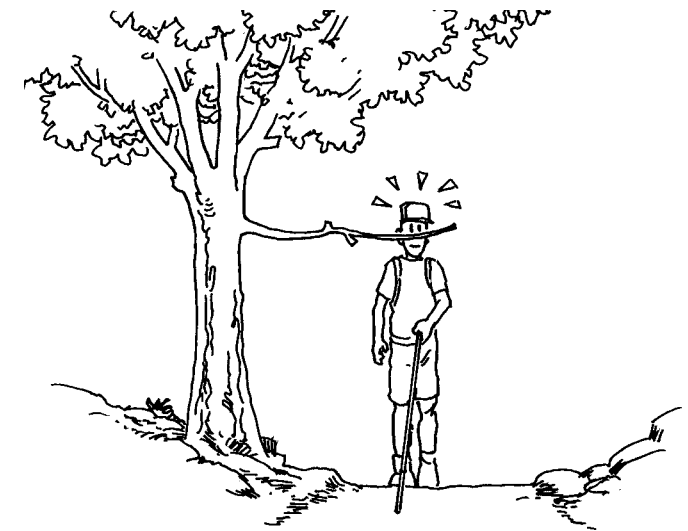
narrow and sight distances are restricted enough that a trail user may unexpectedly encounter somebody traveling in the opposite direction in an area where passing is not possible.

### 15.6.3 Protruding objects and vertical obstructions

Protruding objects are anything that overhangs or protrudes into the shared-use path tread, whether or not the object touches the surface. Examples of protruding objects include rock overhangs and tree limbs. People with vision impairments who use dog guides for navigation are able to avoid obstacles in the trail up to 2.030 m (80 in). Objects that protrude into a recreation trail but are higher than 2.030 m (80 in) tend to go unnoticed, because most pedestrians require less than 2.030 m (80 in) of headroom. People with vision impairments who use long white canes to navigate can easily detect objects on the trail that are below 685 mm (27 in). However, objects that protrude into the

pathway between 685 mm (27 in) and 2.030 m (80 in) are more difficult to detect because the cane will not always come in contact with the object before the pedestrian comes in contact with the object.

Ideally, objects should not protrude into any portion of the clear tread width of a recreation trail. If an object must protrude into the travel space, it should not extend more than 101 mm (4 in).



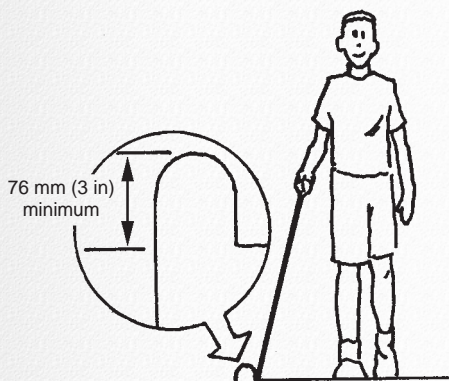
**Figure 15-28.** Objects that protrude into the pathway at a height greater than 685 mm (27 in) are difficult for pedestrians who use long white canes to detect.

# 15

# RECREATION TRAIL DESIGN

## CHAPTER

Because pedestrians with vision impairments do not always travel in the center of the trail tread, protruding objects should be eliminated from the entire tread width, as well as the clear trail width. If a protruding object cannot be removed, information about the size and location of the object should be conveyed to potential trail users before they access the trail. In addition, a barrier should be provided around the object so users will know to avoid the area. An example of a protruding object that cannot be removed would be a rock outcropping that overhangs the trail tread when the surrounding terrain does not permit the trail alignment to be changed.



**Figure 15-29.**  
A 76 mm (3 in) curb serves as effective edge protection on narrow trails and is more detectable by people with vision impairments than a shorter edge.

Trails should be built and maintained to an overhead clear height that is sufficient for all expected users of a trail. For example, equestrians require much higher clearances than pedestrians. Design of the trail clear height should also consider the user's location during all seasons and trail conditions. For example, cross country skiers may be on a "surface" that is several

feet above the same ground level that is used by hikers in the summer. A height of at least 2.5 m (96 in) should be provided for bicyclists and pedestrians, and at least 3.05 m (120 in) should be provided if equestrians or ATV riders use the path. Cross country skiers and snow machine users should have at least 2.5 m (96 in) above the average snow level. At the very minimum, recreation trails for pedestrian use only should provide 2.030 m (80 in) of headroom to protect trail users from vertical obstructions. On trails where there is the potential for emergency vehicles to gain access to areas, it is necessary to provide 3.05 m (10 ft) vertical clearance.

### 15.7 Edge protection

Edge protection serves as a barrier between the trail and the surrounding environment. Edge protection is installed to protect all trail users from a variety of elements including drop-offs and hazardous situations, such as poison oak or thermal areas. It is not necessary to

# 15

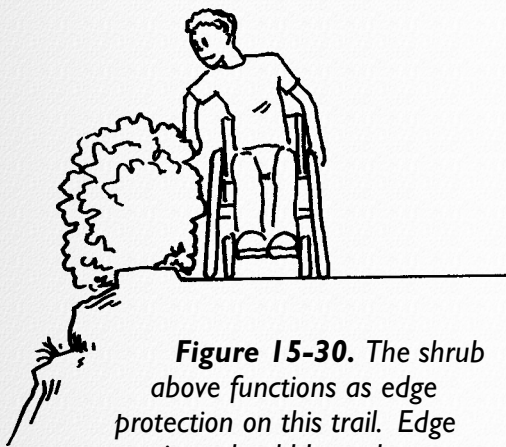
# RECREATION TRAIL DESIGN

## CHAPTER

install edge protection just because people with disabilities may be using the trail.

If bicyclists will be users of the trail, then edge protection should be a minimum of 1.066 m (42 in) high. Bicyclists are typically traveling more rapidly than other users and their center of gravity is higher. If they unexpectedly hit an edge protection that is less than 1.066 m (42 in), they are likely to flip forward into the hazardous situation.

On trails that do not permit bicycles, a variety of edge protection designs may be used; however, edge protection should generally be at least 76 mm (3 in) high. This is higher than standards for edge protection in built facilities because environments with a natural surface frequently contain small obstacles of 25 mm to 51 mm (1 in to 2 in) in height. As a result, individuals with vision impairments must adjust their obstacle detection to a slightly higher level. In addition, many wheelchairs designed for outdoor environments are capable of rolling over small obstacles, and, therefore, higher edge protection is required to ensure that it functions as intended.



**Figure 15-30.** The shrub above functions as edge protection on this trail. Edge protections should be at least 76 mm (3 in) high.

## 15.8 Signs

Signs that clearly describe the recreation trail conditions are an essential component to enhance pedestrian access. Signs should be provided in an easy to understand format with limited text and graphics that are understood by all users. Providing accurate, objective information about actual recreation trail conditions will allow people to assess their own interests, experience, and skills in order to determine whether a particular recreation trail is appropriate or provides access to them with their assistive devices. Providing information about the condition of the recreation trail to users is strongly recommended for the following reasons:

- Users are less likely to find themselves in unsafe situations if they understand the demands of the recreation trail before beginning;
- Frustration is reduced and people are less likely to have to turn around on a recreation trail because they can identify impassible situations, such as steep grades, before they begin;



# 15

# RECREATION TRAIL DESIGN

## CHAPTER

**Figure 15-31.** The symbols above have been included in the report of the Regulatory Negotiation Committee on Accessibility Guidelines for Outdoor Developed Areas. One of these symbols or a similar symbol will be selected to indicate a trail that meets the accessibility provisions for trails (U.S. Access Board, 1999b).



These are symbols that could be used to represent a trail that fully complies with Section 16.

- Users can select recreation trails that meet their skill level and desired experience;
- The level of satisfaction increases because the user is able to select a

recreation trail that meets his or her expectations; and

- If more difficult conditions will be encountered, users can prepare for the skill level and equipment required.

The Regulatory Negotiation Committee on Accessibility Guidelines for Outdoor Developed Areas specifies that a trail that meets accessibility provisions be designated with a universally understood symbol for “accessible trail.” The exact design of the symbol has yet to be developed, but several possible designs were included in their report.

In addition to the universal symbol, objective information about the trail conditions (e.g., grade, cross slope, surface, width, obstacles) should be provided. This information is needed regardless of whether or not the trail is accessible. Objective information is preferable to subjective trail difficulty ratings (e.g., easier, most difficult) because subjective ratings of difficulty typically

# 15

# RECREATION TRAIL DESIGN

## CHAPTER



**Figure 15-32.** This sign at the Merced River Trailhead in Yosemite National Park allows users to assess whether or not the trail will meet their personal interests, experience, and skills by providing objective trail access information.

represent the perceptions of the person making the assessment and cannot be accurate or appropriate for the range of trail users. Individuals with respiratory or heart conditions as well as individuals with mobility impairments in particular are more likely to have different interpretations of trail difficulty than other users.

A variety of information formats may be used to convey objective trail information. The type of format should conform to the policy of the land management agency. For example, one agency may choose to provide trail information at the trailhead, while another may provide trail information at their visitor center. Written information should also be provided in alternative formats, such as Braille, large print, or an audible format. For example, the text of a trailhead sign made available on audiocassette or a digital voice recorder can be used to play the message with the touch of a button. In addition, simplified text and reliance on universal graphic symbols greatly enhances the comprehension of individuals with limited reading abilities.

The type and extent of the information provided will vary depending on the trail, environmental conditions, and expected users. For example, trails that attract predominantly experienced users and located in areas with few safety considerations may require fewer signs containing less detailed information than trails likely to be used by inexperienced people located in areas that will expose users to potential hazards. It is recommended that the following information should be objectively measured and conveyed to the trail user through appropriate information formats:

- Trail name;
- Permitted users;
- Trail length;
- Change in elevation over the total trail length and maximum elevation obtained;



# 15

## RECREATION TRAIL DESIGN

### CHAPTER

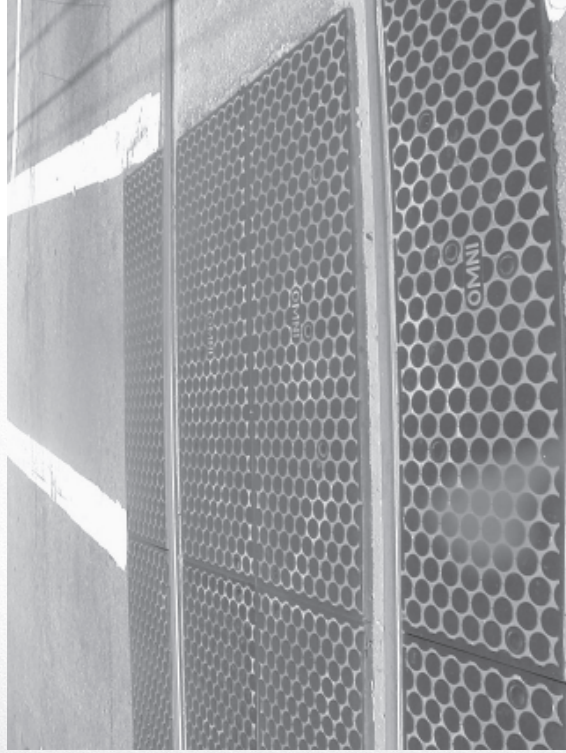
- Average running grade and maximum grades that will be encountered;
- Average and maximum cross slopes;
- Average tread width and minimum clear width;
- Type of surface;
- Location and length of any soft or unstable surfaces; and
- Size, location, and frequency of obstacles.

# Trail Crossings

accessibility. In addition, design elements, such as clear sight lines and accessible information, should also be incorporated. The following chapter provides specific design recommendations for the following types of trail crossings:

- Trails intersecting other trails;
- Bridges;
- Trails intersecting streets and roadways;
- Grade separated crossings; and
- Railroad crossings.

At a trail crossing, users may change directions, encounter other user groups, experience a narrower or wider trail width, or encounter automobile traffic. Designers should carefully develop trail crossings to ensure that they are accessible to the full range of trail users. It is recommended that any type of trail crossing be designed using right angles to maximize visibility and



**Figure 16-1.** Installing a rubber surface rather than asphalt on a shared use path is an example of how rail crossings can be improved for pedestrians.

The following chapter applies to recreation trails and shared use paths. The term *trail* is used to address both types of outdoor pathways. If a design strategy does not apply to both shared use paths and recreation trails, a specific remark will be provided.

### 16.1 Trail crossing another trail

At the intersection of two trails, different user groups often meet one another. To enhance safety, users should be aware that they are approaching an intersection and there is a potential for encountering users from a variety of directions. This can be done through a combination of signs and unobstructed sight lines. To accomplish unobstructed sight lines, trails should intersect at 90-degree angles. Furthermore,

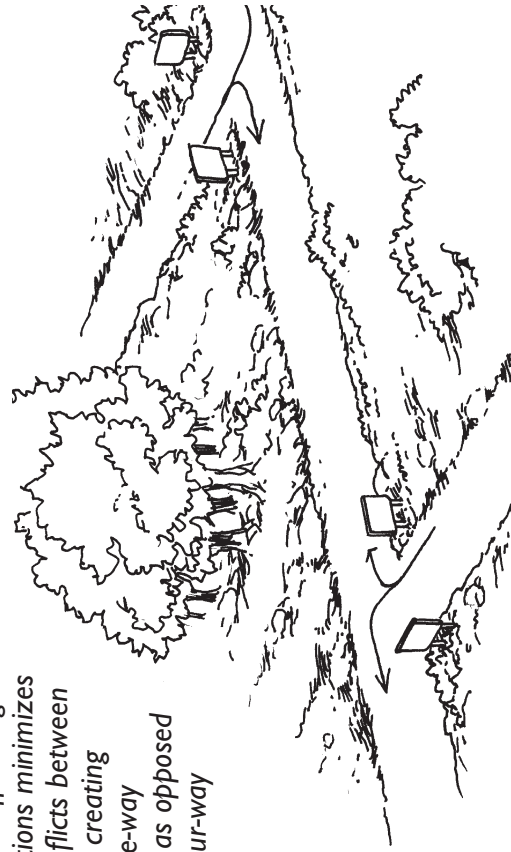
designers should verify that sight lines are unobstructed from both a seated and a standing position. If the trail also includes equestrians, higher sight lines should be cleared. On shared use paths, longer sight lines should be provided for users, such as bicyclists, that may be traveling at higher speeds.

In addition to clear sight lines, other design strategies can also be implemented to reduce conflicts at trail intersections, including:

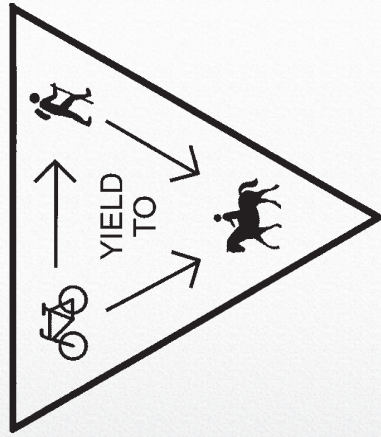


**Figure 16-2.** Clear sight lines and signage should be provided when trails intersect other trails to avoid conflicts between user groups.

**Figure 16-3.** Off-setting trail intersections minimizes potential conflicts between trail users by creating multiple three-way intersections as opposed to a single four-way intersection.







**Figure 16-4.** When a trail intersects another trail, providing signs that clearly indicate which users have the right of way will help mitigate conflict.

- Off-setting the trail intersection and creating two three-way intersections rather than one four-way intersection;
- Designing a level and smooth physical connection between the two trail surfaces;
- Providing signs at the intersection that clearly indicate the desired direction of travel, user right-of-way, and the numerous possible destinations and their distances;
- Providing sign formats in high use areas, such as audible recording devices, that are accessible to

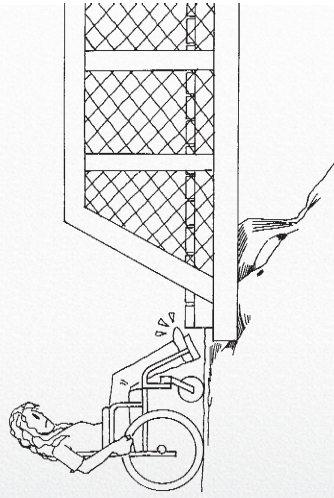
- individuals with vision impairments and those who have a limited ability to read text;
- Clearly indicating, through signs or barriers, the allowed user groups; and
- Providing signage with Trail Access Information to communicate grade, cross-slope, trail width, and obstacle information.

## 16.2 Bridges

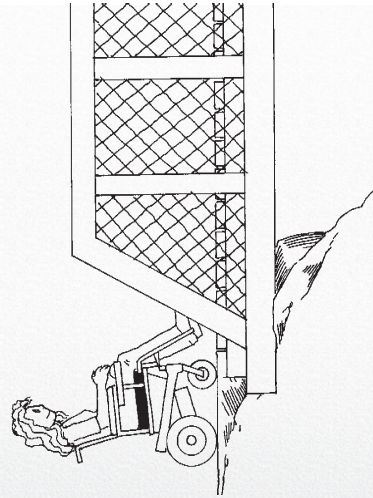
Bridges are common trail structures used to traverse waterways or other trail barriers, such as ravines or rivers. Bridges should be designed for the various types of anticipated trail users. Additional skills and abilities should not be necessary to negotiate the bridge. For example, a trail that provides adequate tread width and access to pedestrians with mobility impairments should not rely on a log bridge or step stone crossing. The following considerations should be included when designing bridges:



**Figure 16-5. PROBLEM:** The design of a trail crossing should be consistent with the trail leading up to it. In this illustration, a split log crossing is provided, but a bridge would be more appropriate.



**Figure 16-6. POTENTIAL PROBLEM:** If the bridge is not flush with the trail surface, people with mobility impairments may be denied access.



**Figure 16-7. GOOD DESIGN:** Bridges that are flush with the trail surface provide greater access to trail users.

- **Change in level** — Bridges should be flush with the trail surface;

- **Handrails** — Handrails should be considered to protect all bridge users and provide a gripping surface to maintain balance or support. If handrails are provided, they should be designed according to ADAAG 4.26; the top rail should be at least 1.1 m (43 in) above the ground;

- **Alignment** — Bridges should be aligned so that users can adequately see and prepare for the transition between the trail and bridge. Steep ramps or steps should be avoided at the bridge approach;

- **Dimensions** — On shared-use paths, bridges should be as wide as the path with a 610 mm (2 ft) buffer on either side. Ideally, bridges on recreation trails should also be as wide as the paths leading up to

them; however, a minimum width of 915 mm (36 in) is critical. Bridges should be wide enough to accommodate the type of trail user, such as bicyclist, snowmobile, and all terrain vehicle driver; and

- **Bridges** — Bridges should not be arched but have flat grades.



**Figure 16-8. GOOD DESIGN:** On this outdoor recreation trail, the width of the bridge is consistent with the width of the trail leading up to the bridge.



### 16.3 Trail intersecting a roadway

Trails intersecting a street create a greater safety hazard than intersections with other trails because of the higher volume and speed of the street traffic. In order to maximize the safety and accessibility of trail-to-street intersections, the following trail design considerations are recommended:

- The trail should intersect the street at a 90-degree angle;
- Increase trail width at the intersection to reduce user conflicts;
- Provide good sight lines for both motorists and trail users;
- Provide signage to ensure that motorists are aware of the trail crossing;
- Provide a visible crosswalk across the intersection to increase trail user and motorist awareness.

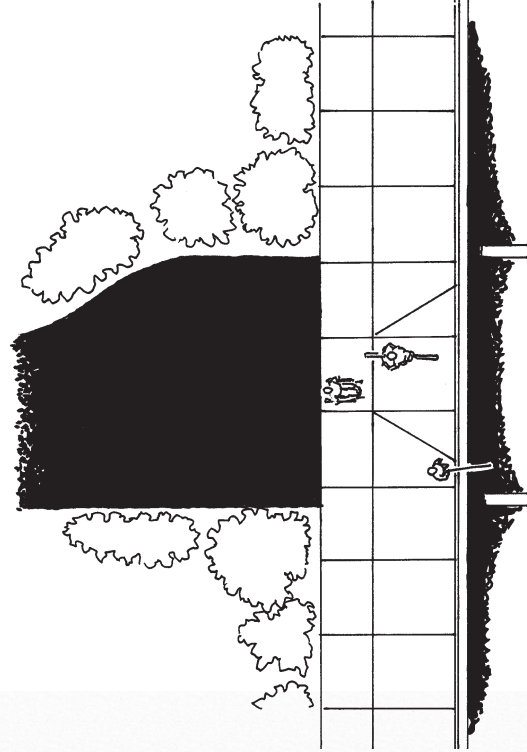
- Signs, both on the road and the trail, should clearly indicate whether motorists or trail users have the right of way; and
- Use curb ramps as required and include detectable warnings to ensure that trail users with vision impairments are aware of the street. Curb ramps should be designed and located in accordance with Section 16.3.1.

At a road and trail intersection, raising the level of the road up to the level of the trail can eliminate the need for curb ramps and contributes to traffic calming because of the raised crosswalk that is created (see Section 8.4). If this design is used, detectable warnings should be included between the edge of the trail and the roadway to ensure that users with vision impairments can identify the intersection.

### 16.3.1 Use of curb ramps on trails at intersections

When trails intersect roads, the design of trail curb ramps should, as a minimum, follow the recommendations provided in Chapter 7, with the exception of ramp width. The width of the ramp should be at least as wide as the average width of the trail to improve safety for users who will be traveling at various speeds. In addition, the overall width of the trail should be

increased, so the curb ramp can be slightly offset to the side. The increased width reduces conflict at the intersection by providing more space for users at the bottom of the ramp. Apply truncated domes when providing a wider curb ramp width. The offset design of the curb ramp allows individuals with vision impairments to follow a straight path of travel to a curb. In general, curbs are more detectable for people with vision impairments than curb ramps. If the offset design cannot be used and the curb ramp must extend the full width of the beaten path, a detectable warning should be provided to alert users with vision impairments to the changing conditions (see Chapter 6, Accessible Information).



**Figure 16-9. GOOD DESIGN:** Curb ramps on trails should be slightly offset whenever possible to reduce conflict at an intersection and make it easier for people with vision impairments to detect the street.

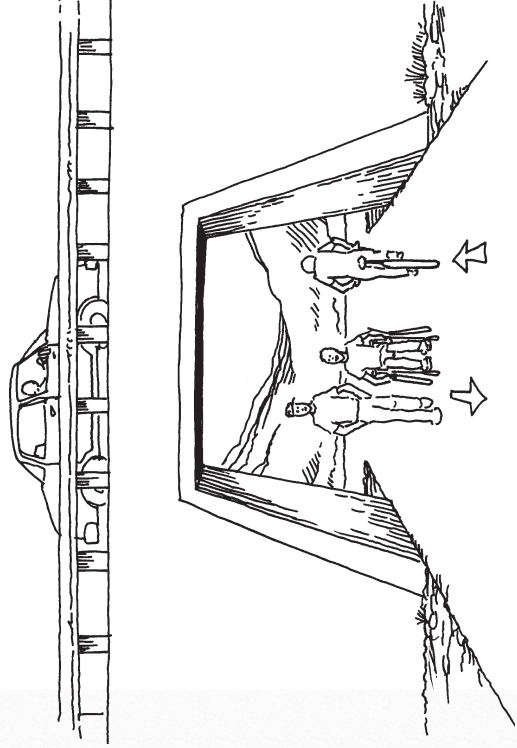
### 16.4 Grade separated crossings

If a grade crossing between a trail and a street is not desirable, a grade separated crossing should be considered. In most situations, motorists will cross at grade and the trail will be routed over or under

the roadway. However, designers should also consider allowing the trail to cross at grade and create an underpass or overpass for motorists. Refer to Section 4.6 for additional information on designing grade separated crossings. When the trail is rerouted, the grade separated crossings must be accessible (any constructed facility must be accessible). The choice of an underpass or overpass is largely determined by the terrain, type of trail/road use, and available funding.

In most cases, underpasses provide a greater level of access because the required elevation changes are usually less severe than changes for an overpass. When an underpass is used, attention must be paid to:

- **Sight lines** — Sight lines should be unobstructed from both a seated and standing position. Good sight lines are essential for a safe path of travel and they provide a greater sense of security;
- **Level of illumination** — Lighting within the underpass should be bright to accommodate the needs of people with vision impairments and increase comfort levels for all pedestrians. Indirect lighting, such as that reflected off the underpass walls or ceiling, minimizes shadows and glare, which benefits users with vision impairments; and
- **Vertical clearance** — Additional vertical height should be provided at an underpass to enhance user



**Figure 16-10. GOOD DESIGN:** A well designed underpass is well lit and provides additional vertical clearance to account for the vertical shy distance.



### 16.5 Trail intersecting a railroad

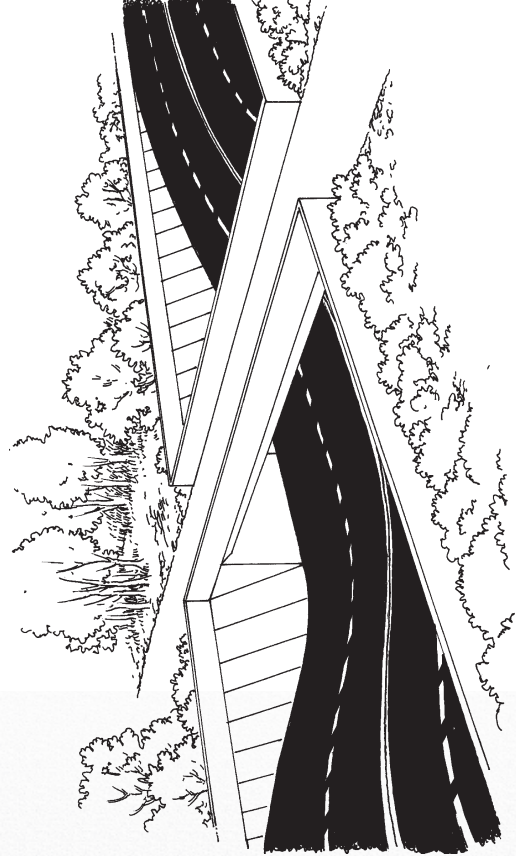
Trails that cross railroads pose potential hazards to all trail users, but particularly those who rely on wheeled forms of mobility because the size of the flangeway gap 51 mm (2 in) exceeds the recommended width for openings 13 mm (0.5 in). Getting a wheel caught in the flangeway gap is a safety hazard (for more information, see Section 8.11).

To minimize the impact of the flangeway gap, it is important that trails should intersect the tracks at a right angle. In addition, the following design strategies should be used:

- Approaches to the track and the area between the tracks should be raised to the level of the top of the rail because rail ties that are not flush with the travel surface create a tripping hazard, in addition to the gap hazard. A surface material that will not buckle, expand, or contract significantly (e.g., textured rubber railroad crossing pads) should be used;

comfort. This additional height is often referred to as vertical shy distance. At least 3.05 m (10 ft) is recommended.

If an overpass is selected, long approaches or switchbacks should be used to maintain grades that provide access to people with mobility impairments.



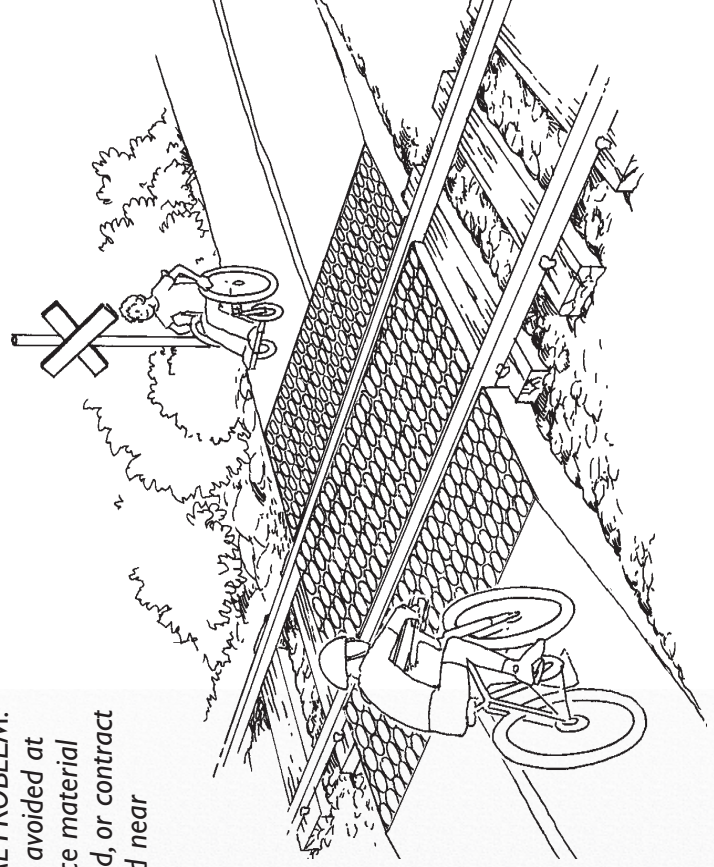
**Figure 16-11.**  
GOOD DESIGN:  
In some situations,  
designers should consider  
allowing the trail to cross  
at grade and creating an  
underpass for motorists.



**Figure 16-12. POTENTIAL PROBLEM:** Broken surfaces should be avoided at railroad crossings. A surface material that will not buckle, expand, or contract significantly should be used near railroad tracks.

- Approaches to the track should be ramped with minimal grades and should be flat for a distance of 5 feet on either side of the tracks, free of obstacles, and have a firm and stable surface;

- For recreation trails, the trail surface should be hardened to reduce the debris that scatters over the tracks as users pass;
- Sight lines and signage should ensure that all users, and particularly those with disabilities affecting hearing, vision, or mobility impairments, have adequate warning about the intersection; and
- Signals and/or gates should be considered to warn trail users of the rail crossing.

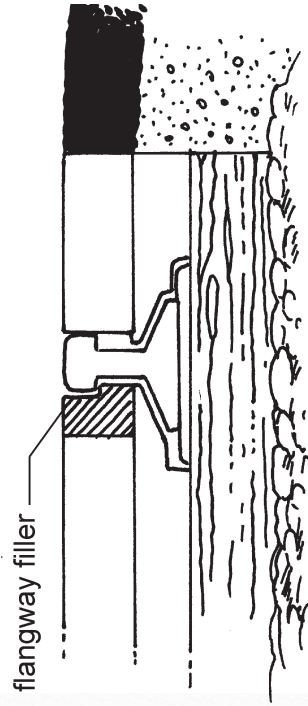


**Figure 16-13. GOOD DESIGN:** The approaches to the railroad tracks and the area between the tracks should be raised to the level of the top of the rail.

Currently there are no design strategies that can completely eliminate the flangeway gap for high speed, regulation size trains. The gap could be eliminated in the future with further research to develop a system similar to what is currently available for low speed, light rail trains. A rubber insert is available to fill the flangeway gap for light rail tracks that have trains traveling at low speeds



**Figure 16-14.** The above "flangeway filler" eliminates the gap in the path of travel for pedestrians when crossing railroad tracks. The filler, consisting of a rubber insert, will deflect downward with the weight of a train and, therefore, does not affect low speed rail function.



(e.g., approaching a transit stop). The flangeway fillers provide a level surface for pedestrians and other trail users but deflect downward with the weight of the train. In this way, pedestrians have a "gap free" surface and the trail and rail function is unaffected.

# Specialized Trails



**Figure 17-1.** Interpretive trails are specialized trails that provide educational information to trail users. All trail information should be provided in formats that are accessible to people with vision impairments.

Many trails provide a unique experience for the user. Trails can provide an educational experience to learn about the natural environment or history and culture of the people who inhabited the area. Other trails are designed to lead the user to a particular destination to see unique features or spectacular views. In this section, the focus will be on designing these various types of trail experiences so that all may benefit from and enjoy the opportunities regardless of their abilities.

## 17.1 Viewpoints

Viewpoints and scenic overlooks should be designed so that everyone has the same opportunities for looking at the intended area. For example, if a high barrier made of a solid, opaque material, such as a stone wall, protects the viewpoint, people who use wheelchairs, adults of small stature, and children may be excluded from enjoying the view. In addition, the height of other types of barriers, such as safety railings, may prevent many users from enjoying the view.

To create a viewpoint that provides access to everyone, designers should adhere to the following recommendations:

- Depending on the location and purpose of the viewpoint, it should be located along a pathway that meets or exceeds the design recommendations for outdoor recreation access routes (ORARs), shared-use use paths, or recreation trails;

# 17

## SPECIALIZED TRAILS

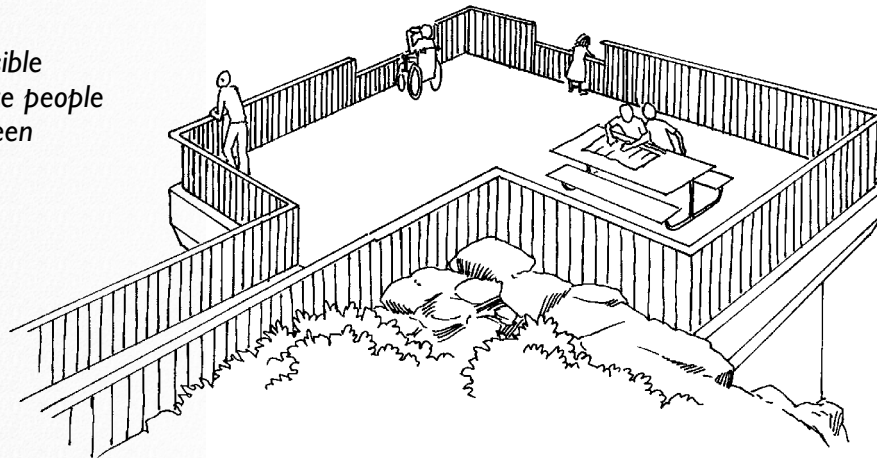
### CHAPTER



**Figure 17-2.** Scenic lookouts should provide a lowered viewing area for children, people who use wheelchairs, and people of short stature.

- Each location that provides a viewing opportunity to one or more distinct points of interest should have at least one unrestricted viewing area;
- Unrestricted viewing should allow visibility for eye levels between 815 mm and 1.295 m (32 in and 51 in). Varying the heights of telescopes should provide opportunities for those of lower stature;
- The surface at the viewpoint should be firm, stable, and free of obstacles; and
- If turning is required, at least 1.525 m x 1.525 m (60 in x 60 in) should be provided to allow wheelchair users enough room to maneuver.

**Figure 17-3.** GOOD DESIGN: Accessible viewpoints accommodate people whose eye level is between 815 mm and 1.295 m (32 in and 51 in).



The type of trail that is built leading to the viewpoint is dependent on where the viewpoint is located. For example, where a trail exists solely as a connection between a transportation stop, such as a parking lot and the viewpoint, the trail should be designed using the recommendations for outdoor recreation access routes (See Section 15.2). If the trail is a recreation opportunity itself, and the viewpoint is just one of the features included in the trail experience, then the trail leading to it should be designed according to the recommendations for shared-use paths or recreation trails.



# 17

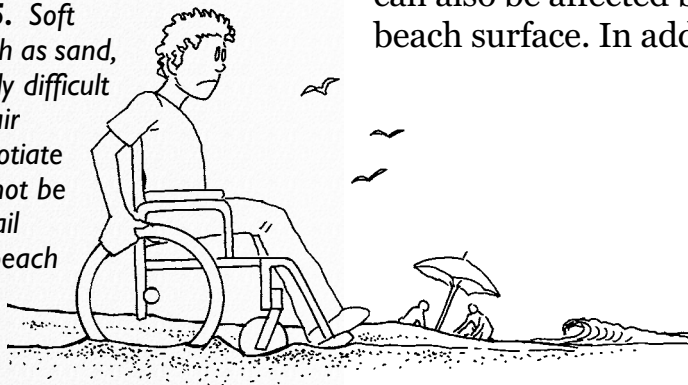
## CHAPTER

# SPECIALIZED TRAILS



**Figure 17-4.** Unimproved paths, such as the one pictured here, typically connect the off-beach facilities, such as parking, playgrounds, or concession stands, to the edge of the beach. Beach paths with improved access should be designed at regular intervals along a beach.

**Figure 17-5.** Soft surfaces, such as sand, are extremely difficult for wheelchair users to negotiate and should not be used as a trail surface for beach access.



## 17.2 Beach trails

Anyone who has traveled along a sandy beach knows how much energy and strength is required to travel on dry sand, loose gravel, or other soft surfaces. For people with mobility impairments, sand surfaces make both movement and balance almost impossible. Since the sand does not provide a firm surface, standard assistive devices will sink into the surface, requiring the user to spend more energy lifting and moving the device. Small-wheeled devices, such as wheelchairs, walkers, inline skates, skateboards, and strollers, will be virtually immovable on sand. Balance can also be affected by the instability of a beach surface. In addition, as the unstable surface changes in response to each user, the surface becomes deformed and uneven, which contributes to a further lack of stability and balance.

### 17.2.1 Beach access route specifications

In the past, beach paths were limited to pathways that connected the off-beach facilities, such as parking, playgrounds or concession stands, to the edge of the beach. Except where a wharf or dock facility was provided, access across the beach surface was typically left to the discretion of the user. For people with mobility impairments, this situation effectively eliminates access to the water or facilities that are located on the beach surface (e.g., beach furniture or volleyball courts). To increase beach access for people with mobility impairments, a beach access route should be provided. The beach access route should cross the surface of the beach and extend to the high tide level, mean river bed level, or the normal recreation pool level. One beach access route should be provided for every 0.8 linear kilometers (0.5 miles) of beach, and should be connected to an outdoor recreation route.

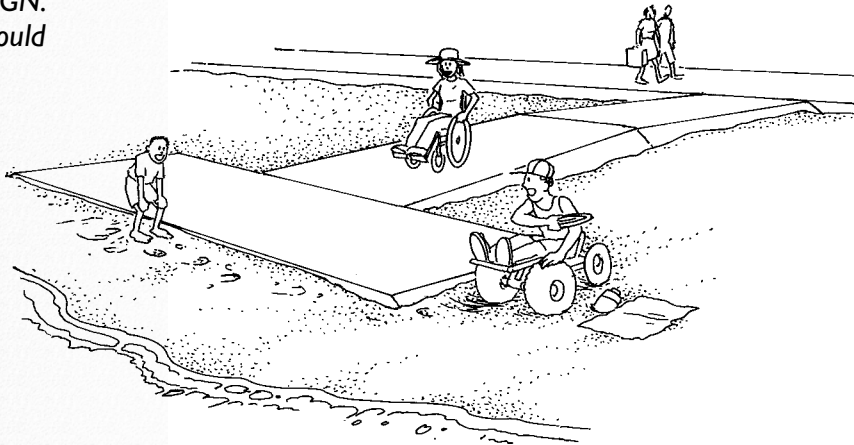
Beach access routes should be designed according to the following

# 17

## SPECIALIZED TRAILS

### CHAPTER

**Figure 17-6. GOOD DESIGN:** Permanent beach paths should be firm and stable to allow people with mobility impairments to fully enjoy the beach environment.



specifications, which are based on the report of the Regulatory Negotiation Committee on Outdoor Recreation Areas (U.S. Access Board, 1999):

- **Surface** — Firm and stable;
- **Clear tread width** — Minimum of 915 mm (36 in);
- **Openings** — Do not permit the passage of a 13 mm (0.5 in) diameter sphere. Elongated

openings should be placed so that the long dimension is perpendicular or diagonal to the dominant direction of travel. If openings must run parallel to the path of travel, a 6.5 mm (0.25 in) sphere should not be able to pass through;

- **Protruding objects** — Objects between 685 mm (27 in) and 2030 mm (80 in) above the surface should not protrude into the route more than 100 mm (4 in);
- **Passing space** — 1.525 m x 1.525 m (60 in x 60 in) should be provided at maximum intervals of 61 m (200 ft) whenever the clear tread width is less than 1.525 m (60 in);
- **Maneuvering/Resting space** — 1.525 m x 1.525 m (60 in x 60 in) should be provided at the high tide level, mean river bed level, normal recreation water level, or end of the beach access route and should not overlap the beach access route;



# 17

## SPECIALIZED TRAILS

### CHAPTER

#### Case Study 17-1

Laquillo Beach Bathing Park, on Puerto Rico's northeast coast, has created a "Sea Without Barriers" through Transportation Enhancement funding. It is a recreational facility that provides access for wheelchair users. A system of ramps leading from the parking lot to a protected platform in the ocean enables a person in a wheelchair to enter into the water.

- **Running grade** — 5 percent or less for any distance; 8.33 percent for a maximum of 15.24 m (50 ft); and 10 percent for a maximum of 9.14 m (30 ft). If the running grade exceeds 5 percent, resting intervals should be provided before and after the maximum grade segment;
- **Cross slope** — Maximum of 3 percent to ensure proper drainage. A maximum of 5 percent may be permitted if needed to ensure proper drainage;
- **Changes in level** — Maximum height of 25 mm (1 in); and
- **Edge protection** — If the edge of the beach access route has a drop-off of 152 mm (6 in) or greater, an edge protection that is a minimum of 51 mm (2 in) in height should be provided. If the drop-off is greater than 25 mm (1 in) but less than 51 mm (6 in), the edge should be beveled.

#### 17.2.2 Selecting surface materials

In tidal areas, the sand exposed during low tide is typically hard packed and firm. Making information about tide times widely available will help visitors make optimum use of the firm surface. In addition, a variety of surfaces can be used for beach access routes to provide pedestrian access. It is important that the surface be kept free of loose sand and drifts; otherwise the surface of the routes ceases to provide a means of access to the beach. The following surface materials could be considered for beach access paths:

- Asphalt, concrete, or soil stabilizers can be used to create a beach access route. Performing routine maintenance to ensure that the softer areas do not erode away from around the hardened surface will be necessary. It is recommended that the beveled edge of the path extend a minimum of 152 mm (6 in) below the soft surface of the beach; or

# 17

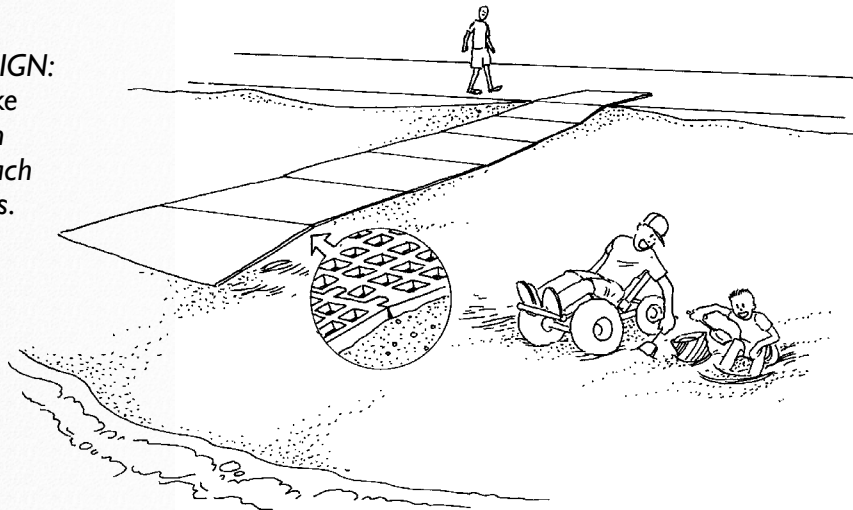
## SPECIALIZED TRAILS

### CHAPTER



**Figure 17-7. GOOD DESIGN:** This temporary beach access route crosses the surface of the beach and extends to the high tide level.

**Figure 17-8. GOOD DESIGN:** Temporary beach paths, like this removable surface, can be laid out to enhance beach access for wheelchair users.



- Wood, concrete, or aggregates can be used to create a raised trail surface, boardwalk, or walkway. In designing a raised surface, the impact of the path on traffic patterns along the beach surface should also be considered.

### 17.2.3 Considering temporary paths

Rather than creating a permanent path, the installation of a temporary path may be preferred at some beaches. A variety of carpet or mat materials are commercially available and provide a firm, stable, and temporary surface in beach environments. If beach access is provided via a temporary path, it should be available whenever the beach is open. It is unacceptable for people to have to wait or to be denied access while a temporary path is installed after they arrive. When determining whether to rely on a temporary path, the following factors should be considered:

- Are staff readily available to install, remove, and ensure the integrity of the temporary path? The action of waves and shifting of the sand can quickly create an uneven surface.
- Does the opportunity or potential for property to be damaged or stolen exist in the particular location? Temporary surfaces laid out across

# 17

## CHAPTER

# SPECIALIZED TRAILS

the sand are also prone to theft and vandalism.

- Do the beach conditions vary enough that the optimal path location may change on an hourly, daily, or seasonal basis? In areas with extreme tides, a permanent path may, at times, be submerged or end a long distance from the water's edge.
- Will seasonal variations in climate affect the integrity of the path from year to year? Winter ice levels are often much higher than summer water levels. Tremendous forces can be exerted as the ice shifts, breaks up, or moves away.
- Will travel patterns on the beach surface be interrupted or limited by a permanent path? Installation of a permanent beach access route will limit use of that section of beach for other recreational activities such as volleyball, football, or Frisbee.

### 17.2.4 Providing beach wheelchairs

Beach areas that provide recreational equipment, such as surfboards, may consider providing a beach wheelchair, in addition to providing a beach access route. Having a beach wheelchair available provides additional access to areas of the beach that are not connected with beach access routes; however, it does not satisfy the requirement to have beach access routes. There are several beach wheelchair models that are commercially available. Most feature oversized tires and some models allow for the user to independently propel the beach chair.

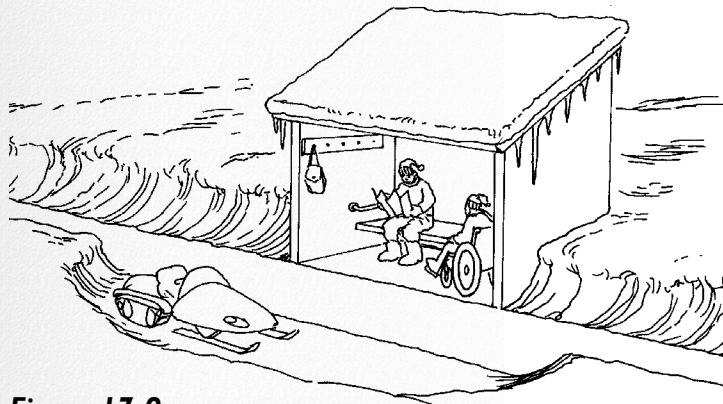
### 17.3 Trails in extreme climates

Trails in extreme climates can present additional challenges to some users with disabilities. Extreme climates can include places that receive heavy snow or rain, deserts with little available water, areas that experience very cold temperatures or high winds, and areas that experience very hot temperatures or high humidity. Some individuals with disabilities are

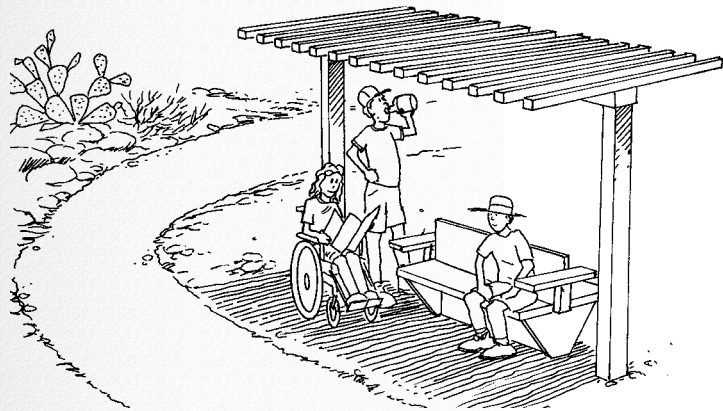
# 17

## SPECIALIZED TRAILS

### CHAPTER



**Figure 17-9.**  
Trails located in cold climates should provide sheltered rest areas to act as insulation and protection from the weather.



**Figure 17-10.**  
In hot climates, frequent rest areas provide shaded relief for trail users.

particularly susceptible to thermal injuries, such as hypothermia and heat stroke, and face increased risks and discomfort.

Trails in areas with extreme climates should be designed to maximize the ability of users to adequately prepare for expected conditions and minimize the personal risks involved in trail use by providing:

- Information warning of conditions, such as extreme temperatures, severe wind or sun exposure, lack of drinking water, or sites where water is available;
- Shelters for shade and insulation from the weather;

- Amenities, such as drinking water, weather information, or emergency shelters that are accessible to people with disabilities; and
- Regular maintenance of facilities that provide services such as drinking water or shelter.

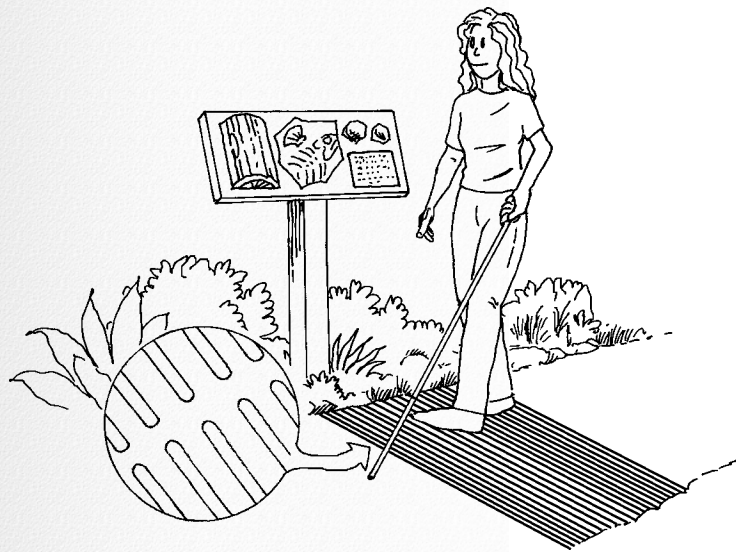
### 17.4 Interpretive trails

Interpretive trails are those that provide information about the environment to the user, usually through signage located along the trail or the availability of interpretive brochures. Incorporating opportunities for people to use multiple senses can enhance the interpretive trail experience for all users, regardless of abilities. Objects that can be examined or manipulated by the users should be durable enough to withstand handling by many people. Bronze castings of buildings or objects can provide information to the user about their shape, size, and location. Three-dimensional relief maps of a feature

# 17

## SPECIALIZED TRAILS

### CHAPTER



**Figure 17-11.** In hot climates, frequent rest areas provide shaded relief for trail users.

or the terrain are also useful in providing an overall description or directions within an area.

Information that is conveyed to trail users in written formats, such as signage or maps, should also be provided in alternative formats, such as audio, Braille, or large print. Audible formats benefit people of all ages and abilities who may not read text or Braille. On interpretive trails, wayfinding

information can be used to identify points of interest for users with vision impairments. Key points of interest can be identified using a raised tactile surface, such as raised directional tiles (see Section 6.4). However, tactile surfaces and other wayfinding strategies on interpretive trails are only useful to people with vision impairments if they understand what the information means. For example, if raised directional tiles are used, information about the meaning of the change in surface should be provided to the user before embarking on the trail. This can be conveyed through recorded audio information, remote infrared audible signage, or Braille.





# Trail Maintenance

thickness, as well as the thickness of the recreation trail or shared-use path surface, are important in reducing future repairs. Considering the types, sizes, and weights of vehicles that may need access to the trail for maintenance or emergencies will be helpful in reducing the damage that may occur to the trail.

All facilities, including recreation trails and shared-use paths, require regular maintenance to reduce the damage caused over time by the effects of weather and use. Many maintenance issues can be reduced if properly addressed in the planning and designing phases before construction even begins. Outslotted trails generally provide adequate drainage of water, however unique situations will require careful planning and design to handle the damage that can be done by water. Adequate subgrade preparation and

Proper maintenance is essential to promote user safety, to ensure ease of access, and to encourage the use of a designated route. The Department of Justice implementing regulations for the ADA require all accessible features and facilities to be maintained in operable working condition for use by individuals with disabilities (U.S. Department of Justice, 1991b). Accessible designs are useless if maintenance is neglected and trails are allowed to degrade to a state where they cannot be used or must be avoided during travel. Maintenance strategies should be included in the preliminary planning stages of new construction and alterations. Maintenance plans should also be created to address existing facilities. The extent and



**Figure 18-1.** Obstacles, such as fallen trees, should be removed to maintain the tread in a condition that can be negotiated by all trail users.

frequency of maintenance schedules will vary greatly depending on the location, amount of use, and resources available for the trail. It is recommended that a plan be developed that clearly specifies the frequency of maintenance and how reported maintenance concerns will be handled.

- Management agency staff may identify sites requiring maintenance.

For a maintenance program to be effective, it must identify conditions that can impede access for people with disabilities and quickly respond with prompt repairs. Any citizen complaints reported should be given first priority for repair.

## 18.1 Facility maintenance

### 18.1.1 Assessment techniques

To maintain recreation trail or shared-use path conditions, current and potential problems should be identified through an objective assessment process. There are many methods available for identifying maintenance needs on existing trails. For example:

- The Universal Trail Assessment Process (UTAP) records and prioritizes maintenance needs on trails (see Chapter 13);
- Users may identify and report maintenance problems; and

### 18.1.2 Shared-use path maintenance

Shared-use paths should be maintained to ensure that they continue to provide access to all pedestrians. Shared-use paths with a hardened surface, such as asphalt or a stabilized surface, may require sealing or recoating at periodic intervals. Shared-use paths should be inspected for conditions that are likely to inhibit access or cause user injuries. The following list of maintenance problems is based on information generated by the Bureau of Maintenance in the city of Portland, Oregon,(1996) and the Division of Engineering for the Lexington–Fayette County Urban Government (1993):



- **Step separation** — A vertical displacement of 13 mm (0.5 in) or greater at any point on the path that could cause users to trip or prevent the wheels of a wheelchair, bicycle, inline skates, or strollers from rolling smoothly;
- **Vegetation overgrowth** — Ground cover, trees, or shrubs on properties or setbacks adjacent to the path that have not been pruned can encroach onto the path and create obstacles.

### 18.1.3 Recreation trail maintenance

- **Badly cracked pavement** — Holes and rough spots ranging from hairline cracks to indentations wider than 13 mm (0.5 in);
  - **Spalled areas** — Fragments of pavement or other building material detached from larger structures;
  - **Settled areas that trap water** — Depressions, reverse cross slopes, or other indentations that make the path lower in specific areas. These depressions trap silt and water on the path surface;
  - **Tree root damage** — Roots from trees growing in adjacent landscaping that cause the surface to buckle and crack; and
- Regular recreation trail inspections can help managers identify public safety issues, routine maintenance needs, and resource management problems. A system to assess and catalog problems on recreation trails should be used to obtain a comprehensive list of potential maintenance items. Having a comprehensive list of sites needing maintenance also helps trail managers prioritize and budget for trail repair and improvement projects. Once identified, these problems can be scheduled for correction through a maintenance program. When a recreation trail has been severely damaged, rerouting might be considered.

Recreation trail maintenance activities include a number of preventative and corrective actions (Beers, 1993):

- Checking the structural integrity of all built trail features such as bridges, steps, and railings and recording any repairs required;

- Keeping the tread surface free of obstacles or hazards, such as downed trees and landslides. Removing loosened rocks and earth in a disturbed area, and restoring the trail tread to its intended state;

- Clearing and maintaining drainage features to minimize trail erosion and environmental damage. Using drainage methods causing the least impact on the natural environment. These methods include:
  - Clearing channels;

- Maintaining an outslope on the trail bed;
  - Cleaning drainage dips or water bars;
  - Clearing parallel ditches; and
  - Cleaning culverts through or beneath the trail.
- Cutting brush to define the established trail and/or protect adjacent resources;
  - Maintaining the tread in a condition that can be negotiated by trail users by:
    - Restoring sloped or crowned surfaces to facilitate drainage;
  - Extending the trail back to its original width;
  - Filling ruts and holes; and
  - Restoring raised approaches to bridges.



## 18.2 Information maintenance

In addition to maintaining the physical characteristics of shared-use paths and recreation trails, agencies should also maintain information regarding trail conditions. Access information is useless if it is not accurate, and it may even be dangerous if users attempt to negotiate trails that are beyond their ability level. Trails should be periodically reassessed to verify that conditions have not changed. Reassessment every three years is recommended for recreation trails and shared-use paths that are unpaved. Assessment data should also be verified after a catastrophic event, such as a flood or an earthquake.

Signage should comply with ADAAG specifications. In general, signage should be reevaluated periodically and replaced when age and weathering reduces legibility. The design of the sign should consider the information that is being displayed, as well as actions taken to reduce theft or vandalism. Signs should be

removed when their messages are no longer needed or the information has changed.

## 18.3 Citizen reporting

Those responsible for recreation trail and shared-use path maintenance should provide users with a convenient means to report sites in need of maintenance. The following techniques have been used successfully by a variety of municipalities to obtain maintenance input from users:

- Publishing a comprehensive maintenance guide, with easy to follow guidelines that highlight the maintenance goals and procedures;
- Using mass mail to send self-addressed stamped forms for requesting a repair. For example, the Maine Department of Transportation's "Spot Me" program (see Figure 10-4) sends residents a postcard asking for small repair/improvement suggestions

along bikeways. This type of a program could be used to improve shared-use path or recreation trail access;

- Using additional signs, or adhesive stickers attached to existing signs, to instruct users on how to submit maintenance/improvement requests;
- Periodically placing information flyers in local newspapers; and
- Making maintenance information available at public and school libraries.

Citizen Report Programs can provide agencies with an efficient way of maintaining facilities. Users can often identify issues in a quicker manner than agencies.

People who take the time to submit problems to the appropriate agency need to have a timely written response or see fairly quick results to feel their efforts were worthwhile. If timely action or notification of pending action is not taken, participants could become frustrated and be less likely to spend time in the future identifying problems. If reported problems and issues are scheduled to be resolved in an upcoming project, then the citizen should be notified with the upcoming plan.

# Research Recommendations

This guidebook represents what we know about current accessible design practices. Very little research has been conducted on the physiological impacts of one design over another. Most information is anecdotal or based on personal experience. In addition, few systems exist that can quantitatively measure the conditions of sidewalks and trails. As improving pedestrian access becomes a more integral part of good design, a quantitative understanding of what people can and cannot negotiate will become critical.

Some standards, such as reach ranges, were based on the evaluations of disabled veterans. Men with developed upper body strength have a longer reach range than

a smaller child or an adult with limited upper body movement. The population is growing older, and a person that becomes disabled at an older age is more likely to have less ability than a younger person who develops a disability. It will be important to evaluate future needs and identify missing gaps in the research. As opportunities increase, it's important to widen the range of access to all users. The following items were identified as planning and design topics that warrant further investigation:

1. Develop educational programs about pedestrian access for students and professionals in fields that share roles in the



- planning, design, and construction of public rights-of-way.
2. Develop design strategies for improving pedestrian access at roundabouts. Currently, most roundabouts in the United States are difficult for people with vision impairments to use because they cannot determine when it is safe to cross the street. European and Asian designs, such as the Swedish model, which use pedestrian-controlled traffic signals and set the crosswalks back four car lengths from the intersection, should be investigated.
  3. Conduct research that identifies strategies for installing and maintaining detectable warnings in climates with harsh weather conditions. Detectable warnings indicating the transition between the sidewalk and the street provide critical information to people with vision impairments.
  4. Analyze intersections to establish guidelines for when accessible information is needed and what type of signal is most appropriate. Develop National standards for specifications of features to be included in pedestrian signals for full access.
  5. Standardize sign formats for people with vision impairments.
  6. Evaluate the impact that right turn on red has on pedestrians, including those with vision impairments, and establish guidelines for when this practice should and should not be permitted.
  7. Evaluate the prototype Sidewalk Assessment Process (SWAP) presented in Chapter 11 as both an assessment tool and an access information dissemination tool.
  8. Evaluate the effects of various traffic calming applications on the disabled, the elderly, and children.

9. Develop signs and mapping formats that provide access information to sidewalk users.
10. Develop consistent and reliable methods to assist transportation agencies with the development of Americans with Disabilities Act transition plans. The ADA mandates municipalities to complete a self-assessment as part of their transition plan to identify discriminatory practices. However, no specific guidelines currently exist for evaluating sidewalk conditions.
11. Develop information systems to better inform citizens of places that are readily accessible. All elements, such as accessible offices, stores, routes, parking spaces, etc., should be highlighted. Such an information system should be readily accessible, easy to understand, and regularly updated as the transition plan for existing facilities unfolds and new construction is built.
12. Develop designs for drainage systems that are compatible with gutter and curb ramp installations.
13. Investigate the potential for broadcast signs that give routine information to pedestrians on sidewalk elements through handheld receivers.
14. Develop effective strategies to enhance the detectability of motor vehicles in slip lanes, such as acoustic surfaces, and include research on effects of acoustic surfaces on bicyclists.
15. Evaluate current wayfinding strategies for sidewalks and trails, such as intersection guidestrips, and develop standardized design guidelines.
16. Develop methodologies to analyze existing shared-use paths to determine if the needs of pedestrians are being addressed.



17. Research and develop design solutions for access at all railroad crossings. The flangeway filler used to service low speed light rail trains at railroad crossings provides a good access solution.
18. Develop standardized construction barricade systems that assure consistency and promote safety for all users.
19. Re-evaluate the existing American Association of State Highway and Transportation Officials (AASHTO) guidelines for the turning radius at an intersection in order to better balance the needs of pedestrians with the needs of long trucks.
20. Develop new surfacing technologies that will provide alternatives to asphalt and concrete for firm and stable surfaces. Alternative surfacing is desired on outdoor recreation trails and other instances where asphalt or concrete fundamentally alters the experience.
21. Define a standard for the levelness of outdoor surfaces. Many stone or rock paths and uneven tile surfaces provide a historic or decorative look while causing a rough ride for wheelchair users and a tripping hazard for others.
22. Establish and enforce minimum requirements for surface firmness and stability. Use objective measures, such as the ANSI/RESNA standards, as the basis for these requirements and the disclosure of information of outdoor recreation trails.
23. Provide data evaluating pedestrian exposure both before and after various roadway and crossing applications are installed.
24. Examine the effects of large curb radius vs. small curb radius on motorists' behavior towards pedestrian right-of-way.

25. Evaluate the impact of guidestrips on bicyclists.
26. Evaluate the ability for the visually impaired to accurately recognize signal changes in various instances.
27. Evaluate the impact of thermoplastic materials and inlay tapes on slip resistance. While these materials are more desirable because they last longer than paint, they reduce the slip resistance for pedestrians and bicyclists. Materials that can be added to thermoplastics and inlay tapes to improve slip resistance should also be considered.
28. Develop a universally designed barrier/gate that restricts access by non-pedestrian user groups but does not restrict access by people with mobility impairments.
29. Encourage the development of universal designs in the pedestrian environment.
30. Evaluate the effects of motor vehicle speed on pedestrian gap detection at various intersection applications.

# Appendices

Appendix A: Sidewalk Assessment Process Forms

Appendix B: Sidewalk Accessibility Checklist

Appendix C: Contact Information

Appendix D: Detectable Warning Manufacturers

Appendix E: Slope Conversion Chart

Appendix F: Abbreviations and Acronyms

Appendix G: Glossary

Appendix H: Bibliography



# A

## APPENDIX

# Appendix A

## Sidewalk Assessment Process Forms

- Stroll Sheet
- Intersection Checklist
- Curb Ramp Element Analysis Form
- Driveway Crossing Element Analysis Form
- Cut-Through Median Element Analysis Form
- Ramped Median Element Analysis Form



# A

## APPENDIX

### Stroll Sheet

#### STROLL SHEET FOR SIDEWALK ASSESSMENT PROCESS (SWAP)

Block name: \_\_\_\_\_ Starting X street: \_\_\_\_\_ Ending X street: \_\_\_\_\_ R/L side Page \_\_ of \_\_

##### Curb Ramp Measurements:

CR Distance m	Number of Ramps #	Type ( L   D C B )	Approach Slope %	Ramp Slope %	Ramp Length cm	Landing Length cm	Detectable Warning y/n

##### Station Measurements:

Distance m	Design Width cm	Cross Slope %	Running Grade %

##### Feature Measurements:

Feature Distance m	Feature	Dimension	Units	Comments

##### Notes:

**Feature codes:**  
 DC = Driveway  
 MG = Maximum Grade  
 CL = Change in level  
 PO = Protruding Object  
 MCW = Minimum clearance width  
 MCS = Maximum cross slope  
 MVC = Minimum vertical clearance  
 RCCS = Rapidly changing cross slope

Appendix A.

**Intersection Checklist:**

Name of primary street:	
Name of cross street:	
Total number of lanes on primary street:	
Total distance across primary street (measure with rolatape):	
Total number of lanes on cross street:	
Total distance across street (measure with rolatape):	
Are there any left turn only lanes?	yes---no
Are there any right turn only lanes?	yes---no
Is a right turn on red permitted?	yes---no
Is there a right turn island?	yes---no
Is parking permitted on the primary street?	yes---no
Is parking permitted on the cross street?	yes---no
How many corners have curb extensions (bulbouts)?	
Is there a median?	yes---no
If so, is it designed as a pedestrian refuge?	yes---no
Is it identifiable to people with vision impairments?	yes---no
Is it accessible to people with mobility impairments?	yes---no
Does the intersection have four way stop signs?	yes---no
Does the intersection have two way stop signs?	yes---no
Is the intersection signalized?	yes---no
Is there a pedestrian actuated control signal?	yes---no
Location of control:	
Information emitted: audible    vibrotactile    infrared	
Is there a high contrast between the button and post color?	yes---no
Is there a tactile arrow indicating the street crossing direction?	yes---no
Height of control:	
Dimension of pedestrian button?	
Is 5 lbs of force or less required to operate the signal?	yes---no
Is the crosswalk marked?	yes---no
If so, what are the conditions of the markings?	
Duration of WALK interval:	
Comments:	

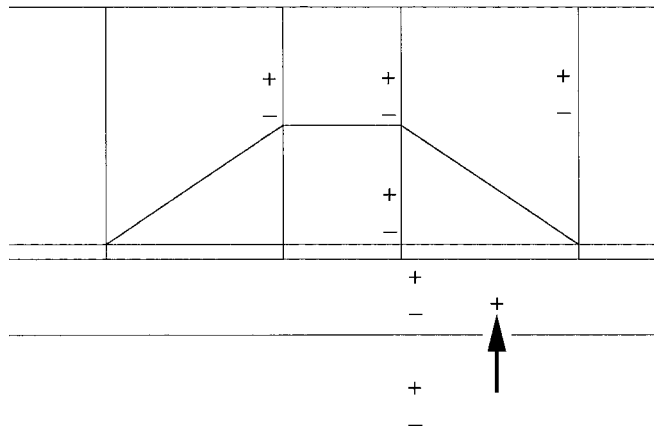
**A****APPENDIX****Intersection Checklist**

# A

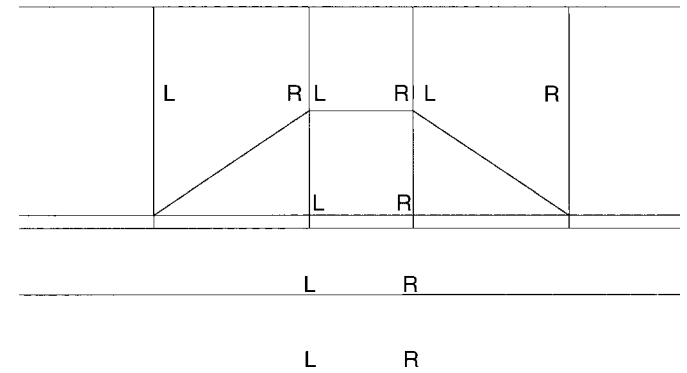
## APPENDIX

### Curb Ramp Element Analysis Form

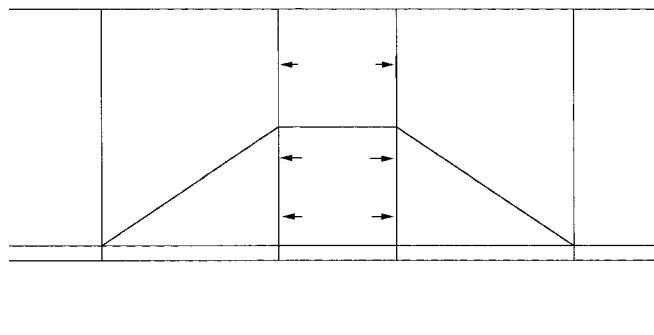
Slope Measurements in the Plus/Minus Direction



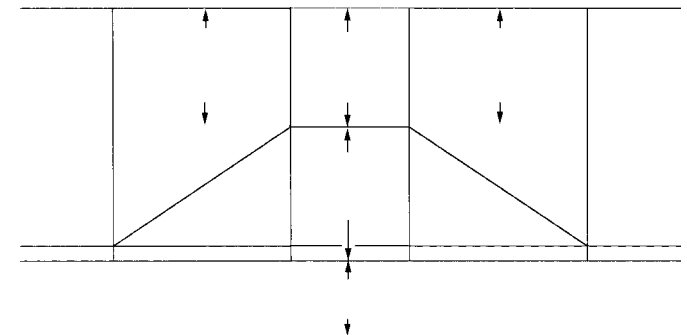
Downward Slope Measurements in the Left/Right Direction



Dimension Measurements in the X Direction



Dimension Measurements in the Y Direction

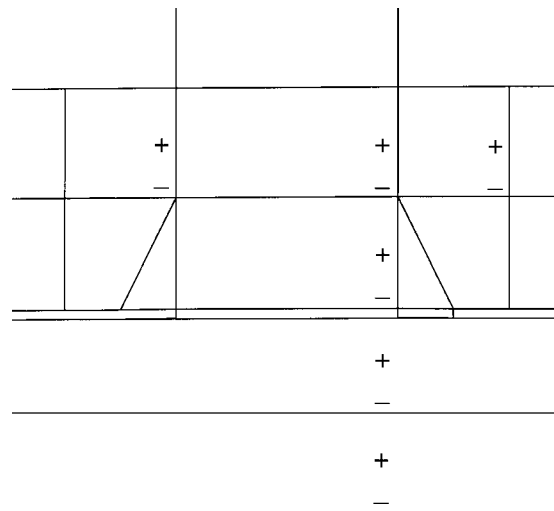


# A

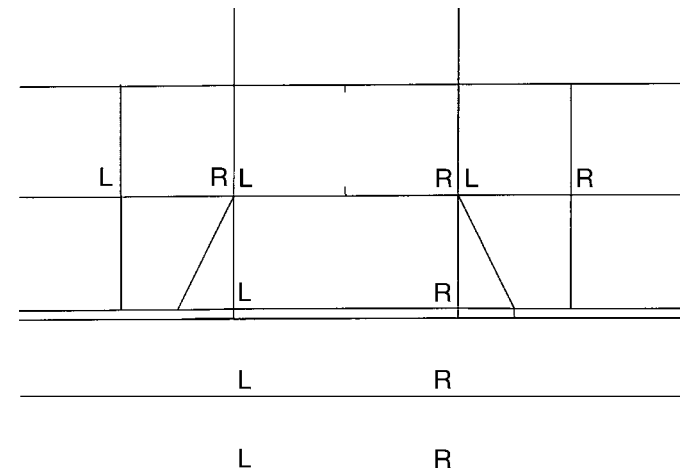
## APPENDIX

### Driveway Crossing Element Analysis Form

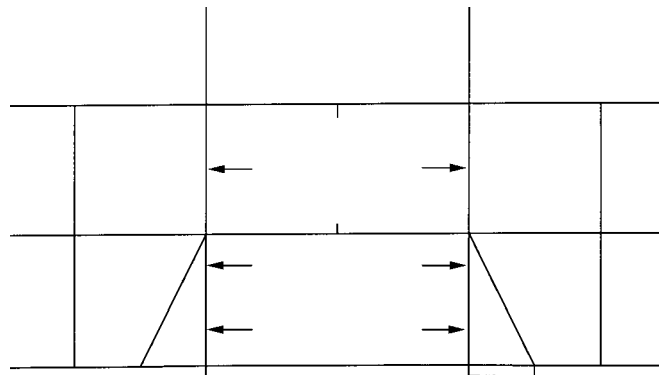
Downward Slope Measurements  
in the Plus/Minus Direction



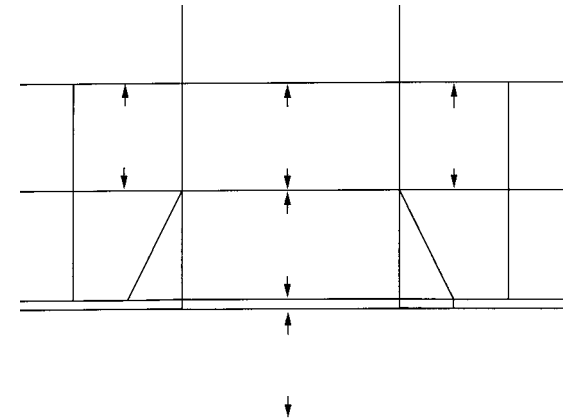
Slope Measurements in the Left/Right Direction



Dimension Measurements in the X Direction



Dimension Measurements in the Y Direction

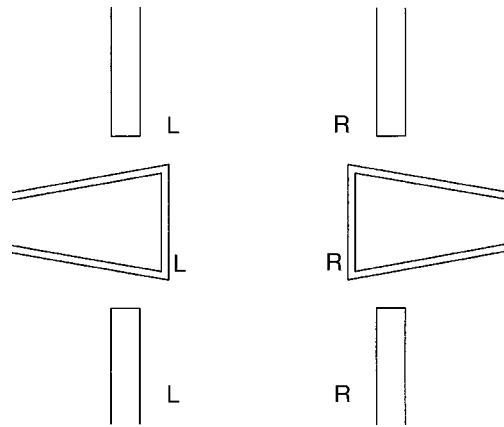


# A

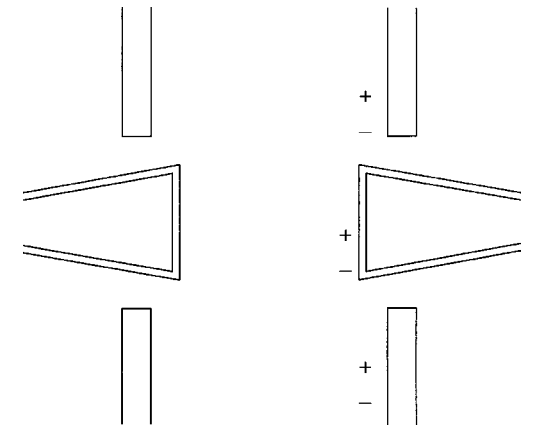
## APPENDIX

### Cut-Through Median Element Analysis Form

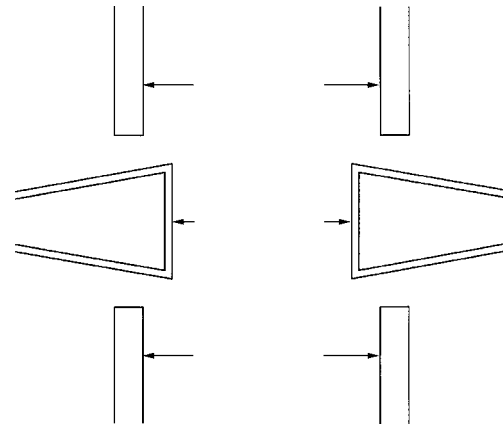
Downward Slope Measurements  
in the Plus/Minus Direction



Slope Measurements in the Left/Right Direction



Dimension Measurements in the X Direction



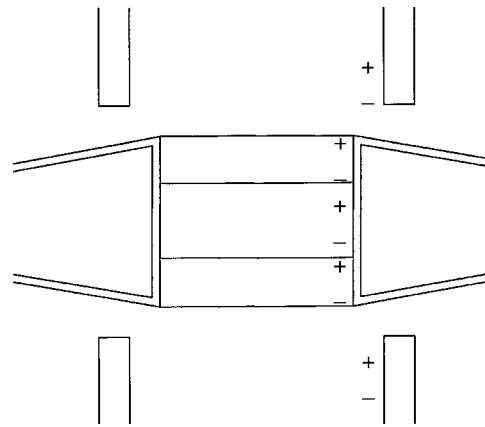


# A

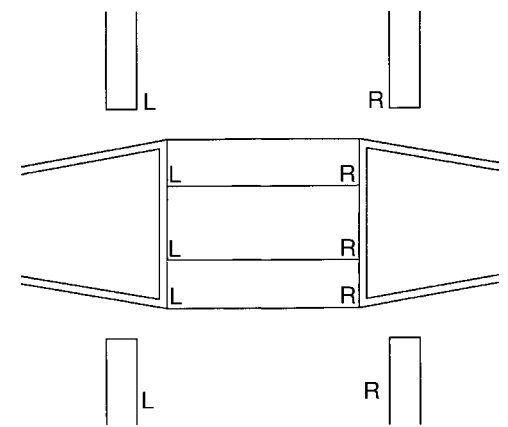
## APPENDIX

### Ramped Median Element Analysis Form

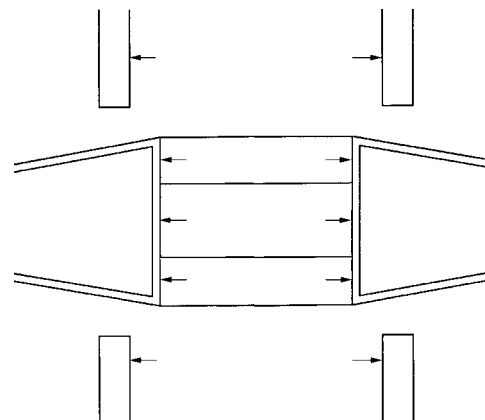
Downward Slope Measurements  
in the Plus/Minus Direction



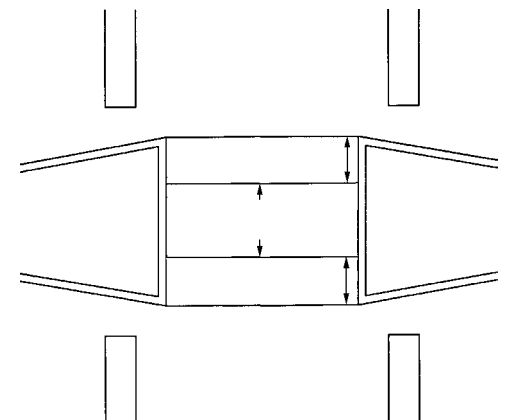
Slope Measurements in the Left/Right Direction



Dimension Measurements in the X Direction



Dimension Measurements in the Y Direction





# B

## APPENDIX

# Appendix B

## Sidewalk

### Accessibility

### Checklist

Identify a place to perform the assessment walk. If you are completing the checklist as a group, try brainstorming collectively to identify important pedestrian routes throughout your community. If you are completing the checklist as an individual, you might want to focus on routes you use regularly, such as from your house to the bus stop. Your walk should be no longer than six blocks.

Complete the contact information and review the checklist questions before you begin your walk. In addition to this form, you may want to bring a notebook, camera and/or sketch pad to record additional information, and a map of the area to mark your route.

Developed by Beneficial Designs

# B

## APPENDIX

### Contact Information

Name: \_\_\_\_\_

Address: \_\_\_\_\_

City: \_\_\_\_\_ State: \_\_\_\_\_ Zip: \_\_\_\_\_

Phone: \_\_\_\_\_ Email: \_\_\_\_\_

Gender: male/female Age: \_\_\_\_\_

Description of Disability (if any): \_\_\_\_\_

Type of Assistive Technology (if any): \_\_\_\_\_

Location of Route: \_\_\_\_\_

\_\_\_\_\_

\_\_\_\_\_

If you are not able to answer yes to a question, check as many problems as are applicable. In addition, please note the approximate locations where you encountered each problem.

1. Did you have enough room to walk safely?

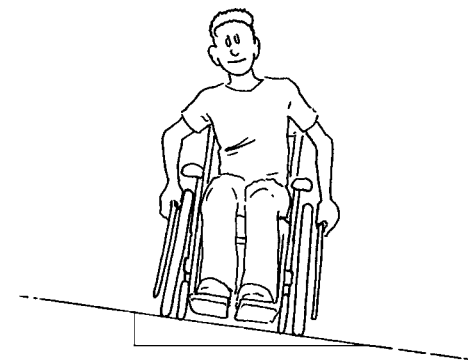
- Yes     Some problems:
- Sidewalks started and stopped
  - Sidewalks were too narrow
  - Sidewalks were blocked with poles, signs, or other obstacles
  - Sidewalks were blocked by branches or other vertical obstacles
  - Adequate passing spaces were not provided
  - No sidewalk existed

Other: \_\_\_\_\_

Locations of problems: \_\_\_\_\_

\_\_\_\_\_

\_\_\_\_\_



# B

## APPENDIX

2. Could you easily negotiate the sidewalk grades and cross slopes?

- Yes     Some problems:
- Sidewalks were excessively steep
  - Sidewalks had severe cross slopes
  - Adequate rest areas and/or level areas were not provided
  - Adequate shaded areas were not provided

Other: \_\_\_\_\_

Locations of problems: \_\_\_\_\_

\_\_\_\_\_

\_\_\_\_\_

3. Was the surface easy to walk on?

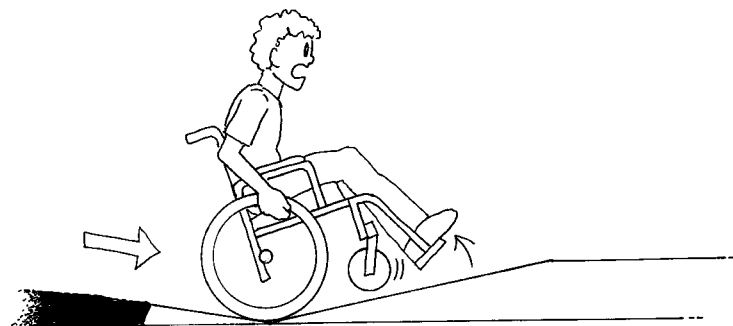
- Yes     Some problems:
- Sidewalk surfaces was not firm
  - Sidewalks were covered with snow or ice
  - Sidewalks were covered with leaves or other debris
  - Sidewalk surfaces were slippery
  - Sidewalks were broken or cracked
  - Gratings for trees and drainage were unavoidable

Other: \_\_\_\_\_

Locations of problems: \_\_\_\_\_

\_\_\_\_\_

\_\_\_\_\_





# B

## APPENDIX

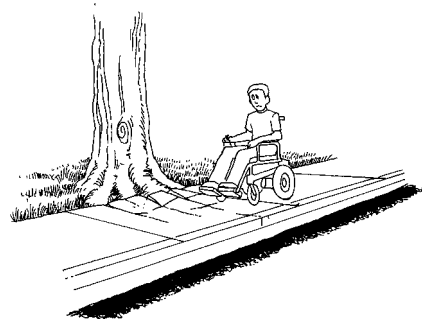
4. Were the curb ramps easy to use?

- Yes     Some problems:
- No curb ramps were provided
  - Curb ramps needed repair
  - Puddles or debris were collected at the bottom of the curb ramp
  - No tactile warning was provided
  - Curb ramps were too steep
  - No landings were provided
  - Extreme street slope made entering or leaving the curb ramp difficult
  - Obstacles such as poles or grates blocked the curb ramps
  - Curb ramps were exposed to traffic

Other: \_\_\_\_\_

Exact location of problematic curb ramps: \_\_\_\_\_

\_\_\_\_\_  
\_\_\_\_\_



5. Was it easy to cross streets?

- Yes     Some problems:
- Difficult to differentiate between the sidewalk and the street
  - Road was too wide
  - Traffic signals made you wait too long
  - Traffic signals did not give you enough time to cross
  - Pedestrian controls were difficult to locate
  - Pedestrian signal controls were difficult to activate
  - Parked cars blocked your view of traffic
  - Trees or plants blocked your view of traffic

Other: \_\_\_\_\_

Locations of problems: \_\_\_\_\_

\_\_\_\_\_  
\_\_\_\_\_

# B

## APPENDIX

6. Was your walk pleasant?

- Yes     Some unpleasant things:
- Needs more grass, flowers, or trees
  - Too much exposure to traffic
  - Suspicious activity
  - Not well lit
  - Dirty; lots of litter or trash

Other: \_\_\_\_\_

Locations of problems: \_\_\_\_\_

\_\_\_\_\_  
\_\_\_\_\_





# Appendix C

## Contact Information

### **America WALKS**

P.O. Box 29103  
Portland, OR 97210  
ph: 503-222-1077  
fax: 503-228-0289  
email: [americawalks@hevanet.com](mailto:americawalks@hevanet.com)  
[www.webwalking.com/amwalks/](http://www.webwalking.com/amwalks/)

### **American Association of the Deaf-Blind (AADB)**

814 Thayer Avenue  
Silver Spring, MD 20910  
ph: 301-588-6545 (TTY only – callers have  
to use their state relay service to reach  
AADB by telephone)  
email: [aadb@erols.com](mailto:aadb@erols.com)

### **American Association of Retired Persons (AARP)**

601 E Street, NW  
Washington, DC 20049  
ph: 800-424-3410  
email: [member@aarp.org](mailto:member@aarp.org)  
[www.aarp.org](http://www.aarp.org)

### **American Council of the Blind (ACB)**

1155 15th Street, NW  
Suite 720  
Washington, DC 20005  
ph: 800-424-8666  
fax: 202-467-5085  
[www.acb.org](http://www.acb.org)

### **American Foundation for the Blind (AFB)**

11 Penn Plaza  
Suite 300  
New York, NY 10001  
ph: 212-502-7661  
TTY: 212-502-7662  
fax: 212-502-7777  
email: [afbinfo@afb.org](mailto:afbinfo@afb.org)  
[www.afb.org](http://www.afb.org)

### **Association for Education and Rehabilitation of the Blind and Visually Impaired (AERBVI)**

4600 Duke Street #430  
P.O. Box 22397  
Alexandria, VA 22304  
ph: 703-823-9690  
fax: 703-823-9695  
[www.aerbvi.org](http://www.aerbvi.org)



## APPENDIX

### **American Occupational Therapy**

Association, Inc. (AOTA)  
4720 Montgomery Lane  
Bethesda, MD 20814-3425  
ph: 301-652-2682  
TTY: 800-377-8555  
fax: 301-652-7711  
www.aota.org

### **American Physical Therapy Association (APTA)**

1111 N. Fairfax Street  
Alexandria, VA 22314  
ph: 703-706-3395  
TTY: 703-683-6748  
fax: 703-706-3396  
www.apta.org

### **Beneficial Designs, Inc.**

5858 Empire Grade  
Santa Cruz, CA 95060  
ph: 831-429-8447  
fax: 831-423-8450  
e-mail: mail@beneficialdesigns.com  
www.beneficialdesigns.com

### **Center for Universal Design School of Design**

North Carolina State University  
Box 8613  
Raleigh, NC 27695-8613  
V/TTY: 919-515-3082  
fax: 919-515-3023  
e-mail: cud@ncsu.edu  
www.design.ncsu.edu/cud

### **Community Transportation Association of America**

1341 G Street, NW  
Suite 600  
Washington, DC 20005  
ph: 202-628-1480  
fax: 202-737-9197  
www.ctaa.org

### **Disability Rights Education and Defense Fund, Inc. (DREDF)**

2212 Sixth Street  
Berkeley, CA 94710  
V/TTY: 510-644-2555  
fax: 510-841-8645  
e-mail: dredf@dredf.org  
www.dredf.org

### **Disabled American Veterans (DAV)**

PO Box 14301  
Cincinnati, OH 45250-0301  
ph: 606-441-7300  
e-mail: ahdav@one.net  
www.dav.org

### **Fair Housing Information Clearinghouse (FHIC)**

U.S. Department of Housing and  
Urban Development  
P.O. Box 9146  
McLean, VA 22102  
ph: 800-343-3442  
TTY: 800-290-1617  
fax: 703-821-2098  
e-mail: fairhousing@circsol.com  
www.circsol.com





## APPENDIX

### **National Association of the Deaf (NAD)**

814 Thayer Avenue  
Silver Springs, MD 20910-4500  
ph: 301-587-1788  
fax: 301-587-1791  
e-mail: NADHO@juno.com  
www.nad.org

### **National Center on Accessibility**

5020 State Road 67 North  
Martinsville, IN 46151  
V/TTY: 800-424-1877  
fax: 765-342-6658  
e-mail: nca@indiana.edu  
www.indiana.edu/~nca

### **National Council on Disability (NCD)**

1331 F Street, NW  
Suite 1050  
Washington, DC 20004-1107  
ph: 202-272-2004  
TTY: 202-272-2074  
fax: 202-272-2022  
e-mail: mquigley@ncd.gov  
www.ncd.gov

### **National Council on the Aging**

409 Third Street, SW  
Suite 200  
Washington, DC 20024  
ph: 202-479-1200  
fax: 202-479-0735  
e-mail: info@ncoa.org  
www.ncoa.org

### **National Federation of the Blind (NFB)**

1800 Johnson Street  
Baltimore, MD 21230  
ph: 410-659-9314  
e-mail: epc@roudley.com  
www.nfb.org

### **National Institute on Disability and Rehabilitation Research (NIDRR)**

US Department of Education  
600 Independence Avenue, SW  
Washington, DC 20202-0498  
ph: 800-872-5327  
e-mail: CustomerService@inet.ed.gov  
www.ed.gov/offices/osers/nidrr

### **Paralyzed Veterans of America (PVA)**

801 18th Street NW  
Washington, DC 20007  
ph: 202-416-7700  
fax: 202-416-7641  
www.pva.org

### **Project ACTION**

700 Thirteenth Street, NW  
Suite 200  
Washington, DC 20005  
ph: 800-659-6428  
fax: 202-347-4157  
www.projectaction.org



## APPENDIX

### **Rehabilitation Engineering and Assistive Technology Society of North American (RESNA)**

1700 N. Moore Street  
Suite 1540  
Arlington, VA 22209  
ph: 703-524-6686  
TTY: 703-524-6639  
fax: 703-524-6630  
www.resna.org

### **Self Help for Hard of Hearing People (SHHHP)**

7910 Woodmont Avenue  
Suite 1200  
Bethesda, MD 20814  
ph: 301-657-2248  
TTY: 301-657-2249  
fax: 301-913-9413  
e-mail: National@shhh.org  
www.shhh.org

### **Smith-Kettlewell Eye Research Foundation**

2232 Webster Street  
San Francisco, CA 94115  
ph: 415-561-1657

### **Trace Research & Development**

University of Wisconsin-Madison  
5901 Research Park Boulevard  
Madison, WI 53719-1252  
ph: 608-262-6966  
TTY: 608-262-8848  
fax: 608-262-8848  
e-mail: web@trace.wisc.edu/  
http://trace.wisc.edu

### **Smith-Ketterwell Eye Research Foundation**

2232 Webster Street  
San Francisco, CA 94115  
ph: 415-561-1657

### **Trace Research & Development**

University of Wisconsin-Madison  
5901 Research Park Boulevard  
Madison, WI 53719-1252  
ph: 608-262-6966  
TTY: 608-262-8848  
fax: 608-262-8848  
e-mail: web@trace.wisc.edu/  
http://trace.wisc.edu

### **U.S. Access Board**

1331 F Street, NW  
Suite 1000  
Washington, DC 20004-1111  
ph: 800-872-2253  
TTY: 800-993-2822  
fax: 202-272-5447  
e-mail: info@access-board.gov  
www.access-board.gov

### **U.S. Department of the Interior/ National Park Service**

by contact with the  
National Center on Accessibility  
at Indiana University  
TTY: 800-424-1877

### **U.S. Department of Justice**

ph: 800-514-0301  
TTY: 800-514-0383  
www.usdoj.gov/crt/ada/adahom1.htm



## APPENDIX

### **U.S. Department of Transportation Office of the Secretary**

Departmental Office of  
Civil Rights  
S-30, Room 10215  
400 Seventh St., SW  
Washington, DC 20590  
ph: 202-366-4648  
TTY: 202-366-5273

### **U.S. Department of Transportation Federal Aviation Administration**

ACR-4, Room 1030  
Office of Civil Rights  
800 Independence Ave., SW  
Washington, DC 20591  
ph: 202-257-3258  
TTY 202-267-9730

### **U.S. Department of Transportation Federal Highway Administration**

HCR-1, Room 4132  
Office of Civil Rights  
400 Seventh St., SW  
Washington, DC 20590  
ph: 202-366-0693  
TTY: 202-366-5751

### **U.S. Department of Transportation Federal Railroad Administration**

ROA-10  
Office of Civil Rights  
400 Seventh St., SW  
Washington, DC 20590  
ph: 202-493-6010

### **U.S. Department of Transportation National Highway Traffic Safety Administration**

NOA-20, Room 6128  
Office of Civil Rights  
400 Seventh St., SW  
Washington, DC 20590  
ph: 202-366-6795

### **U.S. Department of Transportation Federal Transit Administration**

TCR-1, Room 9102  
Office of Civil Rights  
400 Seventh St., SW  
Washington, DC 20590  
ph: 202-366-4018  
ph: 888-446-4511

### **U.S. Department of Transportation Research and Special Programs Administration**

DCR-1, Room 7110  
Office of Civil Rights  
400 Seventh St., SW  
Washington, DC 20590  
ph: 202-366-9638

### **U.S. Equal Employment Opportunity Commission**

1801 L Street, NW  
Washington, DC 20507  
ph: 202-663-4900  
TTY: 202-663-4494  
<http://www.eeoc.gov>



# D

## APPENDIX

# Appendix D

## Detectable Warning Manufacturers

### Detectable Warnings

Synthesis of U.S. and International Practice (May 2000)

*Authors:* Billie Loise Bentzen, Ph.D., Janet M. Barlow, COMS, Lee S. Tabor, Architect

*Available:* U.S. Access Board, [Info@access-board.gov](mailto:Info@access-board.gov)

### Detectable Warning Manufacturers

The Federal Highway Administration does not promote or endorse any of the following manufacturers. For your convenience we have compiled this information to be used as a resource. This is not a comprehensive list of all detectable warnings manufacturers.

#### **ADA Fabricators, Inc.**

P.O. Box 179  
N. Billerica, MA 01862  
Ph: (800) 372-0519  
Fax: (978) 262-1455

#### **Applied Surfaces, Inc.**

1545 Jefferson Street  
Teaneck, NJ 07666  
Ph: (201) 836-5552  
Fax: (201) 836-0346

#### **Architectural Tile and Granite, Inc.**

P.O. Box 3542  
Sunriver, OR 97707  
Ph/Fax: (541) 593-1790

#### **Castek Division**

Transpo Inc.  
20 Jones Street  
New Rochelle, NY 10801  
Ph: (800) 321-7870  
Fax: (914) 636-1282



# D

## APPENDIX

### **Cobblecrete International, Inc.**

485 West 2000 South  
Orem, UT 84058  
Ph: (800) 798-5791  
Fax: (801) 225-1690  
Email: cobble@burgoyne.com  
www.cobblecrete.com

### **COTE-L Industries, Inc.**

1542 Jefferson St.  
Teaneck, NJ 07666  
Ph: (201) 836-0733  
Fax: (201) 836-5220  
Email: cotel@sprynet.com  
www.cotelind.com

### **Cold Spring Granite Company**

202 South 3rd Ave.  
Cold Spring, MN 56320  
Ph: (800) 328-7038  
Fax: (320) 685-5490  
www.coldspringgranite.com

### **Crossville Ceramics Co., L.P.**

P.O. Box 1168  
Crossville, TN 38555  
Ph: (931) 484-2110  
Fax: (931) 484-8418  
Email: crossc@crossville.com  
www.crossville-ceramics.com

### **Disability Devices Distributor**

17420 Mt. Hermon Street, #C  
Fountain Valley, CA 92708  
Ph: (800) 747-5651  
Fax: (714) 437-9309

### **Endicott Clay Products Co.**

P.O. Box 17  
Fairbury, NE 68352  
Ph: (402) 729-3315  
Fax: (402) 729-5804  
Email: endicott@endicott.com  
www.endicott.com

### **Engineered Plastics, Inc.**

Olympic Towers  
300 Pearl Street, #200  
Buffalo, NY 14202  
Ph: (800) 682-2525  
Fax: (800) 769-4463  
www.engplastics.com

### **Hanover Architectural Products, Inc.**

240 Bender Road  
Hanover, PA 17331  
Ph: (717) 637-0500  
Fax: (717) 637-7145  
www.hanoverpavers.com

# D

## APPENDIX

### **Increte Systems**

Inco Chemical Supply Co., Inc.  
8509 Sunstate Street  
Tampa, FL 33634  
Ph: (800) 752-4626  
Fax: (813) 886-0188  
www.increte.com

### **Pavestone Company**

4835 LBJ Freeway, #700  
Dallas, TX 75244  
Ph: (800) 245-PAVE  
Fax: (972) 404-9200  
Email: info@pavestone.com  
www.pavestone.com

### **Steps Plus, Inc.**

6375 Thompson Rd.  
Syracuse, NY 13206  
Ph: (315) 432-0885  
Fax: (315) 432-0612  
www.steps-plus.com

### **Strongwall Industries, Inc.**

P.O. Box 201  
Ridgewood, NJ 07451  
Ph: (800) 535-0668  
Fax: (201) 447-2317  
www.strongwall.com

### **Summitville Tiles, Inc.**

P.O. Box 73  
Summitville, OH 43962  
Ph: (330) 223-1511  
Fax: (330) 223-1414  
www.summitville.com

### **Superock Block Company, Inc.**

3301 27th Avenue N.  
P.O. Box 5326  
Birmingham, AL 35207-0326  
Ph: (205) 324-8624  
Fax: (205) 324-8671  
Email: ggunn@lehighcement.com

### **Vanguard ADA Products of America**

Tilco, Inc.  
20628 Broadway Avenue  
Snohomish, WA 98296  
Ph: (800) 290-5700  
Fax: (360) 668-3335  
Email: tilcovngrd@aol.com  
www.vngrd.com

### **Whitacre-Greer Fireproofing Company**

1400 S. Mahoning Avenue  
Alliance, OH 44601  
Ph: (800) WGPAPER  
Fax: (330) 823-5502  
Email: Info@wgpaver.com  
www.wgpaver.com



# E

## APPENDIX

# Appendix E

## Slope Conversion Chart

%	Ratio	Degree	%	Ratio	Degree
0.9	1:111	0.5	6.3	1:16	3.6
1.0	1:100	0.6	6.7	1:15	3.8
1.1	1:90	0.6	7.1	1:14	4.1
1.2	1:83	0.7	7.7	1:13	4.4
1.3	1:80	0.7	8.3	1:12	4.8
1.4	1:70	0.8	9.1	1:11	5.2
1.7	1:60	1.0	10.0	1:10	5.7
2.0	1:50	1.1	11.1	1:9	6.3
2.2	1:45	1.3	12.5	1:8	7.1
2.5	1:40	1.4	14.3	1:7	8.1
2.9	1:35	1.6	16.7	1:6	9.5
3.3	1:30	1.9	20.0	1:5	11.3
4.0	1:25	2.3	25.0	1:4	14.0
5.0	1:20	2.9	33.3	1:3	18.4
5.3	1:19	3.0	50.0	1:2	26.6
5.6	1:18	3.2	100.0	1:1	45.0
5.9	1:17	3.4			





# F

## APPENDIX

# Appendix F

## Abbreviations and Acronyms

AASHTO	American Association of State Highway and Transportation Officials
ABA	Architectural Barriers Act
ADA	Americans with Disabilities Act
ADAAG	Americans with Disabilities Act Accessibility Guidelines/ADA Standards for Accessible Design
ADT	Average Daily Traffic
ANSI	American National Standards Institute
AOTA	American Occupational Therapy Association, Inc.
APS	Accessible Pedestrian Signal
ATV	All-terrain vehicle
CFR	Code of Federal Regulations
CIP	Capital Improvement Program
CMAQ	Congestion Mitigation and Air Quality Improvement Program
CMP	Comprehensive Master Plan
DOJ	Department of Justice
DOT	Department of Transportation
EEOC	Equal Employment Opportunity Commission
FCC	Federal Communications Commission
FEMA	Federal Emergency Management Agency
FFE	Finished floor elevation
FHWA	Federal Highway Administration
FTA	Federal Transit Administration
GPS	Global Positioning System
HUD	United States Department of Housing and Urban Development

# F

## APPENDIX

ICIDH	International Classification of Impairment, Disability, and Handicap
ILC	Independent Living Center
ISTEA	Intermodal Surface Transportation Efficiency Act
LRV	Light Reflectance Value
MPO	Metropolitan Planning Organization
MUTCD	Manual on Uniform Traffic Control Devices
NWPS	National Wilderness Preservation System
OHV	Off-highway vehicle
ORAR	Outdoor Recreation Access Route
PASD	Pedestrian Actuated Signal Device
STIP	Statewide Transportation Improvement Program
STP	Surface Transportation Program
SWAP	Sidewalk Assessment Process
TDD	Telecommunication Device for the Deaf
TEA	Transportation Enhancement Activities
TEA-21	Transportation Equity Act for the 21st Century
TIP	Transportation Improvement Program
TTY	Telecommunication Device for the Deaf
U.S. Access Board	United States Architectural and Transportation Barriers Compliance Board
UFAS	Uniform Federal Accessibility Standards
USDA	United States Department of Agriculture
USDI	United States Department of the Interior
U.S. DOJ	United States Department of Justice
U.S. DOT	United States Department of Transportation
UTAP	Universal Trail Assessment Process
VA	Veterans Affairs

# Appendix G

## Glossary

**Accessible route** — A continuous, unobstructed path connecting all accessible elements and spaces of a building or facility that meets the requirements of ADAAG.

**Alteration** — Modification made to an existing building or facility that goes beyond normal maintenance activities and affects or could affect usability.

**Americans with Disabilities Act of 1990 (ADA)** — A Federal law prohibiting discrimination against people with disabilities.

**Americans with Disabilities Act Accessibility Guidelines (ADAAG)** — Provide scoping and technical specifications for new constructions and alterations undertaken by entities covered by the ADA.

**Architectural Barriers Act of 1968 (ABA)** — A Federal law stating that buildings and facilities designed, constructed, or altered with Federal funds, or leased by a Federal agency, must comply with standards for physical accessibility.

**Arterial road** — A major through route; arterials often provide direct service between cities and large towns.

**Assistive device** — A device that assists users in accomplishing day-to-day functions. For example, a wheelchair is an assistive device to assist a person who cannot walk.

**Audible warning** — A warning consisting of words or sounds indicating a potentially hazardous situation.

**Barrier removal** — Removal, rearrangement, or modification of objects positioned or structured in a manner that impedes access. Can include rearrangement or removal of furniture or equipment, installation of curb cuts or ramps, or repositioning items such as telephone kiosks or newspaper boxes.

**Bevel** — A surface that meets another surface at any angle other than 0 or 90 degrees.

**Bulbout** — Another term for a curb extension, which is a section of sidewalk at

an intersection or midblock crossing that reduces the crossing width for pedestrians and can help reduce traffic speeds.

**Caster** — A wheel that can pivot but is not intended to govern the driving direction; typically used for the front wheels of most wheelchairs and strollers.

**Change of cross slope** — An abrupt difference between the cross slope of two adjacent surfaces. A rapid rate of change of cross slope is frequently found on driveway crossing flares and curb ramps without landings. A cross slope that changes so rapidly that there is no planar surface over 0.6 m<sup>2</sup> (24 in<sup>2</sup>) can create a safety hazard.

**Change of grade** — An abrupt difference between the grade of two adjacent surfaces.

**Changes in level** — Vertical height transitions between adjacent surfaces or along the surface of a path. Small changes in level are often caused by cracks in the surfacing material. Changes in level may also result when the expansion joints between elements such as curb ramps and gutters are not constructed at the same time. On trails, ruts caused by weather erosion, tree roots, and rocks protruding from the trail surface are common sources of changes in level.

**Charrette** — An intensive 1-5 day workshop involving members of a community discussing planning issues, interrelationships, and impacts, and creating their own vision for a project, corridor, neighborhood, or community.

**Clear space in crosswalk** - The additional space required to be included in a crosswalk at the corner where the ramp of a diagonal curb ramp meets the street, so that those entering or exiting the base of the ramp can remain within the crosswalk.

**Collector road** — A roadway linking traffic on local roads to the arterial road network.

**Commercial facility** — Facilities that are intended for non residential use by private entities and whose operation affects commerce.

**Comprehensive Master Plan** — A broad collection of goals, policies, and objectives adopted by a locality for the purpose of directing the growth of the locality.

**Continuous passage** — An unobstructed way of pedestrian passage or travel that connects pedestrian areas, elements, and facilities to accessible routes on adjacent sites.

**Cross slope** — The slope measured perpendicular to the direction of travel.

# G

## APPENDIX

**Curb extension** — A section of sidewalk at an intersection or midblock crossing that reduces the crossing width for pedestrians and can help reduce traffic speeds.

**Curb ramp** — A combined ramp and landing to accomplish a change in level at a curb. This element provides street and sidewalk access to pedestrians using wheelchairs.

**Design width** — The width specification that a sidewalk or trail was designed to meet. For sidewalks, the design width extends from the curb to any buildings or landscaping that forms the opposite border of the sidewalk. For trails, the design width is the area generally considered part of the trail (the beaten path or tread width).

**Detectable warning** — A standardized surface feature built in or applied to walking surfaces or other elements to warn people with visual impairments of hazards.

**Diagonal curb ramp** — A curb ramp positioned at the apex of an intersection.

**Diagonal technique** — An environmental scanning technique where a visually disabled person holds a cane diagonally across the body in a stationary position, with the cane just above or touching the ground at a point outside one shoulder, and with the handle extending to a point

outside the other shoulder. Used primarily in familiar, controlled environments.

**Drainage inlet** — A site where water runoff from the street or sidewalk enters the storm drain system; the openings to drainage inlets are typically covered by a grate or other perforated surface to protect pedestrians.

**Driveway crossing** — A ramp positioned where a driveway and the sidewalk meet; designed to ease the transition between the street and driveway.

**Finished floor elevation** — The elevation at which the building foundation meets the prevailing ground surface.

**Firmness** — The degree to which a surface resists deformation by indentation when, for instance, a person walks or wheels across it. A firm surface would not compress significantly under the forces exerted as a person walks or wheels on it.

**Flare** — A sloped surface that flanks a curb ramp and provides a graded transition between the ramp and the sidewalk. Flares bridge differences in elevation and are intended to prevent ambulatory pedestrians from tripping. Flares are not considered part of the accessible route.



# G

## APPENDIX

**Frontage Zone** — A linear portion of the sidewalk corridor, adjacent to the edge of the right-of-way (or property line).

**Furnishings Zone** — A linear portion of the sidewalk corridor, adjacent to the curb, that contains elements such as trees, signal poles, utility poles, street lights, street signs, controller boxes, hydrants, parking meters, driveway aprons, planting strips, or street furniture.

**Global Positioning System (GPS)** — A system that identifies latitude, longitude, and elevation; a hand console is used to obtain data from an orbiting satellite.

**Grade** — The slope parallel to the direction of travel that is calculated by dividing the vertical change in elevation by the horizontal distance covered. For example, a trail that gains 2 m in elevation over 40 m of horizontal distance has a grade of 5 percent.

**Grate** — A framework of latticed or parallel bars that prevents large objects from falling through a drainage inlet but permits water and some sediment to fall through the slots.

**Grade-separated crossings** — Facilities such as overpasses, underpasses, skywalks, or tunnels that allow pedestrians and motor vehicles to cross a street at different levels.

**Gutter** — A trough or dip used for drainage purposes that runs along the edge of the trail or street and curb or curb ramp.

**Intermodalism** — The use of multiple modes of transportation to reach one destination; includes combining the use of trains, buses, automobiles, bicycles, and walking into a given trip.

**Intermodal Surface Transportation Efficiency Act of 1991 (ISTEA)** — Federal legislation authorizing highway, highway safety, transit, and other surface transportation programs from 1991 through 1997. It provided new funding opportunities for sidewalks, shared-use paths, and recreational trails. ISTEA was superseded by the Transportation Equity Act for the 21st Century (TEA-21).

**Intersection** — An area where two or more pathways or roadways join together.

**Island** — A pedestrian refuge within the right-of-way and traffic lanes of a highway or street; also used as a loading stop for light rail or buses.

**Land management agency** — Includes any agency or private organization that manages recreation and/or wilderness areas. Examples of land management agencies include: national entities such as the USDA Forest Service, the USDI Bureau of

# G

## APPENDIX

Land Management, and the USDI National Park Service, as well as State and local park systems.

**Landing** — A level area of the sidewalk at the top of a curb ramp that faces the ramp path.

**Level of Service (LOS)** — Qualitative and quantitative measurements of the physical environment for the comfort and efficiency of a mode of travel for pedestrians, bicyclists, or motorists. LOS ratings are A-F, similar to school grading systems. A rating of A (LOS) for one mode may be F for another mode. Balance is needed in order to have a transportation facility that is safe and amenable to all the users.

**Local road** — A road that serves individual residences or businesses and/or distributes traffic within a given urban or rural area.

**Long white cane** — Navigational device used by people with vision impairments to scan the environment for potential obstacles and hazards.

**Maximum cross slope** — The highest cross slope of a trail or sidewalk that exceeds the typical running cross slope of the path. The distance over which a maximum cross slope occurs significantly influences how difficult a section of sidewalk or trail is to negotiate.

**Maximum grade** — The steepest grade that exceeds the typical running grade. The distance over which a maximum grade occurs significantly influences how difficult a section of sidewalk or trail is to negotiate.

**Median** — An island in the center of a road that provides pedestrians with a place of refuge and reduces the crossing distance between safety points.

**Midblock crossing** — A crossing point positioned in the center of a block rather than at an intersection.

**Minimum clear width** — The narrowest point on a sidewalk or trail. A minimum clear width is created when significant obstacles, such as utility poles or tree roots, protrude into the sidewalk and reduce the design width.

**Metropolitan Planning Organization (MPO)** — An urban regional body for areas with populations larger than 50,000, that makes transportation policy and planning decisions as mandated in Federal transportation legislation.

**New construction** — A project in which an entirely new facility is built from the ground up or where a new facility is added to an existing facility.

**Obstacle** — An object that limits the vertical passage space, protrudes into the circulation route, or reduces the clearance width of a sidewalk or trail. On sidewalks, obstacles are most common in retrofit situations, because accessibility was not considered in the original plan. On trails, obstacles can include objects such as boulders, drop-offs, and tree branches.

**Parallel curb ramp** — A curb ramp design in which the sidewalk slopes down on either side of a landing at street level; parallel curb ramps require users to turn on the landing before entering the street.

**Passing space** — A section of path wide enough to allow two users to pass one another or travel abreast.

**Passing space interval** — The distance between passing spaces.

**Pedestrian** — A person who travels on foot or who uses assistive devices, such as a wheelchair, for mobility.

**Pedestrian actuated traffic control** — A push-button or other control operated by pedestrians that is designed to interrupt the prevailing signal cycle to permit pedestrians to cross an intersection.

**Pedestrian/bicycle coordinator** — A position responsible for planning and managing nonmotorized facilities and

programs, creating safety and promotional materials that encourage bicycle and pedestrian transportation, and serving as the principal liaison between government transportation entities, the press, citizen organizations, and individuals on bicycling and walking issues.

**Perpendicular curb ramp** — A curb ramp design in which the ramp path is perpendicular to the edge of the curb.

**Places of public accommodation** — Facilities operated by private entities that fall within the following 12 broad categories defined by Congress: places of lodging, food establishments, entertainment houses, public gathering centers, sales establishments, service establishments, transportation stations, places of recreation, museums and zoos, social service establishments, and places of education.

**Private entity** — An individual or organization not employed, owned, or operated by the government.

**Program access** — Access provided to a program, service, or activity conducted or funded by a public entity.

**Prosthesis** — An artificial device that replaces part of the body; includes artificial limbs that serve as assistive devices and enable mobility.

# G

## APPENDIX

**Public entity** — Any State or local government, department agency, special-purpose district, or other instrumentality of a State or States or local government, and any commuter authority.

**Railroad flangeway** — A channel paralleling train or trolley tracks embedded in the travel surface of a road.

**Ramp** — A sloped transition between two elevation levels.

**Reach distance** — The three-dimensional space within touching or grasping distance of a pedestrian. As a consequence of their seated position, wheelchair users generally have a more limited reach distance than other pedestrians.

**Readily achievable** — Easily accomplished and able to be carried out without much difficulty or expense; refers to the criterion for barrier removal under Title III of the ADA.

**Reasonable accommodation** — Modifications or adjustments to a program, work environment, or job description that make it easier for a person with a disability to participate in the same manner as other employees.

**Recreation Access Advisory Committee** — A committee established in 1993 by the U.S.

Access Board to develop recommendations for accessible recreation facilities.

**Recreation trail** — A trail that is designed to provide a recreational experience.

**Rehabilitation Act of 1973** — A Federal law requiring nondiscrimination in the employment practices of Federal agencies of the executive branch and Federal contractors; requires all Federally assisted programs, services, and activities to be available to people with disabilities.

**Removable obstacle** — An item that obstructs the clear passage space but is not fixed immovably to the ground. Examples of removable objects include newspaper vending boxes, rocks, vegetation, trash receptacles, and small planters.

**Rest area** — A level portion of a trail that is wide enough to provide wheelchair users and others a place to rest and gain relief from the prevailing grade and cross slope demands of the path.

**Rest area interval** — The distance between rest areas.

**Right-of-way** — The rights, title, and interest in real property necessary for the construction and maintenance of the project. Private property rights may be acquired by donation or acquisition and

may be fee-simple, easement, or other form of use agreement acceptable to the parties. The property rights must be of sufficient duration to match the design life of the project, and in a form that can be recorded on the land records.

**Running cross slope** — The average cross slope of a contiguous section of a sidewalk or trail. Running cross slope is measured by averaging the values of cross slope measurements taken periodically at different points along a given section of sidewalk.

**Running grade** — The average of many short, contiguous grades.

**Section 14 (1994)** — Section of the ADAAG containing proposed accessibility guidelines for public rights-of-way (now reserved).

**Section 504 (1973)** — The section of the Rehabilitation Act that prohibits discrimination by any program or activity conducted by the Federal government.

**Shared use path** — A trail that permits more than one type of user and that has a transportation and recreation function. An example is a trail designated for use by both pedestrians and bicyclists.

**Shy distance** — The area along a path generally avoided by pedestrians, such as the areas closest to buildings, retaining walls, curbs, and fences.

**Sidewalk** — The portion of a highway, road, or street intended for pedestrians.

**Sidewalk approach** — The section of the sidewalk that flanks the landing of a curb ramp. The approach may be slightly graded if the landing level is below the elevation of the adjoining sidewalk.

**Sight distance** — The length of roadway visible to a driver or pedestrian; the distance a person can see along an unobstructed line of sight.

**Site** — A parcel of land bounded by a property line or a designated portion of public right of way.

**Slip resistant surface** — Slip resistance is based on the frictional force necessary to permit a person to ambulate without slipping. A slip resistant surface does not allow a shoe heel, wheelchair tires, or a crutch tip to slip when ambulating on the surface.

**Stable surface** — Stability is the degree to which a surface remains unchanged by contaminants or applied force, so that when the contaminant or force is removed the surface returns to its original condition. A stable surface is not significantly altered by a person walking or maneuvering a wheelchair.



# G

## APPENDIX

**Surface** — The material on which a person walks or wheels in the pedestrian environment. Sidewalk surfaces generally consist of concrete or asphalt, but commonly include tile, stone, and brick. In addition to concrete and asphalt, trails can be surfaced with dirt, rock, gravel, sand, mud, snow, grass, and other substances.

**Surface Transportation Program (STP)** — A Federal program that provides grants to States for federally funded roadways and enhancement projects.

**Switchback** — A trail or road that ascends a steep incline by taking a winding course to reduce the grade of the path.

**Title II of the Americans with Disabilities Act of 1990** — The section of the Americans with Disabilities Act of 1990 that prohibits State and local governments from discriminating against people with disabilities in programs, services, and activities.

**Title III of the Americans with Disabilities Act of 1990** — The section of the Americans with Disabilities Act of 1990 that prohibits places of public accommodation and commercial facilities from discriminating on the basis of disability. Applies to both private and public entities.

**Touch technique** — An environmental scanning method in which a blind person arcs a cane from side to side and touches points outside both shoulders. Used primarily in unfamiliar or changing environments, such as on sidewalks and streets.

**Trail** — A path of travel for recreation and/or transportation within a park, natural environment, or designated corridor that is not classified as a highway, road, or street.

**Transportation agency** — A Federal, State, or local government entity responsible for planning and designing transportation systems and facilities for a particular jurisdiction.

**Transportation enhancement** — Projects that enhance the transportation network, including providing bicycle and pedestrian facilities; converting abandoned railroad rights-of-way into trails; preserving historic transportation sites; acquiring scenic easements; and mitigating the negative impacts of a project on a community by providing additional benefits.

**Transportation Equity Act for the 21st Century (TEA-21)** — Federal legislation authorizing highway, highway safety, transit, and other surface transportation programs from 1998 through 2003.

# G

## APPENDIX

It provides funding opportunities for pedestrian, bicycling, and public transit facilities and emphasizes intermodalism, multimodalism, and community participation in transportation planning.

**Truncated domes** — Small domes with truncated tops that are detectable warnings used at transit platforms, curb ramps, and hazardous vehicular ways.

**Uniform Federal Accessibility Standards** — Accessibility standards that all Federal agencies are required to meet; includes scoping and technical specifications.

**Universal Design** — The designing of products and environments to be usable by all people, to the greatest extent possible, regardless of age, size, or abilities.

**U.S. Access Board (United States Architectural and Transportation Barriers Compliance Board)** — The Federal agency that is responsible for developing Federal accessibility guidelines under the ADA and other laws.

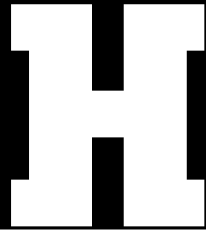
**Vertical clearance** — The minimum unobstructed vertical passage space required along a sidewalk or trail.

**Visual impairment** — Loss or partial loss of vision.

**Water bar** — A bar made of materials such as wood, rubber, or stone that is placed across a trail to divert runoff across rather than down the trail.

**Wheelchair** — Wheeled mobility device used by people with limited or no ability to walk. Wheelchairs can be manually propelled or battery powered.

**Wilderness Act of 1964** — A Federal law that prohibits the use of motorized vehicles and mechanized construction on certain tracts of Federally managed land.



# Appendix H

## Bibliography

*Albright, D.P. (1995). Standing in the cold: Mobility and the mentally challenged. Washington: Surface Transportation Policy Project.*

*This booklet depicts the access deficiencies of public transportation.*

*Alliance for Transportation Research, 1001 University Boulevard, S.E., Albuquerque, NM 87106, Telephone: (505) 246-6410.*

*American Association of State Highway and Transportation Officials. (1983). Transportation glossary. Washington, DC.*

*This book contains definitions of 1,500 transportation terms.*

*AASHTO, 444 North Capitol Street, N.W., Washington, DC 20001, Telephone: (202) 624-5800.*

*American Association of State Highway and Transportation Officials (1995). A policy on geometric design of highways and streets: 1994. Washington, DC.*

*This book lists AASHTO recommended policies for roadway design.*

*AASHTO, 444 North Capitol Street, N.W., Suite 249, Washington, DC 20001, Telephone: (202) 624-5800.*

*American Association of State Highway and Transportation Officials, Inc. (1996). Standard Specifications for Highway Bridges. Washington, DC: American Association of State Highway and Transportation Officials, Inc.*

*This document was developed by the American Association of State Highway and Transportation Officials to provide recommended policies for bridge design.*

*American Association of State Highway and Transportation Officials, 440 North Capitol Street, N.W., Washington DC 20001, Telephone: (202) 624-5800, Fax: (202) 624-5806, Website: <<http://www.aashto.org>>.*



## APPENDIX

*American Association of State Highway and Transportation Officials, Task Force on Geometric Design (1999). Guide for the development of bicycle facilities. Washington, DC.*

This guide is designed to provide information on the development of facilities to enhance and encourage safe bicycle travel. The guide addresses planning and design issues that local, State, and Federal agencies face when implementing bicycle-related programs and facilities.

*American Association of State Highway and Transportation Officials, 440 North Capitol Street, N.W., Washington DC 20001, Telephone: (202) 624-5800, Fax: (202) 624-5806, Website: <<http://www.aashto.org>>.*

*American Society of Civil Engineers, National Association of Home Builders, The Urban Land Institute (1990). Residential streets: Second edition. Washington, DC: Bicycle Federation of America.*

This book outlines current practices in residential street design that provide good examples of design criteria. Specifications related to drainage, intersection, and pavement options are also provided.

*Bicycle Federation of America, 1506 21st Street, N.W., Suite 200,*

*Washington, DC 20036, Telephone: (202) 463-6622, Fax: (202) 463-6625, Email: [bfa@igc.org](mailto:bfa@igc.org) or [bikefed@aol.com](mailto:bikefed@aol.com).*

*Americans with Disabilities Act (ADA) (1990). Public Law 226, 101st Congress. (July 26, 1990).*

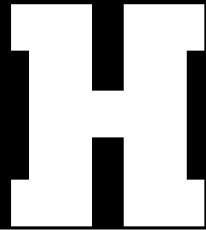
Civil rights legislation prohibiting discrimination against people with disabilities. Written by the 101st Congress of the United States.

*U.S. Government Printing Office, Superintendent of Documents, P.O. Box 371954, Pittsburgh, PA 15250-7954, Telephone: (202) 512-1800, Fax: (202) 512-2233.*

*Architecture and Engineering for Parks Canada, Public Works and Government Services Canada (1994). Design guidelines for accessible outdoor recreation facilities. Ottawa: Canada Paraplegic Association.*

Provides diagrams and design guidelines for developing accessible outdoor recreation facilities.

*Canadian Paraplegic Association, National Office, 1101 Prince of Wales Drive, Suite 320, Ottawa, Ontario K2C 3W7, Telephone: (613) 723-1033, Fax: (613) 723-1060.*



## APPENDIX

Ashmead, D.H., Hill, E.W., Talor, C.R. (1989). *Obstacle perception by congenitally blind children. Perception and Psychophysics*, 46, pp.425-433.

This study determined whether or not congenitally blind children were able to use nonvisual information to perceive objects.

Daniel H. Ashmead,  
Department of Psychology,  
Vanderbilt Bill Wilkerson Center for  
Otolaryngology and Communication Sciences,  
Vanderbilt University,  
Nashville, TN 37232-8700,  
Telephone: (615) 340-8280,  
Fax: (615) 343-7705,  
Email: ashmead@ctrvax.vanderbilt.edu.

Ashmead, D.H., Wall, R.S., Eaton, S.B., Ebinger, K.A., Snook-Hill, M.M., Yang, X. (1998a). *Echolocation reconsidered: Using spatial variations in the ambient sound field to guide locomotion. Journal of Visual Impairment and Blindness*.

This study determined the ability of people with visual disabilities to use ambient, low-frequency sound to guide their locomotion.

Daniel H. Ashmead,  
Department of Psychology,  
Vanderbilt Bill Wilkerson Center for  
Otolaryngology and Communication Sciences,  
Vanderbilt University,

Nashville, TN 37232-8700,  
Telephone: (615) 340-8280,  
Fax: (615) 343-7705,  
Email: ashmead@ctrvax.vanderbilt.edu.

Ashmead, D.H., Wall, R.S., Ebinger, K.A., Eaton, S.B., Snook-Hill, M.M. (1998b). *Spatial hearing in children with visual disabilities. Perception*, 27, pp.105-122.

This study determined whether spatial hearing in children with visual disabilities was equivalent to that of sighted people.

Daniel H. Ashmead,  
Department of Psychology,  
Vanderbilt Bill Wilkerson Center for  
Otolaryngology and Communication Sciences,  
Vanderbilt University,  
Nashville, TN 37232-8700,  
Telephone: (615) 340-8280,  
Fax: (615) 343-7705,  
Email: ashmead@ctrvax.vanderbilt.edu.

Axelson, P. (1988). *Technology as a Continuum for Recreation. Santa Cruz: PAX Press*.

This article analyzes recreational activities with respect to the user, commercial recreational equipment, and the environment and discusses where technology should and should not be applied in each of these areas.

PAX Press (a division of  
Beneficial Designs, Inc.),  
5858 Empire Grade,  
Santa Cruz, CA 95062





## APPENDIX

Telephone: (831) 429-8447,  
Fax: (831) 423-8450,  
Email: [paxpress@beneficialdesigns.com](mailto:paxpress@beneficialdesigns.com),  
Website: [www.beneficialdesigns.com](http://www.beneficialdesigns.com).

*Axelson, P., Chesney, D., Kelley, B., Longmuir, P., Pasternak, M., Wong, K., Wright, W. (1997). Universal trail assessment coordinator training guide. Santa Cruz: PAX Press.*

This book is a guide to the Universal Trail Assessment Process, which can be used to objectively assess outdoor recreation routes and recreation trails to collect access, mapping, usage, and maintenance information.

*Beneficial Designs, Inc.,  
5858 Empire Grade,  
Santa Cruz, CA 95060,  
Telephone: (831) 429-8447,  
Fax: (831) 423-8450,  
Email: [mail@beneficialdesigns.com](mailto:mail@beneficialdesigns.com),  
Website: [www.beneficialdesigns.com](http://www.beneficialdesigns.com).*

*Axelson, P.W., Chesney, D. (1999). Accessible exterior surfaces technical report. Submitted to U.S. Architectural and Transportation Barriers Compliance Board, Washington, DC.*

This report provides a detailed summary of research that analyzed the firmness and stability of trail surfaces.

*Beneficial Designs, Inc.,  
5858 Empire Grade,  
Santa Cruz, CA 95060,*

Telephone: (831) 429-8447,  
Fax: (831) 423-8450,  
Email: [mail@beneficialdesigns.com](mailto:mail@beneficialdesigns.com),  
Website: [www.beneficialdesigns.com](http://www.beneficialdesigns.com).

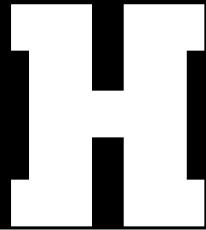
*Axelson, P.W., Chesney, D.A., Faraone, M., Kirschbaum, J.B., Longmuir, P.E., Richter, W.M., Wong, K.M. (1997). Accessible exterior surfaces: A review of existing test methods for surface firmness and stability: Phase 1 report. Washington, DC: U.S. Architectural and Transportation Barriers Compliance Board.*

This research report evaluates existing test methods to determine the accessibility of surfaces.

*Beneficial Designs, Inc.,  
5858 Empire Grade,  
Santa Cruz, CA 95060,  
Telephone: (831) 429-8447,  
Fax: (831) 423-8450,  
Email: [mail@beneficialdesigns.com](mailto:mail@beneficialdesigns.com),  
Website: [www.beneficialdesigns.com](http://www.beneficialdesigns.com).*

*Axelson, P.W., Chesney, D.A., Longmuir, P. (1995). Outdoor recreation access route (ORAR) and recreation trail design specification research: Final report. Martinsville: National Center on Accessibility.*

This study measures the difficulty experienced by wheelchair users and pedestrians traveling over a variety of surfaces with different grade and cross slope characteristics.



## APPENDIX

*Beneficial Designs, Inc.,  
5858 Empire Grade,  
Santa Cruz, CA 95060,  
Telephone: (831) 429-8447,  
Fax: (831) 423-8450,  
Email: mail@beneficialdesigns.com,  
Website: <www.beneficialdesigns.com>.*

*Axelson, P.W., Chesney, D.A., Minkel, J.,  
& Perr, A. (1998). The manual wheelchair  
training guide. Santa Cruz: PAX Press.*

This book was written to teach wheelchair users and their helpers how to access the world with a full range of manual wheelchair skills.

*PAX Press (a division of  
Beneficial Designs, Inc.)  
5858 Empire Grade,  
Santa Cruz, CA 95062,  
Telephone: (831) 429-8447 x107,  
Fax: (831) 423-8450,  
Email: paxpress@beneficialdesigns.com,  
Website: <www.beneficialdesigns.com>.*

*Axelson, P.W., Chesney, D., Longmuir, P.,  
Coutts, K., Rose, S., Smith, J., & Ysselstein, J.  
(1999). Accessible exterior surfaces technical  
article. Submitted to U.S. Architectural and  
Transportation Barriers Compliance Board,  
Washington, DC.*

An executive summary of the "Accessible Exterior Surfaces Technical Report" dated April 24, 1999. This report is available through the Access Board or Beneficial Designs.

*Beneficial Designs, Inc.,  
5858 Empire Grade,  
Santa Cruz, CA 95060,  
Telephone: (831) 429-8447,  
Fax: (831) 423-8450,  
Email: mail@beneficialdesigns.com,  
Website: <www.beneficialdesigns.com>.*

*Axelson, P.W., Chesney, D., Longmuir, P., &  
Wright, W. (1998). Computerized mapping of  
outdoor trails for accessibility. Submitted to  
National Institute of Child Health and Human  
Development, National Institutes of Health,  
Bethesda, MD.*

Final report for the Computerized Mapping of Outdoor Trails for Accessibility project and the development of the Universal Trail Assessment Process.

*Beneficial Designs, Inc.,  
5858 Empire Grade,  
Santa Cruz, CA 95060,  
Telephone: (831) 429-8447,  
Fax: (831) 423-8450,  
Email: mail@beneficialdesigns.com,  
Website: <www.beneficialdesigns.com>.*

*Axelson, P.W., Chesney, D.Y., Galvan, D.V.,  
Kirshbaum, J.B., Longmuir, P.E., Lyons, C., and  
Wong, K.M. (1999). Designing sidewalks and  
trails for access: Part I of II, Review of existing  
guidelines and practices. Washington, DC:  
Federal Highway Association.*



## APPENDIX

This report is Part I of a two phase project focused on designing sidewalks and trails that meet the needs of all users, including people with disabilities. This report contains an analysis of existing sidewalk and trail conditions, as well as an extensive literature review and a compilation of existing standards.

*National Technical Information Service,  
Springfield, VA 22161,  
Telephone: (703) 605-6000.*

*Barrier Free Environments, Inc. (1991). Uniform Federal Accessibility Standards (UFAS) retrofit manual. Washington, DC: U.S. Architectural and Transportation Barriers Compliance Board.*

This manual was designed to provide supplemental information regarding the application of the Uniform Federal Accessibility Standards in retrofit situations.

*U.S. Architectural and Transportation Barriers Compliance Board,  
1331 F Street, N.W., Suite 1000,  
Washington, DC 20004-1111,  
Telephone: (202) 272-5434.*

*Barrier Free Environments, Inc. (1996). Accessibility in Georgia: Governor's Council on Developmental Disabilities for Georgia.*

This is a technical and policy guide to access in Georgia.

*Governor's Council on Developmental Disabilities, Americans with Disabilities*

*Act (ADA) Program Consultant,  
254 Washington Street, S.W.,  
Atlanta, GA 30334,  
Telephone: (404) 657-7313,  
TDD: (404) 657-9993.*

*Bearden, D.M. (1998). Federal highway funding for air quality projects and transportation enhancements: How much, to whom, and for what? Washington, DC: Congressional Research Service, Library of Congress.*

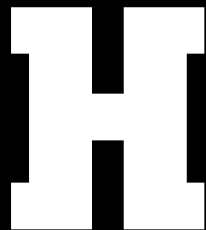
This report examines how Federal highway funding helps States address the environmental impacts of surface transportation. Funding structure, eligible project types, and other major funding situations are discussed.

*Congressional Research Service,  
Library of Congress,  
Washington, DC 20540-7000.*

*Beers, D. (1993 Draft). Klamath district's trail manual: Draft. Los Altos: California Trails Foundation.*

This manual contains equestrian and mountain bike trail information.

*Don Beers,  
North Coast Redwoods Headquarters,  
600-A West Clark,  
Eureka, CA 95501,  
Telephone: (707) 445-6547 ext.18,  
Fax: (707) 441-5737.*



## APPENDIX

*Bentzen, B.L. (1997). Environmental Accessibility. In B. Blasch, W. Wiener, R. Welsh (Eds.), Foundations of orientation and mobility: Second edition (pp. 317-356). New York: AFB Press, American Foundation for the Blind.*

This chapter of Foundations of Orientation and Mobility contains information pertaining to environmental accessibility.

*AFB Press, American Foundation for the Blind,  
11 Penn Plaza, Suite 300,  
New York, NY 10001*

*Bentzen, B.L., Barlow, J.M. (1995). Impact of curb ramps on the safety of persons who are blind. Journal of Visual Impairment and Blindness, 89, pp.319-328.*

The research presented in this article found that curb ramps do, in fact, affect the safety of individuals with visual impairments.

*AFB Press, American Foundation for the Blind,  
11 Penn Plaza,  
New York, NY 10001.  
Website: <[http://www.afb.org/r\\_dwrep.html](http://www.afb.org/r_dwrep.html)>.*

*Bentzen, B.L., Barlow, J.M., and Tabor, L.S. (2000). Detectable warnings: Synthesis of U.S. and international practice. Washington, DC: U.S. Access Board.*

An extensive, well-illustrated review of the state-of-the art use of under-foot warning surfaces in the U.S. and abroad. Includes a summary of and rationale for ADA provisions and a summary of ISO draft standards, standards and guidelines of numerous jurisdictions and publications, descriptions of existing U.S. products, and U.S. and international case studies. Emphasis is on truncated dome detectable warnings as specified in ADAAG 4.29.2.

*The Access Board,  
1311 F Street, N.W.,  
Washington, DC 20004-1111,  
Telephone: (202) 272-5434,  
TDD: (202) 272-5449,  
Fax: (202) 272-5447.*

*Bentzen, B.L., Jackson, R.M., Peck, A.F. (1981). Information about visual impairment for architects and transit planners. Washington, DC: U.S. Department of Transportation.*

This document reports on improving communications with the visually impaired in rail rapid-transit systems.

*National Technical Information Service,  
Springfield, VA 22161,  
Telephone: (703) 605-6000.*

*Bentzen, B.L., Nolin, T.L., Easton, R.D. (1994). Detectable warning surfaces: Color, contrast, and reflectance. Washington, DC: U.S. Department of Transportation.*



## APPENDIX

This laboratory study was conducted to determine the optimal physical properties of a detectable warning system, and to study properties such as contrast, hue, and reflectance.

*National Technical Information Service,  
Springfield, VA 22161,  
Telephone: (703) 605-6000.*

*Bentzen, B.L., Nolin, T.L., Easton, R.D., Desmarais, L., Mitchell, P.A. (1994). Detectable warnings: Detectability by individuals with visual impairments, and safety and negotiability on slopes for persons with physical impairments. Washington, DC: U.S. Department of Transportation.*

This study tested the configurations of a variety of detectable warnings against a number of surrounding surfaces and determined how well people with visual impairments, as well as people with physical disabilities, were able to detect and negotiate the surfaces.

*National Technical Information Service,  
Springfield, VA 22161,  
Telephone: (703) 605-6000.*

*Bentzen, B.L., Tabor, L.S. (1998). Accessible Pedestrian Signals. Washington, DC: U.S. Access Board.*

This report summarizes available types of accessible pedestrian signals. It analyzes when they are needed and what types of information

they provide. Audible broadcast, tactile, vibrotactile, and receiver-based systems are discussed.

*U.S. Architectural and Transportation Barriers Compliance Board,  
1111 18th Street, N.W., Suite 501,  
Washington, DC 20036,  
Telephone: (202) 272-5434,  
TDD: (202) 653-7848.*

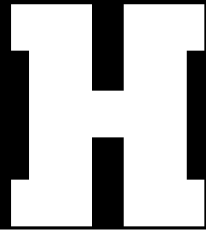
*Bhambhani, Y., Clarkson, H. (1989). Acute physiologic and perceptual responses during three modes of ambulation: Walking, auxiliary crutch walking, and running. Archives of Physical Medicine and Rehabilitation, 70, pp.445-450 (1989, June).*

This research studies the energy cost of walking, running, and crutch use for able-bodied adults.

*University of Alberta,  
Faculty of Rehabilitation Medicine,  
Dr. Bhambhani,  
Room 308 Corbett Hall,  
Edmonton, Alberta T6G2G4 Canada.*

*Bicycle Federation of America (1992). Case study no. 21: Integrating bicycle and pedestrian considerations into State and local transportation planning, design, and operations. Report # FHWA-PD-93-021. Washington, DC: Federal Highway Administration. Report # FHWA-PD-93-021.*





## APPENDIX

This report discusses methods to integrate bicycle and pedestrian considerations into State and local transportation planning, design, and operations.

*Federal Highway Administration,  
U.S. Department of Transportation,  
400 Seventh Street, S.W.,  
Washington, DC 20590.  
Fax requests to FHWA R&T Report Center:  
(301) 577-1421.*

*Bicycle Federation of America (1993a). Case study no. 5: An analysis of current funding mechanisms for bicycle and pedestrian programs at the federal, State, and local levels. Report # FHWA-PD-93-008. Washington, DC: Federal Highway Administration. Report # FHWA-PD-93-008.*

This document reviews funding sources for bicycle and pedestrian facilities available under ISTEA.

*Federal Highway Administration,  
U.S. Department of Transportation,  
400 Seventh Street, S.W.,  
Washington, DC 20590.  
Fax requests to FHWA R&T Report Center:  
(301) 577-1421.*

*Bicycle Federation of America (1993b). Case study no. 18: Final report, analyses of successful provincial, State, and local bicycle and pedestrian programs in Canada and the United States. Washington, DC: Federal Highway Administration. Report # FHWA-PD-93-010.*

This document reviews several State and local bicycle and pedestrian programs that have been exceptionally effective.

*Federal Highway Administration,  
U.S. Department of Transportation,  
400 Seventh Street, S.W.,  
Washington, DC 20590.  
Fax requests to FHWA R&T Report Center:  
(301) 577-1421.*

*Birchard, W. Jr., Proudman, R.D. (1981). Trail design, construction, and maintenance. Harpers Ferry: Appalachian Trail Conference.*

Written for trail workers who maintain the Appalachian Trail, this book provides information about designing, constructing, and maintaining outdoor recreation trails.

*Appalachian Trail Conference,  
P.O. Box 236,  
Harpers Ferry, WV 25425,  
Telephone: (304) 535-6331.*

*Birkby, R.C. (1996). Lightly on the land. Seattle: The Mountaineers.*

This book is a guide for building trails written for the Student Conservation Association. It explains techniques for using volunteers to design and maintain outdoor trails.

*The Mountaineers,  
1001 S.W. Klickitat Way,  
Seattle, WA 98134.*



## APPENDIX

*Bowman, B.L., Fruin, J.J., Zegeer, C.V. (1989). Planning, design, and maintenance of pedestrian facilities. McLean: Federal Highway Administration.*

This handbook's contents include pedestrian characteristics; results of pedestrian traffic and safety studies; pedestrian traffic control devices and procedures; pedestrian facilities in work zones; facility maintenance; and a summary of pedestrian facility problems.

*Research, Development and Technology, Turner-Fairbank Highway Research Center, 6300 Georgetown Pike, McLean, VA 22101-2296. Fax requests to FHWA R&T Report Center: (301) 577-1421.*

*Brock, W., Cunill, B., Dockter, S., Isom, J., King, G., Lindsey-Forester, J., Sparklin, D., Stevens, B. (1996). Community impact assessment: A quick reference for transportation. Washington, DC: Federal Highway Administration.*

This guide outlines the community impact assessment process, highlights areas that must be examined, and identifies basic tools and information sources planners can use to assess the impact of transportation projects.

*Office of Environment and Planning, Telephone: (202) 366-0106, Fax: (202) 366-3409.*

*Brown, S.A., Stein, S.M., Warner, J.C. (1996). Urban drainage design manual: Hydraulic engineering circular 22. Washington, DC: Federal Highway Administration.*

This book is a practical guide to designing storm drain systems connected with transportation facilities.

*National Technical Information Service, Springfield, VA 22161, Telephone: (703) 605-6000.*

*Burden, D., Wallwork, M. (1996). Handbook for walkable communities. High Springs.*

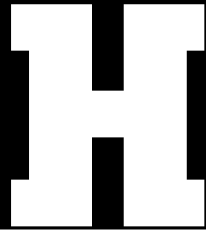
This handbook discusses problems that pedestrians face because of increased auto congestion and introduces planning and engineering principles designed to improve pedestrian safety. Alternatives to private automobile transportation are discussed as well.

*Dan Burden, Telephone: (904) 454-3304, Email: dburden@aol.com.*

*California State Parks (1997). Access to parks guidelines: California edition. Sacramento.*

This document contains the accessibility design guidelines for California State Parks.

*California State Parks Store, P.O. Box 942896, Sacramento, CA 94296-0001,*



## APPENDIX

*Ray Ann Watson (ADA Coordinator),  
Telephone: (916) 653-8148 or (916) 653-6995,  
To Order: (800) 888-0369,  
Fax: (916) 654-8928.*

*Center for Disease Control (1997). National health  
interview survey. Washington, DC: Author.*

This survey includes a variety of statistics  
including the percent of adults who are  
considered overweight.

*Center for Disease Control,  
Website: <[www.cdc.gov/](http://www.cdc.gov/)>.*

*Chesney, D.A., Axelson, P.W. (1994). Assessment  
of outdoor environments for accessibility.  
Proceedings of the Rehabilitation Engineering  
Society of North America. Arlington: RESNA  
Press.*

The objectives of this research project were  
to develop a quantitative system for assessing  
outdoor environments for accessibility and to  
evaluate the reliability of the methodology.

*Beneficial Designs, Inc.,  
5858 Empire Grade,  
Santa Cruz, CA 95060,  
Telephone: (831) 429-8447,  
Fax: (831) 423-8450,  
Email: [mail@beneficialdesigns.com](mailto:mail@beneficialdesigns.com),  
Website: <[www.beneficialdesigns.com](http://www.beneficialdesigns.com)>.*

*Cimarron Design (1994). Trails design and  
management handbook: Revision 1.1. Aspen:  
Pitkin County Open Space and Trails Program.*

This handbook contains the trail design  
standards for Pitkin County, Colorado.  
Separate standards are provided for hard  
surfaces and soft surfaces on multiple-use trails.

*Pitkin County Open Space and Trails,  
530 East Main Street, Suite 301,  
Aspen, CO 81611,  
Telephone: (970) 920-5232,  
Fax: (970) 920-5198.*

*City of Madison Department of Transportation  
(1997). Pedestrian transportation plan for  
Madison, Wisconsin. Madison: Author.*

This plan makes recommendations that  
are intended to enhance the pedestrian  
environment and increase opportunities  
to choose walking as a viable mode of  
transportation in Madison, Wisconsin.

*City of Madison Department of Transportation,  
P.O. Box 2986,  
Madison, WI 53701-2986,  
Telephone: (608) 266-6225,  
Fax: (608) 267-1158,  
Email: [aross@ci.madison.wi.us](mailto:aross@ci.madison.wi.us).*

*City of Portland, Bureau of Transportation  
Engineering and Development and the Pedestrian  
Transportation Program (1998). Pedestrian  
Master Plan. Portland.*

This is the Pedestrian Master Plan of Portland,  
Oregon. It contains construction guidelines  
and layouts used by the City of Portland to  
design pedestrian facilities.



## APPENDIX

*Pedestrian Transportation Program,  
1120 S.W. Fifth Avenue, Room 802,  
Portland, OR 97204-1971,  
Telephone: (503) 823-7211,  
Email: jean@sysgen.ci.portland.or.us.*

*City of Portland, Bureau of Maintenance. (1996).  
The sidewalk handbook. Portland.*

This brochure reviews property owners' responsibilities with regard to maintaining sidewalks and discusses available city support to repair sidewalks.

*Bureau of Maintenance,  
Sidewalk Repair,  
2929 N. Kerby Avenue,  
Portland, OR 97227,  
Telephone: (503) 823-1711,  
Fax: (503) 823-4043.*

*Clark-Carter, D.D., Heyes, A.D., Howarth, I.  
(1987). The gait of visually impaired pedestrians.  
Human Movement Science 6 (pp. 277-282).  
North Holland: Elsevier Science Publishers B.V.*

This research study documents the gait characteristics (speed, stride length, etc.) of adults with visual impairments.

*Elsevier Science, Regional Sales Office,  
Customer Support Department,  
P.O. Box 945,  
New York, NY 10159-0945,  
Telephone: (212) 633-3680 or  
(800) 4ES-INFO,*

*Fax: (212) 633-3680,  
Email: usinfo-f@elsevier.com.*

*Council of American Building Officials (1992).  
American national standard: Accessible and  
usable buildings and facilities (CABO/ANSI  
A117.1-1992). Falls Church.*

This manual provides recommendations for designing buildings and facilities that are accessible to and usable by people with disabilities.

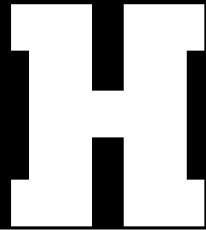
*Council of American Building Officials,  
5203 Leesburg Pike, #708,  
Falls Church, VA 22041,  
Telephone: (703) 931-4533.*

*Craul, Philip J., "Urban Soils: Applications  
and Practices," 1999. Formerly at Syracuse  
University, now at Harvard University.*

*De Leuw, C. Jr., Danielson, F., Kudlick, W.,  
Swan, S. (1981). Effective treatments of over- and  
under-crossings for use by bicyclists, pedestrians,  
and the handicapped. Washington, DC:  
Federal Highway Administration.*

This study provides information about improving access to under- and over-crossings for bicyclists, pedestrians, and the handicapped.

*National Technical Information Service,  
Springfield, VA 22161,  
Telephone: (703) 605-6000.*



## APPENDIX

*Department of Rehabilitation (1995). Access guide: Survey checklist. Sacramento.*

This booklet contains a checklist that can be used to determine whether buildings meet accessible accommodation requirements applicable within the State of California.

*Department of Rehabilitation,  
ADA Implementation Section,  
P.O. Box 944222,  
Sacramento, CA 94244-2220,  
Telephone: (916) 322-0251,  
TTY: (916) 322-1096,  
CALNET 492-0251 (Voice or TTY).*

*Designing for the 21st century: An international conference on universal design of information, products, and environments (1998). Proceedings. Raleigh: Barefoot Press.*

This document contains abstracts and meeting agendas from Designing for the 21st Century: An International Conference on Universal Design of Information, Products, and Environments held at Hofstra University in Hempstead, NY, June 17-21, 1998.

*The Center for Universal Design,  
School of Design, North Carolina State  
University, Box 8613,  
Raleigh, NC 27695-8613,  
Telephone: (800) 647-6777 or (919) 515-3082,  
Fax: (919) 515-3023,  
Email: cud@ncsu.edu.*

*DiStefano, J., Raimi, M. (1996). Five years of progress: 110 communities making a difference. Washington, DC: Surface Transportation Policy Project.*

This series of case studies highlights successful community projects using Federal transportation funds.

*Surface Transportation Policy Project,  
1100 Seventeenth Street, N.W., Tenth Floor,  
Washington, DC 20036,  
Telephone: (202) 466-2636,  
Fax: (202) 466-2247,  
Email: stpp@transact.org.*

*Division of Engineering, Lexington-Fayette County Urban Government (1993). Sidewalks: A homeowner's guide. Lexington.*

This booklet provides homeowners with an outline of the Urban County Government sidewalk inspection program. It is intended to aid property owners in the maintenance of any right-of-way adjoining their private property.

*Division of Engineering,  
Lexington-Fayette County Urban Government,  
Lexington-Fayette Government Building,  
200 East Main Street,  
Lexington, KY 40507,  
Telephone: (606) 258-3410.*

*Earnhart, G., Simon, L. (1987). Accessibility for elderly and handicapped pedestrians: A manual*





## APPENDIX

*for cities. McLean: Turner-Fairbank Highway Research Center.*

This handbook provides an overview of existing accessibility planning and programming. Each chapter provides definitions, illustrations, and Federal standards, if they exist, and includes a section on problems and recommended solutions.

*National Technical Information Service,  
Springfield, VA 22161,  
Telephone: (703) 605-6000.*

*Earnhart, G., & Simon, L. (1987). Accessibility for elderly and handicapped pedestrians: A manual for cities. McLean: U.S. Department of Transportation.*

This document contains revisions and interpretations of the 1973 Rehabilitation Act.

*National Technical Information Service,  
Springfield, VA 22161,  
Telephone: (703) 605-6000.*

*Environmental Design Research Association Annual Conference (1998). People, places, and public policy. Edmond: Environmental Design Research Association (EDRA).*

This document contains abstracts and meeting agendas from EDRA 29 held in St. Louis, Missouri, March 4-8, 1998.

*Environmental Design Research Association (EDRA),  
P.O. Box 7146,*

*Edmond, OK 73083-7146,  
Telephone: (405) 330-4863,  
Fax: (406) 330-4150,  
Email: edra@telepath.com.*

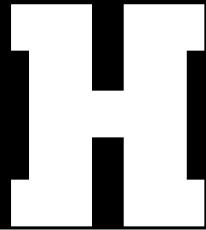
*Equal Employment Opportunity Commission, U.S. Department of Justice (1991). Americans with Disabilities Act (ADA) Handbook. Washington, DC.*

This handbook was written to provide information and assistance on the ADA to people with disabilities, businesses, and the public. It is a particularly valuable tool that contains EEOC Title I regulations and Department of Justice Title II and Title III regulations, together with a section-by-section analysis of each regulatory provision.

*U.S. Department of Justice,  
Telephone: (202) 514-0301 or (800) 514-0301,  
TTY: (800) 514-0383.*

*Farbman, A., Park, D.C. (1989d). Philosophical foundations in providing accessible recreation facilities. Design: Access 4: Philosophical Concepts: Accessible Picnic Areas and Campgrounds. pp.3-16. (Fall 1989). Washington, DC: Park Practice Program.*

This article is the last in a series of four outlining accessibility design requirements as they relate to standards development, access to buildings and structures, and access to outdoor recreation and trails.



## APPENDIX

*National Recreation and Park Association,  
22377 Belmont Ridge Road,  
Ashburn, VA 20148,  
Telephone: (703) 858-0784,  
Fax: (703) 858-0794.*

*Federal Highway Administration (1994).  
Final report: The national bicycling and  
walking study: Transportation choices for  
a changing America. Washington, DC.  
Report # FHWA-PD-94-023.*

This study analyzes the current (1994) state  
of bicycling and walking in the United States.

*Federal Highway Administration,  
Bicycle & Pedestrian Program Office,  
400 Seventh Street, S.W.,  
Washington, DC 20590.  
Fax requests to FHWA R&T Report Center:  
(301) 577-1421.*

*Federal Highway Administration (1996a).  
Chapter 18 facilities for pedestrians and  
bicyclists. Washington, DC.*

This book discusses taking bicyclists and  
pedestrians into consideration when  
proposed facilities are being designed.

*U.S. Government Printing Office,  
Superintendent of Documents,  
P.O. Box 371954,  
Pittsburgh, PA 15250-7954,  
Telephone: (202) 512-1800,  
Fax: (202) 512-2233.*

*Federal Highway Administration (1997a).  
Flexibility in highway design. Washington, DC.  
Report # FHWA-PD-97-062.*

This book identifies and explains the  
opportunities and constraints facing  
designers and design teams responsible for  
the development of transportation facilities.  
It includes many illustrations and examples  
of well-designed highways and roadways.

*Federal Highway Administration,  
U.S. Department of Transportation,  
400 Seventh Street, S.W.,  
Washington, DC 20590,  
Telephone: (202) 366-0106,  
Fax: (202) 366-3409.*

*Federal Highway Administration, Federal  
Transit Administration (1995). A guide to  
metropolitan transportation planning under  
ISTEA: How the pieces fit together. Washington,  
DC: Federal Highway Administration.  
Report # FHWA-PD-95-031.*

This guidebook describes how Metropolitan  
Planning Organizations operated under  
ISTEA. Long- and short-range plans are  
discussed in detail.

*Federal Highway Administration,  
U.S. Department of Transportation,  
400 Seventh Street, S.W.,  
Washington, DC 20590,  
Telephone: (202) 366-5003.*



## APPENDIX

*Federal Highway Administration, Manual on Uniform Traffic Control Devices (MUTCD) (2001) defines the standards used by road managers nationwide to install and maintain traffic control devices on all streets and highways.*

*<<http://mutcd.fhwa.dot.gov/>>.*

*Federal Highway Administration, National Highway Traffic Safety Administration (1996). Pedestrian and bicyclist safety and accommodation: Participant workbook. Washington, DC: Federal Highway Administration. Report # FHWA-PD-96-028.*

Prepared by Dan Burden and Betty Drake, this book supplements a National Highway Institute course that focused on pedestrian and bicycle safety and design. It outlines how focus groups and charities can be incorporated into a public participation model.

*Federal Highway Administration, U.S. Department of Transportation, 400 Seventh Street, S.W., Washington, DC 20590.*

*Fax requests to FHWA R&T Report Center: (301) 577-1421.*

*Federal Highway Transportation (1980). The feasibility of accommodating physically handicapped individuals on pedestrian over and under crossing structures: Final report. Washington, DC: Author.*

This report describes evaluations to determine major and minor access barriers for the physically handicapped.

*National Technical Information Service, Springfield, VA 22161, Telephone: (703) 605-6000.*

*Fischer, J.W. (1998a). ISTEA reauthorization: Highway and transit legislative proposals in the 105th Congress: Second session. Washington, DC: Congressional Research Service, Library of Congress.*

This report discusses the structure of the House and Senate proposals and provides an overview of the issues that might have come to the forefront during conference.

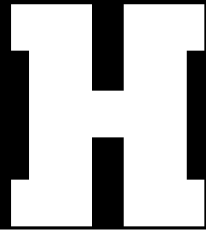
*Congressional Research Service, Library of Congress, Washington, DC 20540-7000.*

*Fischer, J.W. (1998b). Transportation trust funds: Budgetary treatment. Washington, DC: Congressional Research Service, Library of Congress.*

This report addresses issues associated with the purpose and use of transportation trust funds.

*Congressional Research Service, Library of Congress, Washington, DC 20540-7000.*

*Flasher, O.M., Kadar, E.E., Shaw, R.E. (1993). Dimensionless invariance for intentional systems: Measuring the fit of vehicular activities to environmental layout. In J.M. Flach, P.A. Hancock, J.K. Caird, K.J. Vicente. (Eds.),*



## APPENDIX

*An ecological approach to human-machine systems I: A global perspective. (pp. Chapter 11). Hillsdale: Lawrence Erlbaum Associates.*

This article considers how wheelchair users are able to select and follow the best route through cluttered and obstacle-laden courses. It discusses using dimensionless invariance to measure the dynamic fit of active wheelchairs through their functional spaces if given a navigational goal.

*Lawrence Erlbaum Associates,  
10 Industrial Avenue,  
Mahwah, NJ 07430-2262,  
Telephone: (201) 236-9500 or  
(800) 9-BOOKS-9,  
Fax: (201) 236-0072,  
Email: orders@erlbaum.com.*

*Florida Department of Transportation, State Safety Office, MS 82 (1997). Bicycle facilities planning and design handbook. Tallahassee: Bicycle and Pedestrian Program.*

This manual provides a practical overview of the concept and need for bicycle roadway planning. It includes defined terms, bicycle planning needs, principles, and issues. It also describes the bicycle planning process in terms of engineers and community collaboration.

*Florida Department of Transportation,  
Bicycle/Pedestrian Program,  
State Safety Office,  
605 Suwannee Street, Mail Station 82,  
Tallahassee, FL 32399-0450.*

*Gallon, C. (1992). Contractor report 317: Tactile surfaces in the pedestrian environment: Experiments in Wolverhampton. Crowthorne: Transport and Road Research Laboratory.*

This report looks at how effective tactile markings would be in a real pedestrian environment and what form the layout of these surfaces should take.

*Vehicles and Environment Division,  
Vehicles Group,  
Transport and Road Research Laboratory,  
Old Wokingham Road,  
Crowthorne, Berkshire RG11 6AU,  
Telephone: (STD 0344) 773131,  
Telex: 848272, Fax: 0344 770356.*

*Georgia Institute of Technology (1979). Provisions for elderly and handicapped pedestrians: Volume 1: Executive summary. Springfield: U.S. Department of Commerce.*

This document is an executive summary of research done regarding older pedestrians and pedestrians with disabilities. It outlines the research methodologies and summarizes the results of the study.

*National Technical Information Service,  
Springfield, VA 22161,  
Telephone: (703) 605-6000.*

*Gilbert, T.A., Goltsman, S.M., Wohlford, S.D. (1992). User's guide: The accessibility checklist: An evaluation system for buildings and outdoor settings. Berkeley: MIG Communications.*



## APPENDIX

A comprehensive checklist to determine whether buildings and outdoor settings comply with the ADA Guidelines, UFAS, and California's Title 24 building codes.

*MIG Communications,  
1802 Fifth Street,  
Berkeley, CA 94710,  
Telephone: (510) 845-0953.*

*Golden, M., Kilb, L., Mayerson, A. (1993).  
Americans with Disabilities Act: An  
implementation guide. Berkeley: Disability  
Rights Education and Defense Fund, Inc.*

This manual is designed to provide answers to questions businesses, organizations, and individuals might have about the ADA. The explanation of the law integrates the legislative history, the statute, the regulations and analyses, and Section 504 cases. A guide to legal documents, selected cases under Section 504, and a section on tax incentives is also included.

*DREDF,  
2212 Sixth Street,  
Berkeley, CA 94710,  
Telephone: (510) 644-2555 or (800) 466-4232.*

*Gray, D.B., & Hendershot, G.E. (2000).  
The ICIDH2: Developments for a new era of  
outcomes research. Manuscript in preparation.*

This article will review the important concepts that led to the development of the ICIDH,

describe conceptual problems with the ICIDH that led to its revision, outline the revision process, explicate the ICIDH-2 and discuss implications of the ICIDH2 as a conceptual framework for outcome measures.

*Greenways Incorporated (1992a). Case study  
no. 7: Transportation potential and other  
benefits of off-road bicycle and pedestrian  
facilities. Washington, DC: Federal Highway  
Administration. Report # FHWA-PD-92-040.*

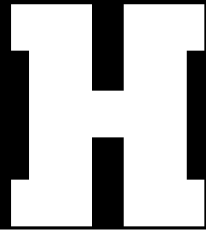
This report is a compendium of the benefits gained by having bicycle and pedestrian trails. It also cites examples of highly successful community greenways.

*Federal Highway Administration,  
U.S. Department of Transportation,  
400 Seventh Street S.W.,  
Washington, DC 20590.  
Fax requests to FHWA R&T Report Center:  
(301) 577-1421.*

*Greenways Incorporated (1992b). Case study  
no. 24: Current planning guidelines and design  
standards being used by State and local agencies  
for bicycle and pedestrian facilities. Washington,  
DC: Federal Highway Administration.  
Report # FHWA-PD-93-006.*

This is a review of some State and local existing bicycle and pedestrian programs to determine the state-of-practice. The report summarizes the best guidelines and standards currently





## APPENDIX

being used. It also names reference materials critical for leading-edge facility design.

*Federal Highway Administration,  
U.S. Department of Transportation,  
400 Seventh Street S.W.,  
Washington, DC 20590.  
Fax requests to FHWA R&T Report Center:  
(301) 577-1421.*

*Guth, D.A., Rieser, J.J. (1997). Perception and the control of locomotion by blind and visually impaired pedestrians. In B. B. Blasch, W. R. Wiener, R. L. Welsh (Eds.), Foundations of orientation and mobility: Second edition (pp.9 - 37). New York: AFB Press.*

This chapter from Foundations of Orientation and Mobility discusses how pedestrians with visual impairments obtain information about and navigate through the pedestrian environment.

*AFB Press,  
American Foundation for the Blind,  
11 Penn Plaza,  
New York, NY 10001,  
Website: <[http://www.afb.org/  
r\\_dwrep.html](http://www.afb.org/r_dwrep.html)>.*

*Hall, G., Rabelle, A., Zabihaylo, C. (1994). Audible traffic signals: A new definition. Montreal: Montreal Association for the Blind.*

This guidance document provides government agencies with information regarding audible traffic signals.

*Montreal Association for the Blind,  
7000 Shebrooke Street West,  
Montreal, Quebec H4B 1R3.*

*Hamilton, E.J., Burgess, F.M., Hepfer, P.C. (1998). Beach access: Assistive devices and surfaces research report. Martinsville: National Center on Accessibility.*

This study addresses the need for objective comparisons of the advantages and disadvantages of the available assistive devices developed for beach access.

*National Center on Accessibility,  
5040 State Road 67 North,  
Martinsville, IN 46151.  
Voice/TDD: (800) 424-1877 or  
(317) 349-3240,  
Email: [nca@indiana.edu](mailto:nca@indiana.edu).*

*Hauger, J.S., Rigby, J.C., Safewright, W.J., McAuley, W.J. (1996). Detectable warning surfaces at curb ramps. Journal of Visual Impairment & Blindness, 90, pp.512-525.*

This article includes tests of blind pedestrians' need for detectable warning surfaces at curb ramps.

*AFB Press,  
American Foundation for the Blind,  
11 Penn Plaza,  
New York, NY 10001.  
Website: <[http://www.afb.org/  
r\\_dwrep.html](http://www.afb.org/r_dwrep.html)>.*



## APPENDIX

*Hesselbarth, W., Vachowski, B. (1996). Trail construction and maintenance notebook. Missoula: United States Department of Agriculture Forest Service.*

Written in a concise pocket format that can be used while on the trail, this guide summarizes basic trail construction and maintenance information relevant to field work.

*USDA Forest Service,  
Missoula Technology and Development Center,  
Building One,  
Fort Missoula, Missoula, MT 59804-7294,  
Telephone: (406) 329-3900,  
Fax: (406) 329-3719.*

*Hooper, L. (1994). NPS trails management handbook. Denver: Denver Service Center.*

This book contains easily reduced drainage and construction guidelines.

*Lennon Hooper Trails Coordinator,  
National Park Service,  
P.O. Box 25287,  
655 Parfet Street,  
Denver, CO 80225.*

*Hopf, P.S., Raeber, J.A. (1984). Access for the handicapped. New York: Van Nostrand Reinhold Company Inc.*

This book provides information to make facilities suitable for use by the physically handicapped.

*Van Nostrand Reinhold Company Inc.,  
135 West Fiftieth Street,  
New York, NY 10020.*

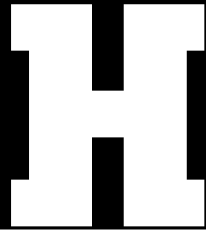
*Hughes, R.G. (1995). An evaluation of detectable warnings in curb ramps: Mobility considerations for the blind and visually impaired. Tallahassee: Florida Department of Transportation.*

This study tested the optimal configuration for detectable warnings installed on curb ramps. It also analyzed any difficulties subjects had with negotiating the ramp and provided recommendations on ramp design and configuration regarding tactile warnings.

*Theo Petritsch,  
State Pedestrian and Bicycle Coordinator,  
Florida Department of Transportation,  
605 Suwannee Street, MS-82,  
Tallahassee, FL 32399,  
Telephone: (850) 487-1200,  
Fax: (850) 922-2935,  
Email: [theopetritsch@dot.State.fl.us](mailto:theopetritsch@dot.State.fl.us).*

*Institute of Transportation Engineers (ITE),  
Technical Council Committee A-55 (1997a).  
Review of planning guidelines and design standards for bicycle facilities. Washington, DC:  
Institute of Transportation Engineers.*

This report defines planning guidelines and design standards used by States and localities to develop bicycle facilities and identify practices that can be used as models by other communities.



## APPENDIX

*Institute of Transportation Engineers, 525 School Street, S.W., Suite 410, Washington, DC 20024-2797, Telephone: (202) 554-8050, Fax: (202) 863-5486.*

*Institute of Transportation Engineers (ITE), Technical Council Committee 5A-5 (1998). Design and safety of pedestrian facilities. Chapel Hill.*

Provides design recommendations for developing safer and more accessible pedestrian friendly designs.

*Institute of Transportation Engineers, 525 School Street, S.W., Suite 410, Washington, DC 20024-2797, Telephone: (202) 554-8050, Fax: (202) 863-5486.*

*Institute of Transportation Engineers (ITE), Transportation Planning Council Committee 5P-8 (1997). Traditional neighborhood development: Street design guidelines. Washington, DC.*

This report, a recommended practice published by ITE, discusses traditional neighborhood development, design parameters, and community planning.

*Transportation Engineers, 525 School Street, S.W., Suite 410, Washington, DC 20024-2797, Telephone: (202) 554-8050, Fax: (202) 863-5486, Website: <<http://www.ite.org>>.*

*Intermodal Surface Transportation Efficiency Act (1991). Public Law 240, 102nd Congress (December 18th, 1991).*

This law authorized transportation funds to be spent on improving intermodal surface transportation alternatives for moving goods and people from 1991-1997.

*U.S. Government Printing Office, Superintendent of Documents, P.O. Box 371954, Pittsburgh, PA 15250-7954, Telephone: (202) 512-1800, Fax: (202) 512-2233.*

*Jacobson, W.H. (1993). The art and science of teaching orientation and mobility to persons with visual impairments. New York: American Foundation for the Blind.*

This textbook teaches orientation and mobility professionals to instruct people with visual impairments in wayfinding and navigation techniques.

*American Foundation for the Blind Press, 11 Penn Plaza, New York, NY 10001, Website: <[http://www.afb.org/r\\_dwrep.html](http://www.afb.org/r_dwrep.html)>.*

*Joffe, E. (Draft, 1994). Interim draft: A detectable warnings implementation document. Washington, DC: Federal Transit Administration.*

# H

## APPENDIX

This report contains technical help and information on the ADA Rule of 1991.

*American Foundation for the Blind Press, 11 Penn Plaza, New York, NY 10001, Website: <[http://www.afb.org/r\\_dwrep.html](http://www.afb.org/r_dwrep.html)>.*

*Kell, J.H., Fullerton, I.J. (1982). Manual of traffic signal design. Washington, DC: Institute of Transportation Engineers.*

This manual discusses how to design traffic signals that function well in the street environment.

*Institute of Transportation Engineers, 525 School Street, S.W., Suite 410, Washington, DC 20024-2797, Telephone: (202) 554-8050, Fax: (202) 863-5486, Website: <<http://www.ite.org>>.*

*Kentucky Department of Parks (1989). Trail construction and maintenance: Division of recreation and interpretation. Frankfort.*

This book contains guidelines for equestrian, hiking, OHV, and mountain bike trails.

*Kentucky Department of Parks, Telephone: (502) 564-2172.*

*Knoblauch, R.L., Crigler, K.L. (1987a). Model pedestrian safety program: User's guide. McLean: Federal Highway Administration.*

This guide describes how localities can plan, implement, and evaluate a pedestrian safety program.

*National Technical Information Service, Technology Administration, U.S. Department of Commerce, Springfield, VA 22161, Telephone: (703) 605-6000, Fax: (703) 321-8547.*

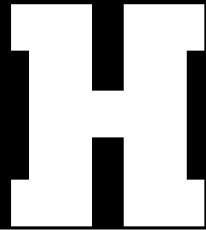
*LaPlante, J., Toole, J. (2000). Planning, design, and operation of pedestrian facilities: Preliminary draft interim report. Prepared for the National Cooperative Highway Research Program, the Transportation Research Board, and the National Research Council.*

This draft report is Part I of a two phase project sponsored by the National Cooperative Highway Research Program, the Transportation Research Board, and the National Research Council to develop design guidelines for pedestrian facilities.

*Lexington-Fayette Urban County Government (1993). Sidewalks: A homeowner's guide. Lexington.*

This booklet contains procedures for evaluating sidewalks and an outline of the local sidewalk improvement maintenance program.

*Lexington-Fayette Urban County Government, Division of Engineering, Lexington-Fayette Government Building,*



## APPENDIX

200 East Main Street,  
Lexington, KY 40507,  
Telephone: (606) 258-3410.

Long, R.G., Hill, E.W. (1997). *Establishing and maintaining orientation for mobility*. In B.B. Blasch, W.R. Wiener, R.L. Welsh (Eds.), *Foundations of orientation and mobility: Second edition* (pp. 39 - 59). New York: AFB Press.

This is a chapter from *Foundations of Orientation and Mobility* about spatial orientation of individuals who are blind or visually impaired. It focuses on spatial problems they must solve to move efficiently from place to place and the strategies or tools they use to solve them.

AFB Press,  
American Foundation for the Blind,  
11 Penn Plaza, New York, NY 10001,  
Website: <[http://www.afb.org/r\\_dwrep.html](http://www.afb.org/r_dwrep.html)>.

Mace, R.L., Hardie, G.J., Place, J.P. (1991). *Accessible environments: Toward universal design*. Raleigh: The Center for Universal Design.

This booklet discusses how universal design can benefit all segments of the population and suggests design principles that can be used to improve access to buildings, outdoor facilities, and other spaces. It also discusses the disabled population and provides an overview of the accommodations required by the Americans with Disabilities Act (ADA).

The Center for Universal Design,  
North Carolina State University,  
P.O. Box 8613,  
Raleigh, NC 27695-8613,  
Telephone and TDD: (919) 515-3082,  
Information Requests: (800) 647-6777.

Marcil, F. (1995). *Multi-use trails in Canada: An analysis of some successful cases*. Montreal: Velo Quebec.

This book discusses the importance of having multi-use trails in Canada. It pairs problems and situations with proposed ideas and solutions.

Velo Quebec,  
1251 Rue Rachel Est,  
Montreal, Quebec H2J 2J9,  
Telephone: (514) 521-8356,  
Fax: (514) 521-5711.

McAuley, W.J., Hauger, J.S., Safewright, M.P., Rigby, J.C. (1995). *The detectable warnings project*. Washington, DC: U.S. Architectural and Transportation Barriers Compliance Board.

This paper discusses the results of a study to determine the level of detectability of a variety of raised, tactile warning surfaces.

U.S. Access Board, Recreation Report,  
1331 F Street, N.W., Suite 1000,  
Washington, DC 20004-1111,  
Telephone: (202) 272-5434 or (800) 872-2253,  
TTY: (202) 272-5449 or (800) 993-2822,





## APPENDIX

Website: <<http://www.access-board.gov/rules/child.htm>>.

*Mickelson, L. (1985). Parkland access for the disabled. Vancouver: Greater Vancouver Regional District Parks Department and Advent Accounting Services Ltd.*

This publication is a design manual for planning and constructing accessible features outdoors. Text examples are heavily illustrated with diagrams of standard signage and facilities that include dimensions and useful accessories.

*Greater Vancouver Regional District Parks, 4330 Kingsway, Burnaby, British Columbia V5H 4G8.*

*Missouri Department of Natural Resources (1975). Missouri State Parks: Trail construction guidelines. Jefferson City.*

This booklet contains the Missouri State Trails System guidelines for trail construction, as well as the procedure for signing trails.

*Missouri Department of Natural Resources, Telephone: (573) 751-5360.*

*Moore, R.L. (1994). Conflicts on multiple-use trails: Synthesis of the literature and state of the practice. Washington, DC: Federal Highway Administration. Report # FHWA-PD-94-031.*

This report provides a synthesis of existing research to explain the underlying causes of trail conflict, identifies approaches for

promoting trail sharing, and identifies gaps in current knowledge. Principles for minimizing conflicts on multiple-use trails are also reviewed.

*Federal Highway Administration, U.S. Department of Transportation, 400 Seventh Street, S.W., Washington, DC 20590. Fax requests to FHWA R&T Report Center: (301) 577-1421.*

*National Council on Disability (1996). Achieving independence: The challenge for the 21st century: A decade of progress in disability policy: Setting an agenda for the future. Washington, DC.*

This book offers an assessment of the nation's progress in achieving equal opportunity and empowerment during the last decade.

*National Council on Disability, 1331 F Street, N.W., Suite 1050, Washington, DC 20004-1107, Telephone: (202) 272-2004, Fax: (202) 272-2022, TDD: (202) 272-2074.*

*New Jersey Department of Transportation (1996). Pedestrian-compatible planning and design guidelines. Trenton: New Jersey Department of Transportation, Bureau of Suburban Mobility.*

These guidelines include an overview of pedestrian activities and problems in

# H

## APPENDIX

New Jersey. Guidelines for accommodating pedestrians on roadways and design techniques encouraging pedestrian travel are also included.

*Bill Feldman,  
Pedestrian and Bicycle Advocate,  
New Jersey Department of Transportation,  
1035 Parkway Avenue,  
P.O. Box 600,  
Trenton, NJ 08625-0600,  
Telephone: (609) 530-8062,  
Fax: (609) 530-3723,  
Email: billatng@aol.com.*

*Nordhaus, R.S., Kantrowitz, M.,  
Siembieda, W.J. (1984). Accessible fishing:  
A planning handbook. Santa Fe: New Mexico  
Natural Resources Department.*

This document presents accessibility design guidelines for most fishing situations.

*Resource Management and  
Development Division,  
New Mexico Natural Resources Department,  
Villagra Building,  
408 Galisteo, Suite 129,  
Santa Fe, NM 87504-1147.*

*O'Leary, A.A., Lockwood, P.B., Taylor, R.V.,  
Lavelly, J.L. (1995). An evaluation of detectable  
warning surfaces for sidewalk curb ramps.  
Richmond: Virginia Department of  
Transportation.*

The authors of this report that investigates the usage of raised detectable warnings, such as truncated domes on curb ramps and other sidewalk environments.

*National Technical Information Service,  
Technology Administration,  
U.S. Department of Commerce,  
Springfield, VA 22161,  
Telephone: (703) 605-6000,  
Fax: (703) 321-8547.*

*Office of Traffic Operations, Federal Highway  
Administration (1982). Standard alphabets  
for highway signs and pavement markings.  
Washington, DC: U.S. Department of  
Transportation.*

This is the latest series of Standard Metric Alphabets for Highway Signs and Pavement Markings created by the Federal Highway Administration at the request of the National Advisory Committee on Uniform Traffic Control Devices.

*U.S. Government Printing Office,  
Superintendent of Documents,  
P.O. Box 371954,  
Pittsburgh, PA 15250-7954,  
Telephone: (202) 512-1800,  
Fax: (202) 512-2233.*

*Ontario Parks (1996). Barrier-free guidelines  
design manual. Ottawa.*



## APPENDIX

This report presents guidelines for accessible design. Different needs and types of disabilities are also discussed.

*Ontario Parks,  
300 Water Street,  
P.O. Box 700,  
Peterborough, Ontario K9J 8M5,  
Telephone: (705) 755-PARK,  
Fax: (705) 755-1701,  
Email: [ontparks@www.mnr.gov.on.ca](mailto:ontparks@www.mnr.gov.on.ca).*

*Oregon Department of Transportation (1995).  
Oregon bicycle and pedestrian plan. Salem.*

This book is a guideline for State and local entities in Oregon involved in establishing bicycle and pedestrian facilities on local transportation systems.

*Bicycle and Pedestrian Program,  
Room 210, Transportation Building,  
Salem, OR 97310,  
Telephone: (503) 986-3555,  
Fax: (503) 986-3749, Email:  
[michael.p.ronkin@odot.State.or.us](mailto:michael.p.ronkin@odot.State.or.us).*

*Park, D.C. (1989a). Designing for everyone:  
Part of the public is disabled. Design: Access 1:  
Standards Development: Space Requirements,  
pp.3-16 (Winter 1989). Washington, DC:  
Park Practice Program.*

This document is the first in a series of four articles outlining accessibility design requirements as they relate to standards

development, access to buildings and structures, and access to outdoor recreation and trails.

*National Recreation and Park Association,  
22377 Belmont Ridge Road,  
Ashburn, VA 20148,  
Telephone: (703) 858-0784,  
Fax: (703) 858-0794.*

*Park, D.C. (1989b). What is accessibility? Design:  
Access 2: Access to Buildings and Structures.  
pp.3-16 (Spring 1989).*

This document is the second in a series of four articles outlining accessibility design requirements as they relate to standards development, access to buildings and structures, and access to outdoor recreation and trails.

*National Recreation and Park Association,  
22377 Belmont Ridge Road,  
Ashburn, VA 20148,  
Telephone: (703) 858-0784,  
Fax: (703) 858-0794.*

*Park, D.C., Farbman, A. (1989c). Accessible  
outdoor recreation facilities. Design Access 3:  
Access to Outdoor Recreation: Trails. pp.3-11  
(Summer 1989). Washington, DC: Park Practice  
Program.*

This document is the third in a series of four articles outlining accessibility design requirements as they relate to standards

development, access to buildings and structures, and access to outdoor recreation and trails.

*National Recreation and Park Association, 22377 Belmont Ridge Road, Ashburn, VA 20148, Telephone: (703) 858-0784, Fax: (703) 858-0794.*

*Peck, A.F., Bentzen, B.L. (1987). Tactile warnings to promote safety in the vicinity of transit platform edges. Washington, DC: US Department of Transportation.*

This study discusses the effectiveness of tactile warning materials to assist visually-impaired travelers in hands-on station environments. It includes a laboratory evaluation of transit service and additional evaluation of two particular warning systems.

*National Technical Information Service, Springfield, VA 22161, Telephone: (703) 605-6000.*

*Pedestrian Federation of America (1995). Walk tall: A citizens' guide to walkable communities. Emmaus: Rodale Press.*

This publication contains stories, ideas, suggestions, resources, and various charts for easy use by people of the community.

*Rodale Press, Inc., 33 East Minor Street, Emmaus, PA 18098.*

*Pein, W.E. (1996). Trail intersection design guidelines. Tallahassee: Florida Department of Transportation.*

This publication addresses the details associated with trail-roadway intersection design, with views toward minimizing accidents and problems at crossing points.

*Theo Petritsch, State Pedestrian and Bicycle Coordinator, Florida Department of Transportation, 605 Suwannee Street, MS-82, Tallahassee, FL 32399, Telephone: (850) 487-1200, Fax: (850) 922-2935, Email: theopetritsch@dot.State.fl.us.*

*Pennsylvania Trails Program (1980a). Motorized trails: An introduction to planning and development. Harrisburg: The Pennsylvania Trails Program, Division of Outdoor Recreation, Bureau of State Parks.*

This is a guide to designing trails to be used by motorized vehicles.

*Pennsylvania State Parks, Telephone: (717) 787-6674.*

*Pennsylvania Trails Program (1980b). Nonmotorized trails: An introduction to planning and development. Harrisburg: The Pennsylvania Trails Program, Division of Outdoor Recreation, Bureau of State Parks.*



## APPENDIX

This is a guide for developing nonmotorized trails and maximizing public use of existing trails. It also includes a section on improving access for people with disabilities.

*Pennsylvania State Parks,*  
Telephone: (717) 787-6674.

*Perry, J., Garrett, M., Gronley, J.K., Mulroy, S.J. (June 1995). Classification of walking handicap in the stroke population. Stroke 26, pp. 982-989.*

This research identifies and evaluates the walking efficiency of individuals who have had a stroke.

*American Heart Association,*  
*Western States Affiliate,*  
1710 Gilbreth Road,  
Burlingame, CA 94010-13317,  
Telephone: (650) 259-6700 or  
(800) AHA-USA1,  
Fax: (650) 259-6891.

*PLAE, Inc. (1993). A design guide: Universal access to outdoor recreation. Berkeley.*

This book provides a framework for determining the appropriate level of accessibility in a range of outdoor recreational settings and contains detailed guidelines for designing the elements and spaces necessary for ensuring accessible paths, signage, restrooms, and other outdoor facilities.

*MIG Communications,*  
1802 Fifth Street,  
Berkeley, CA 94710,  
Telephone: (510) 845-0953,  
Fax: (510) 845-8750.

*Pollak, P.B. (1999). Livable communities: An evaluation guide. Washington, DC: American Association of Retired Persons (AARP), Public Policy Institute.*

This guide was produced in order to develop a means whereby community residents could determine the extent to which communities encouraged or impeded independence as residents aged.

*AARP,*  
*Public Policy Institute,*  
601 E Street, N.W.,  
Washington, DC 20049.

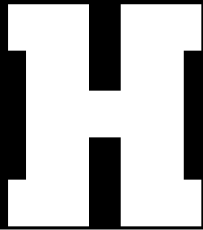
*City of Portland (1998). Portland pedestrian design guide. Portland.*

This is the curb ramp section of the design guidelines for pedestrian facilities in Portland.

*Pedestrian Transportation Program,*  
1120 S.W. Fifth Avenue, Room 802,  
Portland, OR 97204-1971,  
Telephone: (503) 823-7004,  
Email: pedprogram@syseng.ci.portland.or.us.

*Pro Bike/Pro Walk 98 (1998). Creating bicycle-friendly and walkable communities:*





## APPENDIX

*Building for the next generation. Washington, DC: Bicycle Federation of America, Inc.*

This document contains abstracts and meeting agendas from Pro Bike/Pro Walk 98 held in Santa Barbara, CA, September 8-11, 1998.

*Bicycle Federation of America,  
1506 21st Street, N.W., Suite 200,  
Washington, DC 20036,  
Telephone: (202) 463-6622,  
Fax: (202) 463-6625,  
Email: bikefed@aol.com.*

*Project for Public Spaces, Inc. (1993). Case study no. 20: The effects of environmental design on the amount and type of bicycling and walking. Washington, DC: Federal Highway Administration. Report # FHWA-PD-93-037.*

This study summarizes knowledge on the impact of environmental design on walking and bicycling. It also identifies successes and failures in the downtown design environment and the factors that promote effective bicycle and walking use.

*Federal Highway Administration,  
U.S. Department of Transportation,  
400 Seventh Street, S.W.,  
Washington, DC 20590.  
Fax requests to FHWA R&T Report Center:  
(301) 577-1421.*

*Pugh, B. (1989). A bikeway design cookbook. Roseville: BP Engineering.*

This manual contains excerpts from the 2010 Sacramento City/County Bikeway Master Plan. It discusses design standards, figures, uniform traffic control devices, and includes a chapter on signage and roadway traffic diagram figures.

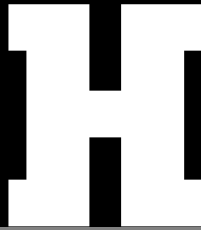
*BP Engineering,  
P.O. Box 1385,  
Roseville, CA 95678-8385,  
Telephone: (916) 771-4563,  
Fax: (916) 771-4569,  
Email: BIKEFED@aol.com.*

*Rabelle, A., Zabihaylo, C., Gresset, J. (1998). Detectability of warning tiles by functionally blind persons: Effects of warning tiles, width and adjoining surfaces texture. In E. Siffermann, M. Williams, B.B. Blasch (Eds.), Proceedings of the Ninth International Mobility Conference (pp. 38-41). Decatur: Rehabilitation Research and Development Center.*

This study determines the width needed for pedestrians to detect the presence of truncated domes and other detectable warning systems.

*Rails to Trails Conservancy, Association of Pedestrian and Bicycle Professionals (1998). Improving conditions for bicycling and walking: A best practice report. Washington, DC: Federal Highway Administration.*

This is a compilation of walking and biking plans from many different cities and states.



## APPENDIX

An abbreviated list of their restrictions and requirements is included.

*Rails to Trails Conservancy,*  
1100 Seventeenth Street, N.W., Tenth Floor,  
Washington, DC 20036,  
Telephone: (202) 331-9696,  
Website: <[www.railtrails.org](http://www.railtrails.org)>.

*Rathke, D.M., Baughman, M.J. (1994).*  
*Recreational trail design and construction.*  
St. Paul: Educational Development System,  
Minnesota Extension Service, University  
of Minnesota.

This publication was designed to be used by small organizations or private individuals to design and construct trails. It contains step-by-step construction methods.

*University of Minnesota,*  
*Minnesota Extension Service,*  
*Distribution Center, 20 Coffey Hall,*  
*1420 Eckles Avenue,*  
*St. Paul, MN 55108-6069,*  
*Fax: (612) 625-6281.*

*Recreation Access Advisory Committee (1994).*  
*Recommendation for accessibility guidelines:*  
*Recreational facilities and outdoor developed areas.* Washington, DC: U.S. Architectural and Transportation Barriers Compliance Board.

*This report contains the scoping technical requirements and rationale of the Recreation Access Advisory Committee for accessible*

*outdoor recreational facility. It contains both final guidelines and proposed work perimeters.*

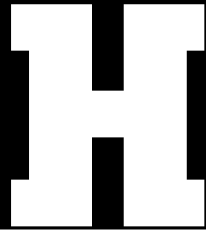
*Access Board,*  
*Recreation Report,*  
*1331 F Street, N.W., Suite 1000,*  
*Washington, DC 20004-1111,*  
*Telephone: (202) 272-5434 or*  
*(800) 872-2253,*  
*TTY: (202) 272-5449 or (800) 993-2822,*  
*Website: <<http://www.access-board.gov/rules/child.htm>>.*

*Rickert, T. (1998). Mobility for all: Accessible transportation around the world. Redwood City: Health and Welfare Ministries, General Board of Global Ministries, The United Methodist Church.*

This is a guide to making transportation accessible for persons with disabilities and elders in countries around the world. This document is available in Spanish as well.

*Health and Welfare Ministries,*  
*General Board of Global Ministries,*  
*The United Methodist Church,*  
*475 Riverside Drive, Room 330,*  
*New York, NY 10115,*  
*Telephone: (212) 870-3870,*  
*Fax: (212) 870-3624,*  
*Email: [kreeves@gbgm-umc.org](mailto:kreeves@gbgm-umc.org).*

*Ryan, K. (1993). Trails for the twenty-first century. Covelo: Island Press.*



This book introduces the concept of the multi-use trail and promotes bicycle and pedestrian travel.

*Island Press,*  
24850 East Lane, P.O. Box 7,  
Covello, CA 95428,  
Telephone: (707) 983-6432,  
Fax: (707) 983-6414,  
Email: [ipwest@igc.apc.org](mailto:ipwest@igc.apc.org),  
Website: [www.islandpress.org](http://www.islandpress.org).

*San Francisco Bureau of Engineering (1996). Warning strips for the visually disabled and blind pedestrian. San Francisco Bureau of Engineering internal report, San Francisco.*

This study was conducted by the San Francisco Department of Public Works to determine whether guide strips used in crosswalks are durable enough to withstand the impact of heavy traffic use. This study tested a variety of different types of guide strips.

*Joe Ovadia, Project Manager,*  
*San Francisco Bureau of Engineering,*  
*Telephone: (415) 558-4004.*

*Richard Skaff, Disability Access Coordinator,*  
*San Francisco Department of Public Works,*  
*30 Van Ness Avenue,*  
*5th Floor,*  
*San Francisco, CA 94102,*  
*Email: [richardskaff@amer.net](mailto:richardskaff@amer.net).*

*Sanford, J.A. (1985). Designing for orientation and safety. Proceedings of the International*

*Conference on Building Use and Safety Technology (pp. 54-59). Atlanta: Georgia Institute of Technology.*

This study determines whether different surfaces are detectable by people with visual impairments and how the properties of different surfaces affect their detectability. It also presents results of tests of the ability of people with visual disabilities to stop after detecting a warning.

*Sanford, J.A., Steinfeld, E. (1985). Designing for orientation and safety. Proceedings of the International Conference on Building Use and Safety Technology (pp. 54-59). Washington, DC: National Institute of Building Sciences.*

This study discussed the properties of different detectable warnings and how well people with visual disabilities were able to detect them. It also discussed the navigational techniques of people with visual impairments and how they interacted with the detectable warning, as well as the usage and interpretation of architectural space by visually impaired people versus sighted people.

*Sawai, H., Takato, J., Tauchi, M. (1998). Quantitative measurements of tactile contrast between dot and bar tiles used to constitute tactile pathway for the blind and visually impaired independent travelers. In E. Sifferman, M. Williams, B.B. Blasch (Eds.), Proceedings of the Ninth International Mobility Conference*



## APPENDIX

(pp. 178-181). Decatur: Rehabilitation Research and Development Center.

This study discusses the ability of people with visual disabilities to detect the difference between the two types of detectable warnings, a dot tile served to alert pedestrians, and a bar tile served to guide pedestrians along a given path.

*Schmid, J. (1997). American trails: 1997 trails resource bibliography. Prescott: American Trails.*

A bibliography of 941 publications and videos containing information about trails.

*American Trails,*  
P.O. Box 11046,  
Prescott, AZ 86304-1046,  
Telephone: (520) 632-1140,  
Fax: (520) 632-1147,  
Email: Amtrails@lankcaster.com,  
Website: <<http://www.americantrails.org>>.

*Seeing Eye, The (Producer) (1996). Partners in travel [Videotape]. Morristown: Independence and Dignity.*

This video provides an overview of guide dogs and how they can aid people with visual impairments.

*Independence and Dignity,*  
P.O. Box 375,  
Morristown, NJ 07963-0375.

*Siwek, S.J., Associates (1996). Statewide transportation planning under ISTEA: A new framework for decision making. Washington, DC: Federal Highway Administration. Report # FHWA-PD-96-026A.*

This guidebook describes how the Intermodal Surface Transportation Equity Act affected State departments of transportation. Long- and short-range plans are discussed in detail.

*Federal Highway Administration,*  
U.S. Department of Transportation,  
400 Seventh Street, S.W.,  
Washington, DC 20590,  
Telephone: (202) 366-4000.

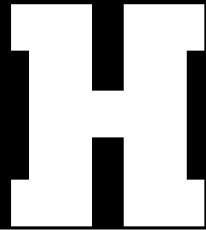
*Space Options®. Researched tolerances for flatness for ramps.*

*Kapaau Kohala, HA 96755-0910.*

*Staplin, L., Lococo, K., Byington, S. (1998). Older driver highway design handbook. McLean: Office of Safety and Traffic Operations R&D.*

This project included literature reviews and meta-analytic techniques in the areas of age-related functional capabilities, human factors, and highway safety. A User-Requirements Analysis to gauge the needs of highway design is also used in this study.

*National Technical Information Service,*  
Technology Administration,  
U.S. Department of Commerce,



## APPENDIX

Springfield, VA 22161,  
Telephone: (703) 605-6000,  
Fax: (703) 321-8547.

*Steinfeld, E., Schroeder, S., Bishop, M. (1979). Accessible buildings for people with walking and reaching limitations. Washington, DC: U.S. Department of Housing and Urban Development (HUD).*

This document presents research regarding the special needs of people with walking and reaching limitations in relation to building design and spatial layout.

*HUD User,  
P.O. Box 6091,  
Rockville, MD 20849,  
Telephone: (301) 251-5154 or (800) 245-2691.*

*Templer, J. (1980). An implementation manual: Provisions for the elderly and handicapped pedestrians. Washington, DC: Federal Highway Administration.*

This book identifies and defines the shortcomings of the pedestrian environment, then giving feasible solutions.

*U.S. Government Printing Office,  
Superintendent of Documents,  
P.O. Box 371954,  
Pittsburgh, PA 15250-7954,  
Telephone: (202) 512-1800,  
Fax: (202) 512-2233.*

*Templer, J.A. (1980a). Provisions for elderly and handicapped pedestrians: Volume 2: Hazards,*

*barriers, problems, and the law. Washington, DC: Federal Highway Administration.*

This survey was conducted to determine problems experienced by elderly and disabled pedestrians.

*National Technical Information Service,  
Springfield, VA 22161,  
Telephone: (703) 605-6000.*

*Templer, J.A. (1980b). Provisions for elderly and handicapped pedestrians: Volume 3: The development and evaluation of countermeasures. Springfield: U.S. Department of Commerce.*

This report presents the findings of several counter-measures designed to improve access for older pedestrians and people with disabilities in sidewalk environments.

*National Technical Information Service,  
Springfield, VA 22161,  
Telephone: (703) 605-6000.*

*Templer, J.A. (1980c). The feasibility of accommodating physically handicapped individuals on pedestrian over- and under-crossing structures. Washington, DC: Federal Highway Administration.*

The objective of this study was to determine the problems faced by people with disabilities when they encounter over- and under-crossing structures.

*National Technical Information Service,  
Technology Administration,*





## APPENDIX

*U.S. Department of Commerce,  
Springfield, VA 22161,  
Telephone: (703) 605-6000,  
Fax: (703) 321-8547.*

*The Resources Agency, Department of Parks and Recreation (1998). Trails handbook. Sacramento: California State Parks.*

This handbook, which has not been published, provides guidance on designing, constructing, and maintaining outdoor trails.

*Don Beers,  
North Coast Redwoods Headquarters,  
600-A West Clark,  
Eureka, CA 95501,  
Telephone: (707) 445-6547 ext.18,  
Fax: (707) 441-5737.*

*Transportation Equity Act for the Twenty-First Century (1998). Public Law 178, 105th Congress (June 6th, 1998).*

This law authorizes transportation funds to be spent on improving intermodal surface transportation alternatives for moving goods and people for 1998-2003.

*U.S. Government Printing Office,  
Superintendent of Documents,  
P.O. Box 371954,  
Pittsburgh, PA 15250-7954,  
Telephone: (202) 512-1800,  
Fax: (202) 512-2233.*

*U.S. Architectural and Transportation Barriers Compliance Board (1985). Detectable tactile*

*surface treatments: Phase 1: Introduction and laboratory testing: Final report. Washington, DC: U.S. Architectural and Transportation Barriers Compliance Board.*

This is a study of the detectability of different types of surface warning systems. It investigates how the different properties of these surface systems affect perceptions of people with visual disabilities.

*Access Board,  
Recreation Report,  
1331 F Street, N.W., Suite 1000,  
Washington, DC 20004-1111,  
Telephone: (202) 272-5434 or  
(800) 872-2253,  
TTY: (202) 272-5449 or (800) 993-2822,  
Website: <<http://www.access-board.gov/rules/child.htm>>.*

*U.S. Architectural and Transportation Barriers Compliance Board (1991). 36 CFR part 1191: Americans with Disabilities Act (ADA): Accessibility guidelines for buildings and facilities: State and local government facilities. (July 26, 1991). Washington, DC.*

This document contains Sections 1 through 12 of the ADA Accessibility Guidelines. Design guidance for built facilities are included in this document. Sections 1-10 in this document are equivalent to the ADA Standards for Accessible Design, which are enforceable standards under the U.S. Department of Justice.

# H

## APPENDIX

*U.S. Government Printing Office,  
Superintendent of Documents,  
P.O. Box 371954,  
Pittsburgh, PA 15250-7954,  
Telephone: (202) 512-1800,  
Fax: (202) 512-2233.*

*U.S. Architectural and Transportation Barriers  
Compliance Board (1994a). Bulletin #4: Surfaces.  
Washington, DC.*

This bulletin clarifies the requirements for accessible surfaces. It defines what is considered firm, stable, and slip-resistant; provides methods to assess firmness and slip resistance; and discusses what materials are considered to comply with ADAAG.

*Access Board, Recreation Report,  
1331 F Street, N.W., Suite 1000,  
Washington, DC 20004-1111,  
Telephone: (202) 272-5434 or  
(800) 872-2253,  
TTY: (202) 272-5449 or (800) 993-2822,  
Website: <[http://www.access-board.gov/  
rules/child.htm](http://www.access-board.gov/rules/child.htm)>.*

*U.S. Architectural and Transportation Barriers  
Compliance Board (1994b). 36 CFR Part 1191:  
Americans with Disabilities Act (ADA)  
Accessibility guidelines for buildings and  
facilities; State and local government facilities:  
Interim final rule. Federal Register, vol. 59,  
no. 117 (June 24th, 1994). Washington, DC.*

This document is the set of interim final guidelines published by the Access Board.

It provides additional guidance to the existing ADA Accessibility Guidelines (ADAAG). Section 14, which covers accessibility for public rights-of-way, is included in this interim final rule.

*U.S. Government Printing Office,  
Superintendent of Documents,  
P.O. Box 371954,  
Pittsburgh, PA 15250-7954,  
Telephone: (202) 512-1800,  
Fax: (202) 512-2233.*

*U.S. Architectural and Transportation Barriers  
Compliance Board (1996). Bulletin 1: Detectable  
Warnings. Washington, DC.*

This bulletin was written to alert the public to the requirements of installing detectable warnings.

*Access Board, Recreation Report,  
1331 F Street, N.W., Suite 1000,  
Washington, DC 20004-1111,  
Telephone: (202) 272-5434 or  
(800) 872-2253,  
TTY: (202) 272-5449 or (800) 993-2822,  
Website: <[http://www.access-board.gov/  
rules/child.htm](http://www.access-board.gov/rules/child.htm)>.*

*U.S. Architectural and Transportation Barriers  
Compliance Board (Producer) (1997). Accessible  
sidewalks: Design issues for pedestrians with  
disabilities [Videotape]. Washington, DC:  
U.S. Architectural and Transportation Barriers  
Compliance Board.*



## APPENDIX

This video presents design recommendations for making sidewalks accessible to pedestrians who use wheelchairs.

*Access Board, Recreation Report, 1331 F Street, N.W., Suite 1000, Washington, DC 20004-1111, Telephone: (202) 272-5434 or (800) 872-2253, TTY: (202) 272-5449 or (800) 993-2822, Website: <<http://www.access-board.gov/rules/child.htm>>.*

*U.S. Architectural and Transportation Barriers Compliance Board (1998). 36 CFR part 1191: Americans with Disabilities Act (ADA): Accessibility guidelines for buildings and facilities: State and local government facilities: Final rule. Federal Register, vol. 63, no. 8. (January 13th, 1998). Washington, DC. (Soon to become part of ADAAG.)*

The Access Board is issuing final guidelines to provide additional guidance with the new construction and alternations of State and local government facilities. This is to help ensure that government facilities are readily accessible to and usable by individuals with disabilities.

*Access Board, Recreation Report, 1331 F Street, N.W., Suite 1000, Washington, DC 20004-1111, Telephone: (202) 272-5434 or (800) 872-2253, TTY: (202) 272-5449 or (800) 993-2822,*

*Website: <<http://www.access-board.gov/rules/child.htm>>.*

*U.S. Architectural and Transportation Barriers Compliance Board (1999a). Accessible rights-of-way: A design guide. Washington, DC: Author.*

This document outlines the relationship between public rights-of-way and the Americans with Disabilities Act (ADA). Detailed design recommendations that meet the needs of people with disabilities are provided.

*Access Board, Recreation Report, 1331 F Street, N.W., Suite 1000, Washington, DC 20004-1111, Telephone: (202) 272-5434 or (800) 872-2253, TTY: (202) 272-5449 or (800) 993-2822, Website: <<http://www.access-board.gov/rules/child.htm>>.*

*U.S. Architectural and Transportation Barriers Compliance Board (1999b). Recommendations for accessibility guidelines: Outdoor developed areas final report. Washington, DC: Author.*

This document is the final report of the Regulatory Negotiation Committee on Accessibility Guidelines for Outdoor Developed Areas. The report contains accessibility recommendations for trails and other outdoor recommendation facilities, such as picnic areas.

# H

## APPENDIX

*Access Board, Recreation Report, 1331 F Street, N.W., Suite 1000, Washington, DC 20004-1111, Telephone: (202) 272-5434 or (800) 872-2253, TTY: (202) 272-5449 or (800) 993-2822, Website: <<http://www.access-board.gov/rules/child.htm>>.*

*U.S. Department of Agriculture, Alaska Region Forest Service (1991). Alaska region trails construction and maintenance guide. Anchorage.*

This document contains trail design and maintenance guidelines for the Forest Service in the Alaskan region.

*Alaska Federal Office Building, 709 West Ninth Street, P.O. Box 21628, Juneau, AK 99802-1628  
DG: Mailroom: R10A.*

*U.S. Department of Agriculture, Forest Service (1984). Standard specifications for construction of trails. Washington, DC: U.S. Government Printing Office.*

These U.S. Forest Service design guidelines provide specifications for trail construction.

*USDA Forest Service, Engineering Staff, Attn: Publications Specialist, P.O. Box 2417,*

*Washington, DC 20013, Telephone: (703) 235-8198.*

*U.S. Department of Agriculture, Forest Service (1985). Trails management handbook. Washington, DC.*

This handbook consists of guidelines used by the U.S. Forest Service to manage trails. Includes sections on trail planning, development, reconstruction and construction, trail operation and maintenance, and construction and maintenance exhibits.

*USDA Forest Service, Engineering Staff, Attn: Publications Specialist, P.O. Box 2417, Washington, DC 20013, Telephone: (703) 235-8198.*

*U.S. Department of Agriculture, Forest Service (1996). Outdoors for Everybody. Washington, DC: Author.*

This booklet contains accessible recreation opportunities in the Northern Region National Forest. The booklets are available free of cost from all of the forests listed in the booklet.

*Jane Ruchman, Gallatin National Forest, Box 130, Bozeman, MT 59771, Telephone: (406) 587-6966, TDD: (406) 587-6801.*



## APPENDIX

*U.S. Department of Commerce, Bureau of the Census (1994). Americans with disabilities. [http://www.census.gov/apspd/www/statbrief/sb94\\_1.pdf](http://www.census.gov/apspd/www/statbrief/sb94_1.pdf). (July 9, 1998).*

This is a summary of the 1990 U.S. Census data on people with disabilities.

*Customer Services: (301) 763-4100,  
Persons with Disabilities Contact:  
John McNeil, (301) 763-8300,  
Statistical Briefs Contact:  
Robert Bernstein, (301) 763-1584.*

*U.S. Department of Defense, U.S. General Services Administration, U.S. Department of Housing and Urban Development, U.S. Postal Service (1984). Uniform Federal accessibility standards. Washington, DC.*

This document contains accessibility guidelines that should be used by Federal agencies to comply with the Rehabilitation Act of 1973.

*Access Board, Recreation Report, 1331 F Street, N.W., Suite 1000, Washington, DC 20004-1111, Telephone: (202) 272-5434 or (800) 872-2253, TTY: (202) 272-5449 or (800) 993-2822, Website: <<http://www.access-board.gov/rules/child.htm>>.*

*U.S. Department of Justice (1991a). 28 CFR part 35: Nondiscrimination on the Basis of Disability in State and Local Government. Washington, DC.*

This rule implements subtitle A of title II of the Americans with Disabilities Act (ADA), Pub. L. 101-336, which prohibits discrimination on the basis of disability by public entities.

*U.S. Department of Justice,  
Telephone: (202) 514-0301 or (800) 514-0301,  
TTY: (800) 514-0383.*

*U.S. Department of Justice (1991b). 28 CFR part 36: Americans with Disabilities Act (ADA). Standards for Accessible Design. Washington, DC.*

The purpose of this part is to implement title III of the Americans with Disabilities Act (ADA) of 1990, which prohibits discrimination on the basis of disability by public accommodations. This document contains accessibility standards for the Americans with Disabilities Act (ADA), which are based on the ADA Accessibility Guidelines published by the U.S. Access Board.

*U.S. Department of Justice,  
Telephone: (202) 514-0301 or (800) 514-0301,  
TTY: (800) 514-0383.*



# H

## APPENDIX

*U.S. Department of Justice (1993a). The Americans with Disabilities Act (ADA), Title II: Technical assistance manual: Covering State and local government programs and services: 1993. Washington, DC.*

This manual presents the ADA's requirements for State and local governments in a focused, systematic description. Questions, answers, and illustrations are used throughout to convey points.

*U.S. Department of Justice,  
Telephone: (202) 514-0301 or (800) 514-0301,  
TTY: (800) 514-0383.*

*U.S. Department of Justice (1993b). The Americans with Disabilities Act (ADA), Title III: Technical assistance manual: Covering public accommodations and commercial facilities. Washington, DC.*

This manual presents the ADA's requirements for public accommodations, commercial facilities, and private entities offering certain examinations and courses in a focused, systematic description. Questions, answers, and illustrations are used throughout to convey points.

*U.S. Department of Justice,  
Telephone: (202) 514-0301 or (800) 514-0301,  
TTY: (800) 514-0383.*

*U.S. Department of Justice (1994a). The Americans with Disabilities Act (ADA), Title II:*

*Technical assistance manual: 1994 supplement. Washington, DC.*

This document contains material to be added to the Americans with Disabilities Act (ADA), Title II Technical Assistance Manual. These supplements are to be inserted, as appropriated, at the end of each chapter of the manual.

*U.S. Department of Justice,  
Telephone: (202) 514-0301 or (800) 514-0301,  
TTY: (800) 514-0383.*

*U.S. Department of Justice (1994b). 28 CFR part 36: Nondiscrimination on the basis of disability by public accommodations and in commercial facilities: Revised edition. Federal Register (July 1, 1994). Washington, DC.*

This is an updated document that contains the implementing regulations for Title III of the Americans with Disabilities Act (ADA) of 1990, which prohibits discrimination on the basis of disability by public accommodations. ADA Title III Department of Justice implementation regulations, including Americans with Disabilities Act Accessibility Guidelines/ADA Standards for Accessible Design (ADAAG).

*U.S. Government Printing Office,  
Superintendent of Documents,  
P.O. Box 371954,  
Pittsburgh, PA 15250-7954,  
Telephone: (202) 512-1800,  
Fax: (202) 512-2233.*



## APPENDIX

*U.S. Department of Justice (1996a). A guide to disability rights laws. Washington, DC.*

This bulletin lists settlements, agreements, and cases of Americans with Disabilities Act (ADA) litigation; provides resources for entities seeking ADA technical assistance; lists other sources for ADA information; and provides an address to file complaints.

*U.S. Department of Justice,  
Telephone: (202) 514-0301 or (800) 514-0301,  
TTY: (800) 514-0383.*

*U.S. Department of Justice (1996b). Enforcing the Americans with Disabilities Act (ADA): A status report from the Department of Justice: Issue three. Washington, DC.*

This booklet provides a short overview of Federal civil rights laws that ensure equal opportunity for people with disabilities and lists contact agencies and organizations.

*U.S. Department of Justice,  
Telephone: (202) 514-0301 or (800) 514-0301,  
TTY: (800) 514-0383.*

*U.S. Department of Justice, Architectural and Transportation Barriers Compliance Board, U.S. Department of Transportation (1994). 28 CFR part 36, 36 CFR part 1191, 49 CFR part 37: Americans with Disabilities Act (ADA) accessibility guidelines: Detectable warnings: Joint final rule. Federal Register, vol. 59, no. 70 (April 12, 1994). Washington, DC.*

This document sets forth the Department of Justice implementing regulations for Americans with Disabilities Act Accessibility Guidelines / ADA Standards for Accessible Design (ADAAG) regarding detectable warnings.

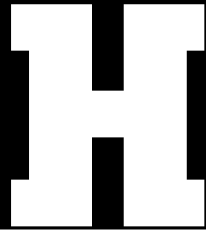
*U.S. Government Printing Office,  
Superintendent of Documents,  
P.O. Box 371954,  
Pittsburgh, PA 15250-7954,  
Telephone: (202) 512-1800,  
Fax: (202) 512-2233.*

*U.S. Department of Transportation (1988). Manual on uniform traffic control devices. Washington, DC: Federal Highway Administration.*

This text, including traffic lights and signs, lists National standards for traffic control devices and their colors, markings, dimensions, and placement. These guidelines must be followed by all public authorities having jurisdiction over traffic control. Numerous diagrams and examples of signs are included.

*U.S. Government Printing Office,  
Superintendent of Documents,  
P.O. Box 371954,  
Pittsburgh, PA 15250-7954,  
Telephone: (202) 512-1800,  
Fax: (202) 512-2233.*

*U.S. Department of Transportation (1991). 49 CFR parts 27, 37, 38: Transportation for*



## APPENDIX

*individuals with disabilities: Final rule. Federal Register, vol. 56, no. 173. (September 6, 1991). Washington, DC.*

This is the final rule implementing the transportation provisions of the ADA. The rule contains provisions on the acquisition of accessible vehicles by private and public entities and contains the amendment to the implementation of Section 504 of the Rehabilitation Act of 1973.

*U.S. Government Printing Office,  
Superintendent of Documents,  
P.O. Box 371954,  
Pittsburgh, PA 15250-7954,  
Telephone: (202) 512-1800,  
Fax: (202) 512-2233.*

*U.S. Department of Transportation (1992).  
Assessment of Detectable Warning Devices  
for Specification Compliance or Equivalent  
Facilitation. Washington, DC: Federal Transit  
Administration.*

This report addresses issues associated with the Architectural and Transportation Barriers Compliance Board (Access Board) specification for detectable warnings for the visually impaired.

*National Technical Information Service,  
Springfield, VA 22161,  
Telephone: (703) 605-6000.*

*U.S. Department of Transportation (1994a).  
Detectable Warnings: Testing and Performance*

*Evaluation at Transit Systems. Washington, DC:  
Federal Transit Administration.*

This report presents the results of a comprehensive testing and performance evaluation program for detectable warning materials placed along the edges of a transit station platform.

*National Technical Information Service,  
Springfield, VA 22161,  
Telephone: (703) 605-6000.*

*U.S. Department of Transportation (1994b).  
Glossary of transportation terms. Washington,  
DC: Federal Highway Administration.*

This English/Spanish version is a translation of the Urban Public Transportation Glossary that was published by the Transportation Research Board (TRB).

*Federal Highway Administration,  
U.S. Department of Transportation,  
400 Seventh Street, S.W.,  
Washington, DC 20590,  
Telephone: (202) 366-4000.*

*U.S. Department of Transportation (1994c).  
Innovations in public involvement for  
transportation planning. Washington, DC:  
Federal Highway Administration.*

This report provides synopses of different methods for involving the public in transportation planning. A description of each technique, the intended audience, the



## APPENDIX

method of participation, how the output might be utilized, the costs, advantages, drawbacks, references, contacts to obtain more information, and issues of special concern are discussed for each technique.

*Federal Highway Administration,  
U.S. Department of Transportation,  
400 Seventh Street, S.W.,  
Washington, DC 20590,  
Telephone: (202) 366-4000.*

*U.S. Department of Transportation (1995).  
Working together on transportation planning:  
An approach to collaborative decision making.  
Washington, DC: Federal Highway  
Administration.*

This report provides guidelines for planning transportation projects within a coalition of government agencies, community groups, special-interest groups, elected officials, minorities, and private-sector interests.

*Federal Highway Administration,  
U.S. Department of Transportation,  
400 Seventh Street, S.W.,  
Washington, DC 20590,  
Telephone: (202) 366-4000.*

*U.S. Department of Transportation (1996).  
Public involvement techniques for transportation  
decision making. Washington, DC: Federal  
Highway Administration.*

This reference lists techniques to involve the public in transportation planning, enumerating the pros and cons. One chapter is devoted to the Americans with Disabilities Act (ADA).

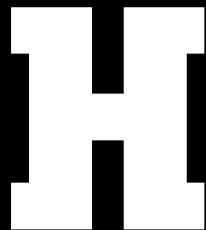
*Federal Highway Administration,  
U.S. Department of Transportation,  
400 Seventh Street, S.W.,  
Washington, DC 20590,  
Telephone: (202) 366-4000.*

*U.S. Department of Transportation (1998).  
Bicycle and Pedestrian Provisions of the Federal  
Aid Program. Washington, DC: U.S. Department  
of Transportation.*

This pamphlet summarizes the bicycle and pedestrian provisions of Transportation Equity Act for the 21st Century (TEA-21). It discusses its implications as well as funding sources for bicycle and pedestrian projects and new research areas, special studies, and reports created by the legislation.

*Federal Highway Administration,  
Bicycle & Pedestrian Program Office,  
400 Seventh Street, S.W.,  
Washington DC 20590.  
Fax requests to FHWA R&T Report Center:  
(301) 577-1421, Publication # FHWA-PD-98-  
049 HEP-10/8-98 (20M)E.*

*Federal Highway Administration (2000). Bicycle  
and pedestrian design guidance. Washington,  
DC: U.S. Department of Transportation.*



## APPENDIX

This document was developed as a result of TEA-21 and contains a national policy statement regarding sidewalk installation. This document was created by the Federal Highway Administration in conjunction with several other agencies and organizations that address pedestrian issues.

*Federal Highway Administration,  
Bicycle & Pedestrian Program Office,  
400 Seventh Street, S.W.,  
Washington DC 20590.*

*Website: <[www.fhwa.dot.gov/environment/bikeped/](http://www.fhwa.dot.gov/environment/bikeped/)>.*

*United Kingdom Department of the Environment, Transport, and the Regions, The Scottish Office (notified draft) (1997). Guidance on the use of tactile paving surfaces. London.*

These design guidelines discuss mobility for people with visual impairments and provide specifications for tactile delineator strips on segregated, shared cycle track/footways.

*Sue Sharp,  
Mobility Policy Branch,  
Great Minister House, Room 1/11,  
76 Marsham House, London SW1P 4DR,  
Telephone: 0171-271-5256,  
Divisional inquiries: 0171-271-5252,  
Fax: 0171-271-5253,  
Email: [mu.dot@gtnet.gov.uk](mailto:mu.dot@gtnet.gov.uk).*

*University of North Carolina, Highway Safety Research Center (1996). Florida pedestrian*

*planning and design guidelines. Tallahassee: State of Florida Department of Transportation.*

This manual provides guidelines, standards, and criteria for the planning, design, construction, operation, and maintenance of pedestrian facilities.

*Theo Petritsch,  
State Pedestrian and Bicycle Coordinator,  
Florida Department of Transportation,  
605 Suwannee Street, MS-82,  
Tallahassee, FL 32399,  
Telephone: (850) 487-1200,  
Fax: (850) 922-2935,  
Email: [theopetritsch@dot.State.fl.us](mailto:theopetritsch@dot.State.fl.us).*

*Vic Roads Principal Traffic Engineer's Department Quality and Technical Resources Division (1995). Vic Roads: Providing for people with disabilities: Traffic engineering guidelines. Kew: Vic Roads.*

These guidelines can be used to improve existing road accessibility conditions.

*Vic Roads Bookshop,  
Sixty Denmark Street,  
KEW Vic 3101,  
Melbourne, Australia,  
Telephone: (03) 854-2782,  
Fax: (03) 853-0084.*

*Ward, K.H., Meyers, M.C. (April 1995). Exercise performance of lower-extremity amputees. Sports Medicine, 20, pp.207-214.*





## APPENDIX

This is a review of published literature relating to walking speed and energy cost during ambulation for individuals with lower-extremity amputation as well as able-bodied individuals.

*Adis International Inc.,  
860 Town Center Drive,  
Langhorne, PA 19047,  
Telephone: (215) 741-5200,  
Fax: (215) 741-5251,  
Website: <www.adis.com>.*

*Washington State Department of Transportation (1997). Pedestrian facilities guidebook: Incorporating pedestrians into Washington's transportation system. Olympia: Author.*

This guidebook provides planning and design guidelines for pedestrian facilities used by the Washington State Department of Transportation.

*Washington Department of Transportation,  
Bike and Pedestrian Program,  
P.O. Box 47393,  
Olympia, WA 98504,  
Telephone: (360) 705-7505.*

*Wellar, B. (1996). Pedestrian perspectives on intersection performance: a case study report on channelization. Ottawa, Ontario: Mobility Services Division, Regional Municipality of Ottawa-Carleton, and Department of Geography, University of Ottawa.*

This paper presents the methodology, findings, and recommendations of an in-depth investigation into problems at the "busiest" intersection in Ottawa-Carleton, Canada.

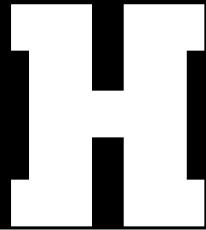
*Professor Barry Wellar,  
Department of Geography,  
University of Ottawa,  
Ottawa, Ontario K1N 6N5,  
Telephone: (613) 562-5725,  
Fax: (613) 562-5145,  
Email: wellar@uottawa.ca.*

*Wellar, B. (1997). Walking security index variables: Initial specification. Ottawa: Mobility Services Division, Regional Municipality of Ottawa-Carleton, and Department of Geography, University of Ottawa.*

This is the interim report of an in-depth investigation into problems at the "busiest" intersection in Ottawa-Carleton.

*Professor Barry Wellar,  
Department of Geography,  
University of Ottawa,  
Ottawa, Ontario K1N 6N5,  
Telephone: (613) 562-5725,  
Fax: (613) 562-5145,  
Email: wellar@uottawa.ca.*

*Wellar, B. (1998a). Walking security index. Ottawa: Mobility Services Division, Regional Municipality of Ottawa-Carleton, and Department of Geography, University of Ottawa.*



## APPENDIX

This is the final report of an in-depth investigation into problems at the “busiest” intersection in Ottawa-Carleton.

*Professor Barry Wellar,  
Department of Geography,  
University of Ottawa,  
Ottawa, Ontario K1N 6N5,  
Telephone: (613) 562-5725,  
Fax: (613) 562-5145,  
Email: wellar@uottawa.ca.*

*Wellar, B. (1998b). The walking security index (WSI) as a means of harmonizing transportation and community goals. Ottawa: Mobility Services Division, Regional Municipality of Ottawa-Carleton, and Department of Geography, University of Ottawa.*

This paper was prepared for presentation at the “Cities, Towns and Traffic” session of the 1998 Annual Conference of the Transportation Association of Canada in Regina, Saskatchewan.

*Professor Barry Wellar,  
Department of Geography,  
University of Ottawa,  
Ottawa, Ontario K1N 6N5,  
Telephone: (613) 562-5725,  
Fax: (613) 562-5145,  
Email: wellar@uottawa.ca.*

*Wernex, J. (1994). Off-highway motorcycle and ATV trails: Guidelines for design, construction,*

*maintenance, and user satisfaction: Second edition. Westerville: American Motorcyclist Association.*

This document outlines design guidelines for off-highway vehicle trails.

*American Motorcyclist Association,  
13515 Yarmouth Drive,  
Pickerington, OH 43147,  
Telephone: (614) 856-1900,  
Fax: (614) 856-1920,  
Email: ama@ama-cycle.org.*

*Whitstock, R.H., Franck, L., Haneline, R. (1997). Dog Guides. In B. Blasch, W. Wiener, R. Welsh (Eds.), Foundations of Orientation and Mobility: Second edition (pp. 260-283). New York: AFB Press, American Foundation for the Blind.*

This chapter of Foundations of Orientation and Mobility contains information pertaining to guide dogs. It includes information on training and responsibilities, and a section on the growth of the guide dog movement.

*AFB Press,  
American Foundation for the Blind,  
11 Penn Plaza, Suite 300,  
New York, NY 10001*

*Wilderness Act (1964). Public Law 88-577,  
88th Congress (September 3, 1964).*

Established the National Wilderness Preservation System for the permanent



## APPENDIX

good of the American people for present and future generations and for other purposes.

Website: <[www.fs.fed.us/outernet/htnf/wildacta.htm](http://www.fs.fed.us/outernet/htnf/wildacta.htm)>.

*Wilderness Inquiry, Inc. (1992). Wilderness accessibility for people with disabilities. Washington, DC: National Council on Disability.*

This report contains the findings of a study that examined the policies used by land management agencies to improve accessibility for people with disabilities. The National Council on Disability's recommendations for improving access to wilderness areas are also included in this report.

*National Council on Disability,  
800 Independence Avenue, S.W.,  
Suite 814,  
Washington, DC 20591.*

*Wilderness Inquiry, Inc. (1995). Wilderness access decision tool. Washington, DC: United States Department of Agriculture Forest Service.*

This document was designed to help all managers of Federal wilderness areas improve access to their trails.

*Arthur Carhart National Wilderness Training Center,  
20325 Remount Road,  
Huson, MT 59846,  
Telephone: (406) 626-5208,  
Fax: (406) 626-5395.*

*Wilkinson, W.C., III. (1993). Case study no. 10: Trading off among the needs of motor vehicle users, pedestrians, and bicyclists. Washington, DC: Federal Highway Administration. Report # FHWA-PD-94-012.*

This document reviews the needs and conflicts of various roadway and sidewalk users.

*Federal Highway Administration,  
U.S. Department of Transportation,  
400 Seventh Street, S.W.,  
Washington, DC 20590.  
Fax requests to FHWA R&T Report Center:  
(301) 577-1421.*

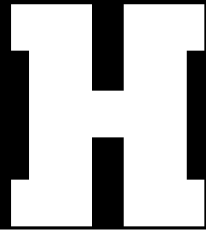
*Wisconsin Department of Natural Resources (1994). Department design standards handbook. Madison.*

This document outlines design standards for new outdoor recreation facilities.

*Wisconsin Department of Natural Resources,  
Telephone: (608) 266-7356.*

*Woo, J., Ho, S.C., Lau, J., Chan, S.G., & Yuen, Y.K. (1995). Age-associated gait changes in the elderly: Pathological or physiological? Neuroepidemiology, 14, pp.65-71.*

In this study, the walking speed and stride length of men and women 70 years of age were evaluated to determine changes in gait associated with aging.



## APPENDIX

*Publisher S. Karger, AG,  
P.O. Box CH-4009,  
Basel, Switzerland,  
Web site: [www.karger.com](http://www.karger.com).*

*World Health Organization (1980).  
International classification of impairments,  
disabilities, and handicaps: A manual of  
classification relating to the consequences  
of disease. Geneva: WHO.*

This document provides internationally accepted standard definitions to identify and distinguish among impairment, disability, and handicap.

*World Health Organization,  
Headquarters,  
Avenue Appia 20,  
1211 Geneva 27, Switzerland,  
Telephone: (+00 41 22) 791 21 11,  
Facsimile (fax): (+00 41 22) 791 3111,  
Web site: <http://www.who.int/>*

*World Health Organization (1999). ICIDH-2:  
International classification of functioning and  
disability. Geneva: WHO.*

A draft classification, issued for field trial purposes, which provides a unified and standard language and framework for the description

of human functioning and disability as an important component of health. ICIDH-2 is part of the WHO family of international classifications for the standardized coding of health-related information.

*World Health Organization,  
Headquarters,  
Avenue Appia 20,  
1211 Geneva 27, Switzerland,  
Telephone: (+00 41 22) 791 21 11,  
Facsimile (fax): (+00 41 22) 791 3111,  
Web site: <http://www.who.int/>*

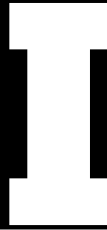
*Zegeer, C.V., Stewart, J.R., and Huang, H.  
(1999). Safety Effects of Marked Vs Unmarked  
Crosswalks at Uncontrolled Crossing Locations.  
Washington, D.C.: UNC Highway Safety  
Research Center.*

This document summarizes a study comparing pedestrian crash experience on marked versus unmarked crosswalks which have no traffic signals or stop signs.

*Federal Highway Administration,  
Bicycle & Pedestrian Program Office,  
400 Seventh Street S.W.,  
Washington DC 20590.  
Fax requests to FHWA R&T Report Center:  
(301) 577-1421.*





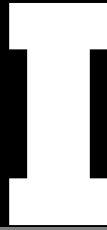


# Appendix I

## Index

### A

- AASHTO Guide, 14-1, 14-10
- Acceptable design, 1-7, 5-5, 7-19
- Access Board, U.S., 1-8, 1-9, 4-25, 6-6, 6-13, 8-14, 12-23, 15-2, 15-11
  - recommendations, 1-7, 1-8, 15-20
  - Technical Bulletin #4, 4-25, 4-39, 14-7, 15-11
- Accessible Pedestrian Signals (APS), 6-1, 6-12
- Accessible Rights-of-Way, 1-8
- ADAAG, 7-24, 7-28, 14-5, 16-4
  - guidelines, 1-2, 1-6, 3-2, 4-20, 4-29, 12-3, 15-2, 15-19, 15-28, 15-40
  - permits, 7-23
  - provisions, 12-3
  - regulations, 12-4, 14-3
  - requirements, 12-22
  - sign standards, 6-5
  - specifications, 4-9, 6-6, 18-5
- Adhesive sticker, 18-6
- Advanced Notice of Proposed Rulemaking, 1-9, 12-4
- Air Quality Improvement Program, 3-15
- Ambulatory impairments, 8-17
- American Association of State Highways, 3-7, 19-4
- American Council of the Blind, 3-21
- Americans with Disabilities Act (ADA)
  - Accessibility Guidelines (ADAAG), 1-2, 1-6, 3-2, 4-20, 4-29, 6-3, 10-1, 12-3, 15-2, 15-19, 15-28, 15-40
  - Coordinator/Citizen's Commission, 3-21
  - Implementing Regulations, 3-5
  - Standards 1-7
  - Titles I, II, III 1-6
  - transition plans, 11-1, 19-3
- Archaeological
  - site, 12-12
  - feature, 12-12
- Architectural Barriers Act (ABA), 1-6, 1-7
- Asian design, 19-2
- Asphalt
  - road, 7-31
  - surface, 4-25,
- Aesthetic relief, 4-2,
- Audible
  - beacon, 2-26
  - broadcast signal, 6-13
  - element, 6-18
  - format, 12-28, 17-9
  - locator tone, 6-4



# APPENDIX

signal, 2-26, 6-16  
 tone, 2-26, 6-1  
 Audio information, 17-9  
 Audiocassette, 14-16, 15-41  
 Audio-vibrotactile pushbutton, 6-17  
 Automobiles  
     risks, 1-3  
     traffic, 4-2, 4-31, 8-10, 16-2  
 Average Daily Traffic (ADT) rates, 8-12, 8-13

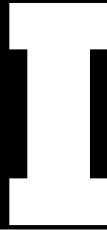
## B

B1 light reflectance value of lighter area, 6-7  
 B2 light reflectance value of darker area, 6-7  
 Bathroom stall, 14-5  
 Battery powered wheelchair, 2-28, 4-16, 14-9, 15-17  
 Beneficial design, 13-4, 13-5  
 Bicycle(s)  
     hand, 2-24  
     lane, 4-16  
     mountain, 2-26, 15-22  
     pathway, 9-4  
     rack, 12-24, 14-5  
     tire, 2-26, 4-30, 15-16  
 Bicyclist, 1-2, 2-23, 14-2  
 Braille  
     characters, 10-8  
     information sign, 6-4  
 Bridge approach, 16-4  
 Broadcasting device, 10-9  
 Bronze castings of buildings, 17-8  
 Business

community, 1-5  
 district, 1-5  
 signs, 11-8

## C

Circulation route, 10-8  
 Citizen complaints, 10-3, 18-2  
 Citizen Report Program, 18-6  
 Civil rights, for disabled persons, 1-6  
 Clinometer, 11-4  
 Commercial  
     district, 1-3  
     facility, 1-6, 8-5  
 Committee, Recreation Advisory  
     recommendations, 15-2  
     report, 1-9  
 Computer  
     kiosk, 11-15  
     software program, 13-5  
 Concrete  
     sidewalk, 4-25  
     surface, 4-25, 14-7  
 Construction  
     activities, 10-7  
     methods, 12-15, 15-4  
     new facilities, 12-5  
     plans, 4-22  
     practices, 12-15, 12-20, 15-4  
     of landing, 7-13  
     requirements, 7-24  
     safety, 10-1, 10-7



## APPENDIX

- site, 10-7
- stages, 12-15
- techniques, 12-19
- tolerance, 4-21, 7-24
- trail, 12-15
- Contextual factors, 2-2
- Cultural features, 12-12, 17-1
- Curb Ramp Element Analysis Form, 11-3, 11-8
- Curb Ramp Measurements, 11-8
- D**
- Department of Justice, 1-7, 18-1
  - mandates, 7-32
- Design
  - acceptable, 5-6
  - good, 5-6
  - Guide, 1-8
  - Guidelines, 4-34
  - not recommended, 5-6
  - specifications, 5-6, 7-22
- Detectable warnings, 6-5
- Digital
  - level, 4-21
  - inclinometer, 11-4
  - voice recorder, 14-6, 15-41
- Disabilities
  - Act, 6-13, 10-1
  - Accessibility Guidelines (ADAAG), 1-2, 1-6, 3-2, 4-20, 4-29, 12-3, 15-2, 15-19, 15-28, 15-40
  - Coordinator/Citizen's Commission, 3-21
  - Focus group, 11-2, 13-3
  - Implementing Regulations, 3-5
  - Standards 1-7
  - Titles I, II, III 1-6
  - transition plans, 11-1, 19-3
- Disability Rights Educational Defense Fund, 3-21
- Discriminatory practices, 19-3
- Dissemination tool, 19-2
- Domes, 6-6, 7-19, 7-23
- DON'T WALK,
  - interval, 6-12
  - phase, 6-17
- Downward Slope Measurements, 11-12
- Drainage
  - channel, 15-30
  - considerations, 4-37
  - curb-ramp, 7-46
  - of terrain, 15-21, 15-31
  - paths, 15-30
  - patterns, 15-25, 15-30
  - pipe, 5-4, 5-6
  - problems, 14-6, 15-30, 15-32
  - slope of gutter, 7-27
  - structures, 7-10, 12-8, 15-31
  - system, 7-47, 19-3
  - water, 15-32, 18-1
- Driveway crossings, 5-1, 7-7
- Driveway Crossing Sidewalk Element Analysis form, 11-11



# APPENDIX

## E

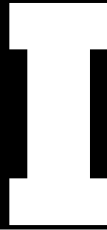
- Earthquake, 18-5
  - Easement program, 12-13
  - Ecosystems, 12-9
  - Economic benefits, 1-4
  - Education, 2-2, 12-3
  - Educational
    - experience, 17-1
    - programs, 19-1
  - Element Analysis, 11-4, 11-8
  - Endangered species, 12-12
  - English units of measurement, 1-3
  - Environmental
    - concerns, 12-13
    - conditions, 5-3, 14-6, 15-41
    - designs, 2-13
    - factors, 2-5
    - impact, 12-10
    - solutions, 2-27
    - technologies, 2-24
  - Erosion problems, 12-15
  - European cities, 6-4
- ## F
- Facilities, commercial, 8-5
  - Feature Measurements Form, 11-6
  - Federal
    - funds, 1-6, 3-3
    - transit funds, 3-15
  - Federal Highway Administration (FHWA) 3-7
    - endorsement, 6-5

policy, 3-7

- Federal Lands/Highway Program, 3-15
- Federally-owned land, 12-14
- Flangeway
  - fillers, 16-10, 19-4
  - gap, 14-8, 16-8, 15-16
- Florida Trail Association, 13-1
- Florida Pedestrian Planning and Design Guide, 4-34
- Focus groups, disabilities, 13-3
- Footrest, 7-29
  - wheelchair, 7-29, 15-23
- Frictional force, 4-25, 14-7, 15-9
- Fruit litter, 4-31
- Furniture zone, 7-6

## G

- Gate, 12-28
- General safety, 10-4
- Geographic Information Systems (GIS), 11-13
- Geotextile fabric, 15-9
- Graphic(s), 6-4, 10-9, 13-5, 15-41
  - symbols, 14-6, 15-39
- Guidelines, review of existing , 1-1, 1-6
- Guidestrip
  - intersection, 6-11, 19-3, 19-5
- Gutter(s)
  - approach, 7-27
  - area, 7-42
  - debris, 7-47
  - dimensions, 11-2
  - slope, 7-30, 7-47



## APPENDIX

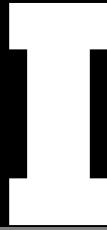
### H

- Handbike, 2-25, 12-24
- Hazardous
  - conditions, 10-7
  - situations, 6-10, 7-47, 12-28, 15-38
  - tipping, 7-28
- Health-related restrictions, 2-1
- Hearing
  - aid, 2-22
  - impairment, 6-4
- Heart condition, 14-6, 15-41
- Heritage, environmental, 12-12
- Highway
  - Capacity Manual, 4-8, 7-42
  - Crossing Program, 3-15
  - vehicle trails, 15-1
- Historic(al)
  - bridge, 12-2
  - districts, 4-27, 4-33
  - features, 12-12
  - route, 12-3
- HIV, 2-4
- Homeowner association, 10-4
- Hospital, 6-14
- Housing communities, 3-22
- Hump, speed, 9-3, 9-9
- Hypothermia, 17-8

### I

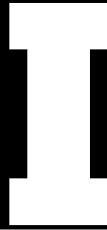
- Ice
  - level, 17-7
  - shift, 17-7
- Impairment
  - international classification, 2-1
  - visual, 7-13, 7-28, 9-10
- Impassible situations, 14-16, 15-39
- Implementing Regulations, ADA, 3-3
- Imported surfaces, 12-13
- Inaccessible design, 5-6
- Inclinometer, 11-4, 11-11
  - digital, 7-26, 11-4, 13-4
- Indenter, 15-11
- Indian tribal protected sites, 12-12
- Infrared audible signage, 17-9
- Injury, 2-9, 10-3, 11-14, 17-8, 18-2
- Institute of Transportation Engineers (ITE), 3-7
- Institutional developments, 3-10
- Installation
  - considerations, 7-35
  - of built-up curb ramps, 7-15
  - of curb ramps, 7-1, 7-27, 7-37, 7-43
  - of drainage control mechanisms, 15-30
  - of elevators, 4-36
  - of jogged landing, 7-44
  - of parallel curb ramps, 4-6,
  - of permanent beach access route, 17-7
  - of perpendicular curb ramps, 7-6, 7-20, 7-38, 7-43





## APPENDIX

- of temporary path, 17-6
- site, 7-5
- Interim Final Rule, 1-8
- Intermodal Surface Transportation Efficiency Act ,  
(ISTEA), 3-2
  - public promotion involvement, 3-22
- International Classification of Impairment,  
Disability, & Handicap, (ICIDH), 2-2, 208
- Internet, 10-10, 11-14, 13-6
- Intersection checklist, 11-3, 11-10
- Interstate highways, 3-15
- Intervals, 11-8
- Inventory, 11-2
  - tool, 13-1
- L**
- Lamp styles, 4-33
- Land
  - use, 12-4
  - management agency, 12-1, 12-5, 12-14, 13-1,  
15-41
  - manager, 12-8, 12-9, 12-15
- Landscaped
  - areas of curb extension, 7-46
  - space, 4-8
- Landscaping, 4-35, 7-46, 9-4, 10-3, 15-22, 18-3
- Language skills, 2-25
- Laser light, 2-23
- Latch mechanism, 12-27
- Learning experiences, 13-4
- LED transmitter, 6-20
- Left/Right Direction segment, 11-12
- Levelness of outdoor surface, 19-4
- Library, school, 18-6
- Lighting
  - post, 14-4
  - street, 4-33
- Limestone, 15-27
- Log bridge, 16-3
- M**
- Maintenance
  - activities, 7-31, 12-5
  - goals, 18-5
  - guide, 18-5
  - improvements, 11-1
  - information, 13-1
  - items, 13-5
  - facilities, 17-8
  - plans, 1-2, 18-1
  - practices, 12-16
  - problems, 18-2
  - programs, 4-26, 4-29, 7-47, 15-16
  - requirements, 15-36
  - routine, 12-7
  - schedules, 18-2
  - strategies, 18-1
  - trails, 12-16, 15-33
  - vehicles, 12-27
- Major arterial roadway, 4-7
- Management
  - agency, 14-16, 18-2



## APPENDIX

- problems, 18-3
- Manual wheelchair, 2-27
- Metric units of measurement, 1-3
- Midblock crossing(s), 4-34, 6-3, 6-11, 7-1, 7-40
- Minor arterial roadway, 4-7
- Mortality rate, 2-9
- Motorcycles, 12-14, 12-25
- Motorist
  - needs, 9-6
  - path of travel, 4-33
  - speeds, 9-10
- Motorized trail, 12-24
- Motor vehicle(s), 4-4, 4-33, 9-10, 12-27
  - lanes, 4-14
  - signs, 6-5
  - speed, 19-5
  - traffic, 9-5, 14-1
- Mountain
  - bike, 2-20
  - ridge, 12-3
- Municipal transportation planning documents, 11-3

**N**

- Narrowings, center island, 9-8
- National Center on Accessibility, 15-18, 15-27
- National Institutes of Health, 15-11, 15-20
- Natural Resources, Departments of, 13-2
- Natural resources, 12-10, 15-25
- National Register of Historic Places, 12-12
- National standards, 19-2
- National Wilderness Preservation System, 12-14

- Navigation, 7-34, 14-14, 15-37
- Negative
  - aspects, 2-21
  - effects of cross slope, 4-20, 14-12, 15-27
  - impacts, 2-24, 4-17, 6-9, 6-12, 9-3, 12-10, 14-15
- Newspaper boxes, 4-2, 38
- Non-Federal lands, 12-14
- Non-visual information, 6-2, 6-3
- North/South crossings, 6-15

## O

- Obstacle, 13-2, 15-37
- On-street parking spaces, 4-2
- Openings, 14-9, 17-4
  - orientation, 14-9
  - width, 14-9
- Operational analysis, 4-15
- Outdoor Developed Area, 1-8, 12-5, 12-18, 12-23, 14-2, 15-2, 15-19, 15-28, 15-40
- Outdoor Recreation Area, 15-4, 17-4
- Outsloped trails, 15-29, 18-1

## P

- Panniers, 12-26
- Parking garage, 4-34
- Parking lane, 7-16, 7-35
- Pedestrian(s)
  - access, 1-1, 4-3, 4-33, 7-18, 7-23, 9-3, 14-15, 15-39, 17-5, 19-1
  - activity, 9-2
  - Activated Signal Devices, 6-19

# I

## APPENDIX

- actuation signal, 6-16
- ambulatory, 4-27
- amenities, 4-4, 4-19
- attractions, 4-34
- audible signals, 2-25
- audio-vibrotactile, 6-17
- awareness, 9-2
- congestion, 7-18
- controlled traffic signals, 19-2
- coordinators, 11-3
- corridor, 4-13, 4-19, 7-41
- crossings, 1-5, 4-3, 6-11, 7-36, 7-40, 9-2
- crossing direction, 7-16
- crossing distances, 9-5
- deaths, 9-1
- directional flow, 7-18
- environment, 2-8, 2-11, 2-15, 2-26, 4-33, 4-36, 7-3, 7-28, 19-5
- exposure, 19-4
- facilities, 4-34, 9-2, 11-1
- gap detection, 19-5
- head, 6-15
- information, 2-15, 6-2, 11-2
- interaction, 6-16
- location, 6-21
- mobility, 4-20, 14-12, 15-27
- needs, 2-18
- network, 1-3, 4-3, 4-34
- path of travel, 2-15, 4-5, 4-34, 7-6, 7-14
- phase (areas), 6-14
- physiological impact (on), 19-1
- refuge, 9-5, 9-7
- route, 1-10
- safety, 2-6, 4-35, 7-15
- safety information, 6-4
- signal indicators, 6-12
- signals, 2-22, 6-1, 6-12, 6-16, 7-34, 11-10
- signs, 4-20, 6-1
- space, 7-16
- stance, 11-5
- standards, 2-9
- system, 2-7, 4-1
- traffic, 4-5, 4-8, 4-35, 6-12, 7-40, 7-41
- trail use, 12-3, 12-24, 15-31
- travel, 2-11, 4-2, 4-6, 4-23
- tunnels, 4-34
- usability, 14-13, 15-35
- use, 4-16, 6-3, 14-15, 15-1, 15-35, 15-38
- volume of traffic, 4-3, 4-8, 6-16, 7-40
- visibility, 7-22, 9-5
- walkway, 7-6
- zone, 4-1, 4-12, 4-18, 4-19, 4-23, 4-30, 7-6, 7-33
- Pedestrian/vehicular boundary, 7-18
- Penetrometer, 15-11
- Periscope, 12-23
- Permits
  - bicycles, 12-26
  - water, 4-30, 14-8, 15-16
- Pilot research, 15-18, 15-27
- Planter/furniture zone, 7-6
- Plants, industrial, 3-5



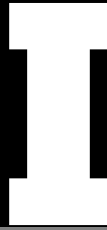
## APPENDIX

Plus/Minus Direction segment, 11-12  
Profile gauge, 11-5  
Property line, 4-2, 5-2  
Prosthetic hands, 6-20  
Psycho-perceptive sense of enclosure, 9-7  
Psychological  
    effects of surface firmness, 15-11  
    functions of systems, 2-3  
Public  
    accommodations, 1-6, 7-1  
    awareness campaign, 1-8  
    comments, 1-9, 12-5  
    involvement in planning process, 1-5  
    right-of way (ROW), 4-7, 4-31  
    sector entities, 4-22  
    sidewalks, 2-1  
    transit, 9-9  
    transportation, 2-5  
Puncheon, 12-6, 15-13  
Pushbutton, 6-16

## R

Railroad, 6-8, 16-8  
    bed, 2-25, 14-4  
    crossings, 14-8, 15-16, 16-1, 19-4  
    hazards, 16-8  
    lines, 14-3  
    ties, 16-8  
    tracks, 4-30  
    trails, 14-3  
    trains, 16-9, 19-4

Rainforest, 12-8  
Ramp  
    applications, 7-15  
    area, 7-32  
    characteristics, 11-9  
    curb, 2-18, 4-2, 7-25, 7-32, 11-8, 16-5  
    design, 4-23, 7-2, 7-18, 7-24, 7-33, 7-40  
    detection of curb, 7-28  
    drainage, 7-46  
    driveway, 5-3  
    facing, 7-33  
    flares, 7-7  
    grade, 4-3, 4-21, 7-4, 7-28  
    installation, 7-35, 19-3  
    length, 7-21, 11-9  
    lips, 7-32  
    path, 7-6, 7-33, 11-11  
    perpendicular curb ramp 7-38  
    placement, 7-5, 7-44  
    slope, 7-6, 7-26, 7-38, 11-9  
    surface, 7-4, 7-32  
    types, 7-3  
    width, 7-19, 7-27, 16-6  
Ramp types  
    combination curb, 7-21  
    curb, 7-1, 7-38  
    parallel, 7-11  
    parallel curb, 7-11, 7-12, 7-21  
Reading ability, 14-16, 15-41  
Reassessment frequency, 18-5  
Recommendations, 9-3

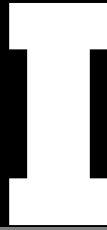


## APPENDIX

- Accessibility Guidelines, 12-4
- Recreation Access Advisory Committee, 1-9
- Recreational
  - equipment, 17-7
  - experiences, 12-1, 12-3, 15-1
  - facilities, 12-4
  - opportunities, 1-4
  - trails, 12-13
- Regulatory Negotiation Committee, 1-8, 12-4, 12-18, 12-23, 14-2, 15-2, 15-19, 15-28, 15-40, 17-4
- Rehabilitation Act (of 1973), 1-6
- Religion, 12-12
- Residential areas, 4-2, 4-8, 4-28, 9-3
- Resources of trails, 12-16
- Review of Existing Guidelines, Phase I, 1-1, 1-6
- Right-of-way (ROW), 4-7, 4-31
- River
  - bed level, 17-3
  - valley, 12-9
- Road
  - access points, 14-3
  - bicycle, 14-9, 15-8
- Rolatape, 11-4, 13-4
- Rotational penetrometer, 15-11
- Roundabouts, 6-11, 9-3, 19-2
- Rubber, 6-7, 15-31,
  - insert, 16-9
  - surface, 15-32
  - waterbar, 15-32
- Rural settings, 12-27
- S**
- Safety
  - considerations, 15-41
  - features, 1-5
  - frames, 2-22
  - hazard, 14-9, 15-13, 16-5
  - information, 6-3, 6-17
- Salt, 4-26
- School Crossing Warrant, 6-16
- School systems, benefits for, 1-5
- Secure/preserve Right-of-Way (ROW), 4-7
- Sensory feedback, 2-21
- Shared-Use Paths, 14-1
- Shopping centers, 4-34
- Sidewalk(s)
  - accessibility, 1-1
  - approach, 7-33
  - area, 4-26,
  - assessments, 10-2, 11-2
  - conditions, 11-2, 19-3
  - corridor, 4-1, 4-8, 4-23, 4-30, 5-3, 5-6, 7-26, 7-33, 7-40
  - cross slope, 4-21
  - cracks, 4-28, 4-31
  - design guidelines, 1-8, 2-10, 11-6
  - developers, 7-18
  - development, 1-2, 2-14, 2-16
  - elements, 19-3
  - entertainment, 4-16, 4-28
  - erroneous assumptions, 7-45



- examples of, 2-24
- facilities, 9-2
- frontage zone, 4-8
- grade, 7-41
- maintenance projects, 11-1
- measurements, 11-5
- networks, 1-2, 1-5
- panels, 6-10
- parameters, 2-7
- planners, 11-1
- segments, 11-7
- surface, 4-24, 4-37, 5-3
- trees, 4-32
- width, 7-20
- Sidewalk Assessment Process (SWAP), 6-5, 11-1, 19-2
- Sidewalk Element Analysis form, 11-3
- Sieve spectrum, 4-25
- Signals, pedestrian
  - audible, 2-22
  - cycle, 6-15, 6-20
  - device, 6-13
  - indicator, 6-16
  - infrared audible, 17-9
  - information, 6-21
  - message overlap, 6-18
  - phase, 6-1
  - visual, 2-25
- Signalized intersections, 6-14
- Signs, 6-1, 15-25, 15-31, 16-3, 17-8, 18-5
- Skateboards, 17-3
- Skaters, 6-8, 14-6, 14-14
- Skate wheels, 15-16
- Skiers, 15-35
  - cross country, 15-38
- Slope Measurements, 11-12
- Snow
  - accumulation, 15-33
  - level, 15-36
  - machine, 15-38
- Snowmobile, 16-4
- Social systems
  - attitudes, 2-4
  - changes, 2-10
  - environment, 2-4
- Soil
  - erosion, 15-22
  - stabilizer, 15-12
  - types, 15-30
- Specifications
  - design, 5-6
- Speech messages, 6-15, 6-20
- Speed humps, 9-3, 9-9
- Stairs, installation, 2-8
- Standardization committee, 6-11
- State laws, 12-12
- Station Measurements, 11-5
- Stiles, 12-25, 12-27
- Stone crossing, 16-3
- Storefronts, 4-8
- Stroll Sheet Station Measurement Form, 11-5
- Surface of trail, 15-12



# APPENDIX

Swales, 15-32  
 Switchbacks, 7-43, 14-4, 15-21, 15-25, 16-8  
 Synthetic materials, 15-12

## T

Tactile
 

- arrow, 6-17
- information, 11-9
- surfaces, 17-9
- tiles/pavers, 6-11

 Tape measure, 11-5  
 TEA-21, 11-10  
 Telescopes, 12-23, 17-2  
 Thermal
 

- areas, 15-38
- injuries, 17-8

 Thermoplastics, 4-25, 19-5  
 Tile surfaces, 19-4  
 Title I, II, II of ADA, 1-6, 6-13, 7-1  
 Traffic
 

- control equipment, 4-2
- flow, 4-15, 12-26
- lane, 4-15
- pattern, 2-19, 9-6, 17-6
- pole, 6-21
- related concerns, 9-2
- signals, 6-3, 6-12, 11-10
- sounds, 2-19, 6-14
- speed, 9-1, 9-9
- volumes, 6-13

 Traffic-free sections of communities, 9-2

Trail(s)
 

- design, 2-13
- development, 1-2, 1-9
- surfaces, 15-8

 Trail Access Information, 16-3
 

- strip, 11-13, 13-5,

 Trail Assessment Coordinators, 13-4  
 Trail Development, 12-1  
 Trailhead, 2-25, 12-1, 12-7, 12-24, 15-4, 15-7, 15-25, 15-41
 

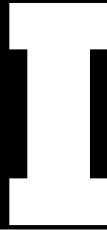
- access, 12-24
- amenities, 12-24
- area, 12-25
- construction, 12-24
- restrictions, 12-25
- sign, 14-16, 15-41
- traffic, 12-25

 Transit
 

- facility platform edges, 6-6
- platforms, 6-8, 6-21
- requirements, 4-5
- stations, 6-11
- stops, 4-5, 4-35
- vehicles, 4-5

 Transition plans, 7-1  
 Transportation, 1-2, 1-8, 7-1, 9-2, 12-1, 12-3
 

- agencies, 4-20, 6-1, 11-3, 11-14, 19-3
- circulation system, 14-1
- engineers, 1-1
- function, 12-3, 14-1
- industry, 1-3, 1-8



## APPENDIX

- municipal, 11-3
- network, 1-3
- Official's guidelines, 19-4
- options, 1-4
- plans, 6-14
- stop, 17-2
- system, 4-30

Transportation Barriers Compliance Board, 1-7

Transportation Community Systems Preservation Pilot Program (TCSP), 3-15

Transportation Equity Act, 6-14

Travelway, 11-1

T-shaped intersection, 7-43

### U

US Access Board, 1-8, 1-9, 4-25, 6-6, 6-13, 8-14, 12-23, 15-2, 15-11

- recommendations, 1-7, 1-8, 15-20
- Technical Bulletin #4, 4-25, 4-39, 14-7, 15-11

US Department of Justice (DOJ) Technical Assistance Manual, 1-7

USDA Forest Service, 13-1

USDI Bureau of Land Management, 13-1

USDI National Park Service, 13-1

Uniform Traffic Control Devices, 2-9, 6-2

Universal Trail Assessment (UTAP), 13-1, 13-4

- Coordinator workshop, 13-4
- process, 13-4, 18-2
- products, 11-13

University campuses, accessibility requirements, 1-7

Utilities, 4-2, 4-39, 7-20, 7-37, 12-23

Utility

- lines, 4-34
- sinks, 12-23

### V

Vehicles, 9-9

Vehicular

- actuation of traffic signals, 6-14
- indications, 6-16
- traffic, 4-34, 4-40, 6-5, 7-6, 7-43

Velocity, water flow, 15-27

Ventilation, 4-35

Vibrotactile, 6-12, 6-13, 6-17

- formats, 6-4
- information, 6-1, 6-12, 6-18
- signal, 6-18

Visual

- enclosure, 4-31
- impairment, 7-13, 7-28, 9-10
- information, 6-17, 11-14
- signals, 2-6, 2-19

### W

WALK

- interval, 6-1, 6-12
- signal, 6-1, 6-15

Warrant investigation, 19-1

Water

- bar, 15-31
- channels, 15-30
- content, 12-15



## APPENDIX

- drainage, 15-33
- flow, 7-47, 15-30
- grate, 4-30, 4-40
- level, 17-7
- mark, 15-13
- source, 4-31
- trough, 15-7
- Wayfinding information, 6-11
- Websites, 13-3
- Wheel
  - design, 2-27
  - track, 15-26
- Wheelchair, 2-4, 2-9, 2-20, 2-26, 4-3, 4-13, 5-2, 5-6, 6-6, 6-20, 7-4, 7-18, 7-27, 12-2, 12-6, 12-14, 12-24, 13-1, 13-4, 14-6, 14-12, 15-7, 15-17, 15-22, 15-29, 15-35, 17-1, 17-7, 19-4
  - access, 4-24, 4-40
  - axel, 15-23
  - casters, 4-26, 4-30, 4-40, 14-8, 15-24, 15-29, 18-3
  - design, 15-23, 15-29
  - footrests, 7-29, 15-24
  - lifts, 4-5, 4-40
  - manual, 2-27, 4-16, 4-35, 7-2, 7-23, 14-9, 15-17, 15-26
  - models, 17-7
  - powered, 2-27
  - road racing, 14-2
  - space facing, 15-34
  - tires, 4-25, 4-40, 14-7, 15-9
- Wheels, vehicle, 9-10
- Wilderness Act, 12-14
- Wilderness areas, 12-11
- World Health Organization, 2-1
- Written language, 2-25





