



PDHonline Course C414 (6 PDH)

Design of Bridge Deck Drainage

Instructor: Vincent D. Reynolds, MBA, PE

2020

PDH Online | PDH Center

5272 Meadow Estates Drive
Fairfax, VA 22030-6658
Phone: 703-988-0088
www.PDHonline.com

An Approved Continuing Education Provider



Design of Bridge Deck Drainage

HEC 21

May 1993

Welcome
to HEC
21-Design
of Bridge
Deck
Drainage



[Table of Contents](#)



[Tech Doc](#)



DISCLAIMER: During the editing of this manual for conversion to an electronic format, the intent has been to keep the document text as close to the original as possible. In the process of scanning and converting, some changes may have been made inadvertently.

[↻ List of Figures](#) [↻ List of Tables](#) [↻ List of Charts & Forms](#) [↻ List of Equations](#) [↻](#)

 [Cover Page : HEC 21-Design of Bridge Deck Drainage](#)

 [Chapter 1 : HEC 21 Introduction](#)

- ▶ [1.1 Scope](#)
- ▶ [1.2 Design Objectives](#)
 - ▶ [1.2.1 Minimization of Spread](#)
 - ▶ [1.2.2 Avoidance of Hydroplaning](#)
 - ▶ [1.2.3 Integration into Structural Dimensions](#)
 - ▶ [1.2.4 Aesthetics](#)
 - ▶ [1.2.5 Minimization of Maintenance](#)
 - ▶ [1.2.6 Bicycle Safety](#)
- ▶ [1.3 Systems](#)
 - ▶ [1.3.1 Deck and Gutters](#)
 - ▶ [1.3.2 Hardware--Inlets, Pipes, and Downspouts](#)
 - ▶ [1.3.3 Bridge End Collectors](#)
- ▶ [1.4 Outline of Design Conditions](#)

 [Chapter 2 : HEC 21 Typical System Components](#)

- ▶ [2.1 Terminology](#)
- ▶ [2.2 Requirements](#)
 - ▶ [2.2.1 Similarities to Pavement Components](#)
 - ▶ [2.2.2 Differences with Pavement Components](#)
 - ▶ [2.2.3 Structural Considerations](#)
 - ▶ [2.2.4 Maintenance Considerations](#)
- ▶ [2.3 Deck and Gutters](#)
- ▶ [2.4 Hardware--Inlets, Pipes, and Downspouts](#)
- ▶ [2.5 Bridge End Collectors](#)

 [Chapter 3 : HEC 21 Estimation of Design Storm Runoff](#)

- ▶ [3.1 Selection of Design Spread and Frequency](#)
- ▶ [3.2 Calculation of Runoff](#)
 - ▶ [3.2.1 Using Spread Plus Rational Method](#)
 - ▶ [3.2.1.1 Coefficient of Runoff](#)
 - ▶ [3.2.1.2 Rainfall Intensity](#)
 - ▶ [3.2.1.3 Time of Concentration](#)

- ▶ [3.2.2 Using Hydroplaning Avoidance](#)
- ▶ [3.2.3 Using Driver Vision Impairment](#)
- ▶ [3.2.4 Using Other Methods](#)

[Chapter 4 : HEC 21 Flow in Gutters](#)

- ▶ [4.1 Sheet Flow to Gutters](#)
- ▶ [4.2 Gutters of Uniform Cross Slope](#)
- ▶ [4.3 Composite Gutter Selections](#)
- ▶ [4.4 Gutters with Curved Cross Sections](#)
- ▶ [4.5 Gutter Flow at Sags](#)
- ▶ [4.6 Guidance for Nontypical Bridge Deck Gutters](#)

[Chapter 5 : HEC 21 Bridge Deck Inlets](#)

- ▶ [5.1 Typical Inlet Designs](#)
- ▶ [5.2 Factors Affecting Interception Capacity and Efficiency](#)
- ▶ [5.3 Anti-Clogging Design Features](#)
- ▶ [5.4 Inlet Locations](#)
 - ▶ [5.4.1 Hydraulic Spacing](#)
 - ▶ [5.4.2 Structural Constraints](#)
 - ▶ [5.4.3 Maintenance Considerations](#)

[Chapter 6 : HEC 21 Underdeck Collection and Discharge System](#)

- ▶ [6.1 Hydraulic Design](#)
- ▶ [6.2 Longitudinal Storm Drains](#)
- ▶ [6.3 Anti-Clogging Features](#)
 - ▶ [6.3.1 Minimum Scouring Velocities for Sand and Grit](#)
 - ▶ [6.3.2 Inlet Traps](#)
 - ▶ [6.3.3 Cleanouts and Maintenance Downspouts](#)
- ▶ [6.4 Vertical Downspouts](#)
 - ▶ [6.4.1 Capacity](#)
 - ▶ [6.4.2 Location to Conform to Structure and Aesthetic Needs](#)
- ▶ [6.5 Outfall Design](#)
- ▶ [6.6 Discharge to Air](#)
- ▶ [6.7 Bridge Expansion Joints](#)

[Chapter 7 : HEC 21 Bridge End Collectors](#)

- ▶ [7.1 Similarities to Pavement Drainage](#)
- ▶ [7.2 Design Flows](#)
- ▶ [7.3 Differences Between Highway Pavement and Bridge Deck Drainage](#)

▶ [7.4 Typical Bridge End Drainage Systems](#)

 [Chapter 8 : HEC 21 Design Procedures](#)

▶ [8.1 Preliminary Data Analysis](#)

▶ [8.2 Establishment of Governing Design Element--Rainfall Intensity](#)

▶ [8.2.1 Rational Method Rainfall Intensity](#)

▶ [8.2.2 Hydroplaning](#)

▶ [8.2.3 Driver Visibility](#)

▶ [8.3 Inlet Sizing](#)

▶ [8.4 Collection System Details](#)

▶ [8.5 Design of Bridge End Collectors](#)

▶ [8.5.1 Location Guidance](#)

▶ [8.5.2 Inlet Information](#)

▶ [8.5.3 Outfall Pipe Information](#)

 [Chapter 9 : HEC 21 Bridge Deck Drainage Method](#)

▶ [9.1 Constant-Grade Bridges](#)

▶ [9.2 Flat Bridges](#)

 [Chapter 10 : HEC 21 Illustrative Examples](#)

▶ [10.1 Example 1--500 Foot, 3 Percent Grade Bridge \(No Inlets Needed\)](#)

▶ [10.2 Example 2--2,000 Foot, 1 Percent Grade Bridge](#)

▶ [10.3 Example 3--1,200 Foot, 3 Percent Grade Bridge](#)

▶ [10.4 Example 4--4,000-Foot Long, 68-Foot-Wide Flat Bridge](#)

▶ [10.5 Example 5--800-Foot-Long, 36-Foot-Wide Flat Bridge](#)

▶ [EXAMPLES 4 and 5 - COMMENTARY](#)

 [Appendix A : HEC 21 Vertical Curve Bridges](#)

▶ [A.1 Vertical Curve Bridge Design Aids](#)

▶ [A.2 Development of Design Procedures](#)

▶ [A.3 Bridge Deck Drainage Vertical Curve Drainage Design Method](#)

▶ [A.4 Example Problem](#)

 [Appendix B : HEC 21 Derivation of Equations](#)

▶ [B.1 Gutter Flow Time of Concentration \(tg\)](#)

▶ [B.2 Inlet Spacing](#)

▶ [B.3 Inlet Spacing for a Horizontal Bridge](#)

▶ [B.4 Inlet Perimeter for a Horizontal Bridge](#)

 [Appendix C : HEC 21 Design Charts - Bridge Drainage](#)



 [Appendix D : HEC 21 Selected Glossary](#)

 [Symbols](#)

 [References](#)

 [Back to Table of Contents](#) 

-  [Figure 1. Composite gutter cross section.](#)
-  [Figure 2. Grate formed with concrete inlet chamber.](#)
-  [Figure 3. Grates with cast-iron inlet chambers.](#)
-  [Figure 4. Grates with welded-steel inlet chambers.](#)
-  [Figure 5. Detail of slab reinforcement modification.](#)
-  [Figure 6. Vertical scupper showing beam clearance.](#)
-  [Figure 7. Horizontal scupper--New Jersey type barrier.](#)
-  [Figure 8. A desirable bent downspout.](#)
-  [Figure 9. Blind alley cleanout.](#)
-  [Figure 10. Finger joint with elastometric sheet to catch drainage.](#)
-  [Figure 11. Bridge end storm drain.](#)
-  [Figure 12. Bridge end detail--CMP drop inlet.](#)
-  [Figure 13. Bridge end shoulder slot inlet with plastic pipe.](#)
-  [Figure 14. Bridge end detail--V ditch drop inlet.](#)
-  [Figure 15. Intensity-Duration-Frequency curves for Charlotte, North Carolina.](#)
-  [Figure 16. Constant grade bridge.](#)
-  [Figure 17. Inlet spacing for example 1.](#)
-  [Figure 18. Horizontal bridge.](#)
-  [Figure 19. Scupper spacing for example 4.](#)
-  [Figure 20. Vertical curve bridge.](#)
-  [Figure 21. Inlet spacing for vertical curve bridge example.](#)
-  [Figure 22. Bridge deck gutter flow relationships.](#)
-  [Figure 23. Flow to scuppers on a flat bridge.](#)
-  [Figure 24. Detail of flow to scupper.](#)

 [Back to Table of Contents](#) 



Chapter 4 : HEC 21

Flow in Gutters

[Go to Chapter 5](#)

A bridge deck gutter is defined in this manual as the section of pavement next to the curb or parapet that conveys water during a storm runoff event. It may include a portion or all of a travel lane. Gutter cross sections usually have a triangular shape with the curb or parapet forming the near-vertical leg of the triangle. The gutter may have a straight cross slope or a cross slope composed of two straight lines. Parabolic sections are also used.

4.1 Sheet Flow to Gutters

Flow in the gutters originates from the bridge deck surface. Because water collects in cracks, potholes, and the voids associated with the texture of the pavement, sheet flow and the runoff coefficient, **C**, is a function of the roughness of the bridge deck--at both the macro- and micro-scales. As presented in [Equation \(2\)](#) of [Chapter 3](#), the effect of surface roughness on sheet flow is accounted for in the Kinematic Wave equation by use of Manning's roughness factor, **n**. The bridge deck and pavement runoff coefficient is usually assumed to be 0.9 (see [Table 1](#)).

4.2 Gutters of Uniform Cross Slope

Modification of the Manning equation is necessary for use in computing flow in triangular channels because the hydraulic radius in the equation does not adequately describe the gutter cross section, particularly where the top width of the water surface may be more than 40 times the depth at the curb. To compute gutter flow, the Manning equation is integrated for an increment of width across the section (Izzard, 1946). The resulting equation, in terms of cross slope, longitudinal slope, and spread on the pavement, is:

$$Q = \left(\frac{k_g}{n} \right) S_x^{1.67} S^{0.5} T^{2.67}, \quad (4)$$

where: Q = Flow rate, ft³/s.
 k_g = 0.56, a constant.
 T = Width of flow (spread), ft.
 S_x = Cross slope, ft/ft.
 S = Longitudinal slope, ft/ft.

n = Manning's roughness coefficient.

[Equation \(4\)](#) neglects the resistance of the curb face. However, this resistance is negligible from a practical point of view if the cross slope is 10 percent or less. Gutter velocity is determined by dividing the gutter flow equation by the cross-sectional area of the gutter. The resulting relation is:

$$V = \frac{2kg}{n} S^{0.5} S_x^{0.67} T^{0.67}, \quad (5)$$

where: V = Gutter velocity, ft/s.

Charts for [Equation \(4\)](#) and [Equation \(5\)](#) are presented in [Appendix C](#).

4.3 Composite Gutter Selections

Composite gutters as shown in [Figure 1](#) are one alternative approach in pavement drainage. They typically are not used on bridge decks for structural reasons. The relationships used in this manual are based on constant cross slope, S_x . If necessary, composite equivalent slopes can be utilized with weighted averages (Johnson and Chang, 1984).

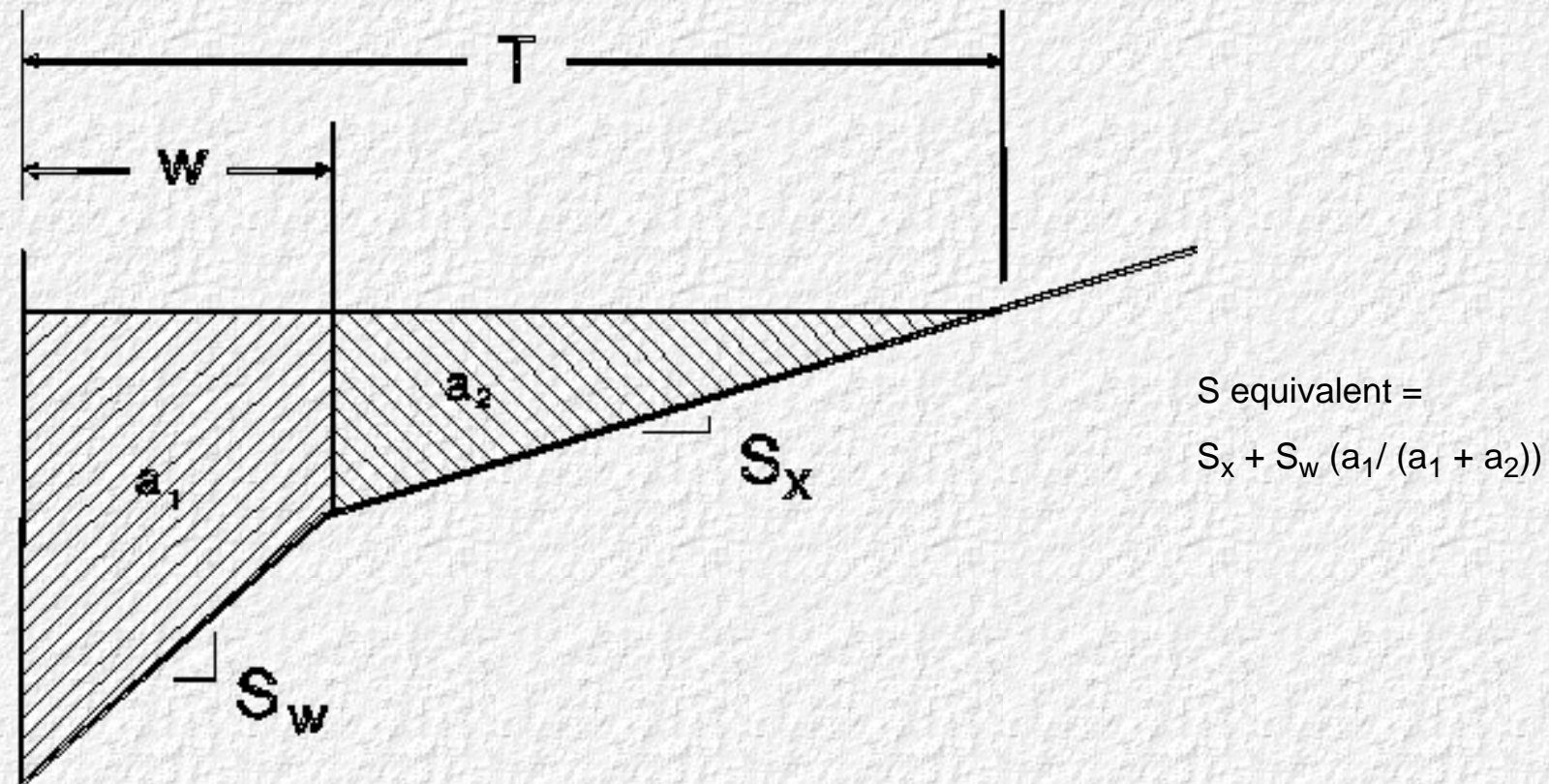

Figure 1. Composite gutter cross section.

4.4 Gutters with Curved Cross Sections

Where the pavement cross section is curved, gutter capacity varies with the configuration of the pavement. For this reason, discharge-spread or discharge-depth-at-the-curb relationships developed for one pavement configuration are not applicable to another section with a different crown height or half-width. Procedures for developing conveyance curves for parabolic sections are given in [HEC-12](#) (Johnson and Chang, 1984).

4.5 Gutter Flow at Sags

The spread of water in sag vertical curves is of concern because inlets in sags are prone to clog. Spread should be examined where the slope is relatively flat at either side of the low point of a sag vertical curve to determine whether the spread is acceptable. It is suggested that spread be checked at a gradient of 0.3 percent and flanking inlets be provided at this location on either side of the sag. Flow at the sag itself is governed by weir and orifice equations. Clogging factors provide a margin of safety. It is strongly urged that sags not be located on bridges.

When sags are present, the span between the flanking inlets can be considered a flat bridge. The flat bridge case method is developed in [Chapter 9](#) and illustrated by example in [Chapter 10](#). The relationships for flat bridges are presented in [Chart 11](#), [Chart 12](#), and [Chart 13](#), [Appendix C](#).

4.6 Guidance for Nontypical Bridge Deck Gutters

Contained in [HEC-12](#) (Johnson and Chang, 1984) is information a designer would need to analyze a bridge deck with a composite gutter cross section, such as shown in [Figure 1](#), or deal with significantly curved crowns that are not tangents at curb side, or calculate sag inlet hydraulics.

[Go to Chapter 5](#)



Chapter 5 : HEC 21

Bridge Deck Inlets

[Go to Chapter 6](#)

The design of the bridge deck inlet is important because it removes water from a bridge deck within the limits of allowable spread. An inlet is a common location for debris to collect and potentially clog a drainage system. From a hydraulic point of view, inlets should be large and widely separated. From a structural point of view, inlets should be avoided or made as small and as few as possible. This chapter presents typical inlet designs and discusses the factors that affect inlet interception capacity. In addition, design features to help prevent clogging and guidance for determining inlet locations are presented.

5.1 Typical Inlet Designs

There are numerous approaches to the design of bridge deck inlets and scuppers. Different States use different materials to make inlet boxes. Some specify all cast-iron boxes. Others specify the box size and shape and allow it to be either cast or made of fabricated steel. Many States require all their metal drainage hardware to be galvanized. Although galvanizing is the most popular finish, it is expensive. Painting and asphalt dipping of boxes is considerably cheaper than galvanizing them and experience has shown that, in most locations, boxes treated in either way will perform as well as galvanized boxes (TRB, 1979). Especially corrosive conditions may require special treatment, such as heavy galvanizing or an epoxy coating.

[Figure 2](#) shows a formed inlet chamber that supports a rather large opening, 14 inches x 18 inches; the significant issue is making the size of the opening as large as possible. The disadvantage is a width irregularity in the slab to accommodate the formed chamber and the weight of the grate.

[Figure 3](#) and [Figure 4](#) show grates with cast-iron and welded-steel inlet chambers, respectively. Because of thinner members, less dead weight, and greater structural strength, the welded-steel alternate allows larger openings than cast iron. The [Figure 4](#) steel frame measures 16½ inches x 18 inches. Tilted or curved vanes would improve the hydraulic performance shown in [Figure 2](#), [Figure 3](#), and [Figure 4](#).

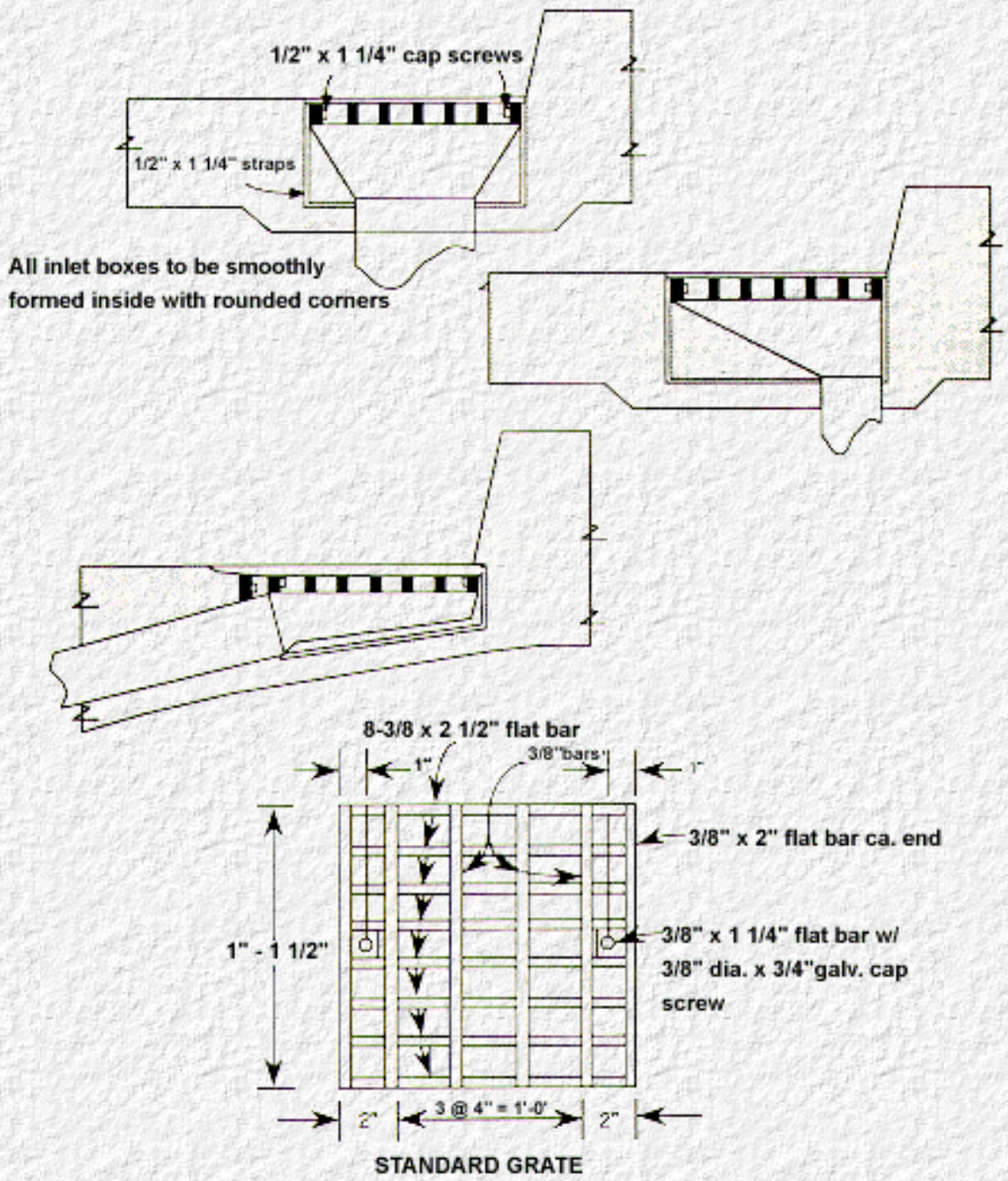

Source: Oregon DOT, 1984

Figure 2. Grate with formed concrete inlet chamber.

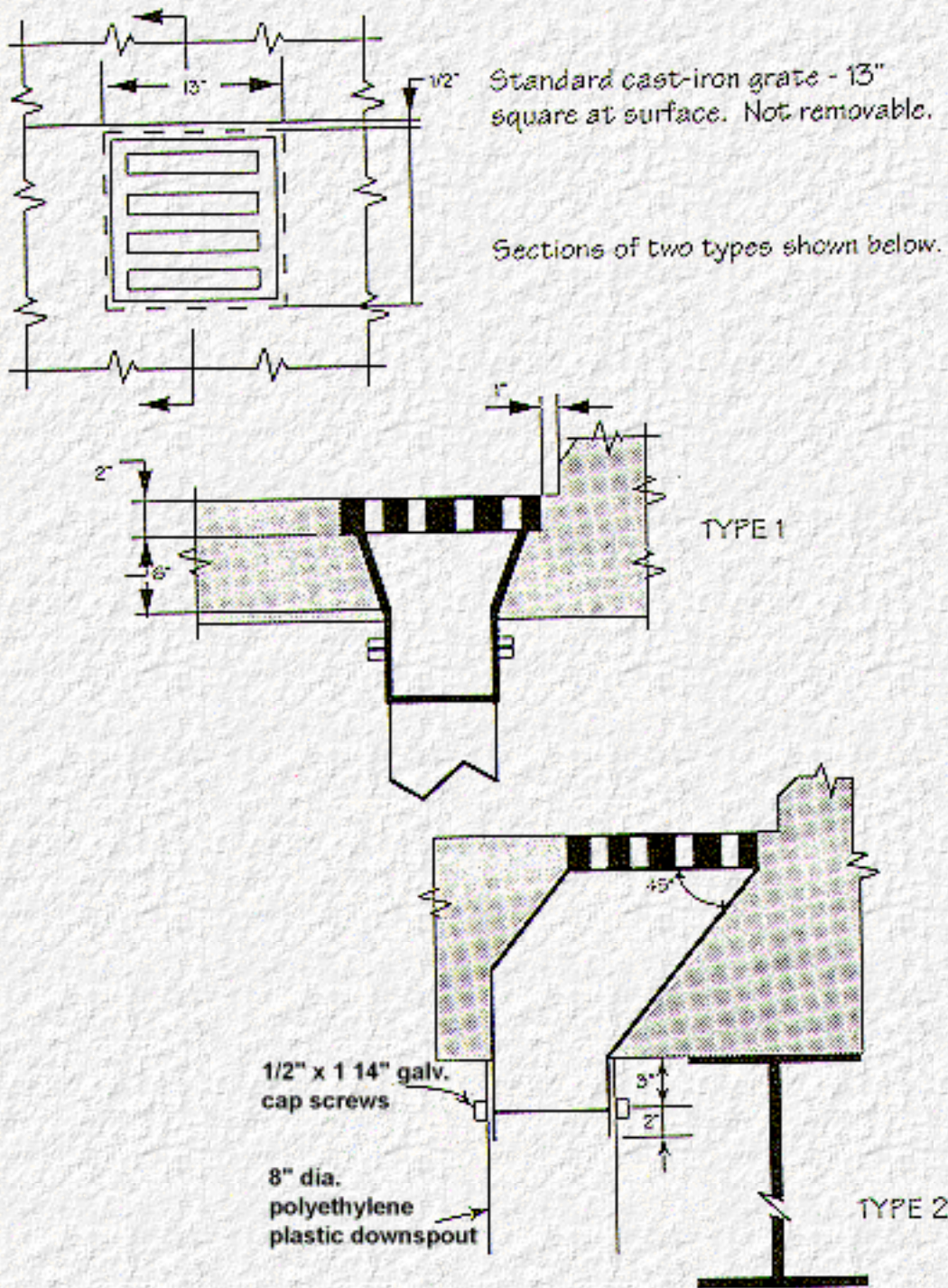

Source: Michigan DOT, 1988

Figure 3. Grates with cast-iron inlet chambers.

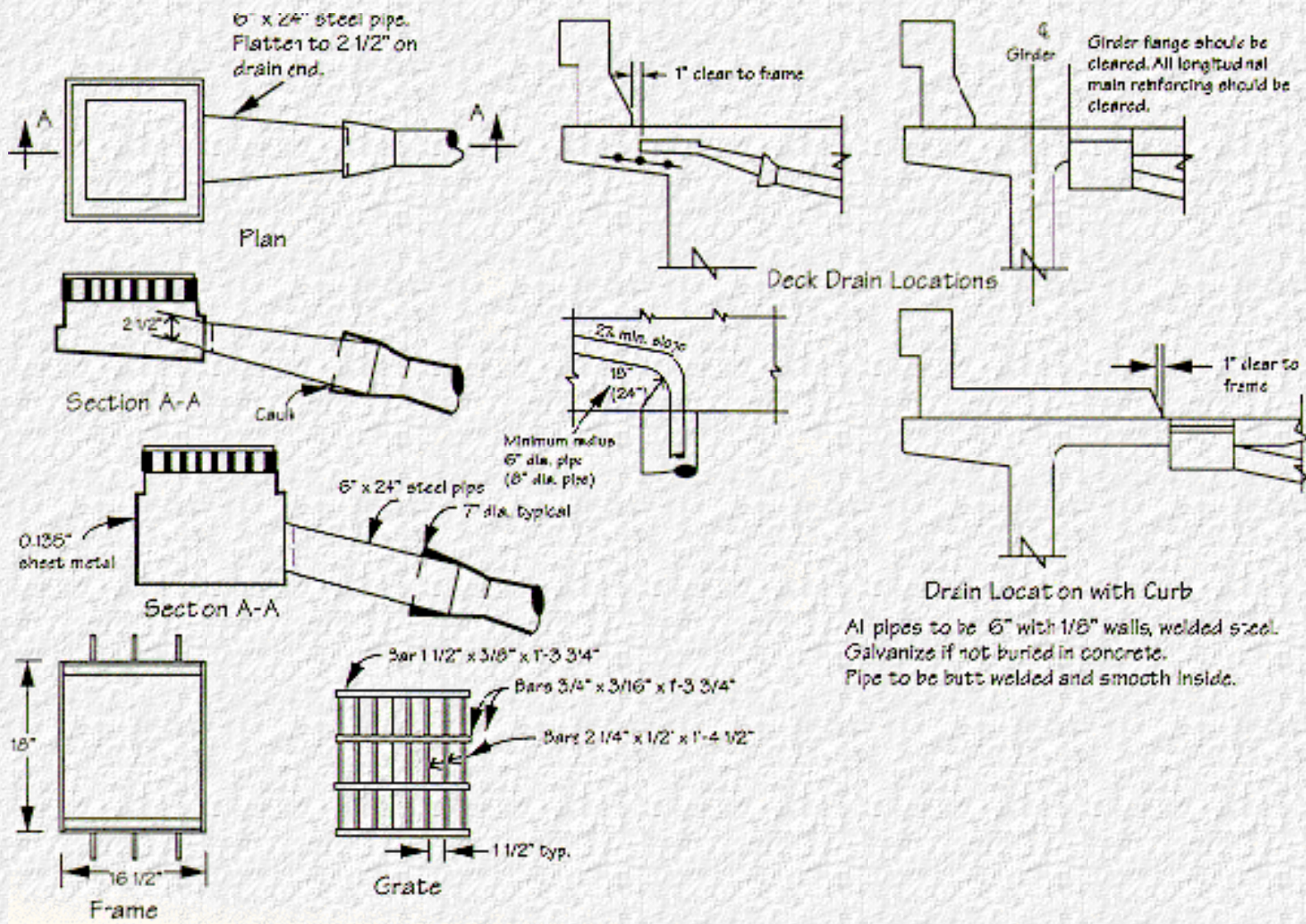

Figure 4. Grates with welded-steel inlet chambers.

For inlet grates that project 12 to 18 inches toward the centerline and a spread of 10 feet, the capture efficiency is 25 to 35 percent (assuming all flow approaching the grate is intercepted). This applies to the bridge deck inlets depicted in [Figure 2](#), [Figure 3](#), and [Figure 4](#).

[Figure 5](#) illustrates extra slab reinforcement for a grate that projects 3 feet from the curb. The advantage of the extra projection generates the need for extra reinforcing. The inlet chamber should have as large a transverse slope as possible to avoid clogging. For this grate, projecting 3 feet toward the centerline, and a spread of 10 feet, the interception efficiency is 61 percent. This assumes all flow within the 3 feet of width is intercepted. Flow across the grate will reduce the interception efficiency of the inlet on higher slopes because the grate is only 8 inches long in the direction of the flow and rapid flow will splash over the gap.

[Figure 6](#) illustrates a vertical scupper with several well-thought-out design details. An eccentric pipe reducer enlarges the circular opening at deck level to 10 inches. While this enlargement is hydraulically beneficial, bars are necessary to reduce the potential hazard of the rather large circular opening. Smaller openings of 4 to 6 inches, without the eccentric pipe reducer, are more typical, but less effective. Note that the pipe discharges below the girder. Such free discharge can be directed on slight angles to erosion-resistant splash surfaces like the concrete

surfaces placed on side slopes under overpass bridges. A 6-inch diameter vertical scupper has a capture efficiency of 12 percent for 10 feet of spread and a 2 percent cross slope; a 4-inch diameter scupper has an efficiency of 7 percent.

For completeness, [Figure 7](#) shows a common practice of using slotted New Jersey type barriers, which has low-hydraulic utility. Horizontal or nearly horizontal scuppers are poor managers of spread. Such designs clog easily, are difficult to maintain, and offer only 5 percent interception capacity for gutter flow having a 10-foot spread. Perhaps the best comment on their usage is that they may be better than nothing.

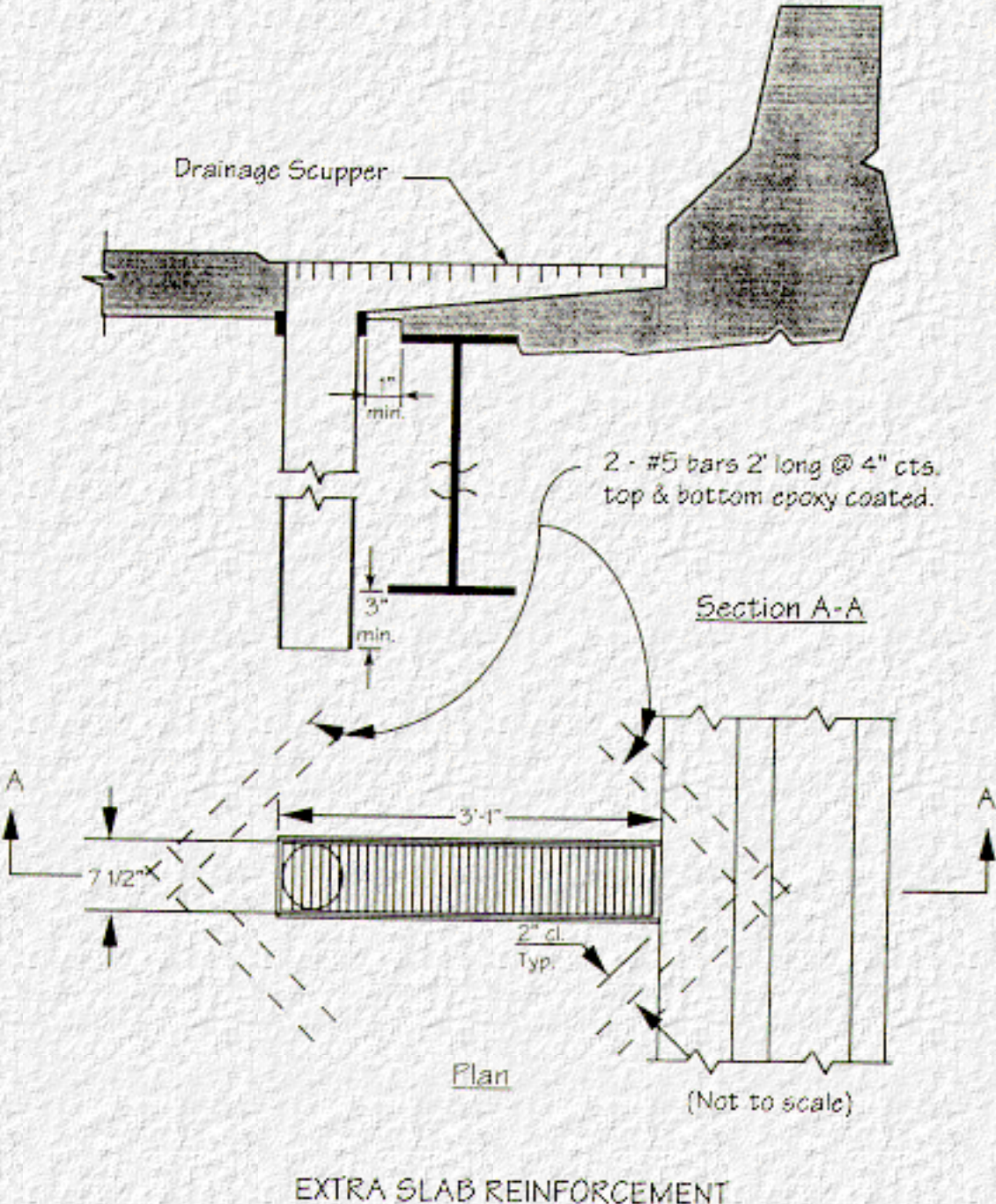

Figure 5. Detail of slab reinforcement modification.

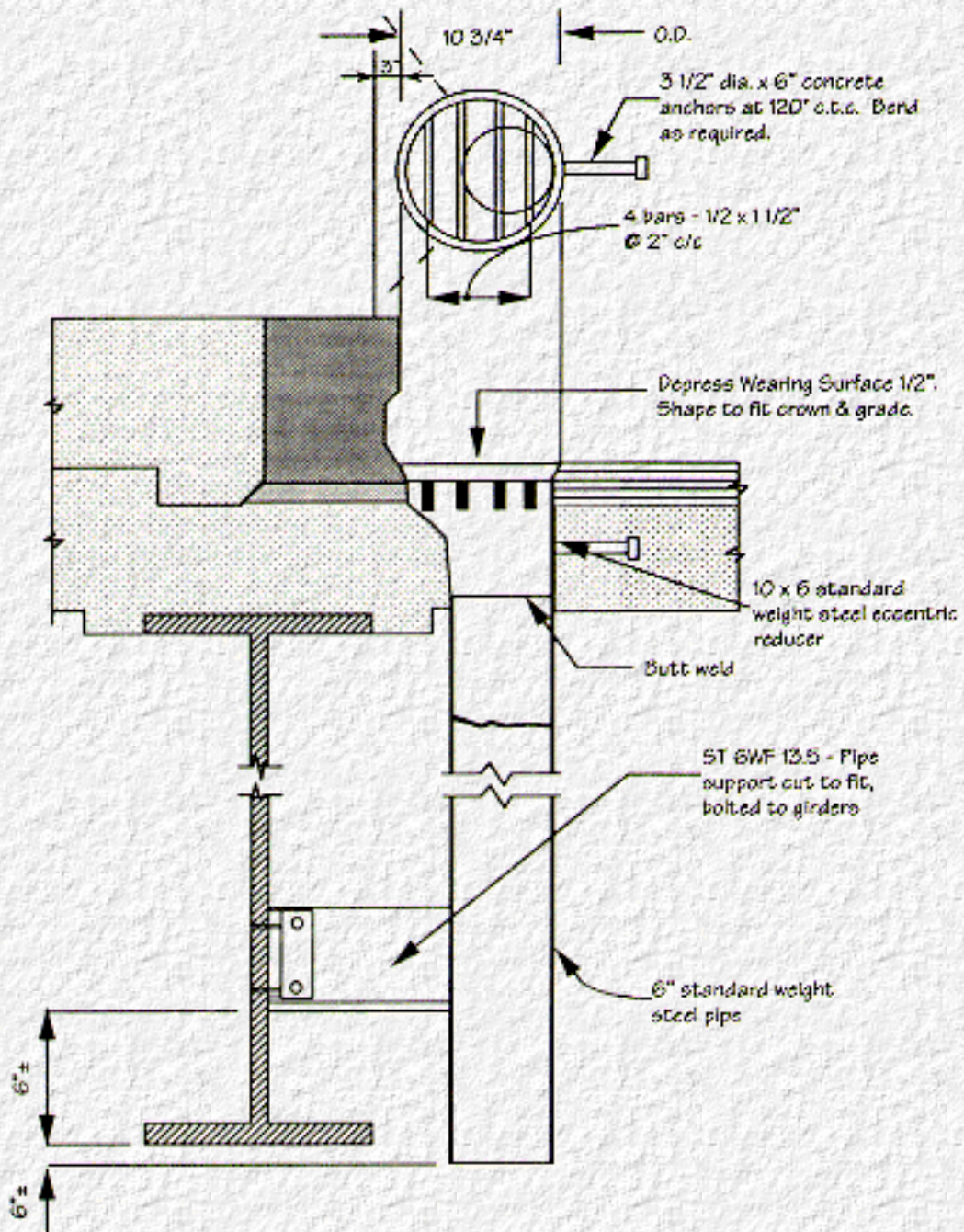
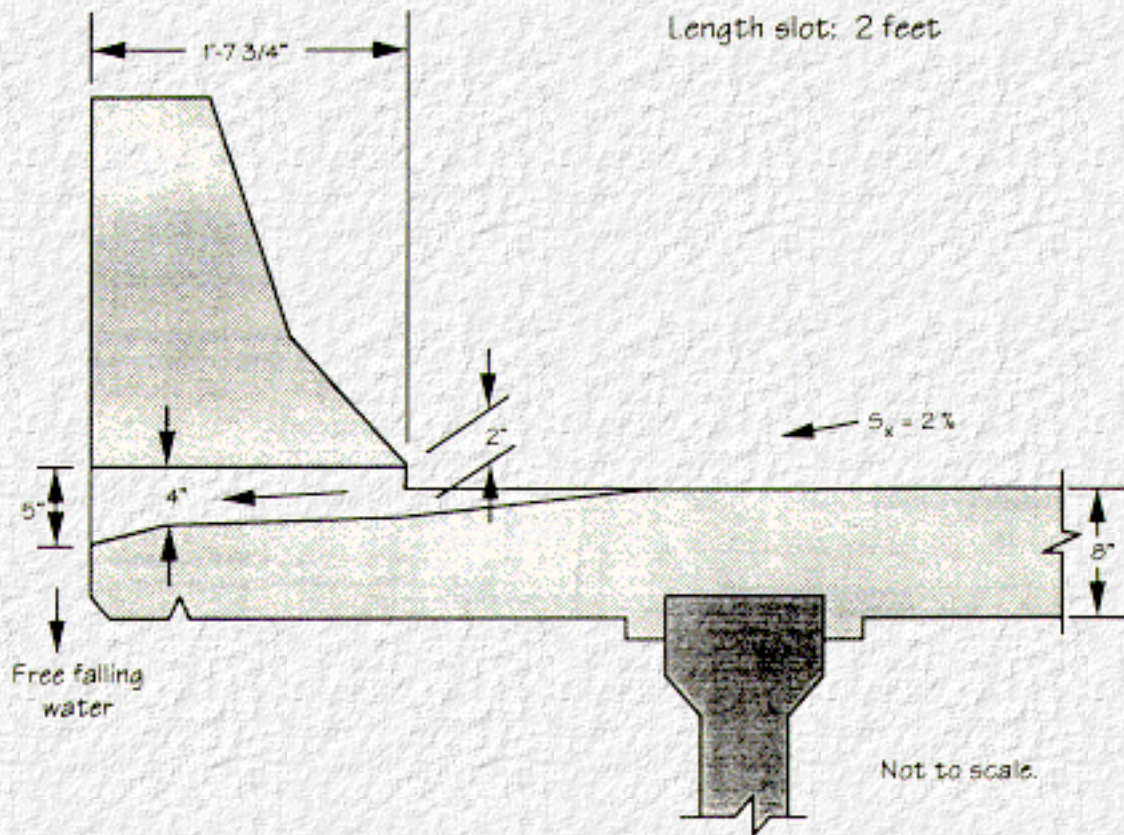

Figure 6. Vertical scupper showing beam clearance.



Performance (using Chart 9, HEC-12) for $L_g = 2$ ft, $S_x = 2\%$				
E Interception (%)	T Spread (ft)	S_u grade (%)	Velocity (ft/s)	Gutter flow (cfs)
5%	10	1	2.4	2.4
4%	10	3	3.5	4.5
8%	5	3	0.7	18

Source: Kentucky DOT, 1992

Figure 7. Horizontal scupper--New Jersey type barrier.

5.2 Factors Affecting Interception Capacity and Efficiency

Inlet interception capacity is the flow intercepted by a bridge deck inlet or scupper under a given set of conditions. The interception capacity of a given inlet changes with differing

conditions. The efficiency of an inlet is the percent of total flow that the inlet will intercept under a given set of conditions. The efficiency of an inlet changes with variations in cross slope, longitudinal slope, total gutter flow, and, to a lesser extent, pavement roughness. In mathematical form, efficiency, E , is defined by the following equation:

$$E = \frac{Q_i}{Q}, \quad (6)$$

where: Q = Total gutter flow, ft³/s.

Q_i = Intercepted flow, ft³/s.

The intercepted flow consists of frontal flow entering the inlet parallel to the gutter, as well as flow entering from the side of the inlet. For small, rectangular inlets, side flow is assumed to be small. The ratio of side flow intercepted to total side flow, R_s , is defined by the following equation:

$$R_s = \frac{1}{\left[1 + \frac{0.15 V^{1.8}}{S_x L_g^{2.3}} \right]}, \quad (7)$$

where: L_g = The length of the inlet parallel to the flow, ft.

Because the side flow is small compared to the total flow, the inclusion of side flow is left to the discretion of the designer. [Equation \(8\)](#) describes the ratio of frontal flow to total gutter flow, E_o (Johnson and Chang, 1984):

$$E_o = 1 - \left(1 - \frac{W}{T} \right)^{2.67}, \quad (8)$$

where: W = The width of the inlet, ft.

T = The width of the design spread, ft.

[Chart 7, Appendix C](#), presents a solution to [Equation \(8\)](#).

The fraction of frontal flow that actually enters the inlet can be expressed as (Johnson and Chang, 1984):

$$R_f = 1 - 0.09(V - V_o), \quad (9)$$

where: R_f = Frontal flow capture fraction.
 V = Gutter velocity, ft/s.
 V_o = Grate splashover velocity, ft/s.

[Equation \(5\)](#) can be used to determine gutter velocity, V . Splashover velocity, V_o , is dependent on the type of grate used. The more efficient the grate, the higher the gutter velocity can be before splashover (passing over the inlet instead of falling into the inlet) occurs. The efficiency of a grate inlet depends on the amount of water flowing over the grate, the size and configuration of the grate, and the velocity of flow in the gutter. The empirical relationship between V_o and R_f for various types of grates is presented in [HEC-12](#) (Johnson and Chang, 1984) and is also provided as [Chart 10](#) in [Appendix C](#). In addition, manufacturers' literature will often contain information concerning capture efficiency for particular grate designs.

The interception capacity of grate inlets on grade is dependent upon the grate geometry and characteristics of the gutter flow. A considerable portion of water may pass over the top of a drain covered by an improperly designed grate. Flowing water follows a parabola as it leaves the square lip of a grate opening. If the velocity is high, inlets must be fairly long for water to drop into the box; otherwise, much of it may splash over the opening. Generally, the steeper the slope, the longer the openings needed.

The grate geometries with flow directing vanes have inlet efficiencies that are dependent on direction of flow; in other words, it is conceivable that such a grate could be placed 180 degrees out of proper alignment. Such an improperly placed grate would have reduced interception capacity and may be more prone to clogging. Manufacturers should be encouraged to provide guide keyways to avoid misplacement, and maintenance workers should be instructed as to proper placement to avoid this mishap.

Rather long curb openings and slotted inlets are required to achieve reasonable interception capacity. Depressed gutters increase the capacity of inlets. However, depressed gutters or long openings are not attractive features for bridge decks. Some commercial inlet devices have small grates combined with side openings; these devices have performance characteristics described by manufacturers.

The grates¹ having empirical frontal flow interception fractions are parallel bar, modified parallel bar, and reticuline. For hydraulic efficiency, parallel bars are best. They are also less subject to clogging. However, parallel bars must have clear openings between bars of less than 1 inch to be bicycle-safe. Non-bicycle-safe parallel bar grates are quite satisfactory on limited access highway facilities where bicycle use is prohibited. Parallel bar grates have been modified with transverse vanes or bars to support bicycles. Tilted vanes or bars are better than non-tilted; curved vanes are better than tilted. Vanes reduce efficiency in comparison to parallel bars. Reticuline grates have the least hydraulic efficiency but are quite safe for bicycles.

Inlets in sag vertical curves operate as weirs up to depths dependent on grate size and configuration and as orifices at greater depths. Generally, inlets in sags operate as weirs up to a depth of 0.4 feet and operate as orifices when depth exceeds 1.4 feet. Between weirs and orifice flow depths, a transition from weir to orifice flow occurs. The perimeter and clear opening area of the grate and the depth of water at the curb affect inlet capacity. From a hydraulic standpoint, a sag located on a bridge deck is very undesirable. If debris collects on a grate, it can reduce the effective perimeter or clear opening area and generate a standing pond.

At low velocities, a grate inlet will intercept all of the water flowing in the section of gutter occupied by the grate. This is called frontal flow. A grate inlet will intercept a small portion of the flow from the triangular wedge of flow on the bridge deck along the length of the grate. This is called side flow. Bridge deck grates are normally small in comparison to those used for pavement drainage. The short lengths minimize side flow, which is taken to be negligible in this manual. Water splashes over the grates on steeper slopes. At slopes steeper than 2 percent, splashover occurs on reticuline grates and the interception capacity is reduced. At a slope of 6 percent, velocities are such that splashover occurs on all grates except parallel bar and curved vane grates. On relatively mild slopes, the various grates perform equally.

Theoretical inlet interception capacity and efficiency neglects the effects of debris and clogging on the various inlets. All types of inlets are subject to clogging, some being much more susceptible than others. Attempts to simulate clogging in the laboratory have not been very successful except to demonstrate the importance of parallel bar spacing in debris handling efficiency. Grates with wider spacings of longitudinal bars pass debris more efficiently.

Problems with clogging are largely local since the amount of debris varies significantly from one area to another. Some localities must contend with only a small amount of debris while others experience extensive clogging of drainage inlets. Partial clogging of inlets on grade rarely causes major problems. Thus, localities need not make allowances for reduction in inlet interception capacity unless local experience indicates such an allowance is advisable.

5.3 Anti-Clogging Design Features

Controlling debris can take one of two possible forms: intercepting and storing it so it cannot enter the system, or transporting it through the system. Generally, it is not possible to screen all debris out of the system. However, the grate will screen out the larger debris that might clog the system, but will pass through smaller debris.

Just how much of the debris is to be permitted to enter depends largely on the nature of the drainage and disposal system. More debris can be admitted when the inlet box opens through the deck and drops free than when water is conducted through an extensive piping system to a storm drain.

With a free-drop, an arrangement may be used where some of the inlet box is recessed under the curb. The unrecessed portion is covered with a grate. The recessed top is left open at the vertical curb face to accept larger debris. Such combined systems hold the larger debris free of the water flow until it can be removed and allow the smaller debris and water to pass on

through the system. Maintenance of drainage is problematic at best. Scupper details are discouraged that permit debris to get below the deck surface.

5.4 Inlet Locations

The deck spread criterion and geometric controls determine the location of inlets. For the pavements on grade, design spread determines the distance between inlets. Consideration must be given to the flow that can be intercepted in a sag without producing hazardous ponding. However, engineers should avoid designing bridges with sag vertical curves. Care should be taken to intercept gutter flow in horizontal curvature or super-elevation transitions to assure that water does not flow across a bridge deck.

5.4.1 Hydraulic Spacing

Determining the maximum design spacing between inlets is straightforward if the drainage area consists of pavement only or has reasonably uniform runoff characteristics and is regularly shaped. This assumes that the time of concentration is the same for all of these evenly spaced inlets. Such an assumption simplifies the inlet spacing computations, as illustrated in [Chapter 10](#) for constant grade and flat bridges and in [Appendix A](#) for the more hydraulically complex vertical curve bridges.

Where significant sag vertical curve ponding can occur, it is sound practice to place flanking inlets on each side of the inlet at the low point in the sag. The flanking inlets should be placed so that they will limit spread on low gradient approaches to the level point and act in relief of the inlet at the low point if it should become clogged or the design storm is exceeded. Use of clogging factors may be appropriate for sag inlets. It should be noted that sag vertical curves on bridges are poor engineering practice from a hydraulic standpoint and should be strongly discouraged.

5.4.2 Structural Constraints

Inlet spacing design guides surface hydraulics and the underlying bridge structure. Inlet locations must be taken into account in the design and layout of the reinforcement spacing within the deck and must not promote corrosion of the structural members. The drainage system design must be coordinated with the structural design so that sharp-angled pipe bends are avoided.

If a free fall outlet system is used, inlets should be placed between, and away from, bridge columns to avoid wind-driven splash on bridge members. If an outfall pipe is necessary to convey flow to a collector channel or pipe beneath the bridge, inlets should be placed next to the columns to allow vertical piping and to avoid long runs of nearly horizontal outfall pipe with the attendant fittings. In addition, to keep drainage out of the joints and away from bridge members, inlets should generally be

placed near and upslope from expansion joints on the bridge deck.

5.4.3 Maintenance Considerations

Maintenance plays an important role in successful deck drainage. An inlet should be placed where it can be serviced by a maintenance crew with ease and safety. A difficult-to-reach inlet will be neglected and inevitably become plugged. Inlets placed in traffic lanes are apt to plug due to vehicles forcing debris into an inlet. Whenever drains are placed in the traffic lanes, localized ponding can lead to hazardous splashing. Maintenance crews should attempt to keep inlets reasonably free of all accumulated ice and snow.

Ideally, a bridge should have 10-foot shoulders and the inlet boxes should be placed at the outside edge of the shoulder. In this position, the maintenance crew can park on the shoulder and work on the side away from the traffic in reasonable safety. These drains have a good chance of being regularly maintained. Unfortunately, accidents may happen when lanes must be blocked to service the drains or when the maintenance crew must work on the edge of the stream of traffic. This can result in poorly placed inlets receiving inadequate maintenance.

The larger the inlet, the fewer inlets to maintain. Hydraulically larger inlets handle larger volumes of flow and are more apt to clean themselves. The larger the inlet, the easier it is to clean with a shovel. Inlets should be sized as large as possible; practically speaking, 36 inches is probably an upper limit for inlets placed within deck slabs.

¹See [Chart 8](#), [Appendix C](#) for illustrations of grate types.

[Go to Chapter 6](#)



Chapter 6 : HEC 21

Underdeck Collection and Discharge System

[Go to Chapter 7](#)

Runoff leaves the inlet box, enters the outlet pipe, and is conveyed by pipes. Steel tubing, cast-iron pipe and plastic pipe are all used for the piping. Bridge drainage pipes are generally large to facilitate maintenance. The inlet conditions generally control the flow capacity. Thus, the hydraulic characteristics of the pipe system below the inlet seldom controls the flow. Design is more often governed by maintenance needs and structural and aesthetic considerations.

6.1 Hydraulic Design

Most States agree that 6 and 8 inches are the minimum pipe sizes to be used. The piping should be cast iron or welded steel, particularly when exposed to air. The minimum wall thickness of steel pipe should be 1/8 inch. Plastic pipe is allowed to be buried in concrete by some States, but special care must be taken with all pipe joints and bends. Avoid corner joints and mitered joints. The interior surfaces of all joints should be smooth.

Entrances, bends, and junctions in the underdeck pipe system provide opportunities for debris to snag and collect. The hydraulic losses at these points are negligible. By virtue of being connected to the bridge deck above the ground or water surface, the drainage has sufficient potential energy to dwarf the hydraulic losses at the various transition points in the pipes.

6.2 Longitudinal Storm Drains

It may be necessary to design a longitudinal storm drain affixed beneath a bridge in environmentally sensitive locations that preclude discharging directly into a water course. An example of the need for an enclosed drainage system suspended under a bridge would be a bridge over a water supply facility. Such systems would discharge to settling basins on natural ground or, in rare instances, to adjacent storm drain systems.

6.3 Anti-Clogging Features

6.3.1 Minimum Scouring Velocities for Sand and Grit

Few States specify any minimum velocity for runoff water in pipes. They all understand, however, that it is desirable to have the highest velocity possible and usually require that the pipe be placed on as steep a slope as possible. A recommended minimum velocity for storm drains is 2.5 ft/s. A slope of 2 percent will generate velocities in excess of 1 ft/s for a 6- to 8-inch pipe. However, because vertical fall for pipes beneath bridges is typically available, 8 percent is a good minimum to observe so that sand and silt are transported through the pipes at over 2.5 ft/s.

Particular care will have to be incorporated into the design of longitudinal storm drains suspended under bridges to assure conveyance of sand and grit.

6.3.2 Inlet Traps

The configurations of manufactured inlet chambers, grate openings, and curb openings often are arranged to attempt to prevent debris except sand and grit from entering the piping system. The manufacturers have a variety of schemes to try to keep debris from causing clogging. Not all schemes are successful and all require periodic maintenance to have any chance of performing their intended function. Designers need to evaluate manufacturers' configurations with a critical eye and make selections based on what has the best chance of success in the inlet location intended, given the prevailing maintenance practices.

6.3.3 Cleanouts and Maintenance Downspouts

Cleanouts (maintenance access) should be provided at key points within the system to facilitate removal of obstructions. Maintenance downspouts should be located so the maintenance crew can get to them from underneath the bridge and preferably from the ground. [Figure 8](#) shows upward and downward cleanouts.

It is most desirable to convey water straight down from the inlet box. When it is necessary to curve the pipe, the cleanout opening leading to the next straight run should be reachable without special equipment from under the bridge. These criteria represent ideal conditions that are not always attainable. Bends often must be placed in difficult locations, and cleanouts are not always easily accessible. However, attaining the most convenient arrangement is worth considerable study and effort because cleanouts that are inaccessible or difficult to reach simply will not be cleaned.

Cleanouts should be located according to probable cleaning methods. Access holes should be provided at the bottom end of a system for pressure backflushing. A tee-joint will not be satisfactory for pressure backflushing unless there is also provision for blocking the outlet leg to the discharge point. An open hole into a catch

basin provides the best backflushing access. Where manual flushing systems are provided, the valves should be easily accessible without hazard from passing traffic. It may be possible to run a long plumber's auger through to clean it. Cleanouts should be located so as not to provide a blind alley for the auger ([Figure 9](#)).

6.4 Vertical Downspouts

6.4.1 Capacity

Since the slope of the downdrain is steep, its capacity will be limited by the inlet of the pipe, which, in turn, may be limited by the capture efficiency of the grating. The pipe opening will operate as a weir or as an orifice, depending on the depth of water in the inlet box. Assuming the inlet box is full of water, then the capacity is:

$$q_x = 0.6 A_x \sqrt{2gx} , \quad (10)$$

where: q_x = Pipe flow capacity, ft³/s.

0.6 = Orifice coefficient.

A_x = Area of the pipe exiting from the inlet box, ft².

g = Acceleration due to gravity = 32.2 ft/s².

x = Depth of the box plus the depth of water in the gutter, ft.

For a 6-inch opening with $A_x = 0.20$ ft² and x between 0.5 and 1.0 feet, the resulting capacity, q_x , is between 0.67 and 0.95 ft³/s, which exceeds the flow passed by a grate of typical efficiency. Therefore, it is reasonable to expect that the inlet capture flow is less than the flow that the collection piping system can handle.

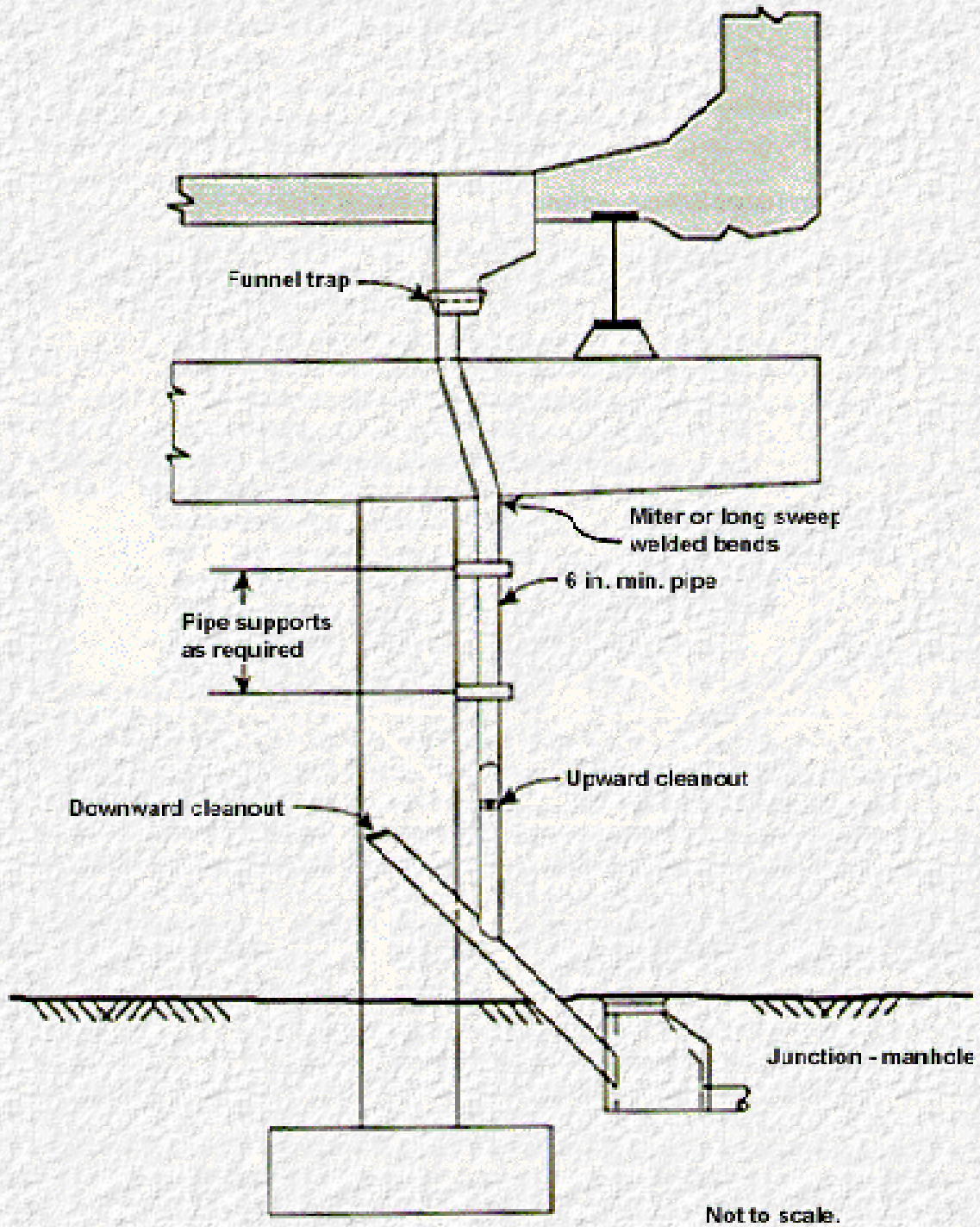

Figure 8. A desirable bent downspout.

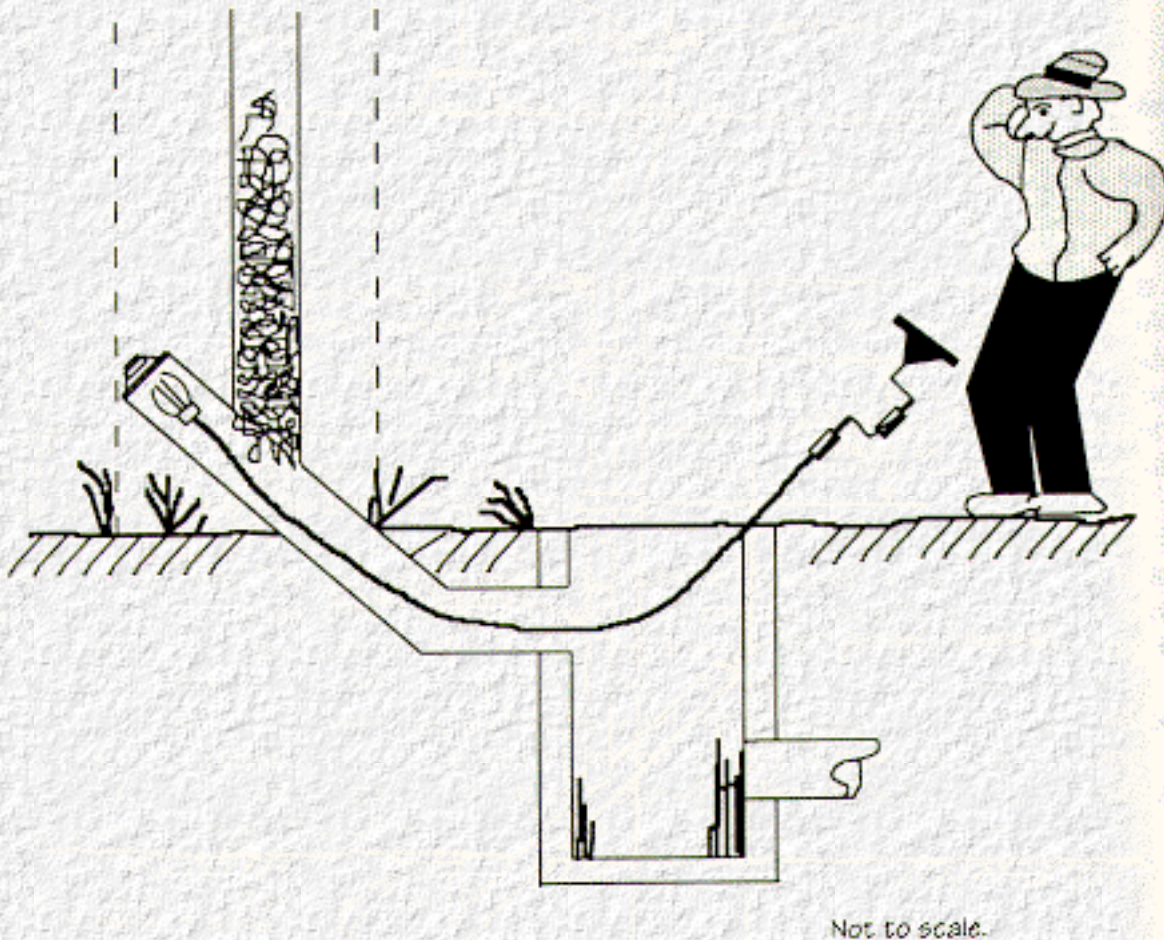

Figure 9. Blind alley cleanout.

6.4.2 Location to Conform to Structure and Aesthetic Needs

While pipes hung on a bridge may lack aesthetic appeal, pipes buried in concrete or concealed within the structure have inherent maintenance challenges. Therefore, a designer is cautioned against placing the drainage system within the superstructure. Drains are frequently located adjacent to bents or piers. Such drains may conveniently lead into pipes running into pier caps and then within a pier column, discharging at the base of the column. In cold regions, States are reluctant to encase drainage pipes within vertical concrete columns because water within such pipes can freeze and crack the surrounding concrete. Drain pipes should not be installed through box girders. In most cases the pipe leaks, freezes, and damages the box girder.

If piping is exposed, it should be parallel to the existing lines of the structure and painted to match the general color of the bridge. When piping is enclosed in the concrete of a pier shaft, it should be daylighted above the ground to provide access for backflushing, rodding, or air-pressure cleaning equipment. If the discharge is

into a storm drain, it ideally should first go into a manhole. The manhole may be tightly covered, but the cover should be removable for cleaning. The manhole invert should match the invert of the outgoing drain pipe. Also, the outgoing invert should be at least 0.1 foot below all other pipes connected to the manhole to allow for minor energy losses.

If the discharge is by free fall under the bridge, the pipes should be carried at least 3 inches below the bottom of the adjacent girders. They should not discharge water where it can easily blow over to and run down a column or pier. Water should not be discharged openly over any traveled way (either vehicular or pedestrian), unpaved embankment, or unprotected ground where it might cause erosion or undermine some structural element. In such cases, energy dissipaters and/or riprap should be provided to prevent erosion. Where the drain is a hole through the deck, the outlet end should be completely ringed by two drip grooves.

6.5 Outfall Design

An outlet pipe discharge should freely discharge into the receiving channel or storm drain. Placing the invert of the outfall pipe above the invert of the receiving system will help avoid clogging at the outlet. If the outlet pipe terminates in a manhole, it should be at least 0.1 feet above the manhole invert.

Free falling systems should extend below the superstructure and be placed away from piers to avoid wind-driven spray on bridge members. Drainage and roadway chemicals will cause corrosion and deterioration of bridge members. Such systems also should be placed so that falling water will not damage whatever is beneath the bridge. A free fall exceeding about 25 feet will sufficiently disperse the falling water so that no erosion damage will occur beneath the bridge. With less than 25 feet, splash blocks may be necessary.

The downdrain from the bridge end drain will discharge into an open channel or a storm drain. In either case, the outlet should be kept clear. Also, the exit velocity will be high because of the steep slope, and erosion protection (such as riprap) will be required for discharge into natural channels.

6.6 Discharge to Air

When holes in the deck or short vertical pipes are used to release water into the air, care must be taken that no erosion or damage occurs underneath. Water should never be dumped onto an embankment surface that lacks erosion protection, such as riprap, a paved slab, splash block, or an open basin. In locations where the free fall exceeds about 25 feet, the natural air movement will disperse the water enough not to erode the ground surface. Thus, bridges high in the air can be allowed to discharge water freely into the air.

To prevent unwanted dispersion, a heavy steel chain can be hung from the opening above to

the basin below. The water will follow the chain and, unless the wind is very strong, little will be lost. The device is used architecturally to lead water from eave drains into disposal systems on the ground. It looks better than a downspout. In addition, the water loses debris on the way down.

6.7 Bridge Expansion Joints

There are two types of expansion joints: (1) so-called water-proof type that, properly maintained, do not allow flow beneath the bridge deck, and (2) the open or finger-joint type that requires an underlying trough.

Collection troughs for catching water passing through open expansion joints range in composition from elastometric sheets to sheet metal gutters; an example is shown in [Figure 10](#) (Romack, 1992). With adequate slope (not less than 8 percent), these devices carry what comes through the joint to one side of the bridge to prevent runoff from reaching structural parts, unsightly staining, and water discharge onto traffic or pedestrians beneath the bridge. The design of drainage approaching a bridge must balance the bridge end inlet design with the need for flow to finger joints to assure scouring flow through the trough.

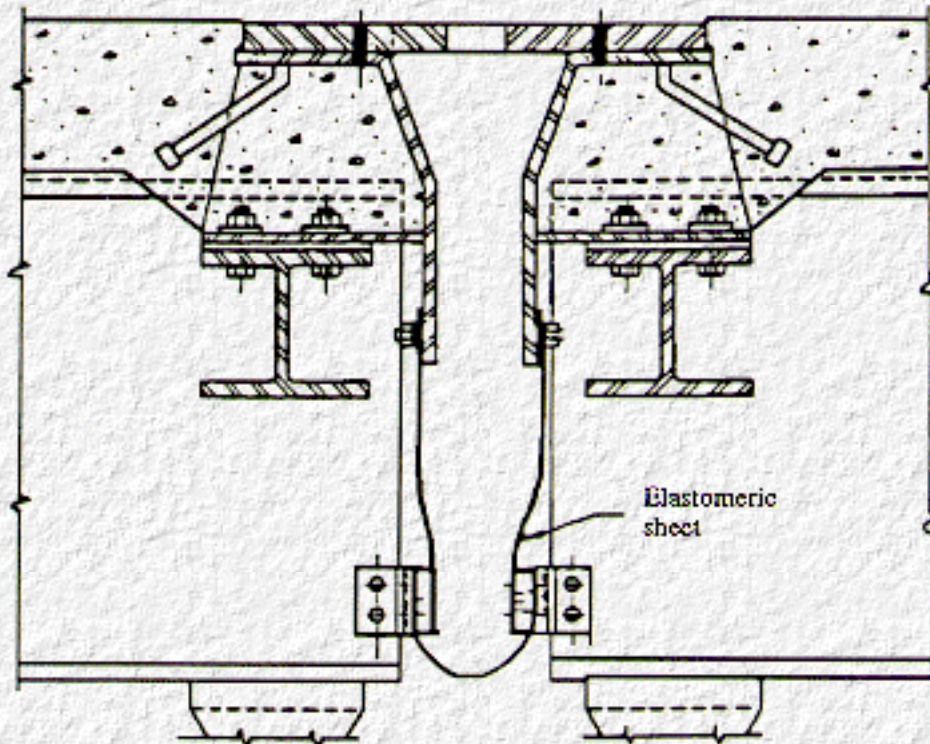

Notes:

- (1) The transverse slope of the elastomeric sheet should be 8% to scour out debris.
- (2) There may be a need to collect low-end discharge to avoid fall to environmentally sensitive areas.

Figure 10. Finger joint with elastomeric sheet to catch drainage.

[Go to Chapter 7](#)



Chapter 7 : HEC 21

Bridge End Collectors

[Go to Chapter 8](#)

Bridge end drainage inlets intercept gutter flow before it gets onto the bridge and remove gutter flow that leaves a bridge. They are designed using the principles contained in [HEC-12](#) (Johnson and Chang, 1984). The inlets are sufficient to capture all the gutter flow and can be grate inlets, curb-opening inlets, slotted inlets, or combination inlets. Curb openings or slotted-drain inlets are not usually effective unless extra cross slope is available.

7.1 Similarities to Pavement Drainage

Bridge end storm drain facilities are pavement drainage devices and are hydraulically designed using pavement drainage methods and charts. They have greater hydraulic capacity than bridge deck inlets and can have long curb opening inlets. They are commonly drop inlets and are typically precast, although cast-in-place or masonry structures are possible. [Figure 11](#) presents a two-inlet storm drain system with outfall to natural ground. Rather than the pipe shown under the traffic lanes, there may be two independent inlets, each discharging to outlet pipes that move water off each side of an embankment.

7.2 Design Flows

Each design agency should establish the percentage of bridge deck inlet blockage that will be incorporated into the design of bridge end systems. Recognizing that bridge end inlet interception will typically be less than 100 percent of the total approach gutter flow, care must be exercised in accounting for the resulting bypass flow. The flow, Q , generated from the bridge deck surface can be computed using the Rational Method [[Equation \(1\)](#)]. A slightly modified version of [Equation \(1\)](#) is presented in [Equation \(11\)](#):

$$Q = \frac{C i L_E W_p}{43560}, \quad (11)$$

where: C = Runoff coefficient, typically 0.9 for bridge decks.

i = Rainfall intensity, in/hr, for selected frequency and for appropriate time of concentration. This time of concentration should be the kinematic wave travel time from the crown or super-elevated side to the gutter, plus the flow time from the last inlet to the bridge end collector ($t_0 + t_g$) assuming no clogging. If inlets are clogged, the gutter flow time should be reckoned from the high point along the grade or the high bridge end.

L_E = The distance from the bridge end to the high point on the bridge (L_{E1} or L_{E2}), or the length of the bridge (L_B), if the high point is beyond the other end, feet.

W_p = The distance from the crown of the bridge deck to the curb or the width of the bridge if super-elevated with constant cross-slope, feet.

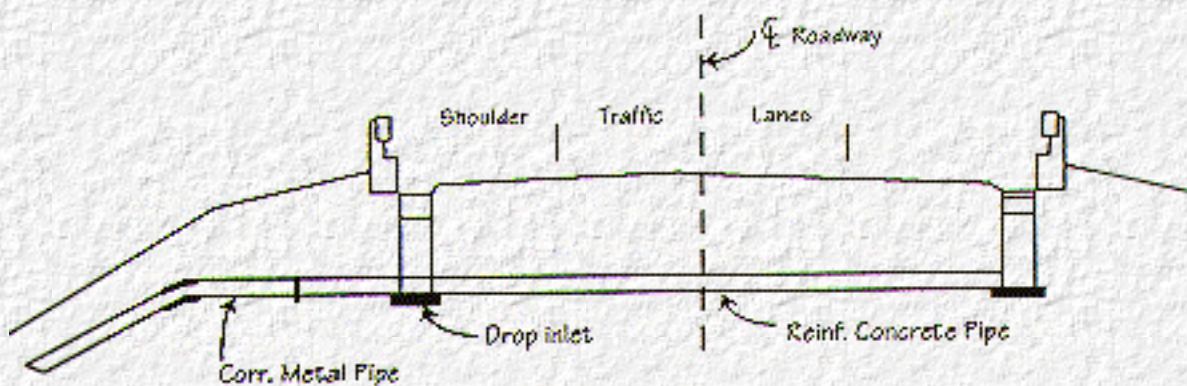
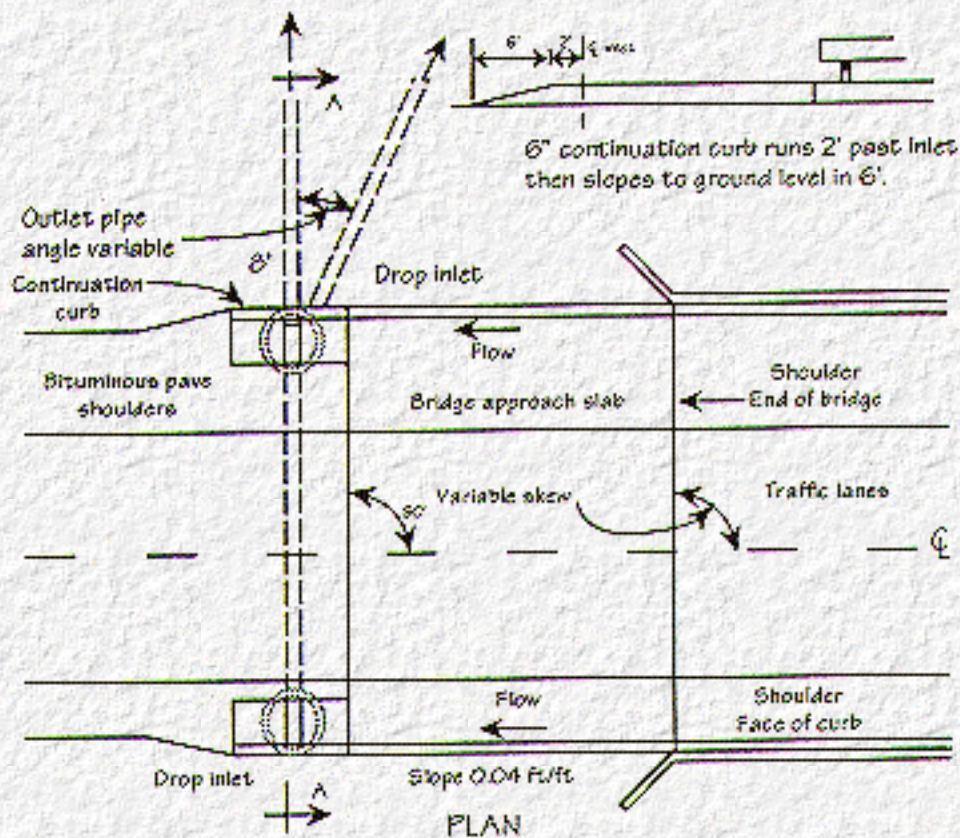

(Not to scale)

Figure 11. Bridge end storm drain.

For extremely long bridges, it may be unrealistic economically to assume all bridge deck inlets are clogged. In this case, extra care may be taken in the bridge inlet specifications to avoid clogging to give credit to drainage removal on the bridge. Computer programs, such as the HYDRAIN (Young and Krolak, 1992) Storm Drain Design and Analysis HYDRA model, can be used to determine the time of concentration through the system when pipes convey water to the end of a bridge rather than the nearest vertical down drain.

When bridges are down slope of approaches (which includes the undesirable case of sags located within the span of the bridge), the flow is based on the drainage to the bridge end inlet as estimated from the Rational Method, as presented in [Equation \(1\)](#), and rewritten in [Equation \(12\)](#):

$$Q = C i A, \quad (12)$$

where:

C = Runoff coefficient representative of drainage areas contributing to the inlet, which will be less than 0.9 if drainage is from road sides, grassed medians, areas beyond the right-of-way, etc.

i = Rainfall intensity for selected frequency and time of concentration, which is calculated for the appropriate drainage areas, in/hr.

A = Contributing drainage area, acres.

7.3 Differences Between Highway Pavement and Bridge Deck Drainage

Highway pavement drainage systems are placed at centerline stations that may coincide with other standard details:

1. Guardrail posts and guardrail transitions to the bridge occur near where inlets are best located.
2. Utility, sign- and lampposts are often located at bridge ends.
3. Curbing transitions from the gutter on the bridge to the pavement gutter on the approach are required.
4. Walkways and handrails can be transitional features at bridge ends.

5. Water, electric, gas, or other utility systems supported and integrated within the bridge emerge and are transitioned at the bridge ends.

It is necessary to require that the plans show exactly where the above features are located; it is undesirable to call out features by centerline stations with drafting symbols. The construction contractor should be made aware of how guardrail posts, sign posts, utility posts, and curb/gutter and utility transitions are dimensioned in the vicinity of bridge end storm drain inlets.

Bridge end storm drain systems are usually located on approach embankments. The situation causes several additional design considerations:

1. Inlet drain pipes and ditches are on steep slopes that parallel the side slope of the embankment. Pipes and ditches placed on the surface need to be designed to avoid sliding. Consideration should be given to anchors or other devices to prevent sliding.
2. Exit velocities from pipes and ditches that traverse large differences in elevation are high and reflect the conversion of high potential to kinetic energy. These velocities need to be dissipated to avoid erosive damage to the toe of the embankment. Information on the design of energy dissipaters can be found in [HEC-14](#) (FHWA, 1983).
3. Properly designed outlet works will minimize traffic obstacles within the right-of-way. Load bearing grates are necessary if traffic can traverse inlets. This depends upon the presence or absence of guardrails, the side slope of the embankment, and the distance of the structure from traffic lanes.
4. The inlet structures are supported by the embankment. Even though compaction specifications for embankments would assure sound footing, lighter structures provide less chance of settlement. They can be lightened by using lesser thicknesses, minimum vertical drops or lightweight concrete, and also can be placed so as to avoid traffic loads.

7.4 Typical Bridge End Drainage Systems

[Figure 12](#) shows typical features of a bridge end drainage system. The outlet pipe is corrugated metal. The corrugated metal offers resistance to sliding and minimizes outlet velocities. The system incorporates an energy dissipater. A horizontal length of pipe is necessary leading into the energy dissipater. [Figure 12](#) also implies the need to consider settlement of the inlet structure and the interaction with the guardrail. While grates on drop inlets are more efficient hydraulically, slotted inlets may be more appropriate in this setting to avoid traffic loads.

[Figure 13](#) shows a precast shoulder slot inlet that is placed directly on compacted fill. The shoulder slot inlet does not often bear traffic loads. The inlet floor acts as a spread footing. The shoulder slot inlet has a minimum drop to the inlet box and thin wall and floor thickness. A variable length is used so as to design interception properly; openings 10 to 20 feet long are typical to capture 100 percent of the flow. The device functions as a curb inlet. This design also uses 15-inch-unperforated corrugated plastic pipe rather than metal pipe in this setting. This

large diameter landscaping pipe is light and does not corrode. It is suitable to be embedded in embankment fills with no pipe bedding where no traffic load is expected.

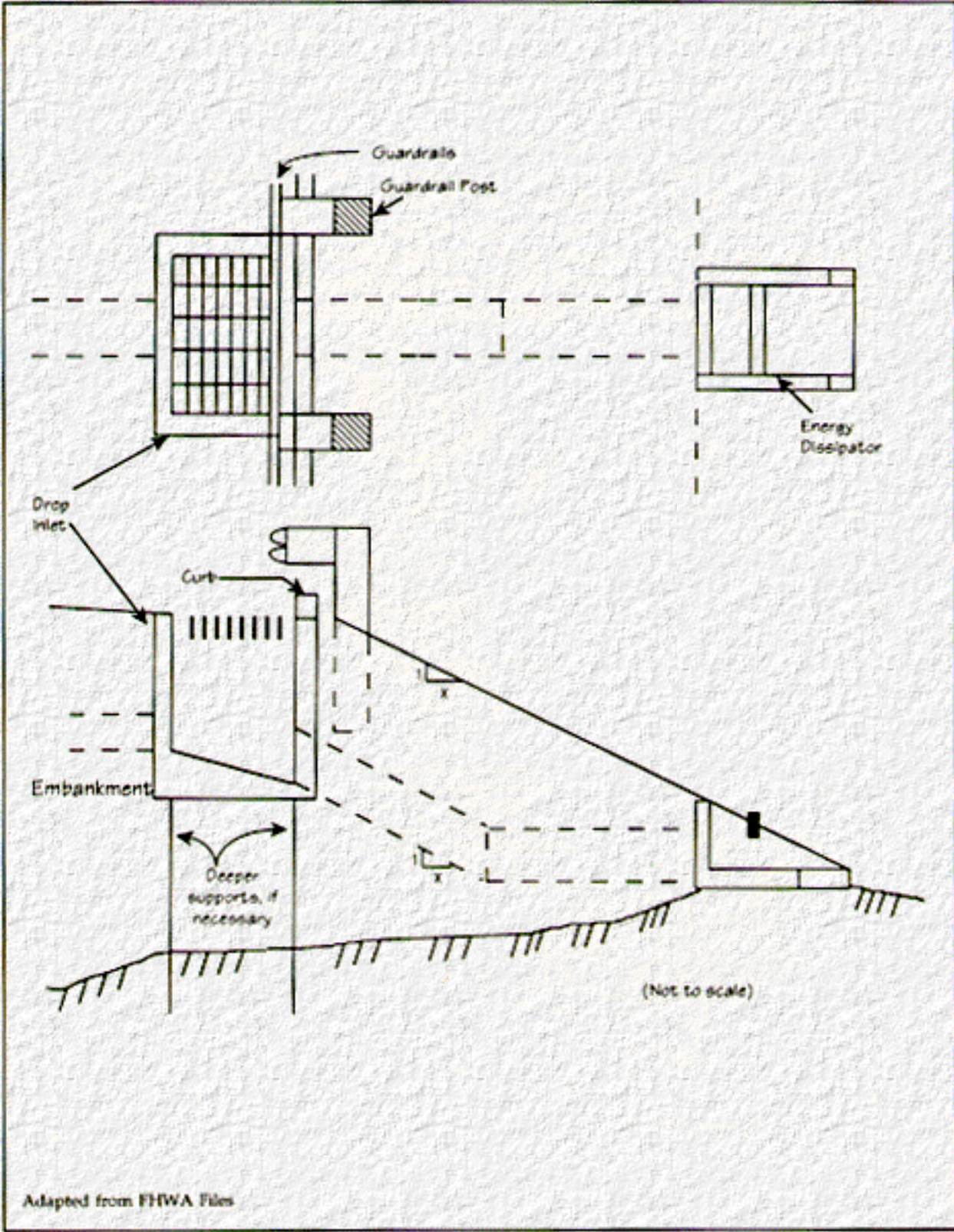
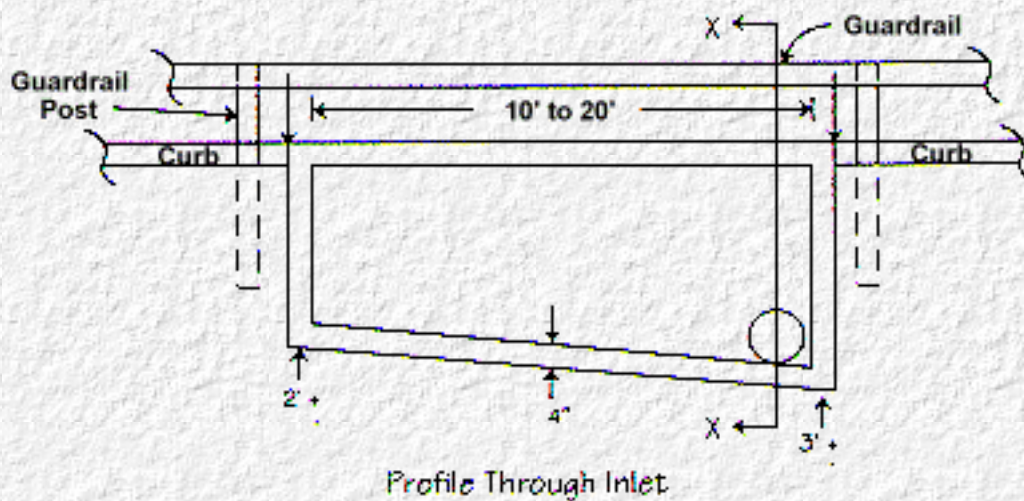
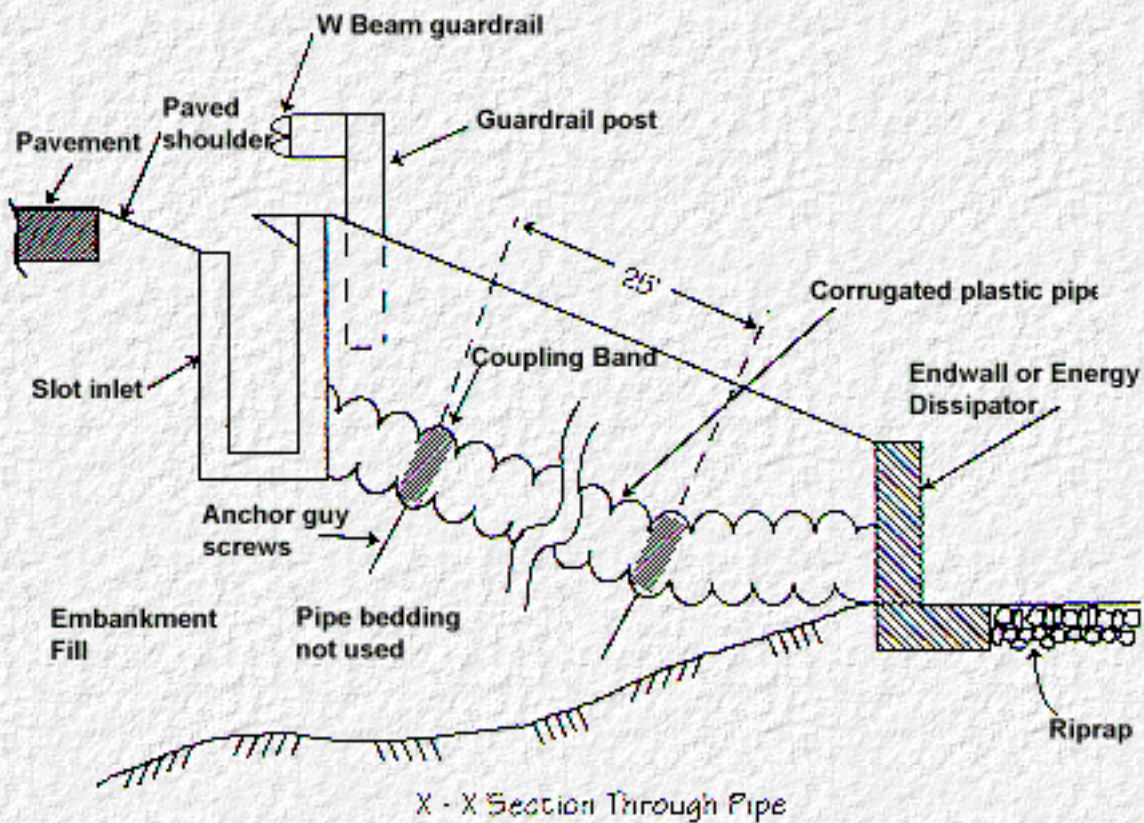

Figure 12. Bridge end detail--CMP drop inlet.



Adapted from special Virginia design

(Not to scale)

Figure 13. Bridge end shoulder slot inlet with plastic pipe.

[Figure 14](#) shows a bridge end drainage system that utilizes a concrete ditch outlet. However, concrete ditches are not recommended because water tends to overtop the sides and undermine the facility. One advantage of this approach is the low clearance required in the drop inlet, which cuts down on the weight and the associated settlement potential.

A rolled bituminous concrete curb design with a flared-end corrugated metal pipe is used in Wyoming. The rolled curb is formed to provide fall from the gutter invert into the flared metal entrance. The flared end may need to be modified with bars to make the opening safe. The flared pipe entrance is angled to the gutter flow line to promote inlet efficiency; the flow line turns 20 degrees to 30 degrees rather than 45 degrees. This necessitates both horizontal and vertical realignments to bring the pipe out perpendicular to the toe of the fill. This design may be appropriate and economical for low-traffic volume highways.

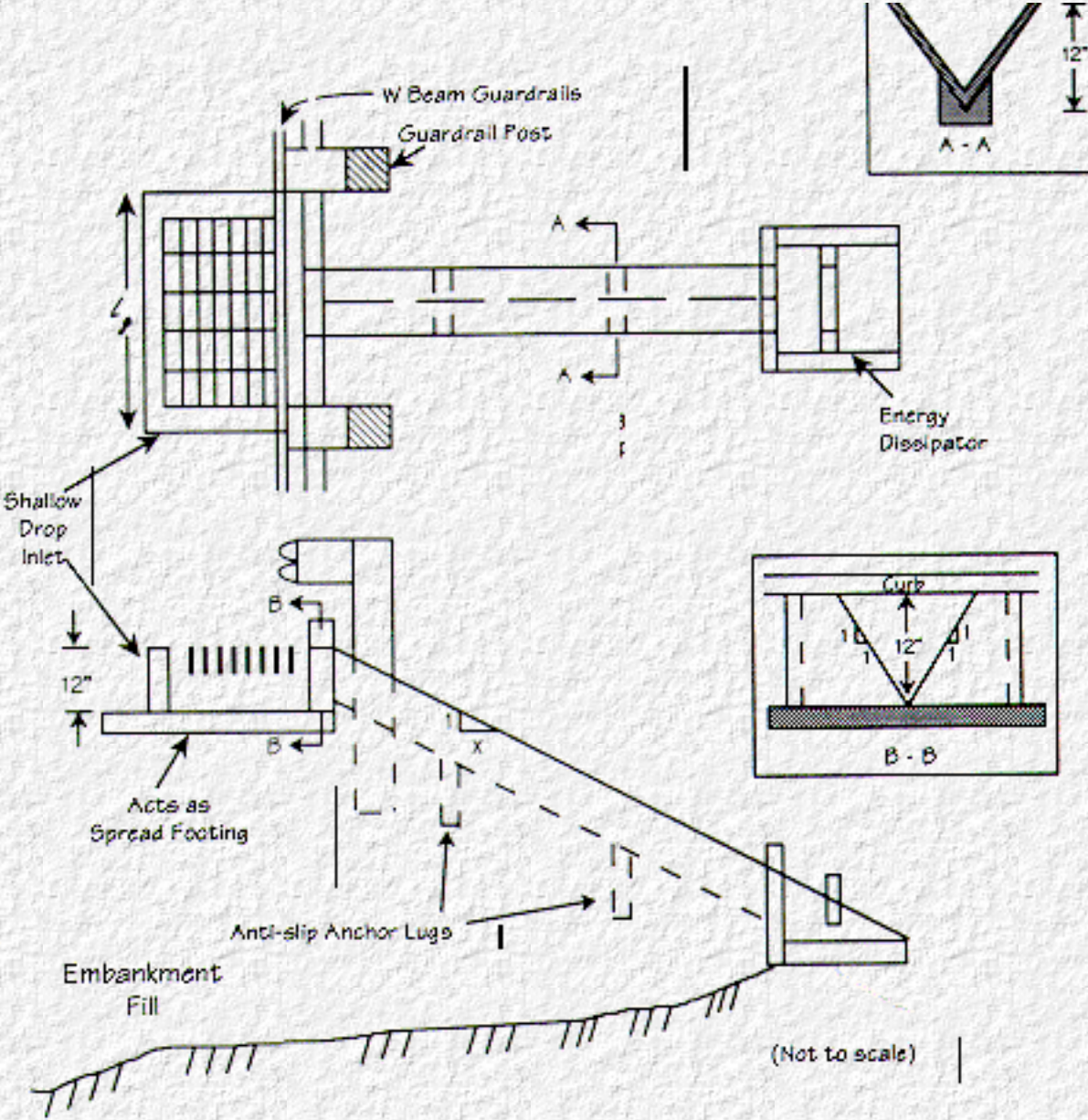

Figure 14. Bridge end detail--V ditch drop inlet.

[Go to Chapter 8](#)



Chapter 8 : HEC 21

Design Procedures

[Go to Chapter 9](#)

This chapter presents procedures for designing the drainage systems for constant-slope and flat bridges. Drainage design procedures for the more complex vertical-curve bridges are presented in [Appendix A](#). This chapter includes information needed before initiating design, guidance for selecting the design rainfall intensity, and design nomographs. Discussion of drainage system details and design of bridge end collectors is also included, as is a design checklist. Examples illustrating the constant-slope and flat-bridge procedures are presented in [Chapter 10](#).

8.1 Preliminary Data Analysis

The following information is necessary for the design of bridge deck drainage systems:

i = The design rainfall intensity, in/hr.

W_p = The width of the area being drained, feet. Typically, this is half the width of a crowned deck, or the entire width of a super-elevated deck.

S = The longitudinal grade of the deck, ft/ft.

S_x = The cross-slope of the deck, ft/ft.

T = The design spread, feet. The spread is the width of flow on the deck. For constant cross-slope, T is physically defined as the depth at the curb divided by the cross-slope. The design spread is the maximum allowable width of gutter flow and is selected by the bridge engineer. One approach may be to set T equal to the shoulder width (for example, 5 feet), keeping the gutter flow entirely off the traveled way. Another approach may be to let the flow on the deck move out to the expected track of the outside tires, which is about 3 feet into the lane; then if the shoulder is 5 feet wide, $T = 5 + 3 = 8$ feet. Still another approach is to sacrifice an entire lane of an infrequently traveled bridge; then if the lane width is 12 feet and the shoulder is 5 feet, then $T = 5 + 12 = 17$ feet.

n = Manning's roughness coefficient. For typical pavements, $n = 0.016$.

C = Runoff coefficient. For pavements, this value is usually taken as 0.9 to account for storage in voids and imperfections in the deck and paving material. This value may vary in the unusual case that drainage from upslope areas that represents different land uses is allowed to flow onto the bridge deck.

8.2 Establishment of Governing Design Element--Rainfall Intensity

Selection of the design rainfall intensity typically uses the Rational Method value associated with travel time to the first inlet and can be guided by two other considerations: the rainfall intensity at which hydroplaning occurs for a given set of road conditions and vehicle velocity and the intensity at which a driver's vision is impaired. Generally, the Rational Method intensity is a conservative design value, and thus, bridge deck drainage systems designed for that intensity may be considered adequate in terms of hydroplaning or driver vision criteria. Since the hydroplaning and driver vision criteria involve variable factors, such as tire tread wear and driver behavior, it is perhaps reasonable to use the Rational Method as the governing criterion for selecting rainfall intensity, and then to check that intensity against the other two criteria and make recommendations for modified pavement surface and/or highway signs, as appropriate.

8.2.1 Rational Method Rainfall Intensity

Using the Rational Method, select an intensity, i , from which the time of concentration of the deck drainage system (t_c) can be determined. The value of t_c is the sum of sheet flow time, plus gutter flow time, and for a bridge is on the order of 5 minutes. The duration of rainfall, t_d , is set equal to t_c . The design concept is: the designer selects the return period based on prevailing criteria. Given the t_d and return period, the designer consults an intensity-duration-frequency curve and selects i .

The [HEC-12](#) (Johnson and Chang, 1984) assumption is that inlets are independent drainage elements that pick up runoff from their small contributing drainage areas. This assumption gives a conservative and constant time of concentration for deck inlets and scuppers equally spaced and equals the time of concentration to the first inlet. However, for the off-bridge end systems, use the total t_c from the bridge high point to the inlet typically located on the downgrade approach embankment.

The steps of the Rational Method as presented in [HEC-12](#) and adapted for bridge decks are:

1. Obtain an intensity-duration-frequency (IDF) curve for the site under consideration. The HYDRAIN (Young and Krolak, 1992) computer model has a microcomputer method, HYDRO, keyed to the latitude and longitude of a site.
2. Select a return period, typically based on Federal, State, or local criteria.

3. Make a trial selection of intensity, i (in/hr).²
 - 4a. Compute overland (sheet) flow time of concentration, t_o , using [Equation \(2\)](#).
 - 4b. Compute the gutter flow time of concentration, t_g , using [Equation \(3\)](#).
 - 4c. Compute the total trial time of concentration, $t_c = t_o + t_g$; note that for a flat (0% slope) bridge, $t_c = 5$ minutes is used for all deck drainage.
 5. Use the IDF curve and the trial t_c to estimate a trial i . Check the initial and final trial t_c values. If equal, stop. If not, return to step 3 and make more trials.
-

8.2.2 Hydroplaning

The prevention of hydroplaning is based on pavement and geometric design criteria for minimizing hydroplaning. An empirical equation for the vehicle speed that initiates hydroplaning is (Gallaway, et al., 1979):

$$V_a = SD^{0.04} P_t^{0.3} (TD + 1)^{0.06} A_T, \quad (13)$$

where:

A_T , a Texas Transportation Institute empirical curve fitting relationship, is the greater of:

$$A_{T1} = \frac{10.409}{d^{0.06}} + 3.507, \text{ or } A_{T2} = \left[\frac{28.952}{d^{0.06}} - 7.817 \right] \text{TXD}^{0.14}, \quad (14)$$

where:

- V = Vehicle speed, mi/h.
- TD = Tire tread depth (1/32 in).
- TXD = Pavement texture depth, in.
- d = Water film depth, in.
- P_t = Tire pressure, psi.

SD = Spindown (percent); hydroplaning is assumed to begin at 10 percent spindown. This occurs when the tire rolls 1.1 times the circumference to achieve a forward progress distance equal to one circumference.

Inversion of equation (13) and equation (14) determines a film depth, **d**, associated with selected values for **V**, **TD**, **TXD**, **P_t**, and with **SD** = 10 percent (Young, et al., 1986). An estimate of design **d** for:

V = 55 mi/h.

TD = 7 (50 percentile level).

TXD = 0.038 in (mean pavement texture).

P_t = 27 psi (50 percentile level).

SD = 10 percent (by definition),

is **d** = 0.0735 in. This is suggested as a sound design value since it represents the combination of the mean or median of all the above parameters. However, a designer could compute other values of **d** based on other considerations. For example, a designer could groove a deck, increase **TXD** and alter **d** to reflect changed pavement design. Or, a designer could select **d** for higher vehicle speeds or for some other combination of adjustments.

Once a design **d** is determined, it is assumed that the thickness of the water film on the pavement should be less than **d**. Water flows in a sheet across the surface to the edge of the gutter flow. The width of sheet flow is the width of the deck area, **W_p**, less the design spread **T**, or (**W_p - T**). At the edge of the gutter flow, the design sheet flow depth is **d**.

Consider a 1-foot-long sheet flow path from the high point to the edge of the spread. The characteristics of this flow path are:

depth: The depth varies from 0 at the high point to the design hydroplaning depth, **d**, at the edge of the spread.

slope: The slope is the vector sum of the cross-slope, **S_x**, and the grade, **S**, or $(S_x^2 + S^2)^{0.5}$.

length: The length of the sheet flow rainfall is:

$$\frac{(W_p - T)}{S_x} (S_x^2 + S^2)^{0.5}. \quad (15)$$

width: The width is one foot.

design flow: Using the Rational Method, $q = CiA$, the sheet flow at the edge of the spread is:

$$q_R = \frac{Ci(W_p - T)(S_x^2 + S^2)^{0.5}}{43560 S_x} \quad (16)$$

sheet flow: Using Manning's equation.

$$V_s = \frac{1.49}{n} d^{0.67} [(S_x^2 + S^2)^{0.5}]^{0.5},$$

$$q_s = dV_s, \text{ thus} \quad (17)$$

$$q_s = \frac{1.49}{n} d^{1.67} (S_x^2 + S^2)^{0.25}.$$

By equating $q_R = q_s$ at the edge of the design spread, a design rainfall can be derived as a function of the design hydroplaning depth, d . Thus,

$$q_R = q_s, \text{ or}$$

$$\frac{Ci(W_p - T)(S_x^2 + S^2)^{0.5}}{43560 S_x} = \frac{1.49}{n} d^{1.67} (S_x^2 + S^2)^{0.25}, \quad (18)$$

and solving for i , gives the hydroplaning design rainfall intensity, as:

$$i = \left[\frac{64904.4}{Cn} \right] \left[\frac{S_x}{(S_x^2 + S^2)^{0.25}} \right] \left[\frac{d^{1.67}}{(W_p - T)} \right]. \quad (19)$$

This hydroplaning design rainfall is independent of the return period. [Table 2](#) and [Table 3](#) present hydroplaning design rainfall intensities for vehicle speeds of 55 and 65 mi/h, respectively (Woo, 1988).

Table 2. Hydroplaning rainfall intensity, i (in/hr), for $V = 55$ mi/h (hydroplaning sheet flow depth $d = 0.08$ in)

$n = 0.016$
 $C = 0.9$
 $TXD = 0.038$ in

S	S _x	(W _p - T)			
		24	36	48	58
0.01	0.01	3.7	2.5	1.9	1.5
	0.02	5.9	4.0	3.0	2.5
	0.04	8.7	5.8	4.4	3.6
	0.06	10.8	7.2	5.4	4.5
	0.08	12.5	8.3	6.2	5.1
0.02	0.01	3.0	2.0	1.5	1.2
	0.02	5.3	3.5	2.6	2.2
	0.04	8.4	5.6	4.2	3.5
	0.06	10.6	7.1	5.3	4.4
	0.08	12.3	8.2	6.2	5.1
0.04	0.01	2.2	1.5	1.1	0.9
	0.02	4.2	2.8	2.1	1.7
	0.04	7.5	5.0	3.7	3.1
	0.06	9.9	6.6	5.0	4.1
	0.08	11.8	7.9	5.9	4.9
0.06	0.01	1.8	1.2	0.9	0.7
	0.02	3.5	2.4	1.8	1.5
	0.04	6.6	4.4	3.3	2.7
	0.06	9.1	6.1	4.6	3.8
	0.08	11.2	7.5	5.6	4.6

0.08	0.01	1.6	1.0	0.8	0.7
	0.02	3.1	2.1	1.5	1.3
	0.04	5.9	4.0	3.0	2.5
	0.06	8.4	5.6	4.2	3.5
	0.08	10.5	7.0	5.3	4.4

Table 3. Hydroplaning rainfall intensity, i (in/hr), for $V = 65$ mi/h (hydroplaning sheet flow depth $d = 0.047$ in)

$n = 0.016$

$C = 0.9$

TXD = 0.038 in

S	S_x	$(W_p - T)$			
		24	36	48	58
0.01	0.01	1.5	1.0	0.8	0.6
	0.02	2.4	1.6	1.2	1.0
	0.04	3.5	2.4	1.8	1.5
	0.06	4.4	2.9	2.2	1.8
	0.08	5.0	3.4	2.5	2.1
0.02	0.01	1.2	0.8	0.6	0.5
	0.02	2.1	1.4	1.1	0.9
	0.04	3.4	2.3	1.7	1.4
	0.06	4.3	2.9	2.1	1.8
	0.08	5.0	3.3	2.5	2.1
0.04	0.01	0.9	0.6	0.4	0.4
	0.02	1.7	1.1	0.8	0.7
	0.04	3.0	2.0	1.5	1.2
	0.06	4.0	2.7	2.0	1.7
	0.08	4.8	3.2	2.4	2.0
0.06	0.01	0.7	0.5	0.4	0.3
	0.02	1.4	1.0	0.7	0.6
	0.04	2.7	1.8	1.3	1.1
	0.06	3.7	2.5	1.8	1.5
	0.08	4.5	3.0	2.3	1.9
0.08	0.01	0.6	0.4	0.3	0.3
	0.02	1.2	0.8	0.6	0.5
	0.04	2.4	1.6	1.2	1.0
	0.06	3.4	2.3	1.7	1.4
	0.08	4.3	2.8	2.1	1.8

8.2.3 Driver Visibility

The following empirical expression (Ivey, et al., 1975) relates rainfall intensity to driver visibility and vehicle speed:

$$S_v = \left[\frac{2000}{i^{0.68}} \right] \left[\frac{40}{V} \right], \quad (20)$$

where:

S_v = Driver visibility, ft.

i = Rainfall intensity, in/hr.

V = Vehicle speed, mi/h.

This empirical relationship was developed based on test data with the following ranges: rainfall, less than 2 in/hr; visibility, 1,500 to 6,000 feet. This equation may overestimate driver visibility distance for rainfall intensity greater than 2 in/hr--range with no available test data, but, a range of extremely low occurrence probability. Velocities of less than 20 mi/h would have less validity (Ivey, et al., 1975). At 55 mi/h, the nonpassing minimum stopping sight distance is 450 feet (this is the lower value of a range given by AASHTO).

Substituting these values,

$$450 = \left[\frac{2000}{i^{0.68}} \right] \left[\frac{40}{55} \right] \quad (21)$$

gives a rainfall intensity of 5.6 in/hr. The research supporting this estimate depicted a single car in rain on a test track. Note that cars in a travel corridor generate splash and spray that increase water droplet density over natural rainfall intensity. To compensate for splash and spray, a design intensity of 4 in/hr may be more realistic as a threshold value that will cause sight impairment. That is, design intensities, i , above 4 in/hr will probably obscure driver visibility in traffic and decrease sight distances to less than minimum AASHTO-recommended stopping sight distances.

The discussion is qualified by:

- The warnings of the researchers (Ivey, et al., 1975). The predictive relationship is empirical.

- Splash and spray are recognized and allowed for, but more research is needed to refine relationships.
- Night driving in the rain is very vision dependent. Data supporting the predictive relationship were secured in daylight.

Therefore, 4 to 5.6 in/hr is a suggested threshold design rain intensity range for the avoidance of driver vision impairment. Rainfall intensities below this range should not obscure a driver's view through a windshield with functioning windshield wipers.

8.3 Inlet Sizing

The dimensions of inlets are relatively constrained for placement and integration into bridge decks. Many decks are pre- or post-tensioned structural slabs, and inlets are details that may interfere with structural continuity. The surface grate and the recessed collection chamber must be considered.

The constraints are associated with reinforcing bar schedules or post-tensioned cable spacings. Typical dimensions need to be less than 12 to 18 inches; these details need to be structurally designed to transfer loads into the slab. Large inlet spans cause a need for special designs and reinforcing details.

The hydraulic problem is that spreads of 8 to 12 feet of water in gutters are not effectively reduced with small inlets having capture efficiencies of 5 to 10 percent. Numerous closely spaced inlets are necessary to control spread.

From a hydraulic standpoint, inlets need to be as large as possible. Considering the bridge deck structural system, 36 inches is probably the practical limit unless special structural details are provided.

Round vertical scuppers should not be less than 6 inches in diameter with 8 inches preferred. Four-inch-diameter scuppers are not uncommon in practice. However, their limited hydraulic capacity coupled with their tendency to plug with debris, mitigates recommending their use. While such features are easy to place, they are relatively ineffective with capture efficiencies on the order of 5 percent. Nonetheless, they may be convenient when drainage can fall directly to underlying surfaces without under deck pipe collection and downspouts. With direct fall of water, their small size is an advantage.

8.4 Collection System Details

The water collected at inlets either falls directly to surfaces beneath bridges or is collected. Collected storm water is conveyed to bridge support columns and downspouts that are affixed to vertical bridge members. The collectors are typically cast iron.

The collector pipes should be sloped at least 2 percent (1/4 in/ft) or more, preferably 8 percent, to provide sufficient velocities at low flow to move silt and small debris to avoid clogging. The gravity flow capacity of small diameter pipe flowing full at 2 percent slope are shown in [Table 4](#):

Table 4. Gravity flow capacity of small diameter cast-iron pipes

Diameter (in)	Full Gravity Discharge at 2 percent Slope (ft ³ /s)	Velocity at 10 percent Full (ft/s)
4	0.3	1.1
6	0.8	1.4
8	2.3	1.6
10	3.0	1.9
12	5.0	2.1

The inlet capacity for the typical bridge deck drainage system is less than the above capacities. Therefore, collector size is not a critical hydraulic decision so long as it is sloped sufficiently to clean out and avoid clogging. Pipe connections should be Y-shaped rather than at right angles. Vertical downspout members should be at least 6 inches and should be provided with Y-fittings to allow clean out with flexible snake cables, water under pressure, or compressed air.

When discharging at the surface under the bridge, splash blocks or energy dissipators are needed to control erosion, unless discharging more than 25 feet from the ground.

8.5 Design of Bridge End Collectors

Bridge end collectors are essential. Properly designed collectors minimize problems such as ponding, erosion, and conflicts with bridge and roadway structures. The design of drainage approaching a bridge must balance bridge end inlet design with the need for flow to open bridge expansion joints and flushing of underlying troughs. An adequate downslope collector will prevent erosion or washout of the embankment and the bridge abutment itself. Water on the bridge may flow into open finger expansion joints, and should be caught with a transverse trough to deny water access to structural components. If end treatment designs are not coordinated with other elements of the design, placement of guardrail

supports, signs, or other posts may interfere with the hydraulic capacity of the end collectors.

8.5.1 Location Guidance

The type of bridge end treatment is a function of its location with respect to flow. Inlets upslope of the bridge should be designed and placed to intercept all of the approach flow except that required to flush the troughs beneath open expansion joints. These inlets, or other drainage provisions, should be on both sides of the roadway unless cross-slopes or super-elevation concentrates flow on one side of the roadway. When the slope of the roadway is toward the bridge, the roadway gutter or swale will lead to the inlet naturally. Abrupt changes in alignment of the gutter upstream of the inlet results in bypass of the inlet.

At the downslope end of a bridge, the transition between the bridge deck gutter to the end drain should be gradual to assure that flow is intercepted. If a sag exists downslope of the bridge, the end drain should be placed at the low point of the sag. Flanking drains to either side of the low point should also be considered, depending on the importance of preventing overtopping of the curb or excessive spread on the pavement. The downslope drain should intercept the bridge drainage that bypasses the deck drains. The designer should deduct the intercepted flow to arrive at the design flow of the downslope drain. Should blockage of the deck drains be significant, the system should be designed assuming a factor accounting for blockage. A conservative approach would be to design the downslope drain to intercept 100 percent of the bridge deck drainage (assuming the deck drains, if any, are clogged) using the design rainfall selected for the roadway system.

8.5.2 Inlet Information

Grate inlets, curb opening inlets, combination inlets, or slotted drain inlets may be used for bridge end drains. The hydraulic characteristics of the inlet should be considered in selecting the type. For example, if the flow spread is wide and 100 percent interception is necessary, a curb opening inlet may be a poor choice since a very long inlet will be necessary. Design capacities of such inlets are presented in [HEC-12](#) (Johnson and Chang, 1984).

8.5.3 Outfall Pipe Information

Storm drains convey the flow from the end drain inlet box to a suitable outfall at the toe of the embankment slope. Open chutes are not recommended because of difficulties turning the flow and keeping the flow within the chute.

Since the slope of the bridge end downdrain is usually steep like the embankment itself, the pipe will carry high flow rates and its hydraulic capacity is limited by the pipe inlet. The pipe inlet will function as either a weir or an orifice, depending on the depth of water in the inlet box. The inlet control nomographs of [HDS-5](#) (Normann, et al., 1985) can be used to define the downdrain capacity.

The downdrain from the bridge end collector will discharge into an open channel or storm drain. Since the exit velocity will be high due to the steep slope, erosion protection (such as riprap or energy dissipators) may be required.

²Trials are necessary because both timing [Equation \(2\)](#) and [Equation \(3\)](#) have the intensity as an independent variable.

[Go to Chapter 9](#)



Chapter 9 : HEC 21

Bridge Deck Drainage Method

[Go to Chapter 10](#)

Methods for determining inlet spacing for constant-slope and flat bridges are presented in this chapter. More complex procedures for vertical curve bridges are presented in [Appendix A](#). For all cases, the Rational Method design approach is used. All charts referenced in this chapter are contained in [Appendix C](#).

9.1 Constant-Grade Bridges

The logic for computing inlet spacing on a constant-grade bridge is shown in [Chart 1](#) in [Appendix C](#). If the bridge slope is nearly flat (less than about 0.003 ft/ft), then the procedures for flat bridges should also be followed as a check. The general procedure is to start at the high end of the bridge and work downslope from inlet to inlet. First, the designer selects a return period and design spread. General bridge dimensions, bridge grade, roughness and runoff coefficients, and inlet specifications are assumed to be known.

The procedure is:

1. Find the appropriate rainfall intensity. The Rational Method can be used. Given an IDF curve, the:
 - a. Overland time of concentration can be found using [Chart 2](#) in [Appendix C](#) or [Equation \(2\)](#).
 - b. Time of gutter flow can be found using [Chart 3](#) or [Equation \(3\)](#). The sum of overland and gutter flow times is used with the IDF curve (use 5 minutes even if the sum is less than 5 minutes) to find the Rational Method intensity. This intensity can be compared with the intensities developed using hydroplaning or driver vision methods.
2. Find the flow on the deck, Q , at design spread, T , using [Chart 4](#) or [Equation \(4\)](#).
3. Starting at the high end of the bridge, the inlet spacing can be computed using the inlet spacing nomograph in [Chart 5](#) or [Equation \(22a\)](#) and [Equation \(22b\)](#), the derivations of which are given in [Appendix B](#):

$$L_0 = \frac{43560 Q}{C_i W_p}, \text{ for the first inlet,} \quad (22a)$$

or between inlets as,

$$L_c = \frac{43560 Q}{C_i W_p} E, \text{ for the general case,} \quad (22b)$$

where:

i = Design rainfall intensity, in/hr, (step 1).

Q = Gutter flow, ft³/s, (step 2).

L_c = Constant distance between inlets, feet.

L_0 = Distance to first inlet, feet.

C = Rational runoff coefficient.

W_p = Width of pavement contributing to gutter flow, feet.

E = Constant, which is equal to 1 for first inlets in all cases and is equal to capture efficiency for subsequent inlets of constant-slope bridges.³

Since the first inlet receives virtually no bypass flow from upslope inlets, the constant E can be assumed to be equal to 1. The computed distance, L_0 , is then compared with the length of the bridge. If L_0 is greater than the length of the bridge, then inlets are not needed and only bridge end treatment design need be considered.

4. If inlets are required, then the designer should proceed to calculate the constant inlet spacing, L_c , for the subsequent inlets.

4a. Inlet interception efficiencies for particular inlets or scuppers can often be found in the manufacturers' literature. If such information is not available, then [Chart 6](#), [Chart 7](#), [Chart 8](#), [Chart 9](#), and [Chart 10](#) can be used to estimate efficiency.

For **circular scuppers**, [Chart 6](#) summarizes results from a laboratory study conducted at the University of South Florida (Anderson, 1973). Efficiency curves are provided for grades of 0.2, 2.0, and 5 percent. To use the figure, calculate the ratio of inlet diameter, D , to gutter spread, T , and enter the graph at the appropriate value along the x-axis. It should be noted that one cross bar across the circular scupper did not significantly reduce efficiency for a diameter of 4 inches. Upon intersection with the applicable curve (or appropriate interpolated curve), read efficiency, E , from the y-axis.

For **rectangular inlets**, several steps are necessary to calculate flow interception efficiency, E , which is the ratio of intercepted to total deck flow. Note that such grates in bridge decks need to be consistent with reinforcing bar spacing. Additional structural details are needed to transfer the load from the imbedded grate to the reinforced deck slab.

- Find the ratio of frontal flow bound by width of grate, W , to total deck flow, E_o , using [Chart 7](#).
- Find the flow intercepted by the inlet as a percent of the frontal flow. Identify the grate

type using the information shown in [Chart 8](#). The gutter velocity is needed and is provided by [Chart 9](#).

- [Chart 10](#) is then used to determine the portion of the frontal flow (R_f , the total flow within a grate width from the curb) that is intercepted by a grate. This will be less than 100 percent when the gutter velocity exceeds the splashover velocity.
- The interception efficiency, E , is then computed as:

$$E = R_f E_0 . \quad (23)$$

In using [Equation \(23\)](#), it is assumed that side flow interception is negligible. If the designer wishes to consider side flow, [HEC-12](#) (Johnson and Chang, 1984) should be consulted.

- The flow intercepted by an inlet is:

$$Q_i = E Q_W \text{ where } Q_W = E_0 Q .$$

- And the flow bypassing an inlet is:

$$Q_b = Q [E_0 (1 - E) + (1 - E_0)] .$$

For small rectangular inlets without grates, use [Chart 7](#), [Chart 8](#), and [Chart 9](#) as above assuming grate type A in [Chart 8](#) and [Chart 9](#). Should such inlets be depressed, use the boundaries of the depression to define the inlet width (W) and inlet length (L_g).

For side slot scuppers, as in New Jersey Type Barrier, [Figure 7](#) provides guidance on selection of E . Curb inlet design charts are found in [HEC-12](#) (Johnson and Chang, 1984).

5. Once efficiency, E , has been determined, [Chart 5](#) is used to calculate the constant inlet spacing L_c . It should be noted that Q_f represents the full flow in the gutter for a corresponding spread, T . Since bridge deck grade and time of concentration are assumed to be constant, the spacing between inlets will be constant.
 6. Continue to space inlets until the end of the bridge is reached. Once L_0 and L_c have been determined analytically, these values may need to be adapted to accommodate structural and aesthetic constraints.
 7. The final step is to design the bridge end treatments, which are recommended for all bridges, whether they require bridge deck inlets or not.
 8. Compare the design rainfall intensity with hydroplaning intensity and visibility criteria.
-

9.2 Flat Bridges

[Chart 11](#) presents the logic diagram for computing inlet spacing for horizontal bridges. The procedure is as follows:

1. The time of concentration (t_c) to each inlet is assumed to be 5 minutes. Frequency, design spread (T), pavement width (W_p), bridge length (L_B), Manning's n (n), rational runoff coefficient (C), and gutter cross-slope (S_x) are assumed to be known. Using a time of concentration of 5 minutes and the selected frequency, rainfall intensity is determined from the intensity-duration-frequency (IDF) curves.
2. Constant inlet spacing, L_c , can then be computed using the nomograph presented in [Chart 12](#) or [Equation \(24\)](#) the derivation of which is given in [Appendix B](#):

$$L_c = \frac{1312}{(n C_i W_p)^{0.67}} S_x^{1.44} T^{2.11}. \quad (24)$$

3. The computed spacing is then compared with the known bridge length. If L_c is greater than the length of the bridge, then there is no need for inlets and the designer need only be concerned with the design of bridge end treatments. If L_c is less than the bridge length, then the total needed inlet perimeter (P) can be computed using the nomograph in [Chart 13](#) or [Equation \(25\)](#), which is based on critical depth along the perimeter of the inlet (weir flow) as derived in [Appendix B](#).

$$P = \frac{(C_i W_p)^{0.33} T^{0.61}}{102.5 S_x^{0.06} n^{0.67}}. \quad (25)$$

4. Adapt spacing to accommodate structural and aesthetic constraints.
5. Design bridge end treatments.
6. Compare the design rainfall intensity with hydroplaning intensity and visibility criteria.

Bridges with vertical curves, having either sags or high points, are nearly flat at their low or high point stations. Bridges with grades less than about 0.3 percent are nearly flat. For nearly flat stations on vertical curve bridges or bridges with constant grades, the designer should check spacing, assuming the bridge is flat. If the flat spacing is less than the spacing determined using a nearly flat grade, then the provision of the flat grade spacing is warranted.

³The **E** designation makes the relationship general for bridges in vertical curves; for curved bridges. **K**, which is a function of **E** (see [Appendix C](#) and [Chart 15](#)) is used.

[Go to Chapter 10](#)



Chapter 10 : HEC 21

Illustrative Examples

[Go to Appendix A](#)

This chapter provides five examples of drainage designs for bridges having a constant grade or no grade. Example 1 is typical of most bridges--no drainage inlets details are needed on the bridge itself. Examples 2 and 3 are different bridges that need inlets on the deck. Examples 4 and 5 are flat bridges; this situation occurs for causeways across marshes, swamps, tidewaters, and for flat land bridges, typically near the oceans. An example for drainage for a more complicated vertical curve bridge is given in [Appendix A](#).

10.1 Example 1--500 Foot, 3 Percent Grade Bridge (No Inlets Needed)

Given: 500 foot bridge with 3 percent grade ($S_o = 0.03$)

$$W_p = 18 \text{ feet,}$$

$$n = 0.016,$$

$$C = 0.9,$$

$$S_x = 0.02,$$

$$T = 10 \text{ feet, and}$$

Frequency = 10-year return period.

The pavement width, W_p , is the width of the bridge from the centerline crown to the gutter edge.

Inlets, if provided, will be 1 foot wide ($W = 1$), 1.5 feet long ($L_g = 1.5$), and will have bicycle-safe, curved vane grates. The bridge has waterproof expansion joint. All upslope pavement drainage is intercepted by bridge end collector.

Find: Inlet spacing, L_o , L_c .

Solution: Use [Chart 1](#), [Chart 2](#), [Chart 3](#), [Chart 4](#), and [Chart 5](#) in [Appendix C](#) and IDF curve for Charlotte, North Carolina, shown in [Figure 15](#).

Step 1. Compute intensity, i , for time of concentration, t_c , to first inlet. Use IDF curve and [Chart 2](#) and [Chart 3](#) in the iterative procedure.

a) Select a trial value for t_c of 5 minutes and verify this assumption.

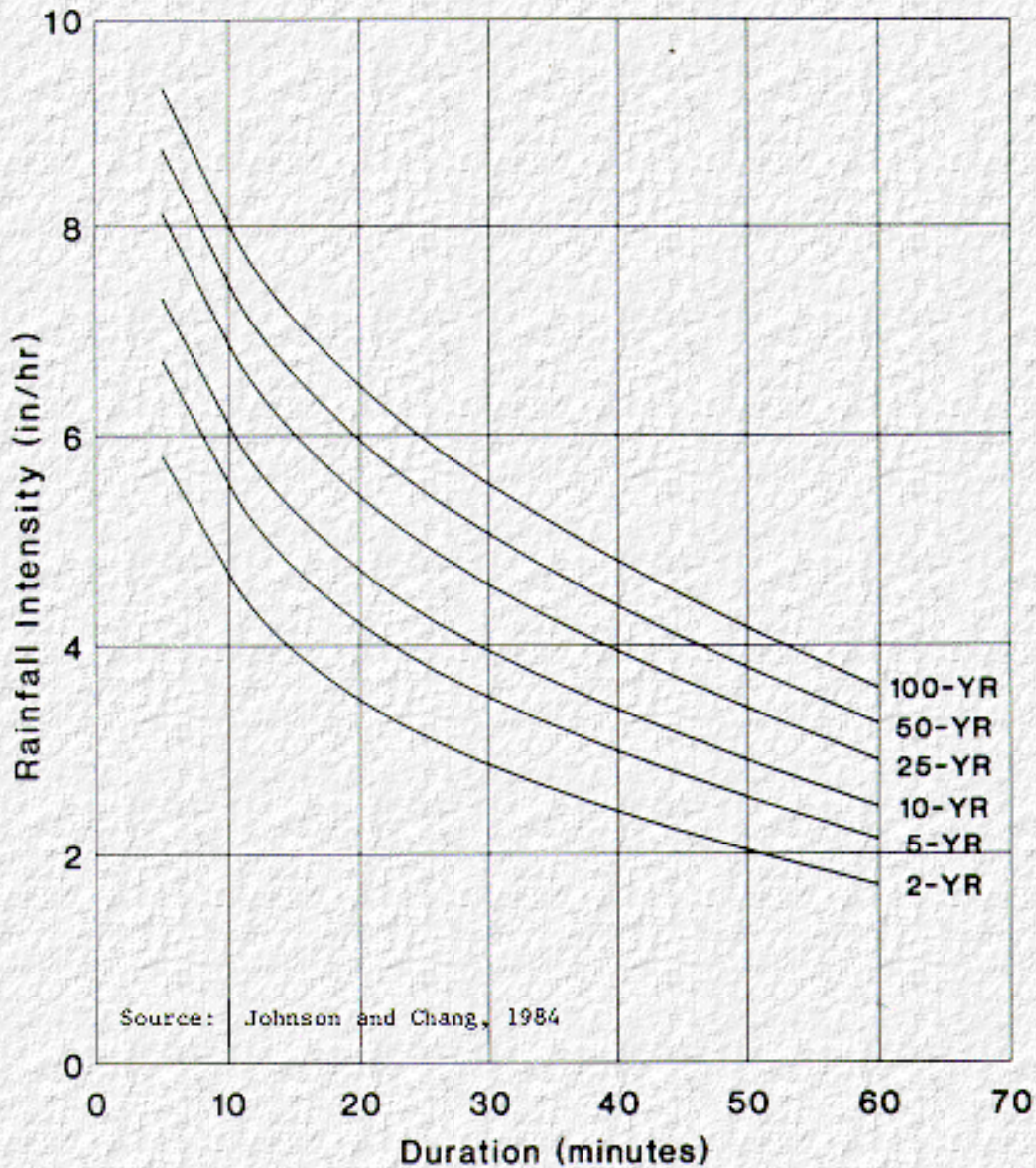

Figure 15. Intensity-Duration-Frequency curves for Charlotte, North Carolina.

b) From the IDF curve ([Figure 15](#)), the intensity, i , for a 10-year storm of 5 minutes in duration is 7.3 in/hr.

c) Compute the overland flow time of concentration using [Chart 2](#) or [Equation \(2\)](#).

$$t_o = 0.93 \frac{(18)^{0.6} (0.016)^{0.6}}{[(0.9)(7.3)]^{0.4} (0.02)^{0.3}} = 0.67 \text{ min.}$$

d) Compute gutter flow time of concentration using [Chart 3](#) or [Equation \(3\)](#). Since the upslope bridge end inlet intercepted all approach flow, $E = 1$.

$$t_g = 484 \frac{(0.02)(10)^2}{(0.9)(7.3)(18)} = 8.19 \text{ min.}$$

e) Compute total t_c and compare with selected trial value.

$$t_c = 0.67 + 8.19 = 8.86 \text{ min.}$$

f) Since the trial value of 5 minutes and the computed value of 8.86 minutes are not equal, select another trial t_c value of 11 minutes and repeat steps (c) through (e). The intensity at this duration, from [Figure 15](#), is 6.0 in/hr.

g) The computed time of concentration for the second trial duration is 10.7 minutes, which is approximately equal to 11 minutes. Therefore, use $i = 6.0$ in/hr as the design intensity.

Step 2. Compute full gutter flow based on the design spread of 10 feet. Use [Chart 4](#) or [Equation \(4\)](#).

$$Q_f = \frac{0.56}{0.016} (0.02)^{1.67} (0.03)^{0.5} (10)^{2.67} = 4.1 \text{ ft}^3/\text{s.}$$

Step 3. Starting at the upslope end of the bridge, compute the distance to the first inlet, L_o , using [Chart 5](#) with $E = 1$ or [Equation \(22a\)](#).

$$L_o = \frac{(43560)(4.1)}{(0.9)(6.0)(18)} = 1837 \text{ ft.}$$

Since L_o is greater than the total bridge length (500 ft), drainage inlets are not required.

Step 4. Design bridge end treatments. With no bridge deck inlets, all bridge deck runoff passes to an inlet off the bridge.

a) If the curb line and cross slope are extended beyond the bridge, the inlet would be located 1,837 feet from the high end of the bridge. The inlet would need to accept the following flow:

$$Q = (0.9)(6.0) \frac{(1837)(18)}{43560} = 4.10 \text{ ft}^3/\text{s.}$$

b) If the bridge end transitioned to a situation where the deck drainage needed to be removed from the roadway (like an embankment with shoulders without curb and gutter), the time of concentration would be reduced to approximately:

$$\frac{500}{1938} 11 = 3.0 \text{ min.}$$

by linear interpolation of the bridge length to the length of required inlet calculated above. This is less than the lower IDF curve values--therefore, use 5 minutes, which gives an intensity of 7.3 in/hr (see step 1 above). The bridge end treatment would have to handle:

$$Q = (0.9)(7.3) \frac{(500)(18)}{43560} = 1.36 \text{ ft}^3/\text{s}.$$

10.2 Example 2--2,000 Foot, 1 Percent Grade Bridge

Given: 2,000 foot bridge with 1 percent grade as shown in [Figure 16](#).

$$\begin{aligned} W_p &= 34 \text{ ft}, \\ n &= 0.016, \\ C &= 0.9, \\ S_x &= 0.02, \\ T &= 10 \text{ ft, and} \end{aligned}$$

Frequency = 10-year return period.

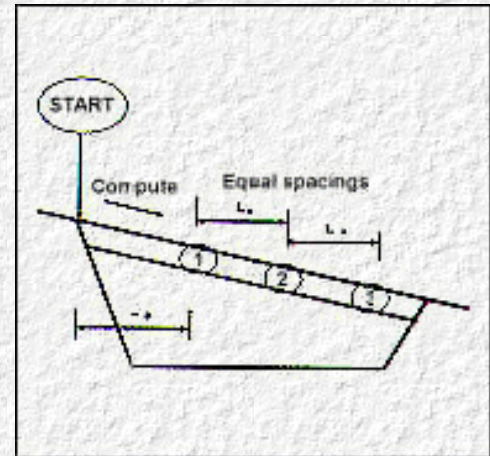

Figure 16. Constant grade bridge.

The pavement width, W_p , is the width of the bridge from the centerline crown to the gutter edge.

Inlets will be 1 foot wide ($W=1$), 1.5 feet long ($L_g=1.5$), and will have bicycle-safe, curved vane grates. The bridge has waterproof expansion joint. All upslope pavement drainage is intercepted by bridge end collector.

Find: Inlet spacing, L_o , L_c .

Solution: Use [Chart 1](#), [Chart 2](#), [Chart 3](#), [Chart 4](#), and [Chart 5](#) in [Appendix C](#) and IDF curve for Charlotte, North Carolina, shown in [Figure 15](#).

Step 1. Compute intensity, i , for time of concentration, t_c , to first inlet. Use IDF for Charlotte, N.C., and [Chart 2](#) and [Chart 3](#) in iterative procedure.

- Select trial value for t_c of 5 minutes and verify this assumption.
- The i for duration of 5 minutes and 10-year storm is 7.3 in/hr from IDF curve.
- Compute overland flow time of concentration using [Chart 2](#) or [Equation \(2\)](#).

$$t_o = 0.93 \frac{(34)^{0.6} (0.016)^{0.6}}{[(0.9)(7.3)]^{0.4} (0.02)^{0.3}} = t_o = 0.98 \text{ min.}$$

d) Compute gutter flow time of concentration using [Chart 3](#) or [Equation \(3\)](#). Since the upslope bridge end inlet intercepted all approach flow, $E = 1$.

$$t_g = 484 \frac{(0.02)(10)^2}{(0.9)(7.3)(34)} = 4.33 \text{ min.}$$

e) Compute total t_c and compare with selected trial value.

$$t_c = 0.98 + 4.33 = 5.3 \text{ min} \approx 5 \text{ min.}$$

Had t_c been less than 5 minutes, then set $t_c = 5$ min.

f) Since trial value and computed value are approximately equal, use $i = 7.3$ in/hr as design intensity.⁴

Step 2. Compute full gutter flow based on the design spread of 10 feet. Use [Chart 4](#) or [Equation \(4\)](#).

$$Q_f = \frac{0.56}{0.016} (0.02)^{1.67} (0.01)^{0.5} (10)^{2.67} = 2.4 \text{ ft}^3/\text{s.}$$

Step 3. Starting at the upslope end of the bridge, compute the distance to the first inlet, L_o , using [Chart 5](#) with $E = 1$ or [Equation \(22a\)](#).

$$L_o = \frac{(43560)(2.4)}{(0.9)(7.3)(34)} = 468 \text{ ft.}$$

Step 4. Since L_o is less than the total bridge length, inlets are needed. Determine the inlet efficiency, E .

a) Using [Chart 7](#) or [Equation \(7\)](#), compute the frontal flow ratio, E_o .

$$E_o = 1 - \left(1 - \frac{1}{10}\right)^{2.67} = 0.245.$$

b) Using [Chart 9](#) or [Equation \(5\)](#), compute gutter velocity.

$$V = \frac{1.12}{0.016} (0.02)^{0.67} (0.01)^{0.5} (10)^{0.67} = 2.38 \text{ ft/s.}$$

c) Using [Chart 10](#), find frontal flow intercept efficiency, R_f , for a curved vane grate, $L_o = 1.5$ ft. The splashover velocity, V_o , is 4.9 ft/s, which is greater than the gutter velocity, implies an R_f of 1.0.

$$\text{Thus: } E = E_o R_f = (0.245)(1) = 0.245.$$

Step 5. Compute constant spacing between the remainder of the inlets using [Chart 5](#) or [Equation \(22b\)](#).

$$L_c = \frac{(43560)(2.4)}{(0.9)(7.3)(34)} (0.245) = 115 \text{ ft.}$$

Step 6. Adapt spacing to structural constraints. For example, if the bent spacing is 100 ft, use $L_o = 400$ feet and $L_c = 100$ feet, rather than 468 and 115 feet. Thus, as illustrated in [Figure 17](#), the number of inlets per side is $(2000 - 400)/100 = 16$.

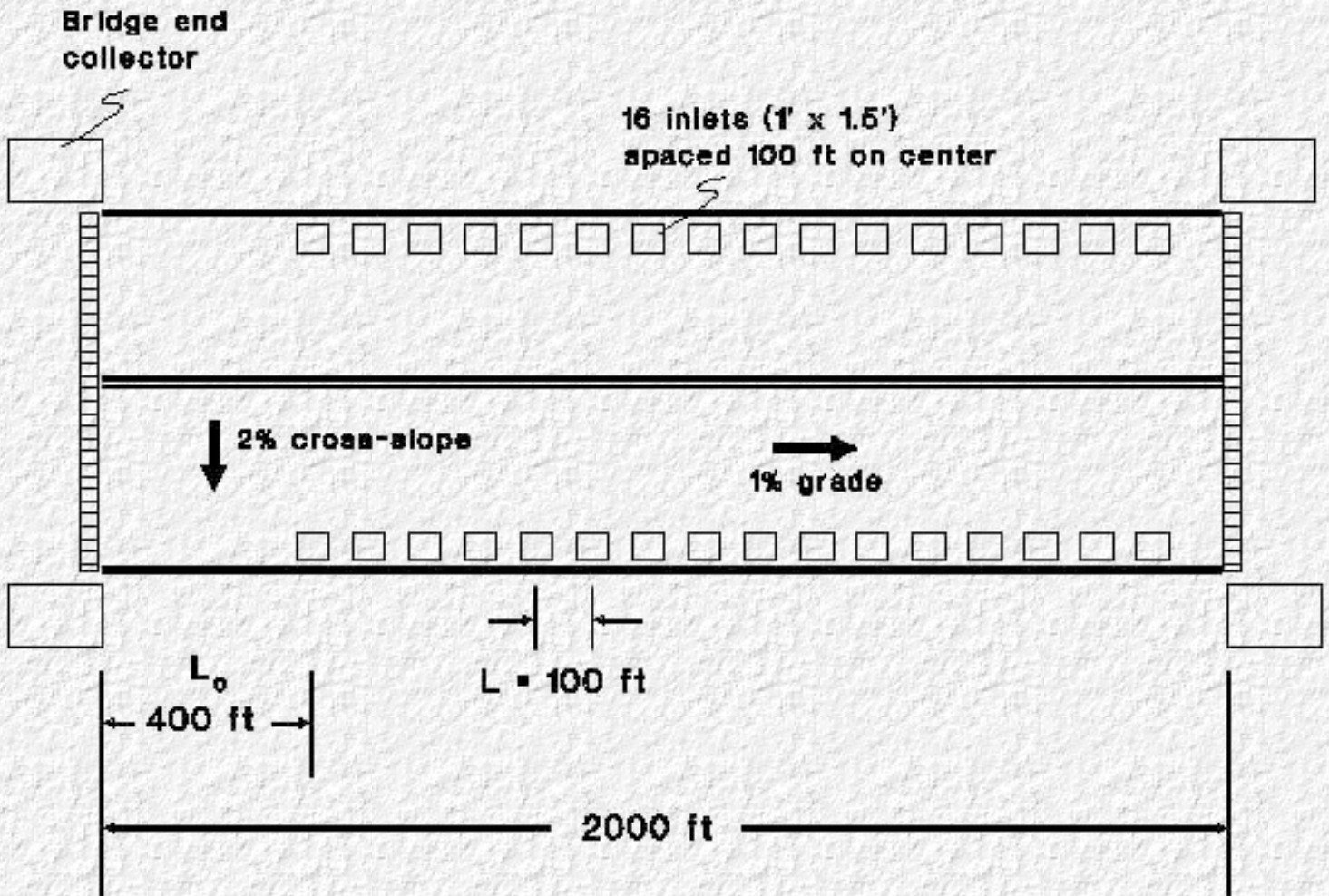

Figure 17. Inlet spacing for example 1.

Step 7. Design bridge end treatments. Two approaches to design flow, Q , estimation are provided here for guidance to designers. The approaches present calculations for 0 percent and 50 percent blockage of the inlets on the bridge.

- 0 percent blockage--assume all the inlets on the bridge are 100 percent functional; the flow at the bridge end will be the full gutter flow at 10 feet spread, $Q = 2.4$ ft³/s.
- 50 percent blockage--This represents a design approach for settings where debris is a factor. Accept half the runoff from the bridge deck; note that it is necessary to recalculate the time of concentration. The overland flow time is 0.98 minutes and is calculated in step 1(c), above.

For a first trial, assume $t_c = 10$ minutes ($i = 6.1$ in/hr) and the bridge end spread, $T = 12.5$ feet, then using [Equation \(3\)](#) or [Chart 3](#),

$$t_g = 484 \frac{(.02)(12.5)^2}{(.9)(6.1)(34)} = 8.10 \text{ min.}$$

$$t_c = 8.10 + .98 = 9.08 \text{ min.}$$

For a second trial, adjust the intensity and check the spread. [Figure 15](#) indicates the 10-year bridge end design intensity for a 9-minute duration to be 6.3 in/hr. This intensity will generate a design flow of

$$Q = (1)(0.9)(6.3) \frac{(2000)(34)}{43560} - (0.5)(0.245)(16)(2.4) = 4.15 \text{ ft}^3/\text{s},$$

where the first term represents [Equation \(1\)](#), and the second term represents a deduction representing 50 percent blockage of an unobstructed capture efficiency, E , of 24.5 percent for 16 gutters operating at a 10-foot spread. The deduction is slightly conservative because the inlet spread is not a constant 10 feet but varies as the bypass builds up. As a check, this flow of 4.15 ft³/s develops a spread of $T = 12.35$ feet using [Equation \(4\)](#) or [Chart 4](#), indicating a good first guess of 12.5 feet.

Using this approach, the design flow is estimated to be 4.15 ft³/s, and assumes all inlets are 50 percent clogged. At this flow, the bridge end spread is 12.35 feet.

The spread at the first inlet associated with the bridge end intensity of 6.3 in/hr, gives a full gutter flow of 2.07 ft³/s having a spread of 9.5 feet. Thus, the spread on the bridge at the inlets is between about 9.5 feet and 12.35 feet.

Commentary: Select a bridge end design flow using one or a variation of the above approaches. Approach "a," assuming 0 percent blockage, produces a design flow of 2.4 ft³/s. Approach "b," assuming 50 percent blockage, produces a design flow of 4.15 ft³/s. Select an inlet scheme for the selected design flow using [HEC-12](#) (Johnson and Chang, 1984) and provide a pipe or paved ditch to convey the design flow to the toe of the embankment. Provide energy dissipation, if necessary, at the toe to achieve nonerosive velocities. Use similar considerations to design upslope bridge end collectors.

Step 8. Compare design rainfall intensity with other criteria.

From [Table 2](#), the hydroplaning rainfall intensity for $S = 0.01$, $S_x = 0.02$, and $(W-T) = 24$ is 5.9 in/hr at 55 mi/h. At 55 mi/h, the threshold intensity for causing sight impairment is estimated as 4 mi/h ([See Chapter 8](#)). One could conclude that driver vision impairment will slow drivers down prior to a rainstorm generating sufficient intensity (5.9 in/hr) to cause hydroplaning. Flooding by excessive spread is avoided at these intensities (5.9 and 4 in/hr) and does not become a factor until the design intensity of 7.3 in/hr is reached.

10.3 Example 3--1,200 Foot, 3 Percent Grade Bridge

Given: This example has the same data as example 2 with a shorter bridge length of 1,200 feet and a steeper slope of 3 percent grade.

Find: Inlet spacing, L_o , L_c .

Solution: Use [Chart 1](#), [Chart 2](#), [Chart 3](#), [Chart 4](#), and [Chart 5](#) in [Appendix C](#) and IDF curve for Charlotte, North Carolina, shown in [Figure 15](#).

Note: The steps are the same as the steps in example 2.

- Step 1. $i = 7.3$ in/hr (same value and logic as example 2).
- Step 2. $Q_f = 4.1$ ft³/s.
- Step 3. $L_o = 800$ ft.
- Step 4. $E = 0.245$.
- Step 5. $L_c = 196$ ft.
- Step 6. Adapt the spacing to structural constraints. For example, if the bent spacing is 100 feet, use $L_o = 800$ feet and $L_c = 200$ feet. (The 196 theoretic value is judged close enough to 200 (2 percent lower) to accept 200 as the practical spacing.) Thus, the number of inlets per side $(1200-800)/200=2$.
- Step 7. Design bridge end treatments. Example 2 discusses procedures for bridge end collection of drainage. The high end gutters should be clear of flow prior to the bridge and the flow at the low end of the bridge should be removed with an inlet off the bridge.

The comparison of constant grade examples 1, 2, and 3 follows.

	Width	L_o Distance to first inlet	L_c Distance between inlets	Number of inlets
Example 1 500 ft 3% grade	18 ft	N/A	N/A	0
Example 2 2000 ft 1% grade	34 ft	400	100	16
Example 3 1200 ft 3% grade	34 ft	800	200	2

10.4 Example 4--4,000-Foot Long, 68-Foot-Wide Flat Bridge

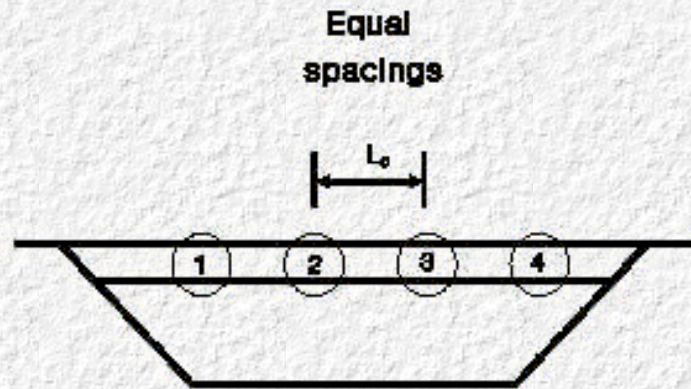

Figure 18. Horizontal bridge.

Given: 4,000-foot horizontal bridge as shown in [Figure 18](#).

$$W_p = 34 \text{ ft,}$$

$$n = 0.016,$$

$$C = 0.9,$$

$$S_x = 0.02,$$

$$T = 10 \text{ ft, and}$$

Frequency = 10-year return period.

Where: Pavement width, W_p , is the width of the bridge from the centerline crown to the gutter edge.

Find: Inlet spacing, L_c , and total inlet perimeter, P .

Solution: Use [Chart 11](#), [Chart 12](#), and [Chart 13](#) in [Appendix C](#) and IDF curve for Charlotte, North Carolina ([Figure 15](#)).

Step 1. Compute intensity for time of concentration of 5 minutes. From the 10-year IDF curve for Charlotte, N.C., the design intensity is 7.3 in/hr.

Step 2. Compute inlet spacing, L_c , using [Chart 12](#) or [Equation \(24\)](#).

$$L_c = \frac{1312}{[(0.016)(0.9)(7.3)(34)]^{0.67}} (0.02)^{1.44} (10)^{2.11} = 258 \text{ ft.}$$

Since $L < 4,000$ feet (the length of the bridge), inlets are needed.

Step 3. Compute total inlet perimeter using [Chart 13](#) or [Equation \(25\)](#).

$$P = \frac{[(0.9)(7.3)(34)]^{0.33} (10)^{0.61}}{102.5 (0.02)^{0.06} (0.016)^{0.67}} = 4.8 \text{ ft.}$$

Any inlet configuration may be used as long as the total inlet perimeter is at least 4.8 feet. If the square or rectangular grate is adjacent to the curb, then the sum of the other three sides should be 4.8 feet. Thus, $4.8/3 = 1.6$ feet = the minimum side of a square grate flush with the curb on one side--approximately 20 inches. A curb opening should be 4.8 feet, if this could be structurally integrated. Therefore, an inlet, such as a 5 foot horizontal scupper (three New Jersey Type slots side-by-side as shown in [Figure 7](#) for a total length of 6 ft) or a 1 foot-1 3/4 feet x 1 foot 5 inch grate (shown in [Figure 2](#)), should be placed every 258 feet. If round vertical openings are used, several openings would be needed every 258 feet with total perimeter of 4.8 feet.

Step 4. Adapt spacing to structural constraints.

If one adapts to a spacing of 250 feet (instead of 258 feet), then the total number of scuppers per side would be: $(4000/250) - 1 = 15$ (a bridge end collector will replace the scupper for the final 100 ft). See [Figure 19](#).

In addition, the spacing of scuppers should be adjusted according to the reinforcing schedule or other structural constraints.

Step 5. Design bridge end treatments.

Step 6. Compare design intensity with hydroplaning and driver vision criteria. For a design hydroplaning depth, d , of 0.0067 feet (0.08 inches) and vehicle speed of 55 mi/h, the design rainfall intensity using [Equation \(18\)](#) is:

$$i = \left[\frac{64904.4}{(0.9)(0.016)} \right] \left[\frac{0.02}{((0.02)^2 + 0)^{0.25}} \right] \left[\frac{(0.0067)^{1.67}}{(34 - 10)} \right] = 6.17 \text{ in/hr}$$

The threshold for driver vision impairment is estimated as 4 in/hr. The discussion contained in step 8, example 1, applies here as well.

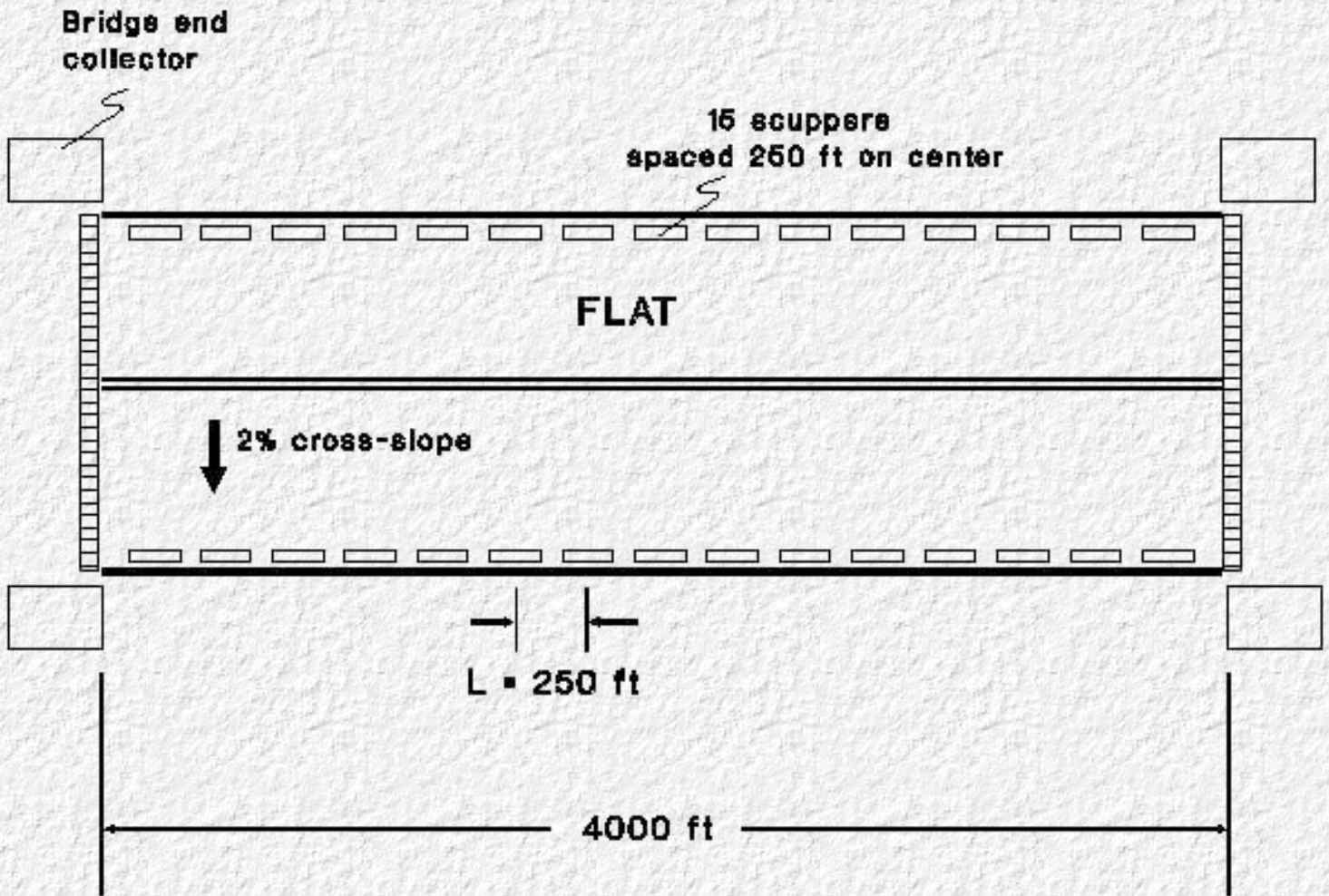

Figure 19. Scupper spacing for example 4.

10.5 Example 5--800-Foot-Long, 36-Foot-Wide Flat Bridge

Given: This example has the same data as example 4 with a shorter bridge length of 800 feet and a distance from crown to gutter, W_p , of 18 feet.

Find: Inlet spacing, L_c , and total inlet perimeter.

Solution: Use [Charts 11 through 13](#) in [Appendix C](#) and IDF curve for Charlotte, North Carolina ([Figure 15](#)).

Note: The steps are the same as the steps in example 4.

- Step 1. $i = 7.3$ in/hr (using 5 minute time of concentration).
- Step 2. Using [Chart 12](#) or [Equation \(23\)](#), inlet spacing, $L_c = 394$ ft.

- Step 3. Using [Chart 13](#) or [Equation \(24\)](#), inlet perimeter, $P = 3.9$ ft.
 - Step 4. Adapt spacing to structural constraints. If one adapts to a spacing of 400 feet, then only one scupper per side would be necessary. A bridge end collector will be placed at the bridge end to remove runoff from the remaining 400 feet of deck.
 - Step 5. Design bridge end treatments.
 - Step 6. Compare design intensity with hydroplaning and driver vision criteria. From [Equation \(18\)](#), $i = 18.66$ in/hr. The discussion contained in step 8, example 2, applies here as well.
-

EXAMPLES 4 and 5 - COMMENTARY

Bridges with vertical curves, having either sags or high points, are nearly flat at their low or high point stations. Bridges with grades less than about 0.3 percent are nearly flat. For nearly flat stations on vertical curve bridges or bridges with constant grades, the designer should check spacing assuming the bridge is flat. If the flat spacing is less than the spacing determined using a nearly flat grade, then the provision of the flat grade spacing is warranted.

⁴ Lesser grades would have higher flow times and lesser intensities and additional trials would be necessary as in example 1

[Go to Appendix A](#)



Appendix A : HEC 21

Vertical Curve Bridges

[Go to Appendix B](#)

The objective of this appendix is to facilitate inlet spacing design for the more complex case of bridges within vertical curves. Constant-slope and flat bridges are discussed in [Chapter 9](#) and [Chapter 10](#).

A.1 Vertical Curve Bridge Design Aids

This section summarizes the design aids used in the vertical curve inlet calculations.

1. **Intensity-Duration-Frequency Curve.** The designer needs such a curve applicable to the specific site. An example is provided in [Figure 16](#).

2. **Time of Overland Flow.** [Equation \(2\)](#)*,

$$t_o = \frac{k_w (l_o n)^{0.6}}{(C_i)^{0.4} S^{0.3}}, \quad (2)$$

or the nomograph in [Chart 2](#) is used.

3. **Time of Gutter Flow.** [Equation \(3\)](#)*,

$$t_g = 484 \frac{S_x T^2}{C_i W_p}, \quad (3)$$

or the nomograph in [Chart 3](#) is used.

4. **Gutter Flow at Given Spread, T.** [Equation \(4\)](#)*,

$$Q = \left(\frac{k_g}{n} \right) S_x^{1.67} S^{0.5} T^{2.67}, \quad (4)$$

or the nomograph in [Chart 4](#) is used.

5. **Inlet Spacing.** [Equation \(22a\)](#) and equation(22b)* are the equations for the spacing of an initial inlet and subsequent inlets on a vertical curve bridge, respectively. The efficiency, **E**, is replaced by the interception coefficient, **K**, for vertical-curve bridges:

$$L_o = \frac{43560 Q}{C_i W_p}, \text{ and} \quad (22a)$$

or the nomograph in [Chart 5](#) is used (with **E** redefined as **K**).

$$L_i = \frac{43560 Q}{C_i W_p} K, \quad (22b)$$

6. Interception Coefficient, K. This coefficient, as mentioned before, replaces inlet interception efficiency, **E**. This equation does not appear in the main body of the report but is derived in [Appendix B](#):

$$K = 1 - (1 - E) \left(\frac{S_u}{S} \right)^{0.5}. \quad (26)$$

The nomograph for [Equation \(26\)](#) is presented in [Chart 15](#).

7. Inlet Efficiency, E.

a) The frontal flow ratio, **E_o**, is computed with [Equation \(8\)](#)^{*},

$$E_o = 1 - \left(1 - \frac{W}{T} \right)^{2.67}, \quad (8)$$

or the nomograph in [Chart 7](#) is used.

b) The efficiency, **E**, is calculated as **E = R_f E_o**, where **R_f** is the frontal flow interception efficiency, which is 100 percent for low velocities on relatively flat grades (less than about 2 percent) but can be a factor on steep grades. [Chart 10](#) presents values of **R_f** for different grate lengths and gutter velocities. Gutter velocities are determined with [Equation \(5\)](#)^{*},

$$V = \frac{2kg}{n} S_u^{0.5} S_x^{0.67} T^{0.67}, \quad (5)$$

or the nomograph in [Chart 9](#) is used.

c) For circular scuppers, **E** is given by [Chart 6](#).

d) For side slot scuppers, as in New Jersey Type Barriers, [Figure 7](#) provides guidance on selection of **E**.

8. Slope, S. Slope as a function of distance from the left edge of the bridge (**X**) and the

slopes of the tangents (g_1, g_2) is another equation that does not appear in the text and is:

$$S = \frac{g_2 - g_1}{L_B} X + g_1, \quad (27)$$

where:

L_B = length of bridge, and

g_1, g_2 = slopes of the tangents of the vertical curve.

A.2 Development of Design Procedures

The logic diagram for vertical curve bridges is provided in [Chart 14](#). The methodology is similar to that outlined for constant-grade bridges except that a trial and error approach is incorporated into the inlet spacing computations to handle estimation of the grade at the next inlet.

The designer first selects a design frequency and design spread. General bridge dimensions, bridge end grades, roughness and runoff coefficients, and inlet specifications are assumed to be given. Using basic geometry, the designer computes the distance from the high point to each end of the bridge (L_{E1}, L_{E2}); this is illustrated in the following example.

Design intensity is determined for the first inlet from the location's IDF curves by iteratively selecting a trial time of concentration, computing overland and gutter times of concentration, and comparing trial and computed values.

Starting at the high point of the bridge, the designer works down the grade of the long end of the bridge. A trial distance to the first inlet, L_0 , is selected and the grade (S) at this distance is determined using [Equation \(27\)](#). Gutter flow, Q , for grade S is computed. The intensity and gutter flow are then used to compute the distance to the first inlet using [Equation \(22a\)](#).

If the computed distance, L_0 , does not match the trial value, then the computations are repeated until agreement is achieved. If the slope at the selected distance is less than 0.003, then the nomograph for flat bridges ([Chart 12](#)) should be used as a check. If the distance to the first inlet is greater than the distance to the end of the bridge, then bridge deck drainage facilities are unnecessary. Many bridges will fall into this category and will need no bridge deck drainage.

However, if inlets are needed, the design intensity computed for the first inlet is used throughout the remainder of the analysis. To compute the distance from the first inlet to its nearest downslope neighbor, a trial spacing value, of about half the first distance, is selected and grade, S , computed. Gutter flow is recomputed. The interception coefficient, K , is determined from the nomograph in [Chart 15](#) or from [Equation \(26\)](#). [Equation \(26\)](#), as it is applied, results in variable spacing between inlets.

Inlet spacing L_i is computed from [Equation \(22b\)](#) or [Chart 5](#) and compared with the trial value selected. If necessary, the computations are repeated until agreement is achieved. If the slope is sufficiently small, the segment is treated as flat.

A.3 Bridge Deck Drainage Vertical Curve Drainage Design Method

The design procedure for a vertical curve bridge is as follows:

1. Compute the lengths of the short and long ends of the bridge, L_{E1} and L_{E2} , respectively, by solving [Equation \(27\)](#) with $S = 0$ for x ; the solution provides the distance from the left edge to the high point (L_{E1}).
2. Determine the rainfall intensity based on the computed time of concentration to the first inlet.
 - a. Select trial time of concentration and determine rainfall intensity from the IDF curve.
 - b. Compute overland travel time, t_o , using [Equation \(2\)](#) or [Chart 2](#).
 - c. Compute gutter travel time, t_g , using [Equation \(3\)](#) or [Chart 3](#).
 - d. Compute time of concentration by summing the gutter and overland travel times.
3. Select a trial distance from the high point to the first inlet on the long end of bridge, L_o , and compute the local slope using [Equation \(27\)](#).
4. Compute gutter flow, Q , that corresponds to the design spread using [Equation \(4\)](#) or [Chart 4](#).
5. Compute the distance to the first inlet, L_o , letting K be 1 for the first inlet, and using [Equation \(22a\)](#) or [Chart 5](#) (substitute K for E and L_o for L_c on the nomograph).
6. Determine spacing to the next inlet on the long end of the bridge.
 - a. Select a trial L_1 .
 - b. Compute the local slope, S , using [Equation \(27\)](#).
 - c. Calculate the gutter flow, Q , using [Equation \(4\)](#) or [Chart 4](#).
 - d. Compute inlet efficiency, E , using [Chart 6](#) or [Chart 7](#), [Chart 9](#), and [Chart 10](#).
 - e. Compute the interception coefficient, K , (K is less than 1 for the inlets following the first) using [Equation \(26\)](#) or [Chart 15](#).
 - f. Compute inlet spacing, L_1 , using [Equation \(22b\)](#) or [Chart 5](#) (substitute K for E and L_1 for L_c on the nomograph), and compare to the trial L_1 in Step 6a. If the computed L_1 does not equal the trial L_1 value, repeat step 6.
7. Repeat step 6 for the next inlet. Inlet spacings are determined one at a time until the sum of the inlet spacings exceeds the length of the long side of the bridge. The short side spacings (starting from the high point and working down) will be the same as the those

determined for the long side (until, of course, the length of the short side is exceeded). That is to say, the spacing of the vertical curve deck inlets are symmetrical with respect to the high point of the bridge.

8. Adapt spacing of inlets to accommodate structural constraints.
9. Design bridge end treatments. See step 7, example 1, [Chapter 10](#).
10. Compare design rainfall intensity with hydroplaning and driver vision criteria.

Since the grades near the high point are low, relatively long spacings may be computed for the crown of the bridge arch. Subsequent spacings are shorter since downslope inlets must capture overflow from upslope inlets. Inlet spacings should be adjusted according to structural constraints, as necessary. Analysis ends after design of bridge end treatments.

A.4 Example Problem

Given: Bridge with vertical curve as shown in [Figure 20](#).

$$W_p = 34 \text{ feet,}$$

$$n = 0.016,$$

$$S_x = 0.02,$$

$$T = 10 \text{ feet,}$$

$$C = 0.9,$$

$$L_B = 2,000 \text{ feet,}$$

Frequency = 10-year return period,

$$g_1 = +0.01,$$

$$g_2 = -0.02, \text{ and}$$

$$d = 0.08 \text{ inch, hydroplaning depth.}$$

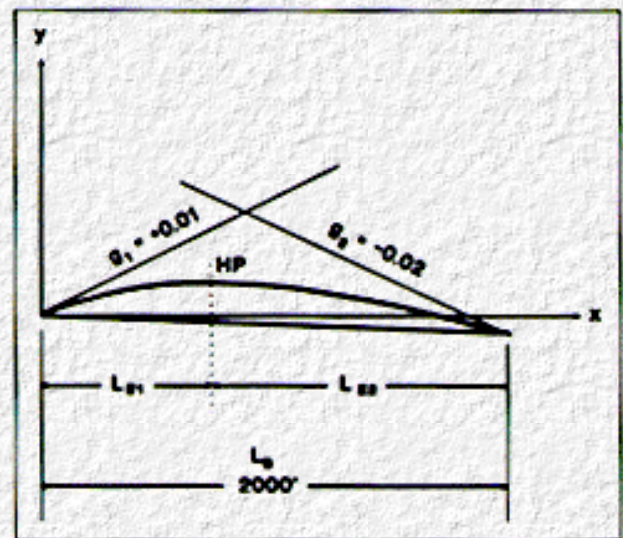

Figure 20. Vertical curve bridge.

Inlets will be 1 foot wide ($W = 1$), 1.5 feet long ($L_g = 1.5$), and will have bicycle-safe, curved vane grates.

Find: Inlet spacing, L_0 , L_1 , L_2 , L_3 , etc.

Solution: Use [Chart 15](#), as well as [Chart 2](#), [Chart 3](#), [Chart 4](#), and [Chart 5](#). Use 10-year IDF curve for Charlotte, North Carolina, shown in [Figure 16](#).

Step 1. Compute L_{E1} and L_{E2} , assuming a parabolic, vertical curve.

Locate high point, X_{HP} , using [Equation \(27\)](#), with $S = 0$.

$$X_{HP} = (-0.01) \frac{2000}{(-0.02 - 0.01)} = 667 \text{ ft.}$$

Thus, $L_{E1} = 667 \text{ ft}$ and $L_{E2} = 2000 - 667 = 1,333 \text{ ft}$.

Step 2. Compute intensity for time of concentration to first inlet. Use IDF curve (such as [Figure 15](#)).

a) Select trial time of concentration of 5 minutes. Using IDF curve for Charlotte, North Carolina (10-year storm), $i = 7.3 \text{ in/hr}$.

b) Compute t_o .

$$t_o = 0.93 \frac{[(34)(0.016)]^{0.6}}{[(0.9)(7.3)]^{0.4} (0.02)^{0.3}} = 0.98 \text{ min (chart 2)}.$$

c) Compute t_g .

$$t_g = 484 \frac{(0.02)(10)^2}{(0.9)(7.3)(3.4)} = 4.33 \text{ min (chart 3)}$$

d) Compute t_c .

$$t_c = 0.98 + 4.3 \text{ min} \approx 5 \text{ min (close enough)}.$$

Since trial value and computed value are approximately equal, use 7.3 in/hr as the design intensity.

Step 3. Select a trial value for the distance from the bridge high point to the first inlet (working down the long side of the bridge) and compute the local slope.

a) Select $L_0 = 300 \text{ ft}$ (1st trial).

$$X = 667 + 300 = 967 \text{ ft (distance from left end)}.$$

b) Use [Equation \(27\)](#) to determine S :

$$S = \frac{(-0.02 - 0.01)}{2000} 967 + 0.01 = -0.0045 \text{ (use } |S| = 0.0045 \text{)}.$$

Step 4. Compute full gutter flow, Q_f , at design spread (10 ft).

$$Q_f = \frac{0.56}{0.016} (0.02)^{1.67} (0.0045)^{0.5} (10)^{2.67} = 1.6 \text{ ft}^3/\text{s (chart 4)}.$$

Step 5. Compute distance to first inlet, L_0 , ($K = 1$ for first inlet).

$$L_0 = \frac{(43560)(1.6)}{(0.9)(7.3)(34)} = 312 \text{ ft (chart 5).}$$

Use $L_0 = 300$ ft. Inlets are needed since L_0 is less than the length of the long side of the bridge.

Step 6. Determine spacing to next inlet.

a) Select $L_1 = 50$ ft (1st trial).

$$X = 667 + 300 + 50 = 1017 \text{ ft (distance from left end).}$$

b) Use [Equation \(27\)](#) to determine S :

$$S = \frac{(-0.02 - 0.01)}{2000} 1017 + 0.01 = -0.0053 \text{ (use } |S| = 0.0053).$$

Note: $S_u =$ prior $S = 0.0045$ (slope at immediately upstream inlet).

c) Compute full gutter flow, Q_f :

$$Q_f = \frac{0.56}{0.016} (0.02)^{1.67} (0.0053)^{0.5} (10)^{2.67} = 1.73 \text{ ft}^3/\text{s (chart 4).}$$

d) Compute inlet efficiency, E .

$$E_o = 1 - \left(1 - \frac{1}{10}\right)^{2.67} = 0.245 \text{ (chart 7)}$$

$$V = \frac{1.12}{0.016} (0.02)^{0.67} (0.0053)^{0.5} (10)^{0.67} = 1.73 \text{ ft/s (chart 9)}$$

$$R_f = 1.0 \text{ (using chart 10)}$$

$$E = E_o R_f = 0.245 (1.0) = 0.245$$

(Note: From [Chart 10](#), splashover does not occur until a gutter velocity of 4.9 ft/sec is reached, corresponding to a slope of 4.4 percent. Thus, R_f will always equal 1.0 and E will always equal 0.245 for the remainder of this example. For steep slopes, E can change from inlet to inlet.)

e) Compute interception coefficient, K (K does not equal 1 for the second inlet):

$$K = 1 - (1 - 0.245) \left(\frac{0.0045}{0.0053}\right)^{0.5} = 0.30 \text{ (chart 15).}$$

f) Compute inlet spacing, L_1 .

$$L_1 = \frac{(43560)(1.73)}{(0.9)(7.3)(34)} (0.30) = 101 \text{ ft (not equal to 50 ft).}$$

Repeat Step 6. Since computed value for L_1 does not equal trial value, select a new trial value for L_1 and repeat Step 6.

a) Select $L_1 = 150$ ft (2nd trial).

$$X = 667 + 300 + 150 = 1117 \text{ ft.}$$

b) Use [Equation \(27\)](#) to redetermine S .

$$S = \frac{(-0.02 - 0.01)}{2000} 1117 + 0.01 = -0.0068 \text{ (use } |S| = 0.0068 \text{)}.$$

Note: S_u still = 0.0045.

c) Recompute Q .

$$Q = \frac{0.56}{0.016} (0.02)^{1.67} (0.0068)^{0.5} (10)^{2.67} = 1.96 \text{ ft}^3/\text{s} \text{ (chart 4)}.$$

d) Recompute inlet efficiency, E .

$E = 0.245$ (no change, as noted).

e) Recompute interception coefficient, K_1 .

$$K = 1 - (1 - 0.245) \left(\frac{0.0045}{0.0068} \right)^{0.5} = 0.39 \text{ (chart 15)}.$$

f) Recompute inlet spacing, L_1 .

$$L_1 = \frac{(43560)(1.96)}{(0.9)(7.3)(34)} (0.39) = 149 \text{ ft (close enough to 150 ft)}.$$

Step 7. Determine spacing to next and subsequent inlets.

a) Select $L_2 = 150$ ft (1st trial).

$X = 1267$ ft.

b) $S = 0.009$.

c) $Q = 2.26$.

d) $E = 0.245$ (no change, as noted).

e) $K_1 = 0.34$.

f) $L_2 = 150$ (OK).

L_i	Inlet Spacing From HP		Slope S	Gutter Flow, Q (ft ³ /s)
	Long Side	Short Side		
L_0	300	300	0.0045	1.73
L_1	150	150	0.0068	1.96
L_2	150	150	0.0090	2.26
L_3	165	N/A	0.0115	2.55

L ₄	175	N/A	0.0141	2.83
L ₅	185	N/A	0.0169	3.09
L ₆	195	N/A	0.0198	3.35

Step 8. Adapt spacings to accommodate structural constraints.

For the sake of uniformity, spacings L₁ through L₆ can be rounded to 150 feet. The resulting arrangement is illustrated in [Figure 21](#).

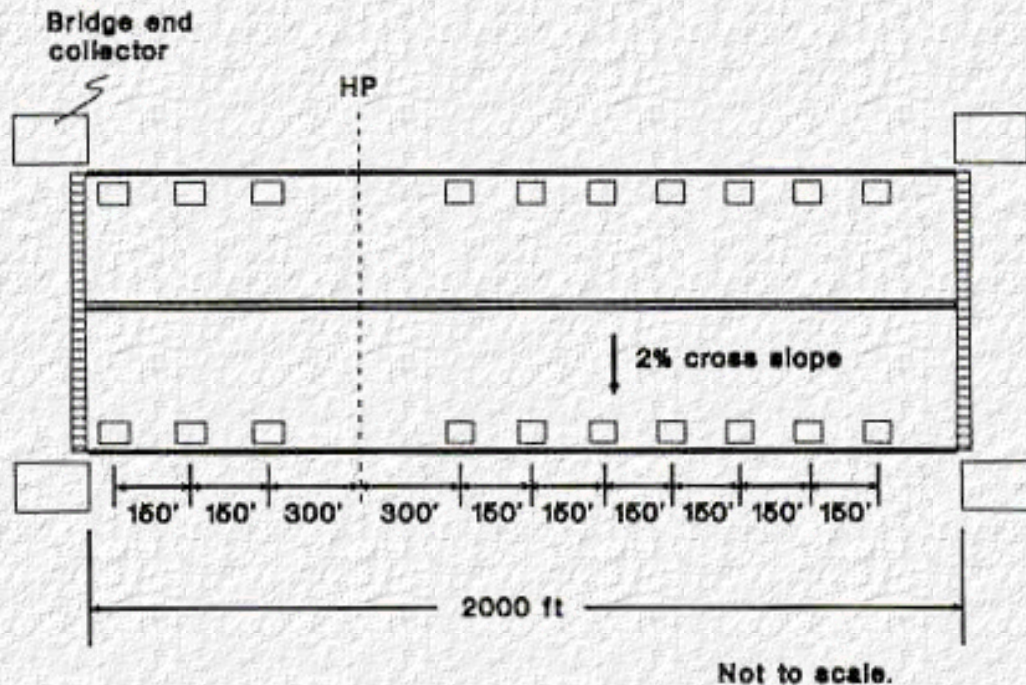

Figure 21. Inlet spacing for vertical curve bridge example.

Step 9. Design bridge end treatments

The flow in the gutters at each end of the bridge will not exceed the design spread of T = 10 feet with the provided inlets. The full gutter flow at each end using the slope at the bridge end stations is used to size the bridge end drains. The slope at the short end is S = 0.009 and the full gutter flow is:

$$Q = \frac{0.56}{0.016} (0.02)^{1.67} (0.009)^{0.5} (10)^{2.67} = 2.26 \text{ ft}^3/\text{s}.$$

The slope at the long end is S = 0.0198 and the full gutter flow is:

$$Q = \frac{0.56}{0.016} (0.02)^{1.67} (0.0198)^{0.5} (10)^{2.67} = 3.35 \text{ ft}^3/\text{s}.$$

The off-bridge end collectors should be sized to handle 2.26 ft³/s on the short end and 3.35 ft³/s on the long end. This procedure uses no blockage on the bridge as a basis. For 50 percent blockage, the previous example 2 (see [Section 10.2](#)) indicates the bridge end flows

will be about twice as large.

Step 10. Compare design rainfall intensity with hydroplaning and driver vision criteria. Using [Equation \(19\)](#), a different design rainfall intensity must be computed for each inlet because of the varying longitudinal gutter slope, **S**, of a vertical curve bridge. For a hydroplaning sheet flow depth, $d = 0.08$ inches, the first inlet would have a design rainfall intensity, i :

$$i = \left[\frac{64904.4}{(0.9)(0.016)} \right] \left[\frac{0.02}{\left[(0.02)^2 + (0.0045)^2 \right]^{0.25}} \right] \left[\frac{(0.08/12)^{1.67}}{(34 - 10)} \right]$$

$$i = 6.09 \text{ in/hr .}$$

Similarly, the design rainfall intensities for all the vertical curve bridge segments (for vehicle speed, $V = 55$ mi/h and hydroplaning sheet flow depth, $d = 0.08$ inches) are as follows:

Inlet No.	Slope, S	Design rainfall intensity, i (in/hr)
0	0.0045	6.09
1	0.0068	6.00
2	0.0090	5.89
3	0.0115	5.74
4	0.0141	5.58
5	0.0169	5.39
6	0.0198	5.20

As mentioned previously, the threshold intensity for causing sight impairment is estimated as 4 in/hr, for a vehicle speed, $V = 55$ mi/h ([See Chapter 8](#)).

**See main body of manual for variable definitions.*

[Go to Appendix B](#)



Appendix B : HEC 21

Derivation of Equations

[Go to Appendix C](#)

This Appendix derives the new technology developed for HEC 21 and provides commentary.

B.1 Gutter Flow Time of Concentration (t_g)

$$t_g = 484 \frac{S_x T^2}{C_i W_p} \text{ (chart 3)} \quad (3)$$

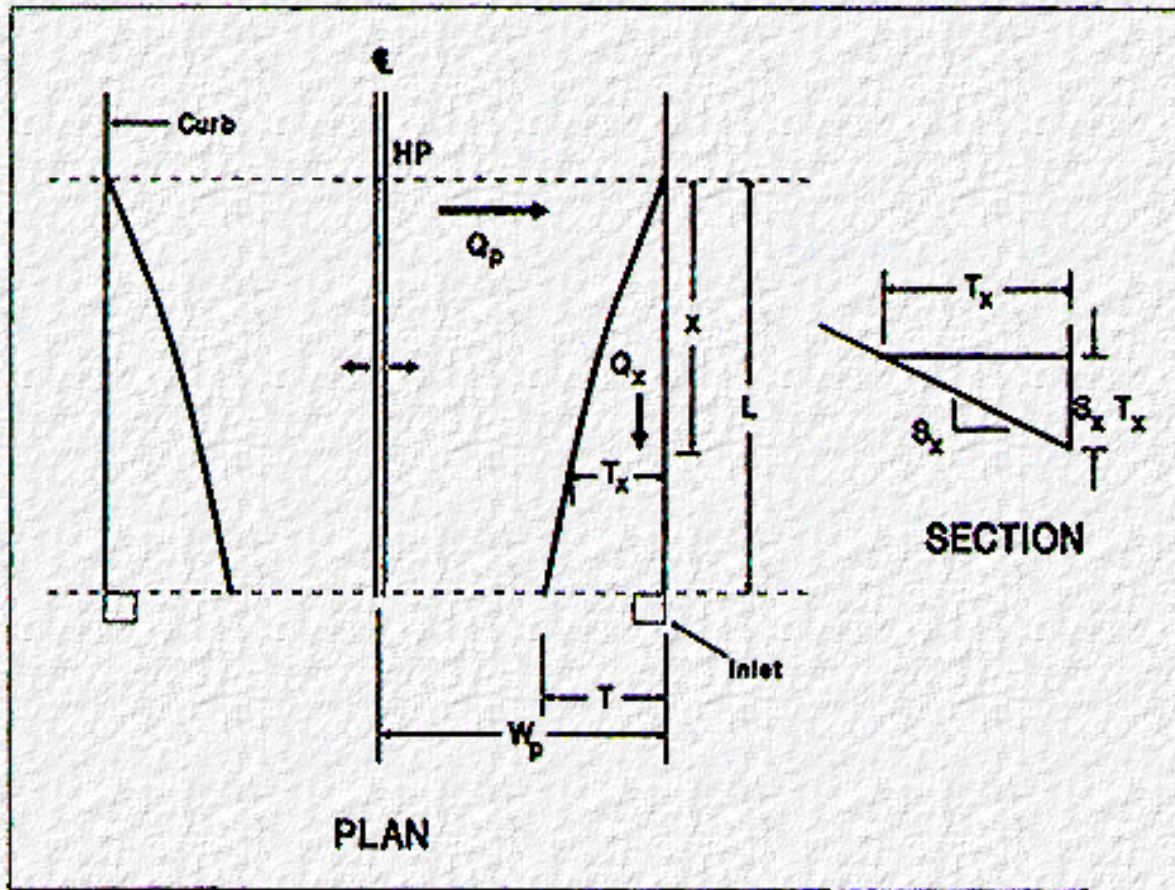

Figure 22. Bridge deck gutter flow relationships.

[Equation \(3\)](#) can be derived using the following steps:

- 1) Determine Q_x , gutter flow at a given point x as a function of Q_p , the flow running off the pavement between the high point and the inlet.
- 2) Determine V_x , gutter velocity at point x , using:

a) continuity to relate velocity to Q_x , and

b) the derivative of distance x with respect to time (the definition of velocity).

3) Integrate the velocity relationship to obtain the total gutter time of travel, t_g , to the first inlet.

Step 1. Determine gutter flow, Q_x .

Using the Rational Method of [Equation \(1\)](#):

$$Q_p = C i A, \quad (28)$$

where:

$$A = \frac{W_p x}{43,560}. \quad (29)$$

Thus, since $Q_p = Q_x$,

$$Q_x = C i \frac{W_p x}{43,560}. \quad (30)$$

Step 2. Determine gutter velocity, V_x .

a) From continuity, V_x can be written as:

$$V_x = \frac{Q_x}{A_x} \quad (31)$$

where: A_x = cross-sectional area of the gutter,

$$= 0.5 S_x T_x^2.$$

Thus,

$$V_x = \frac{2 Q_x}{S_x T_x^2}. \quad (32)$$

Using [Equation \(4\)](#), Q_x can also be written:

$$Q_x = \frac{0.56}{n} S_x^{1.67} S^{0.5} T_x^{2.67}. \quad (33)$$

Rearranging [Equation \(33\)](#), T_x^2 can be written:

$$T_x^2 = \left[Q_x \frac{n}{0.56 S_x^{1.67} S^{0.5}} \right]^{\frac{2}{2.67}} \quad (34)$$

Substituting into [Equation \(32\)](#) yields:

$$V_x = \frac{2 Q_x}{S_x} \left[Q_x \frac{n}{0.56 S_x^{1.67} S^{0.5}} \right]^{\frac{-2}{2.67}},$$

or by collecting terms

$$V_x = 2 Q_x^{0.25} S_x^{0.25} \left(\frac{0.56}{n} \right)^{0.75} S^{0.375} \quad (35)$$

b) From the definition of velocity, V_x can also be written as:

$$V_x = \frac{dx}{dt} \quad (36)$$

Step 3. Integrate [Equation \(36\)](#) to obtain the total gutter flow time.

a) By substituting [Equation \(35\)](#) into (36), dt can be expressed as:

$$dt = \frac{dx}{V_x} = \frac{1}{2} \left(\frac{n}{0.56} \right)^{0.75} \frac{dx}{S_x^{0.25} S^{0.375} Q_x^{0.25}} \quad (37)$$

Let:

$$M = \frac{1}{2} \left(\frac{n}{0.56} \right)^{0.75} \frac{1}{S_x^{0.25} S^{0.375}}, \quad (38)$$

and:

$$m = \frac{C_i W_p}{43,560} \quad (39)$$

From [Equation \(38\)](#) and [Equation \(39\)](#), it follows that:

$$Q_x = m x, \text{ and} \quad (40)$$

$$dt = M \frac{dx}{Q_x^{0.25}} \quad (41)$$

Note that

$$dQ_x = m dx, \quad (42)$$

and substitute into [Equation \(41\)](#) to get

$$dt = M \frac{dQ_x}{m Q_x^{0.25}} \quad (43)$$

Step 4. The integral equation to obtain total gutter flow time, t_g , is:

$$t_g \int_0^{Q_2} dt = \frac{M}{m} \int_0^{Q_2} \frac{dQ_x}{Q_x^{0.25}} \quad (44)$$

Integrating [Equation \(44\)](#) yields:

$$t_g = \frac{M}{m} \frac{Q_x^{0.75}}{0.75} \Big|_0^{Q_L} = \frac{M}{m} \frac{(mL)^{0.75}}{0.75}, \quad (45)$$

or collecting terms,

$$t_g = \frac{ML^{0.75}}{0.75 m^{0.25}} \quad (46)$$

Substitute for M and m using [Equation \(38\)](#) and [Equation \(39\)](#) and rearranging [Equation \(46\)](#) gives

$$t_g = \frac{1}{2} \left(\frac{1}{0.75} \right) \left(\frac{1}{0.56} \right)^{0.75} (43560)^{0.25} \frac{(nL)^{0.75}}{S_x^{0.25} S^{0.375} (Ci W_p)^{0.25}} \cdot (47)$$

Recall [Equation \(22a\)](#) and [Equation \(4\)](#),

$$L = \frac{43560 Q}{Ci W_p}, \text{ and} \quad (22a)$$

$$Q = \frac{0.56}{n} S_x^{1.67} S^{0.5} T^{2.67}. \quad (4)$$

Substitute [Equation \(4\)](#) into [Equation \(22a\)](#) and then substitute into [Equation \(47\)](#) to yield the following relationship:

$$t_g = \frac{1}{2} \left(\frac{1}{0.75} \right) (43560) \frac{S_x T^2}{Ci W_p}, \text{ or} \quad (48)$$

$$t_g = 29040 \frac{S_x T^2}{Ci W_p} \text{ (seconds).}$$

Converting t_g to minutes:

$$t_g = 484 \frac{S_x T^2}{Ci W_p}, \text{ Q.E.D.}^5 \quad (49)$$

[Equation \(44\)](#) assumes no spillover and represents the time of concentration to the first inlet. The above derivation assumes that the longitudinal slope is constant. For vertical curve bridges, this assumption is approximately true for the time of concentration to the first inlet, t_g . It is interesting to note that the gutter flow time does not explicitly consider the length or slope of the gutter.

B.2 Inlet Spacing

$$\text{Derive : } L_c = \frac{43560 QK}{CiW_p} \quad (\text{chart 5})$$

$$\text{where : } K = 1 - (1 - E) \left(\frac{S_u}{S} \right)^{0.5} \quad (\text{chart 15}), \quad (26)$$

S_u = slope at next-to-last upstream inlet,

S = local slope at current (that is, last) inlet.

Inlet spacing for design spread, T , is equal to the gutter length, L_c .

Step 1. Determine gutter flow, Q , at $x = L$.

(a) At $x = L$, $Q_x = Q$.

$$Q_L = \frac{CiW_p L}{43560} + (1 - E) \frac{0.56}{n} S_x^{1.67} S_u^{0.5} T^{2.67}, \quad (50)$$

where the first term is pavement runoff between the upper and lower inlets, the second term is the bypass flow from the upper inlet, and E is the interception efficiency ($0 < E \leq 1$).

(b) Rearranging [Equation \(50\)](#):

$$\frac{CiW_p L}{43560} = Q - \left[(1 - E) \frac{0.56}{n} S_x^{1.67} S_u^{0.5} T^{2.67} \right], \text{ or} \quad (51)$$

$$\frac{CiW_p L}{43560} = Q - \left[\frac{0.56}{n} S_x^{1.67} S^{0.5} T^{2.67} \right] (1 - E) \frac{1}{S^{0.5}} S_u^{0.5}.$$

(c) From [Equation \(4\)](#):

$$Q = \frac{0.56}{n} S_x^{1.67} S^{0.5} T^{2.67} \quad (4)$$

Substituting into [Equation \(51\)](#):

$$\frac{CiW_p L}{43560} = Q - Q(1-E) \left(\frac{S_u}{S} \right)^{0.5}, \text{ or}$$

$$\frac{CiW_p L}{43560} = Q \left[1 - (1-E) \left(\frac{S_u}{S} \right)^{0.5} \right]. \quad (52)$$

Step 2. Solve [Equation \(52\)](#) for L.

$$L_c = \frac{43560Q}{CiW_p} \left(1 - (1-E) \left(\frac{S_u}{S} \right)^{0.5} \right). \quad (53)$$

$$\text{Let } K = 1 - (1-E) \left(\frac{S_u}{S} \right)^{0.5}, \quad (54)$$

and [Equation \(54\)](#) is the relationship presented in [Chart 15](#).

$$\text{Thus, } L_c = L_i = \frac{43560 Q}{CiW_p} K, \text{ Q.E.D.,} \quad (22b)$$

where: S is the local slope at the ith inlet, and S_u is the local slope at the i-1 inlet; if $S = S_u$, then $L_i = L_c$.

Commentary: For [Equation \(26\)](#), when $E = 1$, (the first inlet or a 100 percent efficient inlet):

$$K = 1 - (1 - 1) \left(\frac{S_u}{S} \right)^{0.5}, \text{ and}$$

$$K = 1.$$

and, when $S_u = S$ (constant-sloped bridges),

The nomograph, presented in [Chart 5](#), depicts the solution to [Equation \(22b\)](#), with L_i labeled as L_c , to accommodate the most frequent use of this chart--for constant sloped bridges. Annotations on [Chart 5](#) are provided to extend its utility to the vertical curve case in conjunction with [Chart 15](#).

B.3 Inlet Spacing for a Horizontal Bridge

$$\text{Derive : } L_c = \frac{1312}{(nC_iW_p)^{0.67}} S_x^{1.44} T^{2.11} (\text{chart 12}). \quad (24)$$

Flow on a flat bridge is illustrated in [Figure 23](#) and [Figure 24](#). In deriving [Equation \(24\)](#), it is assumed that velocities are low. Steps in deriving [Equation \(24\)](#) include:

- 1) Define gutter flow, Q_x , using:
 - a) Manning's gutter flow equation, and
 - b) Rational Method
- 2) Combine the two flow equations and integrate the Manning's portion over water depth and the Rational portion over longitudinal distance.
- 3) Make simplifying assumptions concerning critical depth, and solve the result of Step 2 for L_c .

$$Q_x = \frac{0.56}{n} S_x^{1.67} S^{0.5} \left(\frac{y}{S_x} \right)^{2.67}, \text{ or} \quad (57)$$

$$Q_x = \frac{0.56}{n S_x} S^{0.5} y^{2.67}$$

b) From the Rational Method ([Equation \(1\)](#)):

$$Q_x = \frac{CiWp^x}{43560} \text{ (ft}^3/\text{s)}. \quad (58)$$

Step 2. Equate [Equation \(57\)](#) and [Equation \(58\)](#) and integrate.

a) Combining,

$$\frac{CiWp^x}{43560} = \frac{0.56}{n S_x} S^{0.5} y^{2.67}. \quad (59)$$

b) Since the longitudinal slope is zero, the friction slope is taken to be the slope of the water surface,

$$S = \frac{-dy}{dx}. \quad (60)$$

Thus,⁶

$$\frac{CiWp^x}{43560} = \frac{0.56}{n S_x} y^{2.67} \left(\frac{-dy}{dx} \right)^{0.5}. \quad (61)$$

c) Let:

$$A = \frac{0.56}{n S_x}, \text{ and} \quad (62)$$

$$B = \frac{CiWp^x}{43560}, \quad (63)$$

then, it follows that

$$Bx = Ay^{2.67} \left(\frac{-dy}{dx} \right)^{0.5} \quad (64)$$

Squaring both sides of [Equation \(64\)](#):

$$B^2 x^2 = A^2 y^{5.33} \left(\frac{-dy}{dx} \right) \quad (65)$$

d) Integrate [Equation \(65\)](#).

$$B^2 \int_0^{\frac{L}{2}} x^2 dx = -A^2 \int_h^{h_c} y^{5.33} dy, \quad (66)$$

where: h = water depth at curb for the design water spread, T ($x = 0$); and, h_c = water depth at inlet, usually a critical depth, ($x = L/2$), to yield,

$$B^2 \frac{x^3}{3} \Big|_0^{\frac{L}{2}} = -A^2 \frac{y^{6.33}}{6.33} \Big|_h^{h_c}, \text{ or}$$

$$\frac{L}{2} = \left(\frac{3}{6.33} \frac{A^2}{B^2} \right)^{1/3} \left(h^{6.33} - h_c^{6.33} \right)^{1/3} \quad (67)$$

e) Substituting A and B back into [Equation \(67\)](#):

$$\frac{L}{2} = \left(\frac{3}{6.33} \right)^{1/3} \left(\frac{\left(\frac{0.56}{n S_x} \right)^2}{\left(\frac{CiW_p}{43560} \right)} \right)^{2/3} (h^{6.33} - h_c^{6.33})^{1/3}, \text{ or}$$

$$\frac{L}{2} = \frac{656}{(n S_x CiW_p)^{2/3}} (h^{6.33} - h_c^{6.33})^{1/3}. \quad (68)$$

f) If h_c is less than $h/2$, then with 1% error,

$$h^{6.33} - h_c^{6.33} \approx h^{6.33}. \quad (69)$$

Using the [Equation \(69\)](#) simplification,

$$\frac{L}{2} = \frac{656}{(n S_x CiW_p)^{0.67}} h^{2.11}. \quad (70)$$

g) From [Equation \(56\)](#), at $x = 0$, $y = h = TS_x$.

h) Substituting $h = TS_x$ into [Equation \(70\)](#) gives

$$\frac{L}{2} = \frac{656}{(n S_x CiW_p)^{0.67}} (T S_x)^{2.11}, \text{ or}$$

$$\frac{L}{2} = \frac{656 S_x^{1.44} T^{2.11}}{(n CiW_p)^{0.67}}, \text{ or}$$

$$L_c = \frac{1312 S_x^{1.44} T^{2.11}}{(n CiW_p)^{0.67}}, \text{ Q.E.D.}$$

(24)

Commentary: The flat bridge case has no precedent in past design practice. However, it is present in long causeways and bridges are nearly flat at high or low point stations within vertical curves. If the tangent slopes are relatively mild, the nearly flat deck can be significant. This appendix and [Chart 11](#) provides rational inlet spacing methods for what is thought to be a situation that does exist with some, but not very high, regularity. A one-dimensional analysis in the direction of flow, used herein, has simplified the two-dimensional flow net.

At the selected spacing, L_c , the flow that the scuppers or inlets must remove is equal to

$$\frac{C_i W_p L_c}{43560} ,$$

where i is selected for 5 minute duration using the design return period. Assuming critical depth around the perimeter of inlets flowing as weirs, generates the perimeter selection method depicted in [Chart 13](#).

B.4 Inlet Perimeter for a Horizontal Bridge

$$\text{Derive : } P = \frac{(C_i W_p)^{0.33} T^{0.61}}{102.5 S_x^{0.06} n^{0.67}} \text{ (Chart 13) , (71)}$$

where P = the required perimeter length at every spacing station where inlets are needed.

Let d_c be the critical depth at the inlet lip, which is assumed to function as a weir. Then

$$A = d_c P , \quad (72)$$

where, A is the flow area normal to the weir lip. Also, the critical depth at the edge of curb is 2/3 of the depth of spread, or

$$d_c = \frac{2}{3} S_x T . \quad (73)$$

Equating [Equation \(72\)](#) and [Equation \(73\)](#) gives

$$A = \frac{2}{3} S_x T P . \quad (74)$$

Noting that,

$$v^2 = 2gh \text{ and } h = \frac{1}{3} S_x T$$

and substituting gives

$$v = \sqrt{\frac{2g}{3} S_x T}. \quad (75)$$

The total flow to the inlet is

$$Q = \frac{C_i W_p}{43560} L_c. \quad (22a)$$

Setting [Equation \(22a\)](#) equal to $Q = Av$ defined by [Equation \(74\)](#) and [Equation \(75\)](#) gives

$$\frac{C_i W_p L_c}{43560} = \left(\frac{2}{3} S_x T P \right) \left(\sqrt{\frac{2g}{3} S_x T} \right). \quad (76)$$

Solving [Equation \(76\)](#) for perimeter length

$$P = \frac{C_i W_p L_c}{(S_x T)^{1.5}} \frac{1}{(43560)(3.0874)}, \text{ and} \quad (77)$$

substituting [Equation \(24\)](#),

$$L_c = \frac{1312}{(n C_i W_p)^{0.67}} S_x^{1.44} T^{2.11}, \text{ gives}$$

$$P = \frac{(C_i W_p)^{0.33} T^{0.61}}{102.5 S_x^{0.06} n^{0.67}}, \text{ Q.E.D.} \quad (24)$$

⁶In subsequent manipulations, square both sides of [Equation \(61\)](#) to eliminate square root.



Appendix C : HEC 21

Design Charts - Bridge Drainage

[Go to Appendix D](#)

The designer will need these charts, specific information about the bridge, and an IDF curve. The IDF curve can be obtained from HYDRO in the HYDRAIN software using the latitude and longitude coordinates of the site.

CHART NUMBER

- [1. Logic for computing inlet spacing for a constant-grade bridge.](#)
 - [2. Overland time of concentration \(\$T_o\$ \).](#)
 - [3. Gutter time of concentration \(\$T_g\$ \).](#)
 - [4. Flow in triangular gutter section \(\$T\$, \$Q_f\$ \).](#)
 - [5. Inlet spacing \(\$L_o\$, \$L_c\$ \) or \(\$L_0\$, \$L_1\$, \$L_2\$...\).](#)
 - [6. Efficiency curves for circular scuppers \(\$E\$ \).](#)
 - [7. Frontal flow ratio for rectangular inlets.](#)
 - [8. Typical grates.](#)
 - [9. Velocity in triangular gutter sections \(\$T\$, \$V\$ \).](#)
 - [10. Frontal flow interception efficiency for typical grates \(\$E\$ \).](#)
 - [11. Logic for computing inlet spacing for a flat bridge.](#)
 - [12. Inlet spacing for a flat bridge.](#)
 - [13. Inlet perimeter and width for a flat bridge.](#)
 - [14. Logic diagram for vertical curve bridges.](#)
 - [15. \$K\$ for vertical curve bridges.](#)
-

[Go to Appendix D](#)



Appendix D : HEC 21

Selected Glossary

[Go to Table of Contents](#)

Breakdown Lanes	Lanes on a bridge that correspond to shoulders and that are used to temporarily locate disabled vehicles; normally 8- to 10-feet wide. These lanes serve a dual purpose as gutters to convey drainage.
Bypass Flow	Flow that bypasses an inlet on grade and is carried in the gutter to the next inlet downgrade.
Cleanout Plug	A removable plug in the piping system that gives access to a run of piping for cleaning. It is typically located near bends and Y-shaped intersections.
Drain	A receptacle that receives and conveys water.
Drainage System	The entire arrangement of gutters, ditches, grates, inlet boxes, pipes, outfalls, and energy dissipators necessary to collect water and get it to a disposal point.
Drop Inlet	A drain that is used away from a bridge or at bridge ends. It is usually larger than an inlet chamber and is set in earth in the subgrade or shoulder of an approach embankment.
Flanking Inlets	Inlets placed upstream and on either side of an inlet at the low point in a sag vertical curve. The purposes of these inlets are to intercept debris as the slope decreases and to act in relief of the inlet at the low point.
Frequency	The probability that an annual flood can be expected to occur on the average over a long period of years. The reciprocal of this frequency is the return period. For example, a flood of frequency 0.1 or 10 percent has a return period of $1/0.1 = 10$ years.
Frontal Flow	The portion of flow that passes over the upstream side of a grate.
Grate	The ribbed or perforated cover of an inlet chamber that admits water and supports traffic loads; current practice is to make grates that are safe for cyclists.

Gutter	That portion of the edge of the bridge deck that is utilized to convey storm runoff water next to the curb. It may include a portion of all of a traveled lane, shoulder or parking lane, and a limited width adjacent to the curb may be of different materials and have a different cross slope.
Hydroplaning	The separation of the automobile tire from the road surface by a layer of fluid.
Inlet Chamber	A typically cast-iron, welded steel, or formed concrete compartment that is beneath an inlet. It is usually set into the bridge deck, but is sometimes only an open hole in the deck.
Inlet Efficiency (E)	The ratio of flow intercepted by an inlet to total flow in the gutter.
Outlet Pipe	The pipe that leads the water away from an inlet chamber or drop inlet.
Rainfall Intensity	The average rate of rainfall for a selected time interval measured in inches per hour.
Runoff (Q)	Any liquid that can run off the roadway surface. Although the liquid is generally water, it includes any other liquids and dissolved solids that can make their way into the drainage system.
Scupper	A small opening (usually vertical) in the deck, curb, or barrier through which water can flow. The term is nautical and by analogy relates bridge deck drains to openings in the sides of ships at deck level to allow water to run out.
Splash-Over	Portion of the frontal flow at a grate that skips or splashes over the grate and is not intercepted.
Spread (T)	The top width of the water flowing in the gutter. This measures the distance the runoff water encroaches into the breakdown lane. If the spread is wider than the breakdown lane, it encroaches into travel lanes.
Storm Drain	An underground piping system that may connect to a municipal storm water management system or may be a separate disposal system for highway and bridge drainage.
Time of Concentration (t_c)	The time it takes for water to travel from the most remote point in the surface drainage to the inlet. Typically, the travel path is from the high point on the bridge deck to the first inlet and includes sheet flow path to the gutter and then the gutter flow path.

Travel Lane

Portion of the traveled way for the movement of a single lane of vehicles, normally 12 feet.

Note: Also see definition of variables located prior to [Chapter 1](#).

[Go to Table of Contents](#)



Chapter 1 : HEC 21

Introduction

[Go to Chapter 2](#)

The objective of this manual is to support sound, economic, and low maintenance design for bridge deck and bridge end drainage facilities. For the designer of bridge drainage systems, water and its removal is a many-faceted problem. Water may collect in pools or run in sheets; its presence can slow traffic and cause hydroplaning. Water may freeze or fall as ice or snow, making roadways slick and plugging drains. In addition to its ability to disrupt the main traffic function of the bridge, rain may also pick up corrosive contaminants, which, if allowed to come into contact with structural members, may cause deterioration. Uncontrolled water from bridge decks can cause serious erosion of embankment slopes and even settlement of pavement slabs. The rain that falls on a structure may cause stains and discoloration on exposed faces if it is not collected and disposed of properly.

Poor bridge deck drainage is rarely a direct cause of structural failure and thus, bridge designers often view drainage as a detail. Nevertheless, proper design provides benefits related to traffic safety, maintenance, structural integrity, and aesthetics. Furthermore, in light of the movement to control urban stormwater pollution, the potential to improve water quality using off-bridge detention facilities to settle out solid particles in the drainage is sometimes considered.

The detrimental effects of runoff emphasize the importance of getting water off the bridge deck as soon as possible. This points up the need for an efficient drainage system that is always in good working order. Proper designs and procedures can ensure that drains are working and bridge decks are free of standing water. This manual provides guidelines and procedures for designing bridge deck drainage systems, accompanied with illustrative and practical examples.

1.1 Scope

This manual constitutes a compendium of bridge deck drainage design guidance. It features design theory, step-by-step design procedures, and illustrative examples. Drainage system design is approached from the viewpoints of hydraulic capacity, traffic safety, structural integrity, practical maintenance, and architectural aesthetics. System hardware components, such as inlets, pipes, and downspouts, are described. Guidance for selecting a design gutter spread and flood frequency are provided. Theory, system details, and existing computer models are discussed.

1.2 Design Objectives

In designing a system to remove water from the bridge deck, the engineer must develop solutions that:

- Control the spread of water into traffic lanes, as well as the depth of water available to reduce tire traction.
 - Do not interfere with the architectural beauty or structural integrity of the bridge.
 - Will function properly if clogging is maintainable.
-

1.2.1 Minimization of Spread

As water accumulates and spreads across the width of the gutter and into the traffic lane, it can reduce service levels and cause safety problems. Inlets must be adequately sized and spaced to remove rainfall-generated runoff from the bridge deck before it encroaches onto the traveled roadway to the limit of a design spread.

1.2.2 Avoidance of Hydroplaning

Precipitation produces sheet flow on pavement, as well as gutter flow. If sheet flow or spread is of sufficient depth, the tire can separate from the pavement surface. To reduce the risk of motorist hydroplaning, the drainage system must be designed to prevent the accumulation of significant depths of water.

1.2.3 Integration into Structural Dimensions

The drainage system must conform with the structural requirements of the bridge. Drainage details affect structural design: inlets for reinforced concrete bridge decks must fit within the reinforcing bar design. If drainage is not needed, structural design is free of inlet details. In addition, the drainage system should prevent water, road salt, and other corrosives from contacting the structural components.

1.2.4 Aesthetics

A pipe system conveying water from deck inlets to natural ground can be affixed to exterior surfaces of a bridge or encased within structural members. Exposed piping can be unsightly. Pipes affixed to exterior surfaces of structures, running at odd angles, can present an unpleasant silhouette and detract from a bridge's architectural aesthetics. To avoid this, pipes can be run in slots up the backs of the columns or can be hidden behind decorative pilasters. However, encased piping poses serious maintenance considerations and is not typically used in Northern

States due to potential freezing damage.

1.2.5 Minimization of Maintenance

An ideal solution is no inlets. The fewer inlets, the easier to maintain them--clogged inlets are a widespread maintenance problem. The drainage design engineer should first consider whether or not bridge drains are essential. If drains are required, the system design should provide means for convenient maintenance.

1.2.6 Bicycle Safety

The design engineer should also consider the hazards that inlets themselves present to cyclists. Grates with bars parallel to the centerline may be unsafe for bicyclists. Remedy this by putting crossbars or vanes at right angles to the flow or using a reticuline composite grate. The safety remedy, however, does reduce the efficiency of the inlet to admit water. If bicyclists are not allowed, then parallel bar grates without crossbars are the most efficient hydraulic solution.

1.3 Systems

The bridge deck drainage system includes the bridge deck itself, bridge gutters, inlets, pipes, downspouts, and bridge end collectors. The details of this system are typically handled by the bridge engineer and coordinated with the hydraulic engineer. Coordination of efforts is essential in designing the various components of the system to meet the objectives described in the previous section.

1.3.1 Deck and Gutters

The bridge deck and gutters are surfaces that initially receive precipitation and debris. If grades, super-elevations, and cross-slopes are properly designed, water and debris are efficiently conveyed to the inlets or bridge end collectors. Bridge deck designs with zero grades or sag vertical curves are poor hydraulic designs and can cause water problems. Super-elevation transitions through a zero grade cause water problems as well.

1.3.2 Hardware--Inlets, Pipes, and Downspouts

From the deck and gutters, water and debris flow to the inlets, through pipes and downspouts, and to the outfall. Various grate and inlet box designs are available to discourage clogging. Collector pipes and downspouts with a minimum of T-connections and bends help prevent clogging mid-system. Collector pipes need

sufficient slope to sustain self-cleansing velocities. Open chutes are not recommended for downdrains because of difficulties in maintaining chutes and capturing, and then containing the flow. Inlets, and associated hardware, should be called for only when necessary. Super-elevated bridge decks only need inlets on the low side, if any.

1.3.3 Bridge End Collectors

Drainage collection devices placed at the ends of bridges are essential and have two basic purposes. First, they control the amount of upslope drainage that can run onto the bridge deck. Second, they intercept runoff from the bridge deck at the downslope end.

An inlet should be provided just off the upslope end of the bridge in each gutter to intercept the drainage before it gets onto the deck. Collectors at the downslope end catch flow not intercepted by bridge inlets. If there are no bridge inlets, downslope inlets intercept most of the bridge drainage.

1.4 Outline of Design Conditions

Selection of a design rainfall intensity is essential to the design of a bridge deck drainage system. This is analogous to the selection of design loads for structural systems. This manual presents three methods for selecting the design rainfall intensity:

1. *Rational Method*--the drainage system is sized for the rainfall intensity with a duration equal to the time of concentration and a frequency selected by the designer. The time of concentration is the sum of sheet flow time plus gutter flow time and is on the order of 5 to 10 minutes. The use of this method can ensure that the flooding frequencies used along the right-of-way match frequencies used on the bridge.
2. *Avoidance of hydroplaning*--the drainage and cross-slopes systems are designed for the threshold rainfall intensity for hydroplaning. Larger systems will be oversized from a vehicle safety standpoint because hydroplaning is unavoidable without pavement modification.
3. *Driver vision impairment*--the drainage system is sized for the rainfall intensity at which driver sight distance is reduced to levels less than safe stopping intervals.

[Chapter 2](#), [Chapter 3](#), [Chapter 4](#), [Chapter 5](#), [Chapter 6](#), and [Chapter 7](#) present the elements of bridge deck and bridge end drainage design. [Chapter 2](#) is a discussion of typical system components, which includes bridge deck and gutters, hardware, and bridge end collectors. [Chapter 3](#) provides estimation of runoff based on the Rational Method, hydroplaning, and driver vision criteria. [Chapter 4](#) describes flow in various types of gutters. [Chapter 5](#) is a discussion of

bridge deck inlets and their associated capacities, efficiencies, and anti-clogging features. [Chapter 6](#) provides guidance on underdeck piping with regard to hydraulic design and describes some underdeck features. [Chapter 7](#) discusses bridge end collectors and associated similarities and differences to pavement drainage. [Chapter 8](#) provides guidance for selecting the governing criterion and for determining whether a system of inlets is necessary. A method for inlet sizing and spacing is presented and design of system details and end treatments are discussed in [Chapter 8](#) and [Chapter 9](#). Two examples are provided in [Chapter 10](#) to illustrate the design methodology. Bridge decks that exist within vertical curves are considered a more complex case and a design example is provided in [Appendix A](#). Derivations of design equations not found and cited in other references are presented in [Appendix B](#). The logic and graphics used in the design methods are presented as charts. These charts are assembled as a complete set of graphical design aids in [Appendix C](#). [Appendix D](#) presents a glossary of terms.

[Go to Chapter 2](#)



Chapter 2 : HEC 21

Typical System Components

[Go to Chapter 3](#)

The components of bridge deck drainage systems introduced in [Chapter 1](#) are described in greater detail in this chapter. Terminology to be used throughout this manual is introduced. Additional help for the reader is found in [Appendix D](#). Requirements of the system components for meeting the design objectives are described.

2.1 Terminology

For the sake of consistency and clarity, a list of terms is provided below.

Cleanout plug: A removable plug in the piping system that gives access to a run of piping for cleaning. It is typically located near bends and Y-shaped intersections.

Cross slope: The slope of the pavement cross section from the curb to the bridge deck crown.

Drop inlet: A drain that is used away from a bridge or at bridge ends. It is usually larger than an inlet chamber and is set in earth in the subgrade or shoulder of an approach embankment. It has a horizontal or near-horizontal opening.

Drain: A receptacle that receives and conveys water.

Drainage system: The entire arrangement of grates, drains, inlet chambers, pipes, gutters, ditches, outfalls, and energy dissipators necessary to collect water and convey it to a disposal point.

Grate: The ribbed or perforated cover of an inlet chamber that admits water and supports traffic loads; long-established practice is to make grates that are safe for cyclists. Typically, grates are removable to allow maintenance.

Inlet chamber: The typically small cast-iron, welded-steel, or formed-concrete compartment that is beneath a grate. Although usually set into the bridge deck, it is sometimes only an open hole in the deck.

Outlet pipe: The pipe that leads the water away from an inlet chamber or drop inlet.

Runoff, drainage, water: Any liquid that can run off the roadway surface. Although the liquid is generally water, it includes any other liquids and dissolved solids that can make their way into the drainage system.

Scupper: A small opening in the deck, curb, or barrier through which water can flow

from the bridge deck. The term is nautical and by analogy relates bridge deck drains to openings in the sides of ships at deck level to allow water to run out.

Spread: The top width of water measured laterally from the bridge curb.

Storm drain: A beneath-the-bridge and underground piping system that may connect to a municipal storm drain system or may be a separate collection system for highway and bridge drainage.

2.2 Requirements

The main requirement of the drainage system is that it remove rainfall-generated runoff from the bridge deck before it collects and spreads in the gutter to encroach onto the travel roadway to the limit of a design spread. In accomplishing this purpose, the drainage system must meet other design criteria, as presented below.

2.2.1 Similarities to Pavement Components

The bridge deck, gutters, and inlets have similar design requirements as the components used in pavement drainage systems. The geometry of deck and gutters should discourage ponding and encourage efficient transport of flow to the inlets or bridge ends. Similar to roadway inlets, bridge inlets should be designed to minimize clogging and inlet grates should be designed to be traffic-safe.

2.2.2 Differences with Pavement Components

While bridge deck drainage is accomplished in the same manner as drainage of other curbed roadway sections, bridge decks are often less effectively drained because of lower cross slopes, uniform cross slopes for traffic lanes and shoulders, parapets that collect relatively large amounts of debris, drainage inlets and piping that are relatively small, and clogging of inlets and drainage systems. Bridge inlets collect flow into relatively small ductile cast-iron or welded-steel chambers. By contrast, pavement systems have features that are much larger pre-cast, cast-in-place, or masonry structures. Such weight and size is incompatible with bridge structures. Bridge drains are typically steel tubes that must withstand vibrations and deflections better than the storm drains associated with pavement drainage.

Requirements in the design of deck drainage systems differ in the following respects from roadway drainage systems:

- Total or near total interception may be a desirable upgrade of expansion joints.
- Deck drainage systems, having rather small inlets and piping, are highly

susceptible to clogging.

- Inlet spacing is often predetermined by bent spacing or piers.
 - Inlet sizes are sometimes constrained by structural considerations.
-

2.2.3 Structural Considerations

The two main structural considerations in drainage system design are: (1) inlet sizing and placement must be compatible with the structural reinforcement and components of a bridge; and (2) the drainage system should be designed to deter flow (and associated corrosives) from contacting vulnerable structural members or eroding embankments. Structural and hydraulic engineers should work together to design a system that has the necessary hydraulic capacity and is compatible with structural elements. To avoid corrosion and erosion, the design must include proper placement of outfalls, including prevention of flow from splashing or being blown back onto support members. In addition, water should be prevented from running down a crack at the paving notch joint, between pavement and bridge, and undermining an abutment or wingwall.

2.2.4 Maintenance Considerations

Because the drainage system will not function properly if it becomes clogged with debris, maintenance requirements must be considered in the system design. In particular, the design should avoid the following common maintenance problems:

- Clogging of inlets or outlet pipes because of flat grades, points where debris is trapped, poor location, or lack of self-cleansing velocities at low-flow conditions.
- Lack of room for maintenance on the bridge deck and access beneath the bridge.
- Unsafe working areas for maintenance personnel that could result in infrequent maintenance.
- No provisions for cleanouts of the outlet pipe system, or poorly placed cleanouts.

Specifics for addressing these problems are presented in later chapters.

2.3 Deck and Gutters

Adequate cross slope and longitudinal grade must be provided so that water runs quickly toward the drain. Because the object is to remove the water as soon as possible, the steeper the slope the better. However, there are limits to the grade and slope desirable in a deck. Most states use from 1- to 2-percent cross-slope as a minimum (also noted as 1/8 in/ft to 1/4 in/ft).

Steeper slopes (4 percent) give the bridge cross section a broken-back profile and make finishing the bridge deck difficult. High cross slope can also trouble slow-moving vehicles when the deck becomes icy.

The cross slope guides the water to the gutter where it must then run to the nearest drain. Although some States specify no minimum grade for the bridge itself, most States do specify a grade of at least 0.5 or 1 percent. Should the grade be less than 0.5 percent, the designer must specify a gutter grade that will run the water to the inlet boxes from high points between the boxes. Failure to provide adequate gutter grade will result in the need for design to accommodate flat water surfaces.

2.4 Hardware--Inlets, Pipes, and Downspouts

The various hardware components should be designed to minimize maintenance problems and to avoid interference with the aesthetics of the bridge. Inlets should be placed so as to provide room for maintenance crews to work safely. Provision should be made for clean-outs in the pipe and downspout systems. Pipes and downspouts should be hidden or coordinated with the architectural design of the bridge. They should be pitched at 2 percent or greater slope to achieve self-cleansing velocities. Storm drain systems beneath bridges might be necessary to transport runoff to bridge end collectors or stormwater detention facilities.

2.5 Bridge End Collectors

Grate inlets, curb opening inlets, combination inlets, or slotted drain inlets may be used for bridge end drains. The hydraulic characteristics of the inlet should be considered in selecting the type. Water must be transported across the paving notch. From the inlet structure, there must be either a pipe, paved channel, or trough to carry the water down the face of the embankment. The downslope bridge end collectors might be sized assuming all inlets on the bridge itself are clogged. Should a conservative approach be appropriate, water that is collected and transported off a bridge can be detained in temporary storage facilities, typically ponds. Retention and detention ponds, with or without permanent pools, can be provided to attenuate peak flows or provide quiescent conditions to settle out particulates.

[Go to Chapter 3](#)



Chapter 3 : HEC 21

Estimation of Design Storm Runoff

[Go to Chapter 4](#)

The Rational Method is presented as the conventional method for determining peak runoff rate for bridge decks. Alternatives to the Rational Method for determining a design storm runoff for sizing the bridge deck drainage system are discussed in this chapter. Considerations for selecting the design rainfall intensity include the Rational Method, hydroplaning, driver vision impairment, and the Least Total Economic Cost (LTEC).

3.1 Selection of Design Spread and Frequency

Two significant variables considered in the design of bridge deck drainage systems are the frequency of the design runoff event and the spread of water on the pavement during the design event. A related consideration is the use of a larger flooding event (of lesser frequency) to check the drainage design.

The following are common hydraulics design frequencies:

Functional Class of Roadway	Frequency (Return Period--years)
Interstate	10
Major Collectors and Arterials	10
Minor Collectors and Arterials	5
Local Streets	2
Depressed Interstate Drained by Pumping Stations	50

Both design frequency and spread influence cost-effectiveness. The implications of the use of a criterion for spread of one-half of a traffic lane is considerably different for one design frequency than for another frequency. It also has different implications for a low-traffic, low-speed bridge than for a higher functional class. These subjects are central to the issue of bridge deck drainage and are important to traffic safety.

The objective in the design of a drainage system for a bridge deck section is to collect runoff in the gutter and convey it to inlets in a manner that provides reasonable safety for motorists, as well as cyclists and pedestrians, at a reasonable cost. As spread from the curb increases, the risks of traffic accidents and delays, and the nuisance and possible hazard to cyclists and pedestrian traffic, increase.

The process of selecting the design frequency and spread for design involves decisions regarding acceptable costs for the drainage system. Risks associated with water on traffic lanes are greater with high-traffic volumes, high speeds, and higher classifications than with lower volumes, speeds, and bridge classifications.

A summary of the major considerations that enter into the selection of design frequency and design spread follows.

1. The classification of the bridge is a good starting point in the selection process since it defines the public's expectations regarding water on the pavement surface. Ponding on traffic lanes of high-speed, high-volume bridges is contrary to the public's expectations and the risks of accidents and the costs of traffic delays are high.
2. Design speed is important to the selection of design criteria. At speeds greater than 45 mi/h, water on

the pavement can cause hydroplaning.

3. Projected traffic volumes are an indicator of the economic importance of keeping the bridge open to traffic. The costs of traffic delays and accidents increase with increasing traffic volumes.
4. The likelihood of rainfall events may significantly affect the selection of design frequency and spread. Risks associated with the spread of water may be less in arid areas subject to rare high-intensity thunderstorms than in areas accustomed to common but less-intense rainfall.
5. Capital costs are neither the least nor last consideration. Cost considerations make it necessary to formulate a rational approach to the selection of design criteria. Trade-offs between desirable and practicable criteria are sometimes necessary because of costs. In particular, the costs and feasibility of providing for a given design frequency and spread may vary significantly between projects. In some cases, it may be practicable to significantly upgrade the drainage design and reduce risks at moderate costs. In other instances, where extensive outfalls or pumping stations are required, costs may be very sensitive to the criteria selected for use in design.
6. This manual takes the viewpoint that inlets are designed not to clog. Their detailed configuration should keep objects that may plug the drain on the surface and in the gutter. The inlets themselves are taken to admit flow freely without clogging. This condition of unplugged drains may need to be taken into account by users of this manual with design situations that include clogging possibilities.

Other considerations include inconvenience, hazards, and nuisances to cyclists and pedestrian traffic. These considerations should not be overlooked and, in some locations, such as in urban areas, may assume major importance. Local design practice may also be a major consideration since it can affect the feasibility of designing to higher standards and because it influences the public's perception of acceptable practice.

If the bridge drains are designed for the 10-year frequency, they should be checked for hydraulic performance for a higher frequency, typically the 25-year level. The use of a check event is considered advisable if a sizeable area that drains to the bridge could cause unacceptable flooding during events that exceed the design event. Also, the design of any series of inlets should be checked against a larger runoff event, particularly when the series ends at a sag vertical curve in which ponding could occur.

The frequency selected for use as the check storm should be based on the same considerations used to select the design storm, that is, the consequences of spread exceeding that chosen for design and the potential for ponding. Where no significant ponding can occur, check storms are normally unnecessary.

Criteria for spread during the check event may be that one lane of traffic can still cross the bridge without having to splash through spread. Thus, for a crowned bridge with four 12-foot lanes, the check event spread could be: 10-foot breakdown lane plus 12-foot outside flooded lane, plus 4 feet of encroachment into the center lane, equals 26 feet of spread.

3.2 Calculation of Runoff

The conventional method for estimating runoff for highway pavement drainage is the Rational Method. The use of more complex rainfall-runoff models is unwarranted for the small drainage areas associated with bridge deck drainage. Base the determination of a design intensity for use in the Rational Method calculation on the time of concentration, which is a function of the design spread, or the condition for which hydroplaning will occur, or the specific intensity at which driver vision will be impaired (which is related to

vehicle speed).

3.2.1 Using Spread Plus Rational Method

The Rational Method first appeared in American literature in 1889 (Chow, 1964). The Rational formula is (Jens, 1979):

$$Q = kCiA, \quad (1)$$

where:

Q = The peak runoff rate, ft³/s.

k = 1, unit conversion factor.

C = A dimensionless runoff coefficient that represents characteristics of the drainage area. Typically this is taken to be 0.9 for bridge decks.

i = The average rainfall intensity, in/hr, for a duration equal to the time of concentration and for the frequency chosen for design.

A = Drainage area, acres.

Assumptions implicit in the Rational Method are (Chow, 1964; APWA, 1981):

1. The rate of runoff resulting from any rainfall intensity is greatest when the rainfall intensity lasts at least as long as the time of concentration.
2. The probability of exceeding the peak runoff rate is equal to the probability of the average rainfall intensity used in the method.
3. A straight-line relationship exists between the maximum rate of runoff and a rainfall intensity of duration equal to or longer than the time of concentration, for example, a 2-in/hr rainfall will result in a peak discharge exactly twice as large as a 1-in/hr average intensity rainfall.
4. The coefficient of runoff is the same for storms of all recurrence probabilities.
5. The coefficient of runoff is the same for all storms on a given watershed.

3.2.1.1 Coefficient of Runoff

The runoff coefficient, **C**, characterizes antecedent precipitation, soil moisture, infiltration, detention, ground slope, ground cover, evaporation, shape of the watershed and other variables. Commonly used average values for various surface types are assumed not to vary during the storm. When the bridge deck pavement is the sole contributing runoff surface, **C** is usually assumed to be 0.9. However, when other types of surfaces are involved (such as in the design of bridge end treatments), [Table 1](#) can be useful for selecting an appropriate **C** value. If more than one type of surface contributes to a particular inlet, **C** is determined as the average of the individual **C** values, weighted by area.

Table 1. Values of runoff coefficient, **C**, for use in the Rational equation

Type of Surface	Runoff Coefficient, C
-----------------	------------------------------

Paved	0.7 to 0.9
Gravel roadways or shoulders	0.4 to 0.6
Cut, fill slopes	0.5 to 0.7
Grassed areas	0.1 to 0.7
Residential	0.3 to 0.7
Woods	0.1 to 0.3
Cultivated	0.2 to 0.6

(Johnson and Chang, 1984)

Note: For flat slopes and permeable soils, use the lower values. For steep slopes and impermeable soils, use the higher values.

3.2.1.2 Rainfall Intensity

Information concerning the intensity, duration, and frequency of rainfall for the locality of the design is necessary to use the Rational Method. Precipitation intensity-duration-frequency (IDF) curves can be developed from information found in various National Weather Service (NWS) publications. Data from the NWS have been incorporated into the HYDRO computer program of the HYDRAIN (Young and Krolak, 1992) software package supported by the Federal Highway Administration (FHWA). HYDRO determines time of concentration, intensity, and peak runoff flow from user-supplied location and other information.

3.2.1.3 Time of Concentration

Time of concentration is defined as the time it takes for runoff to travel from the most distant hydraulic point in the watershed to the point of reference downstream. An assumption implicit to the Rational Method is that the peak runoff rate occurs when the duration of the rainfall intensity is as long or longer than the time of concentration. Therefore, the time of concentration for the drainage area must be estimated in order to select the appropriate value of rainfall intensity for use in the equation.

The time of concentration for bridge deck inlets is comprised of two components: overland flow time and gutter flow time. The overland flow is sheet flow from the deck high point to the gutter. If overland flow is channelized upstream of the location at which the flow enters the bridge deck gutter, a third component is added. These components are added together to determine the total time of concentration.

A study at the University of Maryland (Ragan, 1971) found that the most realistic method for estimating overland sheet flow time of concentration is the kinematic wave equation:

$$t_o = \frac{k_w (l_o n)^{0.6}}{(Ci)^{0.4} S^{0.3}}, \quad (2)$$

where:

t_o = The time of overland flow, min.

l_o = Overland flow length, ft.

n = Manning roughness coefficient.

C = Runoff coefficient.

i = Rainfall intensity, in/hr.

S = The average slope of the overland area.

k_w = 0.93, a constant.

The kinematic wave theory is consistent with the latest concepts of fluid mechanics. It considers all those parameters found important in overland flow when the flow is turbulent (where the product of the rainfall intensity and length of the slope is greater than 500).

Gutter flow time can be computed using [Equation \(3\)](#), which is derived from the Manning equation for gutter flow and the Rational Method ([Appendix B](#)):

$$t_g = k_g \frac{S_x T^2}{C i W_p}, \quad (3)$$

where:

- t_g = Time of gutter flow, min.
- S_x = Cross slope of gutter, ft/ft.
- T = Spread, ft.
- C = Coefficient of runoff.
- i = Rainfall intensity, in/hr.
- W_p = Width of pavement contributing runoff flow, ft.
- k_g = 484, a constant.

The total time of concentration, t_c , is the sum of t_o and t_g . (Note that [Equation \(2\)](#) and [Equation \(3\)](#) are represented in [Chart 2](#) and [Chart 3](#) in [Appendix C](#)).

Since the time of concentration and rainfall intensity are both independent variables, the solution for intensity is one of iteration or trial and error. A trial value for t_c is first assumed and the corresponding i determined from the IDF curve for the frequency of the event chosen for the particular design problem. This i is then used to compute t_o and t_g from [Equation \(2\)](#) and [Equation \(3\)](#). The procedure is repeated until the trial value and computed value for t_c are in close agreement. The procedure is presented in [Chapter 8](#) and illustrated by example in [Chapter 9](#). A similar procedure is performed automatically by the computer model, HYDRO.

3.2.2 Using Hydroplaning Avoidance

Select the design value of i using a driver safety rationale that considers the avoidance of hydroplaning. This is a new approach to drainage design. It seeks that rainfall that is just sufficient to cause a water depth of sheet flow at the edge of the traveled way that will cause hydroplaning. This edge occurs near the edge of the gutter spread. Tires rotating on the thin film at the outer edge of the spread may hydroplane and skid. The design concept is that removal and control of flooding, caused by rainfall in excess of rainfall that will cause hydroplaning, is overdesign from a vehicle safety standpoint. Procedures for using this method are presented in [Chapter 8](#).

3.2.3 Using Driver Vision Impairment

Select the design intensity using another driver safety rationale that considers driver vision impairment. There is a rainfall intensity that windshield wipers cannot remove or that creates sufficient vision reduction so that a driver can not see within a safe stopping distance. The design concept is that drainage removal or control of flooding caused by rain in excess of that rain, which will cause driver vision impairment, is overdesign from a vehicle safety standpoint.

The avoidance of driver-vision-impairment method is based on empirical observations of how far objects can be seen from behind a windshield in a car moving in rainfall. Details for using this method are presented in [Chapter 8](#).

3.2.4 Using Other Methods

The methods in this manual are suitable for computerization. Numerous runoff simulation models have been developed in recent years because of the interest in stormwater management for flood abatement. The models would have to be adapted to bridge deck drainage.

Recent research on Lowest Total Economic Cost (LTEC) methodology for pavement drainage (Young and Walker, 1990) could be adapted to the bridge deck situation. The LTEC methodology that uses a cost-risk approach relates the design rainfall to the costs of the drainage elements (individual inlets, for example) and the avoidance of traffic delays.

[Go to Chapter 4](#)

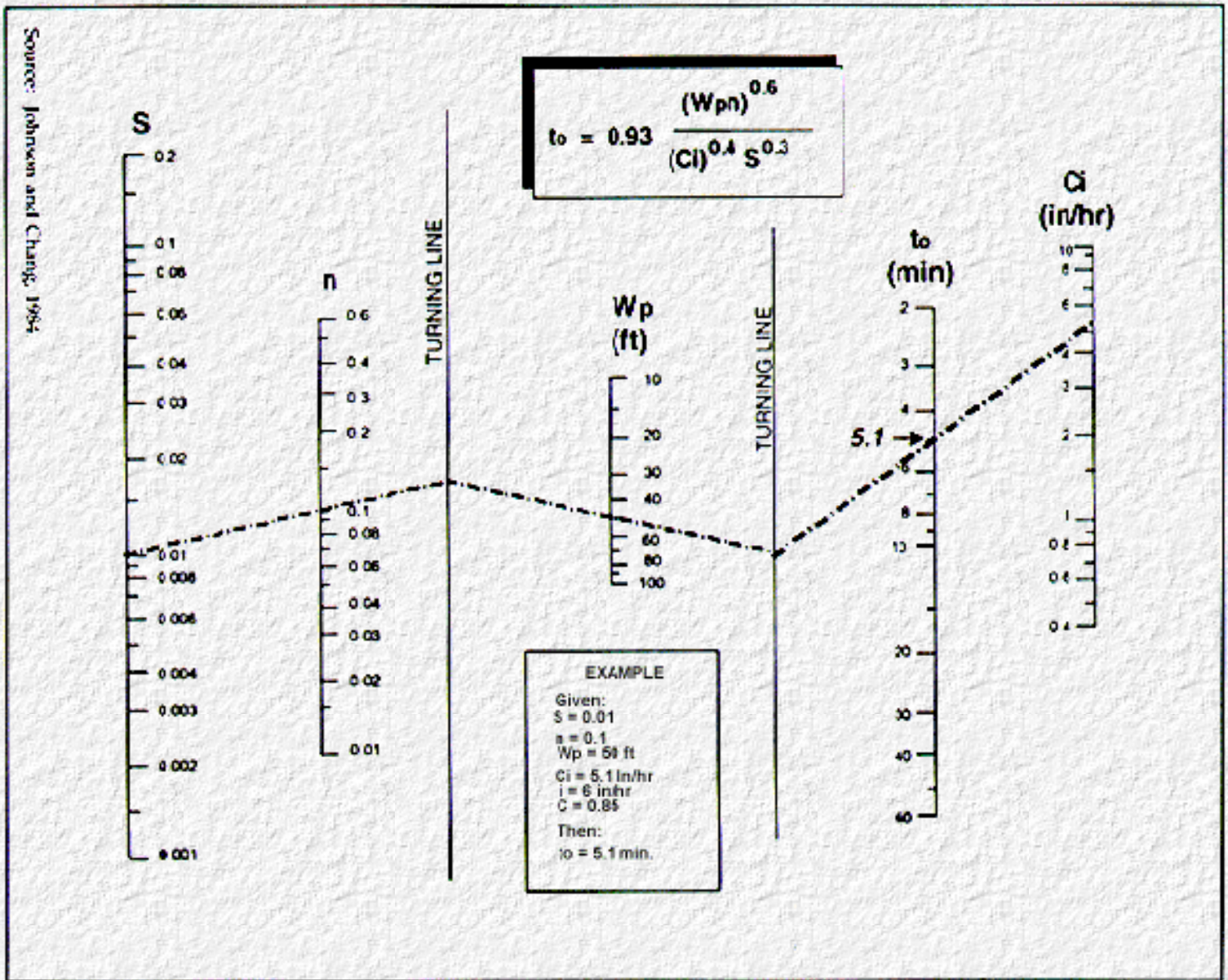

Chart 2. Overland time of concentration.

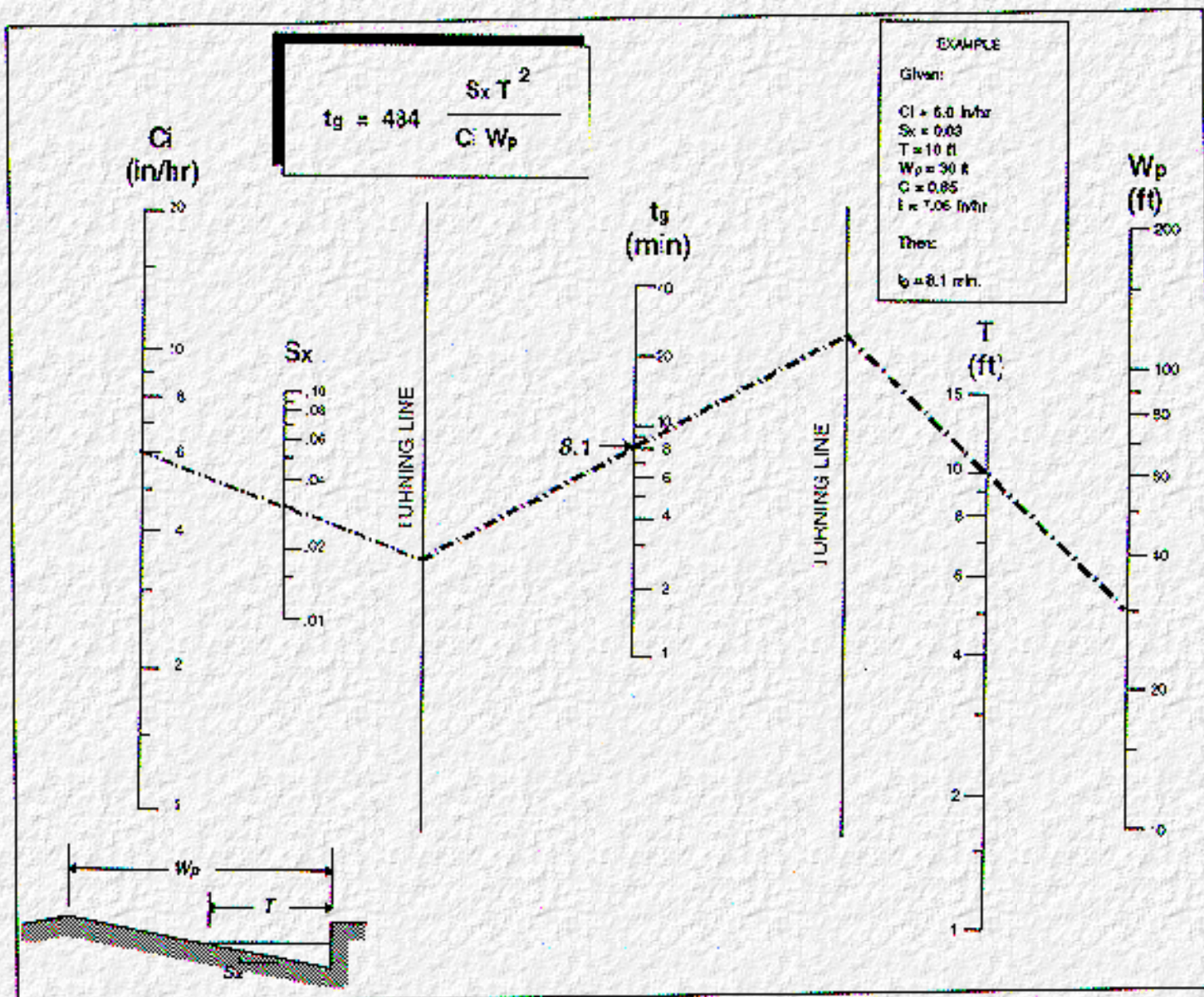

Chart 3. Gutter time of concentration.

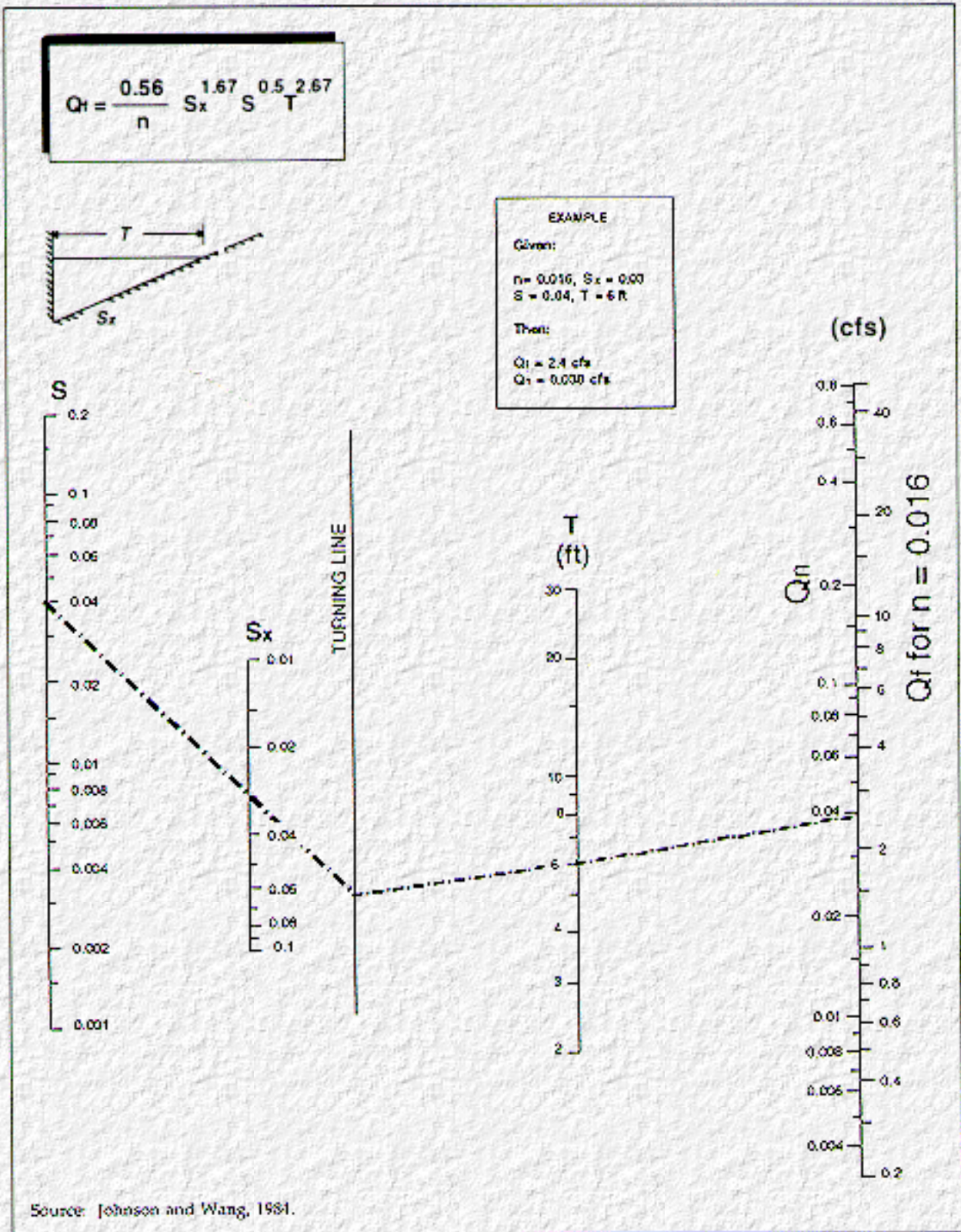

Chart 4. Flow in triangular gutter sections.

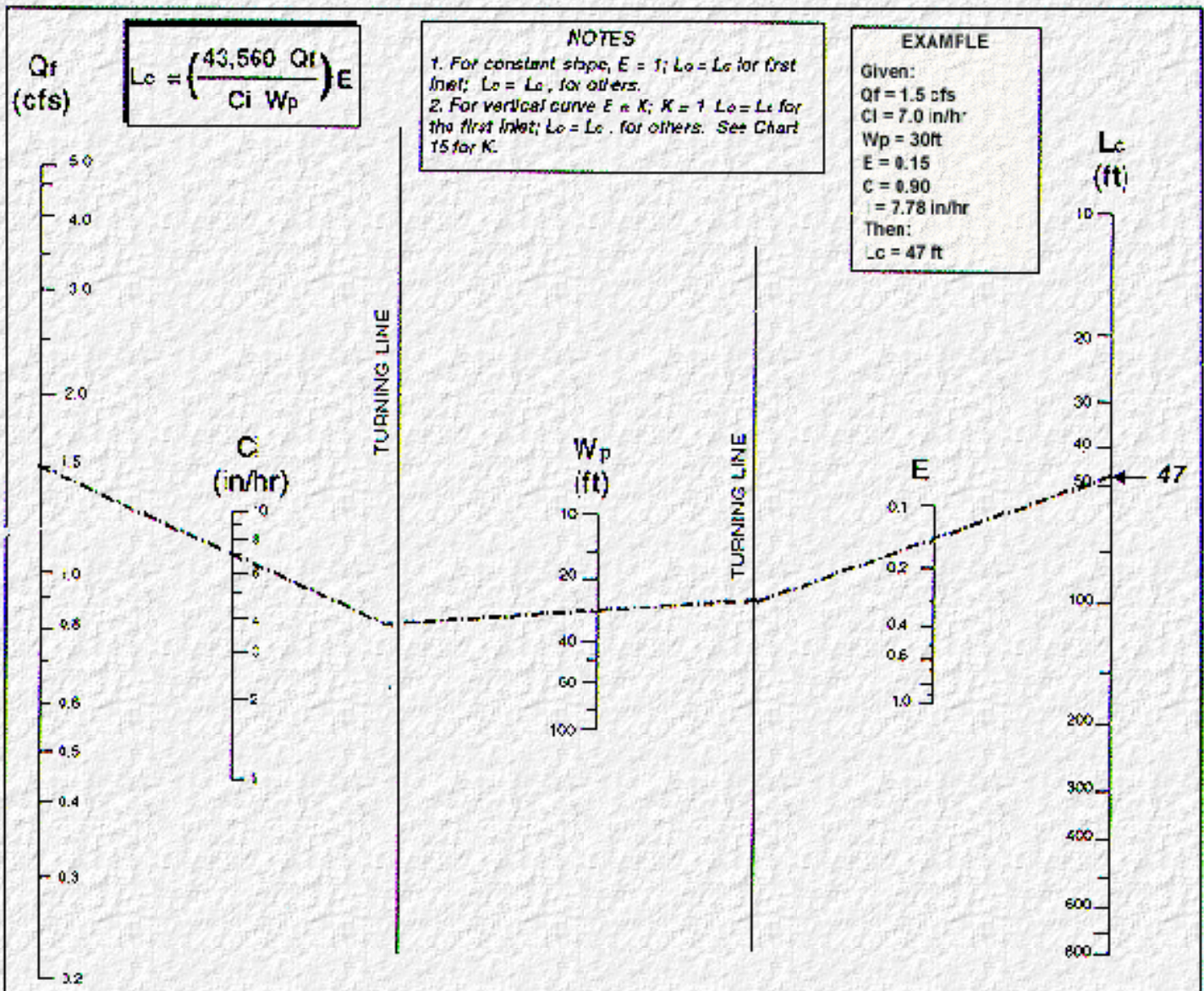

Chart 5. Inlet spacing.

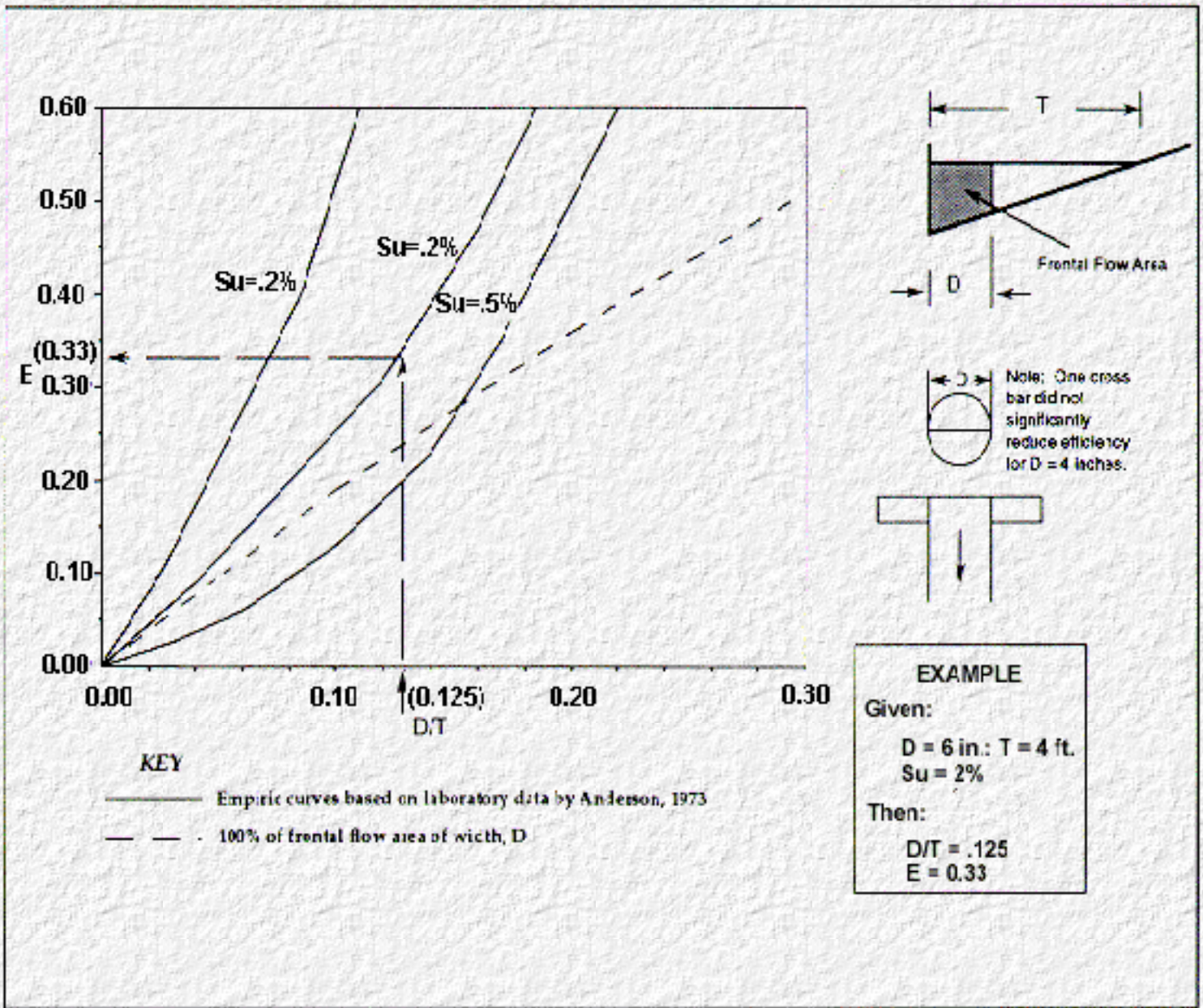

Chart 6. Efficiency curves for circular scuppers.

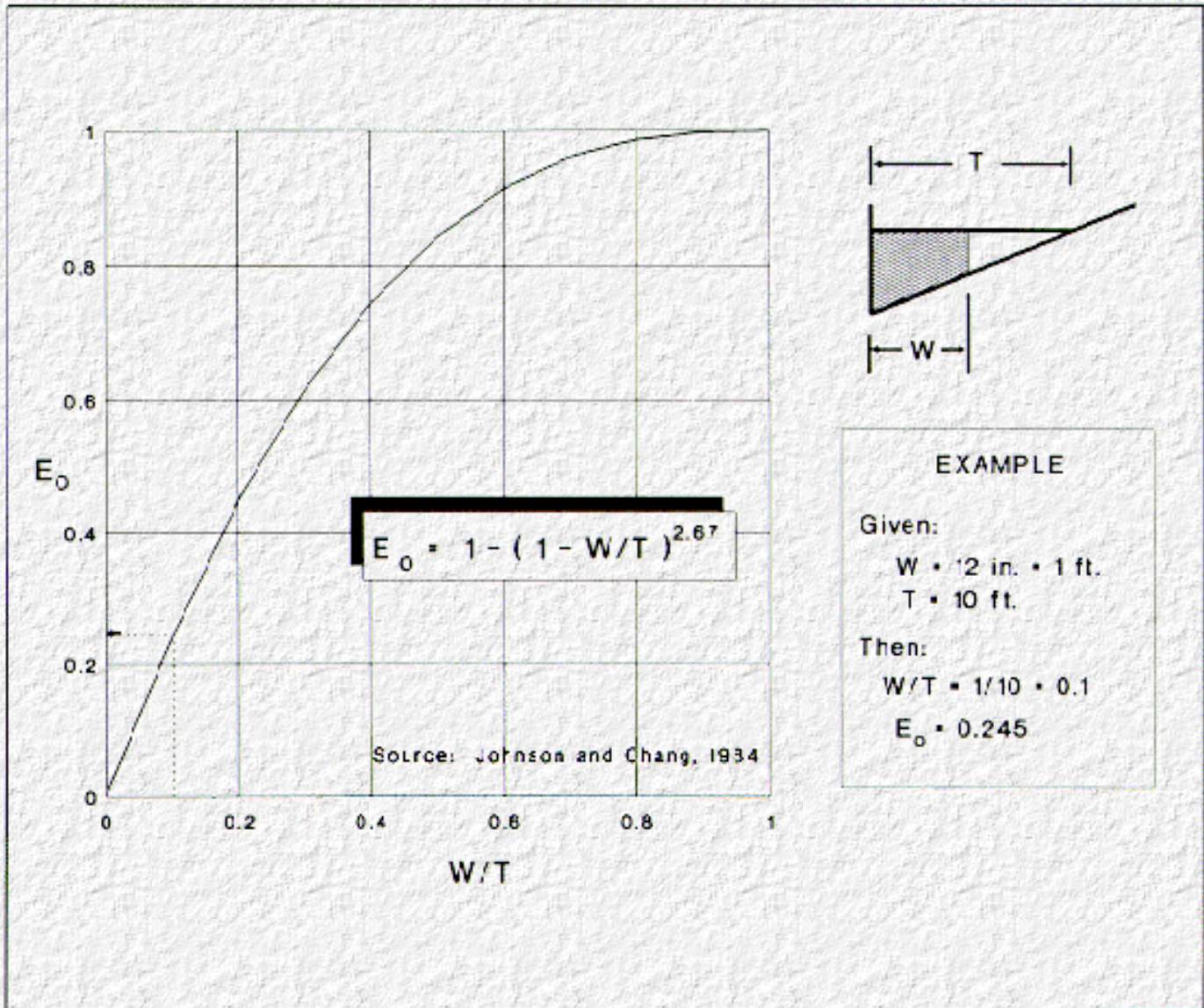
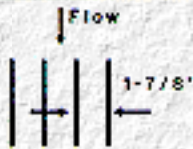
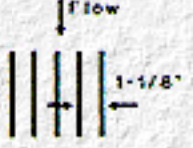
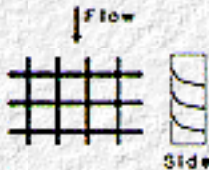
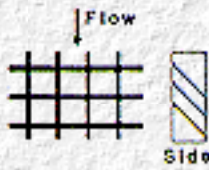
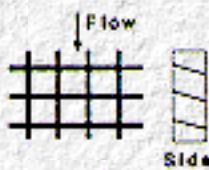
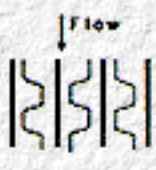

Chart 7. Frontal flow ratio for rectangular inlets.

Grate Type	Description	Comments
<p>Parallel bars with 1-7/8" spacing (not bicycle safe)</p> <p>(A)</p>	 <ul style="list-style-type: none"> • 1/4 x 4" bars • 1-7/8" bar spacing on center 	<p>(G) Adding transverse bars 4" o.c. to bicycle-proof this grate reduces performance to that of 30° vane.</p>
<p>Parallel bars with 1-1/8" spacing (not bicycle safe)</p> <p>(B)</p>	 <ul style="list-style-type: none"> • 3/8 x 4" bars • 1-1/8" bar spacing on center 	(See fig. 9, HEC-12)
<p>Curved vane</p> <p>(C)</p>	 <ul style="list-style-type: none"> • 4-1/2" vane spacing • 1/2 x 2" flat longitudinal bars • 3-7/32" bar spacing on center 	(See fig 10, HEC-12)
<p>45° tilt bar</p> <p>(D)</p>	 <ul style="list-style-type: none"> • 4" vane spacing • 1/2 x 2" flat longitudinal bars • 2-1/4" bar spacing on center 	
<p>30° tilt bar</p> <p>(E)</p>	 <ul style="list-style-type: none"> • 4" vane spacing • 1/2 x 2" flat longitudinal bars • 3-7/32" bar spacing on center 	(See fig. 12, HEC-12)
<p>Reticuline</p> <p>(F)</p>	 <ul style="list-style-type: none"> • 1/4 x 4" flat longitudinal bars, 2-9/16" o.c. • 3/16 x 2" reticuline bars 	<p>Grates with unvaned transverse members approximate reticuline performance.</p>

Note: Letters in circles refer to Chart 10.
 Letter (G) refers to 1-7/8 parallel bars with bicycle-safe transverse bars 4" o.c.

Source: Johnson and Chang, 1984.

Chart 8. Typical grates.

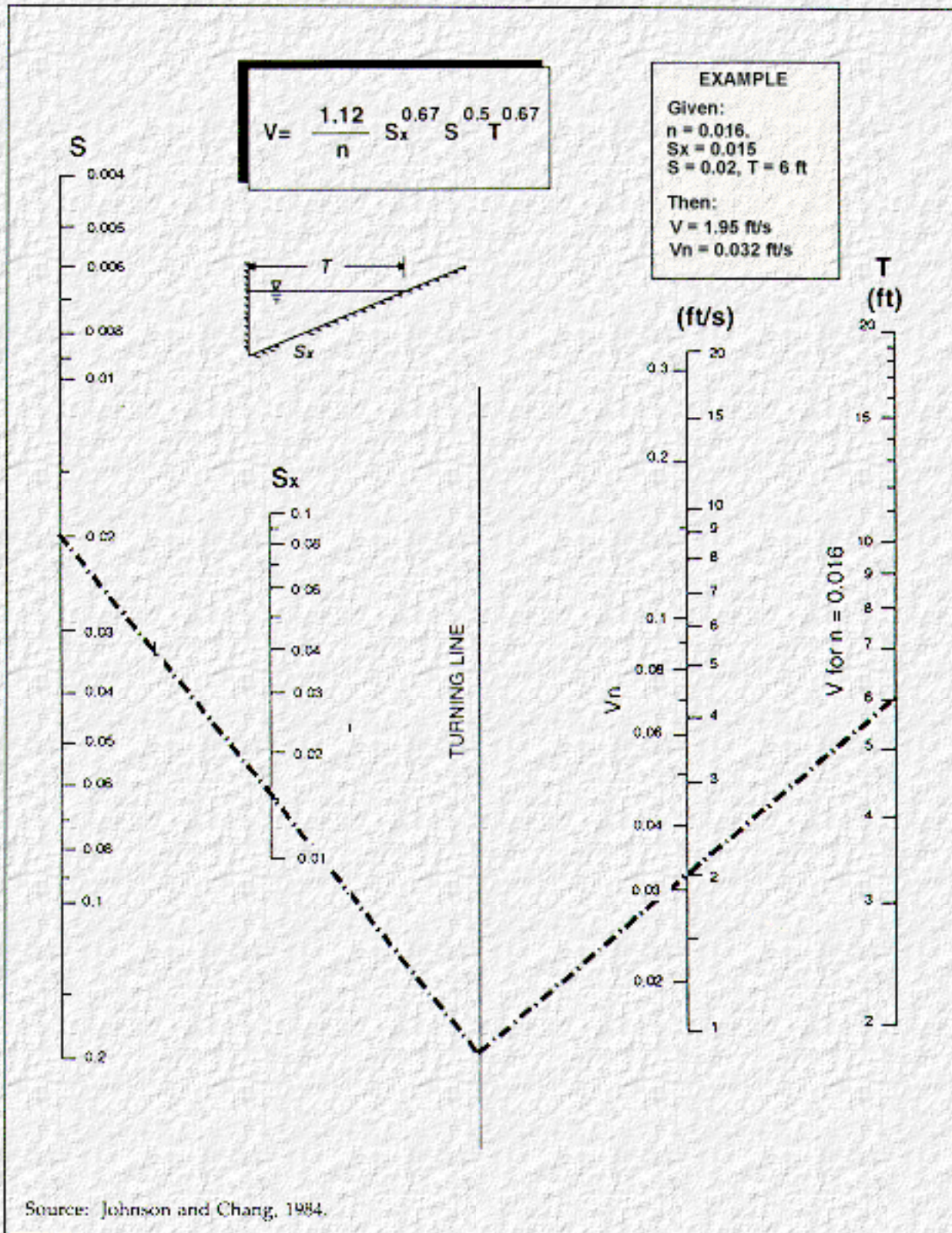

Chart 9. Velocity in triangular gutter sections.

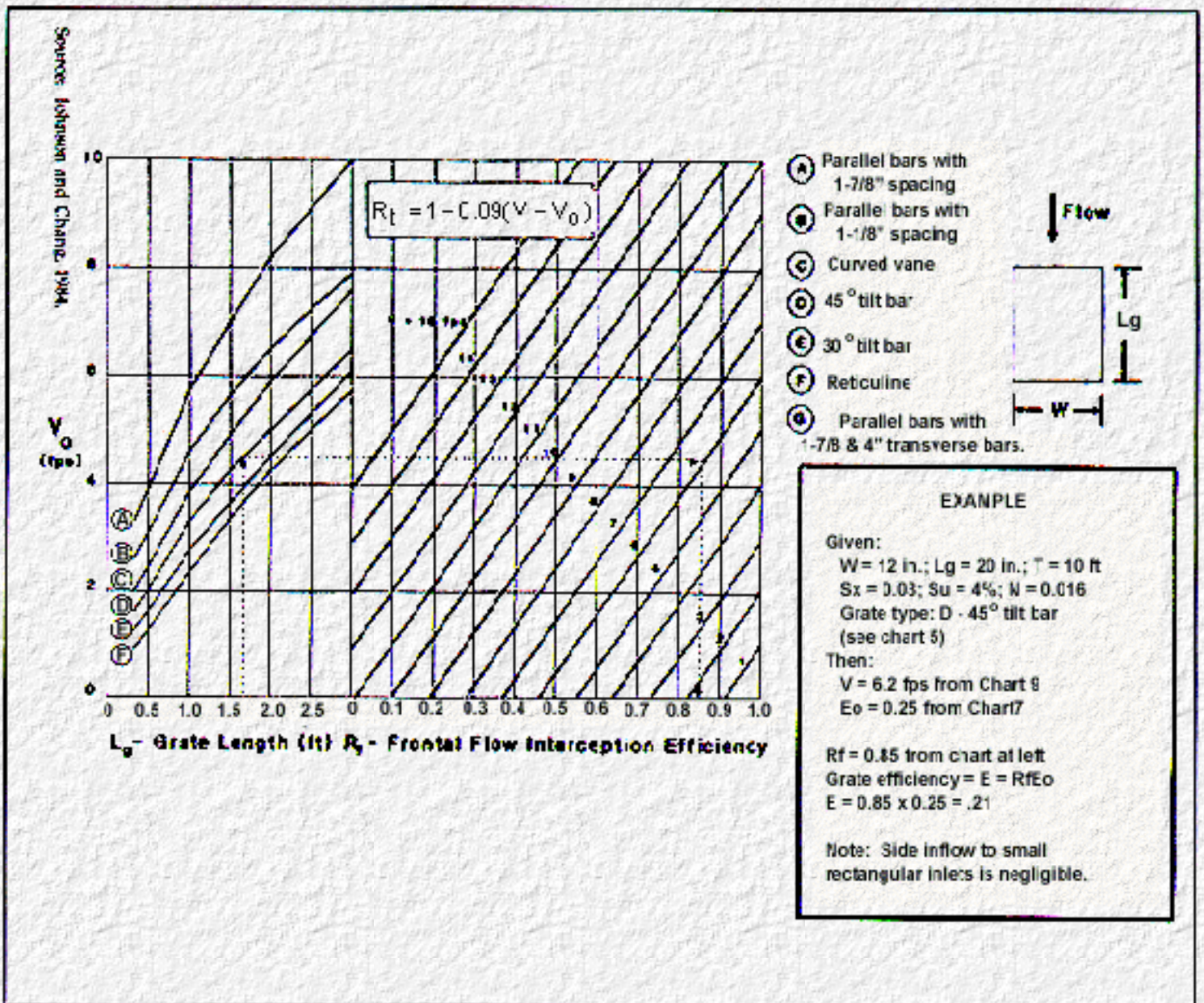

Chart 10. Frontal flow interception efficiency for typical grates.

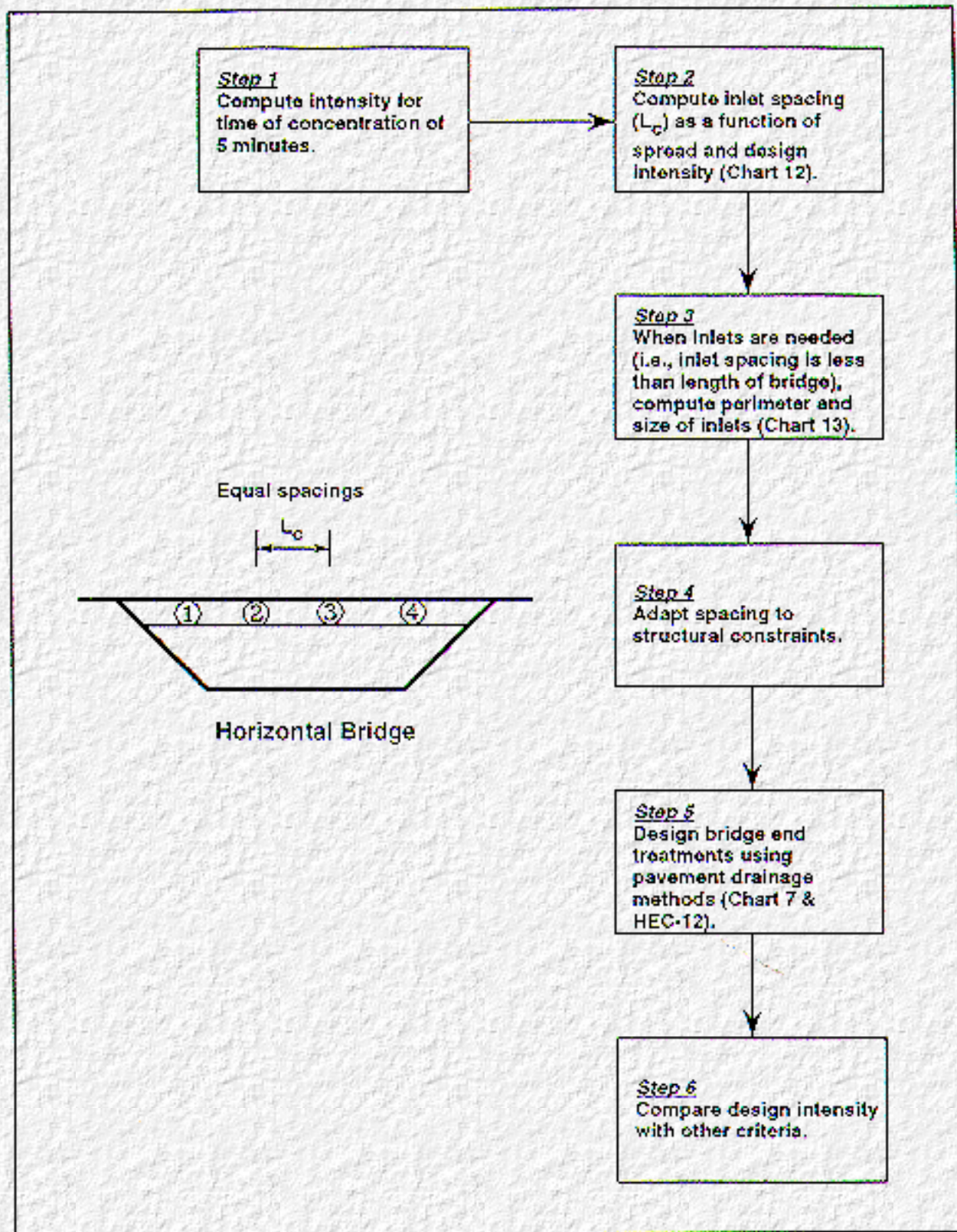

Chart 11. Logic for computing inlet spacing for a flat bridge.

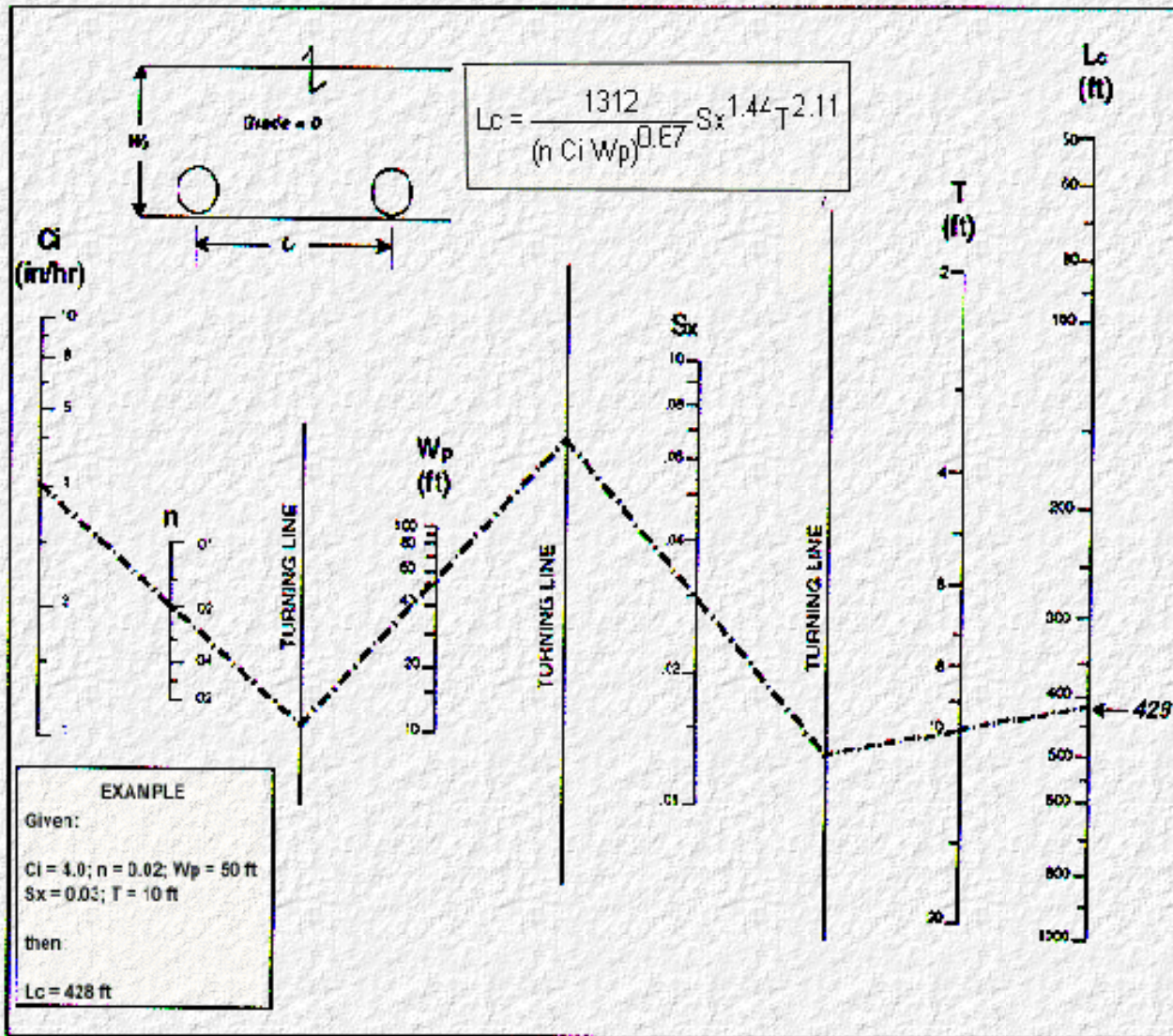

Chart 12. Inlet spacing for a flat bridge.

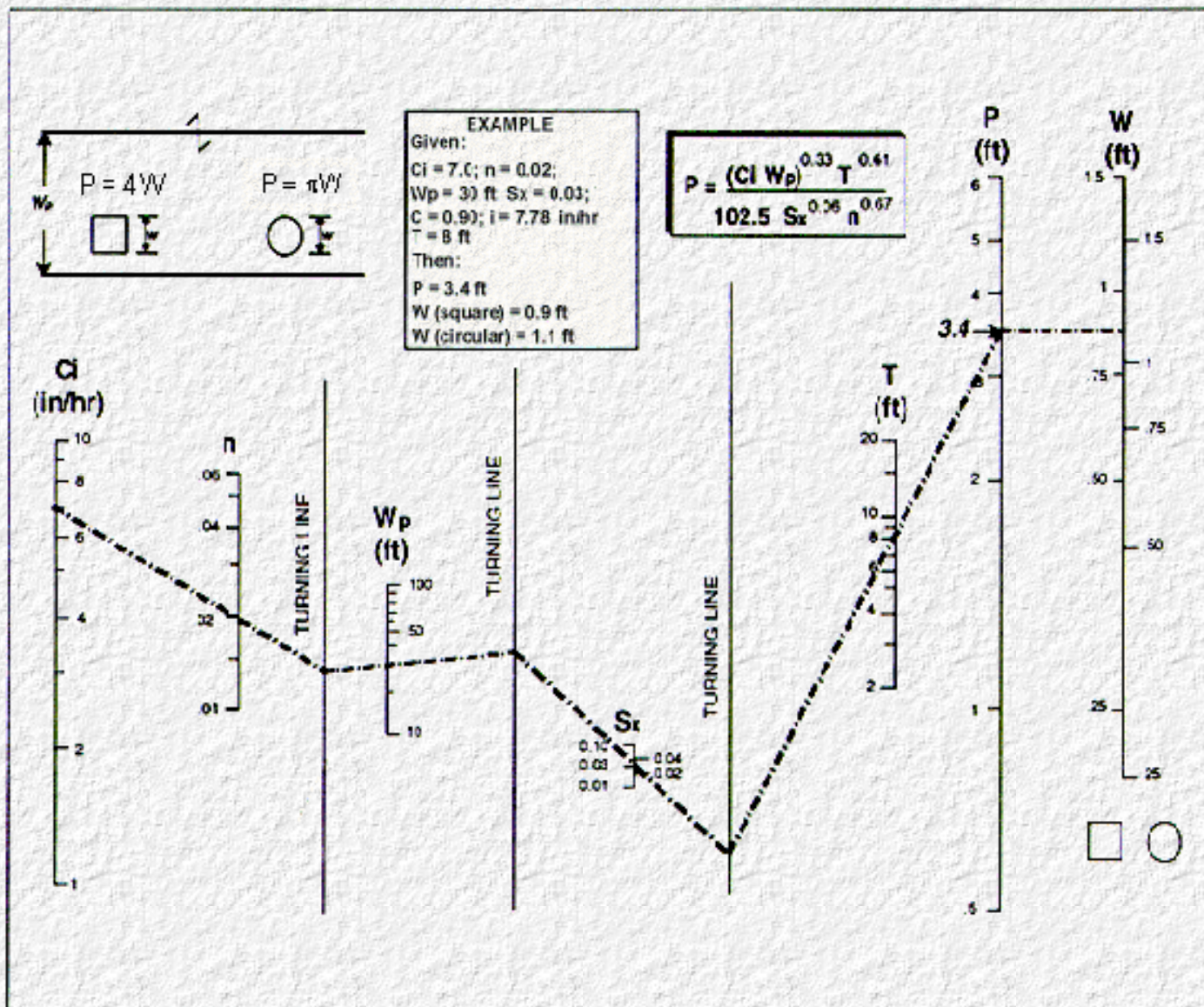

Chart 13. Inlet perimeter and width for a flat bridge.

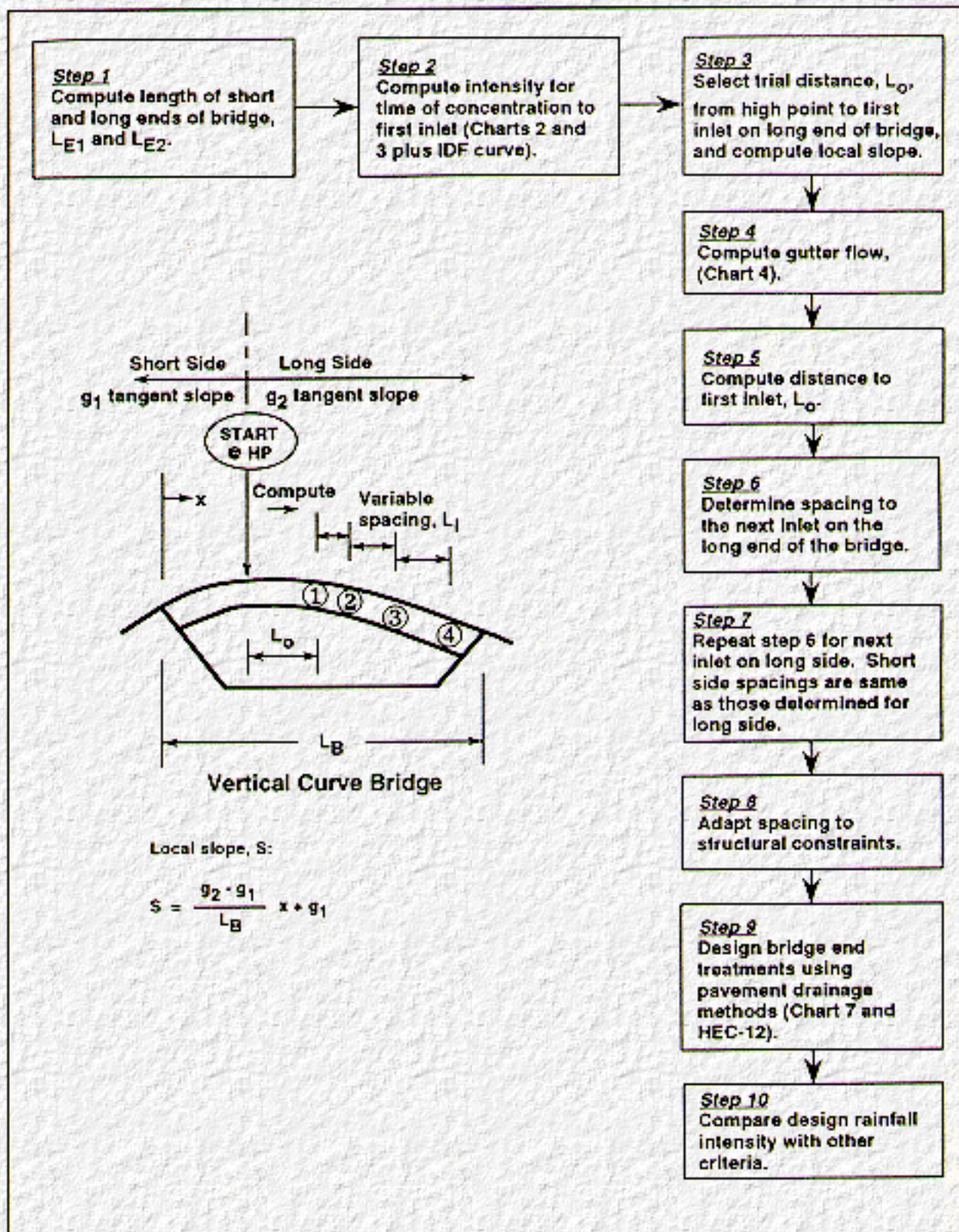

Chart 14. Logic diagram for vertical curve bridges.

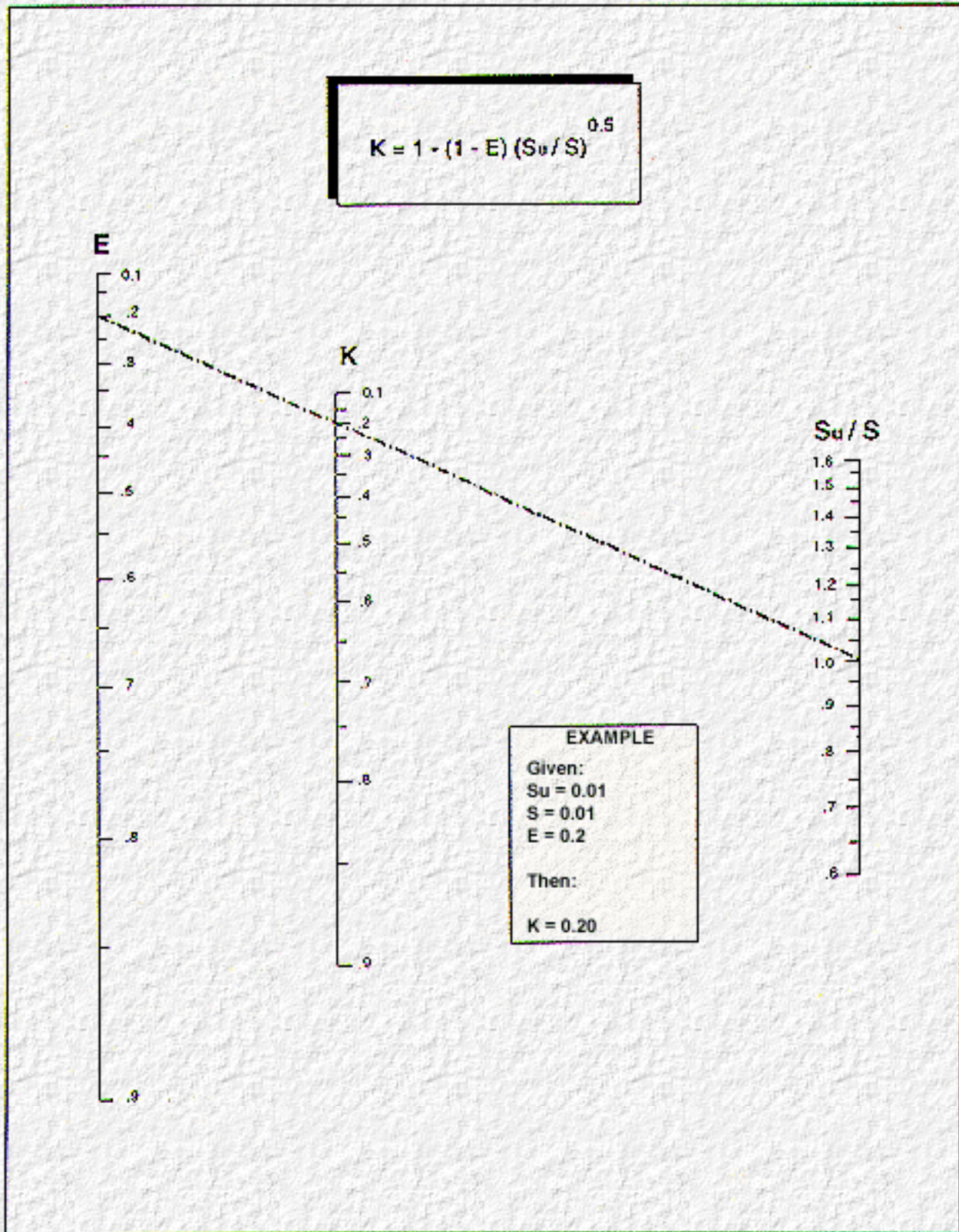

Chart 15. K for vertical curve bridges.

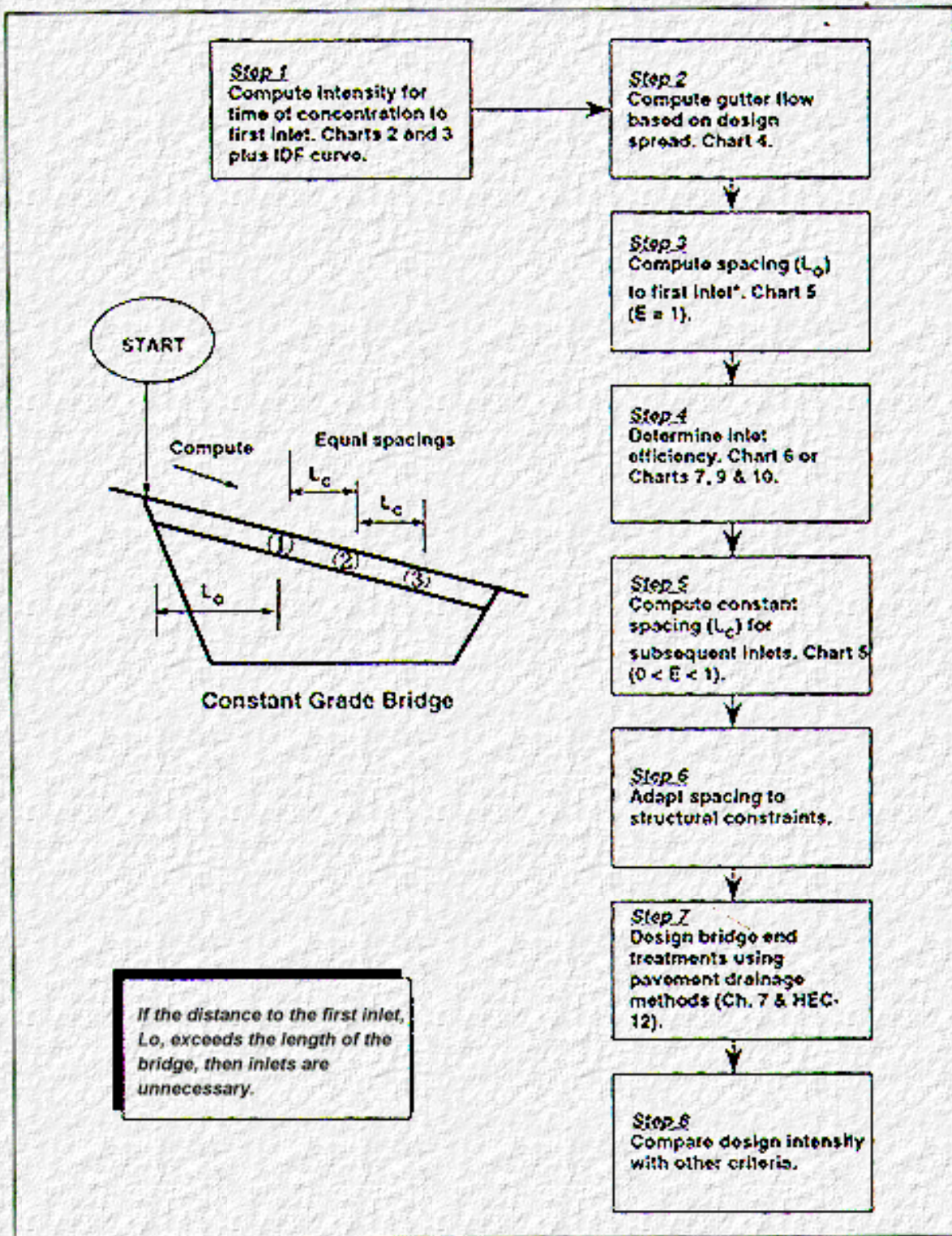

Chart 1. Logic for computing inlet spacing for a constant-grade bridge.



[Back to Table of Contents](#)



[Table 1. Values of runoff coefficient, C, for use in the Rational equation](#)



[Table 2. Hydroplaning rainfall intensity, \$i\$ \(in/hr\), for \$V = 55\$ mi/h \(hydroplaning sheet flow depth \$d = 0.08\$ in\)](#)



[Table 3. Hydroplaning rainfall intensity, \$i\$ \(in/hr\), for \$V = 65\$ mi/h \(hydroplaning sheet flow depth \$d = 0.047\$ in\)](#)



[Table 4. Gravity flow capacity of small diameter cast-iron pipes](#)

















[Back to Table of Contents](#)





[Back to Table of Contents](#)



-  [Chart 1. Logic for computing inlet spacing for a constant-grade bridge.](#)
-  [Chart 2. Overland time of concentration.](#)
-  [Chart 3. Gutter time of concentration.](#)
-  [Chart 4. Flow in triangular gutter sections.](#)
-  [Chart 5. Inlet spacing.](#)
-  [Chart 6. Efficiency curves for circular scuppers.](#)
-  [Chart 7. Frontal flow ratio for rectangular inlets.](#)
-  [Chart 8. Typical grates.](#)
-  [Chart 9. Velocity in triangular gutter sections.](#)
-  [Chart 10. Frontal flow interception efficiency for typical grates.](#)
-  [Chart 11. Logic for computing inlet spacing for a flat bridge.](#)
-  [Chart 12. Inlet spacing for a flat bridge.](#)
-  [Chart 13. Inlet perimeter and width for a flat bridge.](#)
-  [Chart 14. Logic diagram for vertical curve bridges.](#)
-  [Chart 15. K for vertical curve bridges.](#)



[Back to Table of Contents](#)







[Back to Table of Contents](#)



 [Equation 1](#)

 [Equation 2](#)

 [Equation 3](#)

 [Equation 4](#)

 [Equation 5](#)

 [Equation 6](#)

 [Equation 7](#)

 [Equation 8](#)

 [Equation 9](#)

 [Equation 10](#)

 [Equation 11](#)

 [Equation 12](#)

 [Equation 13](#)

 [Equation 14](#)

 [Equation 15](#)

 [Equation 16](#)

 [Equation 17](#)

 [Equation 18](#)

 [Equation 19](#)

 [Equation 20](#)

 [Equation 21](#)

 [Equation 22a](#)































 [Equation 22b](#)





















 [Equation 23](#)



 [Equation 24](#)

 [Equation 25](#)

 [Equation 26](#)

-  [Equation 27](#)
-  [Equation 28](#)
-  [Equation 29](#)
-  [Equation 30](#)
-  [Equation 31](#)
-  [Equation 32](#)
-  [Equation 33](#)
-  [Equation 34](#)
-  [Equation 35](#)
-  [Equation 36](#)
-  [Equation 37](#)
-  [Equation 38](#)
-  [Equation 39](#)
-  [Equation 40](#)
-  [Equation 41](#)
-  [Equation 42](#)
-  [Equation 43](#)
-  [Equation 44](#)
-  [Equation 45](#)
-  [Equation 46](#)
-  [Equation 47](#)
-  [Equation 48](#)
-  [Equation 49](#)
-  [Equation 50](#)
-  [Equation 51](#)
-  [Equation 52](#)
-  [Equation 53](#)
-  [Equation 54](#)
-  [Equation 55](#)
-  [Equation 56](#)

-  [Equation 57](#)
-  [Equation 58](#)
-  [Equation 59](#)
-  [Equation 60](#)
-  [Equation 61](#)
-  [Equation 62](#)
-  [Equation 63](#)
-  [Equation 64](#)
-  [Equation 65](#)
-  [Equation 66](#)
-  [Equation 67](#)
-  [Equation 68](#)
-  [Equation 69](#)
-  [Equation 70](#)
-  [Equation 71](#)
-  [Equation 72](#)
-  [Equation 73](#)
-  [Equation 74](#)
-  [Equation 75](#)
-  [Equation 76](#)
-  [Equation 77](#)

 [Back to Table of Contents](#) 

[Go to Table of Contents](#)

1. Report No. FHWA-SA-92-010	2. Government Accession No.	3. Recipient's Catalog No.
4. Title and Subtitle DESIGN OF BRIDGE DECK DRAINAGE Hydraulic Engineering Circular 21	5. Report Date May 1993	
	6. Performing Organization Report No.	
7. Author(s) G.K.Young, S.E. Walker, F. Chang	8. Performing Organization Report No.	
9. Performing Organization Name and Address GKY and Associates, Inc. 5411-E Backlick Road Springfield, VA 22151	10. Work Unit No. (TRAIS)	
	11. Contract or Grant No. DTFH61-90-C-00037	
12. Sponsoring Agency Name and Address Federal Highway Administration Office of Technology Applications, HTA-22 400 Seventh Street, SW. Washington, D.C. 20590	13. Type of Report and Period Covered Final Report June 1990-October 1992	
	14. Sponsoring Agency Code	
15. Supplementary Notes FHWA COTR: Tom Krylowski Graphics: Donna Pearson, GKY&A Technical Assistance: D.C. Woo, FHWA; Lawrence J. Harrison, FHWA; Mark P. Mistichelli, GKY&A; Chris Dunn, FHWA; A. Tamim Atayee, GKY&A		
16. Abstract <p>The manual provides guidelines and procedures for designing bridge deck drainage systems, including illustrative examples. Should the design process indicate a drainage system is needed, utilization of the most hydraulically efficient and maintenance-free system is emphasized. The manual also stresses the advantages of designing to minimize the complexity of bridge deck drainage systems. Integration of practical drainage details into overall structural design is presented. For user's convenience, all design graphs and nomographs appear in the index.</p> <p>The manual is a compendium of bridge drainage design guidance. It includes design theory, step-by-step design procedures, and illustrative examples. Drainage systems design is approached from the viewpoints of hydraulic capacity, traffic safety, structural integrity, practical maintenance, and architectural aesthetics. System hardware components, such as inlets, pipes, and downspouts, are described. Guidance for selecting a design gutter spread and flood fluency are provided. System details and existing computer models are discussed.</p>		
17. Key Words Bridge deck drainage, drainage inlets, bridge scuppers, hydroplaning, bridge end treatments, hydraulic design	18. Distribution Statement This document is available to the public from the National Technical Information Service, Springfield, Virginia 22151	

19. Security Classif. (of this report) Unclassified	20. Security Classif. (of this page) Unclassified	21. No. of Pages 129	22. Price
---	---	--------------------------------	------------------

[Go to Table of Contents](#)

LIST OF SYMBOLS

A	drainage area
C	Rational Method runoff coefficient
d	water film depth for hydroplaning calculation
D	inlet diameter
E	inlet interception efficiency
E_o	ratio of frontal flow to total gutter flow
g	acceleration due to gravity
i	rainfall intensity
k	Rational Method unit conversion factor ($k = 1$ for acres in/hr units)
k_g	gutter flow unit conversion factor
k_w	kinematic wave unit conversion factor
K	interception coefficient used for computing inlet spacing (vertical curve bridges)
L_B	length of bridge
L_C	length to end of bridge from bridge high point
L_{E1}	length of short end of bridge
L_{E2}	length of long end of bridge
L_c	constant inlet spacing for inlets after the first inlet on constant grade bridge
L_o	spacing to first inlet
L_x	inlet length (dimension parallel to flow)
L_i	inlet spacing for inlet i on vertical curve bridge
n	Manning's roughness coefficient
P	total inlet perimeter
P_t	tire pressure
Q	flow rate of runoff
Q_f	full gutter flow
Q_i	flow intercepted by an inlet
q	hydroplaning design flow at edge of spread

LIST OF SYMBOLS (continued)

q_s	hydroplaning sheet flow at edge of spread
q_p	pipe flow capacity
R_f	frontal flow interception efficiency
S	longitudinal grade of gutter or average slope of overland area
SD	percent spindown
S_u	longitudinal grade for upstream inlet on vertical curve bridge
S_w	cross slope of depressed gutter section nearest curb
S_x	pavement cross-slope
T	design spread on pavement
t_c	total time of concentration
TD	tire tread depth
t_g	gutter time of concentration
t_o	overland time of concentration
TXD	pavement texture depth (silicone putty method)
V	velocity at weir lip
\bar{V}	average gutter velocity
V_v	vehicle speed
V_o	velocity of flow at which splashover first occurs over a grate
V_s	sheet flow velocity
W	width (or diameter) of inlet
W_p	width of pavement contributing runoff (overland flow length)
x	depth of inlet box plus depth of water in gutter
X	horizontal distance along vertical curve from left edge

Note: Also see Appendix D—SELECTED GLOSSARY

References

AASHTO-AGC-ARTBA Joint Cooperation Committee Task Force No. 13, *A Guide to Standardized Highway Drainage Products*, December 1986.

Anderson, Melvin W., *A Hydraulic Study of Bridge Scuppers*, Department of Structures, Materials, and Fluids, University of South Florida, Tampa, Florida, 1973.

California Department of Transportation, *Standard Plans*, Sacramento, California, January 1981.

_____. *Bridge Deck Drains*, FHWA/CA/SD-81/15, Division of Transportation Facilities Design, Sacramento, California, August 1981.

Campbell Foundry Company, *Construction Castings Catalog, 9th Edition*, Harrison, New Jersey, 1973.

Chow, Ven Te, *Open Channel Hydraulics*, McGraw-Hill, New York, NY, 1964.

Colorado Department of Highways, *Drainage Inlet Details, Eastbound Walnut Viaduct*, Denver, Colorado, May 1986.

DeBacker, C., *Drainage of Water on Road Bridges--State of the Art and Recommendations*, Belgian Road Research Centre, March 1990.

Department of Highways, State of Montana, *Drain Details for Use With "T" Beams, Bridge Over Flint Creek*, Washington, D.C., Helena, Montana, September 1985.

Federal Highway Administration, *Standard Bridge Drains Used by Maine*, Memo from H.H. Davis, Washington, D.C., July 24, 1968.

_____. *Bridge End Drainage*, Internal Memo from M.F. Maloney, Washington, D.C., January 4, 1971.

_____. *Standard Plans for Highway Bridges, Vol. II, Structural Steel Superstructures*, Appendices C, D, Washington, D.C., August 1982.

_____. *Hydraulic Design of Energy Dissipators for Culverts and Channels*, HEC-14, Washington, D.C., 1983.

_____. *Standard Drawings for Scuppers*, Memo from Robert Nickerson, Washington, D.C., October 1984.

_____. *Standard Plans for Highway Bridges, Vol. IV A, Typical Continuous Bridges Load Factor Design*, [Appendix A](#), Washington, D.C., April 1984.

_____. *Standard Plans for Highway Bridges, Vol. I, Concrete Superstructures, Sheet No. 102*, Washington, D.C., January 1990.

_____. National Bridge Inventory, *Highway Bridges > or Equal to 20 Feet in Length*, Washington, D.C., July 25, 1990.

Gallaway, B.M., et al., *Pavement and Geometric Design for Minimizing Hydroplaning*, Texas Transportation Institute, Texas A&M University, College Station, Texas, 1979.

Highway Design Committee, Cook County, Illinois, *Study of Expressway Deck Drainage and Downspout Systems*, Cook County, Illinois, January 1969.

IKG Industries, *Irving Grating Catalog*, Long Island City, New York, 1973.

Ivey, Don L. et al, *Rainfall and Visibility--The View from Behind the Wheel*, Texas Transportation Institute, Texas A&M University, College Station, Texas, 1975.

Izzard, C.F., *Hydraulics of Runoff from Developed Surfaces*, Proceedings of the Highway Research Board, Volume 26, p. 129-150, Highway Research Board, Washington, D.C., 1946.

Jens, S.W., *Design of Urban Highway Drainage*, FHWA-TS-79-225, Federal Highway Administration, Washington, D.C., August 1979.

Johnson, F.L. and Chang, F., Hydraulic Engineering Circular No. 12, *Drainage of Highway Pavements*, Report No. FHWA-TS084-202, Federal Highway Administration, Washington, D.C., March 1984.

Marsalek, J., *Road and Bridge Deck Drainage Systems*, Ontario Ministry of Transportation and Communications, Ontario, Canada, 1982.

Normann, J.M., Houghtalen, R.J., and Johnston, W.J., *Hydraulic Design of Highway Culverts*, FHWA Hydraulic Design Series No. 5, Federal Highway Administration, Washington, D.C., September 1985.

Ragan, R.M., *A Nomograph Based on Kinematic Wave Theory for Determining Time of Concentration for Overland Flow*, Report No. 44, Civil Engineering Department, University of Maryland at College Park, 1971.

Romack, George P., *Performance of Bridge Joint Systems Designed for Large Movements*, FHWA Report No. SA-92-018, Washington, D.C., January 1992.

Transportation Research Board, National Cooperative Highway Research Program Synthesis of Highway Practice 67, *Bridge Drainage Systems*, National Research Council, Washington, D.C., December 1979.

Neenah Foundry Company, *Construction Castings Catalog "R," 11th Edition*, Neenah, Wisconsin, June 1989.

North Dakota State Highway Department, *Bridge Approach Drain Details*, Bismark, North Dakota, January 1975.

Utah Department of Transportation, *Shoulders and Median Drain Details*, Salt Lake City, Utah, November 1977.

Vermont Agency of Transportation, *Scupper Details of W Beam Bridges*, Sheet No. SCB-D6-73, Montpelier, Vermont, November 1973.

Virginia Department of Highways and Transportation, *Deck Drainage Details Rte. 1 Over James River*, Sheet No. 260-47, Richmond, Virginia, April 1984.

Woo, Dah-Cheng, Bridge Drainage System Needs Criteria, *Public Roads*, September 1988.

Young, G.K., and Krolak, J.S., HYDRAIN--Integrated Drainage Design Computer System, April 1992.

Young, G.K., and Walker, S.E., *Risk Cost Design of Pavement Drainage Systems*, ASCE, JWRPM, March/April 1990.

Young, G.K., et al., *Bridge Deck Drainage Guidelines*, Report to FHWA, FHWA/RD-87/014, Washington, D.C., December 1986.