



PDHonline Course C427 (16 PDH)

Treating for Nutrients in Wastewater

Instructor: Jim Newton, P.E., DEE

2020

PDH Online | PDH Center

5272 Meadow Estates Drive
Fairfax, VA 22030-6658
Phone: 703-988-0088
www.PDHonline.com

An Approved Continuing Education Provider

Nutrient Control Design Manual



Nutrient Control Design Manual

by

The Cadmus Group, Inc
57 Water Street
Watertown, MA 02472

Scientific, Technical, Research, Engineering, and Modeling Support (STREAMS)
Task Order 68

Contract No. EP-C-05-058

George T. Moore, Task Order Manager
United States Environmental Protection Agency
Office of Research and Development / National Risk Management Research Laboratory
26 West Martin Luther King Drive, Mail Code 445
Cincinnati, Ohio, 45268

Foreword

The U.S. Environmental Protection Agency (EPA) is charged by Congress with protecting the Nation's land, air, and water resources. Under a mandate of national environmental laws, the Agency strives to formulate and implement actions leading to a compatible balance between human activities and the ability of natural systems to support and nurture life. To meet this mandate, EPA's research program is providing data and technical support for solving environmental problems today and building a science knowledge base necessary to manage our ecological resources wisely, understand how pollutants affect our health, and prevent or reduce environmental risks in the future.

The National Risk Management Research Laboratory (NRMRL) is the Agency's center for investigation of technological and management approaches for preventing and reducing risks from pollution that threaten human health and the environment. The focus of the laboratory's research program is on methods and their cost-effectiveness for prevention and control of pollution to air, land water and subsurface resources; protection of water quality in public water systems; remediation of contaminated sites, sediments and ground water; prevention and control of indoor air pollution; and restoration of ecosystems. NRMRL collaborates with both public and private sector partners to foster technologies that reduce the cost of compliance and to anticipate emerging problems. NRMRL's research solutions to environmental problems by: developing and promoting technologies that protect and improve the environment; advancing scientific and engineering information to support regulatory and policy decisions; and providing the technological support and information transfer to insure implementation of environmental regulations and strategies at the national, state, and community levels.

This publication has been produced as part of the Laboratory's strategic long-term research plan. It is published and made available by EPA's Office of Research and Development to assist the user community and to link researchers with their clients.

Sally Gutierrez, Director
National Risk Management Research Laboratory

Notice

This document was prepared by The Cadmus Group, Inc. (Cadmus) under EPA Contract No. EP-C-05-058, Task Order 68. The Cadmus Team was lead by Patricia Hertzler and Laura Dufresne with Senior Advisors Clifford Randall, Emeritus Professor of Civil and Environmental Engineering at Virginia Tech and Director of the Occoquan Watershed Monitoring Program; James Barnard, Global Practice and Technology Leader at Black & Veatch; David Stensel, Professor of Civil and Environmental Engineering at the University of Washington; and Jeanette Brown, Executive Director of the Stamford Water Pollution Control Authority and Adjunct Professor of Environmental Engineering at Manhattan College.

Disclaimer

The views expressed in this document are those of the individual authors and do not necessarily, reflect the views and policies of the U.S. Environmental Protection Agency (EPA). Mention of trade names or commercial products does not constitute endorsement or recommendation for use. This document has been reviewed in accordance with EPA's peer and administrative review policies and approved for publication.

Abstract

The purpose of this EPA design manual is to provide updated, state-of-the-technology design guidance on nitrogen and phosphorus control at municipal Wastewater Treatment Plants (WWTPs). Similar to previous EPA manuals, this manual contains extensive information on the principles of biological nutrient removal and chemical phosphorus removal to serve as the basis for design. A detailed description of technologies, both conventional and emerging, serves as a resource for preliminary technology selection. Because most WWTPs in the United States are equipped with secondary treatment, the focus of this design manual is on retrofits to add nutrient removal to existing WWTPs rather than on new treatment plant design, although guidance for greenfield design is presented. Also new from previous versions, design guidance herein is based on the use of mathematical models and simulators. Simulators allow designers to study kinetic- as well as time-based solutions while determining the total mass balances of many constituents. They have become increasingly powerful, easy to use, and widely accepted for the design of biological nutrient removal facilities. The manual also includes new information on emerging issues in the industry such as sustainability in wastewater treatment design and operation, nutrient recovery and reuse, effluent dissolved organic nitrogen, and measurement of low phosphorus concentrations.

This report was submitted in fulfillment of EPA Contract No. EP-C-05-058, Task Order 68, by The Cadmus Group, Inc. under the sponsorship of the United States Environmental Protection Agency. This report covers a period from November 2007 through April 2010 and represents work completed as of April 2010.

Contents

Acronyms and Abbreviations	xviii
Acknowledgements	xxii
1. Introduction	1-1
1.1 History of Nutrient Removal	1-1
1.2 Purpose and Scope of this Manual	1-3
1.3 Manual Organization	1-5
1.4 References	1-6
2. Need for and Benefits of Nitrogen and Phosphorus Removal.....	2-1
2.1 Introduction	2-1
2.2 Sources of Nitrogen and Phosphorus in Wastewater.....	2-2
2.2.1 Nitrogen	2-2
2.2.2 Phosphorus	2-3
2.3 Status of Wastewater Treatment in the United States	2-3
2.4 Nutrient Impairment of U.S. Waterways.....	2-5
2.4.1 Northern Gulf of Mexico	2-5
2.4.2 Chesapeake Bay	2-6
2.4.3 Great Lakes	2-6
2.4.4 Long Island Sound.....	2-6
2.5 Climate Change Impacts	2-7
2.6 Federal and State Regulations and Initiatives to Reduce Nutrient Pollution	2-8
2.6.1 Water Quality Standards	2-8
2.6.2 Total Maximum Daily Loads (TMDLs)	2-10
2.6.3 NPDES Permitting	2-10
2.6.4 Water Quality Trading	2-11
2.6.5 Technology Evaluation and Guidance.....	2-12
2.7 Industry Initiatives—The WERF Nutrient Removal Challenge.....	2-13
2.8 Benefits of Nutrient Removal	2-14
2.8.1 Improved Plant Performance.....	2-14
2.8.2 Co-Removal of Emerging Contaminants.....	2-14
2.8.3 Nutrient Recovery and Reuse	2-15
2.9 Challenges of Nutrient Removal	2-15
2.9.1 Energy Requirements.....	2-15
2.9.2 Release of Nitrous Oxide	2-17
2.10 References	2-18
3. Principles of Phosphorus Removal by Chemical Addition	3-1
3.1 Introduction	3-1
3.2 Available Forms of Metal Salts and Lime	3-1
3.3 Equations and Stoichiometry.....	3-2
3.3.1 Removable Phosphorus	3-2
3.3.2 Reactions of Metal Salts and Phosphorus	3-2
3.3.3 Reactions of Lime with Phosphorus.....	3-5
3.4 Solids Separation Processes.....	3-5

3.5	Effects on Sludge Production and Handling.....	3-6
3.6	Two Factors that May Limit the Ability of Plants to Achieve Very Low Effluent Levels	3-7
3.7	References	3-8
4.	Principles of Biological Nitrogen Removal	4-1
4.1	Introduction	4-1
4.2	Nitrogen Removal by Biomass Synthesis	4-2
4.3	Microbiology of Nitrification.....	4-3
4.4	Reactions and Stoichiometry of Nitrification.....	4-5
4.5	Nitrification Kinetics.....	4-6
4.5.1	AOB kinetics	4-10
4.5.2	NOB kinetics.....	4-13
4.5.3	Effects of Temperature and Dissolved Oxygen on Nitrification Kinetics	4-14
4.5.4	AOB and NOB Kinetics at High Temperature (SHARON® process)	4-16
4.6	Inhibitory Effects of Environmental Conditions on Nitrification	4-17
4.7	Denitrification Fundamentals	4-20
4.8	Microbiology of Denitrification.....	4-20
4.9	Metabolism and Stoichiometry of Heterotrophic Denitrification	4-21
4.10	Biological Denitrification Kinetics with Influent Wastewater	4-22
4.11	Denitrification Carbon Sources and Relative Consumption Ratios.....	4-24
4.12	Denitrification Kinetics of Exogenous Carbon Sources	4-28
4.12.1	Denitrification Kinetics with Methanol.....	4-28
4.12.2	Alternative Exogenous Substrates and Denitrification Kinetics	4-30
4.12.3	Acclimation Time and Degradative Ability of Denitrifying Bacteria with Exogenous Substrates.....	4-31
4.13	Specific Denitrification Rates (SDNR).....	4-32
4.14	Simultaneous Nitrification-Denitrification.....	4-34
4.15	Metabolism and Stoichiometry and Kinetics of ANAMMOX®	4-35
4.16	Impacts on Sludge Production and Handling.....	4-36
4.17	Effluent Dissolved Organic Nitrogen.....	4-36
4.18	References	4-39
5.	Principles of Biological Phosphorus Removal	5-1
5.1	Overview of the Biological Phosphorus Removal Process.....	5-1
5.2	Substrate Requirements	5-3
5.3	Sources of Volatile Fatty Acids.....	5-5
5.3.1	Fermentation in the Collection System	5-6
5.3.2	Anaerobic Fermentation of Primary or Return Activated Sludge.....	5-7
5.3.3	Commercial Sources	5-10
5.4	Environmental Conditions	5-11
5.4.1	Dissolved Oxygen and Nitrates in the Anaerobic Zone	5-11
5.4.2	Oxygen in the Aerobic Zone.....	5-11
5.4.3	pH	5-12
5.4.4	Temperature	5-12
5.4.5	Cations	5-13
5.5	Kinetics	5-13
5.5.1	Solids Retention Time (SRT).....	5-13

5.5.2	Hydraulic Retention Time (HRT)	5-14
5.6	Important Design and Operational Considerations	5-14
5.6.1	Avoiding Secondary Release of Phosphorus	5-14
5.6.2	Avoiding Backmixing	5-16
5.6.3	Flow and Load Balancing	5-17
5.7	Impacts on Sludge Processing and Handling	5-17
5.8	References	5-18
6.	Overview of Nitrogen and Phosphorus Removal Technologies	6-1
6.1	Introduction	6-1
6.2	Nitrogen Removal Technologies	6-2
6.2.1	Nitrogen Removal in Single Process Unit.....	6-3
6.2.1.1	Modified Ludzack-Ettinger (MLE) Process	6-3
6.2.1.2	4-Stage Bardenpho	6-5
6.2.1.3	MLE or 4-Stage Bardenpho with Membrane Bioractor (MBR)	6-5
6.2.1.4	Sequencing Batch Reactor (SBR).....	6-6
6.2.1.5	Oxidation Ditch with Anoxic Zone	6-7
6.2.1.6	Step Feed Biological Nitrogen Removal (BNR)	6-8
6.2.1.7	Simultaneous Nitrification Denitrification (SNdN)	6-9
6.2.1.8	Integrated Fixed Film Activated Sludge (IFAS).....	6-10
6.2.1.9	Moving Bed Biofilm Reactor (MBBR).....	6-11
6.2.2	Separate Stage Processes—Nitrification	6-12
6.2.2.1	Suspended Growth Nitrification	6-12
6.2.2.2	Attached Growth Nitrification	6-12
6.2.3	Separate Stage Processes—Denitrification	6-13
6.2.3.1	Denitrification Filters	6-14
6.3	Phosphorus Removal Technologies	6-16
6.3.1	Phosphorus Removal by Chemical Addition	6-16
6.3.2	Biological Phosphorus Removal.....	6-19
6.3.2.1	Pho-redox (A/O).....	6-20
6.3.2.2	Oxidation Ditch with Anaerobic Zone.....	6-21
6.4	Combined Nitrogen and Phosphorus Removal Technologies	6-22
6.4.1	Biological.....	6-22
6.4.1.1	3 Stage Pho-redox (A ₂ /O).....	6-22
6.4.1.2	5-Stage Bardenpho	6-23
6.4.1.3	University of Capetown (UCT), Modified UCT, and Virginia Initiative Project (VIP)	6-24
6.4.1.4	Westbank.....	6-26
6.4.1.5	Oxidation Ditch with Anoxic and Anaerobic Zones	6-26
6.4.1.6	Sequencing Batch Reactor (SBR).....	6-27
6.4.2	Hybrid Chemical / Biological.....	6-27
6.4.2.1	Blue Plains Process	6-28
6.4.2.2	Biological-Chemical Phosphorus and Nitrogen Removal (BCFS) Process	6-28
6.5	Effluent Filtration	6-29
6.5.1	Conventional Down-flow Filters	6-29
6.5.2	Continuous Backwashing Upflow Sand Filters (Dynasand)	6-29
6.5.3	Pulsed Bed Filters.....	6-30

6.5.4	Traveling-Bridge Filters	6-30
6.5.5	Discfilters	6-30
6.5.6	Membrane Filters	6-31
6.6	Sidestream Management	6-32
6.7	Technology Performance	6-34
6.7.1	Removal Efficiencies of BNR Technologies – General Discussion.....	6-36
6.7.2	Technology Performance Statistics based on Full-Scale Operating Data ...	6-37
6.8	Factors in Simultaneously Achieving Low Nitrogen and Phosphorus Effluent Concentrations	6-42
6.9	References	6-43
7.	Establishing Design Objectives.....	7-1
7.1	Introduction	7-1
7.2	Characterizing Existing Treatment.....	7-2
7.3	Design Flow Rates	7-3
7.3.1	Characterizing Existing Flow	7-3
7.3.2	Projecting Future Conditions	7-5
7.3.3	Setting Design Flow Rates.....	7-6
7.4	Wastewater characteristics	7-7
7.4.1	Data Collection.....	7-7
7.4.2	Data Verification	7-10
7.5	Target Effluent Concentrations for Total Nitrogen and Total Phosphorus.....	7-15
7.6	Goals for Reliability, Sustainability, and Process Flexibility	7-16
7.7	Sludge Treatment Options.....	7-18
7.8	Site Constraints	7-18
7.9	Selecting an Overall Process Design Factor	7-19
7.10	References	7-20
8.	Selecting Candidate Treatment Processes for Plant Upgrades	8-1
8.1	Introduction	8-1
8.2	Technology Selection Factors	8-1
8.2.1	Seasonal Permit Limits.....	8-1
8.2.2	Footprint	8-2
8.2.3	Hydraulic Considerations.....	8-3
8.2.4	Chemical needs.....	8-3
8.2.5	Available Sludge Treatment and Options	8-3
8.2.6	Energy Considerations	8-4
8.2.7	Staffing and Training Requirements	8-5
8.2.8	Technology Selection Considerations for Small Flow Systems.....	8-5
8.3	Advantages and Disadvantages of Technology Types	8-6
8.4	Overview of Recommended Approach.....	8-8
8.5	Recommended Use of Advanced Tools	8-11
8.6	Patent issues	8-12
8.7	References	8-13
9.	Design Approach for Phosphorus Removal by Chemical Addition	9-1
9.1	Introduction	9-1
9.2	Selecting a Chemical Precipitant.....	9-1

9.2.1	Advantages and Disadvantages of Metal Salts	9-1
9.2.2	Advantages and Disadvantages of Lime	9-3
9.2.3	Costs	9-3
9.3	Selecting Point(s) of Application	9-4
9.4	Determining the Chemical Dose	9-7
9.5	Designing a Chemical Feed System.....	9-10
9.5.1	Liquid feed systems	9-11
9.5.1.1	Storage tanks	9-11
9.5.1.2	Feed Methods.....	9-11
9.5.2	Dry Feed Systems.....	9-12
9.5.2.1	Storage.....	9-12
9.5.2.2	Feed Methods.....	9-13
9.5.2.3	Lime Slaking	9-14
9.6	Designing for Rapid Mix and Flocculation	9-15
9.6.1	Types of Mixers.....	9-15
9.6.2	Design Factors.....	9-17
9.6.2.1	Velocity Gradient	9-17
9.6.2.2	Power Requirements	9-18
9.6.2.3	Hydraulic Retention Time	9-19
9.6.2.4	Vessel Geometry.....	9-20
9.6.3	Summary of Typical Design Parameters	9-20
9.7	Solids Separation Processes.....	9-21
9.7.1	Primary and Secondary Clarification.....	9-22
9.7.2	Tertiary Processes.....	9-22
9.8	Operational Factors	9-22
9.8.1	Dose Control	9-22
9.8.2	Make-up Water.....	9-23
9.8.3	Sludge Production and Handling	9-23
9.8.4	pH Adjustment.....	9-25
9.8.5	Effect on Biosolids Applications.....	9-25
9.9	References	9-25
10.	Design Approach for Biological Nutrient Removal	10-1
10.1	Introduction	10-1
10.2	Preliminary Design Approach	10-3
10.3	Overview of Recommended Approach for Plant Modeling.....	10-5
10.4	Establishing Modeling Objectives and Requirements	10-7
10.4.1	Intended Model Use	10-7
10.4.2	Goals for Model Accuracy.....	10-7
10.4.3	Dynamic vs. Steady State Simulation.....	10-8
10.5	Selecting a Process Simulation Model	10-9
10.6	Data Collection	10-12
10.6.1	Process Configuration.....	10-13
10.6.2	Operating Conditions.....	10-16
10.7	Characterization of Organic Material	10-16
10.7.1	Relationship of Organic Material and Suspended Solids in Wastewater ...	10-20
10.7.2	Methods for Determining COD Fractions	10-22
10.7.3	Data Checks.....	10-25

10.8	Characterization of Nutrient Fractions	10-26
10.8.1	Nitrogen	10-26
10.8.2	Phosphorus	10-29
10.9	Kinetic and Stoichiometric Parameters	10-32
10.10	Calibration	10-33
10.11	Validation	10-37
10.12	Simulation of Design Alternatives for Nutrient Removal	10-38
10.13	Additional Procedures for Design	10-39
10.13.1	Sequencing Batch Reactors (SBRs)	10-39
10.13.2	Denitrification Filters	10-40
10.13.3	Primary Sludge Fermenters	10-41
10.14	Design Checks for Biological Nitrogen and Phosphorus Removal	10-42
10.15	References	10-47
11.	Design Approach for Effluent Filtration	11-1
11.1	Introduction	11-1
11.2	Selection of Filtration Technology	11-2
11.3	Granular Media Filters	11-3
11.3.1	Influent Water Quality	11-4
11.3.2	Media Specifications	11-4
11.3.3	Filter Loading Rate	11-6
11.3.4	Headloss	11-6
11.3.5	Backwash Requirements	11-7
11.3.6	Flow Control	11-9
11.4	Cloth Media Filters	11-10
11.5	Low-Pressure Membranes	11-11
11.5.1	Membrane Material	11-12
11.5.2	Membrane Configuration	11-13
11.5.3	Process Considerations	11-14
11.5.4	Pressure Drop	11-15
11.5.5	Flux Determination	11-15
11.5.6	Performance Data	11-16
11.6	Emerging Filtration Technologies for Phosphorus Removal	11-16
11.6.1	Two-Stage Filtration	11-16
11.6.2	Iron Oxide Coated Media	11-17
11.7	References	11-18
12.	Operation and Optimization to Enhance Nutrient Removal	12-1
12.1	Introduction	12-1
12.2	Analysis of Existing Operations	12-1
12.2.1	Data Analysis	12-2
12.2.2	Use of Process Simulation Models	12-5
12.3	Incorporating SCADA and other Instrumentation	12-6
12.4	Common Operational Changes	12-6
12.4.1	Adjust SRT	12-6
12.4.2	Adjust Aeration Rates	12-7
12.4.3	Add Baffles to Create High Food to Microorganism (F/M) Conditions	12-7
12.4.4	Change Aeration Settings in Plug Flow Basins	12-7

12.4.5	Minimize Impact of Recycle Streams.....	12-8
12.4.6	Reconfigure Flow through Existing Units.....	12-8
12.4.7	Increase VFAs for Biological Phosphorus Removal.....	12-9
12.5	References	12-10
13.	Instrumentation and Controls.....	13-1
13.1	Introduction	13-1
13.2	Factors in Selecting Instrumentation.....	13-2
13.3	Basic Online Instrumentation	13-3
13.3.1	Flow	13-3
13.3.2	Total Suspended Solids (TSS)	13-4
13.3.3	Sludge Blanket Depth.....	13-5
13.3.4	Dissolved Oxygen (DO)	13-5
13.3.5	pH	13-5
13.3.6	ORP	13-6
13.4	Online Instrumentation for Nutrient Control	13-6
13.4.1	Nitrogen Compounds.....	13-6
13.4.2	Phosphate and Total Phosphorus	13-7
13.4.3	NADH (active biomass)	13-8
13.4.3	Respirometry	13-8
13.5	Types of Control.....	13-9
13.5.1	Feed-forward	13-9
13.5.2	Feedback.....	13-10
13.5.3	Feed-forward and feedback.....	13-10
13.5.4	Cascade	13-10
13.5.5	Advanced Control	13-10
13.6	Control Equipment—SCADA.....	13-11
13.7	References	13-13
14.	Sustainable Nutrient Recovery and Reuse.....	14-1
14.1	Introduction	14-1
14.2	Separating and Treating Waste On-Site.....	14-1
14.3	Using Wastewater Treatment Byproducts	14-2
14.3.1	Durham, OR, Advanced Wastewater Treatment Facility.....	14-3
14.3.2	East Bay Municipal Utility District, CA	14-4
14.4	References	14-5

Appendices

- Appendix A. Recommendations for Methanol Safety
- Appendix B. Organic Compounds and Inhibitory Concentrations to Nitrification
- Appendix C. Mathematical Models for Wastewater Treatment

Tables

Table 3-1.	Chemical Precipitants	3-2
Table 4-1.	Phylogeny of Ammonia-Oxidizing Bacteria.....	4-4
Table 4-2.	Phylogeny of Nitrite-Oxidizing Bacteria	4-5
Table 4-3.	Summary of Test Results on Measuring Specific Endogenous Decay Coefficient Rates (All Rates at 20°C).....	4-11
Table 4-4.	Summary of AOB Nitrification Kinetic Coefficient Values.....	4-12
Table 4-5.	Comparison of Nitrification Half-Velocity Coefficients (mg/L) in MBR and Conventional Activated Sludge (CAS) Systems	4-12
Table 4-6.	Summary of NOB Nitrification Kinetic Coefficient Values	4-14
Table 4-7.	NH ₄ -N and NO ₂ -N Concentrations that May Inhibit Nitrification as a Function of pH at 20°C.	4-19
Table 4-8.	Heterotrophic Bacteria Kinetic Coefficients in Anoxic/Aerobic Activated Sludge	4-24
Table 4-9.	Biomass Yields Reported for Exogenous Carbon Sources	4-28
Table 4-10.	Reported Maximum Specific Growth Rates at 20°C and Temperature Coefficients for Methanol Utilization under Anoxic and Aerobic conditions	4-29
Table 4-11.	Reported K _s values for NO ₃ -N reduction with methanol at 20°C.....	4-29
Table 4-12.	Comparison of Maximum Specific Growth rates for Methanol, Acetate, and Corn Syrup at High and Low Temperatures	4-30
Table 4-13.	For BNR Activated Sludge, Ratio of Denitrification Rate with Substrate Addition to Denitrification Rate with No Addition	4-31
Table 4-14.	Ratio of Denitrification Rates for Other Substrates at Day 50 with Ethanol or Methanol Addition Versus no Addition	4-32
Table 4-15.	Range of reported SDNR values in BNR activated sludge treatment	4-33
Table 4-16.	ANAMMOX [®] Bacteria Biokinetic Parameters at 30 ⁰ C	4-35
Table 5-1.	Volatile Fatty Acids Typically Found in Fermented Wastewater	5-4
Table 5-2.	Minimum Ratios for Achieving Total Phosphorus Effluent Concentration of less than 1.0 mg/L.....	5-4
Table 5-3.	Effect of Corrosion and Odor Control Techniques on VFA Production in Wastewater Collection Systems	5-7
Table 6-1.	Matrix of Biological Nitrogen Removal Technologies.....	6-3
Table 6-2.	IFAS Media Types, Applications, and Design Considerations	6-10
Table 6-3.	Matrix of Phosphorus Removal Technologies	6-16
Table 6-4.	Matrix of Combined Biological Phosphorus and Nitrogen Removal Technologies .	6-22
Table 6-5.	Matrix of Tertiary Filtration Technologies	6-29
Table 7-1.	Influent Flow Components	7-4
Table 7-2.	Flow Characterization	7-4
Table 7-3.	Comparison of Flow Rates and Flush Volumes Before and After U.S. Energy Policy Act	7-5
Table 7-4.	Example Permit Limits for Nutrients.....	7-16
Table 8-1.	Advantages and Disadvantages of Technology Types	8-7
Table 8-2.	External Carbon Sources	8-12
Table 8-3.	IFAS Media Types, Applications, and Design Considerations	8-15
Table 9-1.	Advantages and Disadvantages of Common Aluminum and Iron Salts.....	9-2
Table 9-2.	Advantages and Disadvantages of Metal Salt Application Points	9-6

Table 9-3.	Types of Chemical Feeders	9-10
Table 9-4.	Commonly Used Equipment for Rapid Mixing.....	9-16
Table 9-5.	Values of N_p and N_Q for Various Types of Impellers	9-18
Table 9-6.	Typical Design Parameters for Turbine and Propeller Mixer.....	9-21
Table 10-1.	Commonly Used Process Simulators	10-10
Table 10-2.	COD and Particulate Fractions in Municipal Wastewater	10-19
Table 10-3.	TKN Fractions in Municipal Wastewater.....	10-28
Table 10-4.	Total Phosphorus Fractions in Municipal Wastewater	10-31
Table 10-5.	Design Checks for Biological Nitrogen Removal	10-43
Table 10-6.	Design Checks for Biological Phosphorus Removal	10-45
Table 11-1.	Common Filter Media and Characteristics	11-5
Table 11-2.	Filter Media Depths and Particle Sizes	11-5
Table 11-3.	Membrane Characteristics.....	11-14
Table 11-4.	Advantages and Disadvantages of Membrane Materials.....	11-15
Table 11-5.	Phosphorus Removal Reported From Membrane Pilot Studies	11-19
Table 11-6.	Pilot Test Results for the Blue Water Blue PRO® System	11-21
Table 12-1.	Recommended Parameters for Data Evaluation	12-3
Table 13-1.	Summary of Basic On-Line Instrumentation.....	13-2
Table 13-2.	Comparison of Online Nitrate Analyzers	13-7

Figures

Figure 2-1.	Population served by POTWs nationwide for select years between 1940 and 2004 and projected to 2024 (if all needs are met), organized by wastewater treatment type.....	2-5
Figure 2-2.	Water quality-based approach of the Clean Water Act	2-10
Figure 4-1.	Percent nitrogen removal due to biomass synthesis as a function of SRT and influent BOD/N ratio.....	4-3
Figure 4-2.	Effect of SRT and temperature on effluent NH_4^+ -N and NO_2^- -N concentrations using kinetic data in Table 4-6 and 4-4 for CMAS.....	4-15
Figure 4-3.	Effect of DO concentration on effluent NH_4^+ -N and NO_2^- -N concentrations using kinetic data in Table 4-4 and 4-6 and at 15°C for CMAS.	4-15
Figure 4-4.	Effect of temperature on minimal washout SRT AOB, H and NOB, H from Hellinga et al. (1998) and AOB, M and NOB, M from Tables 4-2 and 4-4.....	4-17
Figure 4-5.	Ratio of COD required to NO_3^- -N completely reduce NO_3^- -N (CRNO3) as a function of the biomass yield.	4-26
Figure 5-1.	Theory of BPR in activated sludge.	5-1
Figure 5-2.	BPR at a WWTP	5-3
Figure 5-3.	Biological Pathways of Methane Formation.....	5-8
Figure 5-4.	Example of secondary release in second anoxic zone	5-14
Figure 6-1.	Modified Ludzack-Ettinger (MLE) process.	6-4
Figure 6-2.	4-stage Bardenpho process.	6-5
Figure 6-3.	Common configuration for a membrane bioreactor 4-stage bardenpho treatment system	6-6
Figure 6-4.	Operating periods of a sequencing batch reactor.....	6-7
Figure 6-5.	Example oxidation ditch configuration.....	6-8
Figure 6-6.	Step feed biological nitrogen removal.....	6-7
Figure 6-7.	Downflow denitrification filter.	6-14
Figure 6-8.	Continuous backwash upflow sand (CBUS) filters.....	6-15
Figure 6-9.	Close-up of continuous backwash upflow sand (CBUS) filter.....	6-15
Figure 6-10.	Densadeg® high rate clarification process flow diagram.....	6-18
Figure 6-11.	CoMag™ process flow diagram.	6-19
Figure 6-12.	Pho-redox process (A/O).	6-21
Figure 6-13.	Oxidation ditch with anaerobic zone.....	6-22
Figure 6-14.	3 Stage Pho-redox process (A2/O).....	6-23
Figure 6-15.	5-stage Bardenpho process.	6-24
Figure 6-16.	UCT and Modified UCT process.	6-25
Figure 6-17.	Westbank process.....	6-26
Figure 6-18.	VT2 process schematic.....	6-27
Figure 6-19.	The Blue Plains process.....	6-28
Figure 6-20.	Probability plot of secondary effluent phosphorus data.....	6-39
Figure 6-21.	Technology performance statistics for nitrogen removal plants.....	6-40
Figure 6-22.	Technology performance statistics for phosphorus removal plants.	6-40
Figure 7-1	Net sludge production versus solids retention time and temperature	7-14
Figure 9-1.	Possible application points for chemical addition (C).....	9-4
Figure 9-2.	Schematic of common jar testing apparatus.....	9-9

Figure 9-3.	Typical dry chemical feed system.	9-13
Figure 10-1.	Unified protocol for activated sludge monitoring.	10-6
Figure 10-2.	Essential requirements for wastewater treatment process simulation.	10-13
Figure 10-3.	Example simulator configuration for a biological nutrient removal plant	10-14
Figure 10-4.	COD components for municipal wastewater.....	10-18
Figure 10-5.	Relationship between BOD, COD, TSS, and VSS.	10-21
Figure 10-6.	TKN components for municipal wastewater.	10-27
Figure 10-7.	Phosphorus components in municipal wastewater.	10-30
Figure 11-1.	Upflow continuous backflow filter.	11-11
Figure 11-2.	Operational models of the Fuzzy Filter®.....	11-12
Figure 11-3.	Cutaway view of AquaDisk® cloth media filter.	11-13
Figure 11-4.	Hollow fiber membrane configuration with inside to outside flow.	11-16
Figure 11-5.	Parkson Dynasand D2 advanced filter system.....	11-20
Figure 11-6.	Blue-PRO® process.....	11-21
Figure 12-1.	Spatial and temporal profiles of ammonia	12-5

Acronyms and Abbreviations

A/O	Anaerobic/Oxic, Pho-redox
A2/O	Anaerobic/Anoxic/Oxic, 3 Stage Pho-redox
AMO	Ammonia Monooxygenase
ANAMMOX	Anaerobic Ammonia Oxidation
AOB	Ammonia Oxidizing Bacteria
AS	Activated Sludge
ASCE	American Society of Civil Engineers
ASM	Activated Sludge Model
AT3	Aeration Tank 3
BABE	Bio-Augmentation Batch Enhanced
BAF	Biological Aerated Filter
BAR	Bio-Augmentation Regeneration/Reaeration
BCFS	Biological Chemical Phosphorus and Nitrogen Removal
bDON	Biodegradable Fraction of Dissolved Organic Nitrogen
BHRC	Ballasted High Rate Clarification Processes
BNR	Biological Nutrient Removal
BOD	Biochemical Oxygen Demand
BOD ₅	Biochemical Oxygen Demand (5-day)
BPR	Biological Phosphorus Removal
CCF	Continuous Contact Filtration
CFD	Computational Fluid Dynamic
CIP	Clean in Place
CMAS	Completely-Mixed Activated Sludge
C/N	Carbon to Nitrogen Ratio
COD	Chemical Oxygen Demand
COV	Coefficient of Variation
CR	Consumptive Ratio
CSO	Combined Sewer Overflow
CSTR	Continuous Stirred Tank Reactors
CWA	Clean Water Act
CWSRF	Clean Water State Revolving Fund
DAF	Dissolved Air Flotation
DO	Dissolved Oxygen
DON	Dissolved Organic Nitrogen
DSS	Designated Suspended Solids
EBPR	Enhanced Biological Phosphorus Removal
EDC	Endocrine Disrupting Chemicals
EDTA	Ethylene Diamine Tetraacetic Acid
ENR	Enhanced Nutrient Removal
EPA	U.S. Environmental Protection Agency
FFS	Fixed-film Systems
F/M	Food to Microorganism ratio
FWPCA	Federal Water Pollution Control Act
FWS	Free Water Surface
GAO	Glycogen Accumulating Organism

GMP	Good Modeling Practices
HRSD	Hampton Roads Sanitation District
HRT	Hydraulic Retention Time
iDON	Inert Dissolved Organic Nitrogen
IFAS	Integrated Fixed-Film Activated Sludge
ISF	Intermittent Sand Filter
ISS	Inert Suspended Solids
IWA	International Water Association
JHB	Johannesburg Process
LOT	Limit of Technology
MAUREEN	Mainstream Autotrophic Recycle Enhanced N-removal
MBBR	Moving-Bed Biofilm Reactor
MBR	Membrane Bioreactor
MCL	Maximum Contaminant Level
MF	Microfiltration
MGD	Million Gallons per Day
mg/L	Milligrams per liter
MLE	Modified Ludzack Ettinger
MLSS	Mixed Liquor Suspended Solids
MLVSS	Mixed Liquor Volatile Suspended Solids
MMDF	Maximum Month Design Flow
MUCT	Modified University of Capetown
MWRDGC	Metropolitan Water Reclamation District of Greater Chicago
N	Nitrogen
NF	Nanofiltration
NTU	Nephelometric Turbidity Units
NOAA	National Oceanic and Atmospheric Administration
NOB	Nitrite-Oxidizing Bacteria
NPDES	National Pollutant Discharge Elimination System
NTT	Nitrogen Trading Tool
ORD	EPA Office of Research and Development
ORP	Oxidation Reduction Potential
OSHA	Occupational Safety and Health Administration
OUR	Oxygen Uptake Rate
OWASA	Orange Water and Sewer Authority
OWM	EPA Office of Wastewater Management
P	Phosphorus
PACl	Polyaluminum Chloride
PAH	Polycyclic Aromatic Hydrocarbons
PAO	Phosphate Accumulating Organism
PHA	Poly- β -hydroxy-alkanoate
PHB	Poly- β -hydroxy-butyrate
PHV	Poly-hydroxy valerate
PID	Phased Isolation Ditch
PLC	Programmable Logic Controller
POTW	Publicly Owned Treatment Works
PPCPs	Pharmaceuticals and Personal Care Products
RAS	Return Activated Sludge

RBC	Rotating Biological Contactor
rbCOD	Readily Biodegradable Chemical Oxygen Demand
rDON	Recalcitrant Dissolved Organic Nitrogen
RO	Reverse Osmosis
RSF	Recirculating Sand Filters
SAV	Submerged Aquatic Vegetation
SBCOD	Slowly Biodegradable Chemical Oxygen Demand
SBR	Sequencing Batch Reactors
SCADA	Supervisory Control and Data Acquisition
SCM	Surface Complexation Modeling
SDNR	Specific Denitrification Rate
SHARON	Single Reactor High-Activity Ammonia Removal Over Nitrite
SNdN	Simultaneous Nitrification-Denitrification
SRT	Solids Retention Time
SSO	Sanitary Sewer Overflow
STAC	Chesapeake Bay Program Scientific and Technical Advisory Committee
SWIS	Subsurface Wastewater Infiltration System
TAL	Technology Achievable Limit
TAN	Total Ammonia Nitrogen
TDS	Total Dissolved Solids
TKN	Total Kjeldahl Nitrogen
TMDL	Total Maximum Daily Loads
TN	Total Nitrogen
TP	Total Phosphorus
TSS	Total Suspended Solids
TUDP	Bio-P Model of the Delft University of Technology
UCT	University of Capetown Process
UF	Ultrafiltration
UOSA	Upper Occoquan Sewage Authority
USDA	U.S. Department of Agriculture
USEPA	U.S. Environmental Protection Agency
USGS	U.S. Geological Survey
VFA	Volatile Fatty Acid
VIP	Virginia Initiative Plant
VSS	Volatile Suspended Solids
WAS	Waste Activated Sludge
WEF	Water Environment Federation
WEFTEC	Water Environment Federation Technical Exhibition and Conference
WERF	Water Environment Research Foundation
WQS	Water Quality Standards
WWTP	Wastewater Treatment Plant

Acknowledgements

The principle authors of this document, titled “Nutrient Control Design Manual,” were:

Dr. Clifford Randall, Professor Emeritus of Civil and Environmental Engineering at Virginia Tech and Director of the Occoquan Watershed Monitoring Program

Dr. James Barnard, Global Practice and Technology Leader at Black & Veatch

Dr. H. David Stensel, Professor of Civil and Environmental Engineering at the University of Washington

Laura Dufresne, Senior Engineer, the Cadmus Group, Inc.

EPA technical direction and oversight were provided by Dan Murray, EPA Office of Research and Development, National Risk Management Laboratory.

EPA technical reviews of the document were performed by:

EPA Office of Research and Development

Donald Brown

Douglas Grosse

Richard Brenner

James Smith

Marc Mills

Jeffrey Yang

Edwin Barth

EPA Headquarters

Donald Anderson

Phil Zahreddine

James Wheeler

EPA Regions

David Pincumbe, Region 1

Roger Janson, Region 1

Russ Martin, Region 5

Dave Ragsdale, Region 10

External technical reviews of the document were performed by

Jeanette Brown, Stamford Water Pollution Control Authority

Tanya Spano, Metropolitan Washington Council of Governments (MWWCOG)

S. Joh Kang, Tetra Tech

The following members of the Ohio Water Environment Association:

Dale E. Kocarek, Stantec Consulting, Inc.
William Barhorst, ARCADIS
Dennis P. Meek, DM Engineering
Kim Riddell, City of Delphos
Paul Fletcher, Jones & Henry Engineers
Jason Tincu, City of Xenia
Gary Hickman, City of Columbus
Roger F. Gyger, m²t Technologies
Ted Marten, City of Twinsburg
David Wilson, Butler County Water and Sewer
Karen Harrison, Jordan, Jones, Goulding
Mary Long, Black & Veatch
Robert Hollis, Summit County
Rick Noss, Stantec Consulting
Theping Chen, AECOM
Shaun Beauchesne, Hach Company
David Frank, ARCADIS

The following members of the Water Environment Research Foundation (WERF) Nutrients Challenge Team:

JB Neethling, HDR Engineering, Inc.
Mario Benisch, HDR Engineering, Inc.
Amit Pramanik, WERF

Diagrams for illustration of specific concepts were provided by:

Dr. Clifford Randall, Virginia Tech
Dr. James Barnard, Black and Veatch
Dr. H. David Stensel, University of Washington

1. Introduction

Chapter 1 covers:

- 1.1 History of Nutrient Removal
- 1.2 Purpose and Scope of this Manual
- 1.3 Manual Organization
- 1.4 References

1.1 History of Nutrient Removal¹

Biological nutrient removal (BNR) at wastewater treatment plants (WWTP) began in the early 1960s. Pioneers such as Ludzack and Ettinger (1961) and Wuhrman (1964) made efforts to develop biological nitrogen removal (nitrification-denitrification) wastewater treatment systems. Levin and Shapiro (1965) researched biological phosphorus removal, and developed a patented process for it, known as PhoStrip. However, the systems devised by Ludzack, Ettinger, and Wuhrman, did not utilize an internal recycle to obtain significant utilization of the influent biochemical oxygen demand (BOD), and the proposed biological mechanisms of the PhoStrip process remained controversial because its two final steps were the release of phosphorus from activated sludge under anaerobic conditions and then chemical precipitation of the released phosphorus in a separate reactor.

The major process development breakthroughs for biological removal of both nitrogen and phosphorus utilizing the influent BOD resulted from the work of James Barnard in South Africa in the early 1970s. He first developed a single sludge process configuration with internal recycle that utilized the influent BOD for denitrification (1973). It subsequently became the standard nitrogen removal process for the wastewater industry. It is now known as the modified Ludzack-Ettinger (MLE) process. He also demonstrated that anaerobic-aerobic sequencing of activated sludge, with influent BOD first flowing into the anaerobic zone, was necessary to obtain robust biological phosphorus removal (BPR). This discovery was first published in 1975. Theoretical support that the mechanism was biological and not chemical was supplied by Fuhs and Chen (1975) in the same year. Barnard developed several process configurations for both separate and combined biological removal of nitrogen and phosphorus. A four stage anoxic-aerobic-anoxic-aerobic process designed primarily for nitrogen removal was patented as the Bardenpho Process (1978). The five stage version, created by adding an anaerobic zone as the first stage became known as the Modified Bardenpho Process.

Also during the mid-1970s, an anaerobic-aerobic wastewater treatment configuration was being developed in the United States for control of filamentous growths in activated sludge. This process was patented by Marshall Spector and acquired by Air Products and Chemical, Inc. They learned from Barnard that anaerobic-aerobic sequencing of activated sludge also could be used to accomplish BPR and patented the configuration as the Anaerobic-Oxic (AO) process, which was identical to the Phoredox configuration developed by Barnard in South Africa. They then combined it with an anoxic zone and patented the resulting configuration as the Anaerobic-Anoxic-Oxic (A2/O) process, again identical to a configuration developed by Barnard. At this time, the detrimental impacts of nitrate recycle in return

¹ By Dr. Clifford Randall, Professor Emeritus, Virginia Tech

activated sludge (RAS) to the anaerobic zone on BPR performance was not fully understood, and many of the PhoStrip, Phoredox/A2/O, and Modified Bardenpho plants were removing phosphorus erratically. The South African Government requested that Professor Gerrit Marais and his co-workers at the University of Cape Town investigate and resolve the issue. They developed a modification of the Phoredox/A2/O configuration, dubbed the University of Cape Town (UCT) process, that first sent the RAS to the anoxic zone then added a second internal recycle to recycle denitrified mixed liquor from the effluent of the anoxic zone back to the influent of the anaerobic zone. Based on the supposition that denitrification would occur only in the anoxic zone, a modified version of the UCT process was developed for wastewaters with a high Total Kjeldahl Nitrogen (TKN) to BOD ratio.

BNR was introduced to North America in the early 1980s through implementation of BNR facilities at Kelowna, BC, Canada, and at Orange County, FL. BNR was introduced to the Chesapeake Bay region in 1984 by a seminar and a workshop organized by Dr. Clifford Randall (Virginia Tech) and held at Richmond, VA. Then, working with the Hampton Roads Sanitation District (HRSD) and the Virginia Water Pollution Control Board, a pilot plant study of a high rate UCT process was conducted at the HRSD Lambert's Point primary treatment plant in 1985-86, and followed by full-scale research-demonstrations of the A/O, A2/O and UCT processes at the HRSD York River Plant from 1986-90. Overlapping the York River demonstrations, which resulted in patenting of the Virginia Initiative Plant (VIP) BNR process, were full-scale demonstrations of BNR (both N and P removal) at the Anne Arundel County, MD, Maryland City WWTP, and the Bowie, MD, WWTP. Also overlapping these events were the design and construction of the Mauldin Road WWTP, Greenville, SC, and modification of two plants in Charlotte, NC. North American BNR developments moved rapidly in the late 1980s and early 1990s, resulting in BPR and BNR implementation, design and construction at sites as diverse as the Bonnybrook WWTP, Alberta, Canada, Hillsborough County, FL, Frederick, MD, Atlanta, GA, and modification of the Howard County, MD, WWTP from the PhoStrip to the Phoredox/A2/O configuration.

BNR began to be implemented in Europe on a widespread basis in 1987, first in Germany and The Netherlands, followed by Denmark, Austria, Czech Republic, Italy and France. Schreiber Klarenlagen with their unique Simultech Process wherein BPR, nitrification, and denitrification all occurred simultaneously in one continuous flow reactor was a pace setter in Germany while Kruger, Inc., led the way in Denmark under the guidance of Professor Poul Harremoës and his co-workers at the Danish Institute of Technology.

The engineering art of BNR has progressed towards maturity during the past two decades with the addition of advanced practices such as pre-fermentation of primary sludge to enhance BPR, integration of fixed-film media into activated sludge (IFAS) to enhance nitrogen removal, utilization of biological filters for nitrogen removal, and widespread use of tertiary filters for denitrification and chemical phosphorus removal to lower levels. Recent efforts to develop economical methods for the nutrient removal in sites with limited space for expansion have resulted in the emergence of two innovative technological approaches:

- 1) Technologies such as membrane bioreactors or ballasted flocculation to remove suspended solids to very low concentrations and simultaneously eliminate or greatly reduce the size of secondary settling basins.
- 2) Sidestream processes such as SHARON, ANAMMOX, IN-NITRI and others to either remove nitrogen from ammonia-rich flows from sludge processing or enhance removal in the main stream process.

Nitrogen removal has been widely implemented along the Connecticut coast of Long Island Sound. More stringent effluent standards, typically 3.0 milligrams per liter (mg/L) total nitrogen (TN) and 0.1 or lower mg/L total phosphorus (TP), in regions such as the Chesapeake Bay watershed, coastal areas of North Carolina, Okanagan Lake area of British Columbia, Canada, mid-Colorado and Kalispell, WY, have advanced the art from BNR to enhanced nutrient removal (ENR). A combination of BNR, chemical additions and effluent filtration are typically used to accomplish ENR.

A clear trend of the wastewater treatment industry is a greater emphasis on incorporating elements of recycle, recovery, and reuse into plant design and operation. Sustainable nutrient recovery and reuse is gaining national and international attention as wastewater utilities look for ways to decrease energy costs and greenhouse gas emissions, utilize excess capacity, generate new revenue, and address ever more stringent regulatory requirements. This evolution in thinking is moving wastewater treatment to enhanced energy efficiency and changing the role of wastewater treatment facilities from waste generators to resource providers.

1.2 Purpose and Scope of this Manual

Research and technology development through the mid-70s were the basis for EPA's first design manual for nitrogen control technologies. This document, "Process Design Manual for Nitrogen Control," (EPA, 1975) was published in 1975. This manual covered a broad range of processes that were being evaluated and applied at the time. The intent of the manual was to present design information for technologies that appeared to have a viable, practical application to nitrogen control. Two broad categories of treatment processes were addressed. The first group of processes provides for the conversion of organic and ammonium nitrogen by oxidation to nitrate nitrogen. These processes are biological and are generally referred to as nitrification. The second group of processes removes nitrogen from the wastewater. These processes are also biological, using an anoxic denitrification step with nitrification. Physical/chemical processes were also presented for nitrogen removal, including ion exchange, ammonia stripping, and breakpoint chlorination. Between the publication of the first nitrogen control manual and the update of the manual in 1993, the trend in nitrogen control technology was almost exclusively towards biological processes. Biological processes became proven and well demonstrated and were most efficiently expanded or upgraded for biological nitrification or total nitrogen removal. The focus of the 1993 updated document, "Manual – Nitrogen Control," (EPA, 1993) was on biological/mechanical processes that were finding widespread application for nitrification and nitrogen removal.

In 1971, EPA published its first phosphorus control design manual. This manual, "Process Design Manual for Phosphorus Removal," (EPA, 1971) focused on phosphorus removal methods that involve chemical precipitation. Primarily, the manual focused on the chemical precipitation of phosphorus using salts of aluminum and iron, and lime. The chemical application points addressed in the manual were before primary settling, in the aeration tanks, before final settling, or in a tertiary process. In 1976, "Process Design Manual for Phosphorus Removal" (EPA, 1976) was updated. Specifically, design guidance for phosphorus removal using mineral addition and lime addition before primary settling was revised. Also, guidance for chemical storage, chemical feed systems and residuals handling and disposal was updated. In 1987, EPA published two technical documents that addressed phosphorus control. The first was an update to the 1976 Process Design Manual for Phosphorus Removal (EPA, 1987a). The second was a handbook titled, "Handbook – Retrofitting POTWs for Phosphorus Removal in the Chesapeake Bay Drainage Basin." (EPA, 1987b) The update of the design manual included a major

addition of guidance for biological phosphorus removal. Also, the use of lime addition was not covered in this update due to its loss of popularity in the 80s. The technical guidance provided in the 1987 handbook was focused on the unique phosphorus removal requirements being applied to municipal wastewater treatment plants in the Chesapeake Bay watershed. Because of the varying levels of phosphorus control within the watershed, the handbook included an assessment of technologies for meeting total phosphorus effluent limits of 0.2 mg/L, 0.5 mg/L, 1 mg/L, and 2 mg/L. Because some treatment plants in the Chesapeake Bay watershed need to control both nitrogen and phosphorus, the handbook included a chapter titled, “Compatibility of Chemical and Biological Phosphorus Removal with Nitrogen Control.”

In 2007, EPA initiated the process to develop updated design guidance for both nitrogen and phosphorus removal at municipal WWTPs. The first step was an extensive, state-of-the-technology review of nitrogen and phosphorus control technologies and techniques currently applied and emerging at municipal wastewater treatment plants. This technology review culminated with the publication of the “Nutrient Control Design Manual: State of the Technology Review Report” (USEPA 2009) as an interim document in the development of the updated design manuals.

The purpose of this EPA design manual is to provide updated, state-of-the-technology design guidance on nitrogen and phosphorus control at municipal WWTPs to wastewater utility owners and operators, state and EPA permit writers, and environmental engineering professionals. Similar to previous EPA manuals, this manual includes extensive information on the principles of biological nutrient removal and chemical phosphorus removal to serve as the basis for design. A detailed description of technologies, both conventional and emerging, serves as a resource for preliminary technology selection. The manual presents new information on emerging issues in the industry such as sustainability in wastewater treatment design and operation, nutrient recovery and reuse, effluent dissolved organic nitrogen, and measurement of low phosphorus concentrations. Although this manual provides some examples of proprietary and emerging technologies, EPA recognizes that the industry is continually evolving and that new technologies not identified in this manual may emerge in the future.

Because the majority of WWTPs in the United States are equipped with secondary biological treatment, the focus of this design manual is on process and technology modifications/additions for nutrient removal **at existing WWTPs** rather than on new treatment plant design, although guidance for greenfield design is presented. Also new from previous versions, design guidance herein is based on the use of mathematical models and simulators. Simulators allow designers to study kinetic- as well as time-based solutions while determining the total mass balances of many constituents. They have become increasingly powerful, easy to use, widely accepted, and recommended by WEF and ASCE (2010) for the design of biological nutrient removal facilities. Earlier versions of EPA nutrient control manuals (USEPA 1993; USEPA 1987a; USEPA 1987b) still contain very useful guidance (including examples) on process design using hand calculations that can be used for very preliminary sizing or checks on simulation results.

This manual compliments detailed cost data and in-depth facility case studies published in *the Municipal Nutrient Removal Technologies Reference Document* (USEPA 2008a) and analysis of emerging technologies for nutrient removal presented in the *Emerging Technologies Report on Wastewater Treatment* (USEPA 2008b). Both documents are available for download from EPA’s website at <http://www.epa.gov/OWM/mtb/publications.htm>

1.3 Manual Organization

This design manual has 14 chapters and 3 appendices. It is generally organized with the theory of nutrient removal presented first followed by a description of nutrient removal technologies; guidance on establishing design objectives and selecting candidate treatment processes; and design approaches for chemical phosphorus removal, biological nutrient removal, and effluent filtration. Later chapters describe operational improvements for enhancing technology performance and guidance on instrumentation and controls. The last chapter, Chapter 14, discusses sustainable recovery and reuse. A more detailed description of each chapter is provided below.

- **Chapter 2. Need for and Benefits of Nitrogen and Phosphorus Removal** provides background information on sources of nitrogen and phosphorus in wastewater. It reviews the status of wastewater treatment in the U.S., the impairment of waterways by excessive nutrients, government and industry initiatives to reduce nutrient pollution, and the additional benefits and challenges of nutrient removal.
- **Chapter 3. Principles of Phosphorus Removal by Chemical Addition** describes the available forms of metal salts and lime and their reactions with phosphorus. It provides a general description of solids separation process and the effects of various treatment options on sludge production and handling.
- **Chapter 4. Principles of Biological Nitrogen Removal** examines the fundamental microbiology behind nitrification and denitrification including stoichiometrics and kinetics. It discusses denitrification kinetics with internal and external carbon sources. Simultaneous nitrification-denitrification and potential impacts on sludge handling are also discussed.
- **Chapter 5. Principles of Biological Phosphorus Removal** provides a detailed discussion of the biological phosphorus removal process including kinetics, substrate requirements, environmental conditions, design and operational considerations, and impacts on sludge processing and handling.
- **Chapter 6. Overview of Nitrogen and Phosphorus Removal Technologies** describes the technologies available for removing nitrogen, phosphorus, or both from wastewater. Diagrams are provided for most technologies. It presents information on technology performance including design and operational factors affecting a plant's ability to achieve low effluent concentrations.
- **Chapter 7. Establishing Design Objectives** summarizes this critical step in upgrading or retrofitting an existing WWTP. It provides guidance on establishing design flow rates, characterizing flow and contaminants in influent wastewater including detailed sampling methodologies and data verification steps, and setting goals for process reliability, sustainability, and flexibility. The chapter also describes solids handling options and site constraints.
- **Chapter 8. Selecting Candidate Treatment Processes for Plant Upgrades** describes technology selection factors including treatment goals, available footprint, hydraulic considerations, chemical needs, solids processing capabilities, and energy considerations. It summarizes advantages and disadvantages of different technology types. It also provides an overview of a recommended approach to technology selection and discusses use of advanced tools.

- **Chapter 9. Design Approach for Phosphorus Removal by Chemical Addition** provides guidelines on selecting a chemical precipitant, choosing application points, and determining chemical dose. It provides detailed guidance on designing a chemical feed system and considerations for rapid mix, flocculation, and solids separation processes to maximize phosphorus removal.
- **Chapter 10. Design Approach for Biological Nutrient Removal** presents a step-by-step approach for designing wastewater treatment upgrades for nutrient removal using mathematical models. It provides practical recommendations for data collection and evaluation and model calibration. It includes design checks for nitrogen and phosphorus removal. This chapter also provides an alternative design approach using hand or spreadsheet calculations that designers can use to prepare rough estimates and/or to check model outputs.
- **Chapter 11. Design Approach for Effluent Filtration** discusses the options in filtration technology for effluent polishing and nutrient removal. It provides design guidance on granular media filters and alternative technologies such as cloth filters, disk filters, and membranes. Information on emerging filtration technologies for removal of phosphorus to low effluent concentrations is also provided.
- **Chapter 12. Operation and Optimization to Enhance Nutrient Removal** includes information on how to optimize the performance of existing operations by incorporating SCADA and other instrumentation. The chapter also discusses common operational changes to improve system performance and enhance the cost effectiveness of treatment processes.
- **Chapter 13. Instrumentation and Controls** discusses online instrumentation for nutrient control including automated control and optimization, advanced automated control, and SCADA equipment, all of which can lead to better process optimization and more stable technology performance.
- **Chapter 14. Sustainable Nutrient Recovery and Reuse** examines the latest advances in nutrient recovery including separating and treating waste on-site and how to use wastewater treatment byproducts to decrease energy costs and greenhouse gas emissions, take advantage of excess capacity, and generate new revenue.

The manual is supported by three technical appendices containing recommendations on methanol safety (Appendix A), a list of organic compounds and inhibitory concentrations to nitrification (Appendix B), and background information on mathematical models for biological nutrient removal (Appendix C).

1.4 References

- Barnard, J. L. 1973. Biological Denitrification. *Journal of Water Pollution Control* 72(6):705-720.
- Barnard, J. L. 1975. Nutrient Removal in Biological Systems. *Journal of Water Pollution Control*, 143-154.
- Barnard, J. L. 1978. The Bardenpho Process. In: *Advances in Water and Wastewater Treatment Biological Nutrient Removal*. M.P. Wanielista and W.W. Eckenfelder, Jr. (eds.), Ann Arbor Science, Ann Arbor, MI.

- Fuhs, G.W. and M. Chen. 1975. Microbiological Basis of Phosphate Removal in the Activated Sludge Process for the Treatment of Wastewater. *Microbial Ecology*. 2(2): 119-38
- Levin, G.V. and J. Shapiro. 1965. Metabolic Uptake of Phosphorus by Wastewater Organisms. *Journal of the Water Pollution Control Federation (JWPCF)*, 37 (6): 800-821.
- Ludzack, F. J., and M. B. Ettinger. 1961. Controlling Operation to Minimize Activated Sludge Effluent Nitrogen. *Journal of the Water Pollution Control Federation (JWPCF)*, 34(9):920-931, 1961
- Wuhrman, K. 1964. Nitrogen Removal in Sewage Treatment Processes. *Verhandlungenden Internationalen Verein Limnologie*, 15:580-596, 1964.
- USEPA. 1971. *Process Design Manual for Phosphorus Removal*. October 1971.
- USEPA. 1975. *Process Design Manual for Nitrogen Control*. October 1975.
- USEPA. 1976. *Process Design Manual for Phosphorus Removal*. EPA/625/1-76-001a, April 1976.
- USEPA. 1987a. *Design Manual – Phosphorus Removal*. EPA/625/1-87/001, September 1987.
- USEPA. 1987b. *Handbook – Retrofitting POTWs for Phosphorus Removal in the Chesapeake Bay Drainage Basin*. EPA/625/6-87/017, September 1987.
- USEPA. 1993. *Manual – Nitrogen Control*. EPA/625/R-93/010, September 1993.
- USEPAb. 2008a. *Municipal Nutrient Removal Technologies Reference Document*. Office of Wastewater Management, Municipal Support Division. EPA 832-R-08-006. Available online: <http://www.epa.gov/OWM/mtb/publications.htm>
- USEPA. 2008b. *Emerging Technologies for Wastewater Treatment and In-Plant Wet Weather Management*. EPA 832-R-06-006. Available online: http://www.epa.gov/OW-OWM.html/mtb/emerging_technologies.pdf
- USEPA. 2009. *Nutrient Control Design Manual: State of Technology Review Report*. Office of Research and Development. EPA/600/R-09/012. January 2009. Available online at <http://www.epa.gov/nrmrl/pubs/600r09012/600r09012.pdf#22>

This page left intentionally blank

2. Need for and Benefits of Nitrogen and Phosphorus Removal

Chapter 2 covers:

- 2.1 Introduction
- 2.2 Sources of Nitrogen and Phosphorus in Wastewater
- 2.3 Status of Wastewater Treatment in the United States
- 2.4 Nutrient Impairment of U.S. Waterways
- 2.5 Climate Change Impacts
- 2.6 Federal and State Regulations and Initiatives to Reduce Nutrient Pollution
- 2.7 Industry Initiatives—the WERF Removal Challenge
- 2.8 Benefits of Nutrient Removal
- 2.9 Challenges of Nutrient Removal
- 2.10 References

2.1 Introduction

The harmful effects of eutrophication due to excessive nitrogen and phosphorus concentrations in the aquatic environment have been well documented. Algae and phytoplankton growth can be accelerated by higher concentrations of nutrients, leading to harmful algal blooms, hypoxia, and loss of submerged aquatic vegetation (SAV). Depending on the specific water body characteristics, either nitrogen or phosphorus can be limiting (i.e., present in the smallest amount compared to growth requirements). In addition to stimulating eutrophication, nitrogen in the form of ammonia can exert a direct demand on dissolved oxygen (DO) and can be toxic to aquatic life. Even if a wastewater treatment plant (WWTP) converts ammonia to nitrate by a biological nitrification process, the resultant nitrate can stimulate algae and phytoplankton growth.

From a public health perspective, eutrophication may also cause risks to human health, resulting from consumption of shellfish contaminated with algal toxins or direct exposure to waterborne toxins. Eutrophication, in particular, can create problems if the water is used as a source of drinking water. Chemicals used to disinfect drinking water will react with organic compounds in the source water to form disinfection byproducts, which are potential carcinogens and are regulated by the USEPA. Excess levels of nitrates above the maximum contaminant level (MCL) in drinking water (10 ppm) can cause numerous negative health effects due to the body's conversion of nitrate to nitrite, including serious illness and sometimes death. Infants in particular are susceptible to these effects, which can interfere with the oxygen-carrying capacity of the blood. This interference can lead to an acute condition in which health deteriorates rapidly over a period of days. Symptoms include shortness of breath and blueness of the skin (methemoglobinemia; also known as "Blue-baby Syndrome").

For these reasons, it is important to limit nitrogen and phosphorus contamination of surface and ground water. One way to minimize this contamination is to reduce levels of nitrogen and phosphorus in wastewater treatment plant effluent. This chapter will discuss the various sources of these

contaminants, the impacts they have in the environment, initiatives that are being taken to reduce these pollutants, and the benefits that can be realized by these efforts.

2.2 Sources of Nitrogen and Phosphorus in Wastewater

This section provides an overview of the sources of nitrogen and phosphorus in wastewater.

2.2.1 Nitrogen

Nitrogen is an essential nutrient for plants and animals. Approximately 80 percent of the Earth's atmosphere is composed of nitrogen, and it is a key element of proteins and cells. The major contributors of nitrogen to wastewater are human activities such as food preparation, showering, and waste excretion. The per capita contribution of nitrogen in domestic wastewater is about one-fifth of that for biochemical oxygen demand (BOD). Total nitrogen in domestic wastewater typically ranges from 20 to 70 mg/L for low to high strength wastewater (Tchobanoglous et al. 2003). Factors affecting concentration include the extent of infiltration and the presence of industries. Influent concentration varies during the day and can vary significantly during rainfall events, as a result of inflow and infiltration to the collection system.

The most common forms of nitrogen in wastewater are:

- Ammonia (NH_3)
- Ammonium ion (NH_4^+)
- Nitrite (NO_2^-)
- Nitrate (NO_3^-)
- Organic nitrogen

Total Kjeldahl Nitrogen (TKN) is a common nitrogen measurement parameter. This measurement combines ammonium and organic nitrogen, i.e. reduced forms of nitrogen. It also is typically equal to the total nitrogen (TN) in wastewaters influent to sewage treatment plants because conditions in sewers usually result in the reduction of all oxidized forms of nitrogen. However, this is not true in some collection systems, notably those in steep terrains where sheet flow may dominate flow in the sewers, resulting in aeration of the sewage and the formation of nitrates during flow. The oxidized forms of nitrogen must be measured in addition to TKN to determine influent TN for such collection systems.

Nitrogen in domestic wastewater consists of approximately 60 to 70 percent ammonia-nitrogen and 30 to 40 percent organic nitrogen (Tchobanoglous et al. 2003; Crites and Tchobanoglous 1998). Most of the ammonia-nitrogen is derived from urea, which breaks down rapidly to ammonia in wastewater influent.

WWTPs designed for nitrification and denitrification can remove 80 to 95 percent of inorganic nitrogen, but the removal of organic nitrogen is typically much less efficient (Pehlivanoglu-Mantas and Sedlak, 2006). Domestic wastewater organic nitrogen may be present in particulate, colloidal, or dissolved forms and consist of proteins, amino acids, aliphatic N compounds, refractory natural compounds in drinking water (e.g., humic substances), or synthetic compounds (e.g., ethylene diamine tetraacetic acid (EDTA) and textile dyes). Organic nitrogen may be released in secondary treatment by microorganisms either through metabolism or upon death and lysis. Some nitrogen may be contained in

recondensation products. Hydrolysis of particulate and colloidal material by microorganisms releases some organic nitrogen as dissolved, biodegradable compounds. Amino acids are readily degraded during secondary biological treatment, with 90 to 98 percent removal in activated sludge systems and 76 to 96 percent removal in trickling filters. However, other forms of organic nitrogen may be more persistent in wastewater treatment processes.

The importance of the organic nitrogen fraction has increased as effluent limits on nitrogen have become more stringent. With more impaired waterways from nutrient loads, effluent limits for total nitrogen (TN) concentrations of 3.0 mg/L or less are becoming more common. The dissolved organic nitrogen (DON) concentration in the effluent from biological nutrient removal (BNR) treatment facilities was found to range from 0.50 to 1.50 mg/L in 80 percent of 188 plants reported by Pagilla (STAC-WERF 2007), and values as high as 2.5 mg/L were observed. Thus, for systems without effluent filtration or membrane bioreactors (MBRs) that are trying to meet a TN treatment goal of 3.0 mg/L, the effluent DON contribution can easily be 20 to 50 percent of the total effluent nitrogen concentration, compared to only about 10 percent for conventional treatment (Pehlivanoglu-Mantas and Sedlak 2004). See Chapter 4 of this manual for additional discussion of effluent DON and its implications for nutrient removal.

2.2.2 Phosphorus

Total phosphorus (TP) in domestic wastewater typically ranges between 4 and 8 mg/L but can be higher depending on industrial sources, water conservation, or whether a detergent ban is in place. Sources of phosphorus are varied. Some phosphorus is present in all biological material, as it is an essential nutrient and part of a cell's energy cycle. Phosphorus is used in fertilizers, detergents, and cleaning agents and is present in human and animal waste.

Phosphorus in wastewater is in one of three forms:

- Phosphate (also called Orthophosphate)
- Polyphosphate
- Organic phosphorus

The orthophosphate fraction is soluble and can be in one of several forms (e.g., phosphoric acid, phosphate ion) depending on the solution pH. Polyphosphates are high-energy, condensed phosphates such as pyrophosphate and trimetaphosphate. They are also soluble but will not be precipitated out of wastewater by metal salts or lime. They can be converted to phosphate through hydrolysis—which is very slow—or by biological activity.

Organic phosphorus can be soluble, colloidal or particulate, i.e. settleable. It can also be divided into biodegradable and non-biodegradable fractions. Particulate and colloidal organic phosphorus is generally settled or precipitated out and removed with the sludge. Soluble organic biodegradable phosphorus can be hydrolyzed into orthophosphate during the treatment process. Soluble organic non-biodegradable phosphorus will pass through a WWTP. Assuming an influent TP of 6 -8 mg/L, a typical wastewater will contain 3 to 4 mg/L phosphorus as phosphate, 2 to 3 mg/L as polyphosphate, and 1 mg/L as organically bound phosphorus (WEF and ASCE 2006).

2.3 Status of Wastewater Treatment in the United States

The 1972 Amendments to the Federal Water Pollution Control Act (FWPCA) (Public Law 92-500), also known as the Clean Water Act (CWA), established the foundation for wastewater discharge control in the United States. The CWA's primary objective is to "restore and maintain the chemical, physical, and biological integrity of the Nation's waters." The CWA established a program to ensure clean water by requiring permits that limit the amount of pollutants discharged by all municipal and industrial dischargers into receiving waters. Discharges are regulated under the National Pollutant Discharge Elimination System (NPDES) permit program. As of 2004, there were 16,583 municipal wastewater treatment plants [also known as Publicly Owned Treatment Works (POTWs)] regulated under the CWA, serving approximately 75 percent of the nation's population (U.S. Public Health Service and USEPA 2008) with the remaining population served by septic or other decentralized (cluster) systems.

Wastewater treatment has generally been defined as containing one or more of the following four processes: (1) preliminary, (2) primary, (3) secondary, and (4) advanced (or tertiary) treatment. Preliminary treatment consists of grit removal, which removes dense inert particles, and screening to remove rags and other large debris. Primary treatment involves gravity settling tanks to remove settleable solids, including settleable organic solids. The performance of primary settling tanks can be enhanced by adding chemicals to capture and flocculate smaller solid particles for the precipitation and removal of phosphorus. Secondary treatment follows primary treatment in most plants and employs biological processes to remove colloidal and soluble organic matter. Effluent disinfection is usually included in the definition of secondary treatment.

EPA classifies advanced treatment as "a level of treatment that is more stringent than secondary or produces a significant reduction in conventional, non-conventional, or toxic pollutants present in the wastewater" (U.S. Public Health Service and USEPA 2008). Other technical references subdivide advanced treatment, using the terms "secondary with nutrient removal" when nitrogen, phosphorus, or both are removed and "tertiary removal" to refer to additional reduction in solids by filters or microfilters (Tchobanoglous et al. 2003). Effluent filtration and nutrient removal are the most common advanced treatment processes.

The CWA requires that all municipal WWTP discharges meet a minimum of secondary treatment. Based on data from the *2004 Clean Watersheds Needs Survey*, 16,543 municipal WWTPs (99.8 percent of plants in the country) meet the minimum secondary wastewater treatment requirements. Of those that provide at least secondary treatment, approximately 44 percent (7,322 plants) provide some kind of advanced treatment (U.S. Public Health Service and USEPA 2008). Figure 2-1 shows how secondary and advanced wastewater treatment has been implemented since 1940 and also provides projected treatment for 2024. Note that "No Discharge" refers to systems that do not discharge treated wastewater to the nation's waterways but instead dispose of wastewater via methods such as industrial reuse, irrigation, or evaporation.

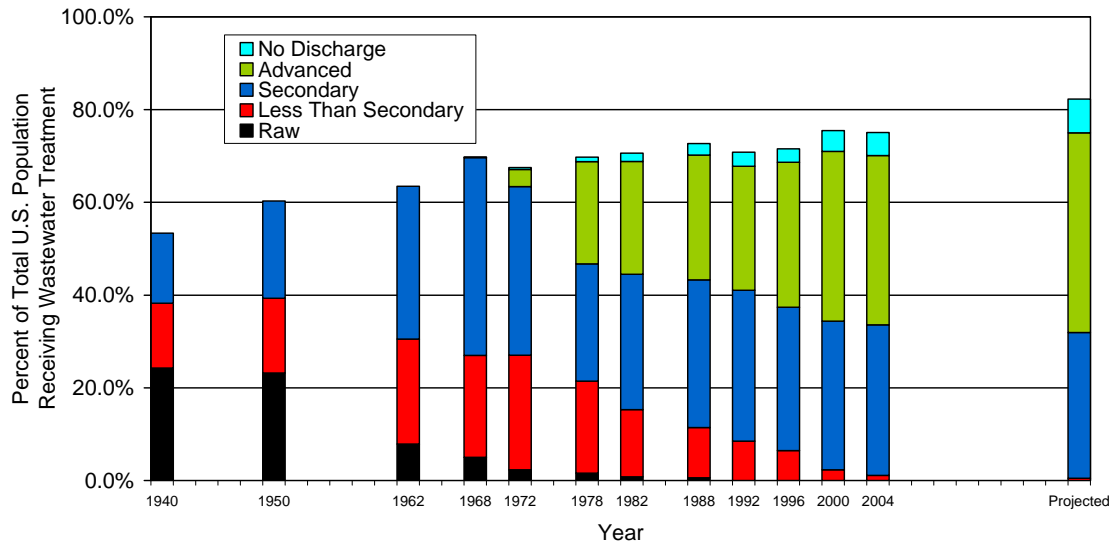

Figure 2-1. Population served by POTWs nationwide for select years between 1940 and 2004 and projected to 2024 (if all needs are met), organized by wastewater treatment type. Source: U.S. Public Health Service and USEPA Clean Watersheds Needs Surveys 2004 Report to Congress (U.S. Public Health Service and USEPA 2008).

2.4 Nutrient Impairment of U.S. Waterways

According to the 2007 report *Effects of Nutrient Enrichment in the Nation's Estuaries: A Decade of Change*, increased nutrient loadings promote a progression of symptoms that begin with excessive growth of phytoplankton and macroalgae and advance to the point where grazers cannot control growth (Bricker et al., 2007). These blooms may be problematic, potentially lasting for months at a time and blocking sunlight to light-dependent SAV. In addition to increased growth, changes in naturally occurring ratios of nutrients may also affect which species dominate, potentially leading to nuisance/toxic algal blooms. These blooms may also lead to other, more serious symptoms that affect biota, such as low DO and loss of SAV. Once water column nutrients have been depleted by phytoplankton and macroalgae and these blooms die, the bacteria decomposing the algae then consume oxygen, making it less available to surrounding aerobic aquatic life. Consequently, fish and invertebrate kills may occur due to hypoxia and anoxia (conditions of low to no DO).

Four examples of impaired large water bodies impacted by nutrient loadings are described below. There are more than 80 additional estuaries and bays, and thousands of rivers, streams, and lakes that are also impacted by nutrients in the United States. In fact, all but one state and two territories have CWA section 303(d) listed¹ water body impairments for nutrient pollution. Collectively, states have listed over 10,000 nutrient and nutrient-related impairments.

2.4.1 Northern Gulf of Mexico

Advanced eutrophic conditions can lead to “dead zones” with limited aquatic life, which describes the hypoxia condition that exists in the Northern Gulf of Mexico. A recent U.S. Geological Survey (USGS) report titled *Differences in Phosphorus and Nitrogen Delivery to the Gulf of Mexico from*

¹ Required by Section 303(d) of the CWA, the 303(d) list is a list of state's water bodies that do not meet or are not expected to meet applicable Water Quality Standards with technology-based controls alone.

the Mississippi River Basin documents the contribution of nitrogen and phosphorus from agricultural and non-agricultural sources in the Mississippi River basin (Alexander et al. 2008). On June 16, 2008, the joint federal-state Mississippi River/Gulf of Mexico Watershed Nutrient Task Force released its *2008 Action Plan for Reducing, Mitigating, and Controlling Hypoxia in the Northern Gulf of Mexico and Improving Water Quality in the Mississippi River Basin*, which builds upon its 2001 plan by incorporating emerging issues, innovative approaches, and the latest science, including findings from EPA's Science Advisory Board. Improvements include more accountability through an Annual Operating Plan, better tracking of progress, state and federal nutrient reduction strategies, and a plan to increase awareness of the problem and implementation of solutions (USEPA 2008c).

2.4.2 Chesapeake Bay

Nutrient pollution has caused significant problems in the Chesapeake Bay. Elevated levels of both nitrogen and phosphorus are the main causes of poor water quality and loss of aquatic habitats in the Bay. Significant algae blooms on the water surface block the sun's rays from reaching underwater bay grasses. Without sunlight, bay grasses cannot grow and provide critical food and habitat for blue crabs, waterfowl, and juvenile fish. Created in 1983, the Chesapeake Bay Program (CBP) is a comprehensive cooperative effort by federal, state, and local governments; nongovernmental organizations; academics; and other entities that share the mission of restoring and protecting the Chesapeake Bay and its watershed. The CBP estimates that 22 percent of the phosphorus loading and 19 percent of the nitrogen loading in the Bay comes from municipal and industrial wastewater facilities (Chesapeake Bay Program, 2008).

To address the need to decrease these pollutants and restore the health of the Bay, the US EPA Chesapeake Bay Office (CBO), along with its partners, developed the Chesapeake Action Plan (CAP), which included goals for the year 2000. The CAP provided a strategic framework that unified CBP's existing planning documents and clarified how CBP partners would pursue the restoration and protection goals for the Bay and its watershed; created an activity integration plan with comprehensive, quality assured data for 2007 that identifies and catalogs CBP partners' implementation activities and corresponding resources; and provided high-level summaries of key information, such as clear status of progress, expected progress toward certain *Chesapeake 2000* goals, summaries of actions and funding, and a brief summary of the challenges and actions needed to expedite progress. A summary of the progress to date can be found in a July 2008 Report to Congress: *Strengthening the Management, Coordination, and Accountability of the Chesapeake Bay Program*. To date, uniform water quality standards have been adopted across the Bay, an aggressive permitting approach for WWTPs has been established, the most cost-effective agricultural best management practices (BMPs) have been implemented, and forests and wetlands surrounding the Bay have been restored.

2.4.3 Great Lakes

The Great Lakes were the first bodies of water to attract national attention to the problem of nutrient caused eutrophication. In the 1960s, Lake Erie was declared "dead" when excessive nutrients in the Lake stimulated excessive algae blooms that covered beaches and killed off native aquatic species as a result of oxygen depletion. At that time, phosphorus was the primary nutrient of concern due to the use of phosphate detergents and inorganic fertilizers. Algal assays showed that phosphorus was the limiting nutrient in the Lakes, which is typical for fresh water bodies. Thus, the focus was on the control of phosphorus. With the enactment of the CWA and the Great Lakes Water Quality Agreement in 1972,

a concerted effort was undertaken to reduce pollutant loadings, particularly phosphorus, to the Lake. Although the health of the Lake improved dramatically, in recent years, there has been renewed attention to the re-emergence of a “dead” zone in Lake Erie, again due to nutrient loadings. Recent studies by scientists and the National Oceanic and Atmospheric Administration (NOAA) have also hypothesized a relationship between excessive nutrients in the Lake and the presence of two aquatic invasive species—the zebra mussel and the quagga mussel (Vanderploeg et al. 2002).

2.4.4 Long Island Sound

Development and population increases in the Long Island Sound Watershed have resulted in a significant increase in nitrogen loading, the current limiting nutrient to the Sound. The increased nitrogen loads have stimulated plant growth, increased the amount of organic matter settling to the benthic zone, lowered DO levels, and changed habitats. The primary concerns in the Sound include hypoxia, the loss of sea grass, and alterations in the food web. Management efforts are currently underway to reduce nitrogen pollution by more than half with a focus on two areas: (1) upgrading WWTPs with new technologies and (2) removing nitrogen by reducing polluted run-off through BMPs on farms and suburban areas (Long Island Sound Study 2004). The emphasis has been primarily on reducing nitrogen discharges, but in recent years phosphorus limitations have been placed on upstream WWTPs discharging to rivers that discharge into the Sound.

2.5 Climate Change Impacts

Climate change may also be a significant influence on the development of future eutrophic symptoms. According to the report *Effects of Nutrient Enrichment in the Nation’s Estuaries: A Decade of Change*, the factors associated with climate change that are expected to have the greatest impacts on coastal eutrophication are:

- Increased temperatures
- Sea level rise
- Changes in precipitation and freshwater runoff

Increased temperatures will have several effects on coastal eutrophication. Most coastal species are adapted to a specific range of temperatures. Increases in water temperatures may lead to expanded ranges of undesirable species. Higher temperatures may also lead to increased algal growth and longer growing seasons, potentially increasing problems associated with excessive algal growth and nuisance/toxic blooms. Additionally, warmer waters hold less DO, therefore potentially exacerbating hypoxia. Temperature-related stratification of the water column may also worsen, having a further negative effect on DO levels.

Climate change models predict increased melting of polar icecaps and changes in precipitation patterns, leading to sea level rise and changes in water balance and circulation patterns in coastal systems. Sea level rise will gradually inundate coastal lands, causing increased erosion and sediment delivery to water bodies, and potentially flooding wetlands. The increased sediment load and subsequent turbidity increase may cause SAV loss. As erosion increases, sediment-associated nutrients also increase, stimulating algal growth. This positive feedback between increased erosion and algal growth may also increase turbidity. The loss of wetlands, which act as nutrient sinks, will further increase nutrient delivery to estuaries. In contrast, an increase in freshwater inflow may reduce

residence time of pollutants, reducing the probability of blooms in some systems. In regions of engineered water flow (e.g., South Atlantic and Gulf of Mexico), the impacts of changes in the amount of runoff will depend on how water management strategies control regional hydrology.

Another report titled *Aquatic Ecosystems and Global Climate Change — Potential Impacts on Inland Freshwater and Coastal Wetland Ecosystems in the United States* notes that climate change of the magnitude projected for the United States over the next 100 years will cause significant changes to temperature regimes and precipitation patterns across the nation (Poff et al. 2002). Such alterations in climate pose serious risks for inland freshwater ecosystems (lakes, streams, rivers, wetlands) and coastal wetlands, and may adversely affect numerous critical services provided to human populations.

2.6 Federal and State Regulations and Initiatives to Reduce Nutrient Pollution

This section describes the following Federal and state regulations and initiatives to reduce nutrient pollution:

- Water Quality Standards (WQSs)
- Total Maximum Daily Loads (TMDLs)
- National Pollution Discharge Elimination System (NPDES) Permitting
- Water quality trading
- Technology evaluations and guidance

In addition to these efforts, state and EPA surface water and drinking water program managers formed an ad hoc Nutrient Innovations Task Group in October 2008 to “identify and frame key nutrient issues, questions, and options on how to improve and accelerate nutrient pollution prevention and reduction at the state and national level” (State-EPA Nutrient Innovations Task Group, 2009). Their final report is available online at <http://www.epa.gov/waterscience/criteria/nutrient/>.

2.6.1 Water Quality Standards

Water quality standards (WQS) are the foundation of the water quality-based pollution control program mandated by the CWA. WQS define the goals for a water body by designating its uses, setting criteria to protect those uses, and establishing provisions to protect water bodies from pollutants. The WQS regulation requires that states and authorized Indian tribes specify appropriate water uses to be achieved and protected. Appropriate uses are identified by considering the use and value of the water body for public water supply; for protection of fish, shellfish, and wildlife; and for recreational, agricultural, industrial, and navigational purposes. In designating uses for a water body, states and tribes examine the suitability of a water body for the uses based on the physical, chemical, and biological characteristics of the water body; its geographical setting and scenic qualities; and economic considerations.

States and tribes typically adopt both numeric and narrative criteria. Numeric criteria are important where the cause of toxicity is known or for protection against pollutants with potential human health effects. Narrative criteria are also important—narrative “free from” toxicity criteria typically serve as the basis for limiting the toxicity of waste discharges to aquatic species. In addition to

narrative and numeric (chemical-specific) criteria, states can and often adopt **nutrient criteria**, which are defined as a means to protect against nutrient over-enrichment and eutrophication.

In 1998, EPA published a *National Strategy for the Development of Regional Nutrient Criteria*, a roadmap for designing guidance for states to use in the development of numeric water quality criteria for nutrients. These technical guidance documents describe the techniques used to develop nutrient criteria for use in state and tribal water quality standards. They cover:

- Estuarine and Coastal Waters
- Lakes and Reservoirs
- Rivers and Streams
- Wetlands

In addition to technical guidance for developing nutrient criteria, EPA has published additional technical documents and tools to aid states and tribes in assessing nutrients in their waters. These include:

- **Methods for Evaluating Wetland Conditions:** A series of documents to help states and tribes build their capacity to monitor and assess the biological and nutrient conditions of wetlands. These modules are designed to help states and tribes establish biological and nutrient assessment and monitoring programs for wetlands. These documents are available online at <http://www.epa.gov/waterscience/criteria/nutrient/guidance/wetlands/#modules>
- **N-STEPS:** A database that provides technical assistance to state and regional scientists and managers who are developing numeric nutrient criteria and provides information to the public regarding nutrient pollution and EPA's activities. This database is available online at <http://www.epa.gov/waterscience/criteria/nutrient/n-steps.html>
- Other **Nutrient Databases:** Databases developed by EPA that contain sample data from various waters throughout the United States, available online at <http://www.epa.gov/waterscience/criteria/nutrient/database/index.html>

Numeric nutrient water quality standards drive water quality assessments and watershed protection management. They support improved development of nutrient Total Maximum Daily Loads (TMDLs; described below). Perhaps most importantly, they create state- and community-developed environmental baselines that allow states and EPA to manage more effectively, measure progress, and support broader partnerships based on nutrient trading, BMPs, land stewardship, wetlands protection, voluntary collaboration, and urban storm water runoff control strategies.

There are a number of key advantages to adopting numeric standards, including:

- Easier and faster development of TMDLs
- Quantitative targets to support trading programs
- Easier to write protective NPDES permits
- Increased effectiveness in evaluating success of nutrient runoff minimization programs
- Measurable, objective water quality baselines against which to measure environmental progress

In December 2008, EPA published a report titled, *State Adoption of Numeric Nutrient Standards (1998-2008)*. The report, which can be found at <http://www.epa.gov/waterscience/criteria/nutrient/files/report1998-2008.pdf>, provides an update of state efforts to develop numeric nutrient standards.

Figure 2-2 depicts the relationships among WQS and the tools used to help meet these standards such as TMDLs, NPDES permits, and water quality trading. These tools are discussed in more detail below.

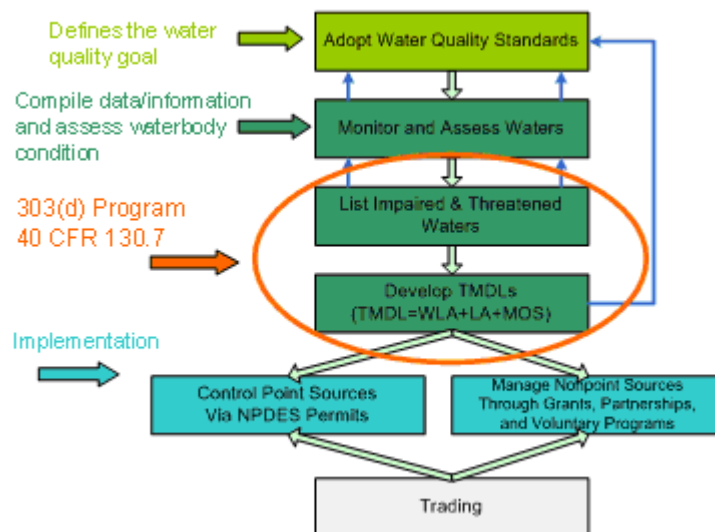

Figure 2-2. Water quality-based approach of the Clean Water Act
Source: USEPA 2008f.

2.6.2 Total Maximum Daily Loads (TMDLs)

CWA Section 303(d) requires states to develop TMDLs for water bodies on the 303(d) list of impaired waters (e.g., waters not meeting their designated uses). A TMDL is a calculation of the maximum amount of a pollutant a water body can receive and still meet WQS. TMDLs serve as a tool for implementing WQS. The TMDL targets or endpoints represent a number where the applicable WQS and designated uses (e.g., public water supply, contact recreation, and the propagation and growth of aquatic life) are achieved and maintained in the water body of concern. TMDLs identify the level of pollutant control necessary to meet WQS and support the designated uses of a water body. Once a TMDL is set, the total load is allocated among all existing sources. The allocation is divided into two portions: (1) a load allocation (LA) representing natural and non-point sources and (2) a waste load allocation (WLA) representing NPDES-permitted point source discharges. In many regions, water bodies have a poor ability to assimilate nutrients or they are already impaired from past pollution and cannot handle large loads of additional nutrients. In these cases, TMDLs may require nutrient permit levels to be even lower than what might otherwise be allowed by nutrient criteria.

Although states are not required under section 303(d) to develop TMDL implementation plans, many states include implementation plans with the TMDL or develop them as a separate document. When developed, TMDL implementation plans may provide additional information on what point and

nonpoint sources contribute to the impairment and how those sources are being controlled, or should be controlled in the future. Once a TMDL has been defined and various load allocations established, the CWA requires that all NPDES permits associated with the water body must reflect the loads established in the TMDL. For WWTPs, this may include specific criteria for nutrients.

2.6.3 NPDES Permitting

Established by the CWA Amendment of 1972, EPA's NPDES permit program has been the primary mechanism for controlling pollution from point sources. Point sources are discrete conveyances such as pipes or man-made ditches. Individual homes that are connected to a municipal system, use a septic system, or do not have a surface discharge do not need an NPDES permit; however, POTWs and other facilities must obtain permits if they discharge directly to surface waters.

NPDES permits for wastewater discharges contain, among other information, effluent limits for "conventional" pollutants such as BOD, total suspended solids (TSS), and pH as well as limits for specific toxicants including various organic and inorganic chemicals. Permits may also include effluent limits for "non-conventional" pollutants such as nitrogen and phosphorus. Effluent limits can be technology-based and/or water-quality based. EPA has established technology-based, secondary treatment effluent limits for BOD as 5-day biochemical oxygen demand (BOD₅), TSS, and pH. Water-quality based effluent limits are set if the technology-based limits are not sufficient to maintain the WQS of the receiving water.

In December 2003, EPA published the *Watershed-Based National Pollutant Discharge Elimination System (NPDES) Permitting Implementation Guidance* (http://www.epa.gov/npdes/pubs/watershedpermitting_finalguidance.pdf), which describes the concept of and the process for watershed-based permitting under the NPDES permit program. Watershed-based NPDES permitting is an approach to developing NPDES permits for multiple point sources located within a defined geographic area (watershed boundaries) to meet WQS. This approach, aimed at achieving new efficiencies and environmental results, provides a process for considering all stressors within a hydrologically defined drainage basin or other geographic area, rather than addressing individual pollutant sources on a discharge-by-discharge basis. This report was followed by technical guidance issued in August 2007 titled, *Watershed-based National Pollutant Discharge Elimination System (NPDES) Permitting Technical Guidance*, available online at http://www.epa.gov/npdes/pubs/watershed_techguidance_entire.pdf

Federal and State regulations related to WQS and TMDLs as described previously are expected to result in more stringent NPDES effluent limits for nitrogen and phosphorus.

2.6.4 Water Quality Trading

Water quality trading is a market-based approach to improve and preserve water quality once WQS and/or TMDLs have been defined. Trading can provide greater efficiency in achieving water quality goals by allowing one source to meet its regulatory obligations by using pollutant reductions created by another source that has lower pollution control costs. For example, under a water quality trading program, a POTW could comply with discharge requirements by paying distributed sources to reduce their discharges by a certain amount. The use of geographically-based trading ratios provides an economic incentive, encouraging action toward the most cost-effective and environmentally beneficial projects.

EPA issued a Water Quality Trading Policy in 2003 to provide guidance to states and tribes on how trading can occur under the CWA and its implementing regulations (<http://www.epa.gov/owow/watershed/trading/finalpolicy2003.pdf>). The policy discusses CWA requirements that are relevant to water quality trading including: requirements to obtain permits; anti-backsliding provisions; development of WQS, including an anti-degradation policy; NPDES permit regulations, TMDLs; and water quality management plans. EPA also developed a number of tools and guidance documents to assist states, permitted facilities, non-point sources, and stakeholders involved in the development of trading programs (www.epa.gov/owow/watershed/trading.htm). Recently, the U.S. Department of Agriculture (USDA) National Resources Conservation Service released a Nitrogen Trading Tool (NTT) prototype for calculating nitrogen credits based on the Nitrogen Loss and Environmental Assessment Package Model (Gross et al. 2008).

Water quality trading programs have been successfully implemented in several states and individual watersheds across the country. For example, nitrogen pollution from point sources into the Long Island Sound was reduced by nearly 25 percent using an innovative nitrogen credit trading program. In Connecticut, the program was implemented across 79 sewage treatment plants in the state. Through the Nitrogen Credit Exchange, established in 2002, the Connecticut program has a goal of reducing nitrogen discharges by 58.5 percent by 2014.

A recent American Society of Civil Engineers journal article (Landers 2008) points out, however, that regulatory frameworks for water quality trading programs have yet to be adopted by the majority of states. Barriers to adopting such programs include uncertainty in: (1) the mechanisms for determining appropriate credits and ratios between point sources and distributed sources; and (2) approaches to ensure that promised reductions actually occur. Other barriers include lack of resources/staff to organize such programs and lack of specific nutrient goals/TMDLs to drive markets.

2.6.5 Technology Evaluation and Guidance

In addition to regulatory and policy initiatives, EPA helps control nutrients through the development and dissemination of technical information. For example, EPA's Office of Wastewater Management (OWM) has developed a number of technology fact sheets on secondary and advanced biological treatment (USEPA, 1999b; 1999c). OWM has also published several technology reports, including *Emerging Technologies for Wastewater Treatment and In-Plant Wet Weather Management* (USEPA, 2008a). This technology guide, published in February 2008, is designed to help municipal wastewater treatment system owners and operators find information on emerging wastewater treatment and in-plant wet weather management. In September 2008, OWM published the *Municipal Nutrient Removal Technologies Reference Document* (USEPA 2008d). Volume 1 of this report provides detailed technical and cost information on biological and physiochemical treatment technologies for the removal of nitrogen, phosphorus, or a combination of the two. The report also includes at least one year's worth of full-scale performance data for 27 wastewater treatment facilities in the United States and Canada and 9 detailed case studies. EPA's Region 10 initiated a project to evaluate municipal WWTPs that have demonstrated exemplary phosphorus removal through their treatment processes. In April 2007, the Region published a report titled, *Advanced Wastewater Treatment to Achieve Low Concentration of Phosphorus* (EPA Region 10 2007).

In 1975, EPA's Office of Research and Development (ORD) published its first technology design guidance for nitrogen removal: *Process Design Manual for Nitrogen Control*. The manual was updated in

1993 and focused on biological/mechanical processes that were finding widespread application for nitrification and nitrogen removal at that time. The development of guidance for phosphorus removal followed a similar schedule, with ORD publishing the document *Process Design Manual for Phosphorus Removal* in 1971. In 1976, the manual was updated to include design guidance for phosphorus removal using mineral addition and lime addition. In 1987, EPA published two technical documents to address phosphorus control: (1) an update to the 1976 *Process Design Manual for Phosphorus Removal* and (2) a handbook titled, *Handbook — Retrofitting POTWs for Phosphorus Removal in the Chesapeake Bay Drainage Basin*. EPA has revised these materials to provide updated state-of-the technology design guidance for both nitrogen and phosphorus control at municipal WWTPs as presented in this manual.

2.7 Industry Initiatives—The WERF Nutrient Removal Challenge

In early 2007, the Water Environment Research Foundation (WERF) created the *Nutrient Removal Challenge* program with the goals of:

- Identifying, assessing, and making recommendations to improve sustainable wastewater nutrient removal technologies.
- Providing information to help agencies meet various receiving water body requirements and other wastewater treatment goals (e.g., climate change, sustainability, cost-effectiveness, reliability).
- Conducting research to inform regulatory decision making and help practitioners comply with increasingly high levels of nitrogen and phosphorus removal with a focus on improving plant performance.

This multi-year program will be funded for 5 years with WERF and external funds anticipated to total \$8-10 million.

As part of the program's kick-off activities, the WERF Nutrient Research Stakeholder Workshop was held on March 7 and 8, 2007 in Baltimore, MD, to further refine the Challenge's research needs and to seek funding partners and collaborators. A total of 25 priority areas were identified, many of them analogous to those identified in a similar workshop conducted by WERF in 2006. Generally, these research areas fall into one of the following three categories:

- Characterization of effluent organic nitrogen
- Accuracy of analytical measurement techniques for low concentrations of phosphorus
- Alternative carbon sources for denitrification

WERF will also be developing a *Nutrient Compendium*, a comprehensive, living document that will describe the current knowledge of regulatory and technological nutrient removal issues. The document will detail the key knowledge areas affecting nutrient removal to very low limits and identify knowledge gaps related to nutrient removal.

As of 2009, WERF has:

- Launched a new web portal (<http://www.werf.org/nutrients>) with research information and relevant links
- Developed technical documents for the *Nutrient Compendium* (preparation of additional technical summaries is underway), including:
 - Tertiary phosphorus removal
 - Low phosphorus concentration measurement
 - Effluent dissolved organic nitrogen
 - External carbon augmentation and denitrification
- Initiated collaborative research in three key areas
 - Effluent organic nitrogen/ refractory dissolved organic nitrogen (RDON)
 - Low phosphorus analysis and measurement at very low limits
 - Alternative external carbon for denitrification to reduce cost and improve efficiency of nitrogen removal

2.8 Benefits of Nutrient Removal

2.8.1 Improved Plant Performance

Biological nutrient removal at POTWs can lead to several operational improvements. In most cases, the addition of an anaerobic zone for biological phosphorus removal will increase the sludge density because of phosphorus accumulation, and reduce the growth of filamentous organisms because of the absence of DO, thereby improving settleability. A pre-anoxic zone for denitrification can also lead to a more stable, better settling activated sludge process as the anoxic-aerobic processes favor good settling floc-forming bacteria over filamentous growth. Additional benefits of a pre-anoxic zone include less aeration energy required in the aerobic zone as the nitrate produced can be used for BOD removal, and less sludge production compared to post-anoxic treatment with supplemental carbon. Anaerobic and anoxic zones also provide better control of foaming if backmixing is eliminated and the recycle of NO_x and DO to the zones is minimized. Further, good removal of nitrogen reduces concern over denitrification and floating sludge in the secondary clarifiers, and provides the option of oversizing the clarifiers to better handle wet weather flows.

The addition of an anaerobic or anoxic zone ahead of the aerobic zone can improve the rate of oxygen transfer in the water. As an example, WEF and ASCE (2006) reported an almost doubling of the oxygen transfer efficiency when the 23rd Avenue Plant in Phoenix, AZ, added a pre-anoxic zone.

Nitrification in the aerobic zone can significantly reduce the alkalinity of the mixed liquor and, in situations where the influent alkalinity is low (e.g., a municipality with soft water), can completely deplete the alkalinity and cause a rapid drop in pH. The nitrification rate will slow significantly below a pH of approximately 6.8. Tchobanoglous et al. (2003) report that nitrification rates at a pH of 6.0 may only be about 20 percent of that with a pH of 7.0. Thus, plants with low alkalinity may experience periods of reduced nitrification and elevated ammonia levels in the plant effluent. Denitrification for total nitrogen removal can replenish much of the alkalinity lost during nitrification and improve operational stability. Approximately 62.5 percent of the amount consumed during nitrate formation is

recovered from the nitrates reduced to nitrogen gas. The total recovery is seldom more than 50 percent for recycle configurations such as MLE with complete denitrification in the anoxic zone.

2.8.2 Co-Removal of Emerging Contaminants

The term “emerging contaminants” refers broadly to those synthetic or naturally occurring chemicals, or to any microbiological organisms, that have not been commonly monitored in the environment but are of increasing concern because of their known or suspected adverse ecological or human health effects. Several studies have examined the effectiveness of current wastewater treatment technologies in the removal of emerging contaminants. Significant findings are:

- Removal efficiencies were enhanced for several investigated contaminants at longer solids residence times (SRTs), with critical SRTs for some contaminants beyond which removal rates did not improve.
- Longer SRTs allow for the establishment of slower growing bacteria (e.g., nitrifying bacteria in activated sludge), which in turn provide a more diverse community of microorganisms with broader physiological capabilities, and the potential for greater biodegradation of emerging contaminants.
- Reverse osmosis has been found to effectively remove pharmaceutical and personal care products (PPCPs) below detection limits including those that were not consistently removed at longer SRTs.

A more detailed discussion of removal of emerging contaminants can be found in EPA’s *Nutrient Control Design Manual — State of Technology Report* (EPA/600/R-09/012, January 2009) at <http://www.epa.gov/nrmrl/pubs/600r09012/600r09012.pdf>.

2.8.3 Nutrient Recovery and Reuse

Nutrient recovery and reuse is gaining national and international attention as a key aspect in sludge management plans. Rather than being disposed as a “waste,” sludge is now being harvested for valuable resources and used as an alternative source of energy. In February 2008, the Global Water Research Coalition in cooperation with USEPA and WERF released a report titled *State of the Science Report: Energy and Resource Recovery from Sludge* (Kalogo and Monteith 2008). In the report, energy recovery technologies are classified into sludge-to-biogas, sludge-to-syngas, sludge-to-oil, and sludge-to-liquid processes. The report also describes various technologies available for resource recovery, including those to recover phosphorus, building materials, nitrogen, and volatile acids. Refer to Chapter 14 of this Manual for more information on resource recovery and sustainability.

2.9 Challenges of Nutrient Removal

Two potentially negative environmental impacts of employing advanced technologies to remove nutrients from wastewater are the increase in the energy use and release of nitrous oxide (N₂O), a greenhouse gas, into the atmosphere.

2.9.1 Energy Requirements

While some operational strategies for enhancing nutrient removal, such as cyclic aeration for denitrification and the utilization of fixed media for integrated fixed-film activated sludge (IFAS) operation in partially or fully nitrifying systems, do not require additional electricity to operate, many BNR technologies require an input of energy beyond that needed for conventional municipal treatment. This is obviously true if the system to be retrofitted was not designed to nitrify due to additional aeration required. Other examples of retrofits that require additional energy include (Kang et al. 2009):

- Additional mixing basins
- Chemical addition
- Additional pumping for recycle flows
- Additional pumping for filtration
- Use of an external carbon source

It is not unusual for the additional energy requirements of upgrading to BNR to require an upgrade to the entire power system, including physical space for motor control centers.

Nitrification requires 50 to 100 percent more aeration energy than non-nitrifying systems, depending upon the operating SRT selected. The total BOD-NOD aeration costs, however, will be reduced by about 20 percent by denitrification to 8-10 mg/L TN for typical municipal wastewaters. The quantity of WAS produced will be greatly reduced which can substantially reduce the amount of energy needed for dewatering and disposal. Thus, conversion of a non-nitrifying activated sludge system to EBPR may not require much in the way of additional energy. Note, also, that addition of either an anaerobic or anoxic zone (and particularly both) ahead of the aerobic zone reduces the aeration volume needed for nitrification through removal from solution or through stabilization of BOD ahead of the aerobic zone, which increases the effective nitrification rate in the aerobic zone.

Chapter 8 of this design manual provides additional discussion of energy and identifies strategies that can be implemented by nutrient removal plants to reduce energy requirements and improve sustainability. The remainder of this section identifies EPA tools and other general strategies that can be used to reduce energy needs.

EPA encourages utilities to identify approaches to integrate energy-efficient practices into their daily management and long-term planning. The 2008 publication, *Ensuring a Sustainable Future, an Energy Management Guidebook for Wastewater and Water Utilities* (USEPA 2008i), provides a recommended approach for energy management using the Plan-Do-Check-Act approach. This guidebook is available online at http://www.epa.gov/waterinfrastructure/bettermanagement_energy.html.

A September 2008 publication titled *National Water Program Strategy — Response to Climate Change* (USEPA 2008b) outlines a number of steps that EPA has taken and that utilities can take to improve energy efficiency. For example, EPA's ENERGY STAR program has developed a "Focus" in the water and wastewater industries. An ENERGY STAR Focus is a targeted effort to improve the energy efficiency within a specific industry or combination of industries. It creates momentum for continuous improvement in energy performance, provides the industry's managers with the tools they need to achieve greater success in their energy management programs, and creates a supportive environment where energy efficiency ideas and opportunities are shared.

Significant progress is being made in the development of new tools for benchmarking energy performance among public water and wastewater utilities. For example, the ENERGY STAR program is expanding the capability of its Energy Performance Rating System to enable drinking water and wastewater utilities to assess their energy use over time and compare it to other utilities—normalized for weather and facility characteristics. As of October 2007, WWTP energy performance can be rated using the ENERGY STAR program’s on-line tool, Portfolio Manager. Portfolio Manager can be used to establish baseline energy use, prioritize investments, set goals, and track energy use and carbon emissions reductions over time.

Many facilities have already installed alternative energy power production facilities, including solar, wind, and hydro, for heating and electricity generation. For example, Calera Creek Water Recycling Plant in Pacifica, CA is using solar panels that provide 10–15 percent of its energy needs, resulting in an estimated \$100,000 savings annually in energy costs (USEPA 2006).

Wastewater facilities can also generate energy from the capture and use of methane. Combined heat and power (CHP) systems can recover biogas (a mixture of methane, carbon dioxide, water vapor, and other gases) from anaerobic digesters to heat buildings or to generate electricity. For example, the East Bay Municipal Utility District (EBMUD) captures and uses biogas to generate enough energy to cover 90 percent of energy needed at its main wastewater facility. If all 544 large sewage treatment plants in the United States operating anaerobic digesters were to install combined heat and power, about 340 megawatts of clean energy could be generated, offsetting 2.3 million metric tons of carbon dioxide emissions annually (i.e., equivalent to planting about 640,000 acres of forest, or the emissions of about 430,000 cars) (USEPA 2007a). This energy is also marketable as “green power” to power utilities that are now required by State laws to have alternative or “green” power as a part of their overall production.

2.9.2 Release of Nitrous Oxide

Nitrous oxide (N_2O) is considered to be a greenhouse gas with a global warming potential approximately 300 times that of the contribution of carbon dioxide (CO_2). N_2O as well as nitric oxide (NO) are known to be intermediates of heterotrophic denitrification (Ahn et al. 2009). Until recently, there has been considerable uncertainty regarding the mechanisms of N_2O generation and whether it is produced and released during the nitrification and denitrification processes.

In 2008, WERF initiated a research project (no. U4R07) to quantify N_2O emissions, determine the mechanisms by which it forms, and develop operational strategies to prevent its formation and release. The first step of this project was to develop a detailed protocol for measuring N_2O and NO emissions from an activated sludge reactor. This method has now been reviewed by EPA and implemented at several WWTPs (WERF 2009). Preliminary findings based on monitoring conducted at nitrogen removal plants were presented at the WEF Specialty Conference: *Nitrogen Removal 2009* and are summarized below (Ahn et al 2009; WERF 2009).

- N_2O emissions are related to an imbalance of the metabolic pathway or, in simpler terms, recovery from stress. N_2O can be produced by nitrifying bacteria in the aerobic and denitrifying bacteria in the anoxic zone; however, denitrifying bacteria can consume N_2O whereas nitrifying bacteria cannot.

- Measured N₂O emissions from the aerobic zone were always higher than emissions from the anoxic zone, contrary to previous thinking.
- N₂O emissions from the aerobic zone exhibited spatial variability within the zone. The highest N₂O levels were observed close to the effluent.
- N₂O emissions form a significant diurnal pattern that can be correlated with diurnal loading patterns of ammonia.
- Release of N₂O in the aerobic zone is largely a function of DO and ammonia concentrations.

Sampling campaigns at additional treatment plants are underway. Researchers are planning to publish an interim Phase 1 report on the findings by the end of 2009 (WERF 2009).

2.10 References

- Ahn, J.H., S. Kim, H. Park, D. Katehis, K. Pagilla, and K. Chandran. Spatial and Temporal Variability in N₂O Generation and Emission from Wastewater Treatment Facilities. Presented at Nutrient Removal 2009. Washington, DC. WEF.
- Alexander, R.B., R.A. Smith, G.E. Schwarz, E.W. Boyer, J.V. Nolan, and J.W. Brakebill. 2008. Differences in Phosphorus and Nitrogen Delivery to the Gulf of Mexico from the Mississippi River Basin. *Environmental Science and Technology*. 42(3): 822-830. Available online: http://water.usgs.gov/nawqa/sparrow/gulf_findings.
- Beline, F., J. Martinez, C. Marol, and G. Guiraud. 2001. Application of 15N Technique to Determine the Contributions of Nitrification and Denitrification to the Flux of Nitrous Oxide from Aerated Pig Slurry. *Water Research*. 35: 2774–2778.
- Bricker, S., B. Longstaff, W. Dennison, A. Jones, K. Boicourt, C. Wicks, and J. Woerner. 2007. Effects of Nutrient Enrichment in the Nation’s Estuaries: A Decade of Change. NOAA Coastal Ocean Program Decision Analysis Series No. 26. Silver Spring, MD: National Centers for Coastal Ocean Science. 328 pp. Available online: <http://ccma.nos.noaa.gov/publications/eutrouupdate/>
- Chesapeake Bay Program, 2008. Chesapeake Bay Program – A Watershed Partnership. Accessed July 1, 2008. Available online: <http://www.chesapeakebay.net/nutr1.htm>
- Crites R. and G. Tchobanoglous. 1998. *Small and Decentralized Wastewater Management Systems*. New York, NY: McGraw Hill.
- EPA Region 10. 2007. *Advanced Wastewater Treatment to Achieve Low Concentration of Phosphorus*. EPA Region 10. EPA 910-R-07-002.
- Garrido J. M., J. Moreno, R. Mendez-Pampin, J.M. Lema. 1998. Nitrous Oxide Production under Toxic Conditions in a Denitrifying Anoxic Filter. *Water Research*. 32(8):2550-2552.

- Gross, C.M., J.A. Delgado, S.P. McKinney, H. Lal, H. Cover, and M.J. Shaffer. 2008. Nitrogen Trading Tool to Facilitate Water Quality Trading. *Journal of Soil and Water Conservation*. March/April 2008. 63(2): 44-45.
- Hong, Z., Hanaki, K., and Matsuo, T. 1993. Greenhouse Gas-N₂O Production during Denitrification in Wastewater Treatment. *Journal of Water Science Technology*. 28(7): 203–207.
- Hynes, R.K. and Knowles, R. 1984. Production of Nitrous Oxide by *Nitrosomonas Europaea*: Effects of Acetylene, pH, and Oxygen. *Canadian Journal of Microbiology*. 30: 1397–1404.
- Lo, I., K.V. Lo, D. Mavinic, D. Shiskowski, and W. Remy. 2008. Reduction of Nitrous Oxide Formation from a Biological Nutrient Removal System in Wastewater Treatment – Factors of Aeration, External Carbon and pH. In *WEFTEC 2008*.
- Kalogo, Y., and H. Monteith. 2008. State of Science Report: Energy and Resource Recovery from Sludge. Prepared for Global Water Research Coalition, by WERF, STOWA, and UK Water Industry Research Limited.
- Kang, S.J., K.P. Olmstead, K.M. Takacs, and J. Collins. 2009. Sustainability of Full-Scale Nutrient Removal Technologies. Presented at Nutrient Removal 2009. Washington, DC. WEF.
- Kuai, L. and W. Verstraete. 1998. Ammonium Removal by the Oxygen-limited Autotrophic Nitrification-Denitrification System. *Applied Environmental Microbiology*. 64: 4500–4506.
- Landers, Jay. 2008. Halting Hypoxia. *Civil Engineering*. PP. 54-65. Reston, VA: ASCE Publications.
- Long Island Sound Study. 2004. Protection+ Progress: Long Island Sound Study Biennial Report 2003–2004. Project Manager/Writer Robert Burg, NEIWPCC/LISS. U.S. EPA Long Island Sound Office, Stamford Government Center. Stamford, CT. Available online: <http://www.longislandsoundstudy.net/pubs/reports/30350report.pdf>
- Meyer, R.L., Zeng, R.J., Giugliano, V. and Blackall, L.L. 2005. Challenges for Simultaneous Nitrification, Denitrification, and Phosphorus Removal in Microbial Aggregates: Mass Transfer Limitation and Nitrous Oxide Production. *FEMS Microbiology Ecology*. 52: 329–338.
- Pehlivanoglu-Mantas, E. and D.L. Sedlak. 2006. Wastewater-Derived Dissolved Organic Nitrogen: Analytical Methods, Characterization, and Effects - A Review. *Critical Reviews in Environmental Science and Technology*. 36:261-285.
- Poff, L.N., M. Brinson, and J. Day, Jr. 2002. Aquatic Ecosystems and Global Climate Change – Potential Impacts on Inland Freshwater and Coastal Wetland Ecosystems in the United States. Prepared for the Pew Center on Global Climate Change. January 2002.
- Shiskowski, D.M. and Mavinic, D.S. 2006. The Influence of Nitrite and pH (nitrous acid) on Aerobic-Phase, Autotrophic N₂O Generation In A Wastewater Treatment Bioreactor. *Journal of Environmental Engineering and Science*. 5: 273-283.

- Spector, M. 1998. Production and Decomposition of Nitrous Oxide during Biological Denitrification. *Water Environment Research*. 70(5): 1096-1098.
- STAC-WERF. 2007. Workshop Considerations and Presentations. Establishing a Research Agenda for Assessing the Bioavailability of Wastewater-Derived Organic Nitrogen in Treatment Systems and Receiving Waters, Baltimore, MD, September, 28, 2007.
- State-EPA Nutrient Innovations Task Group. 2009. An Urgent Call to Action - Report of the State-EPA Nutrient Innovations Task Group. Available online at <http://www.epa.gov/waterscience/criteria/nutrient/>
- Talleg, G., J. Garnier, and M. Gossais. 2006. Nitrous Removal in a Wastewater Treatment Plant through Biofilters: Nitrous Oxide Emissions during Nitrification and Denitrification. *Bioprocess and Biosystem Engineering*. 29: 323-333.
- Talleg, G., J. Garnier, G. Billen, and M. Gossais. 2006. Nitrous Oxide Emissions from Secondary Activated Sludge in Nitrifying Conditions of Urban Wastewater Treatment Plants: Effect of Oxygenation Level. *Water Research*. 40: 2972 - 2980.
- Tchobanoglous, G., F. L. Burton, and H.D. Stensel. 2003. *Wastewater Engineering: Treatment and Reuse*. New York, NY: McGraw-Hill.
- Third, K.A., N. Burnett, and R. Cord-Ruwisch. 2003. Simultaneous Nitrification and Denitrification Using Stored Substrate (PHB) as the Electron Donor in an SBR. *Biotechnology and Bioengineering*. 83: 706–720.
- Thorn, M. and Sorensson, F. 1996. Variation of Nitrous Oxide Formation in the Denitrification Basin in a Wastewater Treatment Plant with Nitrogen Removal. *Water Resource*. 30(6): 1543–1547.
- USEPA. 1976. *Process Design Manual for Phosphorus Removal*. Great Lakes National Program Office. GLNPO Library. EPA 625/1-76-001a. April 1976.
- USEPA. 1987. *Handbook: Retrofitting POTWs for Phosphorus Removal in the Chesapeake Bay Drainage Basin*. Center for Environmental Research Information. Cincinnati, OH. EPA/625/6-87/017.
- USEPA. 1993. *Nitrogen Control Manual*. Office of Research and Development. EPA/625/R-93/010. September 1993.
- USEPA. 1998. National Strategy for the Development of Regional Nutrient Criteria. Office of Water. EPA 822-R-98-002.
- USEPA. 1999a. Wastewater Technology Fact Sheet: Fine Bubble Aeration. EPA 831-F-99-065. Available online: <http://epa.gov/OWM/mtb/mtbfact.htm>
- USEPA. 1999b. Wastewater Technology Fact Sheet: Sequencing Batch Reactors. EPA 832-F-99-073. Available online: http://www.epa.gov/owm/mtb/sbr_new.pdf

- USEPA. 2003a. Watershed-Based National Pollutant Discharge Elimination System (NPDES) Permitting Implementation Guidance. EPA 833-B-03-004. Available online: http://www.epa.gov/npdes/pubs/watershedpermitting_finalguidance.pdf
- USEPA. 2003b. Water Quality Trading Policy. Office of Water. Available online: <http://www.epa.gov/owow/watershed/trading/finalpolicy2003.pdf>
- USEPA. 2006. Wastewater Management Fact Sheet: Energy Conservation. Office of Water, Washington, DC. EPA 832-F-06-024. http://www.epa.gov/owm/mtb/energycon_fasht_final.pdf
- USEPA. 2007a. Opportunities for and Benefits of Combined Heat and Power at Wastewater Treatment Facilities. U.S. Environmental Protection Agency, Combined Heat and Power Partnership, Washington, DC. http://www.epa.gov/chp/documents/wwtf_opportunities.pdf
- USEPA. 2007b. Water Quality Criteria for Nitrogen and Phosphorus Pollution. Database Tools. Website updated 27 September 2007. <http://www.epa.gov/waterscience/criteria/nutrient/database/index.html>
- USEPA. 2007c. Watershed-based National Pollutant Discharge Elimination System (NPDES) Permitting Technical Guidance. Office of Wastewater Management, Water Permits Division. Available online: http://www.epa.gov/npdes/pubs/watershed_techguidance_entire.pdf
- USEPA. 2008a. Emerging Technologies for Wastewater Treatment and In-Plant Wet Weather Management. EPA 832-R-06-006. Available online: http://www.epa.gov/OW-OWM.html/mtb/emerging_technologies.pdf
- USEPA. 2008b. Final Climate Change Strategy. Office of Water. Available online: <http://www.epa.gov/water/climatechange/strategy.html>
- USEPA. 2008c. Mississippi River Basin & Gulf of Mexico Hypoxia. EPA Office of Wetlands, Oceans and Watersheds. Updated June 26, 2008. Available online: <http://www.epa.gov/msbasin/>
- USEPA. 2008d. Municipal Nutrient Removal Technologies Reference Document., Volume 1 - Technical Report. Office of Wastewater Management, Municipal Support Division. EPA 832-R-08-006. Available online: <http://www.epa.gov/OWM/mtb/mnrt-volume1.pdf>
- USEPA. 2008e. Online Technical Support for States: N-STEPS. Health and Ecological Criteria Division, Office of Water Nutrient Criteria Program. Website updated 21 July 2008. <http://www.epa.gov/waterscience/criteria/nutrient/n-steps.html>
- USEPA. 2008f. Overview of Impaired Waters and Total Maximum Daily Loads Program. Wetlands, Oceans & Watersheds. Website updated 16 October 2008. <http://www.epa.gov/OWOW/TMDL/intro.html>
- USEPA. 2008g. State Adoption of Numeric Nutrient Standards (1998-2008). Office of Water. EPA 821-F-08-007. Available online: <http://www.epa.gov/waterscience/criteria/nutrient/files/report1998-2008.pdf>
- USEPA. 2008h. Water Quality Trading. Office of Oceans, Wetlands & Watersheds. Website updated 15 December 2008. <http://www.epa.gov/owow/watershed/trading.htm>

- USEPA. 2008i. Ensuring a Sustainable Future: An Energy Management Guidebook for Wastewater and Water Utilities. January 288. Available online:
http://www.epa.gov/waterinfrastructure/pdfs/guidebook_si_energymanagement.pdf
- USEPA. 2009a. Methods for Evaluating Wetland Conditions. Website updated 9 February 2009.
<http://www.epa.gov/waterscience/criteria/nutrient/guidance/wetlands/#modules>
- USEPA. 2009b. Nutrient Control Design Manual State of Technology Review Report. Office of Research and Development. EPA/600/R-09/012. Available online:
<http://www.epa.gov/nrmrl/pubs/600r09012/600r09012.pdf>
- U.S. Public Health Service and USEPA. 2008. *Clean Watersheds Needs Surveys 2004 Report to Congress*. Available online: <http://www.epa.gov/cwns/2004rtc/cwns2004rtc.pdf>
- Vanderploeg, H. 2002. The Zebra Mussel Connection: Nuisance Algal Blooms, Lake Erie Anoxia, and other Water Quality Problems in the Great Lakes. 2002. Great Lake Environmental Research Laboratory. Ann Arbor, MI. Revised September 2002. Available online:
<http://www.glerl.noaa.gov/pubs/brochures/mcystisflyer/mcystis.html>
- WEF and ASCE. 2006. *Biological Nutrient Removal (BNR) Operation in Wastewater Treatment Plants - MOP 29*. Water Environment Federation and the American Society of Civil Engineers. Alexandria, VA: WEF Press.
- WERF. 2007a. Nutrient Challenge Research Plan – 2007. October 31, 2007. Available online:
<http://www.werfnutrientchallenge.com/docs/Nutrient%20Removal%20Challenge%20Research%20Plan%202007.pdf>
- WERF. 2007b. Nutrient Research Stakeholder Workshop. March 7 and 8, 2007. Baltimore, MD.
- WERF. 2009. Molecular Level Through Whole Reactor Level Characterization of Greenhouse Nitrogen Emission from Wastewater Treatment Operations. Project Number: U4R07. Updated: July 16, 2009. Alexandria, VA: WERF.
- Zeng, R.J., Lemaire, R., Yuan, Z. and Keller, J. 2003. Simultaneous Nitrification, Denitrification, and Phosphorus Removal in a Lab-Scale Sequencing Batch Reactor. *Biotechnology and Bioengineering*. 84(2): 170-178.
- Zheng, H., Hanaki, K., and Matsuo, T. 1994. Production of Nitrous Oxide Gas during Nitrification of Wastewater. *Water Science and Technology*. 30(6): 133–141.

3. Principles of Phosphorus Removal by Chemical Addition

Chapter 3 covers:

- 3.1 Introduction
- 3.2 Available Forms of Metal Salts and Lime
- 3.3 Equations and Stoichiometry
- 3.4 Solids Separation Processes
- 3.5 Effects on Sludge Production and Handling
- 3.6 Two Factors that May Limit the Ability of Plants to Achieve Very Low Effluent Levels
- 3.7 References

3.1 Introduction

Chemical precipitation is widely used to remove phosphorus at wastewater treatment plants (WWTPs). Chemicals such as metal salts or lime can be added to primary, secondary, or tertiary processes or at multiple locations within the plant. Solids removal following chemical precipitation can be conventional, such as primary or secondary clarification, or advanced, such as tertiary filtration or alternative technologies. Chemical precipitation can be used alone or in conjunction with biological phosphorus removal (BPR) to reduce the costs associated with the chemical dose and sludge production.

This chapter describes the principles of phosphorus removal by chemical addition. It includes a description of chemicals available, the latest research on the mechanisms of phosphorus removal, and factors affecting performance such as point of application and solids separation. Lastly, it presents information on sludge production and limits of removal. Chapter 9 follows with more detailed recommendations for designing a chemical phosphorus removal treatment system.

3.2 Available Forms of Metal Salts and Lime

Chemicals used for phosphorus precipitation are typically either metal salts or lime. The two most common metal salts are aluminum sulfate (commonly known as alum) and ferric chloride. Sodium aluminate can serve as a source of alum, although it can increase the pH substantially (WEF and ASCE 2009). Various forms of polyaluminum chloride (PAC) can also be used for chemical precipitation. Ferrous sulfate and ferrous chloride, which are available as byproducts of steel-making operations (pickle liquor), are also used. Lime is typically available in solid form as either quicklime (CaO) or hydrated lime Ca(OH)₂. Table 3-1 summarizes the most common chemical precipitants used for phosphorus removal. Chapter 9 provides additional information on chemical properties and guidance for chemical selection.

Table 3-1. Common Chemicals Used for Phosphorus Removal

Chemical	Formula	Description	Typical Weight Percent in Commercial Solutions ²
Aluminum Sulfate (Alum)	$Al_2(SO_4)_3 \cdot 14(H_2O)$	Crystallized, dry form or liquid	48%
Sodium Aluminate	$Na_2Al_2O_4$	Powder or liquid form. Granular trihydrate is common commercial form	20%
Polyaluminum Chloride (PAC)	$Al_nCl_{(3n-m)}(OH)_m$ EX: $Al_{12}Cl_{12}(OH)_{24}$	Range in the degree of basicity and aluminum concentration	51%
Ferric Chloride ¹	$FeCl_3$	Orange-brown aqueous solution	37 – 47%
Pickle liquor (Ferrous sulfate or Ferrous iron)	Fe_2SO_4 or Fe^{2+}	Green aqueous solution	Varies
Lime	CaO , $Ca(OH)_2$	Dry white powder or liquid form as quicklime, CaO , or hydrated lime, $Ca(OH)_2$	NA

1. "Ferric is also common trade name for $FeCl_3$ and also 40% $FeCl_3$ solution

2. Source: WEF and ASCE 2006 Tables 8.6 and 8.9

3.3 Equations and Stoichiometry

This section describes the forms of phosphorus that can be removed by chemical treatment. It follows with a detailed discussion of the chemical reactions among metal salts, lime, and phosphorus including factors affecting removal efficiency.

3.3.1 Removable Phosphorus

Chemical precipitation will remove only the phosphate (i.e., orthophosphate) fraction of total phosphorus in wastewater. Influent phosphate is typically 50 to 80 percent of total phosphorus and generally exists in one of two forms, $H_2PO_4^-$ and HPO_4^{2-} , with the first being dominant at pH below 8.3. Polyphosphates will not react with metal salts or lime; however, they will be converted to phosphate during biological treatment¹. Organically bound phosphorus typically makes up the smallest fraction of total influent phosphorus ($1 < \text{mg/L}$). The colloidal and particulate portion will generally be removed during solids separation processes. The soluble organic fraction may either be hydrolyzed into orthophosphate during the treatment process (if biodegradable) or will pass through a WWTP (if non-biodegradable).

See Chapter 2, Section 2.2.2 for additional information on the forms of phosphorus in influent wastewater. See Section 3.8 for a discussion on the implications of recalcitrant phosphorus on achieving low effluent total phosphorus (TP) concentrations.

¹ Colorimetric techniques used to quantify phosphate concentrations give results for "reactive" phosphorus, which is primarily orthophosphate but includes a small condensed phosphate fraction.

3.3.2 Reactions of Metal Salts and Phosphorus

The metal salt dose for chemical phosphorus removal has been recognized as a critical design and economic parameter for chemical treatment systems. In addition to dose, the wastewater characteristics, method of chemical addition, chemical addition feeding point(s), reaction pH, flocculation method, and time after chemical addition are important design and performance issues that can affect the relationship between dose and phosphorus removal efficiency.

The metal salt dose is commonly described in terms of the moles of metal added (Me_{dose}) per mole of soluble phosphorus in the influent (P_{ini}). The term “stoichiometric dose” is based on 1.0 Me added per Mole of P removed (i.e., $1.0 Me_{dose}/P_{ini}$) which would be the molar ratio requirement for strictly a chemical reaction between aluminum or iron salts to form a $M-PO_4$ precipitate as shown in Equations 3-1 and 3-2 (WEF and ASCE 2009, charges omitted).

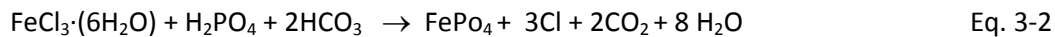
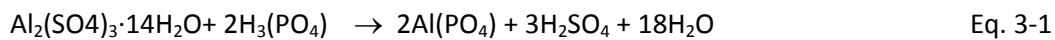

At relatively high effluent P concentrations (above 1.0 mg/L), the stoichiometric relationship for metal salt dose is commonly observed. The molar ratio typically increases well above the stoichiometric ratio as lower effluent phosphorus concentrations are needed. This has commonly been attributed to substantial metal hydroxide formation in addition to metal-phosphorus precipitates (Sedlak, 1991).

Research by Szabó et al. (2008) and Smith et al. (2008) defined a mechanism for phosphorus removal by ferric chloride based on a surface complexation model. Conceptually, the addition of ferric chloride results in the precipitation of hydrous ferric oxide (HFO), which provides surface sites for reaction with phosphorus. The basis of the phosphorus removal mechanism is that phosphate and iron can share an oxygen molecule and that interactions can be represented by the following symbolic reaction (charges omitted) (Smith et al. 2008):



The reactive oxygens are termed “surface sites,” and their availability is related to mixing and aging conditions. Under rapid mixing, surface sites are readily available. With slow mixing, however, much of the HFO would form in the absence of phosphorus and result in less efficient phosphorus removal.

As the HFO forms, phosphate is simultaneously removed through (1) co-precipitation of phosphate into the HFO structure, and (2) adsorption of the phosphate onto pre-formed HFO particles (Smith et al. 2008). After the initial HFO formation and phosphorus removal, additional phosphorus can be removed over time by diffusion of phosphorus into the floc. The effect of aging is to reduce reactive sites and HFO phosphorus removal capacity. Additional research is needed to confirm a similar removal mechanism for aluminum.

Chemical Dose and Phosphorus Removal Efficiency

In all observations on chemical removal of phosphorus, the percent phosphorus removal increases and effluent phosphorus concentration decreases as the molar chemical dose for metal salts increases, but the incremental removal diminishes with increased dosages (Sedlak 1991, Szabo et al.

2008, WEF and ASCE 2009). Smith et al. (2007) found that for typical influent phosphorus concentrations, ferric doses above 1.5 to 2.0 $\text{Me}_{\text{dose}}/\text{P}_{\text{ini}}$ ratios are sufficient to remove 80 to 98 percent of soluble phosphorus. Reaching very low effluent TP concentrations, i.e. below 0.10 mg/L, requires significantly higher ratios of about 6 or 7 $\text{Me}_{\text{dose}}/\text{P}_{\text{ini}}$. A similar dose was reported for 75 to 95 percent phosphorus removal from wastewater using alum (WEF and ASCE 2009). For similar phosphorus removal efficiencies using pre-polymerized salts such as PACl or sodium aluminate, a higher dose is needed. Factors that influence dose and removal efficiency may include pH, alkalinity, competing substances in the wastewater, initial mixing conditions and flocculation.

Mixing at the Dosage Point

Mixing at the dosage point is necessary to ensure that the metal and phosphate molecules react. Mixing intensity can be represented by the velocity gradient, G , in units of seconds^{-1} . Smith et al. (2007) reported that the reactions of phosphates at the surface of the hydrous ferric oxides depend highly on the mixing conditions. Rapid mixing means that the surface sites are available, whereas with slower mixing, many of the metal oxides would form in the absence of phosphate and render internal oxygen atoms unavailable for binding.

Bench-scale kinetic experiments by Szabo et al. (2008) revealed that a majority of phosphate will react with iron in the first 10 to 20 seconds under ideal mixing conditions ($G = 425 \text{ second}^{-1}$). At wastewater plants, mixing at the dosage point is typically poor, with G values ranging from 20 to 100 second^{-1} (Szabó et al. 2008). Szabó et al. recommend that plants attempt to achieve a very high mixing intensity at the dosage point (G values between 200 and 300 second^{-1}). Mixing times at high energy are generally in the range of 10 to 30 seconds.

After the initial rapid kinetics, phosphorus removal can continue with slow reaction kinetics between the phosphate and iron over many hours and even days (Szabo et al. 2008). The slow reaction rate removal is more important for alum or ferric addition to activated sludge basins with solids retention times in days.

Flocculation

After rapid mixing at the dosage point, gentle mixing is needed to form flocs that can be settled or removed through a solids separation process. This is critical for meeting low effluent phosphorus requirements. Often, movement of the wastewater through the treatment plant is sufficient for floc formation (USEPA 2008b). Flocculation can be limited by insufficient time or conditions that disrupt floc formation such as pumping and aeration.

pH and Alkalinity

The highest removal efficiency for chemical precipitation is within a pH range of 5.5 to 7.0 (Szabó et al. 2008). Between pH 7 and 10, phosphorus removal efficiency declines because the surfaces of metal hydroxides are more negatively charged, and soluble iron hydroxides begin to form. At low pH values, the solubility of the precipitant is reduced, and at extremely low pH values, metal hydroxide precipitation is limited. Szabó et al. (2008) reported similar relationships between phosphorus removal efficiency and pH for both alum and ferric chloride.

COD and TSS in Raw Wastewater

The efficiency of metal salt addition in the primary treatment step can be affected by the wastewater characteristics. Based on the results of jar tests using municipal wastewater, Szabo et al. (2008) observed a relationship between organic content and efficiency of phosphorus removal using metal salts. Between chemical oxygen demand (COD) values of 300 to 700 mg/L, the phosphate removal efficiency decreased with increasing COD. Similar results were observed for total suspended solids (TSS), with lower phosphorus removal efficiency at higher TSS concentrations. In addition to reduced efficiency during primary treatment, organic content can reduce the efficiency of metal salt removal of phosphorus in activated sludge reactors. Iron and aluminum ions can react with humic and fulvic acid substances to form insoluble complexes with the metal ions and their mineral oxides, thereby blocking the reactive sites for phosphate precipitation (WERF 2009).

3.3.3 Reactions of Lime with Phosphorus

When lime is added to wastewater, it first reacts with the bicarbonate alkalinity to form calcium carbonate (CaCO_3). As the pH increases to more than 10, excess calcium ions will react with phosphate to precipitate hydroxylapatite [$\text{Ca}_5(\text{OH})(\text{PO}_4)_3$] as shown in the reaction below.

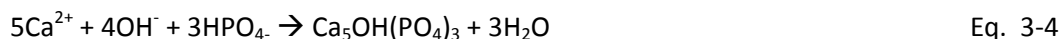

Because it reacts first with alkalinity, the lime dose is essentially independent of the influent phosphorus concentration. Tchobanoglous et al. (2003) estimates the lime dose to typically be 1.4 to 1.6 times the total alkalinity expressed as CaCO_3 .

Lime addition can raise the pH to greater than 11. Because activated sludge processes require pH levels below 9, lime cannot be added directly to biological treatment processes.

3.4 Solids Separation Processes

Solids separation methods are critical for determining phosphorus removal efficiency with chemical precipitation as a large portion of the effluent phosphorus is contained in chemical precipitates. Solids separation technologies, such as clarification and filtration are often used in combination to achieve low effluent TP levels. Polymers can be used in addition to the metal salts for phosphorus precipitation to enhance removal for fine particles and colloids.

Gravity separation in primary or secondary clarifiers is a traditional solids separation method at WWTPs. Clarifiers used in chemical precipitation systems differ very little from those employed in conventional treatment, although use of flocculation zones is recommended to provide flocculation time after chemical addition.

For secondary clarification, flocculation can occur in aeration basins or channels preceding clarification. The use of flocculation zones in secondary clarifiers is a recommended practice to allow flexibility in the point of chemical addition and to provide a zone in which direct control can be exercised over velocity gradients to achieve optimum flocculation.

Membrane bioreactors for activated sludge wastewater treatment provide maximum solids separation with effluent turbidity values typically less than 0.30 NTU and non-detect effluent TSS concentrations.

Tertiary filtration following secondary clarification is increasingly being used as a polishing step, with chemical to reduce TSS and to achieve effluent TP concentrations below 0.50 mg/L. The types of filters available include traditional media filters, upflow continuous backwash filters, cloth filters, and membranes. Several patented ballasted high-rate clarifiers (BHRC) using different types of ballast such as recycled sludge, microsand, and magnetic ballast (USEPA 2008b) have been developed in recent years. Examples include DensaDeg[®], Actiflo[®], and the CoMag[™] process. Chapter 6 of this design manual provides an overview of the different tertiary filter technologies and Chapter 11 provides recommendations for design.

3.5 Effects on Sludge Production and Handling

Sludge production and handling is generally considered to be one of the downsides of chemical phosphorus removal. Chemical precipitation methods always produce additional solids due to generation of metal- or calcium- phosphate precipitates and metal hydroxide sludge. The amount of increased sludge production will depend on the location of chemical addition, the chemical dose used, and the constituents present in the wastewater.

The stoichiometric relationships shown below can provide a good first estimate of additional solids production from chemical precipitation (WEF and ASCE 2009). For alum addition the removal of P with Al can be represented by $Al_{0.8}(H_2PO_4)(OH)_{1.4}$ and the remaining aluminum added will be described by aluminum hydroxide production in accordance with Eq. 3-5. For ferric removal with iron the sludge production from P removal can be estimated as $Fe_{1.6}(H_2PO_4)(OH)_{3.8}$ and the remaining ferric added will be described by ferric hydroxide production in Eq. 3-6.



Typically, the addition of metal salts to the primary clarifier for the purposes of complete phosphorus removal will increase primary treatment sludge production by 50 to 100 percent due to phosphorus and hydroxide precipitates and increased suspended solids removal. In this case the secondary sludge production is lower due to removal of additional TSS and BOD in the primary clarifier. The total overall plant sludge production can be expected to increase by 60 to 70 percent (WEF and ASCE 2009). For metal addition to the secondary treatment process to achieve effluent P concentrations in the range of 0.50 to 1.0 mg/L with the stoichiometric metal salt dose in the range of 2.0, the sludge production may increase by 35 to 45 percent and the overall plant sludge production may increase by 5 to 25 percent (WEF and ASCE 2009). For tertiary applications to achieve effluent P concentrations of less than 0.10 mg/L, the chemical stoichiometric dose can be 2 to 3 times that indicated in the previous sentence for secondary treatment, but the amount of P to be removed is much less, so that the effect on sludge production can be estimated to be increased by 45 to 60 percent for secondary/tertiary treatment and by 10 to 40 percent for the overall plant sludge production. See Chapter 9, Section 9.8.3, for an example calculation of sludge production increase resulting from the addition of metal salts.

Lime typically produces a much higher sludge volume compared to metal salts because of its reaction with natural alkalinity. The following reactions are important for determining the sludge produced from lime addition (Tchobanoglous et al. 2003):

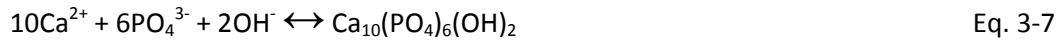

An advantage of lime sludge is that some stabilization can occur due to the high pH levels required. One disadvantage is that lime can cause scaling in mechanical thickening and dewatering systems. Although alum tends to produce less sludge than ferric salts, alum sludge can be more difficult to concentrate and dewater compared to ferric sludge.

The use of metal salts can result in increased inorganic salts (salinity) in the sludge and in the effluent. Salinity can create problems when biosolids are land applied or when the effluent is returned to existing water supply reservoirs. Biological phosphorus removal was developed in South Africa due to the high rate of indirect recycling of wastewater effluent, which led to excessive total dissolved solids (TDS) in the water supply during dry periods. High total salts can reduce germination rates for crops and negatively affect the soil structure, in addition to potential taste and odor problems.

3.6 Two Factors that May Limit the Ability of Plants to Achieve Very Low Effluent Levels

Two factors may limit the ability of plants to achieve very low levels: the presence of recalcitrant phosphorus and challenges in measuring very low effluent concentrations.

A portion of total phosphorus in wastewater can be recalcitrant, meaning that it passes through the chemical, biological, and physical treatment processes and into the effluent unchanged. Lancaster and Madden (2008) reported atypical recalcitrant phosphorus spikes as high as 0.5 mg/L in municipal wastewater, which were suspected to originate from an industrial source. The authors speculated that the recalcitrant fraction was made up of either dissolved acid-hydrolyzable phosphorus, organic phosphorus, or a combination of the two. Neethling et al. (2007) postulated that recalcitrant phosphorus is mostly the dissolved organic variety.

Studies conducted in Washington State and Nevada revealed significant variability in measured phosphorus concentrations less than 0.020 mg/L. The City of Las Vegas Pilot Study found that the accuracy of the measurement depended on several factors including the sample matrix and digestion procedure (Eleuterio and Neethling 2009). In 2007, WERF initiated a project to evaluate the capabilities of commercial laboratories to accurately measure phosphorus concentrations less than 0.020 mg/L and determine factors that affect method accuracy. Key findings, which were presented at the WEF 2009 specialty conference on nutrient removal, are as follows:

- Total phosphorus measurements exhibited a wide variability. This range was attributed to sample digestion procedures.

- Orthophosphate measurements were accurate for de-ionized water, but not for wastewater effluent samples. Variability in results was attributed to sample matrix and digestion procedures.
- The Ascorbic Acid method (either the USEPA or Standard Methods procedure) was the most often used and was found to be a reliable technique for measuring orthophosphate at low concentrations.

Eleuterio and Neethling (2009) concluded that additional research is needed to identify the compounds interfering with the method and develop techniques to correct these interferences.

3.7 References

Benisch, M., D. Clark, Neethling, J.B., H.S. Fredrickson, A. Gu. 2007. Can Tertiary Phosphorus Removal Reliably Produce 10 µg/L?: Pilot Results from Coeur D'Alene, ID. In *Nutrient Removal 2007*. WEF.

EPA Region 10. 2007. Advanced Wastewater Treatment to Achieve Low Concentration of Phosphorus. EPA Region 10. EPA 910-R-07-002.

Lancaster, C.D. and J.E. Madden. 2008. Not So Fast! The Impact of Recalcitrant Phosphorus on the Ability to Meet Low Phosphorus Limits. In *WEFTEC 2008*.

Neethling, J.B., B. Bakke, M. Benisch, A. Gu, H. Stephens, H.D. Stensel, and R. Moore. 2005. Factors Influencing the Reliability of Enhanced Biological Phosphorus Removal. Alexandria, VA: WERF and IWA Publishing.

Neethling, J.B., M. Benisch, D. Clark, A. Gu. 2007. Phosphorus Speciation Provides Direction to Produce 10 µg/L. In *Nutrient Removal 2007*. WEF.

Sedlak, R.I., editor. 1991. Phosphorus and Nitrogen Removal from Municipal Wastewater; Principles and Practice, 2nd edition. Lewis Publishers, Boca Raton, FL.

Smith, D.S., R.L. Gilmore, A. Szábo, I. Takács, S. Murthy, and G. Daigger. 2008. Chemically Mediated Phosphorus Removal to Low Levels: Analysis and Interpretation of Data. In *WEFTEC 2008*.

Smith, S., A. Szabó, I. Takács, S. Murthy, I. Licskó, and G. Daigger. 2007. The Significance of Chemical Phosphorus Removal Theory for Engineering Practice. In *Nutrient Removal 2007*. WEF.

Smith, S., I. Takács, S. Murthy, G.T. Daigger, and A. Szabó. 2008. Phosphate Complexation Model and Its Implications for Chemical Phosphorus Removal. *Water Environment Research*. 80(5): 428-438. Alexandria, VA: WEF.

Szabó, A., I. Takács, S. Murthy, G.T. Daigger, I. Licskó, and S. Smith. 2008. Significance of Design and Operational Variables in Chemical Phosphorus Removal. *Water Environment Research*. 80(5):407-416. Alexandria, VA: WEF.

Tchobanoglous, G., F. L. Burton, and H.D. Stensel. 2003. *Wastewater Engineering: Treatment and Reuse*. New York, NY: McGraw-Hill.

- USEPA. 2000. Wastewater Technology Fact Sheet: Chemical Precipitation. Office of Water. EPA 832-F-00-018.
- USEPA. 2008a. Emerging Technologies for Wastewater Treatment and In-Plant Wet Weather Management. EPA 832-R-06-006. Available online: http://www.epa.gov/OW-OWM.html/mtb/emerging_technologies.pdf
- USEPA. 2008b. Municipal Nutrient Removal Technologies Reference Document. Volume 1 - Technical Report. Office of Wastewater Management, Municipal Support Division. EPA 832-R-08-006. Available online: <http://www.epa.gov/OWM/mtb/mnrt-volume1.pdf>
- WEF and ASCE. 1998. *Design of Municipal Wastewater Treatment Plants - MOP 8, 4th Ed.* Water Environment Federation and American Society of Civil Engineers. Alexandria, VA: WEF.
- WEF and ASCE. 2006. Biological Nutrient Removal (BNR) Operation in Wastewater Treatment Plants - MOP 29. Water Environment Federation and the American Society of Civil Engineers. Alexandria, VA: WEF Press.
- WEF and ASCE. 2009. *Design of Municipal Wastewater Treatment Plants – WEF Manual of Practice 8 and ASCE Manuals and Reports on Engineering Practice No. 76, 5th Ed.* Water Environment Federation, Alexandria, VA, and American Society of Civil Engineers Environment & Water Resources Institute, Reston, Va.
- WERF. 2009. Chapter 1, Introduction: Tertiary Phosphorus Removal. Nutrient Compendium. Website accessed 11 March 2009. <http://www.werfnutrientchallenge.com/chapter1.asp?area=ch1>

The page left intentionally blank

4. Principles of Biological Nitrogen Removal

Chapter 4 covers:

- 4.1 Introduction
- 4.2 Nitrogen Removal by Biomass Synthesis

Nitrification

- 4.3 Microbiology of Nitrification
- 4.4 Reactions and Stoichiometry of Nitrification
- 4.5 Nitrification Kinetics
- 4.6 Inhibitory Effects of Environmental Conditions on Nitrification

Denitrification

- 4.7 Denitrification Fundamentals
- 4.8 Microbiology of Denitrification
- 4.9 Metabolism and Stoichiometry of Heterotrophic Denitrification
- 4.10 Biological Denitrification Kinetics with Influent Wastewater
- 4.11 Denitrification Carbon Sources and Relative Consumption Rates
- 4.12 Denitrification Kinetics of Exogenous Carbon Sources
- 4.13 Specific Denitrification Rates

Additional Topics

- 4.14 Simultaneous Nitrification-Denitrification
- 4.15 Metabolism, Stoichiometry, and Kinetics of ANAMMOX®
- 4.16 Impacts on Sludge Production and Handling
- 4.17 Effluent Dissolved Organic Nitrogen
- 4.18 References

4.1 Introduction

Biological nitrogen removal in wastewater treatment occurs by two primary mechanisms: 1) biomass synthesis (nitrogen assimilation) and sludge wasting, and 2) biological nitrification and denitrification, with only the latter able to achieve high levels of nitrogen removal and low effluent concentrations of inorganic nitrogen in biological nutrient removal processes treating domestic wastewaters. Nitrification is a two-step process in which one genus of aerobic bacteria oxidize ammonia-nitrogen ($\text{NH}_3\text{-N}$) to nitrite-nitrogen ($\text{NO}_2\text{-N}$) followed by another genus which oxidizes nitrite-nitrogen to nitrate-nitrogen ($\text{NO}_3\text{-N}$). Under certain conditions, e.g. inadequate dissolved oxygen, the process can be stopped at $\text{NO}_2\text{-N}$ formation. In biological denitrification, a carbon source is oxidized using nitrate and/or nitrite as electron acceptors in biological oxidation-reduction reactions to reduce the oxidized nitrogen ($\text{NO}_3\text{-N}$ or $\text{NO}_2\text{-N}$) to inert nitrogen gas (N_2). An anaerobic process that does not require a carbon source for $\text{NO}_2\text{-N}$ reduction is the ANAMMOX® (anaerobic ammonia oxidation) process in which certain bacteria are capable of oxidizing ammonia with nitrite reduction to produce N_2 (Sliemers et al. 2002).

This chapter provides an overview of the principles behind biological nitrogen removal including autotrophic and heterotrophic microorganisms responsible for nitrification and denitrification, reactions and stoichiometry, kinetics, effects of environmental factors, and fixed film process considerations, as well as simple design calculations.

4.2 Nitrogen Removal by Biomass Synthesis

Biochemical oxygen demand (BOD) removal in biological wastewater treatment processes occurs with bacterial cell growth. A commonly used formulation for biomass (Hoover and Porges 1952) is $C_5H_7O_2N$, which suggests that nitrogen accounts for 12 percent of the biomass volatile suspended solids (VSS). For domestic wastewater treatment, **15 to 30 percent** of influent nitrogen can be removed via biomass synthesis and sludge wasting. If the waste sludge is processed by anaerobic digestion, about one half of the nitrogen removed can be released as ammonia in the digester and returned to the biological treatment process in dewatering recycle streams, such that only 10 to 15 percent net removal by synthesis occurs. Centrate or filtrate from digester solids dewatering can contain NH_4-N concentrations ranging from 500 to 1200 milligrams per liter (mg/L), depending on the level of solids thickening prior to anaerobic digestion and the digester operation.

The nitrogen removal efficiency by biomass synthesis depends on the biological process influent BOD to total nitrogen (TN) ratio and the biomass solids retention time (SRT) in the system. With increasing SRT, a greater fraction of the biomass undergoes endogenous decay, releasing NH_4-N and decreasing the net nitrogen removal due to both synthesis and decay. Not all of the nitrogen is released with cell loss, as some of it remains unavailable in cell debris following cell death. The effect of SRT and influent BOD/TN ratio on the percent nitrogen removal due to biomass synthesis and decay is illustrated in Figure 4-1. At lower SRTs and higher influent BOD/N ratios, the removal due to biosynthesis and sludge wasting is higher. Assumptions used were a biomass synthesis yield value of 0.50 g VSS/g BOD removed and an endogenous decay rate of 0.08 gVSS/gVSS per day (Tchobanoglous et al. 2003). The fraction of biomass debris remaining from endogenous decay was assumed to be 0.08 gVSS/gVSS (Barker and Dold 1997).

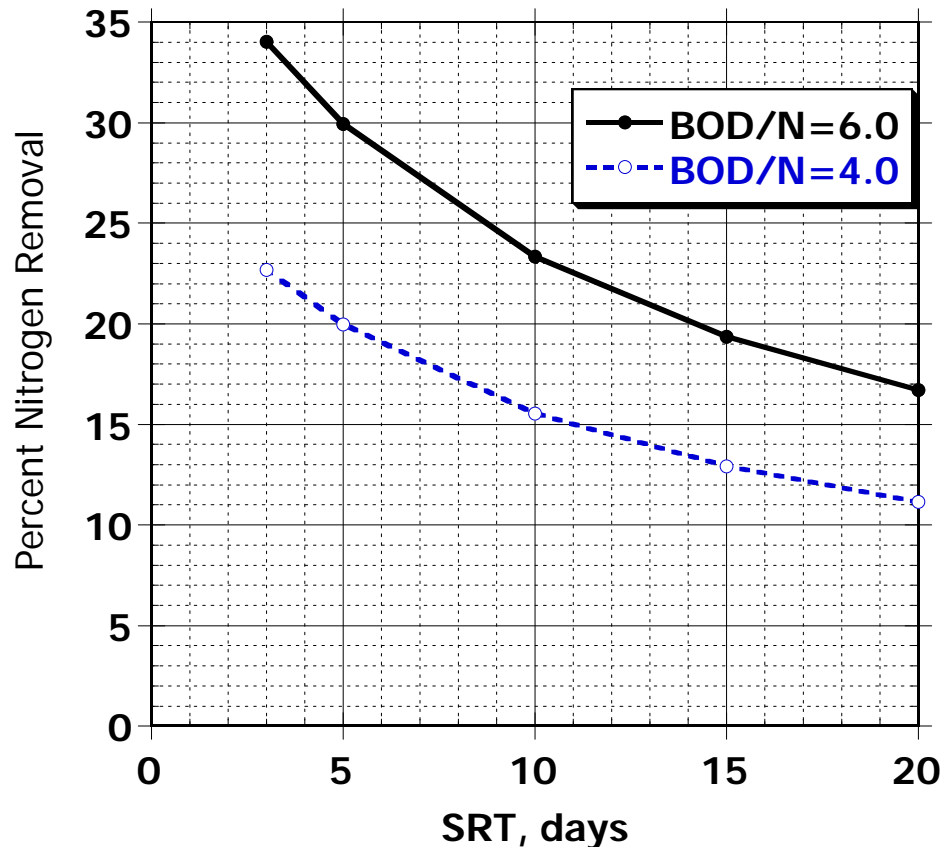

Figure 4-1. Percent nitrogen removal due to biomass synthesis as a function of SRT and influent BOD/N ratio.

4.3 Microbiology of Nitrification

Ammonia- and nitrite-oxidizing bacteria are referred to as autotrophic bacteria because they use carbon dioxide (CO_2) for their carbon source. More specifically, they are aerobic chemoautotrophic bacteria because, in addition to using CO_2 , they require dissolved oxygen to oxidize an inorganic compound ($\text{NH}_4\text{-N}$ or $\text{NO}_2\text{-N}$) to obtain cell energy. A key functional enzyme possessed by all these bacteria is ammonia monooxygenase (AMO). This enzyme oxidizes ammonia to hydroxylamine, which is subsequently converted to nitrite by hydroxylamine oxidoreductase. The ammonia-oxidizing bacteria (AOB) are designated as Nitroso organisms and include the genera *Nitrosomonas*, *Nitrospira*, and *Nitrosococcus*. The nitrite-oxidizing bacteria (NOB) are designated as Nitro-organisms and include the genera *Nitrobacter*, *Nitrospira*, *Nitrococcus*, and *Nitrospina* (Rowan et al. 2003).

Differences in 16S ribosomal RNA (rRNA) sequences for AOB and NOB genera results in distinct differences in phylogenetics (Rowan et al. 2003). The phylogenetic distribution of AOB is summarized in Table 4-1. The genera *Nitrosomonas* and *Nitrospira* are soil and freshwater AOB that are in the class β -Proteobacteria. Five lineages of *Nitrosomonas* AOB have been determined by Koops and Pommerening-Roser (2001) and are *N. europaea/eutropha*, *N. communis*, *N. oligotropha*, *N. marina*, and *N. cryptolerans*. *Nitrosococcus* AOB are located in the α -Proteobacteria and consist of only marine AOB species with strains *Nitrosococcus oceani* and *Nitrosococcus halophilus*. *Nitrosococcus mobilis* was previously misnamed and now belongs to the β -Proteobacteria genus *Nitrosomonas* and not the genus *Nitrosococcus* in the α -Proteobacteria.

Table 4-1. Phylogeny of Ammonia-Oxidizing Bacteria

Subclass of Proteobacteria	Sub Clusters	Species	Salt Requirement	NH ₃ affinity K _s , μM	Preferred Habitat
β-Proteobacteria	europaea-mobilis	<i>Nitrosomonas europaea</i>	Halotolerant, moderately halophilic	30-61	WWTP, eutrophic freshwater, brackish water
		<i>Nitrosomonas eutropha</i>			
		<i>Nitrosomonas halophilar</i>			
		<i>Nitrosococcus mobilis</i>			
	communis	<i>Nitrosomonas communis</i>	No salt requirement	14-43	Soils (not acid)
		<i>Nitrosomonas sp. I</i>			
		<i>Nitrosomonas sp. II</i>			
	oligotrophia	<i>Nitrosomonas nitrosa</i>	No salt requirement	19-46	Eutrophic freshwater
		<i>Nitrosomonas ureae</i>	No salt requirement	1.9-4.2	Oligotrophic freshwater, natural soils
	<i>Nitrosomonas oligotropha</i>				
	marina	<i>Nitrosomonas marina</i>	Obligately halophilic	50-52	Marine environment
		<i>Nitrosomonas sp. III</i>			
		<i>Nitrosomonas aestuarii</i>			
		<i>Nitrosomonas cryotolerans</i>	Obligately halophilic	42-59	
nitrospira	<i>Nitrosolobus multififormis</i>	No salt requirement		Soils (not acid)	
	<i>Nitrosovibrio tenuis</i>			Soils, rocks, and freshwater	
	<i>Nitrospira sp. I</i>				
α-Proteobacteria		<i>Nitrosococcus oceani</i>	Obligately halophilic		Marine environment

Source: Modified from Koops and Pommerening (2001).

The four NOB genera show more diverse phylogenetics with *Nitrobacter* within α-Proteobacteria, *Nitrococcus* within γ-Proteobacteria, *Nitrospina* within the δ-Proteobacteria, and the two species of the genus *Nitrospira*, *Nitrospira moscoviensis* and *Nitrospira marina* within a separate phylum close to the δ subclass of the Proteobacteria (Siripong and Rittmann 2007). These are summarized in Table 4-2 (Koops and Pommerening-Roser 2001). While *Nitrobacter* generally occur as free cells, *Nitrospira* are more commonly observed attached to flocs or biofilms in their natural environments.

Table 4-2. Phylogeny of Nitrite-Oxidizing Bacteria

Subclass of Proteobacteria	Species	Ecophysiological parameters	Preferred Habitat
<i>α-Proteobacteria</i>	<i>Nitrobacter alkalicus</i>	Alkali and halotolerant	Soda lakes
	<i>Nitrobacter winogradskyi</i>	No salt requirement	Freshwater, soils, rocks
	<i>Nitrobacter vulgaris</i>		
	<i>Nitrobacter hamburgensis</i>		
<i>γ-Proteobacteria</i>	<i>Nitrococcus mobilis</i>	Obligately halophilic	Marine environments
<i>δ-Proteobacteria</i>	<i>Nitrospina gracilis</i>	Obligately halophilic	
	<i>Nitrospira moscoviensis</i>	No salt requirement	Freshwater
	<i>Nitrospira marina</i>	Obligately halophilic	Marine environment

Source: Modified from Koops and Pommerening (2001).

Using molecular biology tools, researchers have identified diverse populations of AOB and NOB in activated sludge and fixed film nitrification systems. Siripong and Rittmann (2007) examined the diversity of nitrifying bacteria communities in the seven activated sludge facilities operated by the Metropolitan Water Reclamation District of Greater Chicago (MWRDGC) with varying SRT, temperature, and influent characteristics. They found the coexistence of AOB *Nitrosomonas* and *Nitrospira* genera in all facilities and the coexistence of NOB *Nitrobacter* and *Nitrospira* genera. Colder temperatures appeared to increase proportions of *Nitrospira* and *Nitrospira*. Park et al. (2002) found that the AOB community in an aerated-anoxic process was very diverse, with both *Nitrosomonas* and *Nitrospira* present. Others have shown that *Nitrosomonas* is very common in activated sludge treatment and *Nitrospira* is the most common NOB (Aoi et al. 2000; Coskuner and Curtis 2002; and Harms et al. 2003; Li et al. 2005).

In a laboratory fixed film fluidized bed reactor, Schramm et al. (1999) found a dominance of *Nitrospira* for AOB and *Nitrospira* for NOB. In contrast, Rowan et al. (2003) found a dominance of *Nitrosomonas* for AOB in a biological aerated filter and trickling filter receiving combined domestic and industrial wastewater.

Though their role in wastewater treatment has not been determined, it is notable that the diversity of ammonia oxidation via AMO extends to the domain Archaea with ammonia oxidation found in members to the kingdom Crenarchaeota. Originally thought to be a marine organism with their discovery by Fuhrman et al. (1992), they have also been found in a wide range of soils, in sediments, and in freshwater (Nicol and Schleper 2006). Furthermore, Leininger et al. (2006) found that they were more abundant than autotrophic bacteria for ammonia oxidation in soils. A marine Crenarchaeota isolated by Konneke et al. (2005) was able to grow as a chemoautotroph at rates comparable to AOB, and it also had a much higher affinity for ammonia (0.03 to 1.0 μM). However, the presence of organic substrate appeared to inhibit its growth.

4.4 Reactions and Stoichiometry of Nitrification

The energy yielding ammonia oxidation reaction by AOB is as follows:



In Equation 4-1, 1.5 moles of oxygen are required to oxidize 1 mole of ammonia and 2 moles of hydrogen are produced. Thus, the oxygen requirement to produce nitrite is 3.43 g O₂/g NH₄-N oxidized to NO₂-N. The energy producing reaction by NOB is as follows and shows the need for 1.14 g O₂/g NO₂-N oxidized to NO₃-N:



The overall reaction for the two-step oxidation process can be written as follows and accounts for alkalinity consumption by the hydrogen produced:



Based on the above stoichiometry, ammonia oxidation to nitrate requires 4.57 g O₂/g NH₄-N oxidized to NO₃-N and consumes 7.14 g alkalinity (as CaCO₃) per g NH₄-N oxidized (Tchobanoglous et al., 2003).

The oxygen required and alkalinity consumption per g NH₄-N removed calculated from Equation 4-3 will be less in reactors because some of the NH₄-N removed is consumed for biomass synthesis by the nitrifying bacteria. Werzernak and Gannon (1967) found that the oxygen consumption normalized to nitrogen removal was 4.33 g O₂/g NH₄-N oxidized to NO₃-N with 3.22 g O₂ used for NH₄-N oxidation to NO₂-N and 1.11 g O₂ for oxidation of NO₂-N to NO₃-N. This fits reasonably close to the stoichiometry presented by Haug and McCarty (1972) in which biomass yields of 0.15 g VSS/g NH₄-N and 0.02 g VSS/g NO₂-N removed were determined. Their balances are as follows:

Ammonia consumption:

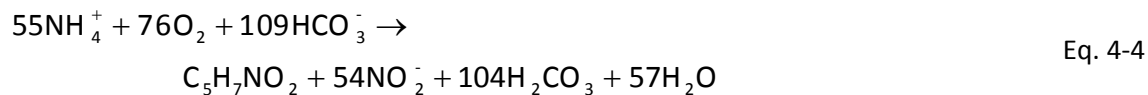

Nitrite consumption:

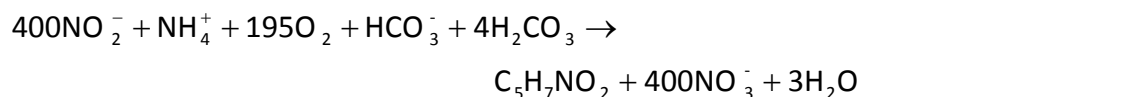

When accounting for synthesis per the above reactions, the calculated oxygen and alkalinity consumptions for NH₄-N removal are lower by about 5 percent and 1 percent, respectively. At longer SRTs with decay of nitrifiers, ammonia will be released and the difference is less. By ignoring synthesis and using the oxidation only values of **4.57 g O₂/g NH₄-N oxidized to NO₃-N** and **7.14 g alkalinity (as CaCO₃) per g NH₄-N oxidized, the results** are slightly conservative but practical for design estimates.

4.5 Nitrification Kinetics

Where ammonia removal is needed, nitrification kinetics will govern the activated sludge aerobic zone design as the nitrifying bacteria have slower growth rates than the BOD-consuming heterotrophic bacteria and thus require a longer SRT. Bacterial growth rate models (Monod model) or

substrate utilization models are commonly used to describe nitrification kinetics. The models are used to fit data from steady state or non-steady state nitrification systems to obtain appropriate coefficients. Because it has a significant effect on AOB and NOB growth rates, substrate utilization rates, and endogenous decay rates, temperature is accounted for in nitrification kinetic models. The models will be reviewed first before presenting kinetic coefficient information.

The Monod model is used to describe the specific growth rate of nitrifying bacteria as a function of the concentration of the nitrogen species being oxidized, DO concentration, and endogenous decay rate as shown in Equations 4.6 and 4.7 below for AOB and NOB, respectively. For completely mixed activated sludge systems at temperatures below 25°C, the process is sufficiently modeled by considering only the AOB, as the NOB are able to use nitrite much faster. However, at higher temperatures, the kinetics of both groups must be considered as the effect of higher temperature favors AOB more than NOB. This is an underlying basis for the Single Reactor High Activity Ammonia Removal Over Nitrite (SHARON®) process for nitrogen removal, which is described later in this chapter. For nitrification in batch fed systems or for aerobic reactors in series, it may be more appropriate to model both AOB and NOB to determine treatment NH₄-N and NO₂-N concentrations (Chandran and Smets, 2000).

$$\mu_{\text{AOB}} = \mu_{\text{max,AOB}} \left[\frac{S_{\text{NH}}}{S_{\text{NH}} + K_{\text{NH}}} \right] \left[\frac{S_{\text{o}}}{S_{\text{o}} + K_{\text{o,AOB}}} \right] - b_{\text{AOB}} \quad \text{Eq. 4-6}$$

$$\mu_{\text{NOB}} = \mu_{\text{max,NOB}} \left[\frac{S_{\text{NO}}}{S_{\text{NO}} + K_{\text{NO}}} \right] \left[\frac{S_{\text{o}}}{S_{\text{o}} + K_{\text{o,NOB}}} \right] - b_{\text{NOB}} \quad \text{Eq. 4-7}$$

Where:

- μ_{AOB} = Specific growth rate of ammonia-oxidizing bacteria, g VSS/g VSS – d
- μ_{NOB} = Specific growth rate of nitrite-oxidizing bacteria, g VSS/g VSS – d
- $\mu_{\text{MAX,AOB}}$ = Maximum specific growth rate of ammonia-oxidizing bacteria, g VSS/g VSS - d
- $\mu_{\text{MAX,NOB}}$ = Maximum specific growth rate of nitrite-oxidizing bacteria, g VSS/g VSS – d
- b_{AOB} = Specific endogenous decay rate of ammonia-oxidizing bacteria, g VSS lost/g VSS – d
- b_{NOB} = Specific endogenous decay rate of ammonia-oxidizing bacteria, g VSS lost/g VSS – d
- S_{NH} = NH₄⁺ – N concentration, mg/L
- K_{NH} = Half-velocity coefficient for NH₄⁺ – N, mg/L
- S_{o} = DO concentration, mg/L
- $K_{\text{o,AOB}}$ = Half – velocity coefficient for DO for AOB, mg/L
- S_{NO} = NO₂⁻ – N concentration, mg/L
- K_{NO} = Half – velocity coefficient for NO₂⁻ – N, mg/L
- $K_{\text{o,NOB}}$ = Half – velocity coefficient for DO for NOB, mg/L

The next several equations describe the specific growth rate of AOB, volumetric NH₄-N oxidation rates, and effluent NH₄-N concentration as a function of kinetic parameters and system SRT. An identical set of equations can be used for NOB to describe NO₂-N oxidation kinetics and are not written here.

$$\mu_{\text{AOB}} = \frac{1}{\text{SRT}} \quad \text{Eq. 4-8}$$

$$S_{\text{NH}} = \frac{K_{\text{NH}}(1 + b_{\text{AOB}}\text{SRT})}{\text{SRT}(\mu_{\text{max,AOB,DO}} - b_{\text{AOB}}) - 1.0} \quad \text{Eq. 4-9}$$

$$\mu_{\text{max,AOB,DO}} = \frac{(\mu_{\text{max,AOB}})(S_o)}{(S_o + K_{o,\text{AOB}})} \quad \text{Eq. 4-10}$$

Where:

SRT = Solids retention time, days

$\mu_{\text{max,AOB,DO}}$ = $\mu_{\text{max,AOB}}$ corrected for DO concentration, g/g – day

The next set of kinetic equations describes nitrification rates in batch tests using activated sludge or nitrifier enrichments grown in bench-scale studies. In this case, only the equations for AOB are shown but a similar set of equations would apply to NOB. From the Monod equation, bacteria-specific growth rate can be described as a function of substrate utilization.

$$\mu_{\text{AOB}} = \frac{r_{x,\text{AOB}}}{X_{\text{AOB}}} = \mu_{\text{max,AOB}} \left[\frac{S_{\text{NH}}}{S_{\text{NH}} + K_{\text{NH}}} \right] \left[\frac{S_o}{S_o + K_{o,\text{AOB}}} \right] \quad \text{Eq. 4-11}$$

Where:

$r_{x,\text{AOB}}$ = AOB growth rate, mg/L – day

X_{AOB} = AOB concentration, mg/L

$$r_{x,\text{AOB}} = \mu_{\text{max,AOB}} \left[\frac{S_{\text{NH}}}{S_{\text{NH}} + K_{\text{NH}}} \right] \left[\frac{S_o}{S_o + K_{o,\text{AOB}}} \right] X_{\text{AOB}} \quad \text{Eq. 4-12}$$

The rate of biomass growth is a function of the substrate utilization rate and synthesis yield coefficient:

$$r_{x,\text{AOB}} = Y_{\text{AOB}} (r_{\text{NH}}) \quad \text{Eq. 4-13}$$

Where:

r_{NH} = NH_4^+ – N oxidation rate, mg/L - day

Combining Equations 4.12 and 4.13 gives the NH_4 -N utilization rate.

$$r_{\text{NH}} = \left[\frac{\mu_{\text{max,AOB}}}{Y_{\text{AOB}}} \right] \left[\frac{S_{\text{NH}}}{S_{\text{NH}} + K_{\text{NH}}} \right] \left[\frac{S_{\text{o}}}{S_{\text{o}} + K_{\text{o,AOB}}} \right] X_{\text{AOB}} \quad \text{Eq. 4-14}$$

Besides the kinetic model parameters, the ammonia utilization rate depends on the AOB concentration, which can be calculated from a mass balance on the average daily amount of ammonia oxidized, the AOB synthesis yield and endogenous decay coefficient, and the average SRT (Tchobanoglous et al. 2003).

$$X_{\text{AOB}} = \frac{Q(Y_{\text{AOB}})(\text{Nox})\text{SRT}}{V(1 + b_{\text{AOB}}\text{SRT})} \quad \text{Eq. 4-15}$$

Where:

- X_{AOB} = AOB concentration, mg/L
- Q = Average daily influent flow, L/day
- Nox = NH₄⁺ - N oxidized by AOB from influent, mg/L
- V = Volume of reactor containing AOB, L

Combining Equations 4-14 and 4-15 gives the NH₄-N utilization rate with the growth reactor AOB:

$$r_{\text{NH}} = \mu_{\text{max,AOB}} \left[\frac{S_{\text{NH}}}{S_{\text{NH}} + K_{\text{NH}}} \right] \left[\frac{S_{\text{o}}}{S_{\text{o}} + K_{\text{o,AOB}}} \right] \left[\frac{Q(\text{Nox})\text{SRT}}{V(1 + b_{\text{AOB}}\text{SRT})} \right] \quad \text{Eq. 4-16}$$

Equations 4-9 and 4-16 represent expressions that can be used for two different types of tests to obtain nitrification kinetics. In the first case, the effluent NH₄-N concentration is measured at different operating SRTs to fit the model to obtain the maximum specific growth rate, $\mu_{\text{max,AOB}}$. For Equation 4-16, careful measurement of NH₄-N oxidation over time and SRT control and maintenance is needed before using the reactor biomass in batch nitrification tests in which r_{NH} versus S_{NH} is measured to obtain $\mu_{\text{max,AOB}}$ by model fitting. It should be noted that in both cases the value used for the endogenous decay rate, b_{AOB} , affects the calculated $\mu_{\text{max,AOB}}$ value.

4.5.1 AOB kinetics

In the nitrification model equations shown previously, the value used for the specific decay coefficient directly affects the calculated $\mu_{\text{max,AOB}}$ value. For a given observed nitrification rate or effluent NH₄-N concentration with SRT, higher specific decay coefficient values result in higher $\mu_{\text{max,AOB}}$ values and vice versa. Thus, it is difficult to compare nitrification kinetic values between studies without knowing the value for b_{AOB} , and the maximum specific growth rate is not accurately determined without an accurate determination of the specific endogenous decay rate coefficient (Dold et al. 2005).

In early work on nitrification kinetics, the specific endogenous decay rate was believed to be very low and generally ignored (Downing et al. 1964; USEPA 1993). Tests evaluating AOB nitrification kinetics revealed the importance of the specific endogenous decay rate value (Melcer et al. 2003). Similar $\mu_{\text{max,AOB}}$ values were obtained in a study using three different experimental methods to obtain nitrification kinetics and applying a b_{AOB} value of 0.17 g/g-d obtained in a separate test method (Dold et

al. 2002; Melcer et al. 2003). The specific endogenous decay coefficient obtained in the Water Environment Research Foundation (WERF) study is included in Table 4-3 and compares closely to results from other studies aimed at determining b_{AOB} . Manser et al. (2006) obtained similar specific endogenous decay rates for AOB and NOB and, in addition, obtained similar rates for membrane bioreactor (MBR) and conventional clarification activated sludge.

Lower specific endogenous decay coefficients have been found for anoxic-aerobic systems with Lee and Oleszkiewicz (2003), Nowak et al. (1994), and Siegrist et al. (1999) reporting about a 50-percent reduction in the decay rate. Temperature is also known to affect the endogenous decay rate of both heterotrophic and autotrophic microorganisms. The effect of temperature on the AOB endogenous decay rate was also determined in the WERF study (Melcer et al. 2003) from 10 to 20°C, and the temperature coefficient, θ , was found to be 1.029 in the temperature relationship given in Eq. 4-17 below.

$$b_{AOB,T} = b_{AOB,20} (\theta)^{(T-20)} \quad \text{Eq. 4-17}$$

Where:

- $b_{AOB,T}$ = Endogenous decay rate at temperature T, °C
- $b_{AOB,20}$ = Endogenous decay rate at 20°C
- θ = Temperature coefficient, 1.029

Table 4-3. Summary of Test Results on Measuring Specific Endogenous Decay Coefficient Rates (All Rates at 20°C)

Bacteria or source	Nitrifier group	Specific endogenous decay rate (b), g VSS/g VSS-day	Reference
Aerobic activated sludge	AOB	0.17	Melcer et al., 2003
Nitrobacter	NOB	0.14	Copp and Murphy, 1995
Aerobic activated sludge	AOB	0.17	Copp and Murphy, 1995
Aerobic activated sludge	AOB	0.15*	Manser et al., 2006
Aerobic activated sludge	NOB	0.14*	Manser et al., 2006
Aerobic activated sludge	AOB	0.20**	Nowak et al., 1994
Aerobic activated sludge	AOB	0.21**	Siegrist et al., 1999
Aerobic activated sludge	AOB	0.15	Lee and Oleszkiewicz, 2002
Anoxic-aerobic activated sludge	AOB	0.10	Lee and Oleszkiewicz, 2003
Aerobic activated sludge	AOB	0.09	Katehis et al., 2002

* Showed similar results for membrane bioreactor and conventional activated sludge systems.

** Reported that the decay rate under anoxic conditions was about ½ of the aerobic system rate.

Often referred to as μ_{AUT} , the μ_{max} value for AOB and NOB is a critical kinetic parameter and shown to be a function of temperature. AOB has historically been the focus of these kinetic evaluations, and results on the 20°C value and effect of temperature have varied widely. Reported values for early studies on AOB μ_{max} at 20°C range from 0.32-0.77 g/g-day (Downing et al. 1964; Downing and Hopwood 1964; Barnard 1975; Lawrence and Brown 1976; Hall and Murphy 1980; Randall et al. 1992), but these studies assumed negligible or very low specific endogenous decay rates. At the higher measured decay

rate, the WERF study (Melcer et al. 2003) obtained a 20°C μ_{\max} value of 0.90 g/g-day for three different test methods. However, more recent studies also show a wide range in AOB 20°C μ_{\max} values; 0.63 – 4.55 g/g-day (Chandran et al. 2008; Marsili-Libelli et al. 2001, and Iacopozzi et al. 2007).

Similarly, the reported effect of temperature on the 20°C μ_{\max} value has also ranged widely with the ratio of the 20°C μ_{\max} /10°C μ_{\max} from 2.2 to 3.7. The ratio in the WERF study (Melcer et al. 2003) was 2.0. Reported differences in kinetic data are the result of data analysis methods, activated sludge characteristics, and operating conditions. Comparing or using only single kinetic parameter values between studies may not be valid as the calculated kinetic value is related to the determined or assumed values for other kinetic parameters in the nitrification model. Because a complete set of model parameters were determined in the evaluation of AOB kinetics in the WERF study (Melcer et al. 2003), these values are given in the following nitrification AOB kinetic values in Table 4-4 for use in nitrification kinetic modeling (Eq. 4-9 through 4-16). These studies were done at DO concentrations in the 4-6 mg/L range so the DO half-saturation value was not evaluated. The value from the IWA activated sludge model report is used here (Henze et al. 2000). Designers should not take these values as absolute and if at all possible **measure and calibrate nitrification kinetic values for the design facility** (See Chapter 10, Section 10.8 for additional discussion).

Table 4-4. Summary of AOB Nitrification Kinetic Coefficient Values.

Parameter	Units	20°C Value	Temperature correction value, θ
Yield, Y	g VSS/g N oxidized	0.15	1.0
Specific endogenous decay rate, b	g VSS/g VSS-day	0.17	1.029
Maximum specific growth rate, μ_{\max}	g VSS/g VSS-day	0.90	1.072
Half-velocity coefficient, K_{NH}	mg/L	0.70	1.0
Half-velocity coefficient, K_0	mg/L	0.50	1.0

Source: All from Melcer et al. (2003) except the DO half-velocity coefficient; from Henze et al. (2000).

Mixing, floc size, and site specific operating conditions can affect nitrification kinetics. Large floc sizes and less mixing will have more diffusion limitations with lower inorganic nitrogen and DO concentrations within the floc. Thus, lower specific nitrification rates will be observed as the rates are normalized to the total VSS concentration or biomass concentration. The effect of kinetic limitations was discussed by Manser et al. (2005) in which they observed lower AOB and NOB half-velocity coefficient values (Table 4-5) for a conventional activated sludge versus MBR. The MBR had smaller floc size, which they reasoned was due to greater agitation for membrane scour. The effect was greatest on the oxygen half-velocity coefficient. If constant half-velocity coefficient values were assumed in interpreting the test data, a lower observed μ_{\max} value would have been determined.

Table 4-5. Comparison of Nitrification Half-Velocity Coefficients (mg/L) in MBR and Conventional Activated Sludge (CAS) Systems

Nitrifier group	MBR	CAS
AOB		
Oxygen, K_o	0.18	0.79
Ammonia, K_{NH}	0.13	0.14
NOB		
Oxygen, K_o	0.13	0.47
Ammonia, K_{NH}	0.17	0.28

Source: Manser et al. 2005.

In addition to floc size, the oxygen uptake rate (OUR) of the activated sludge can affect the observed nitrification rate at a given bulk liquid DO concentration due to more oxygen limitation in the floc at greater OURs. Stensel et al. (1993) showed that for a staged nitrification aeration tank, a higher DO concentration was needed to maintain the same nitrification rate at a given bulk liquid NH_4-N concentration for mixed liquor in the initial aerobic stages versus mid to latter stages. The higher OUR resulted in greater oxygen limitations in the activated sludge floc and affected nitrification rates. The effects of mixed liquor suspended solids (MLSS) concentration, floc size, and OUR are not currently factored into nitrification kinetic models. Also note that the transfer rate of DO to the nitrifiers ceases to be a significant nitrification factor in long hydraulic residence time (HRT) - long SRT systems such as extended aeration systems. For these systems, complete nitrification can be accomplished at very low DO concentrations, i.e. <0.3 mg/L, even though the kinetic rate would be faster if DO concentration was higher.

4.5.2 NOB kinetics

NOB kinetics are of major interest with regard to treating high temperature anaerobic digestion centrate or filtrate streams for nitrogen removal with the SHARON® process (discussed below) or for operating conditions that lead to higher effluent NO_2-N concentrations. Studies on NOB kinetics have been based on model fitting of pilot plant or bench-scale results in which selected parameters have been arbitrarily fixed or on evaluating one particular kinetic effect such as DO concentration. Previous work has shown that NOB are inhibited at low DO concentrations with NO_2-N concentrations increasing at low DO (Picioreanu et al. 1997; Garrido et al. 1997; Peng and Zhu 2006; Contreras et al. 2008), suggesting a higher K_o for NOB than AOB. Values for K_o for studies with NOB ranged from 0.50 to 1.75 mg/L. For studies with both NOB and AOB, the ratio of the NOB to AOB DO half velocity coefficients were 2.36 (Guisasola et al. 2005), 1.4 (Ciudad et al. 2006), and 0.59 (Manser et al. 2005). Absolute values of oxygen half-velocity coefficients depend on the operating and activated sludge floc conditions and possible diffusion limitations in addition to the bacterial affinity for DO.

Nitrite oxidation Kinetic coefficients used in model fits vary widely (Sin et al., 2008). Lacopozzi et al. (2007) presented a model for the two-step nitrification process using 20°C μ_{max} values from Marsili-Libellie et al. (2001) of 0.63 g/d-d for AOB and 1.04 g/g-d for NOB. Based on Eq. 4-17, their assumed temperature coefficient, θ , values for μ_{max} were 1.06 for both AOB and NOB. However, Kaelin et al. (2009) fit a two-step AOB and NOB kinetic model to BNR pilot plant data at winter and summer conditions with constant or intermittent aeration. Their data fit resulted in 20°C μ_{max} values of 0.90 and 0.65 g/g-d for AOB and NOB, respectively. They found that the effect of temperature was more pronounced with AOB versus NOB, and based on Eq. 4-17, their temperature coefficient, θ , values for both μ_{max} and b were 1.13 for AOB and 1.08 for NOB. These results are consistent with observations that

at higher temperatures, above 25°C, effluent NO₂-N concentrations can be higher than NO₃-N concentrations. There is little work on half-velocity coefficients for NO₂-N oxidation by NOB. Manser et al. (2005), in a comparative study, found that the NOB N substrate half-velocity coefficient was slightly higher than that for AOB, but observations on activated sludge nitrification suggests a lower half-velocity coefficient value. Based on the information in Table 4-3, the specific endogenous decay rate may be assumed equal at 20°C for AOB and NOB

A possible set of kinetic coefficients for NOB are given in Table 4-6 and are selected to represent the generally observed effects of temperature and DO concentration. The DO half-velocity coefficient is much lower than that for AOB, as shown by Contreras et al. (2008) and Guisasola et al. (2005). More research is needed on NOB kinetics, and site specific testing for model calibration may give a different set of values than that shown in Table 4-6.

Table 4-6. Summary of NOB Nitrification Kinetic Coefficient Values

Parameter	Units	20°C Value	Temperature correction value, θ
Yield, Y	g VSS/g N oxidized	0.05	1.0
Specific endogenous decay rate, b	g VSS/g VSS-day	0.17	1.063
Maximum specific growth rate, μ_{max}	g VSS/g VSS-day	1.00	1.063
Half-velocity coefficient, K_{NO}	mg/L	0.20	1.0
Half-velocity coefficient, K_0	mg/L	0.90	1.0

4.5.3 Effects of Temperature and Dissolved Oxygen on Nitrification Kinetics

The effects of temperature and aeration tank DO concentration on effluent NH₄-N and NO₂-N concentrations are illustrated in Figures 4-2 and 4-3, respectively for a single completely-mixed activated sludge (CMAS) aeration tank using Eqs. 4-9 and 4-10. No safety factors are built into these graphical presentations. Figure 4-2 shows that a much longer SRT is needed at a lower temperature to achieve low effluent NH₄-N concentrations and that the effluent NO₂-N concentration is always lower than the NH₄-N concentration. The example in Figure 4-3 shows that at the longer SRT needed to have an effluent NH₄-N concentration of 1.0 mg/L in a CMAS system at 10°C the effect of DO concentration on the effluent NO₂-N concentration is minimal, but at the higher 20°C temperature and lower SRT needed to achieve an effluent NH₄-N concentration of 1.0 mg/L, lower DO concentrations result in much higher effluent NO₂-N concentrations.

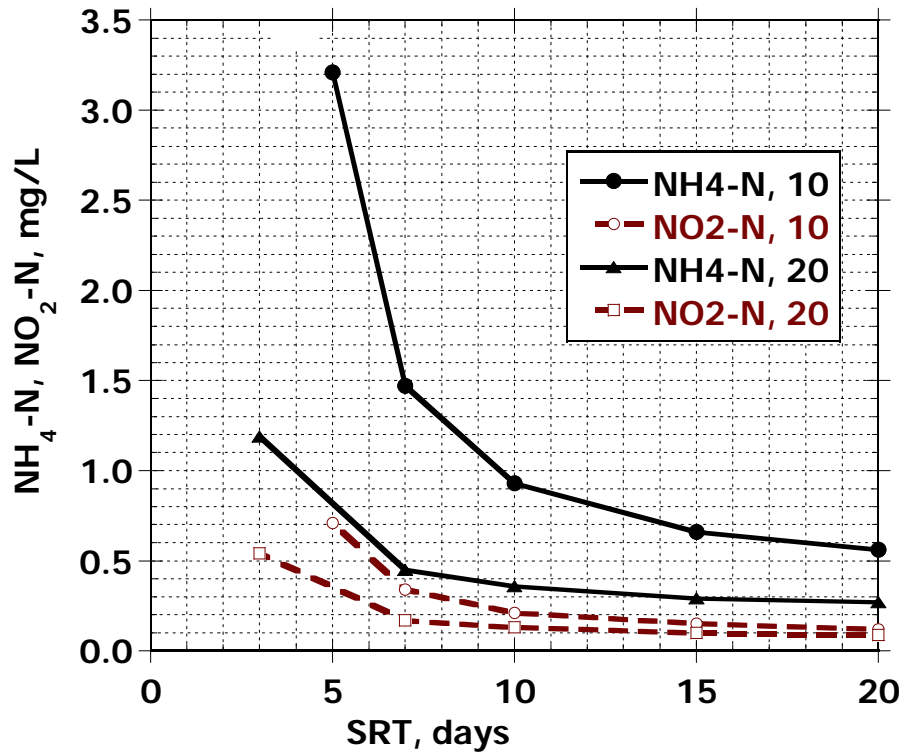

Figure 4-2. Effect of SRT and temperature on effluent $\text{NH}_4^+\text{-N}$ and $\text{NO}_2^-\text{-N}$ concentrations using kinetic data in Table 4-6 and 4-4 for CMAS with no safety factor

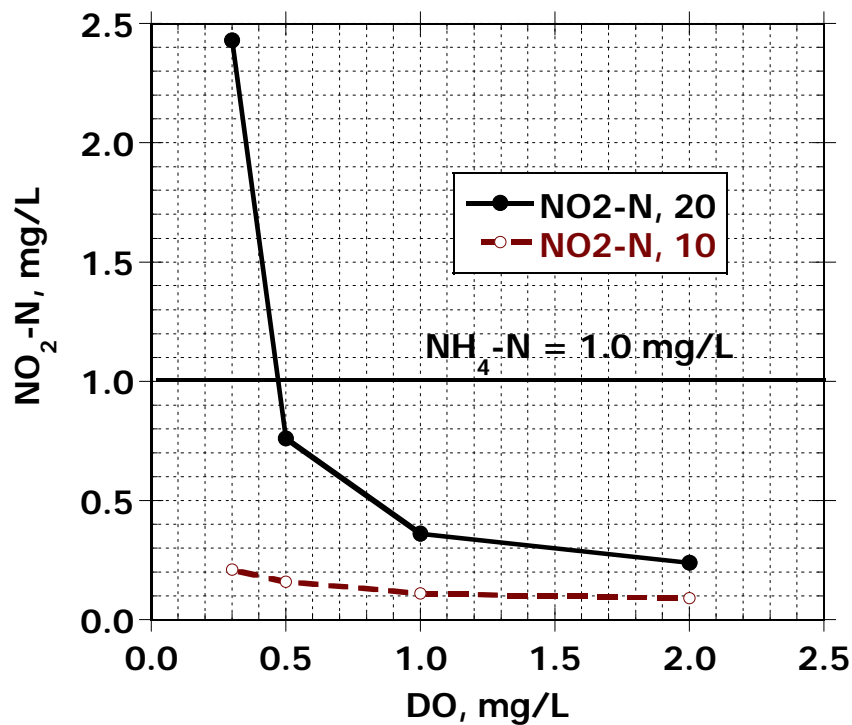

Figure 4-3. Effect of DO concentration on effluent $\text{NO}_2^-\text{-N}$ concentrations for SRTs at 10°C and 20°C that give an effluent $\text{NH}_4\text{-N}$ concentration of 1.0 mg/L using kinetic data in Table 4-4 and 4-6 for CMAS with no safety factor

It should be noted that the above examples on the effect of SRT, temperature and DO concentration were based on steady state conditions of constant flow and influent concentrations. Under typical diurnal flow and concentrations for domestic wastewaters, the SRT would have to be increased to achieve the same effluent concentrations shown. **Dynamic simulation models** are used for design to account for variable loading effects. (See Chapter 10 for detailed guidelines on using models for design of biological nitrogen removal systems.) Typically the SRT may be 40 to 80 percent greater than indicated by the figures.

The required SRT for nitrification can be reduced significantly for many applications by using a series of aeration tanks (staged systems) versus a single aeration tank. The effect depends on the influent nitrogen concentration to the aeration tank, temperature, and effluent NH₄-N concentration goal. The effect is less pronounced for systems with high return sludge recycle rates, such as MBRs, in which the influent nitrogen is substantially diluted.

4.5.4 AOB and NOB Kinetics at High Temperature (SHARON® process)

The effect of temperature on the relative AOB and NOB kinetics is important in the SHARON® (Single Reactor High Activity Ammonia Removal Over Nitrite) process used in sidestream treatment of high ammonia anaerobic digestion centrate/filtrate from biosolids dewatering (Van Hulle et al. 2007; Volcke et al. 2007). The process takes advantage of a high temperature condition (25°C to 35°C) in which the specific growth rate of AOB is higher than that for NOB, so that at low enough operating SRTs the NOB can be washed out and ammonia is oxidized to mainly nitrite (nitritation process). Low dissolved oxygen conditions can also hinder NOB growth rates in the process. Based on the oxygen requirements shown above of 3.22 g O₂ used for NH₄-N oxidation to NO₂-N and 1.11 g O₂ for oxidation of NO₂-N to NO₃-N, the nitritation process reduces the energy required for complete nitrification by 26 percent. The carbon needed for denitrification is also decreased.

Washout occurs when the SRT is lower than that needed to accommodate the maximum net growth rate of the nitrifiers in the reactor. From Equations 4-6 and 4-8, the washout or minimal SRT is as follows assuming excess N substrate and DO concentration:

$$SRT_{\min} = \frac{1}{\mu_{\max} - b} \quad \text{Eq. 4-18}$$

The washout SRT for AOB and NOB as a function of temperature using the kinetic coefficients in Tables 4-2 and 4-4, respectively, is compared to that claimed by Hellinga et al. (1998). Above 20°C, the washout SRT for AOB is similar and below that for NOB.

A comprehensive model for the SHARON® process, including alkalinity effects, pH, free ammonia and nitrous acid toxicity, and AOB and NOB kinetics was evaluated by Magri et al. (2007) with a bench scale reactor operation at 35°C. The model high temperature μ_{\max} and decay coefficient (b) values for AOB and NOB that best fit the lab results were 1.75 and 0.56 g/g-d and 0.23 and 0.04 g/g-d, respectively. These values result in washout SRTs of 0.66 days for AOB and 1.92 days for NOB, which is in the range of that shown for Figure 4-4 at 35°C.

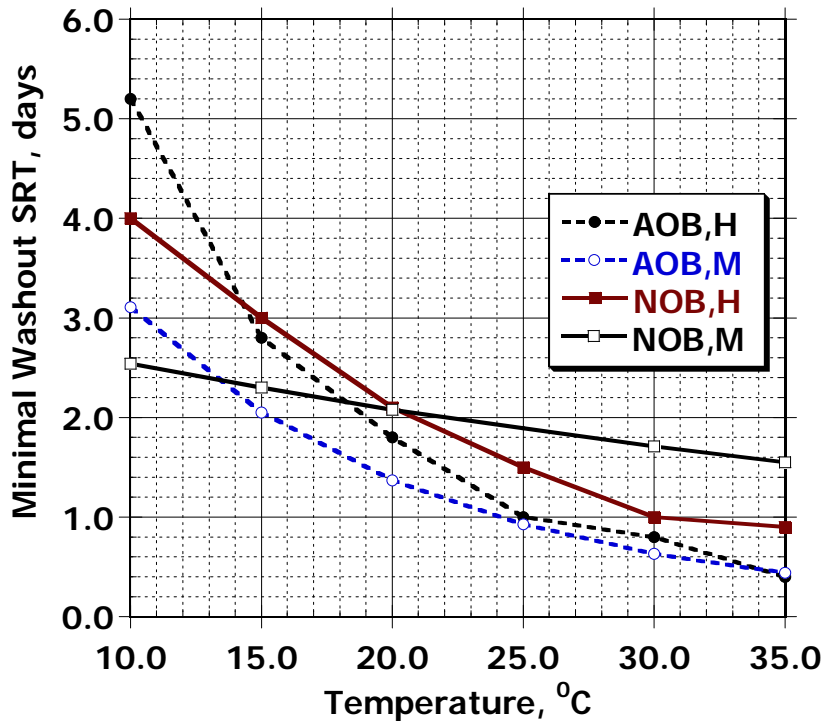

Figure 4-4. Effect of temperature on minimal washout SRT AOB, H and NOB, H from Hellinga et al. (1998) and AOB, M and NOB, M from Tables 4-2 and 4-4.

4.6 Inhibitory Effects of Environmental Conditions on Nitrification

Effect of pH

Ammonia oxidation rates decrease rapidly with decreasing pH below a pH of 6.8, and an optimal pH is in the range of 7.5 to 8.0 (Tchobanoglous et al. 2003). The effect of lower pH on the ammonia oxidation rate may be due to the reduction in free ammonia (NH_3) concentration, as Suzuki et al. (1974) reported that $\text{NH}_3\text{-N}$ is the true substrate for AOB. An operating pH of 7.0 to 7.2 is often used for design and operation to assure reliable nitrification rates, and for some facilities it is necessary to add alkalinity to maintain pH.

Effect of Free Ammonia and Nitrous Acid (HNO_2)

For high ammonia strength wastewaters, such as from anaerobic digester centrate return, animal feedlots, and industrial wastewater, the issue of $\text{NH}_3\text{-N}$ and HNO_2 concentration inhibition on AOB and NOB becomes important. Conditions that inhibit NOB activity to stop nitrification at $\text{NO}_2\text{-N}$ have been modeled for sequencing batch reactors (Pambrun et al. 2006; Kyung and Choi 2001).

$\text{NH}_3\text{-N}$ is more inhibitory to NOB than to AOB (Peng and Zhu, 2006), while HNO_2 is more inhibitory to AOB. Anthonisen et al. (1976) and Turk and Mavinic (1986) found NOB inhibition at $\text{NH}_3\text{-N}$ concentrations from 0.10 to 1.0 mg/L, whereas Mauret et al. (1996) found inhibition at 6.6 to 8.9 mg $\text{NH}_3\text{-N/L}$. Wong-Chong and Loehr (1975) reported inhibition by $\text{NH}_3\text{-N}$ at 3.5 mg/L for unacclimated

bacteria and 40 mg/L after an acclimation phase. Kyung and Choi (2001) found 50 percent inhibition at 11.1 mg NH₃-N/L.

For AOB inhibition by NH₃-N, Anthonisen et al. (1976) reported higher concentrations than for NOB at 7.0 mg/L, and Abeling and Seyfried (1992) found complete loss of activity at a 20 mg NH₃-N/L concentration. However, with acclimation Wong-Chong and Loehr (1975) found stable AOB activity at 50 mg NH₃-N/L. HNO₂ concentrations found inhibitory to AOB were 0.065 to 0.83 mg/L by Anthonisen et al. (1976).

The relative concentration of NH₃-N and HNO₂ are a function of pH and temperature and can be calculated according to Anthonisen et al. (1976):

$$\text{NH}_3\text{-N} = \frac{\text{TAN}(10^{\text{pH}})}{\frac{1}{K_a} + 10^{\text{pH}}} \quad \text{Eq. 4-19}$$

and Eq. 4-20

$$\frac{1}{K_a} = \exp\left[\frac{6,334}{273 + T}\right]$$

$$\text{HNO}_2\text{-N} = \left(\frac{\text{NO}_2\text{-N}}{K_n * 10^{\text{pH}}}\right) \quad \text{Eq. 4-21}$$

and Eq. 4-22

$$K_n = \exp\left[-\frac{2,300}{273 + T}\right]$$

Where:

- TAN = Total ammonia nitrogen, NH₃-N + NH₄⁻-N concentration, mg/L
- HNO₂-N = Free nitrous acid concentration as N, mg/L
- NO₂-N = Nitrite concentration as N, mg/L
- T = Temperature, °C
- K_a = Ionization constant for ammonium
- K_n = Ionization constant for nitrous acid

Values for K_a and K_n at 25°C are 10^{-9.24} and 10^{-3.4}, respectively.

The above equations were used to calculate possible TAN and NO₂-N concentrations that may inhibit AOB and NOB at pH values from 6.0 to 8.0 at 20°C. Results are summarized in Table 4-7

Table 4-7. NH₄-N and NO₂-N Concentrations that May Inhibit Nitrification as a Function of pH at 20°C.

NH₃ Inhibition		
	AOB (7.0 mg NH ₃ -N/L)	NOB (0.10 to 3.5 mg NH ₃ -N/L)
pH	NH ₄ -N, mg/L	NH ₄ -N, mg/L
6.0	17,100	244-8,500
6.5	5,400	77-2,700
7.0	1,700	25-860
7.5	550	8-274
8.0	178	3-89
HNO₂ Inhibition		
	AOB (0.065 to 0.80 mg HNO ₂ /L)	
pH	NO ₂ -N, mg/L	
6.0	25-311	
6.5	80-986	
7.0	253-3,118	
7.5	801-9,861	
8.0	2,533-31,185	

Effect of salinity

Nitrifying bacteria are able to maintain activity under high saline concentrations. Campos et al. (2002) found 100 percent nitrification at 13.7 g NaCl/L but a decline at close to 20 g/L.

Inorganic and Organic Compound Inhibitors to Nitrification

Nitrifying bacteria are much more susceptible to inhibition than are heterotrophic bacteria. They are affected by a wide range of organic and inorganic compounds that in many cases does not kill them but greatly reduces their growth rate. Because of their sensitivity, they have been proposed as indicators of the presence of toxic compounds at low concentrations (Blum and Speece 1991). Toxic organic compounds include organic solvents, amines, phenolic compounds, alcohols, cyanates, ethers, carbamates, and benzenes. The most significant heavy metals that are toxic to nitrifying bacteria at low reactor soluble concentrations are nickel (0.25 mg/L), chromium (0.25 mg/L), and copper (0.10 mg/L) (Tchobanoglous et al. 2003). Appendix B presents a list of known organic compounds that have been identified as inhibitory to nitrification (WEF and ASCE 1998).

4.7 Denitrification Fundamentals

Denitrification is the biological reduction of nitrate or nitrite and can be assimilatory and/or dissimilatory. Assimilatory denitrification involves the reduction of nitrate or nitrite to NH₄-N for use in biomass synthesis when NH₄-N is not otherwise available. Most references to biological denitrification for nitrogen removal refer to dissimilatory denitrification in which nitrate/nitrite is the ultimate electron acceptor in the bacteria cell respiratory electron transport chain for the oxidation of various organic and inorganic substrates.

Nitrate reduction follows a series of intermediate products, nitrite (NO_2^-), nitric oxide (NO), and nitrous oxide (N_2O) to nitrogen gas (N_2), with each step using a specific reductase enzyme in the respiratory chain to transfer electrons. NO and N_2O are nitrogen gases and the emission of N_2O is of great concern because it is one of the most significant greenhouse gases (See Chapter 2 for additional discussion).



Denitrification can be accomplished by heterotrophic bacteria oxidizing organic substrates, heterotrophic nitrifying bacteria, and autotrophic bacteria. Heterotrophic bacteria are mainly responsible for denitrification in the biological nitrification-denitrification processes. Most heterotrophic bacteria responsible for biological denitrification use BOD in influent wastewater as facultative aerobic bacteria with the ability to use elemental oxygen, nitrate, or nitrite as their terminal electron acceptors for the oxidation of organic material. When oxygen is present, they will use oxygen as the electron acceptor, but the reductase enzymes for denitrification are induced in the absence of oxygen (Payne 1973). Autotrophic denitrification is of interest for higher temperature recycle streams from anaerobic digestion centrate/filtrate with the ANAMMOX[®] bacteria process being the prime example.

Microbiologists generally use the term “anaerobic” to describe biological reactions in the absence of oxygen. To distinguish anaerobic conditions for which the biological activity occurs mainly with nitrate or nitrite as the electron acceptor in biological nitrification-denitrification processes, the term “anoxic” has been applied.

4.8 Microbiology of Denitrification

Heterotrophic bacteria capable of denitrification are very common in wastewater treatment and include the following genera: *Achromobacter*, *Acinetobacter*, *Agrobacterium*, *Alcaligenes*, *Arthrobacter*, *Bacillus*, *Chromobacterium*, *Corynebacterium*, *Flavobacterium*, *Hypomicrobium*, *Moraxella*, *Nesseria*, *Paracoccus*, *Propionibacteria*, *Pseudomonas*, *Rhizobium*, *Rhodopseudomonas*, *Spirillum*, and *Vibrio* (Tchobanoglous et al. 2003).

In many BNR process applications, a supplemental carbon source has been needed to (1) provide sufficient carbon for nitrate/nitrite reduction for wastewaters with lower C/N ratios, (2) accelerate denitrification rates to reduce tank volume requirements, or (3) provide a carbon source for further nitrate/nitrite reduction in post-anoxic systems such as denitrification filters. Methanol (CH_3OH) has been commonly used because it is inexpensive, but because of its unique single-carbon compound structure, it supports growth of a less diverse, more specific bacterial population. The methanol-utilizing bacteria commonly found in denitrifying system are bacteria of the genus *Hyphomicrobium* (Timmermans and Van Haute 1983; Sperl and Hoare 1971) and possibly *Paracoccus denitrificans* (Van Verseveld and Stouthamer 1978). Recently, using stable isotope probing, Baytshtok et al. (2008) identified a *Methyloversatilis universalis* strain in addition to *Hyphomicrobium zavarzinii*.

A heterotrophic nitrifying bacterium that can denitrify and has been studied often is *Paracoccus pantotropha*, which obtains energy by nitrate or nitrite reduction while oxidizing ammonia under aerobic conditions. A readily available carbon source, such as acetate, is needed (Robertson and

Kuenen, 1990). The conditions required for this form of denitrification are not practical in biological wastewater treatment.

Denitrification has been observed for a number of autotrophic bacteria using nitrate/nitrite to oxidize a variety of electron acceptors including zero valence iron and Fe(II) by *Paracoccus ferrooxidans*, *Paracoccus denitrificans*, *P. pantotrophus*, and *P. versutus* (Kumaraswamy et al. 2006 Kielemoes et al. 2000), reduced sulfur compounds by *Thiobacillus denitrificans* (Bock et al. 1995) and ammonia by *Nitrosomonas eutropha*, *nitrosomonas europaea*, and *nitrosolobus multififormis* (Poth and Focht 1985; Zart and Bock 1998; Schmidt et al. 2003). Ammonia oxidation by *nitrosomonas* under anoxic conditions has been shown to be slow and of little practical significance in activated sludge treatment (Littleton et al. 2003).

More recently Mulder et al. (1995) discovered a unique autotrophic bacteria in a denitrifying fluidized bed reactor with the ability to oxidize ammonia to nitrogen gas using nitrite as the electron acceptor. This biological reaction was termed ANAMMOX (ANAerobic AMMONia OXidation). The autotrophic organisms capable nitrite reduction without carbon addition have been identified in the ANAMMOX® process (Schmidt et al. 2003) as *Candidatus Brocadia anammoxidans* and *Candidatus Kuenenia stuttgartiensis* and belong to the order *Planctomycetales*, a division within the domain Bacteria (Strous et al. 1999). Under anaerobic conditions, ammonia is oxidized with the reduction of nitrite to produce nitrogen gas. They are slow growing organisms, and the reaction is best accomplished at temperatures above 25°C.

4.9 Metabolism and Stoichiometry of Heterotrophic Denitrification

Soluble organic substrates are consumed during heterotrophic denitrification, with a portion of the substrate COD oxidized using nitrate or nitrite as the electron acceptor and the other COD portion found in cell biomass. For denitrification of influent wastewater such as in pre-anoxic zones before aeration, the soluble organic substrate consumed is from the following:

- The soluble degradable COD in the influent wastewater
- Hydrolysis of biodegradable particulate and colloidal COD in the influent wastewater
- Degradable COD release from endogenous decay

Oxidation reactions are shown as follows for wastewater represented as $C_{10}H_{19}O_3N$ (Tchobanoglous et al. 2003) and common exogenous substrates.

Wastewater:

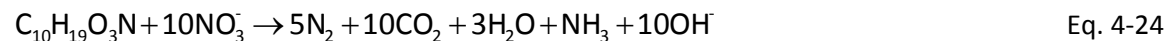

Methanol:



Ethanol:

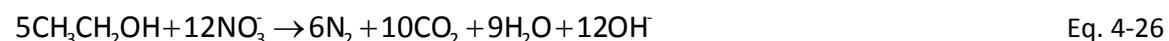

Acetate:

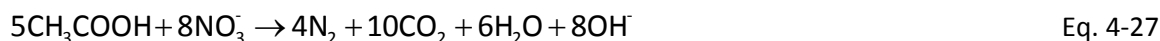

In all these reactions, 1 mole of hydroxide alkalinity is produced per mole of NO_3^- reduced or one equivalent OH per equivalent N. This equates to 50 mg alkalinity as CaCO_3 per 14 mg N reduced or 3.57 mg alkalinity as CaCO_3 produced per mg NO_3^- -N reduced. The same alkalinity ratio also applies to NO_2^- -N reduction.

In the above reactions, nitrate serves as an electron acceptor for oxidation-reduction reactions to oxidize the organic substrate as is done with oxygen as the electron acceptor. Because COD balances are useful in biological process design to equate the biodegradable substrate consumed to oxygen or electron acceptor needs plus biomass COD, it is convenient to understand the oxygen equivalent of NO_3^- -N and NO_2^- -N. This can be done by comparing the half reactions for a mole of electron transfer as follows:

Oxygen:



Nitrate:



Nitrite:



For NO_3^- -N, 0.20 moles are equivalent to the oxidation by 0.25 moles of oxygen, and thus the oxygen equivalent of NO_3^- -N equals $(0.25 \times 32) / (0.20 \times 14) = 2.86 \text{ g O}_2 \text{ equivalent/g NO}_3^-$ -N reduced. Similarly, the oxygen equivalent of NO_2^- -N is $1.73 \text{ g O}_2/\text{g NO}_2^-$ -N reduced. Thus, less substrate oxidation is needed per unit of oxidized nitrogen removed for NO_2^- -N reduction compared to NO_3^- -N reduction so that processes that stop nitrification at NO_2^- -N need less carbon for denitrification.

4.10 Biological Denitrification Kinetics with Influent Wastewater

Denitrification rates in pre- or post-anoxic zones in BNR processes depend on many factors. A semi-empirical approach has been to assess the rate in terms of a **specific denitrification rate** (SDNR) in terms of g NO_3^- -N reduced/g mixed liquor VSS (MLVSS)-day. Depending on the wastewater characteristics, temperature, and design loading to a pre-anoxic zone, the SDNR may range from 0.03 to 0.20 g NO_3^- -N/g MLVSS-day. For post-anoxic tanks it may range from 0.01 to 0.03 g NO_3^- -N/g MLVSS-day, where the denitrification rate is driven mainly by endogenous respiration rates (Tchobanoglous et al. 2003). The denitrification rate in an activated sludge reactor is affected by many factors and can be determined using simulation models based on kinetic equations.

The organic substrate removal rate by denitrifiers determines the nitrate reduction rate. The substrate removal rate is commonly described by Monod kinetics as follows and is affected by the organic substrate, NO_3^- -N and DO concentrations, and the biomass in the reactor that are facultative nitrate reducers:

$$r_{ss} = \frac{1}{Y_H} \left(\frac{\mu_{\max}(S_s)}{K_s + S_s} \right) \left(\frac{S_{NO}}{K_{NO} + S_{NO}} \right) \left(\frac{K_{O,H}}{S_O + K_{O,H}} \right) (\eta) X_H \quad \text{Eq. 4-31}$$

Where:

- r_{ss} = Substrate utilization rate in the reactor, mg/L-d
- Y_H = Heterotrophic bacteria synthesis yield, g VSS/g COD used
- μ_{\max} = Maximum specific growth rate of denitrifying heterotrophs, g VSS/g VSS-d and is a function of temperature
- S_s = Soluble degradable substrate concentration, mg COD/L
- K_s = Substrate utilization half-velocity coefficient, mg COD/L
- S_{NO} = $\text{NO}_3\text{-N}$ concentration, mg/L
- K_{NO} = Nitrate half-velocity coefficient, mg/L
- $K_{O,H}$ = DO inhibition constant for nitrate reduction, mg/L
- S_O = DO concentration
- η = Fraction of heterotrophic bacteria that can use nitrate in lieu of oxygen
- X_H = Heterotrophic bacteria concentration, mg/L

Additional equations and mass balances are required for the reactor to determine the reactor soluble degradable COD concentration as a function of utilization with nitrate, soluble substrate entering the reactor, and soluble substrate produced via hydrolysis of particulate and colloidal degradable COD and from cell lysis due to endogenous decay. Wastewaters with a higher influent soluble biodegradable COD fraction will have higher denitrification rates as the hydrolysis step to convert particulate and colloidal COD to readily useable soluble COD is slower than the soluble COD uptake rate.

The nitrate utilization rate is related to the fraction of biodegradable COD used that is oxidized and incorporated into cell mass. A mass balance on degradable COD accounts for COD oxidized using $\text{NO}_3\text{-N}$ and COD incorporated into cell synthesis as follows (Tchobanoglous et al. 2003):

$$r_{NO} = \frac{1 - 1.42Y_H}{2.86} r_{ss} \quad \text{Eq. 4-32}$$

Where:

- r_{NO} = $\text{NO}_3\text{-N}$ reduction rate, mg/L-day

and combining Eq. 4-31 and 4-32 gives the reactor $\text{NO}_3\text{-N}$ reduction rate as follows:

$$r_{NO} = \left(\frac{1 - 1.42Y_H}{2.86Y_H} \right) \left(\frac{\mu_{\max}(S_s)}{K_s + S_s} \right) \left(\frac{S_{NO}}{K_{NO} + S_{NO}} \right) \left(\frac{K_{O,H}}{S_O + K_{O,H}} \right) (\eta) X_H \quad \text{Eq. 4-33}$$

The value for η is affected by the system operating conditions and how much of the growth substrate is consumed under anoxic conditions. Stensel and Horne (2000) showed that this can be at least 0.80 for anoxic/aerobic BNR systems with significant BOD removal in a pre-anoxic zone. Literature values for the heterotrophic kinetics coefficients in Eq. 4-31 vary widely and may be system specific for the DO inhibition and half-velocity coefficients. Examples of coefficient values are given in Table 4-8.

Table 4-8. Heterotrophic Bacteria Kinetic Coefficients in Anoxic/Aerobic Activated Sludge

Kinetic Model Parameter	Units	Typical Value
Maximum specific growth rate, μ_{\max}	g VSS/g VSS-d	3.2
Temperature coefficient, θ	-	1.029
Heterotrophic bacteria synthesis yield, Y_H	g VSS/g COD removed	0.47
Substrate utilization half-velocity coefficient, K_s	mg COD/L	5.0
Nitrate half-velocity coefficient, K_{NO}	mg NO_3 -N/L	0.10
DO inhibition constant, $K_{O,H}$	mg DO/L	0.02

Source: Barker and Dold (1997)

The DO inhibition coefficient in Eq. 4-33 attempts to account for the inhibitory effect of oxygen on denitrification. DO inhibition on denitrification has been shown at DO concentrations of 0.20 mg/L by Skerman and Mori (1975) and Dawson and Murphy (1972). Oxygen inhibition is greater on nitrite reduction than on nitrate reduction. There is less concern about pH effects on denitrification than for autotrophic bacteria, though Dawson and Murphy (1972) showed a decrease in denitrification rates as the pH was decreased from 7.0 to 6.0 in batch tests.

4.11 Denitrification Carbon Sources and Relative Consumption Ratios

Denitrifying bacteria need a readily available carbon food source, such as soluble BOD, to rapidly convert nitrate to nitrogen gas. WWTPs that meet very low total nitrogen limits often use a secondary anoxic zone in which supplemental carbon is added.

A general rule of thumb is that **4 g of wastewater influent BOD is needed per g of NO_3 -N to be removed** through biological treatment (Tchobanoglous et al. 2003). When denitrification is needed after nitrification, there is little BOD remaining so a supplemental carbon source is often needed. Supplemental sources can be “internal,” such as fermented wastewater or sludge, or “external” or exogenous sources, such as purchased chemicals. The most common exogenous carbon source in use is methanol; however, due to issues regarding its safety, kinetic rates, and availability, some wastewater systems are using alternative carbon sources such as acetic acid, ethanol, sugar, glycerol, and proprietary solutions depending on the needs of their particular facility (deBarbadillo et al. 2008).

Equation 4-32 can be rearranged to show the ratio of biodegradable COD required for complete NO_3 -N reduction as a function of the biomass synthesis yield. This is similar to the consumptive ratio advanced by McCarty et al. (1969), in which they showed that exogenous substrates with lower biomass synthesis yields had lower consumptive ratios, and thus required less substrate addition relative to the amount of NO_3 -N to be removed. The consumptive ratio for methanol was about 70 percent of that for glucose, which had a higher biomass synthesis yield coefficient. A lower biomass synthesis yield means that the bacteria oxidize a greater portion of the substrate to provide energy for biomass growth and thus a greater portion of the COD used is oxidized by NO_3 -N with less ending up in sludge production.

$$CR_{NO_3} = \frac{bCOD}{NO_3 - N} = \frac{2.86}{1 - 1.42Y_H} \quad \text{Eq. 4-34}$$

Where:

CR_{NO_3} = g COD used/g NO_3 -N that is completely reduced in the anoxic zone.

Note that the value of $1.42(Y_H)$ is equal to the biomass yield in g biomass COD produced per g COD consumed for an assumed biomass formula of $C_5H_7N_2O$.

Based on the oxygen equivalent of the electron acceptor, a similar CR can be determined for bacteria using NO_2 -N or oxygen in an anoxic zone. Oxygen may enter the anoxic zone in recycle flows or in the influent wastewater. Thus the total exogenous chemical dose must account for other electron acceptors entering the anoxic zone besides NO_3 -N.

$$CR_{NO_2} = \frac{bCOD}{NO_2 - N} = \frac{1.73}{1 - 1.42Y_H} \quad \text{Eq. 4-35}$$

Where:

CR_{NO_2} = g COD used/g NO_2 -N that is completely reduced in the anoxic zone.

Comparison of Equations 4-34 and 4-35 shows that the COD addition for NO_2 reduction is about 60 percent of that for NO_3 reduction.

$$CR_{O_2} = \frac{bCOD}{DO} = \frac{1.0}{1 - 1.42Y_H} \quad \text{Eq. 4-36}$$

Where:

CR_{O_2} = g COD used/g DO that is completely reduced in the anoxic zone.

Figure 4-5 shows the effect of the biomass yield on the ratio of electron donor needed as COD to NO_3 -N reduced to N_2 . Substrates that have lower biomass yields will require lower consumptive ratios.

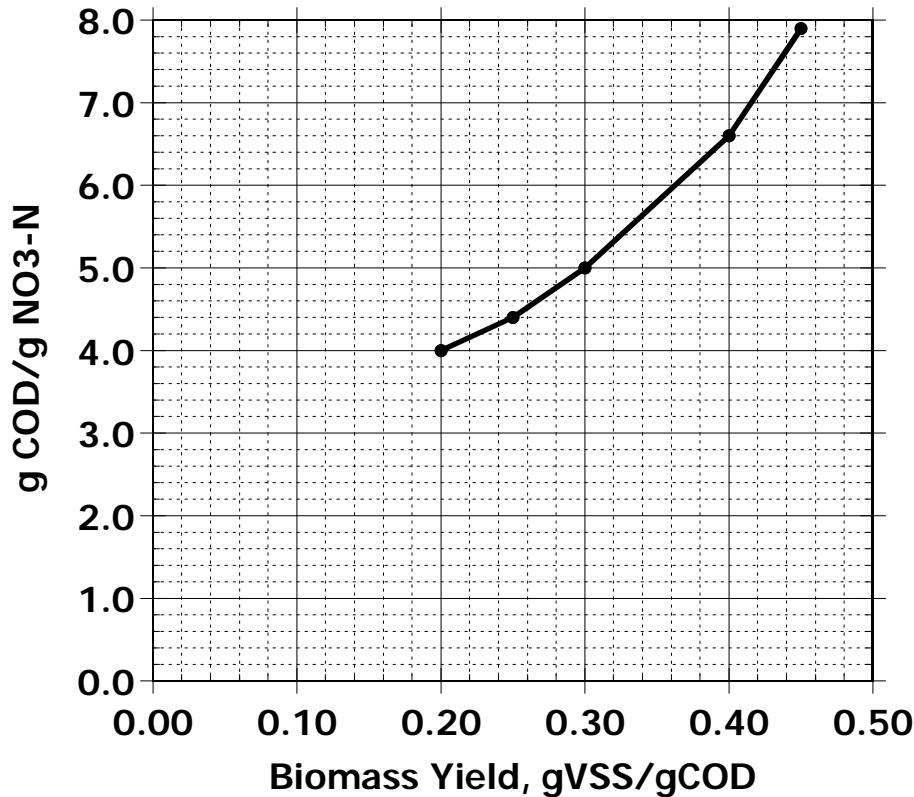

Figure 4-5. Ratio of COD required to NO₃-N completely reduce NO₃-N (CR_{NO₃}) as a function of the biomass yield.

It should be noted that the biomass yield value in Equations 4-34 through 4-36 can also represent the overall observed yield depending on the denitrification process design and where endogenous decay occurs for the biomass grown on the electron donor. For example, if the exogenous substrate is added in a tertiary application in which the reactor is mainly anoxic, the yield in the CR equations can be taken as the observed yield (Y_{obs}) for the system as follows:

$$CR_{NO_3} = \frac{2.86}{1 - 1.42 Y_{obs}} \quad \text{Eq. 4-37}$$

$$Y_{obs} = \frac{Y_H}{1 + bSRT} \quad \text{Eq. 4-38}$$

If the exogenous substrate is added to an anoxic reactor in a BNR system, Equation 4-34 is more applicable for NO₃ reduction as most of the endogenous decay for the methylotrophs will occur in other aerobic and anoxic zones, which represent a large proportion of the total volume. However, the estimated substrate addition should also take into account the nitrate demand from endogenous decay by the mixed liquor in the anoxic zone, which would include that by methylotrophs and other heterotrophs. The electron acceptor demand by the endogenous decay would consume a certain amount of NO₃-N. The consumptive ratio can then be applied to the remaining NO₃-N to be removed in that zone to estimate the exogenous substrate demand. A further consideration that will raise the substrate demand is that not all of the exogenous substrate added will be used. Equation 4-33 shows

that there must be a finite substrate concentration to drive the nitrate reduction rate. For systems with smaller anoxic tank volumes, a higher reactor substrate concentration is needed to remove the $\text{NO}_3\text{-N}$ at a faster rate, which increases the loss of substrate to the reactor effluent and increases the total exogenous substrate demand above that predicted by the consumptive ratio. Systems with higher internal recycle flows through the anoxic zone receiving exogenous substrates will have a higher overall feed $\text{COD}/\text{NO}_3\text{-N}$ ratio.

Values for biomass synthesis or observed yields are helpful for estimating exogenous organic carbon feed quantities for nitrate/nitrite removal. Information on biomass yields for methanol (the most commonly used exogenous substrate) and other possible exogenous substrates are summarized in Table 4-9. In many cases, the yields are observed yields based on data fits from test data or calculated using Eq. 4-37 and the reported $\text{COD}/\text{NO}_3\text{-N}$ ratio.

The higher the biomass yield, the higher will be the required dose for the exogenous substrate. For methanol, the yields ranged from about 0.20 to 0.30 $\text{gVSS}/\text{g COD}$. Using Eq. 4-37 or Figure 4-4, the CR_{NO_3} requirement for methanol is 4.0 to 5.0 $\text{g COD}/\text{g NO}_3\text{-N}$. Methanol has a COD of 1.5 $\text{g COD}/\text{g CH}_3\text{OH}$, so the requirement based on methanol is 2.7 to 3.3 $\text{g CH}_3\text{OH}/\text{g NO}_3\text{-N}$. Field applications in the range of 3.5 to 3.8 are common and account for the yield and the net effect of mixed liquor endogenous decay, entering DO, and effluent methanol. Based on the yields in Table 4-9, the dose for acetate and ethanol will be higher than that for methanol. CR_{NO_3} values ranged from 2.2 to 0.2 in an evaluation of 30 industrial waste organics by Monteith (1980).

Table 4-9. Biomass Yields Reported for Exogenous Carbon Sources

Substrate	Biomass Yield g VSS/g COD	Reference
Methanol	0.18	Stensel et al. (1973)
	0.28 ¹	Dold et al. (2008)
	0.29	Daigger et al. 2007
	0.21	Christensson et al. (1994)
	0.33 ¹	Sobieszuk et al. (2006)
	0.16 ²	Carrera et al. (2003)
	0.29 ²	Cherchi et al. (2008)
	0.29	Baytshtok et al. (2008)
Ethanol	0.30	Purtschert and Gujer (1999)
Ethanol	0.36 ²	Christensson et al. (1994)
	0.35 ²	Cherchi et al. (2008)
Acetate	0.66	Kujawa & Klapwijk (1999)
Glycerin	0.32 ²	Bilyk et al. (2009)
Glycerin	0.28 ²	Bilyk et al. (2009)
Glycerin	0.30 ²	Bilyk et al. (2009)
Glycerin	0.27 ²	Bilyk et al. (2009)
Glycerin	0.32 ²	Bilyk et al. (2009)
Glycerin	0.34 ²	Bilyk et al. (2009)
Glycerin	0.26 ²	Bilyk et al. (2009)
Glycerin	0.32 ²	Bilyk et al. (2009)
Glucose	0.42 ²	Bilyk et al. (2009)
Corn Syrup	0.38 ²	Bilyk et al. (2009)

¹Observed yield²From COD/N ratio

4.12 Denitrification Kinetics of Exogenous Carbon Sources

Because methanol has historically been the most commonly used exogenous carbon source, it has received the most attention from industry experts regarding its degradation kinetics. More recently, there has been greater interest in denitrification kinetics using ethanol, acetate, and glycerol.

4.12.1 Denitrification Kinetics with Methanol

Kinetic coefficients for methanol-utilizers have been evaluated based on a Monod model (Eq. 4-10), and results for μ_{\max} from various investigators are summarized in Table 4-10 along with temperature effects according to Equation 4-17. The range of temperature correction coefficients shown by Dold et al. (2008) are based on two different methods. The higher value is based on their high food-to-microorganism (F/M) test procedure to obtain μ_{\max} . The authors believe that the endogenous decay coefficient assumption may have biased the temperature correction value. The lower correction value is based on observed specific denitrification rates for their methanol enrichments. In the study by Baytshtok et al. (2008), μ_{\max} was also determined under conditions using nitrite as an electron acceptor instead of nitrate, and a much lower specific growth rate was found at 0.28 g VSS/g VSS-day.

Although there are considerable results reported for the yield coefficient for methanol utilization (Table 4-9), there is minimal information on the endogenous decay rate coefficient. Stensel et al. (1973) reported a value of 0.04 g/g-d, and Purtschert and Gujer obtained a value of 0.25 g/g-d in their

model fit to denitrification kinetics with methanol. It should be noted that an endogenous decay coefficient value (b) of 0.04 g/g-day was used by Nichols et al. (2007) and Dold et al. (2008). The use of higher values in the data fitting methods would have resulted in higher μ_{\max} values.

The results reported by Purtschert and Gujer are of practical interest for BNR processes with methanol feeding. Overdosing methanol to the anoxic zone or having a high methanol concentration in the anoxic zone effluent to support high denitrification rates will then support growth of methylotrophs under aerobic conditions. Their results suggest that the substrate utilization rates by methylotrophic organisms grown under aerobic conditions may be lower than that grown under anoxic conditions. Thus, kinetic models for methanol utilization in BNR processes may have to consider two methylotrophic populations: those grown under (1) anoxic and (2) aerobic conditions.

Table 4-10. Reported Maximum Specific Growth Rates at 20°C and Temperature Coefficients for Methanol Utilization under Anoxic and Aerobic conditions

Growth Condition	μ_{\max} , Anoxic	μ_{\max} , Aerobic	Temp. θ	Reference
Anoxic	1.86		1.12	Stensel (1973)
Anoxic	1.25		1.13	Nichols et al. (2007)
Anoxic	1.30		1.09 - 1.13	Dold et al. (2008)
Anoxic	1.25		1.14	Cherchi et al. (2008)
Anoxic	0.94			Baytshtok et al. (2008)
Anoxic	1.30	1.72		Purtschert and Gujer (1999)
Aerobic	0.81	3.88		Purtschert and Gujer (1999)

Little information exists on the methanol half-velocity (K_s) coefficient value, and more information is needed as this greatly determines the reactor methanol concentration when trying to achieve sufficient denitrification rates while keeping the reactor effluent methanol concentration low. Table 4-11 summarizes reported K_s values determined in laboratory kinetic studies. The results may be highly dependent on data fitting methods, and further work is needed to evaluate denitrification at low methanol concentrations to better define K_s .

Table 4-11. Reported K_s values for $\text{NO}_3\text{-N}$ reduction with methanol at 20°C

Growth Condition	K_s , mg COD/L	Reference
Anoxic	9.1	Stensel (1973)
Anoxic	15.6	Cherchi et al. (2008)
Anoxic	31.7	Baytshtok et al. (2008)
Anoxic	< 1.0	Purtschert and Gujer (1999)

Because of the relatively slow denitrification kinetics for methanol and its rising cost, there is an interest in using other exogenous substrates either long term, short term during cold weather conditions, or in combination with methanol. In addition, where carbon is needed only periodically to enhance denitrification rates, other carbon sources are more attractive as they do not require as long an acclimation period compared to methanol.

4.12.2 Alternative Exogenous Substrates and Denitrification Kinetics

Evaluation of alternative substrates has shown that denitrification rates are much faster with acetate, ethanol, and glycerol than with methanol. Using the same high F/M test method as used for methanol kinetics, Dold et al. (2008) obtained much higher values of μ_{\max} for acetate or sugar; at about 4.0 g/g-day at 20°C. Cherchi et al. (2008) using the same test technique as Dold et al. (2008) obtained a 20°C μ_{\max} value for acetate of 2.2 g/g-day. In comparing the maximum specific growth rate of bacteria grown on methanol, acetate, and corn syrup (Table 4-12), Mokhayeri et al. (2006) found that acetate and corn syrup resulted in rates that were about 2.5 times that for methanol grown bacteria at 13°C and about 3.5 times faster at 19°C. Christensson et al. (1994) found a similar effect in comparing ethanol and methanol. The maximum specific growth rate for ethanol compared to methanol was about 2.5 times faster at 15°C and about 2.3 at 25°C.

Table 4-12. Comparison of Maximum Specific Growth rates for Methanol, Acetate, and Corn Syrup at High and Low Temperatures

Reference	Substrate	μ_{\max} , g VSS/g VSS-day	
Mokhayeri et al. (2006)		13°C	19°C
	Methanol	0.5	1.0
	Acetate	1.2	3.7
	Corn Syrup	1.3	3.5
Christensson et al., 1994		15°C	25°C
	Methanol	0.8	2.1
	Ethanol	1.9	4.8

Mokhayeri et al. (2008) also found a similar rate comparison using three enrichments grown on methanol, acetate, and ethanol by comparing SDNRs with unlimited substrate at 13°C. The ratio of the acetate to methanol SDNRs was 3.4 and for ethanol to methanol it was 3.3. Fillos et al. (2007) presented the equations shown below to describe SDNRs with methanol or ethanol addition to an activated sludge BNR process as a function of temperature. They showed appreciable differences in SDNR with ethanol versus methanol, but in contrast to the above, the relative denitrification rates with ethanol versus methanol was not as large and greater at high temperature; ethanol:methanol SDNRs are 2.2 at 20°C and 1.8 at 10°C. After a 50-day acclimation period in a full scale and pilot scale anoxic-aerobic BNR systems, Hallin and Pell (1998) found that the system with ethanol addition had an SDNR that was about 2.2 times the system with methanol addition.

Methanol SDNR (Fillos et al, 2007):

$$\text{SDNR}_T = 0.0738(1.11)^{(T-20)} \quad \text{Eq. 4-39}$$

Ethanol SDNR (Fillos et al., 2007):

$$\text{SDNR}_T = 0.161(1.13)^{(T-20)} \quad \text{Eq. 4-40}$$

4.12.3 Acclimation Time and Degradative Ability of Denitrifying Bacteria with Exogenous Substrates

For some BNR applications, the need for an exogenous substrate may be seasonal to increase denitrification rates at low temperatures or intermittent due to wet weather conditions or low weekend loads. In such cases, the ability of the BNR activated sludge mixed liquor to rapidly respond to the exogenous substrate addition is desired. For methanol additions, a considerable acclimation period is needed to fully utilize the methanol added and to achieve the full denitrification rate possible with the methanol addition. Acclimation time is not a significant issue with some other exogenous substrates, such as ethanol and acetate. In full-scale and pilot-plant BNR system studies treating municipal wastewater, Hallin and Pell (1998) found an immediate response with ethanol and acetate addition. In contrast, a time period of over 50 days was required to reach full degradation rates with methanol as shown by batch tests using the BNR mixed liquor with excess substrate. Table 4-13 shows the increased denitrification rates over time relative to the BNR activated sludge without substrate addition. Methanol addition did have some mild immediate effect to the denitrification rate potential, although approximately 1 SRT (26-day SRT for system) was needed to fully develop the methanol-degrading population. Nyberg et al. (1992, 1996) also showed the need for significant acclimation time of two- and three-SRTs (50 and 70 days) with methanol feeding before the methylotrophic population reached its full degradative capacity.

Table 4-13. For BNR Activated Sludge, Ratio of Denitrification Rate with Substrate Addition to Denitrification Rate with No Addition

Time Period	Substrate	
	Methanol	Ethanol
Day 1	1.2	4.0
Day 50	2.0	4.1

Source: Hallin and Pell (1998)

Another important observation by Hallin and Pell (1998) was that the bacteria populations developed by ethanol and methanol feeding could also degrade other exogenous substrates (Table 4-14). The ability of the methanol-fed BNR activated sludge to degrade ethanol was also observed by Dold et al. (2008) in which they commented that it violated the rule that methylotrophs can only use single carbon compounds. However, Sperl and Hoare (1971) noted that the methylotroph *Hyphomicrobium sp.* can denitrify with ethanol, propanol, butanol, acetate, formate, formaldehyde, methylamine, and glycerol. It should be noted also that Dold et al. (2008) obtained a μ_{max} value for ethanol of 0.37 g/g-d at 9.8°C, which is close to that predicted for methanol at the same temperature; however, an ethanol enriched activated sludge should have a much higher rate. Nyberg et al. (1996) raised the possibility of using ethanol with methanol to accelerate the acclimation time of a methanol-fed denitrification system. Cherchi et al. (2009) found that a methanol acclimated biomass could also use acetate, ethanol, and MicroC™ without an acclimation period, although glucose did require an acclimation period. MicroC™ acclimated biomass was found to be able to denitrify using methanol, ethanol, acetate, and glucose without an acclimation period. They reported that acetate acclimated biomass could not use any other carbon sources to denitrify without an acclimation period.

Table 4-14. Ratio of Denitrification Rates for Other Substrates at Day 50 with Ethanol or Methanol Addition Versus no Addition

Test Substrate	Ethanol Fed Mixed Liquor	Methanol Fed Mixed Liquor
Methanol	7.0	2.0
Ethanol	4.1	1.7
Acetate	2.4	1.0
Propionate	1.9	0.8
Butyrate	2.3	0.8
Glucose	1.8	0.8

Source: Hallin and Pell (1998)

For the results shown above in Table 4-14, the ethanol utilization rate by the methanol-fed system was 85 percent of its methanol utilization rate. Cherchi et al. (2008) observed an ethanol degradation rate that was 18 percent higher than the methanol utilization rate for a methanol fed enrichment. The methanol-utilizing bacteria contain methanol dehydrogenase enzymes that can act on a number of alcohols.

4.13 Specific Denitrification Rates (SDNR)

SDNR values have been commonly used to estimate the size of pre- and post-anoxic zones for nitrogen removal. They provide a simple first cut approximation of the anoxic reactor sizing. More precise calculations for anoxic reactor size and the effect of stages are commonly done today with commercial simulation model software that models the fate of degradable particulate and soluble substrates, active biomass, and nitrogen species and the effect of temperature and DO concentration. See Chapter 10 for guidance on using simulation models for the design of biological nutrient removal systems. This section presents the fundamental equations used in models to size reactors and presents typical values for kinetic parameters.

The required anoxic volume for denitrification can be estimated from SDNRs with the following equation.

$$V = \frac{(NO_R)}{SDNR(X)} \quad \text{Eq. 4-41}$$

Where:

V = Anoxic zone volume, m³

SDNR = Specific denitrification rate, mg NO₃-N removed/mg MLVSS-day

X = MLVSS concentration

NO_R = Nitrate removal rate in anoxic zone equal to nitrate fed rate to anoxic zone via internal and return sludge flows or from upstream nitrification zone.

Typical values for SDNR are summarized in Table 4-15. Temperature corrections for methanol addition have been given previously. For wastewater feed only, reported values range from 1.03 to 1.08 (Dawson and Murphy, 1972, Ekama et al., 1984).

Table 4-15. Range of reported SDNR values in BNR activated sludge treatment

Condition	SDNR, 20°C g NO ₃ -N/g MLVSS-d
Pre-anoxic	0.05 – 0.15
Post-anoxic	0.01 – 0.04
With methanol added	0.10 – 0.25

Source: Tchobanoglous et al. 2003

The following equation was used to fit SDNR data versus the pre-anoxic zone food to mass ratio (lb BOD applied/lb MLVSS-day) for a Bardenpho process at 18°C with no primary treatment (Burdick et al., 1982).

$$\text{SDNR} = 0.03(\text{F/M}) + 0.029 \quad \text{Eq. 4-42}$$

$$\frac{\text{F}}{\text{M}} = \frac{\text{QSo}}{\text{X}_A \text{V}} \quad \text{Eq. 4-43}$$

Where:

- SDNR₂₀ = Specific denitrification rate at 20°C, g NO₃-N/g MLVSS-d
- F/M = BOD food to mass ratio to the anoxic zone, g BOD/g MLVSS-d
- Q = Influent flowrate, m³/day
- So = Influent BOD concentration, mg/L
- X = MLVSS concentration of the anoxic zone, mg/L
- V_A = Anoxic zone volume, m³

Equation 4-42 has to be adjusted for other conditions of SRT and wastewater characteristics that will result in a different active biomass fraction in the MLVSS. The active biomass fraction for the data fit was estimated at 0.30 using Equation 4-44. Thus, Equation 4-42 is adjusted as follows:

$$\text{SDNR}_{20} = 0.03(\text{F/M}) \left(\frac{\text{F}_b}{0.30} \right) + 0.029 \quad \text{Eq. 4-44}$$

$$\text{F}_b = \left(\frac{\left[\frac{\text{Y}_H}{(1 + b_T \text{SRT})} \right]}{\left[\frac{\text{Y}_H}{(1 + b_T \text{SRT})} + \text{Y}_I \right]} \right) \quad \text{Eq. 4-45}$$

Where:

- F_b = Active biomass fraction of MLVSS
- Y_H = Heterotrophic biomass synthesis yield, 0.47 g VSS/g BOD removed
- b_T = Endogenous decay rate at MLVSS temperature, g VSS/g VSS-d
- b₂₀ = Endogenous decay rate at 20°C, 0.10 g VSS/g VSS-d
- Y_I = Influent inert VSS fraction, g VSS inert/g BOD

The influent inert solids concentration greatly affects the active biomass fraction of the MLVSS. Values for Y_1 are site specific but generally range from 0.10 to 0.30 for secondary influent wastewaters with primary treatment and 0.30 to 0.50 without primary treatment (Tchobanoglous et al., 2003).

Temperature corrections applied to the SDNR in Equation 4-44 and for the endogenous decay rate (b_T) are as follows:

$$b_T = b_{20}(1.029^{(T-20)}) \quad \text{Eq. 4-46}$$

$$SDNR_T = SDNR_{20}(1.07^{(T-20)}) \quad \text{Eq. 4-47}$$

For post-anoxic systems or for the anoxic zone of oxidation ditch processes, Refling and Stensel (1978) used the following equation to estimate the SDNR.

$$SDNR_{E,T} = \frac{\eta(A_N)}{2.86(Y_N)} \left(\frac{1}{SRT} \right) \quad \text{Eq. 4-48}$$

Where:

$SDNR_{E,T}$ = SDNR in anoxic zones following nitrification and with no exogenous carbon addition, g $\text{NO}_3\text{-N/g MLVSS-d}$

η = Fraction of heterotrophs capable of nitrate reduction, 0.50 to 0.85

A_N = Net oxygen requirement by heterotrophs, g $\text{O}_2/\text{g BOD removed}$

Y_N = Net heterotrophic biomass yield, g VSS/g BOD removed

Y_N and A_N are calculated with Equations 4-49 and 4-50, respectively.

$$Y_N = \frac{Y_H}{1 + b_T SRT} \quad \text{Eq. 4-49}$$

$$A_N = 1.6 - 1.42(Y_N) \quad \text{Eq. 4-50}$$

4.14 Simultaneous Nitrification-Denitrification

Simultaneous nitrification-denitrification (SNdN) refers to a condition in activated sludge (or biofilm) processes in which the positive bulk liquid DO concentration is low enough that the DO diffusing into the floc is removed before it can penetrate the entire floc depth. Thus, nitrification is occurring on the exterior portions of the floc and denitrification is occurring in the anoxic, interior portion.

SNdN commonly occurs in oxidation ditches with sufficient SRT and with aerobic and anoxic zones as flow moves downstream from aeration in the ditch channels. Nitrite accumulation does not typically occur under low DO conditions when SRTs are maintained at appropriate values, meaning that the AOB and NOB populations remain balanced. Park et al. (2002) evaluated the AOB population in an aerated-anoxic Orbal process and found that *Nitrosospira*-like organisms were a major contributor to ammonia oxidation. *Nitrosospira* have a high affinity for oxygen which allows them to grow under low DO conditions.

Daigger et al. (2007) illustrated that the floc size for a given system is an important parameter that can affect the DO penetration and amount of denitrification. The DO concentration that is possible for SNdN depends on a number of factors including the mixed liquor concentration, temperature, oxygen uptake rate, substrate loading, and floc size. In SNdN systems, the nitrification and denitrification rates are lower than that for systems with separate nitrification zones with higher DO concentration and separate denitrification zones with no DO present. Thus, the reactor volumes for a SNdN system should be larger than that for a system with a separate anoxic denitrification zone and higher DO aerobic nitrification zone.

4.15 Metabolism, Stoichiometry and Kinetics of ANAMMOX®

The autotrophic bacteria anaerobic oxidation of ammonia with nitrite has been termed the ANAMMOX® process or Anammox reaction (Strous et al., 1998). The stoichiometry for the biological reaction given by Strous et al. (1998) is as follows, showing that 1.32 moles of NO₂-N are reduced per mole of NH₄-N oxidized:

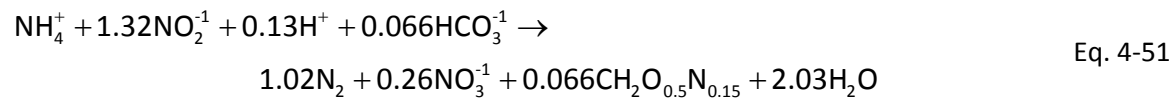

These are slow-growing organisms with doubling times of about 11 days at 30°C (Jetten et al., 1999).

Biokinetic parameters with selected values have been assembled by Capuno et al. (2008) as part of a model development for the process in a biofilm reactor (Table 4-16).

Table 4-16. ANAMMOX® Bacteria Biokinetic Parameters at 30°C

Parameter	Units	Value
Maximum specific growth rate	g VSS/g VSS-d	0.08
Growth yield	g VSS/g N oxidized	0.11
NH ₄ -N half-velocity coefficient	mg/L	0.07
NO ₂ -N half-velocity coefficient	mg/L	0.05
Oxygen inhibition coefficient	mg/L	0.01
Specific Endogenous decay rate	g VSS/g VSS-d	0.003

Source: (Capuno et al., 2008)

The process is sensitive to nitrite concentration. An NO₂-N concentration of 4.8 mg/L was found to decrease anammox activity by Wett et al. (2007). Musabyimana et al. (2008) reported that a preferred pH operating range is 7.0 to 7.7 and that activity could be sustained at 50 mg/L NO₂-N, though inhibited. They also noted that nitrite inhibition was reversible.

The original Anammox process relied on a step process in which nitrite is produced under aerobic conditions in a portion of the ammonia rich stream and then the streams are combined and subject to anaerobic conditions. Other process modifications, such as the DEMON, CANON, and OLAND processes are described in Chapter 6.

4.16 Impacts on Sludge Production and Handling

Less sludge production and better settling and thickening sludge is found for activated sludge systems using anoxic/aerobic treatment for nitrogen removal versus aerobic treatment only. The sludge production is less because the biomass yield from BOD consumption using nitrate as an electron acceptor instead of oxygen is about 40 percent lower. The net reduction in sludge production is site specific and depends on the portion of the influent BOD that is oxidized via biological denitrification. For many applications, reductions of biomass production by 10 to 20 percent are possible. The impact this will have on total sludge production by a treatment plant will depend upon how much waste sludge is produced by other treatment units such as primary clarifiers and chemical treatment with precipitating chemicals.

Implementation of biological nitrogen removal at conventional activated sludge plants improves the sludge thickening characteristics due to its ability to decrease the amounts of filamentous bacteria in the activated sludge. The effect of additional solid production from adding an exogenous carbon source to increase denitrification rates must be considered as part of the overall sludge production. Solids produced from nitrogen removal processes generally thicken and dewater well and show no negative impact on any solids processing system.

4.17 Effluent Dissolved Organic Nitrogen

As effluent limitations have become more stringent, the DON fraction in the plant effluent has become increasingly important. Most BNR processes can remove 80 to 95 percent of the inorganic forms of nitrogen (ammonia-nitrogen, nitrate, and nitrite), but are less efficient at removing the residual organic fractions (Sedlak 2007). The concentration of DON in the plant effluent (also called effluent DON or EDON) depends on influent concentration and specific treatment process and varies from plant to plant. Based on effluents from 188 BNR plants, Pagilla (2007) reported concentrations typically between 0.5 and 1.5 mg/L with some values as high as 2.5 mg/L. Likewise, Bratby et al. (2008) found EDON concentrations between 0.4 and 2.2 mg/L with an average value of 1.8 mg/L based on a compilation of the available literature. The EDON fraction is not as important for plants trying to achieve a TN effluent limit of 10 mg/L, but becomes a much larger percentage of effluent TN and more problematic for plants attempting to meet a 5 mg/L or 3 mg/L limit.

The text box below provides information on EDON in the form of questions and answers. One very important and timely question for the industry is whether EDON can degrade in the natural environment to bioavailable inorganic nitrogen species. Bioavailable forms can be used by algae and other phytoplankton and thus, contribute to the problem of eutrophication. Although much of EDON has been thought to be recalcitrant, meaning that it is inert and *not* bioavailable in the natural environment, Mullholland et al. (2007) noted that photochemical reactions and salinity conditions can convert recalcitrant material to inorganic forms of nitrogen such as nitrite and ammonium. Bacteria can also play an important role in the breakdown of EDON (Sedlak and Pehlivanoglu 2007). Summarizing results of several research projects, the Water Environment Research Foundation (WERF) (2008) estimates that for those WWTPs discharging into freshwater watersheds, 20 to 60 percent of EDON could be converted to bioavailable forms. The authors note, however, that the proportions are very site specific and additional research is needed in this area.

Questions and Answers Regarding Effluent Dissolved Organic Nitrogen (EDON)

What are the sources of EDON? There are two primary sources:

- (1) Influent DON that is recalcitrant and passes through the plant unchanged or influent biodegradable DON that is not removed during treatment. DON in domestic wastewater can be present as amino acids, proteins, aliphatic N compounds, synthetic compounds such as EDTA, and humic organic substances (WEF 2008).
- (2) DON can also be produced during biological treatment processes within the plant through cell metabolic processes, cell decay, and cell lysis.

What are its characteristics? EDON is composed primarily of degraded amino sugars, peptides, and porphyrins (Leenheer et al. 2007 as cited in Bratby et al. 2008). The molecular weight varies from source to source but has been reported to be relatively small overall (Bratby et al., 2008). Sedlak and Pehlivanoglu (2007) hypothesized that the high molecular weight portion (> 1,000 Daltons) is not biologically available, whereas a large portion of the low molecular weight portion (< 1,000 Daltons) may be biodegradable.

How is it measured? EDON is usually determined as the difference between the measured effluent soluble Kjeldahl nitrogen and effluent ammonia with filtration of both samples through a 0.45 micron filter. Because of challenges associated with measuring fractions in effluents with very low TN concentrations, researchers are investigating other methods. Sattayetewa and Pagilla (2008) reported success using a persulfate digestion method and second derivative ultraviolet spectrophotometric (SDUS) combined method. Currently, there is no standard method for differentiating between the inert portion and the portion that can be converted to bioavailable inorganic nitrogen in the watershed.

How is it removed at the plant? DON can be removed through hydrolysis and ammonification. Removal is dependent on temperature and solids residence time.

What are its environmental concerns? The main concern in the wastewater industry is the bioavailability of effluent DON when it is a large fraction of the effluent total nitrogen concentration.

For more information, see the WEF Nutrient Compendium, available online at http://www.werf.org/AM/Template.cfm?Section=Content_Folders&CONTENTID=8726&TEMPLATE=/CM/ContentDisplay.cfm

4.18 References

- Abeling, U. and C. F. Seyfried. 1992. Anaerobic-Aerobic Treatment of High-Strength Ammonium Wastewater; Nitrogen Removal Via Nitrate. *Water Sci and Tech.* 26: 1007-1015.
- Anthonisen, A. C., R. C. Loehr, T. B. S. Prakasam and E. G. Srinath. 1976. Inhibition of Nitrification by Ammonia and Nitrous Acid. *J. Water Pollut. Control Fed.* 48(5): 835-852.
- Aoi, Y., T. Miyoshi, T. Okamoto, S. Tsuneda, A. Hirata, A. Kitayama, and T. Nagamune. 2000. Microbial ecology of nitrifying bacteria in wastewater treatment process examined by fluorescence in situ hybridization. *Journal Bioscience and Bioengineering.* 90(3):234-240.
- Barker, P.S. and P.L. Dold. 1997. General Model for Biological Nutrient Removal Activated Sludge Systems: Model Presentation. *Water Environment Research.* 69(5): 969-999.
- Barnard, J.L. 1975. Biological Nutrient Removal without the Addition of Chemicals. *Water Res.* 9: 485.
- Baytshtok, V., S. Kim, R. Yu, H. Park, and K. Chandran. 2008. Molecular and Biokinetic Characterization of Methylophilic Denitrification Using Nitrate and Nitrite as Terminal Electron Acceptors. *Water Sci and Tech.* 58(2):359-365.
- Bilyk, K., A. Stone, R. Latimer, P. Pitt, T.J. Lynch, and T. Mencome. 2009. Full-Scale Denitrification Evaluations Using Sugar Water, Glycerin, and Methanol in Denitrification Filters and Activated Sludge. Presented at Nutrient Removal 2009. Washington, DC. WEF.
- Blum, D.J., and R. E. Speece. 1991. A Database of Chemical Toxicity to Environmental Bacteria and its Use in Interspecies Comparison and Correlations. *Water Environ. Res.* 63:198.
- Bock, E. I. Schmidt, R. Stuvén, and D. Zart. 1995. Nitrogen Loss Caused by Denitrifying *Nitrosomonas* Cells Using Ammonium or Hydrogen as Electron Donors and Nitrite as Electron Acceptor. *Arch. Microbiol.* 163:16-20.
- Bratby, J., J. Jimenez, D. Parker. 2008. Dissolved Organic Nitrogen – Is It Significant, and Can it be Removed? Presented at WEFTEC 2008
- Burdick, C. R., Refling, and D. R., Stensel, H. D. 1982. Advanced Biological Treatment to Achieve Nutrient Removal. *J. Water Pollut. Control Fed.* 54: 1078–1086.
- Campos, J. L., A. Mosquera-Corral, M. Snachez, R. Mendez, and J. M. Lema. 2002. Nitrification in Saline Wastewaters with High Ammonia Concentration in an Activated Sludge Unit. *Water Research.* 36: 2555
- Capuno, R. E., N. G. Love, A. Terada, S. Lackner, and B. F. Smets. 2008. Model Prediction of Completely Autotrophic Nitrogen Removal under Different Reactor Configurations. Proceedings of WEF 75th ACE. Chicago, IL. October, 2008.
- Carrera, J., T. Vicent, and F. J. Lafuente. 2003. Influence of Temperature on Denitrification of an Industrial High-Strength Nitrogen Wastewater in a Two-Sludge System. *Water S.* 29(1):11-16.

- Chandran, K., Z. Hu and B. F. Smets. 2008. A Critical Comparison of Extant Batch Respirometric and Substrate Depletion Assays for Estimation of Nitrification Biokinetics. *Biotechnol. Bioeng.* 101: 62-72.
- Chandran, K. and B. F. Smets. 2000. Applicability of Two-Step Models in Estimating Nitrification Kinetics from Batch Respirograms Under Different Relative Dynamics of Ammonia and Nitrite Oxidation. *Biotechnology and Bioengineering.* 70(1): 54-64.
- Cherchi, C., A. Onnis-Haydern, and A. Z. Gu. 2008. Investigation of Microc™ as an Alternative Carbon Source for Denitrification. *Proceedings WEF 75th ACE.* Chicago, IL. October, 2008.
- Cherchi, C., A. Onnis-Hayden, and A.Z. Gu. 2009. Ability of Specific Enriched Denitrifying Culture to Utilize Other Carbon Sources. Presented at Nutrient Removal 2009. Washington, DC. WEF.
- Christensen, M.H. and P. Harremoës. 1977. Biological Denitrification of Sewage: a Literature Review. *Prog. Water Technol.* 8:509.
- Christensen, M.H., E. Lie, and T. Welander. 1994. A Comparison Between Ethanol and Methanol as Carbon Sources for Denitrification. *Water Sci and Tech.* 30(6): 83-90.
- Ciudad, G., A. Werner, C. Bornhardt, C. Munoz, and C. Antileo. 2006. Differential Kinetics of Ammonia- and Nitrite-Oxidizing Bacteria: A Simple Kinetic Study Based on Oxygen Affinity and Proton Release During Nitrification. *Process Biochemistry.* 41:1764-1772.
- Contreras, E. M., R. Fabricio, and N. C. Bertoia. 2008. Kinetic Modeling of Inhibition of Ammonia Oxidation by nitrite under low dissolved oxygen conditions. *Journal of Environmental Engineering.* ASCE. 134(3): 184-190.
- Copp, J. B. and K. L. Murphy. 1995. Estimation of the Active Nitrifying Biomass in Activated Sludge. *Water Research.* 29(8): 1855-1862.
- Coskuner, G. and T. P. Curtis. 2002. In Situ Characterization of Nitrifiers in an Activated Sludge Plant: Detection of *Nitrobacter spp.* *Journal Appl. Microbiol.* 93(3): 431-437.
- Daigger, G. T., C. D. Adams, and H. K. Steller. 2007. Diffusion of Oxygen through Activated Sludge Flocs: Experimental Measurement, Modeling, and Implications for Simultaneous Nitrification and Denitrification. *Water Environment Research.* 79(4): 375-387.
- Dawson, R.N., and K.L. Murphy. 1972. The Temperature Dependency of Biological Denitrification. *Water Res. (G.B.)* 6: 71.
- DeBarbadillo, C., J. Barnard, S. Tarallo, and M. Steichen. 2008. Got Carbon? Widespread Biological Nutrient Removal is Increasing the Demand for Supplemental Sources. *Water Environment & Technology.* Alexandria, VA: WEF. 20(1): 49-53.
- Dold, P. L., R. M. Jones, and C. M. Bye. 2005. Importance and Measurement of Decay Rate When Assessing Nitrification Kinetics. *Water Sci and Tech.* 52(10-11): 469-477.

- Dold, P. L., H. D. Stensel, R. Ke, R. M. Jones, C. M. Bye, and H. Melcer. 2002. Importance of Decay Rate in Assessing Nitrification Kinetics. *Proceedings of WEF 75th ACE*. Chicago, IL. September 28 – October 2, 2002.
- Dold, P., I. Takács, Y. Mokhayeri, A. Nichols, J. Hinojosa, R. Riffat, C. Bott, W. Bailey, and S. Murthy. 2008. Denitrification with Carbon Addition—Kinetic Considerations. *Water Environment Research*. 80(5): 417-427.
- Downing, A.L. and A. P. Hopwood. 1964. Some Observations on the Kinetics of Nitrifying Activated Sludge Plants. *Schweizerische Aeitschrift fur Hyddrologie*. 26: 271.
- Downing, A. L., H. A. Painter, and G. Knowles. 1964. Nitrification in the Activated Sludge Process. *J. Inst. Sew. Purification*. 64: 130.
- Ekama, G.A., et al. 1984. Biological Excess Phosphorus Removal. In *Theory, Design, and Operation of Nutrient Removal Activated Sludge Processes*. Water Resour. Comm. Pretoria, S. Afr.
- Fillos, J. K. Ramalingam, R. Jezek, A. Deur, and K. Beckmann. 2007. Specific Denitrification Rates with Alternate External Sources Of Organic Carbon. Proceedings of the 10th International Conference on Environmental Science and Technology. Kos Island, Greece. September 5-7, 2007.
- Fuhrmann, J. A., K. McCallum, and A. Davis. 1992. A Novel Major Archaeobacterial Group from Marine Plankton. *Nature*. 356: 148-149.
- Garrido, J. M., W. A. J. van Benthum, M. C. M. van Loosdrecht and J. J. Heijnen. 1997. Influence of Dissolved Oxygen Concentration on Nitrite Accumulation in a Biofilm Airlift Suspension Reactor. *Biotechnology and Bioengineering*. 53:168-178.
- Guisasola, A., I. Jubany, J. A. Baeza, J. Carrera, and J. Lafuente. 2005. Respirometric Estimation of the Oxygen Affinity Constants for Biological Ammonium and Nitrite Oxidation. *J. Chem. Technol. Biotechnol.* 80:388-396.
- Hall, I.R. and K. L. Murphy. 1980. Estimation of nitrifying biomass and kinetics in wastewater. *Water Res.* (14): 297.
- Hallin, S. and M.Pell. 1998. Metabolic Properties of Denitrifying Bacteria Adapting to Methanol and Ethanol in Activated Sludge. *Water Res.* 32(1): 13-18.
- Harms, G., A. C. Layton, H. M. Dionisi, I. R. Gregory, V. M. Hawkins, K. G. Robinson, and G. S. Sayler. 2003. Real-time PCR Quantification of Nitrifying Bacteria in a Municipal Wastewater Treatment Plant. *Environ. Sci. Technol.* 37(2): 343-351.
- Haug, R. T. and P. L. McCarty. 1972. Nitrification with the Submerged Filter. *Jour. Wat. Poll. Contr. Fed.* 44, 50.
- Hellinga, C., A. A. J. C. Schellen, J. W. Mulder, and M. C. M. van Loosdrecht. 1998. The SHARON Process: An Innovative Method for Nitrogen Removal from Ammonium-Rich Wastewater. *Water Res.* 37(9): 135-142.

- Henze, M., W. Gujer, T. Mino, and M. C. M. van Loosdrecht. 2000. Activated Sludge Models ASM1, ASM2, ASM2d, and ASM3. *IWA Scientific and Technical Report No. 9*. IWA Publishing, London.
- Hockenbury, M.R. and C. P. L. Grady. 1977 Inhibition of Nitrification-Effects of Selected Organic Compounds. *J. Water Pollut. Control Fed.* 49, 768.
- Hoover, S. R. and N. Porges. 1952. Assimilation of Dairy Wastes by Activated Sludge II: The Equation of Synthesis and Oxygen Utilization. *Sewage Ind. Wastes.* 24, 306.
- Iacopozzi, H., V. Innocenti, S. Marsili-Libelli and E. Giusti. 2007. A Modified Activated Sludge Model No. 3 (ASM3) with Two-Step Nitrification-Denitrification. *Environmental Modeling & Software.* 22(6): 847-861.
- Jetten, M. S. M., M. Strous, K. T. van de Pas-Schoonen, J. Schalk, G. J. M. van Dongen, A. A. van de Graaf, S. Logemann, G. Muyzer, M. C. M. van Loosdrecht, and J. G. Kuenen. 1999. The Anaerobic Oxidation of Ammonium. *FEMS Microbiology Reviews.* 22:421-437.
- Kaelin, D., R. Manser, L. Rieger, J. Eugster, K. Rotterman, and H. Siegrist. 2009. Extension of ASM3 Four Two-Step Nitrification and Denitrification and its Calibration and Validation with Batch Test and Pilot Scale Data. *Wat. Res. Article in Press.* 1-13.
- Katehis, D., J. Fillos, and L. A. Carrio. 2002. Comparison of Bench Scale Testing Methods for Nitrifier Growth Rate Measurements. *Wat. Sci. and Technol.* 46(1-2): 289-295.
- Kielemoes, J., P. De Boever, and W. Verstraete. 2000. Influence of Denitrification on the Corrosion of Iron and Stainless Steel Powder. *Environ. Sci. Technol.* 34:663-671.
- Konneke, M., A. E. Bernhard, J. R. de la Torre, C. B. Walker, J. B. Waterbury, and D. A. Stahl. 2005. Isolation of an Autotrophic Ammonia-Oxidizing Marine Archaeon. *Nature.* 437(7058): 543-546.
- Koops, H.-P. and A. Pommerening-Roser. 2001. Distribution and Ecophysiology of the Nitrifying Bacteria Emphasizing Cultured Species. *FEMS Microbiology Ecology.* 37(1): 1-9.
- Kujawa, K. and B. Klapwijk. 1999. A Method to Estimate Denitrification Potential for Predenitrification Systems Using NUR Batch Test. *Water Research.* 33(10): 2291-2300.
- Kumaraswamy, R., K. Sjollem, G. Kuenen, M. C. M. van Loosdrecht, and G. Muyzer. 2006. Nitrate-Dependent [Fe(II)EDTA](2-) Oxidation by *Paracoccus ferrooxidans sp nov.*, Isolated From A Denitrifying Bioreactor. *Systematic and Appl. Microbiol.* 29(4):276-286.
- Kyung-Ik, G. and E.-S. Choi. 2001. Modelling of Inhibition of Nitrite Oxidation in Biological Nitritation Processes by Free Ammonia. *Biotechnology Letters.* (23):2021-2026.
- Lawrence, A.W., and C. G. Brown. 1976. Design and Control of Nitrifying Activated Sludge Systems. *J. Water Pollut. Control Fed.*, 48, 1779.

- Lee, Y. and J. A. Oleszkiewicz. 2002. Evaluation of Maximum Growth and Decay Rates of Autotrophs Under Different Physical and Environmental Conditions. *Proceedings of WEF 75th ACE*. Chicago, IL. September 28 – October 2, 2002.
- Lee, Y. and J. A. Oleszkiewicz. 2003. Effects of Predation and ORP Conditions on the Performance of Nitrifiers in Activated Sludge Systems. *Water Res.* 37(17): 4202-4210.
- Leininger, S., T. Urich, M. Schloter, L. Schwark, J. Qi, G. W. Nicol, J. I. Prosser, S. C. Schuster and C. Schleper. 2006. Archaea Predominate Among Ammonia-Oxidizing Prokaryotes in Soils. *Nature* 442(7104): 806-809.
- Li, H., M. Yang, Y. Zhang, X. Liu, M. Gao, and Y. Kamagata. 2005. Comparison of Nitrification Performance and Microbial Community between Submerged Membrane Bioreactor And Conventional Activated Sludge System. *Wat. Sci. and Technol.* 51(6-7): 193-200.
- Littleton, H. X., G. T. Daigger, P. F. Strom, R., and A. Cowan. 2003. Simultaneous Biological Nutrient Removal: Evaluation of Autotrophic Denitrification, Heterotrophic Nitrification, and Biological Phosphorus Removal. *Water Environ. Res.* 75:138-150.
- Magri, A., L. Corominas, H. Lopez, E. Campos, M. Balaguer, J. Colprim, and X. Flotas. 2007. A Model for the Simulation of the Sharon Process: pH As a Key Factor. *Environ. Tech.* 28(3): 255.
- Manser, R., W. Gujer, and H. Siegrist. 2005. Consequences of Mass Transfer Effects on the Kinetics of Nitrifiers. *Water Res.* 39(19): 4633-4642.
- Manser, R., and W. Gujer, et al. 2006. Decay Processes of Nitrifying Bacteria in Biological Wastewater Treatment Systems. *Water Res.* 40(12): 2416-2426.
- Marsili-Libelli, S., P. Ratini, A. Spagni, and G. Bortone. 2001. Implementation Study and Calibration of a Modified ASM2d for the Simulation of SBR Processes. *Wat. Sci. and Technol.* 43(3): 69-76.
- Mauret, M., E. Paul, E. Puech-Costes, M. T. Maurette, and P. Baptiste. 1996. Application of Experimental Research Methodology to the Study of Nitrification in Mixed Culture. *Wat. Sci. and Technol.* 34(1-2):245-252.
- McCarty, P. L., L. Beck, and P. St. Amant. 1969. Biological Denitrification of Wastewaters by Addition Of Organic Materials. *Proc. Industrial Waste Conf.* Purdue University Ext. Ser., Purdue University, Lafayette, IN. 135:1271-1285.
- Melcer, H., P.L. Dold, R.M. Jones, C.M. Bye, I. Takacs, H.D. Stensel, A.W. Wilson, P. Sun, and S. Bury. 2003. Methods for Wastewater Characterization in Activated Sludge Modeling. WERF Final Report. Project 99-WWF-3.
- Mokhayeri, Y. A. Nichols, S. Murthy, R. Riffat, P. Dold, and I. Takacs. 2006. Examining the Influence of Substrates and Temperature on Maximum Specific Growth Rate of Denitrifiers. *Wat. Sci. and Technol.* 54(8):155-162.
- Mokhayeri, R. Riffat, I. Takacs, P. Dold, C. Bott, J. Hinojosa, W. Bailey and S. Murthy. 2008. Examining the Influence of Substrates and Temperature on Maximum Specific Growth Rate of Denitrifiers. *Wat. Sci. and Technol.* 58(1):233-237.

- Monteith, H.D. 1980. Industrial Waste Carbon Source for Biological Denitrification. *Prog. Water Technol.*, 12, 127.
- Mulder, A., A.A. Graaf, L.A. Robertson, and J.G. Kuenen. 1995. Anaerobic Ammonium Oxidation Discovered in a Denitrifying Fluidized Bed Reactor. *FEMS Microbiology Ecology.*, 16(3): 177-184.
- Musabyimana, M., N. G. Love, C. Bott, S. Murthy, and G. Daigger. 2008. Evaluating the Impact of Nitrite Concentration on Anaerobic Ammonia Oxidation. Proceedings of WEF 75th ACE. Chicago, IL. October, 2008.
- Nichols, A., J. Hinojosa, R. Riffat, P. Dold, I. Takacs, C. Bott, W. Bailey and S. Murthy. 2007. Maximum Methanol-utilizer Growth Rate Impact of Temperature on Denitrification. Proceedings of WEF 74th ACE. San Diego, CA. October, 2007.
- Nicol, G. W. and C. Schleper. 2006. Ammonia-oxidizing Crenarchaeota: Important Players in the Nitrogen Cycle? *Trends in Microbiology* 14(5): 207-212.
- Nowak, P., H. Schweighofer, and K. Svardal. 1994. Nitrification Inhibition - A Method for Estimation of Actual Maximum Autotrophic Growth Rates in Activated Sludge Systems. *Wat. Sci. and Technol.* 30(6): 9-19.
- Nyberg, U., B. Andersson and H. Aspegren. 1996. Long-Term Experiences with External Carbon Sources for Nitrogen Removal. *Wat. Sci. and Technol.* 33(12): 109-116.
- Nyberg, U., H. Aspegren, B. Andersson, and I.J.C. Jansen. 1992. Full-Scale Application of Nitrogen Removal with Methanol as Carbon Source. *Wat. Sci. and Technol.* 26: 1077-1086.
- Pagilla, K. (2007) *Presentation at Water Environment Research Foundation and Chesapeake Bay Science and Technology Advisory Committee Workshop*, Baltimore, MD, September 27/28, 2007
- Painter, H. A. 1970. A Review of Literature on Inorganic Nitrogen Metabolism in Microorganisms. *Water Res.* 4, 393-450.
- Painter, H. A., and J. E. Loveless. 1983. Effect of Temperature and Ph Value on the Growth-Rate Constants Of Nitrifying Bacteria In The Activated Sludge Process. *Water Res.* 7, 238.
- Pambrun, V. and E. Paul, and M. Sperando. 2006. Modeling the Partial Nitrification in Sequencing Batch Reactors for Biomass Adapted to High Ammonia Concentrations. *Biotechnology and Bioengineering.* 95(1):120-131.
- Park, H. D., J. M. Regan, and D. R. Noguera. 2002. Molecular Analysis of Ammonia-Oxidizing Bacterial Populations in Aerated-Anoxic Orbal Processes. *Wat. Sci. and Technol.* 46(1-2): 273-280.
- Payne, W.J. 1973. Reduction of Nitrogenous Oxides by Microorganisms. *Bacterial Rev.* 37, 409.
- Peng, Y. and G. Zu. 2006. Biological Nitrogen Removal with Nitrification and Denitrification via Nitrite Pathway. *Appl. Microbiol Biotechnol.* 73:15-26.
- Piciooreanu, C., M. C. M. van Loosdrecht and J. J. Heijnen. 1997. *Wat. Sci. and Technol.* 36(1): 147-156.

- Poth, M. and D. D. Focht. 1985. ^{15}N kinetic Analysis of N_2O Production by *Nitrosomonas europaea*: an Examination of Nitrifier Denitrification. *Appl. Environ. Microbiol.* 49:1134-1141.
- Purtschert, I. and W. Gujer. 1999. Population Dynamics by Methanol Addition in Denitrifying Wastewater Treatment Plants. *Water Sci. Technol.* 39(1): 43-50.
- Randall, C.W., H.D. Stensel, and J.L. Barnard. 1992. Design of Activated Sludge Biological Nutrient Removal Plants. In *Design and Retrofit of Wastewater Treatment Plants for Biological Nutrient Removal*. Lancaster, PA: Randall, Ed. Technomic Publishing Co. Inc.
- Refling, D.R. and Stensel, H.D. 1978. A Rational Approach to Biological Nitrogen Removal. Paper presented at *51st Annu. Conf. Water Pollut. Control Fed.* Anaheim, CA.
- Richardson, M. 1985. *Nitrification Inhibition in the Treatment of Sewage*. The Royal Society of Chemistry, Burlington House: Thames Water, Reading, Pa.
- Robertson. L. A. and J. G. Kuenen. 1990. Combined Heterotrophic Nitrification and Aerobic Denitrification in *Thiosphaera pantotropha* and Other Bacteria. *Antonie Van Leeuwenhoke.* 56:289-299.
- Rowan, A. K., J. R. Snape, D. Fearnside, M. R. Barer, T. P. Curtis, and I. M. Head. 2003. Composition and Diversity of Ammonia-Oxidising Bacterial Communities in Wastewater Treatment Reactors of Different Design Treating Identical Wastewater. *FEMS Microbiology Ecology.* 43(2): 195-206.
- Schmidt, I., O. Sliemers, M. Schmid, E. Bock, J. Fuerst, J. G. Kuenen, M. S. M. Jetten, and M. Strous. 2003. New Concepts Of Microbial Treatment Processes for the Nitrogen Removal in Wastewater. *FEMS Microbiology Review.* 27: 481-492.
- Schramm, A., D. de Beer, J. C. van den. Heuvel, S. Ottengraf, and R. Amann. 1999. Microscale Distribution of Populations and Activities of *Nitrosospira* and *Nitrospira* Spp. along a Macroscale Gradient in a Nitrifying Bioreactor: Quantification by In Situ Hybridization and the Use of Microsensors. *Appl. and Environ. Microbiol.* 65(8): 3690-3696.
- Sharma, B. and R. C. Ahlert. 1977. Nitrification and Nitrogen Removal. *Water Res.* (G.B.), 11, 897.
- Siegrist, H. I. Brunner, G. Koch, P. Con. Linh, and C. Van Chiew. 1999. Reduction of Bio Mass Decay Rate Under Anoxic and Anaerobic Conditions. *Wat. Sci. and Technol.* 39(1): 129-137.
- Sin, G., D. Kaelin, M. J. Kampschreur, I. Takacs, B. Wett, K. V. Gernaey, L. Rieger, H. Siegrist, and M. C. M. Van Loosdrecht. 2008. Modelling Nitrite in Wastewater Treatment Systems: A Discussion of Different Modelling Concepts. *Wat. Sci. and Technol.* 58(6): 1155-1171.
- Siripong, S. and B. E. Rittmann. 2007. Diversity Study of Nitrifying Bacteria in Full-Scale Municipal Wastewater Treatment Plants. *Water Res.*, 41(5): 1110-1120
- Sliemers, A. O., N. Derwort, J. L. Campos Gomez, M. Strous, J. G. Kuenen, and M. S. M. Jetten. 2002. Completely Autotrophic Nitrogen Removal over Nitrite in One Single Reactor. *Wat. Res.* 36, 2475-2482.

- Skerman and Mori. 1975 [full reference to be provided]
- Sobieszuk, P. and K. W. Szewczyk. 2006. Estimation of (C/N) Ratio for Microbial Denitrification. *Environmental Technology*. 27:103-108.
- Sperl, G T. and D. S. Hoare. 1971. Denitrification with Methanol: A Selective Enrichment for *Hyphomicrobium* Species. *Jour. Bacteriology*. 108: 733-736.
- Stensel, H. D., R. C. Loehr, and A. W. Lawrence. 1973. Biological Kinetics of Suspended-Growth Denitrification. *Jour. Water Pollut. Control Fed.* 45:249-261.
- Stensel, H.D., O.E. Albertson, and P. Hendricks. 1993. Evaluation of Anoxic-Aerobic Treatment of the Phoenix 91st Avenue WWTP, *Liquid Process Symposium Proceedings of the Water Environment Federation Conference*. Anaheim, October 1993.
- Stensel, H. D. and G. Horne. 2000. Evaluation of Denitrification Kinetics at Wastewater Treatment Facilities. *Research Symposium Proceedings*. 73rd Annual Water Environment Federation Conference. Anaheim, CA. October 14-18, 2001.
- Strous, M., J. J. Heijnen, J. G. Kuenen, and M. S. M. Jetten. 1998. The Sequencing Batch Reactor as a Powerful Tool for the Study of Slowly Growing Anaerobic Ammonium-Oxidizing Organisms. *Applied Microbiology and Biotechnology*. 50:589-596.
- Strous, M., J. Fuerst, E. Kramer, S. Logemann, G. Muyzer, K. van de Pas, R. Webb, J. G. Kuenen, and M. S. M. Jetten. 1999. Missing Lithotroph Identified as New Planctomycete. *Nature*. 400:446-449.
- Suzuki, I., U. Dular, S. C. Kwok. 1974. Ammonia or Ammonium Ion as Substrate for Oxidation by *Nitrosomonas europaea* Cells and Extracts. *Jour Bacteriol.* 120(1):556-558.
- Tchobanoglous, G., F. L. Burton, and H.D. Stensel. 2003. *Wastewater Engineering: Treatment and Reuse*. New York, NY: McGraw-Hill.
- Timmermans, P. and A. Van Haute. 1983. Denitrification with Methanol. Fundamental Study of the Growth and Denitrification Capacity of *Hyphomicrobium sp.* *Water Research*. 17: 1249-1255.
- Turk, O. and D. S. Mavinic. 1986. Preliminary Assessment of a Shortcut in Nitrogen Removal from Wastewater. *Can. J. Civ. Eng.*, (13): 600.
- USEPA. 1993. *Nitrogen Control Manual*. Office of Research and Development. EPA/625/R-93/010. September 1993.
- Van Hulle, S. W. H., E. I. P. Volcke, J. L. Teruel, B. Donckels, M. C. M. van Loosdrecht, and P. A. Vanrolleghem. 2007. Influence of Temperature and pH on the Kinetics of the Sharon Nitritation Process. *Journal of Chemical Technology and Biotechnology*. 82(5): 471-480.
- Van Verseveld, H. W. and A. H. Stouthamer. 1978. Electron-Transport Chain and Coupled Oxidative Phosphorylation in Methanol-Grown *Paracoccus* Denitrifications. *Arch. Microbiol.* 118: 13-20.

- Volcke, E. I. P., M. Sbarciog, M. Loccufier, P. A. Vanrolleghem, and E. J. I. Noldus. 2007. Influence of Microbial Growth Kinetics on Steady State Multiplicity and Stability of a Two-Step Nitrification (SHARON) Model. *Biotechnology and Bioengineering*, 98(4):882-893.
- WEF and ASCE. 1998. *Design of Municipal Wastewater Treatment Plants - MOP 8, 4th Ed.* Water Environment Federation and American Society of Civil Engineers. Alexandria, VA: WEF.
- Werzernak, C. T. and J. J. Gannon. 1967. Oxygen-Nitrogen Relationships in Autotrophic Nitrification. *Applied Microbiology*. 15(5).
- Wett, B., S. Murthy, I. Takacs, G. Bowden, A. Deur, and M. O'Shaughnessy. 2007. Key Parameters for Control of Denitrification Process. Proceedings, IWA/WEF Nutrient Removal Specialty Conference. Baltimore, MD. March 2007.
- Wong-Chong, G. M. and R. C. Loehr. 1975. The Kinetics of Microbial Nitrification. *Water Res.* 9(12):1099-1106.
- Zart, D. and E. Bock. 1998. High Rate of Aerobic Nitrification and Denitrification by *Nitrosomonas eutropha* Grown in a Fermentor with Complete Biomass Retention In The Presence of Gaseous NO₂ or NO. *Arch. Microbiol.* 169:282-286.

This page left intentionally blank

5. Principles of Biological Phosphorus Removal

Chapter 5 covers:

- 5.1 Overview of the Biological Phosphorus Removal Process
- 5.2 Substrate Requirements
- 5.3 Sources of Volatile Fatty Acids
- 5.4 Environmental Conditions
- 5.5 Kinetics
- 5.6 Important Design and Operational Considerations
- 5.7 Impacts on Sludge Processing and Handling
- 5.8 References

5.1 Overview of the Biological Phosphorus Removal Process

Biological phosphorus removal (BPR) in wastewater treatment is accomplished by encouraging the growth of phosphate accumulating organisms (PAOs). PAOs are heterotrophic bacteria that occur naturally in the environment and in aerobic activated sludge. The growth of PAOs is encouraged by cycling them between anaerobic and aerobic conditions.

In the presence of oxygen (i.e., aerobic conditions), PAOs obtain energy from stored food and uptake large amounts of phosphorus into their cells, which they store as polyphosphates. These polyphosphates contain high-energy bonds and function like energy storage batteries. In the absence of oxygen (i.e., anaerobic conditions), PAOs can break the polyphosphate bonds and use the resulting energy to uptake easily biodegradable compounds, namely short chain volatile fatty acids (VFAs)¹. PAOs polymerize and store the VFAs in their cells as intermediate products known as poly- β -hydroxy-alkanoates (PHAs), of which the most common is poly- β -hydroxy-butyrate (PHB). When oxygen becomes available again (i.e., aerobic conditions), they can metabolize the PHAs to generate energy and uptake phosphorus (in the form of phosphate) and store the excess amount. See Figure 5.1 for a conceptual representation of the theory of BPR.

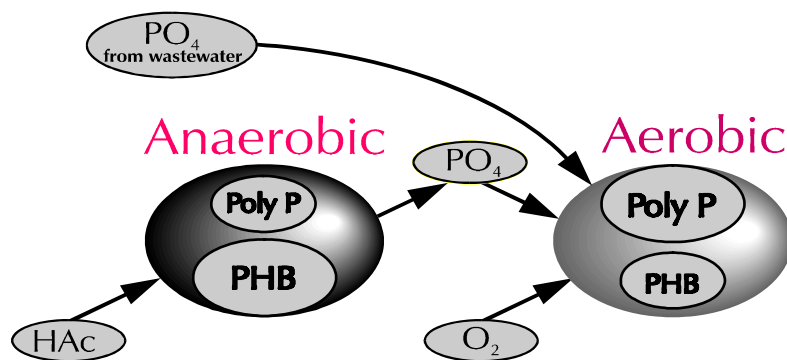

Figure 5-1. Theory of BPR in activated sludge.

¹ For biological nutrient removal (BNR), it is important to distinguish between anaerobic conditions in where no oxygen is present and anoxic conditions where oxygen is available in combined form only (e.g., NO₂⁻, NO₃⁻) and there is no free oxygen. Anoxic conditions are sufficient for denitrification, whereas anaerobic conditions are required for BPR.

What makes PAOs special? PAOs have a competitive advantage over most aerobic bacteria because they can uptake and store food (i.e., VFAs) under anaerobic conditions. Most other microorganisms must wait until oxygen is available to uptake VFAs. One notable exception is glycogen accumulating organisms (GAOs), which can also uptake VFAs in an anaerobic environment using energy stored in glycogen. GAOs compete with PAOs in the anaerobic zone; however, PAOs nearly always out-compete GAOs in temperate and cold-zone treatment plants. There is still a debate among researchers about the conditions likely to favor GAOs over PAOs. Summarizing a number of publications, it would appear that the following conditions favor the growth of GAOs over that of PAOs:

- Temperature over 28° C.
- Stronger waste with low nitrogen content.
- Polysaccharides such as glucose are the dominant feed to the anaerobic zone.
- Low pH in the aerobic zone.

Other factors that may favor GAOs but need further confirmation are high solids retention time (SRT), longer non-aerated zones, and periods of intermittent low organic substrate levels in the plant influent. Note that some GAOs are always present in the anaerobic zones of municipal BPR plants. Typically their impacts are not noticeable because the PAOs still obtain enough VFAs to remove the phosphorus to the desired effluent concentration.

The key steps for achieving BPR at wastewater treatment plants (WWTPs) are illustrated in the simplified diagram in Figure 5-2 and summarized below.

- 1) Return activated sludge from the secondary clarifier, which contains PAOs, is added to the influent wastewater.
- 2) In the anaerobic zone, PAOs break polyphosphate bonds to generate energy. They use this energy to take up VFAs and store them as PHA compounds such as PHB. When PAOs break the polyphosphate bonds, they release phosphate ions (PO_4^{-3}) in their cells. Because each phosphate molecule is negatively charged, it must first bond with positively charged ions such as magnesium or potassium to move across the cell membrane and be released into the water.
- 3) When the mixed liquor (i.e., wastewater and return sludge) enters the aerobic zone, the PAOs use oxygen to metabolize the stored PHAs to generate energy for growth and maintenance. They store the excess energy by taking up phosphate ions along with magnesium, potassium, and other positive ions into their cells and forming polyphosphates. This “luxury uptake” of phosphorus results in more being removed in the aerobic zone than was released in the anaerobic zone.

- 4) As the water enters the clarifier, PAOs settle to the bottom with the rest of the activated sludge. The phosphorus stored in the PAOs is removed with the waste activated sludge, thereby resulting in a net removal of phosphorus during treatment².

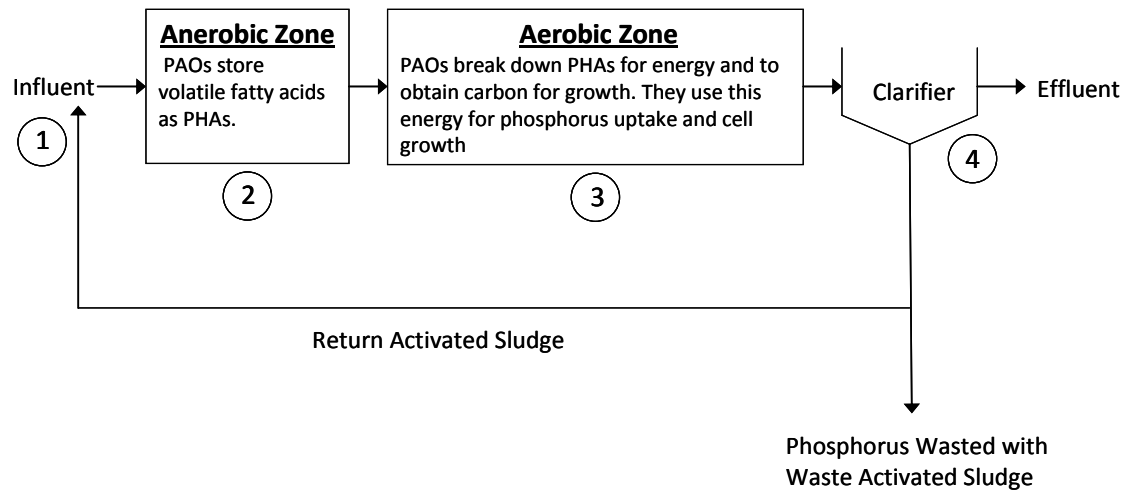

Figure 5-2. BPR at a WWTP

5.2 Substrate Requirements

The availability of readily biodegradable organic carbon (i.e., VFAs) in the anaerobic zone is critical to the success of BPR. Table 5-1 shows the VFAs typically found in fermented wastewater and the observed ratio of mg/L phosphorus uptake per mg/L of each VFA consumed during the treatment of municipal wastewater (Abu-Ghararah and Randall 1991). Acetic acid and propionic acid are the dominant VFAs in domestic wastewater, with the other forms present in minimal concentrations. Common percentages from the fermentation of municipal wastewater settled solids are 60 percent acetic, 30 percent propionic, and 10 percent of the remaining four. Large variations occur, however. Propionic acid, for example, may vary from less than 20 to more than 50 percent, and isovaleric acid may be as high as 10 percent. Research has shown that GAOs do not grow well on propionic relative to PAOs (Chen and Randall 2004; Lopez-Vazquez et al. 2009). Therefore, the ratio of propionic to acetic affects the performance of BPR, with higher amounts of propionic relative to the acetic producing improvements.

²If wasting is directly from a reactor rather than from the clarifier as is practiced at some activated sludge plants and at plants with membrane bioreactors, the activated sludge should be wasted from an aerobic zone, preferably when the sludge phosphorus concentration is at a maximum (i.e. before significant release occurs from extended aeration).

Table 5-1. Volatile Fatty Acids Typically Found in Fermented Wastewater

Volatile Fatty Acid (VFA)	Chemical Formula	Phosphorus Uptake / VFA as COD Consumed
Acetic acid	CH ₃ -COOH	0.37
Propionic acid	CH ₃ -CH ₂ -COOH	0.10
Butyric acid	CH ₃ -CH ₂ -CH ₂ -COOH	0.12
Isobutyric acid	CH ₃ -CH ₂ -COOH-CH ₃	0.14
Valeric acid	CH ₃ -CH ₂ -CH ₂ -CH ₂ -COOH	0.15
Isovaleric acid	CH ₃ -CH ₂ -COOH-CH ₂ -CH ₃	0.24

Note: Acetic acid and propionic acid are the most common VFAs found in fermented wastewater.
 Source: Abu-Ghararah & Randall (1991) as presented in Table 4.2 from WEF and ASCE (2006)

Table 5-2 summarizes the minimum ratios of substrate to total phosphorus to obtain effluent phosphorus concentrations of less than 1 mg/L that have been reported in the literature. Evaluating the chemical oxygen demand to total phosphorus (COD:TP) and five-day biochemical oxygen demand to total phosphorus (BOD₅:TP)³ ratios will provide only a rough approximation of BPR capabilities, but will provide a useful rule of thumb for estimations. Evaluating the ratio of readily biodegradable COD to TP (**rbCOD:TP ratio**) of the process influent is a more reliable way of assessing the BPR capabilities of a wastewater plant and of determining if additional substrate is required to achieve the desired effluent phosphate concentration. Analysis of the rbCOD:TP ratio is superior to analysis of VFA:TP because much of the non-VFA rbCOD can be fermented to VFA in the anaerobic zone as long as there is sufficient SRT (typically at least 1 to 2 days but varies with temperature; WEF and ASCE 2006). Hence, designers may under-predict performance and over-predict the need for additional substrate if only VFA:TP ratios are considered. See the text box following Table 5-2 for information on how to estimate the rbCOD:TP ratio.

Table 5-2. Minimum Ratios for Achieving Total Phosphorus Effluent Concentration of less than 1.0 mg/L

Substrate Type to Total Phosphorus	Recommended Minimum Ratio	References
COD:TP	40 – 45	WEF and ASCE 2006
BOD:TP	20	WEF and ASCE 2006
rbCOD:TP ¹	10 – 16	Barnard et al. 2006
VFA: TP	4 – 16	Neethling et al. 2005

¹ Most accurate

COD = chemical oxygen demand; BOD = biochemical oxygen demand; rbCOD = readily biodegradable chemical oxygen demand; VFA = volatile fatty acid; TP = total phosphorus

³ Unless otherwise indicated, “BOD” is based on the 5-day test. Ultimate BOD (BOD_U) is based on the 20-day test per standard methods (APHA, AWWA, and WEF 2005).

How can I determine the rbCOD:TP ratio at my wastewater plant?

Total Phosphorus (TP). Information on influent TP levels should be available for your treatment plant. TP in domestic wastewater typically ranges between 4 and 8 mg/L but can be higher depending on industrial sources, water conservation, and whether or not a phosphate detergent ban is in place. It is typically measured using colorimetric analysis or ion chromatography and requires a digestion step to convert polyphosphate and organic phosphorus to orthophosphate. TP loading typically follows a diurnal pattern with highest concentrations during the day. Influent concentrations are usually lower during peak wet weather flow events.

Readily Biodegradable Chemical Oxygen Demand (rbCOD). The literature describes several experimental methods that can be used to estimate rbCOD. After extensive review, Melcer et al. (2003) concluded that the ***Aerobic Batch Method*** is the most practical of the bioassay methods, has the least requirement for analytical laboratory facilities, and lends itself to onsite use at WWTPs. For detailed instructions on how to perform this method, refer to Melcer et al. A second, less time-consuming method was published by Mamais et al. (1993) and is based on the assumption that truly soluble degradable COD is representative of the rbCOD. The method requires removal of solids and colloids by flocculation followed by filtration through a 0.45 micron filter prior to COD analysis. The difference in results for an influent and effluent sample is taken to be rbCOD. Melcer et al. found that although the Mamais method is comparable to bioassay methods, results can be up to 5 percent higher. Influent rbCOD can vary significantly between seasons in temperate climates with ranges from 25 to 125 mg/L. See Chapter 10 for additional information on estimating COD fractions.

Research results suggest that the instantaneous COD:TP ratio is more important than the overall average (Neethling et al. 2005). Short-term drops in the BOD:TP ratio in the primary effluent to below that required for the desired quantity of phosphorus removal correlated well with rises in effluent phosphorus. Intermittent recycles of phosphorus-rich return streams may cause short-term variability in the BOD:TP ratio. Weekend changes in the BOD:TP ratio also can affect performance.

5.3 Sources of Volatile Fatty Acids

Section 5.2 described how fermentation of the non-VFA portion of rbCOD can occur in the anaerobic zone of WWTPs to produce additional VFAs. Other sources of VFAs include:

- Fermentation in the wastewater collection system
- Fermentation at the treatment plant (requires new process equipment)
- Commercial sources

Each source is discussed separately below.

5.3.1 Fermentation in the Collection System

Fermentation of wastewater under anaerobic conditions occurs to at least some extent in all wastewater collection systems. Factors that favor anaerobic conditions are:

- Long detention times (e.g., in relatively flat collection mains or pump station wet wells)
- High strength waste
- Warm temperatures

Force mains are also excellent fermenters for the production of VFAs because they flow full and there is no air-water interface for oxygen transfer. Often, the concentration of influent VFAs varies from month to month depending on temperature and flow conditions in the collection system. Further changes will occur within the plant depending on the extent and type of pretreatment, the types of sludge processing equipment, and the utilization of anaerobic digestion.

In addition to VFAs, fermentation produces sulfide. Sulfide is converted to hydrogen sulfide (H_2S) when it enters air such as the head space in gravity sewers or in force main discharge manholes. Hydrogen sulfide has an objectionable odor, and its release can cause corrosion problems when it is converted to sulfuric acid by bacteria on the pipe wall.

Some techniques used for odor and corrosion control in wastewater collection systems do so by reducing anaerobic conditions, which can have detrimental impacts on BPR. Kobylinski et al. (2008) reported that chemical oxidation, nitrate addition, pH control to greater than 11, super oxygenation, and vapor-phase odor control can slow or stop the production of VFAs. Other techniques such as iron addition and pH control to between 9 and 10 do not adversely impact the production of VFAs. Table 5-3 provides a summary of the effect of odor and corrosion control techniques on VFA formation in wastewater collection systems.

Table 5-3. Effect of Corrosion and Odor Control Techniques on VFA Production in Wastewater Collection Systems

Corrosion/Odor Control Technique	Effect on VFA Production
Oxidation of H ₂ S by adding a strong oxidant (e.g., chlorine, sodium hypochlorite, hydrogen peroxide)	<ul style="list-style-type: none"> Strong oxidants easily oxidize VFAs.
Application of nitrate salts (common method)	<ul style="list-style-type: none"> Nitrate creates anoxic condition and prevents fermentation, which in turn prevents VFA formation. Nitrate can also act as an electron acceptor (similar to oxygen), so that oxidizable VFAs are consumed by bacteria.
pH control	<ul style="list-style-type: none"> pH between 9 and 10 will keep hydrogen sulfide in ionized form and prevent release to headspace without affecting VFA production. pH of 11 will slow or stop the rate of VFA fermentation.
Super oxygenation	<ul style="list-style-type: none"> Excess oxygen added in collection system or in force mains eliminates production of VFAs. Excess oxygen can serve as electron acceptor for heterotrophic bacteria to uptake VFAs, but without VFA storage.
Vapor-phase odor control	<ul style="list-style-type: none"> Chemical blow down from wet scrubbing has high chlorine concentration, which can oxidize VFAs.
Iron addition (common method)	<ul style="list-style-type: none"> Iron addition will precipitate sulfide without impacting VFA formation. However, if hydrogen peroxide is added at a downstream location to reactivate the iron, VFAs will be oxidized.

Source: Derived from Kobylinski et al. (2008).

Industrial discharges to the collection system can significantly impact VFA formation. Discharges with high temperatures and/or BOD loading can increase fermentation, while discharges containing nitrate will inhibit VFA production because denitrifying bacteria will use the nitrates to fully metabolize the organics rather than ferment them. Some industries only discharge seasonally or at certain times during the week, which can cause great variations in VFAs and rbCOD entering the wastewater plant. This is more likely to be a problem on weekends when industries shut down. Weekend effects also occur mostly in suburban bedroom communities.

5.3.2 Anaerobic Fermentation of Primary or Return Activated Sludge

Some treatment configurations, such as the Westbank process, make use of anaerobic fermentation of the primary sludge to provide VFAs to the BPR process (See Chapter 6 for a detailed description of this technology). A fermentation process, however, can be added to any configuration to provide VFAs, especially in areas where little fermentation takes place in the collection system. This approach has been used very successfully in cold climates.

Fermentation of the primary sludge or the RAS will produce VFA. Primary sludge fermentation is used more frequently and is generally preferred over fermentation of RAS for reasons provided later in this section.

In the normal anaerobic fermentation of primary sludge, the larger proteins and carbohydrate compounds are reduced by acid fermentation to a variety of simple products. Typical fermentation products are:

- Acetic acid
- Propionic acid
- Butyric acid
- Hydrogen

Under normal operating conditions at pH near neutral, 60 or more percent of the by-products formed are acetic acid. A total of 20 to 30 percent could be in the form of propionic and butyric acid with only small quantities of other fatty acids. VFA production from fermenting primary sludge typically yields 0.066 to 0.15 g VFA/g total solids (both expressed as COD), although values up to 0.3 g VFA/g solids have been reported (Barnard et al. 2005).

In anaerobic digesters, methane fermentation is established spontaneously following the biological pathways shown in Figure 5-3. As the redox potential drops, methane organisms will soon reach an equilibrium wherein the acetates are consumed at the rate at which they are produced. If VFA production and accumulation is desired the growth of methane organisms should be avoided as much as possible. This usually can be accomplished by operating the fermenter at SRTs of no more than 4 days.

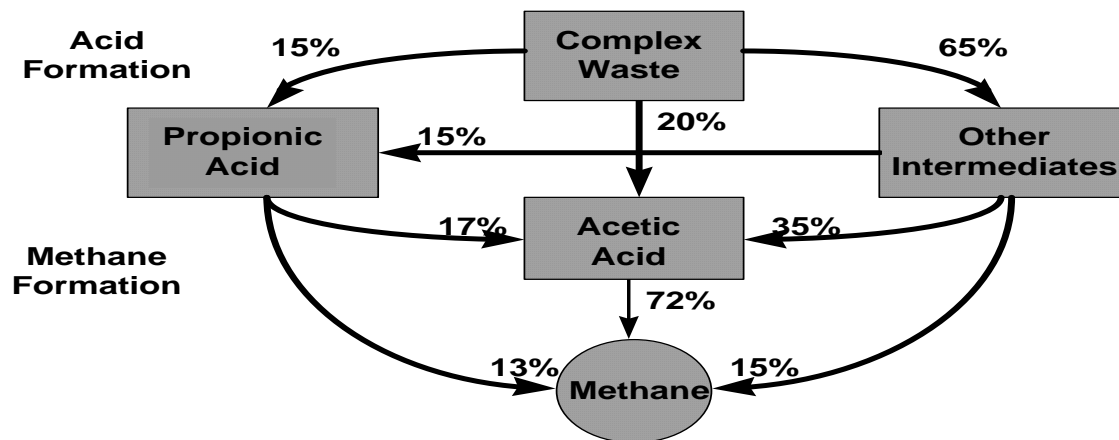

Figure 5-3. Biological Pathways of Methane Formation

There are several primary sludge fermenter designs that have been used successfully in full scale plants. The simplest configuration allows the formation of a thick sludge blanket in the primary clarifier itself where fermentation takes place. Some of the thickened sludge is returned to the influent of the primary clarifier to allow for elutriation of the VFA to the primary effluent. This is referred to as an activated primary sedimentation tank (Barnard 1984). Another variation is to pump sludge to a complete-mix tank ahead of the primary clarifier to accomplish fermentation. The sludge is then passed to the primary clarifier for elutriation of the VFA. Both of these processes lead to an increased solids load on the primary clarifier. Sludge age should be controlled to prevent methanogenic bacteria from growing and converting the VFA to methane. The SRT of the solids in the fermenter will depend on the

wastewater temperature which can vary from winter to summer, but usually less than 4 days is sufficient.

An alternative method accomplishes fermentation in an over-sized gravity sludge thickener by holding the sludge under anaerobic conditions for typically 4 to 8 days⁴ (this is referred to as a static fermenter). The supernatant can then be fed directly to the anaerobic zone, avoiding a high load on the primary clarifier. Thickening can either be accomplished with a single thickener or in two stages. The two-stage process can either be a complete mix tank followed by a thickener or two thickeners in series. It has been shown that adding molasses or other sources of readily biodegradable COD can improve the performance of fermenters (Bott et al. 2007). Static or two-stage fermenters have the advantage over fermentation in the primary sedimentation tank because the VFAs in the supernatant can be discharged directly to the anaerobic zone rather than mixed with the main influent stream. This configuration allows the by-passing of storm flows without significantly affecting the mass of VFA to the anaerobic zone. Elutriating water (either from the primary effluent or the final effluent) can be fed to the fermenter to flush out the VFAs produced and send them to the anaerobic zone.

Some of the RAS can also be fermented in a side stream process at similar SRTs; however, it is critical that designers carefully consider and account for the potential for phosphorus release. Evidence from full-scale plants showed that when some RAS or mixed liquor is fermented in an upflow fermenter, sufficient VFA is produced to overcome the release of phosphorus. RAS or mixed liquor fermentation could be used in any BPR process, but is most common in processes without primary clarifiers.

Fermenters have several advantages over external carbon sources for BPR, including:

- VFA generation results in a favorable ratio of acetic to propionic acids.
- The VFA produced can enhance denitrification by increasing the growth rate of the denitrifiers because VFAs are simple, readily biodegradable substrates.
- The size of the anaerobic zone could be reduced to about 5 percent of the total volume.
- The fermenters will supply VFA at a constant rate even through storm flows.
- VFA fermentation for BPR results in smaller increase in sludge production when compared with precipitating chemicals.
- Fermentation can improve sludge settleability due to selection for PAO's that are good floc formers.

Disadvantages of fermentation include:

- Increased biological load to the aeration basin.
- Odor issues when compared with chemical removal addition for phosphorus removal (odor control is typically needed).

⁴ The actual SRT will depend on the temperature and should be designed to reduce the growth of methanogens.

- Will reduce digester gas production which can reduce energy output if the plant uses digester gas to produce electricity.
- Capital costs of equipment.

See Chapter 10 for recommendations on designing sludge fermentation systems.

5.3.3 Commercial Sources

External sources of VFAs can be added to the WWTP to stimulate BPR. Acetate is typically used because it is the most efficient VFA. Acetate alone, however, does not match the VFAs produced during fermentation of municipal sewage. As noted previously in Section 5.2, acetate usually comprises 40 to 60 percent, propionate 20 to 40 percent, and the other VFAs up to 10 percent of total VFAs in municipal wastewater. Thus, a mixture of acetate and propionate plus small amounts of butyrate and valerate and their iso-forms more closely represent the products of sewage fermentation. Research has shown that the mixture significantly affects the competition between PAOs and GAOs. This will be discussed in greater detail in subsequent paragraphs.

Yuan et al. (2008) examined the effect of the organic carbon source on BPR. The authors compared the production of PHB (but not the other PHAs) and the uptake and release of phosphorus achieved using four different sources of organic carbon: acetate, beef extract, glucose, and municipal wastewater. Experimental results showed that the most effective substrates for phosphorus uptake and release and PHB production and utilization were small, simple molecules such as acetate and glucose. Glucose was the substrate that resulted in the most dissolved organic carbon uptake, but that was partially because it was added in the largest amount. The fastest rate of phosphorus release and highest uptake occurred when acetate was used as a substrate, as expected. Interestingly, the amount of phosphorus released per amount of dissolved organic carbon uptake observed was the same for acetate and municipal wastewater, indicating that the wastewater organics were fermented primarily to acetate. It should also be mentioned that they acclimated the activated sludge used for the batch tests using sequencing batch reactors (SBRs) fed by a substrate that was phosphorus limited rather than organic carbon limited.

Several studies have examined the effects of relative concentrations of acetic and propionic acid on the growth of PAOs and GAOs. An Australian study shows that while both PAOs and GAOs could use acetate, PAOs will have a competitive advantage when the VFAs consist of roughly equal parts of acetic and propionic acid as a growth medium. This is because PAOs that are fed on acetate are able to switch to propionate much more quickly and effectively than GAOs (Oehmen et al. 2005). This finding led to a strategy to feed equal amounts of acetic acid and propionic acid as the optimal for stimulating PAO growth (Oehmen et al. 2006, Bott et al., 2007). Note that studies published by Chen, et al. (2004), Randall and Chen (2008), and Lopez-Vasquez et al. (2009) have shown that an increase in the propionic to acetic acid ratio, even if the acetic acid concentration is greater, resulted in higher net phosphorus removal because the combination favors the PAOs over the GAOs, thereby resulting in higher concentrations of PAOs in the MLSS.

Another study showed that isovaleric acid drives BPR even better than acetic acid (Bott et al., 2007). This finding is in contrast to the results obtained by Abu-Ghararah and Randall (1991), who concluded that isovaleric was the second best VFA for BPR but only 65 percent as efficient as acetic. Isovaleric acid is much more expensive than acetic acid and is more odorous. It also is not significantly

generated in the primary sludge fermentation process. Addition of rbCOD such as sugars and alcohols containing two carbons or more can increase phosphorus uptake by PAOs when added to the anaerobic zone but may cause sludge bulking if dosed in excess (Jenkins and Harper 2004).

5.4 Environmental Conditions

5.4.1 Dissolved Oxygen and Nitrates in the Anaerobic Zone

When dissolved oxygen is present in the anaerobic zone, heterotrophic aerobic organisms can use the oxygen as the electron acceptor and will compete with the PAOs for VFAs. This results in less VFA storage and, subsequently, less BPR. Moreover, if oxygen is available, PAOs can metabolize VFAs completely and use the energy and carbon obtained for growth instead of storing VFAs using energy from polyphosphate bonds for subsequent phosphate uptake. If PAOs use oxygen to metabolize VFAs, they do not release phosphorus in the anaerobic zone during VFA storage, and they do not take up excess phosphorus in the aerobic zone.

Nitrates can also be used as an electron acceptor by facultative (denitrifying) heterotrophs, which include some PAOs. The presence of nitrate in the anaerobic zone will deplete the amount of VFAs available to PAOs, just as the presence of dissolved oxygen does. Nitrates can also inhibit fermentation of rbCOD and reduce the production of VFAs because most of the fermenting microorganisms are facultative and can use nitrate as an electron acceptor to fully oxidize the non-VFA rbCOD instead of producing VFAs as the end product.

Oxygen can be inadvertently added back to the anaerobic zone through recycle flows such as the RAS and by backmixing from inadequately baffled aerobic zones. Nitrates can be introduced to the anaerobic zone by the RAS, by mixed liquor recycles from anoxic zones, by backmixing from inadequately baffled anoxic zones, and by plant recycles such as supernatant from sludge handling facilities. Significant nitrate interference of BPR is much more common than dissolved oxygen interference, and efforts to control nitrate introduction to the anaerobic zone should be practiced at all BPR plants. See section 5.6.2 for additional discussion.

5.4.2 Oxygen in the Aerobic Zone

PAOs need oxygen to digest the storage products and uptake and retain phosphorus in the aerobic zone. Maintaining a sufficiently high DO transfer in the aerobic zone enhances process stability and has been found to be a key factor in phosphorus removal (Bott et al. 2007). However, it should be recognized that the appropriate DO concentration in the mixed liquor for a non-limiting oxygen transfer rate is a function of the way the biological process is being operated, notably the SRT, the mixed liquor suspended solids concentration, and the actual HRT in the reactor. For high rate systems, the DO needs to be 2.0 mg/L or greater in the effluent, i.e., prior to a deoxygenation zone if one is being used. Under these conditions, phosphorus removal can be improved by increasing the mixed liquor DO concentration. However, for long residence time systems such as oxidation ditches, excellent nitrification, denitrification, and excess BPR are possible when DO in the system never exceeds 0.5 mg/L, and varies from near zero in some sections of the ditch to an effluent concentration of 0.25 mg/L (Sen et al. 1990). Similar results are possible with other high HRT configurations such as the Schreiber Process. Re-aeration may be useful to ensure that there is sufficient DO in the MLSS in the final clarifiers to prevent release of phosphorus during settling.

5.4.3 pH

Low pH can reduce and even prevent BPR. Below pH 6.9, the process has been shown to decline in efficiency (WEF and ASCE 2006). Research has shown that it is not possible to establish BPR when the pH in the anaerobic zone is less than 5.5, even if an abundant amount of VFAs are present in the anaerobic zone (Tracy and Flammino 1987; Randall and Chapin 1997).

Filipe et al. (2001) found that GAOs do not grow when the pH is greater than 7.25 in the anaerobic zone. They also showed that low pH values in the aerobic zone will inhibit BPR, but PAOs have the advantage over the GAOs if the zone pH is 7.0 or greater. Fortunately, robust continuous flow BPR systems commonly experience a large pH swing between the anaerobic and aerobic zones (e.g., from 7.2 ± 0.2 to 8.4 or more), and pH control is unlikely to be needed and in fact may be detrimental when treating municipal wastewaters. Because many wastewater processes such as chemical addition and nitrification can lower the pH, it should be monitored in the anaerobic zone and chemically adjusted if necessary.

5.4.4 Temperature

High temperatures (i.e., above 20°C) stimulate GAO acetate uptake rates more than PAO uptake rates, and temperatures of approximately 30°C can have an adverse effect on phosphorus removal (Whang and Park 2006). Bott et al. (2007) have reported that phosphorus removal will generally be impaired at temperatures greater than 28°C. Modeling studies have shown that GAOs can dominate at higher temperatures because of their increased ability to uptake acetate at those temperatures compared to PAOs (Whang et al. 2007).

Panswad et al. (2003) kinetically investigated microbial population dynamics in response to gradual temperature increases in an enhanced BRP system. As the temperature rose from 20°C to 30°C to 35.5°C, the predominant microbial group changed from PAOs (47–70 percent of total volatile suspended solids (VSS)) to GAOs (64–75 percent of total VSS) to the ordinary heterotrophs (90 percent of total VSS), respectively. Despite the species alteration, the phosphorus contents of the PAOs appeared to be steady within 0.182 to 0.308 mg/mg VSS (PAO) regardless of the temperature level. The initial specific phosphorus release rates, which are solely due to the activities of the PAOs, increased with temperature from between 37.5 and 55.9 to between 51.8 and 61.3, 52.0 and 76.9, 147.2 and 210.3, and 374.2 and 756.3 mg P/gm VSS (PAO) hr, at 20°C, 25°C, 30°C, 32.5°C, and 35.5°C, respectively. Although the mean initial specific phosphorus uptake rates of the biomass decreased as the temperature increased, the data implied that the uptake rate of the PAOs was higher than the other two microbial groups. These results indicate that the PAOs are lower-range mesophiles or possibly psychrophiles. As the temperature rises, the portion of energy required for maintenance increases substantially, which reduces the energy availability for cell reproduction; hence, the PAOs can be washed out from the system.

Low temperatures can also lower phosphorus uptake, although this has not been an issue in well operated and properly acclimatized plants (WEF and ASCE 2006). Reduced phosphorus removal performance in the winter is usually caused by reduced fermentation or increased DO and nitrate inputs to the anaerobic zone. In general, BPR capacity is greater at temperatures below 15°C than at higher temperatures if electron acceptor inputs (DO and nitrates) are controlled. In lab experiments, Erdal et al. (2002) found that PAOs out competed GAOs at 5°C even though the PAO metabolism was slower at

5° C than at 20° C. This outcome was because GAOs rely on glycolysis for energy, and glycolysis is very sensitive to low temperatures, resulting in much slower growth rates for the GAOs. The GAOs virtually disappeared in the 5° C reactor, resulting in a much greater excess phosphorus removal capacity of the biomass at 5° C compared to that observed at 20° C because of the much higher concentration of PAOs in the MLSS.

Although BPR capacity is greater at low temperatures, it has been shown that low temperatures can cause PAOs to “wash out” of activated sludge before the heterotrophs capable of removing BOD (McClintock et al. 1991; McClintock et al. 1993; Mamais and Jenkins 1992). Mamais and Jenkins (1992) showed that the wash out point is determined by a combination of temperature and SRT values. That is, at each SRT value, there is a temperature that will cause BPR wash out. This has been demonstrated at both pilot plant and large plant scale.

5.4.5 Cations

The breakdown of polyphosphates increases the phosphate concentration in the cell and the release of phosphates from the cells. However, because each phosphate molecule (PO_4^{-3}) contains three negative charges, it is unable to pass through the cell membrane on its own. To pass through the cell membrane, the phosphate molecule must bond with positively charged ions such as magnesium (Mg^{+2}) and potassium (K^+). Once the phosphate molecule bonds with these charged ions, it becomes neutral and can be transported across the cell membrane. Experiments have shown that magnesium and potassium are essential cations for BPR rather than just providing charge neutralization, whereas calcium and other cations that might become involved are not essential (Pattarkine and Randall 1999).

The release of phosphate from PAO cells is a critical step in the anaerobic zone of BPR wastewater treatment systems. The phosphate will not be released in the anaerobic zone once either magnesium or potassium is depleted, and BPR will cease. There are no known cases, however, of BPR limitation because of inadequate magnesium in domestic and municipal wastewaters, but it has been observed in industrial wastewaters, as well as in the laboratory under experimental conditions.

5.5 Kinetics

The biological processes of WWTPs are designed on the basis of SRT and HRT. The design SRT is based on the growth rate of the activated sludge microorganisms for the organic loading rate of the influent wastewater, which determines the oxygen transfer requirements and waste activated sludge production. The nominal HRT (i.e., the time it takes to fill the reactor(s) if only the wastewater is flowing into it) is used for reactor design. It determines the mixed liquor suspended solids (MLSS) concentration for the design SRT value.

5.5.1 Solids Retention Time (SRT)

In general, a minimum system SRT of 3 to 4 days based on total reactor volume is sufficient for BPR in temperate climate conditions. As long as there are sufficient VFAs available, higher SRTs (as great as 30 days) will not increase phosphorus uptake because the PAO concentration in the mixed liquor will increase until either the VFAs or the available phosphates become limiting. If SRT becomes too great, however, the quality of the effluent will decrease because endogenous respiration will cause release of phosphorus as biomass degrades. The SRT level at which this secondary release occurs is site specific

based on VFA uptake, PHA polymerization and use, and the glycogen breakdown and polymerization rates in corresponding zones of the system (WEF and ASCE 2006).

5.5.2 Hydraulic Retention Time (HRT)

Both anaerobic and aerobic HRT can impact BPR. In the anaerobic zone, sufficient time is needed for the fermentation of non-VFA rbCOD to VFAs and for the storage of PHAs. An HRT of 1 to 2 hours is typically required if most of the fermentation needs to take place in the anaerobic zone. VFA uptake and storage as PHAs, however, is fairly rapid. Thus, the HRT can be much shorter if fermentation of rbCOD in the anaerobic zone is not a significant source of VFAs (as low as 30 minutes, although one hour would typically be used). The anaerobic HRT may vary from 5 to 15 percent of the total nominal HRT of a full biological nutrient removal (BNR) system (removes both nitrogen and phosphorus), with the actual value depending primarily upon whether or not VFAs are supplied to the anaerobic zone from a source other than the influent wastewater.

5.6 Important Design and Operational Considerations

This section identifies some key design and operational parameters that can impact BPR. See Chapter 6 for discussion of specific wastewater plant configurations.

5.6.1 Avoiding Secondary Release of Phosphorus

The release of phosphorus in the anaerobic zone is an essential step of BPR because it indicates that PAOs are uptaking and storing VFAs as PHBs and other compounds. However, phosphorus release can occur for other reasons such as low pH, chemical toxicity, and excessive anaerobic respiration resulting in destruction of PAO cells. Thus, release of phosphorus can also occur in the absence of a source of VFAs. For example, some of the energy stored as polyphosphate is used for cell maintenance, and phosphorus is released to the liquid phase. If PAOs release phosphorus without storing polymerized VFAs, they will not have sufficient energy to remove all of the released phosphorus in the aerobic zone. This occurrence is known as secondary release.

If PAOs enter the aerobic zone with inadequate PHA, they will not have the energy needed for complete phosphorus uptake and the efficiency of phosphorus removal will decrease. This may occur in the following process stages:

- In the anaerobic zone if the HRT is too long and the VFAs are depleted a considerable period before the end of the retention time.
- In the main anoxic zone when the nitrates are exhausted well before the end of the HRT.
- In the second anoxic zone as shown in Figure 5-4 when there are no nitrates to be removed.
- In the sludge blankets of final clarifiers when the RAS rate is too low and sludge is not removed fast enough, resulting in the flow of released phosphates over the effluent weir.

Secondary release may also happen in aerobic zones that are too large, resulting in stored substrate depletion and destruction of PAO cells by endogenous metabolism. Further, excessive depletion in the aerobic zone of the stored glycogen in the PAOs will reduce VFA storage and

phosphorus release in the anaerobic zone, and result in reduced phosphate removal by the BPR system (Punrattanasin and Randall 2000).

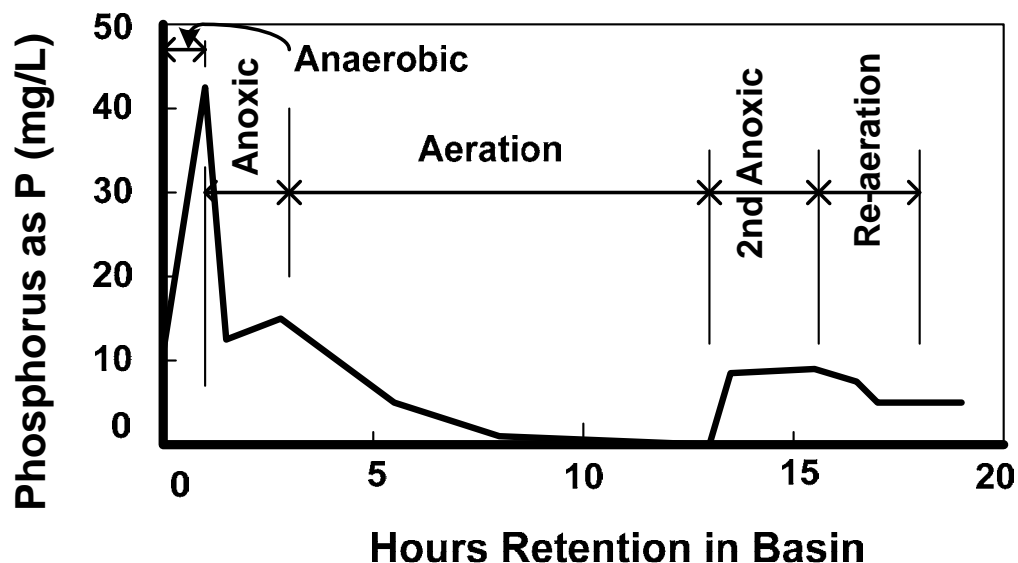

Figure 5-4. Example of secondary release in second anoxic zone.

Phosphorus will be released from PAOs in sludge treatment processes that are anaerobic. Gravity thickening of sludge from BPR processes can lead to phosphorus release if long retention times are used. Mechanical dewatering instead of gravity dewatering allows less retention time and less phosphorus release (Bott et al. 2007). Dissolved air flotation (DAF) is usually recommended to thicken sludge to reduce the amount of phosphorus release. DAF thickening can be quite successful for the reduction of release, but if the thickened sludge is left on the DAF beach too long before removal, excess release will occur just as it will when the sludge is left too long in a gravity thickener.

Anaerobic digestion can also lead to extensive phosphorus release. Some of the phosphorus will, however, be precipitated out as either a metal salt (e.g., calcium phosphate) or as struvite (magnesium ammonium phosphate, $MgNH_4PO_4$). PAOs take up and release magnesium along with phosphates, and these two ions combine with ammonium (which is always present in abundance in anaerobic digesters) to form struvite ($Mg NH_4PO_4 \cdot 6H_2O$). Struvite formation is very fast and will continue until one of the three ions is reduced to its solubility concentration. Magnesium is usually present in the lowest concentration, and its depletion typically limits struvite formation within the anaerobic digester.

Calcium phosphate precipitates also tend to form in anaerobic digesters, but they are non-stoichiometric and form much more slowly than struvite. If substantial amounts of phosphates are precipitated by calcium along with the struvite formation, there will be little if any propensity for struvite to form when the sludge exits the anaerobic digesters. Few struvite problems occur with belt filter press dewatering of the anaerobically digested sludge, but plants using centrifuges for dewatering have reported problems with clogging of the ports. Note that if the digested sludge is composted after dewatering, the resulting Class A sludge will be enriched in magnesium, phosphorus, nitrogen, and, to a lesser extent, potassium, which also is taken up and released with phosphorus by PAOs. Only thirty

percent of the phosphorus entering the anaerobic digesters at the York River plant during four years of BPR experimentation was recycled back to the headworks from belt filter press dewatering. However, it was possible to consistently produce an effluent of less than 1 mg/L TP without effluent filtration, in spite of the phosphorus recycle, following the enactment and implementation of a phosphate detergent ban in Virginia (Randall et al. 1992).

Alternatives to anaerobic digestion such as composting, drying, or alkaline treatment can be used to reduce phosphorus release and recycle. There have been several studies that have examined struvite precipitation as a way to recover phosphorus from digester supernatant. These processes were tested at full scale facilities in Treviso, Italy and Edmonton, Canada (SCOPE 2004), and currently are still operating at those two plants and others including plants in Durham, NC, and Olburgen in the Netherlands.

When anaerobic release of phosphorus occurs, recycling these streams can overload phosphorus removal processes. The effect can be worsened when the waste handling process is only operated intermittently. In some instances, there is a high degree of phosphorus precipitation in the anaerobic digesters, and with sufficient VFAs in the influent, the returned phosphorus may be removed. However, in many circumstances, some chemicals need to be added to the return streams or to the anaerobic digester itself so that the metal precipitate will be removed with the dewatered sludge. The chemical requirement is usually considerably less than when added to the mainstream plant in the absence of BPR. Removing phosphorus from the recycle stream could also reduce the VFA demand in the anaerobic zone and in some cases, allow the plant to avoid adding a fermenter or external carbon source.

5.6.2 Avoiding Backmixing

In configurations where the anaerobic zone is followed immediately by an anoxic or aerobic zone, backmixing can occur unless the design ensures it is impossible. Backmixing can cause elevated concentrations of nitrates and/or dissolved oxygen in the anaerobic zone which favors growth of organisms other than PAOs and thus can inhibit BPR by reducing the VFAs available to the PAOs. In addition, backmixing can cause thick scum to form on the surface of the anaerobic zone.

Aeration of mixed liquor, either diffused or mechanical, increases the depth of the liquid, which causes a hydraulic gradient back toward the non-aerated zone. If the baffling is insufficient, flow from the aerated zone can seep back into the non-aerated (anaerobic or anoxic) zones. Backmixing can be avoided by increased baffling such as an underflow baffle with openings sized to maintain a forward velocity of 1 foot per second (0.3 m/sec) or greater at all times or by changing the mixing rates at the WWTP.

5.6.3 Flow and Load Balancing

Flows and loads to WWTPs can vary widely because of regular diurnal flow patterns and because of larger, more irregular disturbances such as storm events. Peaks in either flow or nutrient load can stress the BPR system and cause reduced performance as measured by effluent phosphorus concentrations. Flow peaks can be evened out by using equalization tanks at the head of the plant. Equalization tanks in combination with nutrient sensors can also be used to balance nutrient loads. In this case, recycle streams high in nutrient concentrations such as digester supernatant can be stored during peak nutrient loads and recycled during times when concentrations are low.

5.7 Impacts on Sludge Processing and Handling

Sludges from BPR processes will have higher phosphorus contents, and therefore a higher settling velocity, but will otherwise be similar to sludge from conventional activated sludge plants. The stored phosphorus adds dry weight to the sludge and improves settling; however, PAOs produce fewer VSS than bacteria that use dissolved oxygen in metabolism because the growth reaction is less efficient.

PAOs can store phosphorus up to 40 percent of their cell mass. Thus, the percent phosphorus in the wasted activated sludge will be determined by the fraction of the activated sludge that consists of PAOs. This fraction is determined by the ratio of the VFAs that become available to the PAOs in the anaerobic zone to the amount of available phosphorus in the anaerobic zone. Either the VFAs or the phosphorus will become limiting in the anaerobic zone, and the PAO fraction will be determined by whichever is limited.

BPR for North American sewage usually results in 4 to 8 percent of phosphorus in activated sludge as a percentage of mixed liquor volatile suspended solids (MLVSS). Phosphorus content as high as 15 percent of MLVSS, however, was observed for several weeks at the HRSD York River WWTP when it was operated as an anaerobic/oxic (A/O) process prior to the phosphate detergent ban in Virginia. The MLVSS at York River was 10 percent phosphorus for several months during 1986 and 1987. The effluent soluble phosphorus concentration was 2.2 to 2.5 mg/L during this period of time, illustrating the inverse relationship between percent P in the MLVSS and effluent TP that is common for EBPR processes. Thus, for some wastewaters the fraction of phosphorus in the wasted dry solids could be 8 percent or more, but as noted earlier it will commonly be between 4 and 8 percent for North American sewage. There is a tendency to think that effluent TSS will contain the same concentration of phosphorus as the MLVSS, but it is much more likely that the effluent TSS from gravity settling will consist primarily of the low specific gravity flocs that contain low concentrations of phosphorus rather than the high specific gravity PAO flocs. Microphotographs consistently show that microbial distributions in activated sludge are not uniform.

With respect to settling and dewatering, varying results have been found, with some plants using BPR reporting little or no change in sludge characteristics (Knocke et al. 1992) and others reporting enhanced settling and dewatering properties (Bott et al. 2007). The sludge produced from BPR will have higher magnesium and potassium concentrations in addition to phosphorus because the PAOs always take up these elements with phosphorus during BPR.

As noted in Section 5.6.1, anaerobic digestion of sludge will lead to release of phosphorus into the liquid recycle stream from dewatering or from supernating of the digester. It is very important that designers consider this potential when designing for BPR because the phosphorus recycled to the

biological process must be removed in addition to the influent phosphorus. However, also as noted in section 5.6.1, because the resulting digester liquid stream is enriched with ammonium, magnesium and phosphate, struvite ($\text{Mg NH}_4\text{PO}_4 \cdot 6\text{H}_2\text{O}$) will precipitate in anaerobic digesters until the concentration of one of the constituents is reduced below its solubility point. If the digester is not supernated (i.e. the digested sludge is not permitted to settle and form supernatant that is wasted from the system), the concentrations will remain at high levels and more struvite precipitation will occur than if supernating is practiced, thereby reducing the amount of phosphorus that will be recycled to the biological process. With abundant phosphorus and ammonium, magnesium is usually the element in short supply because the ionic strength of the magnesium taken up and released is only about 50 percent of the ionic strength of the phosphate uptake and release. Additional precipitation of the released phosphorus with calcium will usually occur after struvite precipitation is complete. During the HRSD York River study, only about 30% of the phosphate released during anaerobic digestion of the BPR sludge was recycled after dewatering on a belt filter press (Randall et al. 1992). It was still possible to obtain an effluent TP concentration of less than 1 mg/L without effluent filtration after the phosphate detergent ban went into effect. Some designers have proposed chemically precipitating struvite or other phosphate solids to avoid high phosphorus return in recycle streams (Bott et al. 2007). Depending on where struvite crystals form, i.e. in the anaerobic digester or after exiting the digester, they can plug centrifuge ports, as well as pumps and pipes used to convey the sludge, if not controlled. However, because of the higher concentrations of magnesium and phosphorus in anaerobic digesters when BPR sludge is digested, most, if not all, of the struvite formation occurs within the sludge and remains with the sludge rather than forming after the sludge and supernatant exit the digesters. Note, however, the reverse typically happens when non-BPR sludge is anaerobically digested. The struvite forms after the sludge or supernatant exit the digester rather than within the digester.

5.8 References

- American Public Health Association (APHA), American Water Works Association (AWWA) & Water Environment Federation (WEF). 2005. *Standard Methods for the Examination of Water and Wastewater, 21st Edition*. Eds. A.D. Eaton, L.S. Clesceri, E.W. Rice, A.E. Greenberg, and M.H. Franson.
- Abu-Ghararah, Z.H. and C.W. Randall. 1991. The Effect of Organic Compounds on Biological Phosphorus Removal. *Water Science and Technology*. 23: 585-594.
- Barnard, J.L. 2006. Biological Nutrient Removal: Where We Have Been, Where Are We Going? In *WEFTEC 2006*.
- Bott, C.B., S. N. Murthy, T. T. Spano, and C.W. Randall. 2007. WERF Workshop on Nutrient Removal: How Low Can We Go and What Is Stopping Us from Going Lower? Alexandria, VA: WERF.
- Chen, Y., A.A. Randall, and T. McCue. 2004. The Efficiency of Enhanced Biological Phosphorus Removal from Real Wastewater Affected by Different Ratios of Acetic to Propionic Acid. *Water Research*. 38(1): 27-36.
- Erdal, U.G., Z.K. Erdal, and C.W. Randall. 2002. Effect of Temperature on EBPR System Performance and Bacterial Community. In *Proceedings of WEFTEC 2002*.

- Filipe, C.D.M., G.T. Daigger, and C.P. L. Grady Jr. 2001. pH As a Key Factor in the Competition Between Glycogen Accumulating Organisms and Phosphate Accumulating Organisms. *Water Environment Research*. Alexandria, VA: WEF. 73(2): 223-232.
- Fuhs, G.W. and M. Chen. 1975. Microbiological Basis of Phosphate Removal in the Activated Sludge Process for the Treatment of Wastewater. *Microbial Ecology*. 2(2): 119-38.
- Jenkins, D.I. and W.F. Harper. 2004. Use of Enhanced Biological Phosphorus Removal for Treating Nutrient-Deficient Wastewater. Alexandria, VA: WERF and IWA Publishing.
- Knocke, W.R., J.W. Nash, and C.W. Randall. 1992. Conditioning and Dewatering of Anaerobically Digested BPR Sludge. *Journal of Environmental Engineering*. 118(5): 642-656.
- Kobylinski, E., G.V. Durme, J. Barnard, N. Massart, and S. Koh. 2008. How Biological Phosphorus Removal is Inhibited by Collection System Corrosion and Odor Control Practices. In *WEFTEC 2008*.
- Lopez-Vazquez, C.M., A. Oehmen, C.M. Hooijmans, D. Brdjanovic, H.J. Gijzen, Z. Yuan, and M.C.M. van Loosdrecht. 2009. Modeling the PAO–GAO Competition: Effects of Carbon Source, pH and Temperature. *Water Research*. 43(2):450-462.
- Mamias, D. and D. Jenkins. 1992. The Effects of MCRT and Temperature on Enhanced Biological Phosphorus Removal. *Water Science and Technology*. 26(5-6): 955-965.
- Mamias, D., D. Jenkins, and P. Pitt. 1993. A Rapid Physical-Chemical Method for the Determination of Readily Biodegradable Soluble COD in Municipal Wastewater. *Water Research*. 27(1):195-197.
- McClintock, S.A., C.W. Randall, and V.M. Pattarkine. 1991. The Effects of Temperature and Mean Cell Residence Time on Enhanced Biological Phosphorus Removal. In *Proceedings, 1991 Specialty Conference on Environmental Engineering*. American Society of Civil Engineers. New York, N.Y. pp. 319-324.
- McClintock, S.A., C.W. Randall, and V.M. Pattarkine. 1993. Effects of Temperature and Mean Cell Residence Time on Biological Nutrient Removal Processes. *Water Environmental Research*. 65(2):110-118.
- Melcer, H., P.L. Dold, R.M. Jones, C.M. Bye, I. Takacs, H.D. Stensel, A.W. Wilson, P. Sun, and S. Bury. 2003. Methods for Wastewater Characterization in Activated Sludge Modeling. WERF Final Report. Project 99-WWF-3.
- Neethling, J.B., B. Bakke, M. Benisch, A. Gu, H. Stephens, H.D. Stensel, and R. Moore. 2005. *Factors Influencing the Reliability of Enhanced Biological Phosphorus Removal*. Alexandria, VA: WERF and IWA Publishing.
- Oehmen, A., A.M. Sanders, M.T. Vives, Z. Yuan, and J. Keller. 2006. Competition between Phosphate and Glycogen Accumulating Organisms in Enhanced Biological Phosphorus Removal Systems with Acetate and Propionate Carbon Sources. *Journal of Biotechnology*. Elsevier Science BV. 123(1):22-32.

- Oehmen, A., Z. Yuan, L.L. Blackall, and J. Keller. 2005. Comparison of Acetate and Propionate Uptake by Polyphosphate Accumulating Organisms and Glycogen Accumulating Organisms. *Biotechnology and Bioengineering*. 91(2). New York, NY: John Wiley & Sons, Inc.
- Panswad T., A. Doungchai and J. Anotai. 2003. Temperature Effect on Microbial Community of Enhanced Biological Phosphorus Removal System. *Water Research*. 37(2):409-415.
- Pattarkine, V.M. and C.W. Randall. 1999. The Requirement of Metal Cations for Enhanced Biological Phosphorus Removal by Activated Sludge. *Water Science and Technology*. 40(2): 159-165.
- Punrattanasin, W. and C. Randall. 2000. Factors Affecting the Production and Storage of Polyhydroxyalkanoates in Activated Sludge Biomass. Proceedings, 1st World Congress of the International Water Association. July 3-7. Paris, France. ISBN: 2-9515416-0-0.
- Randall, C. W. and R. W. Chapin. 1997. Acetic Acid Inhibition of Biological Phosphorus Removal. *Water Environment Research*. 69(5):955-960.
- Randall, A., and Y. Chen. 2008. The Kinetics of Anaerobic and Aerobic Carbon and Phosphorus Transformation for a Septic Wastewater with Varying Propionate:Acetate Ratios. In *WEFTEC 2008*.
- Randall, C.W., H.D. Stensel, and J.L. Barnard. 1992. Design of Activated Sludge Biological Nutrient Removal Plants. In *Design and Retrofit of Wastewater Treatment Plants for Biological Nutrient Removal*. Lancaster, PA: Randall, Ed. Technomic Publishing Co., Inc. pp. 125-126.
- SCOPE. 2004. Newsletter No. 57. July. Centre Européen d'Etudes sur les Polyphosphates. Brussels, Belgium. Available online: <http://www.ceep-phosphates.org/Files/Newsletter/Scope%20Newsletter%2057%20Struvite%20conference.pdf>
- Sen, D., C.W. Randall, and T.J. Grizzard. 1990. *Biological Nitrogen and Phosphorus Removal in Oxidation Ditch and High Nitrate Recycle Systems*. Report CBP/TRS 47/90. Chesapeake Bay Office, USEPA, Washington, D.C.
- Spérandio, M., V. Urbain, P. Ginestet, M.J. Audic, and E. Paul. Application of COD Fractionation by a New Combined Technique: Comparison of Various Wastewaters and Sources of Variability. 2001.
- Tchobanoglous, G., F. L. Burton, and H.D. Stensel. 2003. *Wastewater Engineering: Treatment and Reuse*. New York, NY: McGraw-Hill.
- Tracy, K. D. and A. Flammino. 1987. Biochemistry and Energetics of Biological Phosphorus Removal. Proceeding IAWPRC International Specialized Conference, Biological Phosphorus Removal from Wastewater. Rome, Italy. September 28-30. In *Biological Phosphorus Removal from Wastewater*. pp. 15-26. R. Ramadori, Ed. New York, NY: Pergamom Press.
- WEF and ASCE. 1998. Design of Municipal Wastewater Treatment Plants - MOP 8, 4th Ed. Water Environment Federation and American Society of Civil Engineers. Alexandria, VA: WEF.

- WEF and ASCE. 2006. Biological Nutrient Removal (BNR) Operation in Wastewater Treatment Plants - MOP 29. Water Environment Federation and the American Society of Civil Engineers. Alexandria, VA: WEF Press.
- Whang, L.M. and J.K. Park. 2006. Competition Between Polyphosphate- and Glycogen-Accumulating Organisms in Enhanced-Biological-Phosphorus-Removal Systems: Effect of Temperature and Sludge Age. *Water Environment Research*. 78(1): 4-11.
- Whang, L.M., C.D.M. Filipe, and J.K. Park. 2007. Model-Based Evaluation of Competition Between Polyphosphate- and Glycogen-Accumulating Organisms. *Water Research*. 41(6): 1312-1324.
- Xu, S. and S. Hasselblad. 1996. A Simple Biological Method to Estimate the Readily Biodegradable Organic Matter in Wastewater. *Water Research*. 30(4):1023.
- Yuan, Q., R. Sparling, and J. Oleszkiewicz. 2008. Effect of Different Carbon Sources on Biological Phosphorus Removal and Polyhydroxyalkanoate Production. In *WEFTEC Proceedings 2008*.

This page left intentionally blank

6. Overview of Nitrogen and Phosphorus Removal Technologies

Chapter 6 covers:

- 6.1 Introduction
- 6.2 Nitrogen Removal Technologies
- 6.3 Phosphorus Removal Technologies
- 6.4 Combined Nitrogen and Phosphorus Removal Technologies
- 6.5 Effluent Filtration
- 6.6 Sidestream Management
- 6.7 Technology Performance
- 6.8 Factors for Simultaneously Achieving Low Nitrogen and Phosphorus Effluent Concentrations
- 6.9 References

6.1 Introduction

This chapter describes the many technologies that are available to remove nitrogen and phosphorus from wastewater. It presents findings from an extensive review of nutrient removal technologies and techniques currently applied and emerging at municipal wastewater treatment plants (WWTPs). This chapter also includes a discussion of achievable effluent concentrations based on real-world data from well-operated plants before ending with a discussion of the key factors in simultaneously achieving low effluent total nitrogen (TN) and total phosphorus (TP) concentrations. Refer to Chapters 3, 4, and 5 for detailed discussions on the principles of phosphorus removal by chemical addition, biological nitrogen removal, and biological phosphorus removal, respectively.

The information presented herein complements findings published in the following EPA reports on the subject:

- *Nutrient Control Design Manual — State of Technology Review Report* (Published January, 2009): Profiles the latest advances in technology to achieve consistently low nutrient levels, including effluent filtration and advanced clarification techniques, along with up-to-date research on the removal of emerging microcontaminants. This report was an interim product in the development of this design manual. Full text available at: <http://www.epa.gov/nrmrl/pubs/600r09012/600r09012.pdf>
- *Municipal Nutrient Removal Technologies Reference Document* (Published September, 2008): Presents detailed technical and cost information about both biological and physiochemical treatment technologies for the removal of nitrogen, phosphorus, or a combination of the two. Includes at least one year's worth of full-scale performance data for 27 wastewater treatment facilities in the United States and Canada and 9 detailed case studies. Full text available at: <http://www.epa.gov/OWM/mtb/publications.htm>
- *Emerging Technologies for Wastewater Treatment and In-Plant Wet Weather Management* (Published February, 2008): Describes innovative and emerging technologies for nitrogen and

phosphorus removal, assesses their merits and costs, and provides sources for further technological investigation. Full text available at:
<http://www.epa.gov/OWM/mtb/publications.htm>

Although this chapter provides some examples of proprietary and emerging technologies, it is important to recognize that the industry is always changing and that new technologies not identified in this chapter may emerge in the future. New technologies may be innovative adaptations of existing technologies or technologies borrowed from another industry, and some could lead to considerable performance improvements and cost savings. When evaluating new technologies, designers and plant owners should work closely with their state regulatory agency and use the basic treatment principles in Chapters 3 through 5 of this design manual to ensure that any new technology follows these basic principles and can achieve its claimed removal goals.

6.2 Nitrogen Removal Technologies

Nitrification is an aerobic process in which autotrophic bacteria oxidize ammonia or nitrite for energy production. Ammonia-nitrogen ($\text{NH}_3\text{-N}$) is first converted to nitrite (NO_2^-) by ammonia oxidizing bacteria (AOB). The nitrite produced is then converted to nitrate (NO_3^-) by nitrite oxidizing bacteria (NOB). Both reactions usually occur in the same process unit at a WWTP (e.g., activated sludge mixed liquor or fixed film biofilm). Denitrification is the biological reduction of nitrate or nitrite to nitrogen gas (N_2) in the absence of oxygen (or under “anoxic” conditions). See Chapter 4 for detailed information on the principles of biological nitrogen removal.

Since nitrogen in treatment plant influents is mostly (70 to 80 percent) ammonia, total nitrogen removal requires that nitrification occur first followed by denitrification. In the past, some WWTPs were required only to remove ammonia-nitrogen in wastewater to reduce toxicity to aquatic organisms with no limits on nitrate or total nitrogen. However, many treatment plants are now required to remove nitrogen because both ammonia-nitrogen and nitrate-nitrogen can stimulate algae and phytoplankton growth and lead to eutrophication of U.S. waterways (See Chapter 2 for additional discussion). Many plants that aren't required to remove nitrogen do so anyway by recycling mixed liquor from the nitrification aeration tank to an upstream anoxic tank because it produces alkalinity, uses nitrate produced in aeration zone for BOD removal to thus reduce aeration energy, and improves sludge settling.

Biological nitrogen removal can be accomplished by a variety of treatment configurations using suspended growth, attached growth, or combined systems. Nitrification, denitrification and biochemical oxygen demand (BOD) removal can be accomplished in a single process with bioreactors followed by secondary clarifiers. Systems can also be designed as separate stage systems with nitrification and BOD removal occurring in the same bioreactor or in separate bioreactors, and denitrification occurring in a tertiary process. Membrane bioreactors can be used for solids separation instead of secondary clarifiers. Physical/chemical methods for nitrogen removal are not commonly used at municipal WWTPs and are not addressed in this manual.

Sidestream treatment processes can be used to enhance nitrification. Supplemental carbon is often added for denitrification, and advanced solids separation such as membrane bioreactors (MBR) and effluent filtration can be used to achieve very low levels.

Table 6-1 lists the technologies that are available today (in use and emerging) that can achieve biological nitrogen removal. Discussion of each technology follows the table. Note that technologies that achieve both nitrogen and phosphorus removal are discussed in Section 6.4.

Table 6-1. Matrix of Biological Nitrogen Removal Technologies¹

Configuration	Type	Technology	Section Reference
Single Process Unit for Nitrification and Denitrification	Suspended growth	Modified Ludzack-Ettinger (MLE)	6.2.1.1
		4-Stage Bardenpho	6.2.1.2
		MLE or 4-Stage Bardenpho with Membrane Bioreactor	6.2.1.3
		Sequencing Batch Reactor (SBR)	6.2.1.4
		Oxidation Ditch with Anoxic Zone	6.2.1.5
		Step Feed Biological Nitrogen Removal	6.2.1.6
		Simultaneous Nitrification Denitrification (SNdN)	6.2.1.7
	Attached growth or hybrid	Integrated Fixed Film Activated Sludge (IFAS)	6.2.1.8
		Moving Bed Biofilm Reactor (MBBR)	6.2.1.9
Separate Stage—Nitrification	Suspended growth	Nitrification (See sidestream treatment processes in Section 6.2.4 for discussion of nitrification with bioaugmentation)	6.2.2.1
	Attached growth or hybrid	Biological Aerated Filters (BAF)	6.2.2.2
Separate Stage—Denitrification	Suspended growth	Suspended Growth Reactors (not common)	6.2.3
	Attached growth	Denitrification Filters - Downflow - Upflow Continuous Backwash	6.2.3.1

1. These technologies are for nitrogen removal only. Technologies for removal of both nitrogen and phosphorus are presented in Table 6-3.

6.2.1 Nitrogen Removal in Single Process Unit

This section provides information on technologies that achieve nitrogen removal in a single sludge process, typically by alternating between anoxic and aerobic conditions. Suspended growth processes are discussed first followed by fixed film and hybrid systems. Supplemental carbon can be added to a single unit process to enhance denitrification, although this is more common with separate stage processes where BOD is depleted prior to the last denitrification step. See Section 6.2.3.3 for a discussion of the various carbon sources and issues. Sidestream treatment processes to enhance nitrification are discussed in section 6.6.

6.2.1.1 Modified Ludzack-Ettinger (MLE) Process

The most common nitrogen removal process used at WWTPs, the Modified Ludzack-Ettinger (MLE) process, is a pre-denitrification, single sludge system. The process includes an initial anoxic zone

followed by an aerobic zone. In the anoxic zone, nitrate produced in the aerobic zone is reduced to nitrogen gas using BOD in the anoxic zone influent. Nitrification occurs in the aerobic zone along with the removal of nearly all remaining soluble BOD. At the end of the aerobic zone, pumps recycle the nitrate-rich mixed liquor to the anoxic zone for denitrification. See Figure 6-1 for the MLE process schematic.

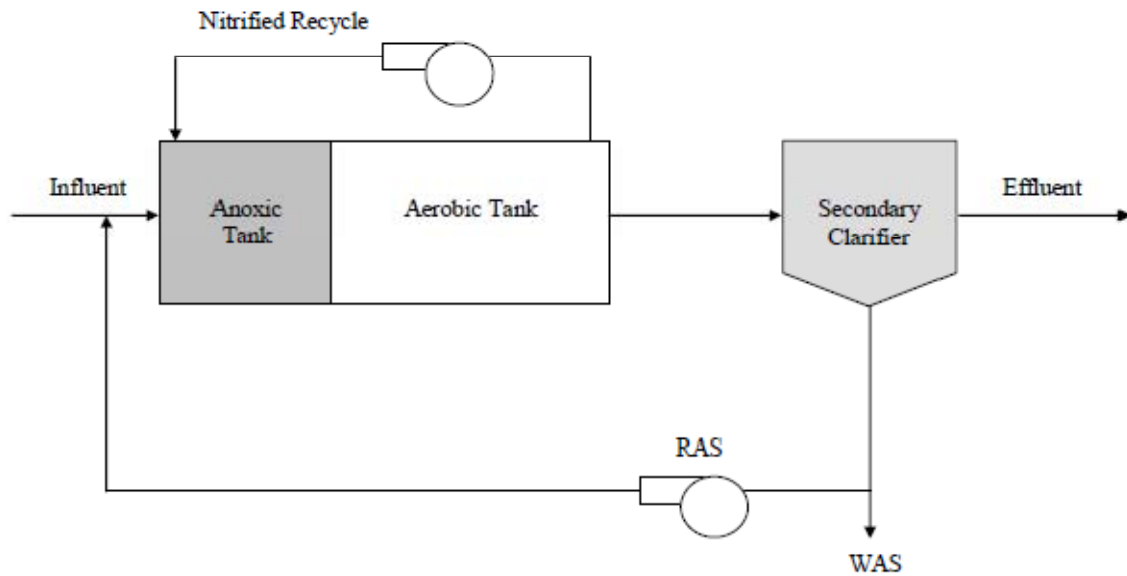

Figure 6-1. Modified Ludzack-Ettinger (MLE) process.
RAS = Return activated sludge; WAS = Waste activated sludge
Source: USEPA 2008b Figure 2-3

The MLE is constructed either by adding an anoxic zone ahead of an aerobic activated sludge process or by constructing walls in an existing aeration basin to create an anoxic zone at the influent end, although this will reduce the aeration zone nitrification capacity. A retrofit to an existing activated sludge plant will require pumping and piping for the internal recycle stream. Nitrogen removal might be limited by factors such as carbon source availability, process kinetics, and anoxic or aerobic zone sizes. Oxygen recycled from the aerobic zone can negatively affect the denitrification rate in the anoxic zone. An additional carbon source may be needed for denitrification.

One challenge of the MLE process and any similar processes that rely heavily on recycling is to make sure that the system hydraulics are suitable. RAS rates can be quite high and baffles need to be designed accordingly.

6.2.1.2 4-Stage Bardenpho

The first two stages of the 4-stage Bardenpho are identical to the MLE system. The third stage is a secondary anoxic zone to provide denitrification of the portion of the flow that is not recycled to the primary anoxic zone. The fourth and final zone is a re-aeration zone that serves to strip any nitrogen gas and increase the dissolved oxygen (DO) concentration before clarification (see Figure 6-2). Methanol or another carbon source can be added to the third stage to enhance denitrification. Some configurations have used an oxidation ditch with a low DO zone instead of the first two stages.

The 4-stage Bardenpho process involves several basins and has a larger footprint than the MLE process. The footprint can be reduced by adding external organic carbon to the second anoxic basin. Pumping and piping are required for the internal recycle. The process has been combined with MBRs to achieve low effluent nitrogen.

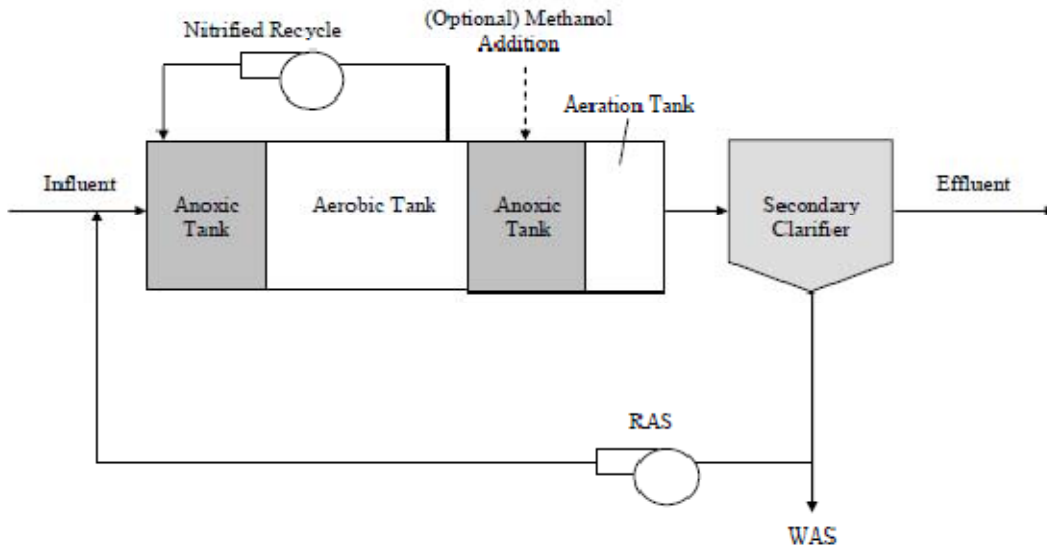

Figure 6-2. 4-stage Bardenpho process.
Source: USEPA 2008b Figure 2-5.

6.2.1.3 MLE or 4-Stage Bardenpho with Membrane Bioreactor (MBR)

Membrane bioreactors (MBRs) use membranes placed in the last aerobic zone of either an MLE or 4-stage Bardenpho treatment system for liquid-solid separation instead of conventional clarification. Membranes can be submersed in the biological reactor or located in a separate stage or compartment. See Figure 6-3 for common configuration of a membrane bioreactor in a 4-stage Bardenpho nitrogen removal system.

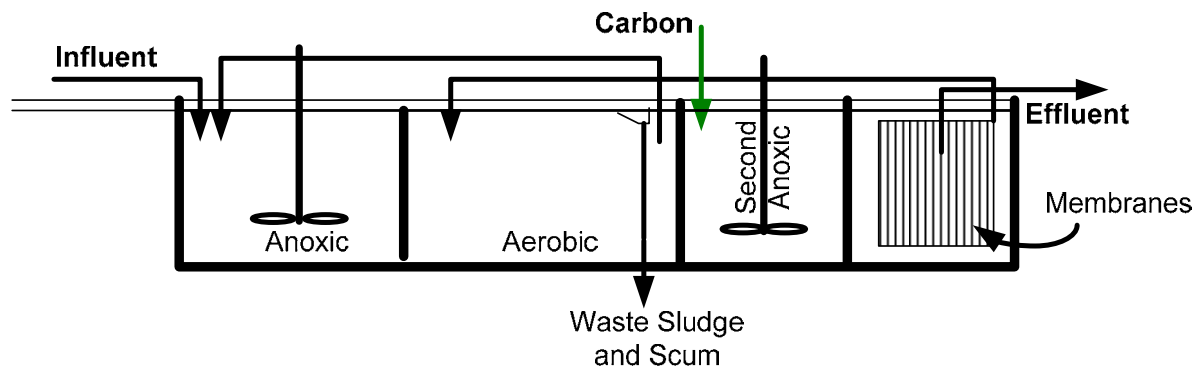

Figure 6-3. Common configuration for a membrane bioreactor 4-stage bardenpho treatment system

Low-pressure membranes (ultrafiltration or microfiltration) are commonly used. Systems can be pressure or vacuum driven. Despite similar design solids residence times (SRTs) and design principles, MBR systems operate at a higher mixed liquor suspended solids (MLSS) concentration, which results in smaller tanks and smaller space requirements than biological nitrogen removal systems with secondary clarifiers. In addition, membrane separation provides for greatly reduced total suspended solids (TSS) in the effluent, typically well below 1.0 mg/L, and, hence, slightly greater removal of nitrogen and phosphorus.

Membrane materials are either organic polymers or inorganic materials such as ceramics. They are designed in modular units and are typically configured as either hollow fiber bundles or plate membranes. All membrane systems use an air scour technique to reduce buildup on the membranes (USEPA 2007b; USEPA 2008a). Membranes require periodic cleaning (typically 2 to 4 times per year) using citric acid or sodium hypochlorite solution. Operational issues include membrane biofouling, chemical costs, loss of production for cleaning, and increased pumping requirements with increased electricity costs (USEPA 2007b; WEF 2005). MBR systems overall produce less waste sludge than conventional systems because they tend to be operated at higher SRTs. When operated at the same SRTs there is very little difference, with the MBR system producing slightly more sludge because of greater effluent TSS capture.

6.2.1.4 Sequencing Batch Reactor (SBR)

Sequencing batch reactors (SBRs) are fill-and-draw batch systems in which all treatment steps are performed sequentially for a discrete volume of water in a single or set of reactor basins. SBRs use four basic phases for most systems: fill, react, settle, and decant, followed by an idle period (see Figure 6-4 for a depiction of operating cycles). The SBR control system allows it to mimic the treatment environments of other suspended growth processes such as the MLE or 4-Stage Bardenpho system by

use of multiple aeration and anoxic periods. It typically completes 4 to 6 cycles per day per tank when treating domestic wastewater¹.

A common design is two SBRs in parallel to allow treatment of the continuous inflow and for one to be taken out of service for maintenance, plus one spare basin used for flow storage and equalization, initially, and becoming the third SBR when expansion is desired. Additional treatment trains can improve reliability for meeting low effluent goals. The key to the SBR process is the control system, which consists of a combination of level sensors, timers, and microprocessors, which can be configured to meet system needs for nitrogen removal (Sen et al. 1990). SBRs are often sold as package plants and are more commonly used for small community WWTPs. Individual SBR basins are relatively small because they do not have a separate clarifier, but the overall footprint is typically medium because designs usually call for multiple SBRs in parallel and the use of an equalization basin. A primary advantage of SBRs is that settling occurs under quiescent conditions, thus making it more efficient, and they are easy to automate.

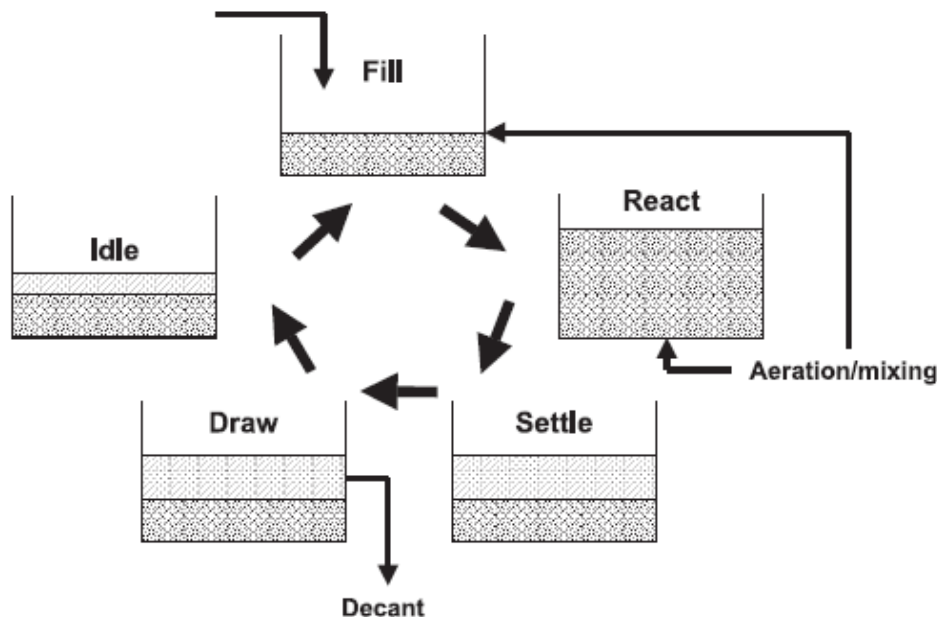

Figure 6-4. Operating periods of a sequencing batch reactor.
Source: USEPA 2008c.

6.2.1.5 Oxidation Ditch with Anoxic Zone

Oxidation ditches are looped channels that provide continuous circulation of wastewater and biomass. They typically operate as racetrack configurations around a central barrier, with forward mixed liquor flows of approximately 1 foot per second or more and long SRTs (e.g., 15 to 30 days), although shorter SRTs are possible. The aerators are typically rotating brushes or turbines that move the water as well as transfer oxygen. Therefore, no additional pumping or piping is typically

¹ SBRs can be operated to achieve biological phosphorus removal (BPR) by using a larger batch reactor with an anaerobic period; however, chemical addition is more commonly used for treatment to low effluent TP levels (Young 2008).

needed compared to a conventional activated sludge system, which reduces energy costs. Oxidation ditches are widely used in small- to medium-sized communities (WERF 2000a). Oxidation ditches are commonly designed with a large footprint and thus, are used less for large, urban systems. See Figure 6-5 for a typical oxidation ditch configuration

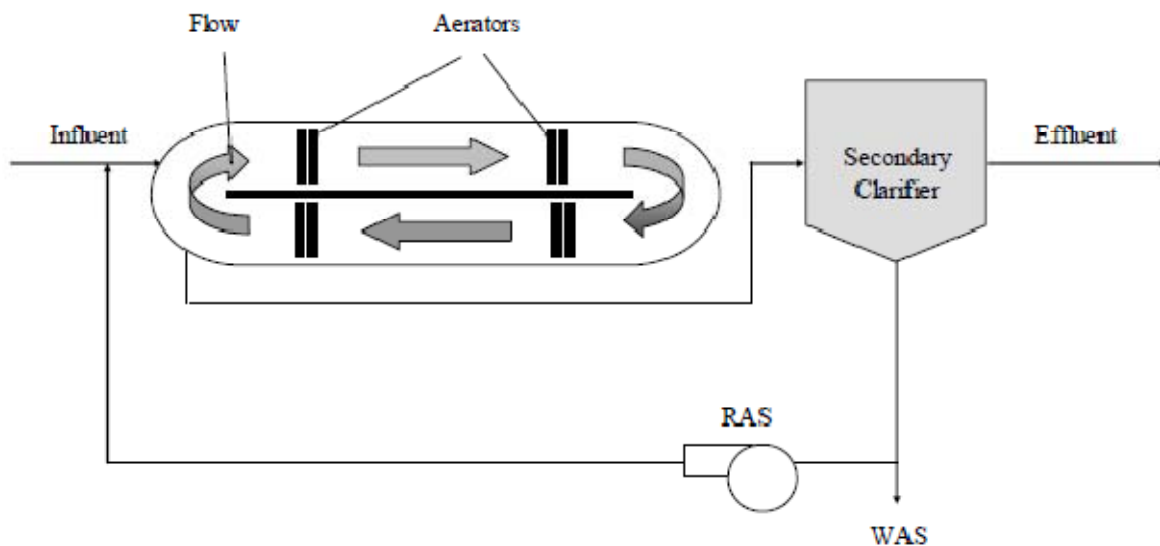

Figure 6-5. Example oxidation ditch configuration.
Source: USEPA 2008b, Figure 2-6

Most oxidation ditches can be operated to remove a substantial amount of TN due to the long SRTs that ensure complete nitrification, the high MLSS concentrations (often in excess of 3,000 -6,000 mg/L) that encourage simultaneous nitrification-denitrification, and the unique DO profiles along the flowpath that can be manipulated by controlling oxygen transfer by the rotor mixing systems. Oxidation ditches that are specifically designed to remove nitrogen typically work by cycling the flow within the ditch between aerobic and anoxic conditions. TN removal can be enhanced by using automatic controls (typically DO or Oxidation Reduction Potential) to turn rotors/mixers on and off to maintain desired DO setpoints along the flow path.

Patented oxidation ditch designs for nitrogen removal include the Carrousel and Phased Isolation Ditch (PID) (the latter also known as the Biotenitro and Biotenipho) processes. The Carrousel oxidation ditch is a variation of the traditional design. These ditches are typically deeper than standard oxidation ditches and use turbine aerators for aeration, mixing, and propulsion instead of rotors. The PID process uses pairs of ditches operating in alternating anoxic-aerobic or anaerobic-anoxic-aerobic modes. See section 6.4.1.5 for a discussion of proprietary oxidation ditch designs that can achieve both nitrogen and phosphorus removal (e.g., the Orbal process)

6.2.1.6 Step Feed Biological Nitrogen Removal

The step feed biological nitrogen removal process splits the influent flow and directs a portion of it to each of two or more (typically 3 or 4) anoxic-aerobic zone combinations in series with similar portions of the influent flow going to each zone but a lesser amount to the last anoxic-aerobic

combination prior to clarification to minimize the discharge of ammonium in the effluent (see Figure 6-6). The biomass in the later stages is not just treating influent flow but is also reducing nitrate from the upstream zones.

The step feed system also provides flexibility for systems to handle wet-weather events. The excessive flow is directed to the last or latter stages and normal flow is maintained in the initial stages. Step feed systems can be compatible with existing conventional “plug flow” activated sludge processes, and they do not require the installation of recycle pumps and piping, just step-feed pipes. The footprint can be large to accommodate both nitrification and denitrification; however, as a retrofit technology, a step feed system is able to redirect the flows of an existing activated-sludge system without needing to increase its footprint through adding tank volume. Operational disadvantages include the need to control the DO concentration of aeration zones preceding the downstream anoxic zones and the need to control the flow splitting to the step feed points.

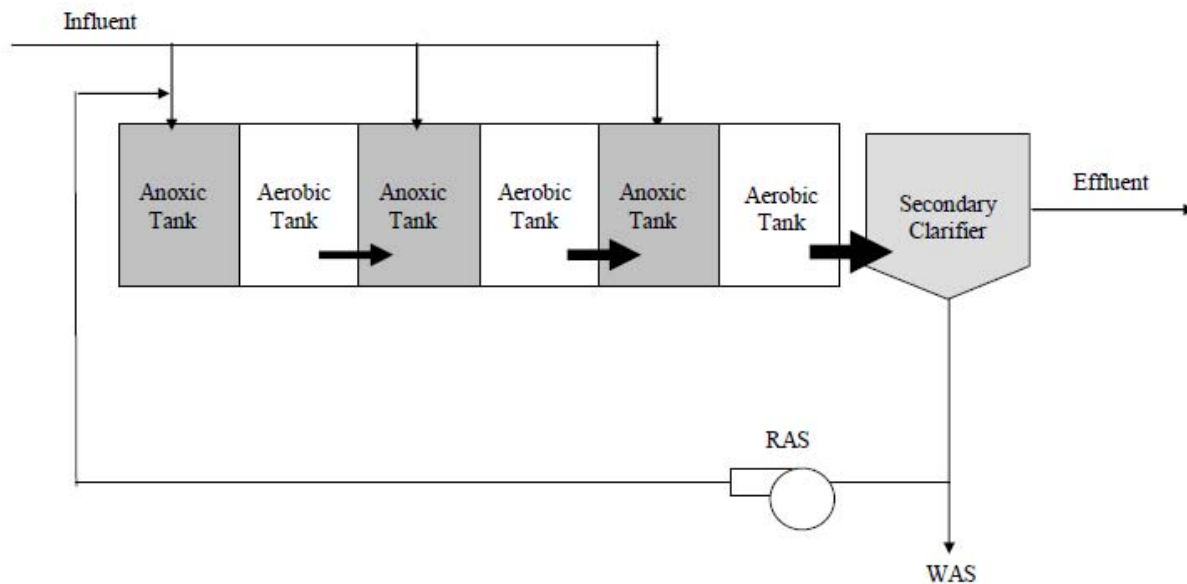

Figure 6-6. Step feed biological nitrogen removal.
Source: USEPA 2008b, Figure 2-10

6.2.1.7 Simultaneous Nitrification Denitrification (SNdN)

Simultaneous Nitrification Denitrification (SNdN) is a process whereby DO concentrations are low enough so that oxygen does not penetrate the entire activated sludge floc. Thus, nitrification is occurring on the exterior portions of the floc and denitrification is occurring in the anoxic, interior portions. SNdN commonly occurs in oxidation ditches. SNdN necessitates a larger reactor volume compared to nitrification only; however, it does not require a separate zone for denitrification and can result in reduced energy requirements. The need for an additional carbon source for denitrification is typically reduced or eliminated because the entire process is accomplished in one tank. See Chapter 4, section 4.14 for additional discussion of SNdN mechanisms.

One example of a patented technology that uses SNdN is the Schreiber Process. The wastewater enters a circular basin equipped with a rotating bridge that provides mixing. Aeration is provided by fine-bubble diffusers attached to the bridge. The aeration can be turned off to sequence between aerobic and anoxic conditions while the moving bridge continues to keep the tank mixed. The separation of mixing and aeration makes the system very easy to control for SNdN, as well as for BPR in the same reactor.

Another technology that takes advantage of SNdN is marketed as the proprietary Symbio[®] system by Enviroquip[®], a division of Emico Watertechnologies, Inc (USEPA 2008a). It uses a probe to measure the level of nicotinamide adenine dinucleotide (NADH) in the biomass and the DO of the wastewater to predict changes in BOD. Based on instantaneous readings, aeration is adjusted to maintain optimal conditions (DO < 1 mg/L) for SNdN. Operating data from three municipal WWTPs show TN removal to 10 mg/L or less (Trivedi and Heinen 2000). This technology is commonly used for industrial treatment systems.

6.2.1.8 Integrated Fixed Film Activated Sludge (IFAS)

Integrated fixed film activated sludge (IFAS) is a relatively new technology that describes any suspended growth system that incorporates an attached growth media within the suspended growth reactor (either aerobic or anoxic zone)². Many types of fixed and floating media are available, as summarized in Table 6-2.

Table 6-2. IFAS Media Types, Applications, and Design Considerations

Media Type	Description	Products Names (Partial List)	Design and Operational Considerations
Textile or rope media	Also called looped-cord or strand media. Consists of a polyvinyl chloride-based material woven into rope or web with loops along its length to provide surface area for the biomass. Arranged within a rigid frame.	AccuWeb Cleartec Ringlace Biomatrix	Rope needs to be located in area with low BOD and high ammonia concentration for enhanced nitrification. Middle of aeration zone is usually the optimum location. Aeration and mixing should provide cross flow pattern. Worm growth has been reported but can be controlled by creating anoxic conditions and chlorinating the RAS. High DO encourages worms, while low DO increases SNdN and discourages worms.
Sponge	Free floating cuboids with specific gravity close to water distributed throughout the media	Linpor	Requires air knife and airlift pump with an impingement plate passive squeezing to keep media from sinking. Requires downstream screen. Replacement of some media is required during first few years of operation.
Plastic	Free floating plastic media	Kaldnes Hydroxyl iPAC Entex	Requires downstream screen. Media does not need to be replaced.

Notes: RAS = return activated sludge; HDPE = high-density polyethylene

Source: USEPA 2008b; WEF and ASCE 2006.

² Although most IFAS systems have been used for biological nitrogen removal rather than biological phosphorus removal, pilot-scale research by Sriwiryarat and Randall (2005) has demonstrated that BPR can be combined with IFAS in the same treatment train. Researchers did not use media in the anaerobic zone, and recommend against this practice. Media was used in the anoxic zone with effectiveness.

A fine screen is recommended upstream of the secondary process to prevent material such as hair from interfering with the surface area of the medium (USEPA 2008b). Free floating systems require installation of effluent screens to keep the media in the reactor (Gellner et al. 2008). The free floating media also requires more energy input than fixed media because of the need for mixing. Sponges require recycle as well as mixing.

IFAS has several benefits over suspended growth nitrification systems, including (WEF and ASCE 2006):

- Increased biomass without increased solids loads on the secondary clarifier.
- Can provide more treatment capacity with the same footprint because the selected media is installed within an existing basin.
- Can improve nitrification under cold temperatures because the attached nitrifiers have a much longer SRT than the suspended growth ones.
- Sludge has improved settling characteristics.
- Nitrification is more resistance to toxics and washout.
- Low additional operating costs.

Higher residual DO levels are typically needed when non-porous media are used in the aerobic zone to penetrate the slime layer, which is a feature of this type of media, if the objective is to maximize nitrification. However, lower DO concentrations can be used to establish simultaneous nitrification-denitrification. Porous media systems typically operate at residual DO levels of 1.5 to 2.0 mg/L using fine bubble diffusers. Thomas et al. (2009) found that an IFAS system could be operated with a lower volume fraction of media if higher DO concentrations were used during low temperature periods.

6.2.1.9 Moving Bed Biofilm Reactor (MBBR)

The moving bed biofilm reactor (MBBR) is similar to the suspended media IFAS systems in that it uses plastic media with a large surface area to increase biomass within the biological reactor. However, there is no mixed liquor recycle as there is with IFAS. The MBBR media is submerged in a completely mixed anoxic or aerobic zone and contained in the zone with screens or sieves. The plastic media are typically polyethylene with a specific gravity of slightly less than 1.0. The carrier elements from most manufacturers are shaped like cylinders or wheels with internal and external fins. These shapes provide a high surface area per unit volume that is protected from shear forces, allowing better biofilm growth (USEPA 2008b). Slow speed submersible mixers are typically used in anoxic zones, while aeration is typically supplied by coarse bubble diffusers in aerated zones (WEF and ASCE 2006) to obtain good mixing.

Like IFAS, MBBR can be used in separate aerobic and anoxic zones. They can reduce solids loading, generate sludge with better settling characteristics, and prevent inhibition and washout of

nitrifiers in aerobic zones. Unlike IFAS, MBBR systems do not involve any return flow and do not rely on suspended growth to provide treatment.

6.2.2 Separate Stage Processes—Nitrification

6.2.2.1 Suspended Growth Nitrification

Suspended growth nitrification and BOD removal are commonly accomplished in the same aerated basin as long as two conditions exist: (1) the biomass inventory is retained long enough to establish a stable population of nitrifiers and (2) the hydraulic retention time (HRT) is such that the biomass can react with the ammonia-nitrogen entering the system. Because nitrifying bacteria have slower growth rates than BOD-consuming bacteria, nitrification kinetics govern the process design, with the critical design parameter being design SRT.

With sufficient DO (generally 2 mg/L or greater) and adequate pH (generally at least 6.8), typical design SRTs required for nitrification range from 10 to 20 days at 10°C and 4 to 7 days at 20°C (Randall et al., 1992). The nitrification kinetics and thus, design SRT, vary considerably from system to system depending on site-specific factors such as operating DO, mixing, floc size, temperature, alkalinity, and presence of inhibitors in the influent. Because of this variability, designers are strongly encouraged to determine site-specific nitrifier growth rates rather than using values from industry literature. See Chapter 10 for guidelines on determining site-specific nitrifier growth rates. See Chapter 4 for an in-depth discussion on the microbiology of nitrification, reactions and stoichiometry, nitrification kinetics, and factors affecting nitrifier performance at WWTPs.

The SRT needed for near complete nitrification of influent ammonia can be reduced significantly by using a series of aeration tanks (staged systems) versus a single aeration tank. The effect is less pronounced for systems with high return sludge recycle rates, such as MBRs, in which the influent nitrogen is substantially diluted. For plants having difficulty in nitrifying due to insufficient SRT, there are some emerging sidestream processes that can increase the nitrification rate. One of these is bioaugmentation. Bioaugmentation is accomplished by seeding the activated sludge process with an external source of nitrifying bacteria (also known as external bioaugmentation) or making process improvements to increase the activity of or enrich the nitrifier population (also known as *in situ* bioaugmentation). See Section 6.6 for a discussion of several bioaugmentation technologies.

6.2.2.2 Attached Growth Nitrification

Trickling filters and rotating biological contactors (RBCs) have historically been used for biological treatment of wastewater and can achieve nitrification with a low organic loading and a relatively high media volume. Typically, nitrification is achieved on the media after most of the BOD is removed because the heterotrophic population competes with the nitrifying organisms for oxygen and space on the media. Major disadvantages of these technologies compared to suspended growth systems is that the SRTs cannot be controlled, and denitrification is either fully dependent on the addition of a supplemental carbon source or a two stage system must be constructed, e.g. anoxic filter followed by an aerobic filter with recycle of nitrates back to the anoxic filter. Suspended growth processes, on the other hand, are more flexible because the SRT can be precisely controlled, and they can be designed to denitrify 80 percent or more of the nitrate resulting from near complete nitrification

using the incoming BOD as the carbon source, which is a lower cost solution. Consequently, trickling filters and RBCs have fallen out of favor for nutrient removal applications.

Existing trickling filters, however, can be integrated into a BNR system (Hu 2001). One approach is to first treat wastewater in an anaerobic activated sludge basin, followed by internal settling of the mixed liquor. The clarified liquid is sent to the trickling filter for nitrification, whereas the settled flow is routed to the main anoxic tank, which also receives the nitrified effluent from the trickling filter, where denitrification is accomplished. The denitrified flow from the anoxic zone goes to a small aerobic basin to strip the nitrogen gas out of the flow prior to settling the mixed liquor in an anoxic basin. From the anoxic basin, the flow is briefly aerated to strip the nitrogen gas and the flow is settled with the RAS returned to the anaerobic zone. This can be accomplished with an activated sludge SRT of 8 to 10 days in temperate climates and also is useful for controlling filamentous microorganisms.

Newer attached growth systems called biological aerated filters (BAF) have taken the place of trickling filters and RBCs. They differ from trickling filters in that the media is smaller, i.e. has a higher specific surface area, and a built-in aeration system. BAFs originated in Europe and now are installed in several locations in North America (Sen et al. 2008). BAFs can be configured in series to remove BOD in one unit and oxidize ammonia-nitrogen in the next, or they can be designed for BOD removal and nitrification in a single unit, depending on process goals. Additionally, they are used for denitrification. BAFs require higher DO concentrations in the bulk water compared to suspended growth nitrification to promote DO diffusion into the biofilm. Vidal et al. (1997) recommend a minimum DO concentration of at least 6 mg/L; recent pilot- and full-scale studies in California found good nitrification at a consistent minimum DO concentration of 7 mg/L (Holloway et al. 2008). Advantages of BAFs include their smaller footprint, higher hydraulic loading rate, and less susceptibility to washout than suspended sludge systems (Verma et al. 2006). BAF performance is also relatively insensitive to temperature (Zhu and Chen 2002; Holloway et al. 2008), which can be a significant advantage in cold weather regions. BAF technology can also be configured for pre- or post-denitrification, with post-denitrification requiring the addition of a supplemental carbon source.

The EPA emerging technologies report (USEPA 2008a) identified two proprietary BAF designs as established technologies: the Biofor® system and the Biostyr® system. The Biofor® filtration system is a fixed bed, upflow, expanded bed system with dense granular clay media. Air is sparged into the filter to maintain an aerobic environment. The Biostyr® system is similar but uses media that are less dense than water, and the system operates as an upflow packed bed held in place during operation by a screen at the top of the cell.

6.2.3 Separate Stage Processes—Denitrification

A separate-stage denitrification system may be appropriate for plants that are regularly achieving nitrification and need to add denitrification capabilities. Suspended growth systems are not common, although they have been used for some treatment plants. Suspended growth reactors typically have short SRTs and a small aerated zone following the denitrification zone to oxidize excess methanol and release nitrogen gas bubbles contained in the denitrified mixed liquor (WEF and ASCE 2006).

6.2.3.1 Denitrification Filters

Denitrification filters were first installed in the 1970s and are a popular add-on technology for wastewater utilities trying to consistently achieve low effluent TN limits. They have the advantage of providing both denitrification and effluent filtration. Because the BOD has been removed from the wastewater during secondary treatment, a supplemental carbon source must be added (see Chapter 4 for an extensive discussion on consumption rates and kinetics of exogenous carbon sources). Denitrification filters typically have a small footprint compare to attached growth systems, but require additional pumping and energy costs.

Denitrification filters have evolved into two main process configurations: downflow filters and upflow continuous backwash filters. Downflow denitrification filters are deep bed filters consisting of media, support gravel, and a block underdrain system. Media depths are typically 8 to 12 feet, and loading rates are between 2 and 3 gallons per minute per square foot (gpm/ft²). Wastewater flow is directed over weirs onto the top of the filter where a supplemental carbon source, typically methanol, is added. Backwashing (typically air scouring and backwashing with air and water) is conducted at regular intervals to remove entrapped solids from the filter. During operation, nitrate is converted to nitrogen gas and becomes entrained in the filter media, increasing head loss through the filter. To release entrained nitrogen, most downflow denitrification systems have a nitrogen-release cycle operation that essentially “bumps” the filter by turning on the backwash pump(s) for a short period of time. See Figure 6-7 for a schematic of a typical downflow denitrification filter.

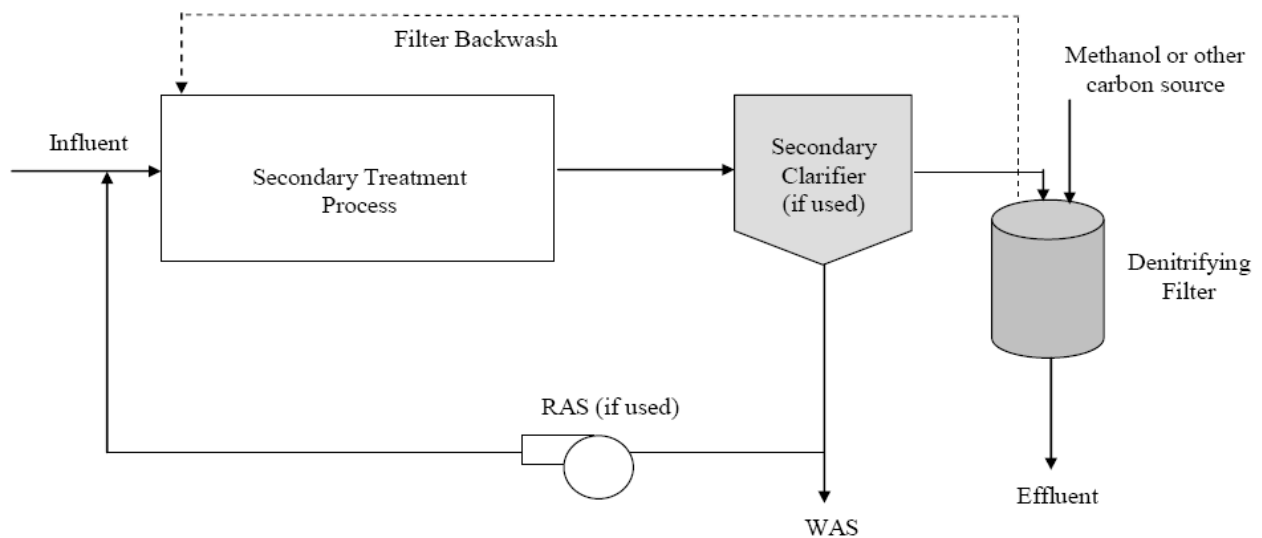

Figure 6-7. Downflow denitrification filter.
Source: USEPA (2008b), Figure 2-1

Upflow continuous backwash filters have the advantage of remaining in service during backwashing, as they are an integral part of the filtering process. Wastewater enters the bottom of the filter where a carbon source, typically methanol, is added. Water flows up through an influent pipe and is dispersed into the filter media through distributors. Filtered water discharges at the top of the filter. Filter media continuously travel downward, are drawn into an airlift pipe at the center of the filter, and

are scoured before being returned to the filter bed. See Figures 6-8 and 6-9 for process schematics of upflow continuous backwash filters.

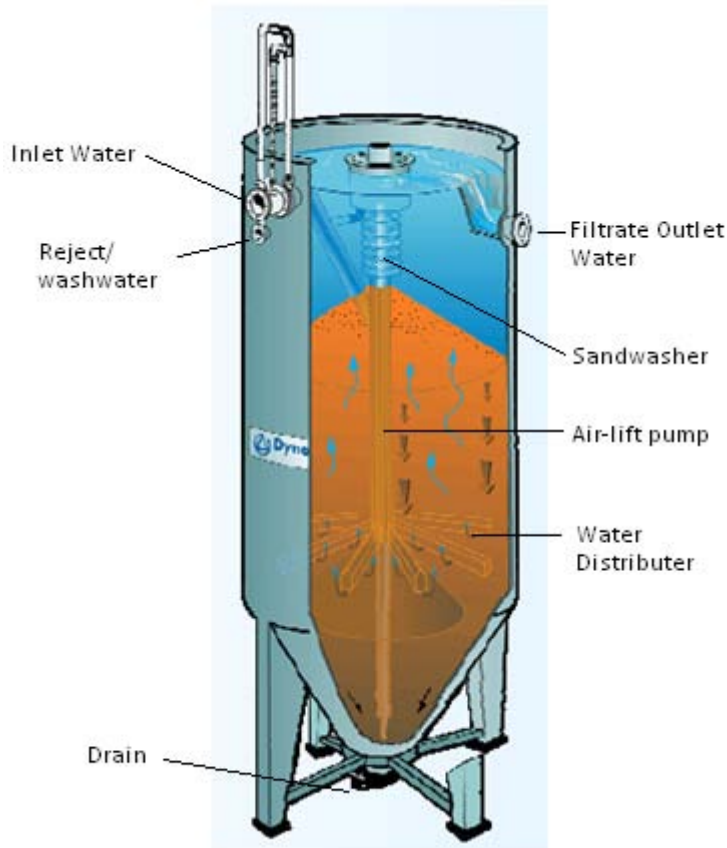

Figure 6-8. Continuous backwash upflow sand (CBUS) filters.
Source: Feldthusen 2004. © Nordic Water Products AB. Used with permission

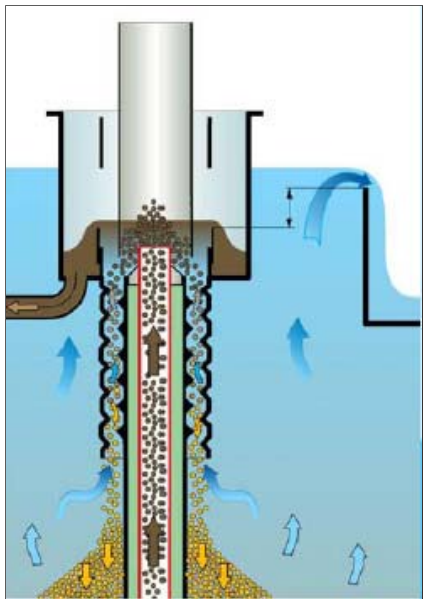

Figure 6-9. Close-up of continuous backwash upflow sand (CBUS) filter.
Source: Feldthusen 2004. © Nordic Water Products AB. Used with permission

Performance of denitrifying filters depends on many factors including:

- Influent weir configuration (needs to reduce DO, which can inhibit denitrification at concentrations as low as 0.2 mg/L)
- Filter media
- Underdrain system
- Backwash system
- Flow and methanol feed control to avoid increased BOD in the plant effluent

Operators at a wastewater system in Connecticut reported that key issues for them were influent piping design to minimize aeration, maintaining a consistent flow to the filters, and control of methanol feed based on influent chemical oxygen demand (COD) (Pearson et al. 2008).

6.3 Phosphorus Removal Technologies

WWTPs remove phosphorus by chemical or biological methods. A combination of these methods (e.g., biological phosphorus removal and chemical polishing) can be used to achieve very low effluent TP levels at minimal costs. Table 6-3 lists the chemical and biological methods for phosphorus removal. A discussion of each technology follows the table.

Table 6-3. Matrix of Phosphorus Removal Technologies¹

Configuration	Type	Technology	Section Reference
Chemical Precipitation Followed by Solids Separation	Pre-, co-, or post-precipitation	Addition of lime or metal salt at one or multiple locations within the plant to react with phosphorus to form precipitate. Solids can be removed through conventional clarification or advanced solids separation processes. Tertiary filtration can remove additional solids and produce effluent with very low TP concentrations. (See Section 6.5 for discussion of tertiary filtration.)	6.3.1
Biological	Suspended growth	Anaerobic/Oxic (A/O), i.e. Phoredox	6.3.2.1
		Oxidation Ditch with Anaerobic Zone	6.3.2.2

1. These technologies are for phosphorus removal only. Technologies for removal of both nitrogen and phosphorus are presented in Table 6-4 and discussed in Section 6.4.

6.3.1 Phosphorus Removal by Chemical Addition

Chemical precipitation for phosphorus removal is a reliable, time-tested wastewater treatment method that has not drastically changed over the years. To achieve removal, various chemicals are

added to wastewater where they react with soluble phosphates to form precipitates. The precipitates are removed using a solids separation process, most commonly settling (clarification). Chemical precipitation is typically accomplished using either lime or a metal salt such as aluminum sulfate (alum) or ferric chloride. The addition of polymers and other substances can further enhance floc formation and solids settling. Operators can use existing secondary clarifiers or retrofit primary clarifiers for their specific purposes. See Chapter 3 for a detailed discussion on the principles of phosphorus removal by chemical addition.

The effectiveness of phosphorus removal by chemical addition is highly dependent on the solids separation process following chemical precipitation. The direct addition of metal salts to activated sludge processes followed by conventional clarification can typically remove TP to effluent levels between 0.5 and 1.0 mg/L (Bott et al. 2007). Tertiary processes (post-secondary treatment) can be used to remove phosphorus to very low concentrations. For example, Reardon (2005) reports that four WWTPs with tertiary clarifiers achieved TP levels of between 0.032 and 0.62 mg/L.

Two common tertiary processes are clarification and effluent filtration. These approaches can be used separately or in combination. Section 6.5 describes effluent filtration technologies. Conventional clarification and recent advances in tertiary clarification processes are discussed below.

Conventional Clarification

Conventional gravity clarifiers can be used very effectively for the tertiary removal of phosphorus precipitates. Their performance can be enhanced by the addition of synthetic polymers following precipitation to aid flocculation and sedimentation. The precipitating chemical typically would be added to the flow upstream of the clarifier, and polymer commonly would be added at the center well of the clarifier. This technology following simultaneous precipitation and clarification in the activated sludge process was used to obtain effluent TP concentrations of less than 0.18 mg/L (monthly average) at the Fairfax County, VA, Lower Potomac WWTP and the Arlington County, VA, WWTP for more than two decades. The tertiary clarifiers were followed by sand filtration.

Lime clarification, although not commonly used today, is a viable treatment option for tertiary removal of phosphorus (WEF 2005). Most existing plants use a two-step process whereby excess lime is added to the first stage to raise the pH to between 11 and 12. The effluent is passed to a second stage where carbon dioxide and possibly soda ash is added to stabilize the pH to between 9.5 and 10.5 and to precipitate additional calcium (re-carbonation). Sand filtration is used after re-carbonation. This technology has been used at the Upper Occoquan Sewage Authority Advanced Wastewater Treatment Plant, Fairfax County, VA, since 1978 to achieve effluent TP concentrations of less than 0.1 mg/L (weekly average).

Conventional clarification has been used for many years and design and operation is well covered in other manuals such as the WEF manual of practice for design of municipals WWTPs (WEF and ASCE 2010) and the WEF Clarifier Design Manual (WEF 2005).

High-Rate Tertiary Clarification Processes

Two types of high-rate clarification processes are common: dense sludge and ballasted high-rate clarification (BHRC). The latter has been used successfully to achieve low effluent phosphorus concentrations (WEF 2005). Several patented BHRC technologies using different types of ballast, such as

recycled sludge, microsand, and magnetic ballast (USEPA 2008a), have been developed in recent years. The advantages of high rate clarification are that the clarifiers have a smaller footprint and are able to treat larger quantities of wastewater in a shorter period of time. The following patented processes are examples of high rate clarification (including performance estimates):

- DensaDeg® uses a coagulant in a rapid mix basin to destabilize suspended solids. The water flows into a second tank where polymer (for aiding flocculation) and sludge are added. The sludge acts as the “seed” for formation of high density floc. This floc is removed in settling tubes (USEPA, 2008). The main advantages of this process are a smaller footprint and denser sludge, which is easier to dewater. Pilot testing for the City of Fort Worth, TX found a phosphorus removal rate of 88-95 percent for DensaDeg® (USEPA 2003). See Figure 6-10 for the process configuration for this technology.

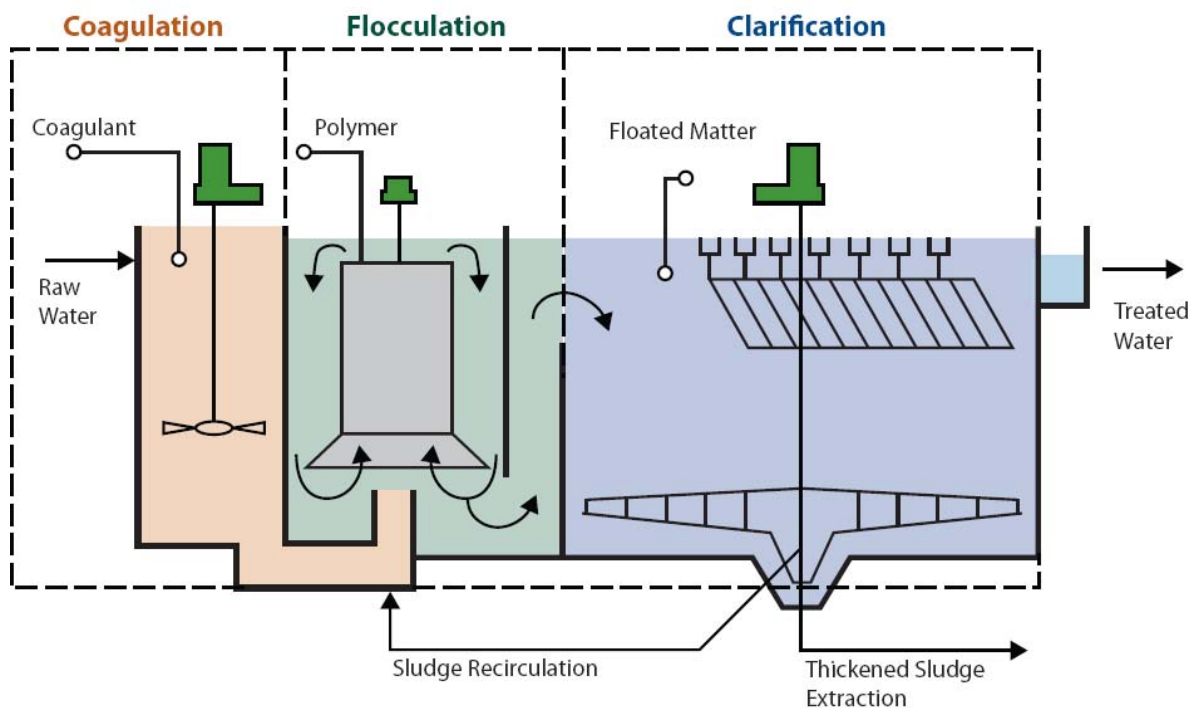

Figure 6-10. DensaDeg® high rate clarification process flow diagram.
Source: USEPA 2008a

- Actiflo® uses a coagulant in a rapid mix basin to destabilize suspended solids. The water flows to a second tank where polymer (for aiding flocculation) and microsand are added. Microsand provides a large surface onto which suspended solids attach, creating a dense floc that settles out quickly. Clarification is assisted by lamella plate settling. Product pilot testing in Fort Worth, TX showed a phosphorus removal efficiency of 92-96 percent for Actiflo® (USEPA 2003).
- The CoMag™ process uses the addition of high density magnetite ballast with metal salts and polymer to promote floc formation and high rate settling. Settling is followed by magnetic separation for final effluent polishing and recovery of the magnetite ballast from the tertiary sludge, utilizing its strong natural attraction to magnetic fields (USEPA 2008a).

Since November 2007, CoMag™ has been in operation at a 1.2 million gallon per day (MGD) WWTP in Concord, MA (EPA Region 10 2007; Proakis Ellis and Cathcart 2008). Shortly after startup, the system reached 0.05 mg/L TP in the plant effluent on an average daily basis and has performed to this level consistently under a wide range of influent loading conditions. Proakis Ellis and Cathcart (2008) report many operational advantages of CoMag™ including reduced chemical usage and less sludge production compared to using alum alone for secondary treatment. The final polishing electromagnet in Concord requires relatively high power usage; however, newer installations of the CoMag™ system are being designed with final polishing magnets that do not require any power usage. See Figure 6-11 for the process configuration for this technology.

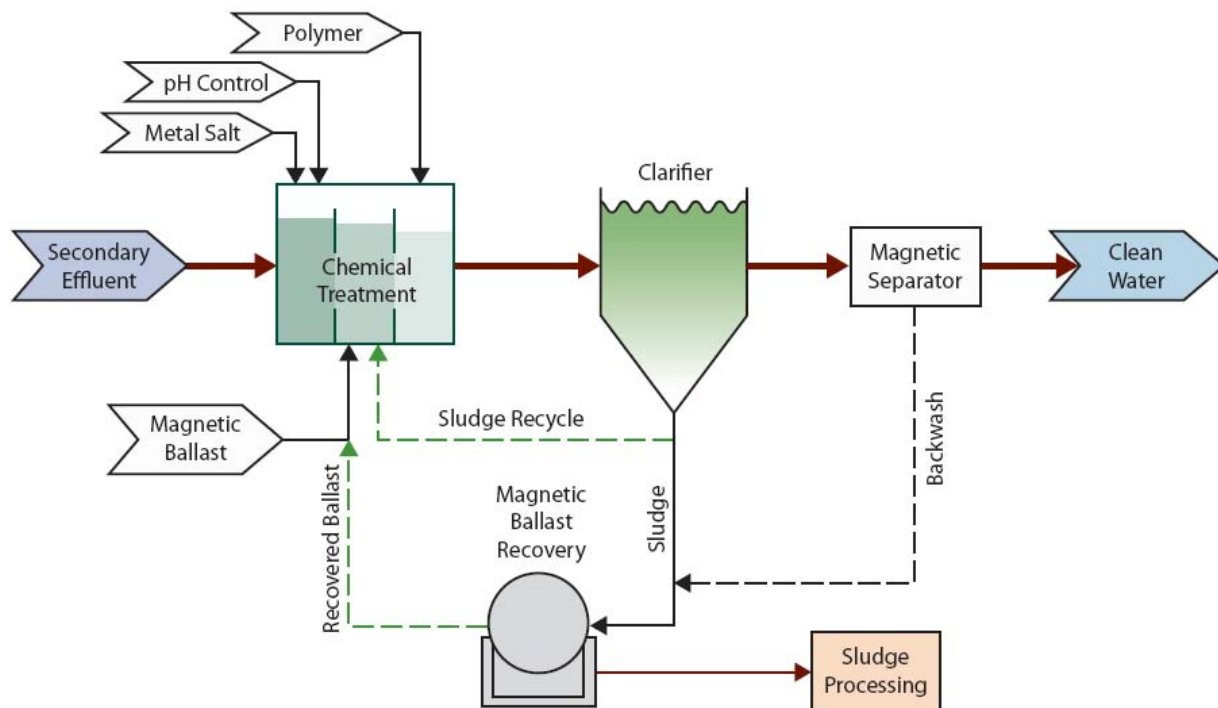

Figure 6-11. CoMag™ process flow diagram.
Source: USEPA 2008a

6.3.2 Biological Phosphorus Removal

Biological phosphorus removal (BPR) is accomplished by encouraging the growth of phosphate accumulating organisms (PAOs). Under anaerobic conditions, PAOs uptake and store simple carbon food sources such as volatile fatty acids (VFAs) using the energy in phosphate bonds, and release phosphorus to solution. When the PAOs are subject to aerobic conditions, they metabolize the stored carbon to generate energy for cell growth and maintenance and store excess energy by taking up phosphate ions and creating polyphosphates. The phosphorus uptake by PAOs in the aerobic zone results in a net reduction in phosphorus in the wastewater when sludge is wasted.

The success of biological phosphorus removal is highly dependent on the availability of VFAs in the anaerobic zone. VFAs are produced by fermentation of municipal wastewater, which can occur in the collection system or in the anaerobic zone itself. If sufficient VFAs are not present, plant operators can consider adding VFAs by using onsite sludge fermentation or by adding a commercial source. See Chapter 5 for additional information on the principles of BPR.

All biological phosphorus removal technologies are designed to cycle treatment from anaerobic to aerobic conditions to encourage PAOs to grow and uptake phosphorus. This section describes two technologies that have been designed to biologically remove phosphorus only (not nitrogen) from wastewater. Most technologies have been designed to remove both nitrogen and phosphorus and are presented in Section 6.4.

As noted in Chapter 5, nitrate in the recycle stream can inhibit BPR. This can be a problem for plants that nitrify but do not denitrify. In these cases, nitrification needs to be eliminated or greatly reduced to biologically remove phosphorus unless the readily biodegradable COD (rbCOD) in the influent is very high, which it typically will not be for municipal and domestic wastewaters. Operating at an SRT less than 4 days will usually washout nitrifiers at temperatures less than 25 °C. Note that most WWTPs in the Eastern USA have effluent ammonia limits, which means that operating without nitrification is frequently not possible. Once a plant is practicing nitrification, there are additional advantages to also practicing denitrification for TN removal (see Section 6.8).

6.3.2.1 Pho-redox (A/O)

The Pho-redox (A/O) process is a conventional activated sludge system with an anaerobic zone at the head of the aeration basin. The RAS is pumped from the clarifier to the anaerobic zone. It is a low SRT process that is operated to avoid nitrification. With no nitrates in the RAS, the process is reliable and easy to operate except at mixed liquor temperatures in excess of 25°C when nitrification is difficult to avoid. If nitrates are present in the recycle stream, the anaerobic zone can be split into an anoxic chamber for nitrate denitrification and one or more anaerobic zones for biological phosphorus removal. Figure 6-12 provides a schematic for this system.

The technology is relatively easy to retrofit into an existing basin by installing a baffle wall and mixers to produce an anaerobic zone. The aerators will need to be redistributed in the aerobic zone, with closer spacing in the influent end of the zone.

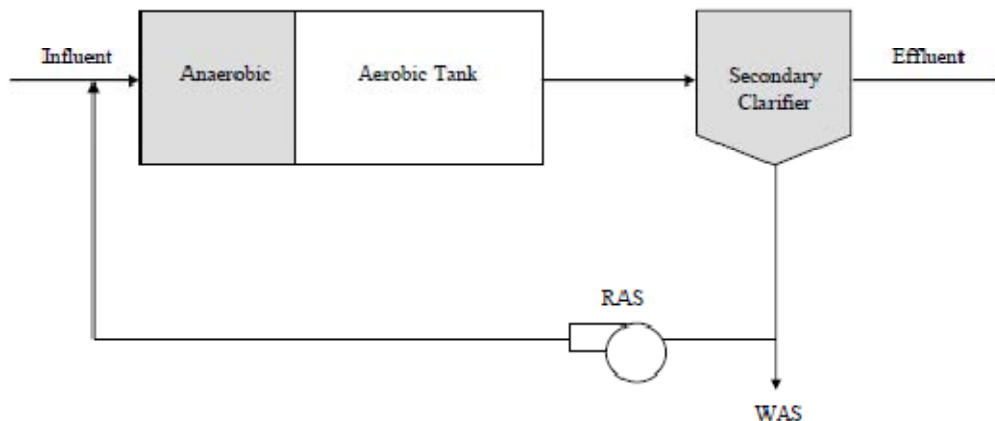

Figure 6-12. Pho-redox process (A/O)
 Source: USEPA 2008b, Figure 2-15

6.3.2.2 Oxidation Ditch with Anaerobic Zone

Similar in design to the oxidation ditches for nitrogen removal discussed previously, oxidation ditches for phosphorus removal are a modification of the standard design with the requirement that an anaerobic zone be established. The anaerobic zone is most often ahead of the ditch (sometimes called a “selector”) or it can be within the ditch if the DO balance is carefully managed, but filamentous organisms will tend to grow. See Figure 6-13 for an example of an oxidation ditch with an anaerobic basin (also called a “selector”).

Oxidation ditches with phosphorus removal but not nitrogen removal may encounter problems with low alkalinity because nitrification will deplete alkalinity but denitrification in an anoxic zone is not present to partially replenish it. Lower TP effluent levels can be achieved by close monitoring and control of DO and flow in the anaerobic zone. The footprint size for this process is potentially large compared to other technologies. It does not require any additional recycle pipes or pumping and needs minimal energy to operate.

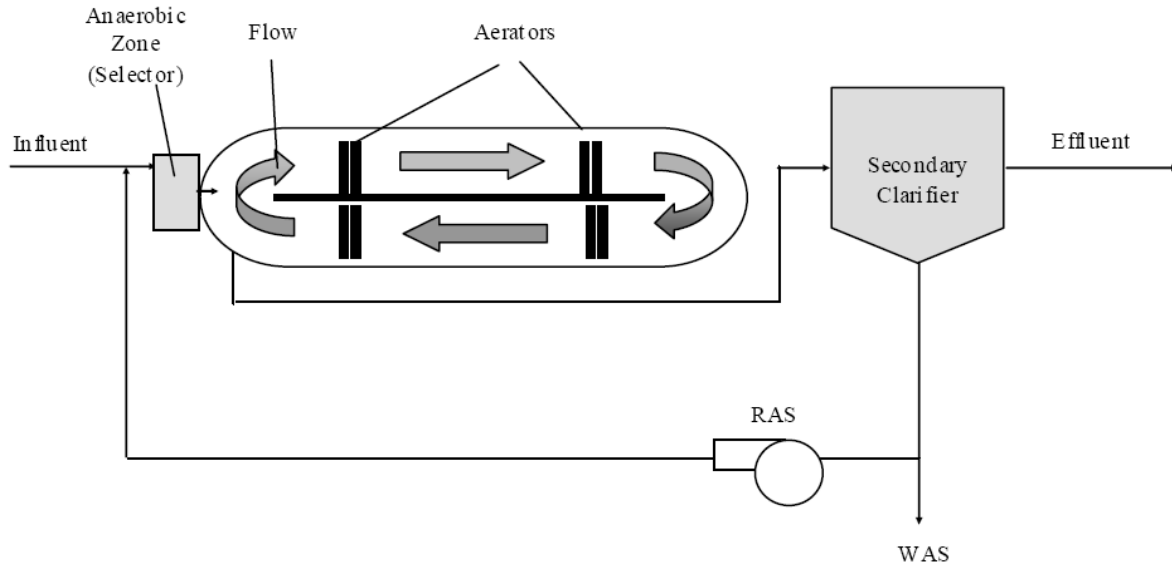

Figure 6-13. Oxidation ditch with anaerobic zone.
 Source: USEPA (2008b), Figure 2-16

6.4 Combined Nitrogen and Phosphorus Removal Technologies

Table 6-4 presents the technologies capable of simultaneously achieving both nitrogen and phosphorus removal. A discussion of each technology follows the table.

Table 6-4. Matrix of Combined Biological Phosphorus and Nitrogen Removal Technologies

Configuration	Type	Technology	Section Reference
Biological	Suspended growth	3 Stage Pho-redox (A2/O)	6.4.1.1
		5-Stage Bardenpho	6.4.1.2
		University of Capetown (UCT), Modified UCT, and Virginia Initiative Project (VIP)	6.4.1.3
		Westbank Configuration	6.4.1.4
		Oxidation Ditch with Anoxic and Anaerobic Zone	6.4.1.5
		Sequencing Batch Reactor (SBR)	6.4.1.6
Hybrid Chemical / Biological		Blue Plains Process	6.4.2.1
		Biological Chemical Phosphorus and Nitrogen Removal (BCFS)	6.4.2.2

6.4.1 Biological

6.4.1.1 3 Stage Pho-redox (A2/O)

The 3 Stage Pho-redox (A2/O) process adds an anoxic zone to the A/O process configuration after the anaerobic zone to achieve denitrification. In addition, nitrate-rich liquor is recycled from the

end of the aerobic zone to the head of the anoxic zone to enhance denitrification, as shown in Figure 6-14. A shortcoming of the 3 Stage Pho-redox process is that there will be nitrates present in the RAS, potentially making the phosphorus removal process unreliable. With A2/O, as with all combined nitrogen-phosphorus biological systems, some phosphorus is taken up in the anoxic zone by the PAOs, and the sludge residence time in each zone must be sufficient to allow complete phosphate release or uptake. The clarifier also must be operated to regularly waste solids to avoid release of phosphate by the endogenous respiration of PAOs.

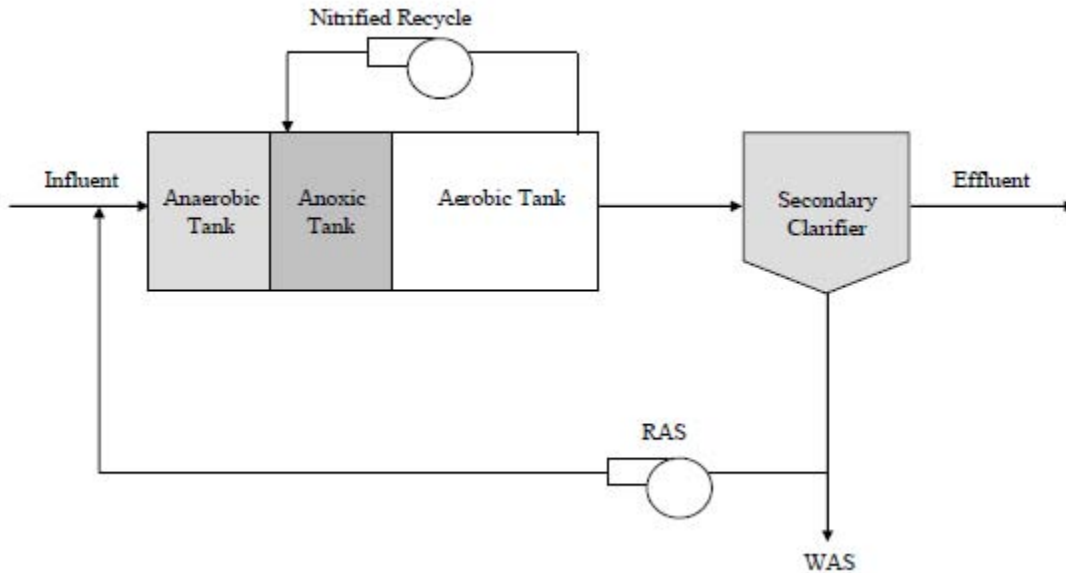

Figure 6-14. 3 Stage Pho-redox process (A2/O).
Source: USEPA 2008b, Figure 2-22

6.4.1.2 5-Stage Bardenpho

The 5-stage Bardenpho process consists of the 4-stage process (see 6.2.1.2) with an anaerobic zone added to the front of the system (see Figure 6-15). A nitrate-rich liquor is recycled from the first aerobic stage to the first anoxic zone. The RAS is recycled from the clarifier to the beginning of the anaerobic zone. Since the nitrates in the RAS are typically low (from 1 to 3 mg/L), they do not have the potential to significantly interfere with the phosphorus removal process as with the A2/O configuration (see 6.4.1.1). Methanol might need to be added to the second anoxic zone for complete denitrification or to minimize the volume of the second anoxic zone.

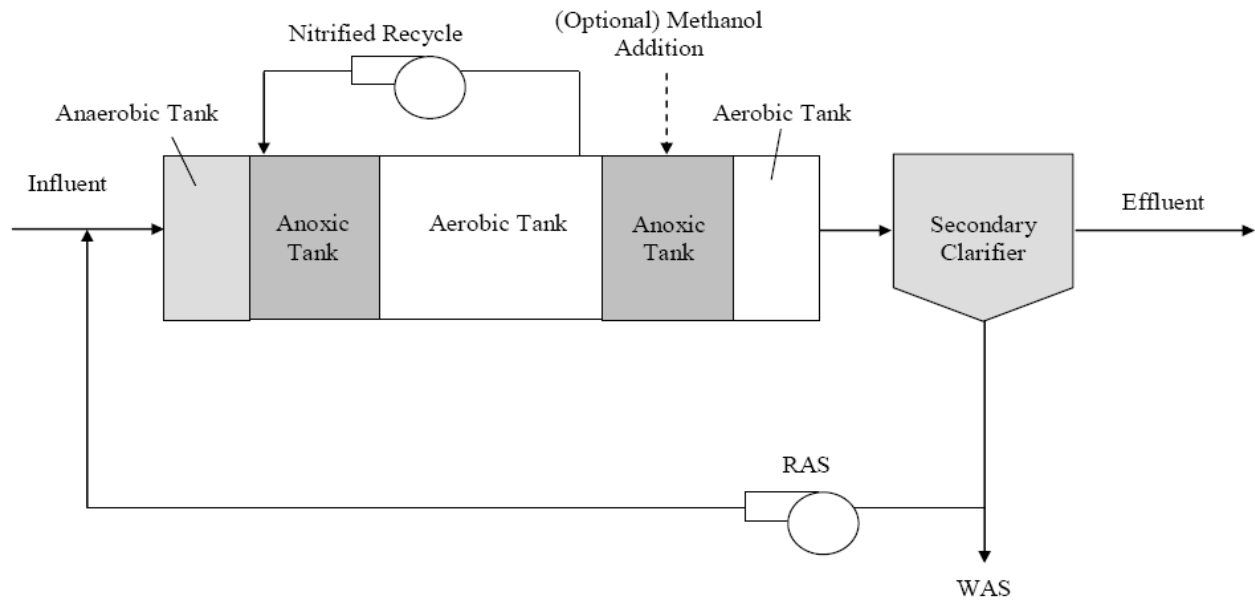

Figure 6-15. 5-stage Bardenpho process. Note that alternative external carbon sources can be used instead of methanol
Source: USEPA (2008b), Figure 2-23

6.4.1.3 University of Capetown (UCT), Modified UCT, and Virginia Initiative Plant (VIP)

The UCT process was designed to reduce nitrates to the anaerobic zone when high removal of nitrates in the effluent is not required. Similar to other nitrogen and phosphorus removal technologies, it consists of three stages: an anaerobic stage, an anoxic stage, and an aerobic stage. The RAS is returned from the clarifier to the anoxic zone instead of the anaerobic zone to allow for denitrification and to avoid interference from nitrate with the activation of the PAOs in the anaerobic stage. A nitrate rich stream is recycled from the aerobic zone to the anoxic zone influent. Denitrified mixed liquor is recycled from the anoxic zone effluent to the anaerobic zone.

The modified UCT process splits the anoxic zone into two stages. The nitrate rich recycle from the aerobic zone is recycled to the head of the second anoxic stage. The distinction between the modified and the UCT processes is seen in Figure 6-16. The nitrate containing RAS is recycled to the first anoxic stage where it is denitrified. Next, the denitrified RAS is recycled from the end of the first anoxic stage back to the head of the anaerobic stage and mixed with the incoming wastewater.

The Virginia Initiative Plant (VIP) is similar to the UCT process, but the anaerobic and anoxic zones are baffled into two or more sections each to increase rates of reaction in the first section of each zone, thereby firmly establishing the desired anaerobic and anoxic conditions in the second section.

These configurations have a medium-sized footprint and, in some cases, can be installed in existing basins. They require extensive pumping, piping, and control for the multiple recycle streams. However, internal recycles can be inexpensively installed when retrofitting most activated sludge basins by using low-head pumps, such as propeller pumps, and piping along one internal wall of the basin.

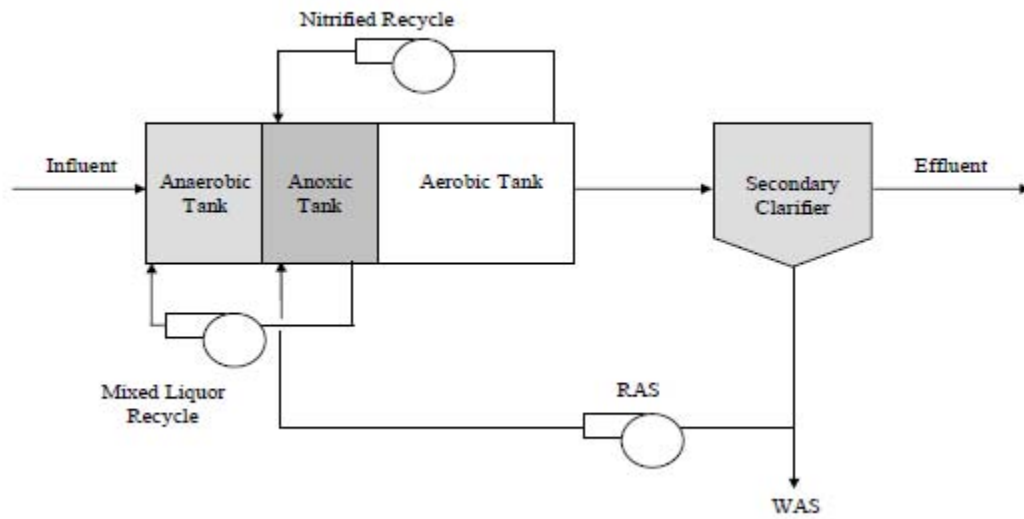

UCT Process

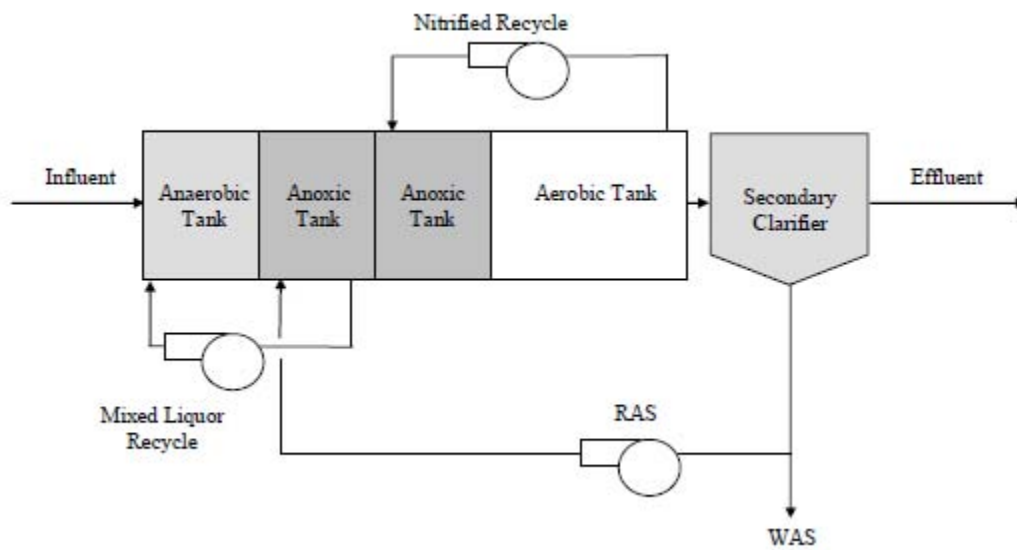

Modified UCT Process

Figure 6-16. UCT and Modified UCT process.
Source: USEPA 2008b, Figures 2-24 and 2-25

6.4.1.4 Westbank

The Westbank process, shown in Figure 6-17, has a small, pre-anoxic zone followed by an anaerobic zone, a second anoxic zone, and lastly, a large aerobic zone. The pre-anoxic zone minimizes DO and nitrates entering the anaerobic portion. Primary effluent is divided among the pre-anoxic zone (to denitrify the RAS), the anaerobic zone (to provide some VFAs for phosphorus removal), and the second anoxic zone (to stimulate denitrification). Direct feed of primary effluent to the second anoxic zone increases the denitrification rate and therefore decreases the size of the anoxic zone compared to the 5-stage Bardenpho system. During storm flows, excess flow is passed directly to the main anoxic zone. VFAs obtained from fermentation of the primary sludge are passed to the anaerobic zone.

Additional piping is required to discharge the influent to multiple zones; however, recycle streams are reduced compared to similar layouts. The fermenter requires additional pumping, piping, and controls for optimum fermentation and feeding of the VFAs to the anaerobic zone. The design has a medium-sized footprint.

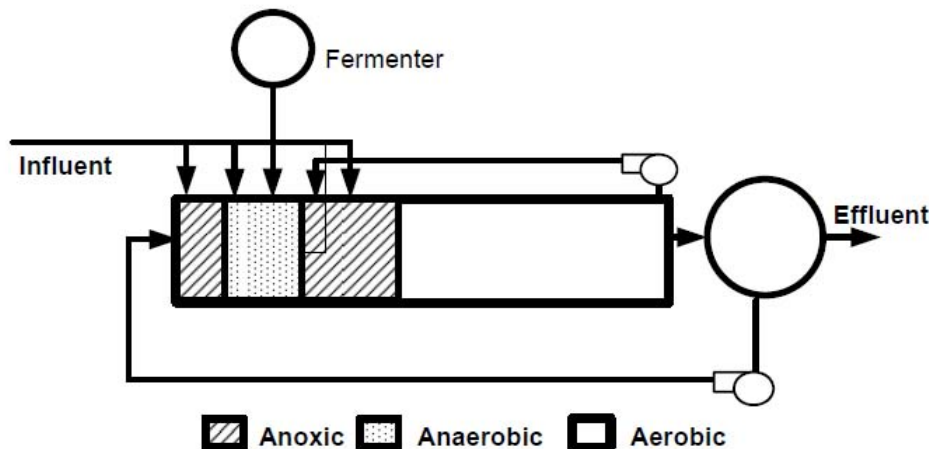

Figure 6-17. Westbank process.

6.4.1.5 Oxidation Ditch with Anoxic and Anaerobic Zones

Section 6.2.1.5 described oxidation ditches that are biologically configured to remove nitrogen. Any of these configurations can be modified with an anaerobic basin (also called a “selector”) before the ditch to accomplish BPR in a combined system. Because of the very high internal recycle within the ditch, very low nitrate concentrations can be achieved in the mixed liquor before settling, which minimizes nitrate in the RAS stream to the anaerobic selector zone, improving BPR process efficiency.

Many oxidation ditch configurations have been developed to simultaneously achieve biological nitrogen and phosphorus removal to low levels. An example is the VT2 process developed at Bowie, MD, which operates two Pasveer ditches in series with dedicated anoxic, near anaerobic, and aerobic zones (See Figure 6-18). It also has a sidestream anaerobic zone that receives approximately 30 percent of the influent to enhance BPR. Denitrified MLSS for the anaerobic zone are obtained from the end of

the near anaerobic zone of the adjacent ditch. Operated without primary sedimentation, the system consistently achieved very low annual average effluent TP concentrations (0.16 – 0.24 mg/L) without chemical addition or effluent filtration for more than 20 years. Originally designed for only one ditch, both ditches had to be operated in series because the plant has limited clarification capacity. Series operation of both ditches resulted in lower MLSS concentrations to the clarifiers. The Bardenpho process uses pairs of ditches that operate in alternating anoxic-aerobic modes. An anaerobic tank with RAS returned to it is placed before the ditches to stimulate BPR, and the ditches are alternated between aerobic and anoxic conditions for nitrification and denitrification. The Orbal process uses anaerobic and anoxic zones in the outer of three concentric oval-shaped ditches with RAS recycled from the clarifier to the anoxic zone to remove both nitrogen and phosphorus.

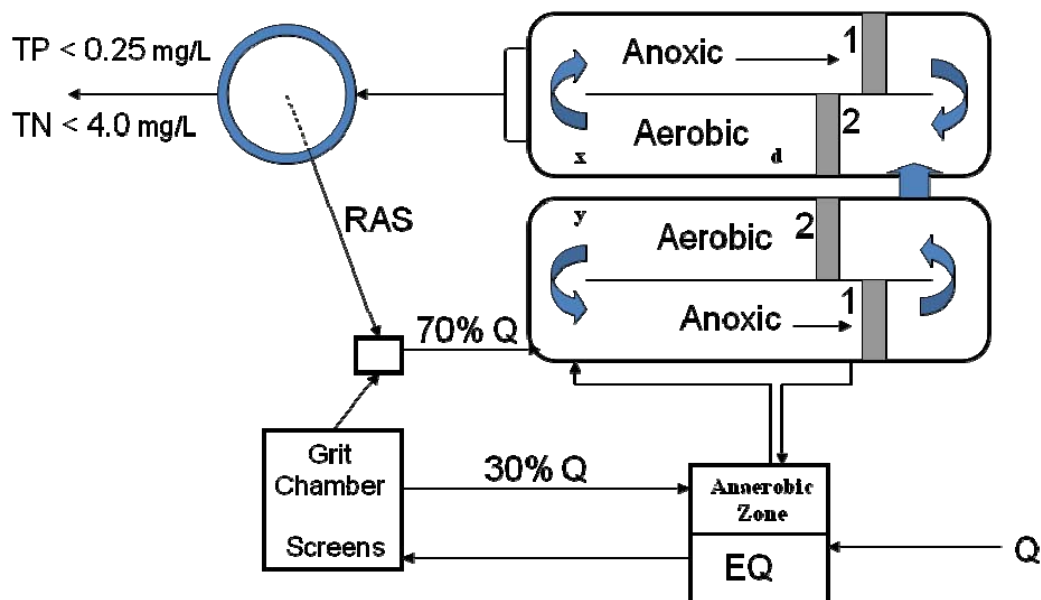

The Modified BNR WWTP Operated at Bowie, Maryland, 1988-2008

Figure 6-18. VT2 process schematic.

6.4.1.6 Sequencing Batch Reactor (SBR)

SBRs can be operated to accomplish both biological phosphorus and nitrogen removal by progressing through anoxic/anaerobic/aerobic phases. Because of the fill-and-draw nature of SBRs, it is necessary to remove the nitrates remaining from the previous cycle before anaerobic conditions can be established; thus, the typical treatment progression becomes anoxic/anaerobic/aerobic. Additional carbon may be needed. See Section 6.2.1.4 for additional discussion of SBRs.

6.4.2 Hybrid Chemical / Biological

Configurations that use some form of biological treatment for nitrogen removal and possibly phosphorus removal combined with chemical precipitation and advanced solids removal for phosphorus are popular and typically reliable treatment options for achieving low effluent concentrations. Many different combinations of the technologies discussed previously can be used. This section presents two

examples: The Blue Plains Process and the Biological-Chemical Phosphorus and Nitrogen Removal (BCFS) Process.

6.4.2.1 Blue Plains Process

The Blue Plains process was a retrofit to the existing nitrification activated-sludge process at the Washington, DC, facility. A new anoxic zone with an HRT of 0.8 hours was created inside the aeration tank from the nominal 3.3 hours HRT of the total basin (see Figure 6-19). The design sludge age was 13 days. The existing return activated-sludge system remained unchanged in this retrofit. Methanol is fed directly into this new anoxic zone for a target nitrogen concentration of 7.5 mg/L (Kang et al. 1992; Sadick et al. 1998). Phosphorus is removed by ferric chloride addition and tertiary filtration (USEPA 2008b).

The effluent concentrations (post tertiary filter) found in the literature for the Blue Plains process were 7.5 mg/L for TN and 0.12 mg/L for TP on a monthly average basis (USEPA 2008a). However, that was when only half of the plant was modified for nitrogen removal. When the entire plant was modified, the effluent TN was less than 5 mg/L (monthly average).

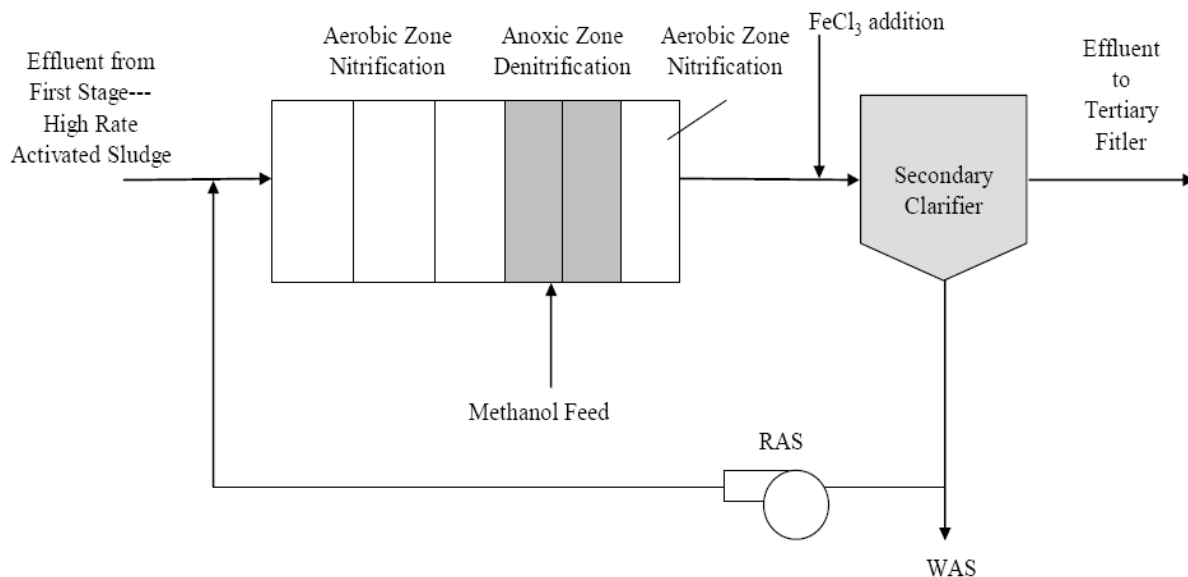

Figure 6-19. The Blue Plains Process.
Source: USEPA (2008b), Figure 2-29

6.4.2.2 Biological-Chemical Phosphorus and Nitrogen Removal (BCFS) Process

The Biological-Chemical Phosphorus and Nitrogen Removal (BCFS) process was developed for the WWTP in Holton, the Netherlands, to achieve low TN and TP effluent concentrations at a relatively low BOD:TP and BOD:TN influent ratio. The design is similar to the modified UCT process. A sludge stream is removed from the anaerobic zone for thickening, and ferric chloride is added to the sludge

thickener to remove phosphate. This provides an advantage over chemical addition to the secondary clarifier because it does not require the chemical sludge to be recycled. Additional information can be found on the website of the Dutch Foundation for Applied Water Research (STOWA), <http://www.stowa-selectedtechnologies.nl/> (see Fact Sheets).

6.5 Effluent Filtration

Many varieties of filters can be used in WWTPs. Media range from mono-media such as sand to multimedia such as sand with anthracite and high density gravel. Other media such as cloth or membranes (operated under pressure) can be used to capture solids. Filters can be operated in upflow or downflow mode and can be backwashed using a variety of techniques. Design of multiple filters in series or filters preceded by a tertiary clarifier can improve solids (and thereby total phosphorus) removal. Table 6-5 lists some major filtration technologies. A description of each follows the table.

Table 6-5. Matrix of Tertiary Filtration Technologies

Configuration	Technology	Section Reference
Tertiary Filtration	Gravity (down-flow) Filters – Conventional – Deep Bed	6.5.1
	Continuous Backwash Upflow Sand Filters	6.5.2
	Pulsed Bed Filters	6.5.3
	Travelling Bridge Filters	6.5.4
	Discfilters (including cloth media)	6.5.5
	Membrane Filtration	6.5.6

6.5.1 Conventional Down-flow Filters

These filters consist of fixed-media beds that are typically up to 3 feet in depth and are similar to filters used to treat drinking water. Media can be single media, dual media, or multi-media. Single media is typically sand or anthracite. Dual media combines anthracite and sand. Multi-media filters include a layer of garnet or ilmenite. Differences in specific gravity make it possible to have the largest particles (anthracite) in the top layer of the filter and the smaller ones (garnet) in the bottom layer. Flow in these filters is by gravity from the top down. Most of the removal occurs in the top few inches of the media, but multi-media filters use more of the bed depth for active filtration than mono- or dual media filters. The filter must be taken off-line periodically to backwash it to prevent clogging and excessive pressure loss.

Deep bed filters are similar to conventional down-flow filters but have deeper beds and larger media size. Therefore they have the advantage of longer run times between backwashes. The size of the media is limited by the ability to backwash the filter. Because these filters are more difficult to backwash, air scour is necessary to fully clean the filter bed.

6.5.2 Continuous Backwashing Upflow Sand Filters

During operation of the continuous backwashing upflow filter, water is introduced through risers at the bottom of a deep sand bed. Water flows upward through the sand bed and over an

overflow weir. Sand and trapped solids flow downward through the filter and are drawn into the suction of an airlift pipe in the center of the filter. As the sand travels up the airlift pipe, the air scours the particles and separates the sand from filtered solids. At the top of the airlift pipe, the clean sand settles back onto the top of the filter and the solids are carried away into a reject line. See Figures 6.8 and 6.9 in Section 6.2.3.1 for cut away diagrams of a continuous backwashing upflow filter.

These filters have the advantages of no moving parts other than the air compressor and less energy and maintenance requirements than traditionally backwashed filters. They are sometimes referred to by the trade name Dynasand.

A modification of the standard continuous backwashing upflow filter media is use of sand coated with hydrous ferric oxide. Ferric oxide coated media provides adsorption in addition to filtration. One example is the Blue PRO™ system where ferric salt is added prior to the filter to aid in coagulation and to replace the ferric coating, which is abraded from the sand. Turbulence from the compressed air knocks accumulated iron and phosphorus along with any solids off the particle as the sand travels upward. The iron, phosphorus, and particles are wasted, while the clean sand is deposited on the top of the bed. Benish et al. (2006) report that “an average effluent TP of 0.06 mg/L was observed during a pilot study in Moscow, Idaho, and near 0.02 mg/L was achieved in a pilot study in Coeur d’Alene, Idaho.” EPA Region 10 (2007) summarized results of demonstration of the Blue PRO™ system at a 0.25 MGD Hayden Wastewater Research Facility. Secondary effluent with a total phosphorus concentration of between 1 and 4 mg/L was treated through a two-single-pass Blue PRO™ filtration system. The average effluent concentration for the entire test period (2005 to 2007) was 0.014 mg/L.

6.5.3 Pulsed Bed Filters

Pulsed bed filters are shallow filters with an unstratified fine sand media. An air pulse disturbs the media and allows penetration of solids into the media bed, allowing the entire filter bed to be used for removal of solids. The pulse is designed to expand the filter operation and reduce the number of backwash cycles, although the filter must still be periodically backwashed to remove the solids.

6.5.4 Traveling-Bridge Filters

Traveling-bridge filters consist of long shallow beds of granular media divided into cells. Wastewater is applied to the top of the media and flows downward. Each cell is individually backwashed by a traveling bridge while the other cells continue to operate. The bridge uses filtered water to backwash the filters. This type of filter is used for the removal of effluent TSS, which can enhance nutrient removal because TSS contain both nitrogen and phosphorus. Effluent TSS is usually between 5 and 10 mg/L, which is not suitable for enhancing phosphorus removal below 0.5 mg/L.

6.5.5 Discfilters

Discfilters are a series of parallel mounted disks used to support a cloth filter media. Water enters a central tube and flows out between the two layers of cloth in each disk. The disks rotate and are normally 60 to 70 percent submerged. The portion above the water is backwashed using spray nozzles.

The cloth media disk filter is similar to the discfilter described above. In this case, the water flows from the outside of the submerged cloth disks and into a center pipe. Disks continue to rotate during backwash, as water is pulled through the media from the disc using suction heads.

Discfilters and cloth media disk filters have limited solids loading capacities and are thus most often used for BNR applications rather than following chemical addition for phosphorus removal.

6.5.6 Membrane Filters

Membrane systems use a pressure head to drive water through a permeable membrane. Membrane filters are typically classified by their pore size, which in turn determines the size of the particles they exclude and guides the pressure requirements. Microfiltration, ultrafiltration, nanofiltration, and reverse osmosis (RO) membranes remove increasingly smaller particles. Biological treatment that includes microfiltration and ultrafiltration typically remove 3 to 6 logs of bacteria and 95 percent or more BOD, along with most particles (WEF 2006). Nanofiltration removes nearly all particles, including some viruses. RO removes all particles as well as most large dissolved constituents, and is capable of producing pure water. Typically, the water must be pre-treated before using RO membranes. Pre-treatment could be conventional filters, cartridge filters, or larger pore membrane filters. The energy cost for applying the pressure head and the need to replace membranes make membrane filtration a more expensive technology. It can achieve very low concentrations of nutrients and other contaminants, however, and is common in water re-use projects.

Membranes can be configured a number of ways including hollow fiber, spiral wound, plate and frame, cartridge, or in pressure vessels. Membranes can foul from organics, biological growth, or metals in the wastewater. Disinfection may be required to prevent biological fouling.

6.6 Sidestream Management

Solids handling processes result in a liquid sidestream that is generally recycled to the head of the treatment plant and combined with the influent wastewater. The concentration of nitrogen and phosphorus in the sidestream depends on the influent concentrations and the main stream removal technology. It also depends highly on the solids treatment technology and equipment, with the highest nutrient concentration resulting from anaerobically digested or thermally conditioned sludge (WEF and ASCE 2006). As will be discussed in Chapter 10, characterizing sidestreams (e.g., nutrient loadings and when they are discharged) is very important when designing for nutrient removal, particularly for plants wanting to consistently achieve low effluent concentrations.

Equalization of sidestreams is a proven management technique to reduce the impact of the sidestreams on the main treatment train. An equalization tank can be sized to hold the total volume of recycle flows for a certain period of time so that they can be sent to the treatment system at selected rates or times to minimize the impact on the treatment process (e.g., at night when total plant flows and nutrient loadings are low). An equalization tank can also be designed to settle and remove solids to reduce the loads back to the plant, but the settled solids have to be collected and processed. Aeration within the tank or as a separate process has also been shown to reduce the ammonia load back to the plant by up to 50 percent given that detention time is sufficient and the tank can be fully mixed (WEF and ASCE 2006).

Over the last several years, patented processes have been designed to remove nitrogen from recycle streams. The following examples are discussed in this section, but note that this is not a complete list and new processes are continually being developed:

- Bioaugmentation (e.g., InNitri® or BABE®)
- BAR
- MAUREEN
- SHARON®
- ANAMMOX®
- DEMON®
- CANON
- OLAND

InNitri® and BABE® use bio-augmentation (i.e., the seeding of nitrifiers) to enhance nutrient removal. InNitri® (Inexpensive Nitrification) grows nitrifiers in a small, sidestream aeration-clarifier system by treating high ammonia, high temperature water from digestion and dewatering to obtain complete nitrification of the ammonia. The waste activated sludge (WAS) from the sidestream system is discharged to the main aeration tank to supplement the nitrifiers in that reactor, thereby reducing the SRT needed to maintain nitrification at low temperatures. InNitri® does not remove nitrogen but reduces the volume needed in the main stream reactor to accomplish nitrification.

The BABE® (BioAugmentation Batch Enhanced) process uses a single batch reactor to treat a mixture of high ammonia sidestreams from dewatering, RAS from the main biological treatment system, and residual biomass remaining in the reactor from the preceding cycle. The high ammonia concentration is completely nitrified and then partially denitrified during each cycle of the batch reactor to obtain removal of nitrogen. The RAS is partially seeded with nitrifiers and denitrifiers by the BABE

process during this operation. The BABE process is designed to operate between 20 and 25° C, and temperatures below 20° C will dramatically increase the reactor volume needed.

The Bio-Augmentation Regeneration/Reaeration (BAR) process was developed in the United States and is identical to the Regeneration-DeNitrification (R-DN) process developed independently in the Czech Republic. It works by recycling ammonia-laden filtrate or centrate from dewatering of aerobically digested sludge to the head of the aeration tank. The sidestream is fully nitrified which seeds the aeration tank with additional nitrifying bacteria and allows for reduced SRT. There are numerous full scale applications in the Czech Republic, United States, and Canada.

The Mainstream AUtotrophic Recycle Enabling Enhanced N-removal (MAUREEN) Process was developed for the two-sludge treatment configuration at the Blue Plains Advanced Wastewater Treatment Plant in Washington, DC. The process involves recycling of WAS from the nitrification stage to a reactor where the AOBs are used to oxidize the centrate ammonia to nitrite. Then the nitrite is reduced to nitrogen gas, and the AOBs are sent to the high-rate carbon removal stage for bioaugmentation of the first sludge stage activated sludge to accomplish some nitrification in that stage.

The SHARON® (Single reactor for High Activity Ammonia Removal Over Nitrite) process takes place in a single reactor operated without biomass recycle, i.e., the SRT is equal to the HRT. Developed to treat high ammonia concentration sidestreams from sludge digestion, the system is designed to convert ammonia to nitrite, then denitrify the nitrite to nitrogen gas, thus avoiding the conversion of nitrite to nitrate and the need to reduce nitrate back to nitrite to obtain nitrogen removal. This process is accomplished by operating the reactor at high temperatures and selecting an HRT (equals SRT) that will wash out the slow-growing nitrite oxidizers. The process is typically operated at 30 to 40° C with an HRT range of 1 to 2 days. By preventing the conversion of nitrite to nitrate, the SHARON® process reduces the amount of oxygen required for nitrification by 25 percent and then reduces the amount of COD needed for denitrification by 40 percent, compared to full nitrification and denitrification. See Chapter 4, Section 4.5 for additional discussion on the principles of the SHARON® process.

The ANAMMOX® (ANAerobic AMMONia OXidation) process uses only autotrophic bacteria to accomplish nitrogen removal, i.e. denitrification as well as nitrification, and, because ammonium is used as an electron donor, COD does not have to be added to accomplish nitrogen removal. In the conventional ANAMMOX process the first stage is similar to the SHARON® process except that only 50 percent of the ammonia is oxidized to nitrite, and a 50-50 mixture of ammonium and nitrite is sent to the second reactor, where the anammox bacteria use ammonium as an electron donor and reduce nitrite to nitrogen gas. Thus, the oxygen requirement is only 50 percent of that required for complete oxidation of ammonia to nitrite by the SHARON® process, or only 37.5 percent of the amount needed for nitrification to nitrate, assuming nitrification of the entire ammonium load. In addition, the need for organic carbon is completely eliminated. It has been reported that this process reduces the operating costs by 90 percent compared to standard nitrification-denitrification. See Chapter 4, Section 4.12 for additional discussion on the principles of the ANAMMOX® process.

The combination of partial nitrification and Anammox processes can also be carried out in a single reactor and has been given different names: DEMON (DE-amMONification), OLAND (Oxygen-Limited Autotrophic Nitrification-Denitrification) or CANON (Completely Autotrophic Nitrogen removal over Nitrite process). Under oxygen-limited conditions a co-culture of aerobic and anaerobic ammonium-oxidizing bacteria can be maintained as a co-culture in a single reactor.

The DEMON^R process uses pH and DO control in an SBR to maintain both nitrification to NO₂-N and nitrite reduction by anammox bacteria to convert ammonia to nitrogen gas. It allows both of these types of bacteria to co-exist in one single reactor volume, despite the completely different growth characteristics of these bacteria. Within the DEMON process, approximately 50 percent of the ammonia is nitrified to nitrite. External carbon addition is typically not needed.

Another variation of the above application of the anammox process in a single SBR tank is the CANON process (Vazquez-Padin et al., 2009). In this application, air is pulsed to the reactor at a rate and frequency to maintain low microaerophilic DO concentrations.

The OLAND process had been used in laboratory studies with SBR and fixed film applications (Pynaert et al., 2002, Clippelier et al., 2009). For SBR applications low DO and low volumetric removal rates were considered critical to maintain an anammox culture in a granular floc. The fixed film application showed that the anammox reaction could be maintained in a rotating biological contactor with a liquid DO concentration of near 1.0 mg/L.

6.7 Technology Performance

For a given biological nutrient removal technology, the daily composite effluent nitrogen and phosphorus concentrations will vary from day to day and vary among sites due to a number of factors. Commonly recognized factors that affect BNR plant performance are summarized below.

- Wastewater characteristics are of particular importance in BNR processes. The characteristics and relative amount of influent biodegradable COD are key to biological denitrification for nitrogen removal and also for the performance and capacity of enhanced biological phosphorus removal. This and other important wastewater characteristics are given as follows:
 - Influent rbCOD:TP and BOD:TN ratios
 - Minimal temperature and temperature variations
 - Daily and seasonal variations in influent flowrates
 - Daily and hourly variations in flow and constituent concentrations
 - Seasonal variations in flow and constituent concentrations
 - Industrial contributions (e.g., toxins)

- BNR Treatment plant design and configuration involve a number of complex process considerations and equipment selection. For example, choosing a high SRT may be beneficial for some processes such as nitrification, but not for enhanced biological phosphorus removal. It should be noted that full-scale plant data used to judge BNR treatment performance is typically obtained from plants that are to varying degrees below their design capacity. Key factors that can affect performance are as follows:
 - Design conservatism in SRT and HRT
 - Treatment goals (related to permit level and averaging period)
 - Process flexibility
 - Solids processing methods
 - Type and methods of handling recycle flows
 - Equalization capability
 - Sidestream treatment of recycle flows

- Installed equipment
 - Equipment performance and reliability
 - Equipment maintenance requirements
 - Redundancy

- Operation
 - Staffing
 - Instrumentation and process control methods

When evaluating effluent concentrations for a specific BNR technology, it is necessary to recognize that the effluent performance varies daily as a function of influent wastewater, process conditions, operating methods, and biological treatment variations. Thus, the effluent is more aptly characterized in terms of a statistical performance.

Neethling et al. (2009) introduced a method for using a statistical approach to describe process performance. In this approach, the treatment plant or technology performance is tied to the statistical rank to express the probability of achieving a certain performance. Building on this statistical approach, the term Technology Performance Statistic (TPS) was used at a WEFTEC workshop (WEF/WERF, 2009) to assess the performance of full scale treatment plants.

The Technology Performance Statistics (TPS) describes the performance of a technology or process or plant under specific conditions. The TPS is determined from performance data and is linked to the operational conditions during which the data were collected (pilot, full scale, summer, winter, excess capacity available, SRT, etc). The conditions must also include external factors that impact the technology, industrial loadings, seasonality, absence of recycle streams, etc. In addition, the TPS established using past performance, is tied to the treatment objectives or permit limits.

As will be described in more detail in Chapter 7, permit limits for nitrogen and phosphorus can be based on annual average values, quarterly averages, seasonal averages, maximum monthly averages, maximum weekly values, or at their most stringent, maximum daily recorded levels. Limits may be concentration or mass based. Many permits include multiple types of limits for the effluent parameters.

Annual average permit limits for TN and TP clearly provide the greatest flexibility in operation and the least risk of violations. In temperate regions, the BNR system can be operated with relatively high effluent nitrogen concentrations during the winter months, and then operated to obtain very low concentrations during the late summer-early fall months. Seasonal averages provide a similar but lesser amount of flexibility. Monthly or weekly limits necessitate that effluent limits be met on a consistent basis regardless of seasonal operating conditions. The shorter the time period the less forgiving the limit is for periodic upsets of the biological system, such as partial nitrifier washout during storm events. The end result is that WWTPs are often operated to produce effluent concentrations lower than the required value, providing a margin of safety and protecting against a single day exceedance and potential permit violation. This approach may require higher operating costs or more expensive technologies than would be designed and constructed for the longer term averages.

The remainder of this section provides a generalized discussion of the effectiveness of nutrient removal technologies followed by a description of recent research to identify reliable effluent concentrations using data from full-scale treatment plants.

6.7.1 Removal Efficiencies of BNR Technologies - General Discussion

Nitrogen Removal

For biological nitrogen removal, the attainable effluent limit for a suspended growth process depends on the number of anoxic zones and the nitrate recycle ratio to the influent flow. The basic configuration of a single anoxic and aerobic zone (the MLE system), has historically achieved 70 to 90 percent TN removal. TN removal by this basic configuration has been improved by the use of attached growth filters for nitrification (e.g., BAF) or attached growth media in the anoxic and/or aerobic basin to increase SRT and reduce the risks of washout. A second anoxic zone after the aerobic zone (e.g., the 4-stage Bardenpho process) can achieve additional TN removal by denitrifying that portion of the flow that is not recycled to the first anoxic zone. Because the BOD has been removed in the aerobic zone, denitrification in a post-anoxic zone often requires a supplemental carbon source especially in colder regions where the endogenous denitrification rate is low.

Nitrification processes can be optimized by controlling influent ammonia loading (from wastewater or recycle streams) and flow to prevent washout of nitrifiers. Configuration of swing zones that can be operated in anoxic or aerobic modes can help ensure consistent removal under varying operating conditions (e.g., seasonal variations in influent loading, temperature changes, flow variation). Similarly, online monitoring and process control of aeration systems and recycle streams can allow for more consistent performance of systems. Sidestream treatment such as bioaugmentation can be used to seed the activated sludge process with an external source of nitrifiers to obtain complete nitrification at lower SRTs.

For removal of total nitrogen to very low levels (3 mg/L or less), technologies may be limited by biologically resistant dissolved organic nitrogen (rDON), which is typically between 0.5 and 1.5 mg/L. Research is ongoing into the design and operating conditions that can be used to minimize rDON. Process optimization and automated control systems become very important in achieving these low TN levels. Denitrification filters with supplemental carbon (e.g., methanol) addition can provide enhanced TN removal consistently to low effluent levels.

Phosphorus Removal

For biological phosphorus removal, the attainable effluent concentration is fundamentally determined by the rbCOD:TP ratio entering the anaerobic zone, minus the mass of electron acceptors (i.e., DO and nitrates) entering the anaerobic zone. If the rbCOD:TP ratio is favorable (16:1 or higher) and the recycle of nitrate and DO to the anaerobic zone is carefully controlled, low effluent concentrations can be reliably obtained using almost any of the BPR technologies. If VFAs are added from sludge fermentation, lower rbCOD:TP ratios can achieve the same results, with the variability depending upon the quantity and mix of VFAs formed by the fermentation. Unsettled sewage will produce lower effluent soluble phosphorus concentrations than settled sewage because settling changes the COD to TP ratio of the wastewater in an unfavorable direction.

Phosphorus removal by chemical addition (with or without biological phosphorus removal) can reliably achieve low effluent TP levels. Metal salts such as alum and ferric chloride are commonly used. Complete mixing of the chemical at the dosing point and adequate flocculation assure that the metal reacts with phosphate to form a precipitant. The key factor to achieving low levels is the method of liquid/solids separation. Tertiary filtration, in particular deep bed, dual media systems and membranes, provide nearly complete removal of particulate matter and can achieve very low effluent TP levels. Advanced processes such as ballasted high-rate clarification (BHRC) and filtration using iron-oxide coated media have been successful at removing TP to low levels in a number of full-scale applications.

For reliably removing phosphorus to very low levels, the recalcitrant fraction (i.e., unreactive fraction that goes through the treatment process unchanged) may become limiting depending on the nature of the influent wastewater. In addition, variability in measurement of phosphate concentrations less than 0.02 mg/L could be a limiting factor. See Chapter 3, section 3.7 for additional discussion.

6.7.2 Technology Performance Statistics based on Full-Scale Operating Data

The Water Environment Research Foundation (WERF) sponsored a project to evaluate the performance capabilities of nutrient removal processes by collecting data from some of the best performing nutrient removal WWTPs in the county to improve understanding of achievable effluent levels for nutrients and key factors affecting plant performance to these levels (WERF project no. NUTR1R06j, 2009). Preliminary results of the project were presented at the 2009 Annual Water Environment Federation Technical Exhibition and Conference (WEFTEC) (Neethling, et al. 2009; Parker, et al. 2009; Bott, et al. 2009).

The facility evaluations were based on complete operating data and analytical information provided by plant managers covering a 3 year period. No special sampling or operational changes were made for the performance evaluations. Statistical methods were used to determine the probability statistics for nitrogen and/or phosphorus removal performance at each plant. Probability plots were developed using normal and log-normal distributions. See Bott et al. (2009) for a detailed discussion of statistical analyses of plant data.

The WERF researchers recognized the variability in nutrient removal performance that exists in all plants due to variations in wastewater characteristics and operating conditions, and consequently it was not considered practical to describe the achievable limits for a technology based on a single numerical value. Thus, the achievable performance was described as **Technology Performance Statistics (TPS)**. In this way the performance levels could be defined in terms of frequency and

reliability. In addition, TPS results should consider the conditions under which the data were collected such as process configurations, treatment objectives, existing versus design loadings, solids handling processes, etc. See (Neethling, et al. 2009) for more information.

Three TPS levels can be used to define the best, median, and reliably achievable performance:

- **Best performance:** The lowest concentration achieved by the plant during a 14-day period (TPS-14d). Neethling, et al. (2009) provides the rationale for this value, explaining that a 2-week period would capture two weekly cycles, eliminate outlying data, identify a high level of treatment that can occasionally be achieved, and perhaps also capture a cycle of at least one sludge age in a typical plant operation. The TPS-14d can be calculated in two ways: (1) calculating a running 14-day average and determining the minimum value, or (2) calculating the 3.84th percentile.
- **Median performance:** The concentration achieved on a statistical median basis (TPS-50%) approximating average performance. This value indicates the median performance of the technology that can be achieved on an annual basis with no margin of safety. It is statistically exceeded every other year and requires a margin of safety to provide reliable performance to comply with discharge limits.
- **Reliably Achievable Performance:** May be the 90th, 95th, or 99th percentile depending on the permit averaging period. Neethling, et al. (2009) notes that the 91.7th percentile (11/12 percent) translates to a plant with monthly limits exceeded one month per year on a statistical basis. The TPS-95% indicates a monthly value that is exceeded 3 months in a 5 year cycle.

Figure 6-20 illustrates technology performance statistics of a phosphorus removal plant. The data from this facility follows a good approximation of the typical log-normal distribution. When determining performance statistics, the rank is used to calculate performance to account for the actual performance distribution as reported by the technology. The TPS-3.84% or best performance for this dataset is 0.040 mg/L. This value excludes the best reported value of 0.002 mg/L which is likely an outlier. The 50th percentile performance statistic of 0.08 mg/L reflects the median value and the 95th percentile statistic of 0.23 mg/L the reliable performance. The 95th percentile effluent P concentration is 3 times the median performance and 6 times the best performance.

The distribution in Figure 6-20 illustrates the importance of the averaging period in determining plant performance. This example plant demonstrates that it can achieve 0.08 mg/L on average, yet the reliable monthly value is three times higher at 0.23 mg/L. The longer averaging period increases the ability of the plant to achieve the limit. A shorter averaging period requires a higher safety factor to increase the ability to achieve the limit reliably.

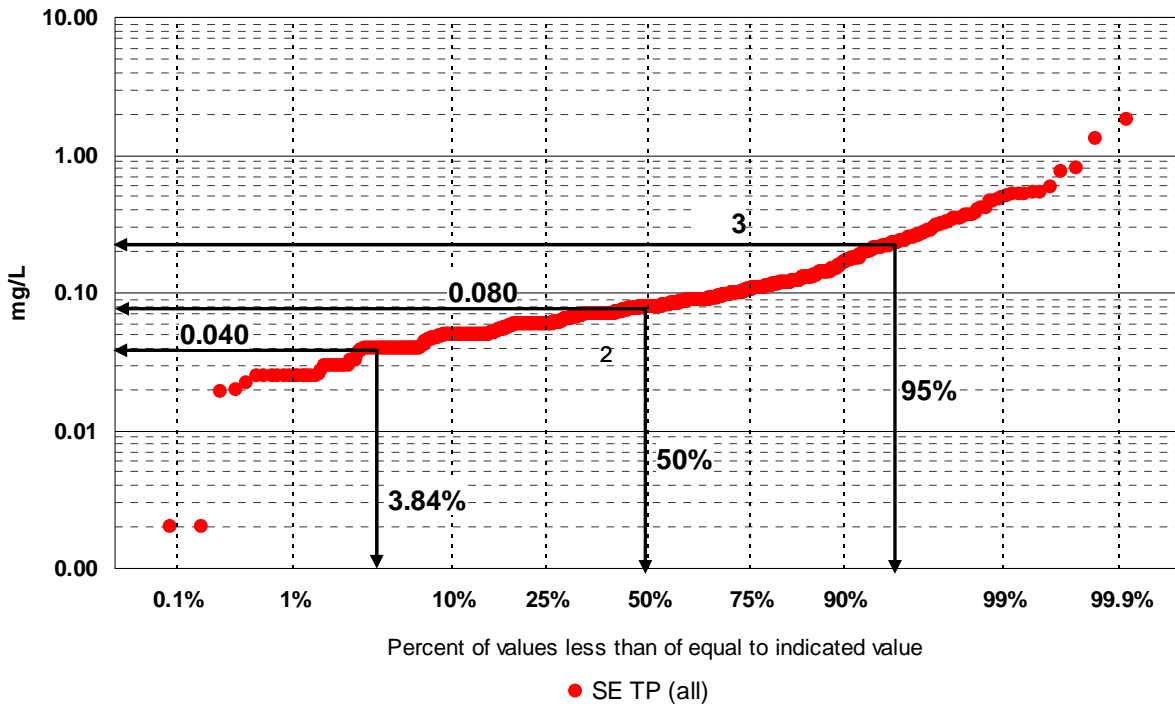

Figure 6-20. Probability plot of secondary effluent phosphorus data showing 3.84th, 50th, and 95th percentiles of the data showing a log-normal distribution line and determining the percentiles based on this log-normal distribution (Example data).

Summary of Performance Data

TPS values for the facilities participating in the WERF study are summarized in Figure 6-21 for nitrogen removal and Figure 6-22 for phosphorus removal. The figures show the best, median, and reliable (95%) TPS values.

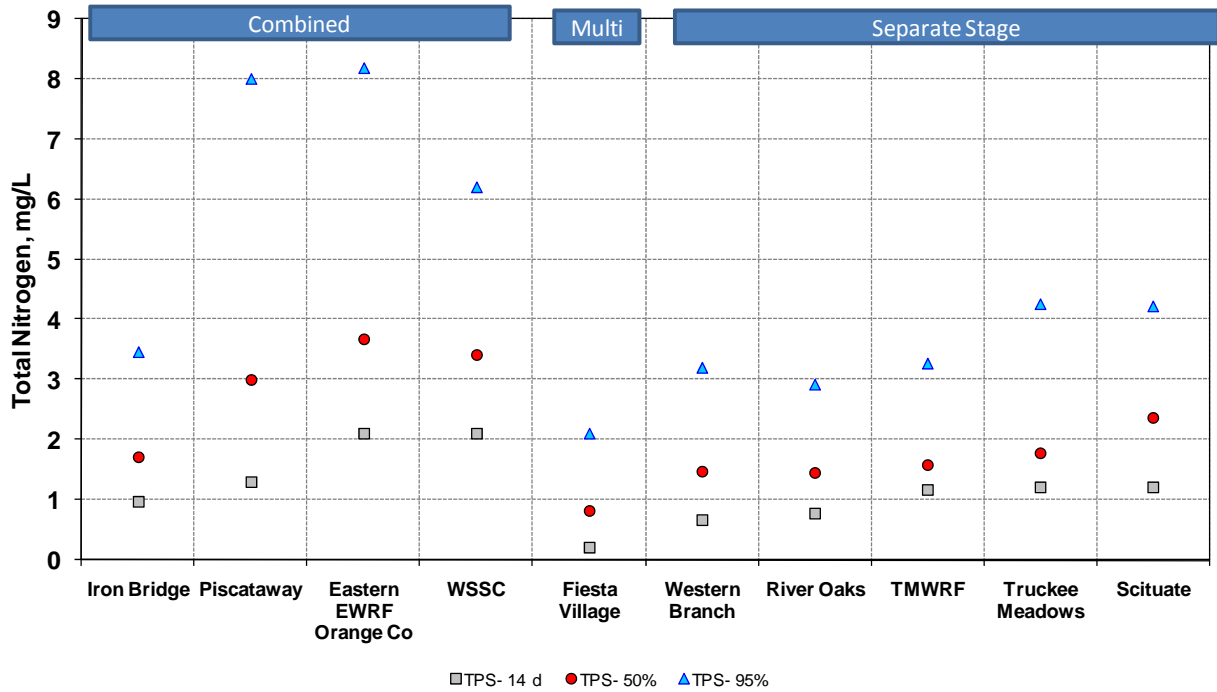

Figure 6-21. Technology performance statistics for nitrogen removal plants showing the best (TPS 14-d), median (TPS-50%) and reliable (TPS-95%) values.
 Source: Clark et al. 2010. Used with permission.

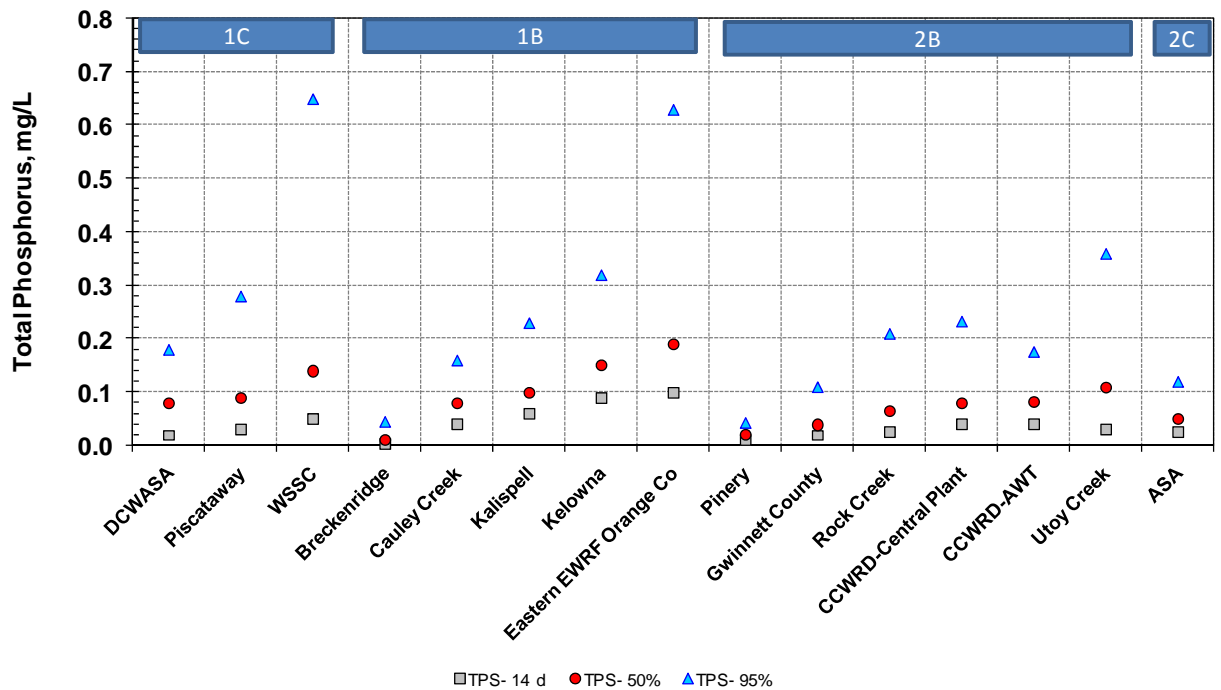

Figure 6-21. Technology performance statistics for phosphorus removal plants showing the best (TPS 14-d), Median (TPS-50%) and reliable (TPS-95%) values.
 Source: Clark et al. 2010. Used with permission.

Nitrogen removal facilities are grouped into three categories:

- Separate Stage processes. These nitrogen removal plants use separate unit processes for nitrification and denitrification. A carbon source such as methanol is added to the denitrification stage.
- Combined nitrogen removal processes represent conventional, multiple zone activated sludge processes designed for biological nitrogen removal. These processes include MLE, Bardenpho, step feed, or other processes. Effluent filters are used in these plants without added carbon – the filter removes particulate nitrogen but does not provide denitrification.
- Multiple Stage processes are those that use conventional biological nitrogen removal (as in the combined processes) with additional nitrogen removal in a denitrification filter with carbon addition.

The performance of the facilities in Figure 6-21 show the three TPS values in groups. The graphs show that combined processes are not achieving as low effluent nitrogen values as separate and multistage processes. In addition, the variability of the combined (or conventional) processes is high: for two of the facilities, the reliable TN concentration is about 3 times the median performance. Multistage and separate stage facilities achieve lower effluent TN concentrations and show less variability with reliable TPS-95% values about 2 times the average. The reason for the improved performance is in the ability to add external carbon to overcome excursions in performance and maintain the performance levels at the target by adjusting the carbon addition.

Phosphorus removal facilities are grouped into four categories depending on the main removal process (biological or chemical) and depending on addition of tertiary chemical addition:

- 1B represents Biological Phosphorus Removal with a polishing filter, but without chemical addition to the filters.
- 1C represents Single Chemical Phosphorus Removal in the primary or secondary process with a polishing filter but without chemical addition to the filters.
- 2B represents Biological Phosphorus Removal with polishing filter with chemical for phosphorus removal.
- 2C represents Single Chemical Phosphorus Removal in the primary or secondary process with a polishing filter with chemical for phosphorus removal.

The performance of the facilities in Figure 6-22 show the three TPS values in groups. The graph shows that 2 stage processes are achieving lower effluent phosphorus values than single stage processes. There appears to be little difference in the performance of plants using biological and chemical removal for the primary and secondary process. The variability in the phosphorus removal is significant. The reliable performance is 1.5 to 4 times higher than the average.

6.8 Factors for Simultaneously Achieving Low Nitrogen and Phosphorus Effluent Concentrations

Some unique factors apply when plants are attempting to simultaneously achieve low nitrogen and phosphorus in the plant effluent. Key factors are discussed below. For additional discussion, see Section 2.4.1 of the *Municipal Nutrient Removal Technologies Reference Document* (USEPA 2008b).

The microorganisms responsible for biological removal of phosphorus and nitrogen compete for bio-available carbon in the waste stream. The available carbon in the influent or return side streams can be used for both biological phosphorus removal and denitrification, but is likely to be insufficient to simultaneously achieve very low effluent levels of both, for instance, below 4.0 mg/L TN and 0.5 mg/L TP. This limitation can be overcome by adding a supplemental organic carbon source such as methanol or some other alternative to the second anoxic zone or VFAs to either the anaerobic or second anoxic zones, or both. Plants that are required to meet very low effluent phosphorus limits will most likely require both the addition of an alternative carbon source to the anaerobic zone and tertiary filtration.

Phosphorus is a necessary nutrient for microbial growth. If TP is reduced too low before a biological process like nitrification or denitrification, the growth of the microorganisms could be inhibited, necessitating the addition of supplemental phosphorus. This is most likely to occur when tertiary denitrification filters are used; however, inhibition of nitrification also has been observed in plants practicing chemical phosphorus removal in the primary clarifiers.

In plants with a single anoxic zone for nitrification, nitrates may be returned in the RAS stream to the anaerobic zone. This can reduce BPR because some heterotrophic microorganisms use nitrates to grow and will consume organic substrate instead of the PAO. To address this issue, the following design options can be used:

- Convert the last part of the aeration zone into a deoxygenation section by reducing the aeration. Care must be taken not to cause rising sludge in the secondary clarifier.
- Divert the RAS to a small tank before returning it to the anaerobic zone, such as in the RDN configuration. The tank would reduce the DO and nitrate in the RAS, which would further improve the performance of the anaerobic zone. The retention time, however, would have to be limited to prevent secondary release of phosphorus.
- Divert the RAS to the anoxic zone rather than to the anaerobic zone, where it will both deoxygenate and denitrify, and then recycle to the anaerobic zone, as in the UCT/VIP configurations.

Plants should be designed and operated to avoid secondary release. Anaerobic or anoxic zones that are too big remove organic carbon and nitrates in less time than the HRT. This can result in the release of phosphate without poly- β -hydroxy-alkanoate (PHA) storage, which means that there will be insufficient stored substrate to take up the released phosphorus in the aerobic zone. Plant operators can consider adding a chemical to primary sedimentation tanks (e.g., ferric chloride) in the winter to remove more solids and reduce the needed SRT to achieve the same nitrification levels.

If nitrate removal has been enhanced in the secondary process, phosphorus can be released from the sludge in the secondary clarifier if DO depletion occurs. This might not be observed immediately but could result in a buildup of phosphorus in the secondary treatment system that would eventually raise the effluent TP levels. If this is a possible issue, plant operators should consider biological nitrification and phosphorus removal in a tertiary process using chemical addition.

Temperature affects biological nitrogen and phosphorus removal processes similarly although nitrification is more sensitive than BPR. In colder temperatures, fermentation might not provide sufficient VFAs for the BPR process. Sidestream fermentation has been used very successfully to augment VFAs in the anaerobic zone during winter operation. The rate of nitrification decreases significantly with decreasing temperatures, with rates 50 percent lower for every 8 to 10°C drop in temperature (WEF and ASCE 2006). To maintain nitrification of ammonia (which is the key first step to nitrogen removal), plants can design swing zones and aerate those zones during periods of low temperatures. Denitrification rates also decrease with decreasing temperature, although not as rapidly. Denitrification rates at low temperatures should also be considered when designing and operating nutrient removal systems.

Both nitrification and chemical phosphorus removal consume alkalinity. Low alkalinity can inhibit nitrification because it is the carbon source for the nitrifiers, and also because low alkalinity usually causes low pH, which can inhibit nitrifiers. Therefore, even when nitrogen removal is not required but phosphorus removal is, practicing denitrification is usually the most economical approach because denitrification restores 50 percent of the alkalinity consumed during nitrification. Of course, this is a useful strategy only if nitrification is already being practiced. Note that chemical precipitation will not be complete if sufficient alkalinity is not present.

6.9 References

- Barnard, J.L. 1984. Activated Primary Tanks for Phosphate Removal. *Water SA*. 10(3): 121-126.
- Barnard, J.L. 2006. Biological Nutrient Removal: Where We Have Been, Where We are Going? In WEFTEC 2006.
- Barnard, J.L., H. Phillips, B. Sabherwal, C. deBarbadillo. 2008. Driving Membrane Bio-Reactors to Limit of Technology. In *WEFTEC 2008*.
- Benish, M., D. Clark, A.Z. Gu, J.B. Neethling. 2006. How Low Can You Go? Achieving Extremely Low Effluent Phosphorus in Wastewater Treatment. *Water and Wastes Digest*, October 2006. Volume 46 Number: 10.
- Bott, C.B., S. N. Murthy, T. T. Spano, and C.W. Randall. 2007. WERF Workshop on Nutrient Removal: How Low Can We Go and What is Stopping Us from Going Lower? Alexandria, VA: WERF.
- Bott, C.B, D. Parker, J. B. Neethling, A. Pramanik, and S. Murthy. 2009. WEF/WERF Cooperative Study of BNR Plants Approaching the Limit of Technology: II. Statistical Evaluation of Process Reliability. Presented at WEFTEC 2009, Orlando, FL.

- Clark, D.L., Hunt, G., Kasch, M.S., Lemonds, P.J., Moen, G.M., Neethling, J.B. (2010) Nutrient Management Approaches to Protect Water Quality. Volume 1 Review of Existing Regulatory Practices, WERF Nutrient Challenge report NUTR1R06i, WERF/IWAP.
- Clippelier, H.D., S.E. Vlaeminck, M. Carballa, and W. Verstraete, 2009. A Low Volumetric Exchange Ratio Allows high Autotrophic Nitrogen Removal in a Sequencing Batch Reactor, *Bioresource Technology* 100: 5010-5015.
- DeBarbadillo, C., J. Barnard, S. Tarallo, and M. Steichen. 2008. Got Carbon? Widespread biological nutrient removal is increasing the demand for supplemental sources. *Water Environment & Technology*. Alexandria, VA: WEF. 20(1): 49-53.
- Dold, P., I. Takács, Y. Mokhayeri, A. Nichols, J. Hinojosa, R. Riffat, C. Bott, W. Bailey, and S. Murthy. 2008. Denitrification with Carbon Addition—Kinetic Considerations. *Water Environment Research*. 80(5): 417-427. WEF.
- Ellis, E.P. and A.H. Cathcart. 2008. Selection, Installation, Startup and Testing of the World's First Full-Scale CoMag Phosphorus Reduction Tertiary Treatment System. Presented at WEFTEC 2008. Chicago, IL.
- EPA Region 10. 2007. Advanced Wastewater Treatment to Achieve Low Concentration of Phosphorus. EPA Region 10. EPA 910-R-07-002.
- Feldthusen, M. 2004. Continuous Sand Filters: Tertiary WWT and Other Applications. SAWEA-Workshop. March 22, 2004.
- Holloway, R., H. Zhao, T. Rinne, G. Thesing, J. Parker, and M. Beals. 2008. The Impact of Temperature and Loading on Meeting Stringent Nitrogen Requirements in a Two-Stage BAF – A Comparison of Pilot and Full-Scale Performance. In *WEFTEC 2008*.
- Hu, Z. 2001. Eternal Nitrification Biological Nutrient Removal Activated Sludge Systems: Development and Modeling. Doctoral Dissertation. Department of Civil Engineering, University of Cape Town, Rondebosch, 7700, South Africa.
- Kang, S.J., W.F. Bailey, and D. Jenkins. 1992. Biological Nutrient Removal at the Blue Plains Wastewater Treatment Plant in Washington, D.C. *Water Science Technology*. UK 26(9-11):2233–2236.
- Neethling, J.B., B. Bakke, M. Benisch, A. Gu, H. Stephens, H.D. Stensel, and R. Moore. 2005. *Factors Influencing the Reliability of Enhanced Biological Phosphorus Removal*. Alexandria, VA: WERF and IWA Publishing.
- Neethling, J.B., D. Stensel, D. Parker, C. Bott, S. Murthy, A. Pramanik, and D. Clark. 2009. What is the Limit of Technology (LOT)? A Rational and Quantitative Approach. Presented at WEFTEC 2009, Orlando, FL.
- Parker, D., C. Bott, J. B. Neethling, A. Pramanik, and S. Murthy. 2009. WEF/WERF Cooperative Study of BNR Plants Approaching the Limit of Technology: I. What Can We Learn About the Technologies? Presented at WEFTEC 2009, Orlando, FL.
- Pynaert, K., R. Sprengers, J. Laenen, and W. Verstraete, 2002. Oxygen-limited Nitrification and denitrification in a Lab-scale Rotating Biological Contactor. *Environment Technology*. 23(3): 353-362.

- Pearson, J.R., D.A. Dievert, D.J. Chelton, and M.T. Formica. 2008. Denitrification Takes a BAF: Starting Up the First Separate Biological Anoxic Filter in Connecticut Requires Some Problem-Solving and Know-How. *Water Environment & Technology*. Alexandria, VA: WEF. 20(5): 48-55.
- Randall, C.W., J. Barnard and D. Stensel. 1992. *Design and Retrofit of Wastewater Treatment Plants for Biological Nutrient Removal*. Technomic Publishing Company, Inc., Lancaster, PA.
- Reardon, Roderick D. 2005. Tertiary Clarifier Design Concepts and Considerations. In *WEFTEC 2005*.
- Sadick, T., W. Bailey, G. Daigger, and M. McGrath. 1998. Large-Scale Nitrogen Removal Demonstration at the Blue Plains Wastewater Treatment Plant Using Post-Denitrification with Methanol. Presented at IAWQ 19th Biennial International Conference on Water Quality. Vancouver, B.C., Canada. June 1998.
- Sen, D., C. Randall, and T. Grizzard. 1990. Biological Nitrogen and Phosphorus Removal in Oxidation Ditch and High Nitrate Recycle Streams. Pub CDP/TRS 47/90. USEPA Chesapeake Bay Program.
- Sen, S., V Occiano, P. Wong, and A. Langworthy. 2008. Comparing Implementation of MBBR versus BAF on a Space Constrained Site. In *WEFTEC 2008*.
- STOWA. 2006. BCFS Process Sheets. Website updated 13 June 2006. Available online: <http://www.stowa-selectedtechnologies.nl/Sheets/Sheets/BCFS.Process.html>
- Trivedi, Hiren and Nicolas Heinin. 2000. Simultaneous Nitrification / Denitrification by Monitoring NADH Fluorescence in Activated Sludge. In *WEFTEC 2000*.
- USEPA. 2003. Wastewater Technology Fact Sheet: Ballasted Flocculation. Office of Waste Management. Municipal Technology Branch. EPA 832-F-03-010
- USEPA. 2007a. Wastewater Management Fact Sheet: Denitrifying Filters. EPA 832-F-07-014.
- USEPA. 2007b. Wastewater Management Fact Sheet: Membrane Bioreactors. Available online: http://www.epa.gov/owm/mtb/etfs_membrane-bioreactors.pdf
- USEPA. 2008a. *Emerging Technologies for Wastewater Treatment and In-Plant Wet Weather Management*. EPA 832-R-06-006. Available online: http://www.epa.gov/OW-OWM.html/mtb/emerging_technologies.pdf
- USEPA. 2008b. *Municipal Nutrient Removal Technologies Reference Document* Office of Wastewater Management, Municipal Support Division. EPA 832-R-08-006. Available online: <http://www.epa.gov/OWM/mtb/publications.htm>
- USEPA. 2008c. Onsite Wastewater Treatment Systems Technology Fact Sheet 3: Sequencing Batch Reactor Systems. EPA 625-R-00-008. Website updated: 14 April 2008. Available online: <http://www.epa.gov/nrmrl/pubs/625r00008/html/html/tfs3.htm>
- USEPA. 2009. *Nutrient Control Design Manual State of Technology Review Report*. Office of Research and Development. EPA/600/R-09/012. Available online: <http://www.epa.gov/nrmrl/pubs/600r09012/600r09012.pdf>

- Vaxquez, J.R, M. Figueroa, I. Fernandez, A. Mosquera-Corral, J.L. Campos, and R. Mendez. 2009. Post-treatment of Effluents from Anaerobic Digesters by the Anammox Process, *Water Science and Technology*, 60(5): 1135-1143.
- Verma, M., S.K. Brar, J.F. Blais, R.D Tyagi, and R.Y. Surampalli. 2006. Aerobic Biofiltration Processes--- Advances in Wastewater Treatment. *Pract. Periodical of Haz., Toxic, and Radioactive Waste Mgmt.* 10: 264-276.
- Vidal, A., R. Combeau, J. Costa, X. Le Tallec. 1997. Biostyr Improvements: Control Process of the Aeration. *Annual Report of Anjou Research on Biostyr Process.* OTV, France.
- WEF and ASCE. 2006. *Biological Nutrient Removal (BNR) Operation in Wastewater Treatment Plants - MOP 29.* Water Environment Federation and the American Society of Civil Engineers. Alexandria, VA: WEFPress.
- WEF. 2006. *Membrane Systems for Wastewater Treatment.* Alexandria, VA: WEFPress.
- WEF. 2005. *Manual of Practice FD-8: Clarifier Design, 2nd Edition.* Alexandria, VA: WEF.
- WEF and ASCE. 2010. *Design of Municipal Wastewater Treatment Plants – WEF Manual of Practice 8 and ASCE Manuals and Reports on Engineering Practice No. 76, 5th Ed.* Water Environment Federation, Alexandria, VA, and American Society of Civil Engineers Environment & Water Resources Institute, Reston, Va.
- WERF. 2000a. Technology Assessments: Nitrogen Removal Using Oxidation Ditches. Alexandria, VA, WERF.
- WERF. 2000b. Investigation of Hybrid Systems for Enhanced Nutrient Control. Final Report, Collection and Treatment. Project 96-CTS-4. Alexandria, VA: WERF.
- WE&T. 2007. Plant Profile: Warrenton Wastewater Treatment Plant. *Water Environment & Technology.* Alexandria, VA: WEF. Available online: <http://www.wef.org/ScienceTechnologyResources/Publications/WET/07/07May/07MayPlantProfile.htm>
- Young, T., S. Crosswell, and J. Wendle. 2008. Comparison of Nitrogen Removal Performance in SBR Systems. In *WEFTEC 2008.*
- Zhu, S. and S. Chen. 2002. The Impact of Temperature on Nitrification Rate in Fixed Film Biofilters. *Aquacult. Eng.* 26, 221-237.

7. Establishing Design Objectives

Chapter 7 covers:

- 7.1 Introduction
- 7.2 Characterizing Existing Treatment
- 7.3 Design Flow Rates
- 7.4 Wastewater Characteristics
- 7.5 Target Effluent Concentrations for Nitrogen and Phosphorus
- 7.6 Goals for Reliability, Sustainability, and Process Flexibility
- 7.7 Solids Handling Options
- 7.8 Site Constraints
- 7.9 Selecting an Overall Process Design Factor
- 7.10 References

7.1 Introduction

Establishing design criteria is a critical first step in upgrading or retrofitting a wastewater treatment plant (WWTP) for nutrient removal. **Design criteria** are the conditions under which the WWTP must operate following the upgrade or retrofit. They include factors such as projected influent flow rate and mass loading, effluent requirements (e.g., total nitrogen limits), and goals for sustainability, operability, and flexibility. Designers should work closely with facility owners and other stakeholders to develop design criteria that carefully consider future needs and treatment conditions for the entire planning period (typically 20 years). The text box on the next page highlights some key questions that should be asked during design criteria development.

Design criteria are an important part of an overall **facility plan** (also called a strategic or master plan). The facility plan documents the planning and decision-making processes that lead directly to design and construction. Among other things, it identifies the problem, presents criteria and assumptions, provides preliminary layout and cost alternatives, and reviews staff requirements. Ten State Standards (2004) requires that comprehensive facility plans be completed for projects involving new, upgraded, or rehabilitated wastewater treatment facilities. Facility plans are usually prepared by a consultant and signed and sealed by a registered professional engineer. Additional guidance on developing an overall facility plan is provided in the Water Environment Federation (WEF) Manual of Practice No. 28, *Upgrading and Retrofitting Water and Wastewater Treatment Plants* (2005).

Key Questions to Consider when Establishing Design Criteria

- Will the service area boundary change in the future? A planned residential community or annexation of an existing community can significantly change influent flows and characteristics.
- What is the population projected to be at the end of the design period (typically 20 years)? Population projections should consider seasonal changes in population and non-permanent residents.
- Is decentralized or onsite treatment being encouraged for new, remote communities? Some states and large wastewater utilities are encouraging decentralized treatment to reduce the load on the existing collection system and save energy.
- Are there any anticipated changes in industrial users? Addition of a major industry or industrial plant shutdowns can have a significant impact on wastewater quantity and quality.
- Is there a strong water conservation program in your service area or is one being planned? Water conservation could result in reduced flow volumes but higher concentrations of nitrogen and phosphorus in the wastewater.
- How certain are you about future regulations and flow quantity? Flexibility in design can help address uncertainty in future conditions.

This chapter provides technical guidance on establishing design criteria for the purposes of upgrading an existing facility to provide nutrient removal (nitrogen, phosphorus, or both) or improve nutrient removal capabilities if they already exist. It is important to note that the data gathering steps in Sections 7.2 through 7.4 go hand in hand with the development and calibration of a process simulation model. As will be explained in Chapter 10, modeling is the recommended approach for designing WWTP upgrades for biological nutrient removal (BNR) because of (1) its flexibility in enabling designers to quickly test many different configurations and operating scenarios and (2) its ability to simulate treatment performance under a wide range of conditions using dynamic modeling.

Many states have specific requirements for design criteria such as design flows and reliability. Designers should carefully review state requirements and guidelines when developing criteria for nutrient removal upgrades or retrofits. In addition to this chapter, readers are encouraged to review Chapter 5, Upgrading Existing Facilities, in the *Municipal Nutrient Removal Technologies Reference Document* (USEPA 2008), available online at <http://www.epa.gov/OWM/mtb/mnrt-volume1.pdf>. General information on WWTP design can also be found in Ten State Standards (2004), WEF and ASCE (1998), and Tchobanoglous et al. (2003).

7.2 Characterizing Existing Treatment

Technology selection and design for efficient nutrient removal requires an extensive understanding of the existing plant's configuration, operation, and performance. For example, an operations team wishing to optimize the plant's activated sludge system for nitrification needs in depth knowledge of flow configuration, hydraulic residence time (HRT), solids residence time (SRT), and

dissolved oxygen levels within the basin(s) during both normal and peak flow conditions. Recycle streams, such as supernatant from sludge dewatering operations, can increase ammonia in the activated sludge basins and have a negative impact on nitrification. The configuration of existing sludge handling systems can be a driving factor in the design of chemical phosphorus removal systems. Odor control practices in the collection system can reduce the amount of substrate available for biological phosphorus removal.

In addition to configuration and performance, it is important to ascertain the condition of existing equipment such as piping and pumps to determine their remaining life and rehabilitation requirements. WEF (2005) recommends plant walk-throughs and interviews with the owners and operators to gather this information and determine how existing equipment would fit into the upgraded facility plan.

7.3 Design Flow Rates

The total flow delivered to a WWTP can vary from year to year due to population and industrial changes within the service area. Influent flow rate can also vary seasonally—especially for areas with large seasonal populations such as resort communities. WWTPs can experience significant peak flows during wet weather events due to inflow and infiltration or if they have a combined collection system. For small plants, peak hourly flow based on individual usage patterns can have a significant impact on design.

Retrofits for nutrient removal should be designed for average and peak flow conditions. These flow conditions should be projected for initial operation and through the end of the design period. The typical design period is 20 years; however, shorter alternative design periods (e.g., 10 years) may be used for the phased implementation of retrofits. Energy efficiency should be considered for existing operation and at the end of the design period.

This section discusses the various design flow rates that are important for designing upgrades or retrofits for nutrient removal.

7.3.1 Characterizing Existing Flow

Designers should use historical operating data from the plant to identify the various components of the existing flow and to characterize its variability over time. At least **three years** of historical flow data should be analyzed if available. Graphical and statistical analysis of this data can be extremely useful. Flow characterization is also an important component of developing and calibrating a process simulation model. Designers may decide to collect detailed flow data for modeling purposes.

Table 7-1 provides a description of influent flow components. Flow from domestic sources is a key component that provides the basis for flow projections. Infiltration and inflow (I&I) and storm water flow are needed for defining peak flow values. Table 7-2 lists the flow characteristics that should be identified based on existing plant records.

Existing flow data should be used to identify a **peaking factor** for the plant. The peaking factor is the peak flow rate (typically peak hourly flow) divided by the average long-term flow rate. At least three years of flow data should be used to determine the peaking factor (Tchobanoglous et al. 2003).

Table 7-1. Influent Flow Components

Flow component	Description	Estimation Methodology
Domestic wastewater	Wastewater from residential, commercial, institutional, and similar facilities.	Average dry-weather flow minus industrial flow. Can be estimated assuming a typical flow per day per person.
Industrial wastewater	Wastewater originating from industrial processes. Characteristics are highly variable. Can contain components that inhibit biological nitrogen removal.	From water utility meter records or interviews with owners.
Infiltration and inflow (I&I)	Stormwater, snowmelt or ground water that enters the collection system either through cracks and other types of breaks in the system (infiltration) or direct storm drain connections such as foundation and basement drains (inflow). Much lower contaminant concentrations compared to domestic wastewater.	I&I can be estimated as the difference between average daily wet weather flow and average daily dry weather flow. Infiltration can be determined separately from inflow by comparing flow during wet periods when the ground water is elevated, to flow during and shortly after a heavy rainfall.
Storm water	A factor only for localities that use the same system for collecting wastewater and storm water(combined systems).Infiltration from peak rainfall is included in I&I above.	Difficult to differentiate between inflow and storm water flow. Can be estimated as the difference between dry weather flow and wet weather flow.

Table 7-2. Flow Characterization

Flow Characterization	Description
Annual average daily flow ¹	Average flow rate occurring within a 1-day period based on annual flow data, i.e. 1/365 th of total Annual Flow.
Average daily dry-weather flow	Average of daily flows sustained during a dry weather period. Determined as the daily average flow for all dry weather periods during an average year.
Average daily wet-weather flow	Average of daily flows sustained during a wet weather period when I&I and storm water are factors. Determined as the daily average flow for all wet weather periods during an average year.
Maximum or peak daily flow	The largest volume of flow occurring within a 1-day period during an average year.
Maximum monthly flow	The average of daily flows for the month with the highest total flow during an average year. Once determined should be used for design flow.
Peak hourly flow	The largest volume of flow occurring within a 1-hour period during an average year.
Peak instantaneous flow	Highest recorded flow rate. May be considerably below the actual peak flow because of equipment limitations, but should be estimated if so.
Diurnal flow pattern	The typical daily flow pattern for domestic wastewater, i.e. with peaks occurring in the morning and evening.
Atypical events	Types of events include storm flows and large industrial discharges. Based on historical records going back as many years as possible (e.g., based on review of past 10 years).

1. An average year is usually the average of three years, or more, at the discretion of the designer. However, its definition may change depending upon whether or not there is a steady annual increase or decline for known reasons.

7.3.2 Projecting Future Conditions

The following information is needed to project future flows and establish design flows for the project:

- Projected population growth for the design period including the estimated number of people to be served at the end of the design period.
- Per person (per capita) flow rate estimate in gallons per day (gpd).
- Projected commercial growth (including zoned areas and expected types of businesses) and new institutional and recreational facilities.
- Planned industrial contributions and an allowance for unplanned contributions.

Population growth projections are often made by the city or county government. If these are not available, historical population data can be extrapolated to predict population increases into the future, although this method is crude at best.

Historical flow records can be used to estimate average per person flow for a given community by dividing the average annual dry-weather flow (expressed as a daily value) by the number of people served. Industrial flows should be subtracted from the average annual dry-weather flow if possible. Historical records, however, cannot always be depended upon to give an accurate prediction of future flows. In its onsite wastewater treatment manual, EPA (2002) reports that average daily flows between 50 and 70 gpd per person are typical for residences built before 1994. New homes and residences constructed after 1994 are subject to the U.S. Energy Policy Act (EPACT) standards, which set maximum flow values for household plumbing fixtures such as toilets, showerheads, and faucets (Table 7-3 shows the difference in water use between standard fixtures and EPACT fixtures). EPA estimates that homes built after 1994 or homes that have been retrofitted with EPACT standard fixtures have average daily wastewater flows between 40 and 60 gpd per person (EPA, 2002). Average per capita flow may be even less in regions that have enacted water conservation programs.

Table 7-3. Comparison of Flow Rates and Flush Volumes Before and After U.S. Energy Policy Act

Fixture	Fixtures installed prior to 1994	EPACT requirements (effective January, 1994)	Potential reduction in water used (%)
Kitchen faucet	3.0 gpm (0.19 L/s)	2.5 gpm (0.16 L/s)	16
Lavatory faucets	3.0 gpm (0.19 L/s)	2.5 gpm (0.16 L/s)	16
Showerheads	3.5 gpm (0.22 L/s)	2.5 gpm (0.16 L/s)	28
Toilet (tank type)	3.5 gal (13.2 L)	1.6 gal (6.1 L)	54
Toilet (valve type)	3.5 gal (13.2 L)	1.6 gal (6.1 L)	54
Urinal	3.0 gal (11.4 L)	1.0 gal (3.8 L)	50

Source: Konen, 1995.

Design textbooks also provide typical ranges of flow per person per day. WEF and ASCE (1998) provide a range of total flow per capita of between 60 and 110 gpd/person. Tchobanoglous et al. (2003) present a possible range of per person flow rate values of between 46 and 97 gpd based on the number of persons per household, with higher per person values for smaller households (citing Mayer 1999). Some states provide guidance on selecting per capita flow rate estimates. The Wisconsin Department of Natural Resources (DNR) recommends that design engineers assume 60 to 70 gpd/person for plants serving 5,000 or fewer people, and between 65 and 80 gpd/person for plants serving more than 5,000 people. This higher value reflects greater influence of commercial and industrial customers (Wisconsin DNR 2006). When completing flow projections, regional and state guidance should be consulted to account for the potential regional differences in water use and wastewater generation.

Water use records are another source of data that can be useful in predicting per capita flow and future flows. The 1999 report, *Residential End Uses of Water* (Mayer 1999), is one of the most commonly cited sources for water use data. The proportion of water consumed that becomes wastewater depends on regional conditions. Higher proportions (as high as 90 percent) can be assumed for northern states during cold weather when irrigation use is low. A smaller proportion (60 to 70 percent) becomes wastewater in arid regions (Tchobanoglous et al. 2003).

Future flow projections for new commercial, institutional, and recreational facilities can be based on meter records from similar facilities. Data Tables 3-2 through 3-4 in Tchobanoglous et al. (2003) provide typical values if flow data are not available.

7.3.3 Setting Design Flow Rates

Average annual design flow is important for conducting steady state modeling simulations. It should be based on population projections and estimated future flows from commercial, institutional, recreational, and industrial facilities for the end of the design period (or at some point in the design period if using a phased approach as described in Section 7.3). Average annual flow should represent normal, dry-weather operating conditions.

Biological reactors (e.g., activated sludge basins) are usually sized using the **Maximum Month Design Flow**, although short SRT systems may require sizing based on max week or even short running averages. Clarifiers, filters, and pump stations are typically sized based on maximum hydraulic or solids load, which is often based on **Peak Hourly Design Flow**. Maximum and peak rates are usually derived by multiplying the average annual design flow by a peaking factor. Peaking factors are based on analysis of existing peak flows compared to average flows (see Section 7.3.1), with engineering judgment applied to account for future changes in I&I (e.g., collection system upgrades can significantly reduce I&I, but aging infrastructure increases I&I). Flow equalization is a significant factor—flow equalization at the plant or in the collection system can reduce the peaking factor. Diurnal flow pattern for the design year are also very important for modeling.

Designers should consult with state regulators to ensure that design flows adhere to state requirements and meets the forecasted needs of the community through the end of the design period.

7.4 Wastewater characteristics

Measured data characterizing the quality of wastewater in the influent and at key locations throughout the plant are extremely important for designing biological nutrient removal processes. Mathematical models depend on accurate data to predict the performance of various treatment scenarios. The phrase “garbage in, garbage out (GIGO)” is very appropriate here – model predictions are only as good as the data on which they are based. As will be explained further in Chapter 10, one of the key benefits of modeling is the ability to simulate variations in wastewater flow and characteristics and thus, produce a “tighter” design with lower process safety factors, saving on capital and operations costs. Tight designs with low safety factors are highly dependent on good quality data. To address the importance of wastewater characterization, the basic guidance on data collection in Section 7.4.1 is followed by recommended steps for data verification in Section 7.4.2.

It is very important to note that characterization of influent flow rates and mass loading of contaminants go hand in hand. A common error in design is to assume that nutrient loadings are independent of flow rate variability, which is not the case in systems that receive any I&I or storm water flow. Conversely, nutrient loadings from domestic sources often vary diurnally and can be greatest during periods of high flows. As noted throughout this document, return streams can discharge high nutrient concentrations to the head of the treatment plant

7.4.1 Data Collection

Which data are typically available from the plant?

Plants routinely measure flow and wastewater quality to aid in basic operating decisions and to ensure regulatory compliance. Most maintain historical data in electronic format such as spreadsheets, databases, or, in the case of small systems, handwritten log sheets. Daily composites or grab samples of the influent and effluent are typically available from plant personnel for the following parameters (Melcer et al. 2003): Biochemical Oxygen Demand (BOD)¹, Total Suspended Solids (TSS), mixed liquor suspended solids (MLSS), ammonia and/or Total Kjeldahl Nitrogen (TKN), nitrate, and phosphorus (sometimes only ortho-phosphorus).

Designers should start by obtaining as much historical data as possible from the wastewater utility. When working with large plants with electronic records, designers should obtain as many as **8 to 10 years** of historical data to help identify annual trends and eliminate data anomalies and errors. It is important, however, to only include data from time periods that represent current conditions. Dates of major plant configuration or operating changes should be discussed with plant operators and considered when reviewing historical data. Sudden changes in influent conditions could also represent addition or removal of a major industry or a change in laboratories.

¹ For the purposes of this design manual “BOD” represents the 5-day BOD measurement method (sometimes referred to as BOD₅) unless otherwise noted.

What additional data are needed for modeling nutrient removal processes?

In general, the following data are needed to model nutrient removal processes:

- 1) Average values for the following parameters in the treatment plant influent, primary effluent, and secondary effluent.
 - Chemical oxygen demand (COD) – COD is used instead of BOD to model organic substrate; see the text box in this section for further explanation. If the
 - Total suspended solids (TSS)
 - Volatile suspended solids (VSS)
 - Total Kjeldahl Nitrogen (TKN, which is the sum of organic and ammonia nitrogen)
 - Ammonia-nitrogen (NH₄-N, NH₃-N)
 - Nitrate-nitrogen (NO₃-N)
 - Total phosphorus (TP)
 - Orthophosphate (OP)
 - Alkalinity
 - Temperature
 - pH – spot samples. Average of samples is meaningless
- 2) Diurnal influent loading patterns for COD, ammonia, and phosphate are also very important for both steady state and dynamic modeling.

Data should represent **normal dry-weather operating conditions** and be based on several years of historical data.

In most cases, historical data are insufficient to meet design objectives for nutrient removal. If time and funding allow, measurement campaigns, also called “special sampling,” can be conducted early in the process before calibration begins. This step is recommended if key data are missing or if designers do not have confidence in existing data (e.g., grab sampling locations are not representative, historical data do not match expected values). The duration of a typical measurement campaign is 1 to 2 weeks. 24-hour composite samples should be collected from well-mixed locations representing influent flow, primary effluent, and secondary effluent and analyzed for key parameters such as COD², BOD, VSS, TSS, ammonia, nitrate, phosphate, alkalinity, and pH. Designers should consider supplemental sampling of the influent to obtain diurnal profiles (e.g., hourly grab samples for 24 to 48 hours measuring COD, ammonia, and phosphate). Special sampling of operating parameters could include spot checks of dissolved oxygen (DO) concentrations in aerated zones, daily grab samples of mixed liquor, monitoring of RAS recycle rate and concentration, and sampling to characterize side streams (Melcer et al. 2003). Where ample historical BOD information and no COD data are available, designers should try to establish a relationship between the COD and BOD for raw and settled wastewater. See the text box at the end of this section for guidance on estimating COD if only BOD data are available.

Total cost of a 2-week composite sampling campaign is estimated to be about **\$20,000** (Takacs 2009)

² Laboratory analysis for COD should be done as soon as possible after sample collection to minimize possible errors introduced by preservation techniques (Takacs 2009).

Why do mathematical models use COD instead of BOD to represent organic material?

To explain why COD is the recommended measurement for organic material in wastewater, it is useful to first provide a review of the way in which microorganisms consume organics.

Microorganisms use organic substrate in two ways.

- (1) They oxidize it to CO₂ and water to provide energy for maintaining existing cell mass. This is accomplished by transferring electrons from the organic substrate to a terminal electron acceptor (oxygen, or in the case of anoxic conditions, nitrate). Under substrate limiting conditions, which are typical for activated sludge systems, microorganisms use a relatively fixed percentage of organic substrate, expressed as COD, for the cell maintenance process.
- (2) They convert organic material to new cell mass using the energy generated through oxidation, as described in item (1) above.

COD measures the amount of an oxidant that reacts with a sample under controlled conditions. Because each mole of oxygen accepts four electron equivalents, the COD measurement of oxidant demand is a direct measure of the electron donating potential of a sample. From the electron donating potential, it is possible to quantify the amount of COD and oxygen consumed and the amount of sludge produced.

The BOD measurement method has several limitations. It only accounts for the carbonaceous material that is used for energy, not organic material converted to new cell mass. Most BOD measurements are based on a testing duration of 5 days (BOD₅) which only accounts for the amount that reacts within a five-day period and not all the available carbon. Depending on how rapid the oxidation rates are, two different wastewater samples may have the same ultimate BOD but different BOD₅ concentrations.

Total organic carbon (TOC) could be used to represent carbon; however, because models account for reactions based on the electrons transferred and not the moles of carbon, it would be difficult to track the reactions based on TOC.

Measuring COD at various locations in the wastewater plant allows for a mass balance. COD entering the system must equal the sum of (1) COD in the effluent, (2) COD of the wasted sludge, and (3) oxygen consumed in utilization of organic material.

For more information: See Melcer et al. (2003), Appendix B; APHA, AWWA, and WEF (2005).

What if the plant does not have COD data? This is a common problem. Many plants measure BOD instead of COD because the BOD method has been used for a long time and is often the basis for regulatory compliance. If COD measurements are not available, COD can be approximated by establishing the ratio of COD/BOD or COD/VSS. While some mathematical models may take BOD as the input, it is still necessary to adjust the COD fractions for good correlation.

Although measured values of BOD, COD, and VSS in the plant influent vary greatly, the ratios are generally consistent for a specific wastewater. COD/BOD ratios are typically 1.9 to 2.2, with the higher ratios for relatively fresh wastewater. COD/ VSS should range from 1.42 to 1.48 mg COD per mg MLVSS. Estimating the ratio of COD/BOD is more common than COD/VSS.

To determine the COD:BOD ratio for a specific wastewater:

- Collect several samples (10 to 20 are recommended) of influent wastewater. The samples should be representative of total influent flow and taken at different times of the day at low and high influent flow rate.
- Split the samples, taking care to homogenize them thoroughly.
- Analyze each sample for COD and BOD. Use the same method for BOD that is used for the available plant data. (BOD₅ is most common, although some plants will have cBOD₅ data.)
- Determine the average COD:BOD ratio for all samples.
- Repeat the test with primary effluent

Designers can then apply this ratio to historical BOD data to determine COD.

Limitations in funds and time, however, often render extensive measurement campaigns impractical. Melcer et al. (2003) recommends an iterative, or “tiered” approach whereby the model is first run using historical data. Additional data needs are determined based on the accuracy of mass balances and other calibration checks. See Chapter 10 for detailed guidance on model calibration using this recommended iterative approach.

7.4.2 Data Verification

The designer should perform a number of data review and verification steps **before making calculations or entering data into the model**. In the simplest terms, designers should critically evaluate the data to answer the questions, “do the data make sense?” and “do they follow expected engineering principles?” Below is a recommended 4-step process for reviewing and verifying data. Chapter 10 provides additional recommended data verification steps for organic substrate, nutrient fractions, and kinetic/stoichiometric parameters, respectively. Additional mass balances and calibration checks are recommended in Chapter 10 of this design manual.

Step 1: Review data for anomalies.

- Conduct statistical analyses to determine average, median, minimum, and maximum values. Look for obvious outliers that could be a result of data entry error (e.g., a parameter different than comparable measurements by a factor of 10 could be an error in decimal placement).
- Plot historical data over time to evaluate trends. Extreme changes in readings or flat data could indicate sensor problems.

Step 2: Review sampling locations and collection procedures.

- Permanent instrumentation should represent the process and should be in a well-mixed sampling location.
- Check locations of flow meters—are separate flow meters installed for each train? If not, how is split estimated?
- Check location of grab sample collection—sometimes a convenient place to sample from a basin is not representative of the water quality in that basin.

Example 1: Improper Sampling of Primary Effluent.

An automated flow-proportional composite sampling device was drawing sample aliquots from near the bottom of a primary effluent channel. The primary effluent channel was not well mixed and thus, the sampling device was drawing an unrepresentative amount of particulate matter. A second problem existed with the sampling device itself. The vacuum used to withdraw and transport the sample from the primary effluent channel to the sample container caused the volatile portion of the organic matter to dissipate as it entered the receiving vessel (Melcer et al. 2003).

Step 3: Review analytical procedures.

- Check that samples are analyzed using approved standard methods.
- Check the method for determining BOD. Because modeling experience is based on relationships between COD and BOD, all data should be from the 5-day BOD test (also referred to as BOD₅), not ultimate BOD. Check if BOD is in the form of carbonaceous BOD (cBOD). Plant managers are more often monitoring and reporting cBOD instead of BOD to be consistent with state permit limits. The standard method for cBOD requires the addition of an inhibitor to prevent nitrification that would otherwise register as BOD. There is evidence that some of the organic reactions are also inhibited, leading to artificially low cBOD values (Albertson 1995). Others (Baird et al. 2002) maintain that there is no inhibition of BOD but, instead, there are more nitrifiers in raw wastewater than usually assumed, leading to an apparent inhibition of BOD. To check, determine the COD/BOD ratio if COD data are available. The ratio should be between 1.9 and 2.2. COD/BOD ratios higher than 2.2 may indicate inhibition for cBOD data or could result from excessive particulate matter from industries. Some designers have corrected this by adjusting cBOD data upward by 10 to 15 percent for domestic wastewater.

- Check the method for COD determination. Mercuric sulfate (HgSO_4) must be added to counter the influence of chlorides, and silver sulphate (Ag_2SO_4) is required as a catalyst to facilitate for the oxidation of some organic matter such as VFAs. These chemicals are hazardous and must be disposed of following regulations. The use of mercury salts is necessary when chloride is a factor in COD, but can be omitted in instances where the contribution of chloride to COD is negligible. When using historical COD values, check to see whether these chemicals were used. COD/BOD ratios should be as expected (see Step 4). See *Standard Methods for the Examination of Water and Wastewater* (APHA, AWWA, and WEF 2005) for more information about methods 5220A through D.

Example 2: Significant Observed Differences in COD in Split Samples

Latimer et al. (2007) reported several cases of questionable wastewater characterization data. In one instance, large differences in COD concentration were observed between split samples analyzed on-site and at an approved commercial laboratory. Although both used EPA approved methods and typical QA/QC procedures, the laboratory results were on average approximately 30 percent less than plant values. This discrepancy persisted even after efforts to ensure proper sampling, preservation, and homogenizing of the sample prior to splitting. The only explanation provided by the laboratory was that the method gave different results depending on the way the vial was turned in the instrument. This example underscores the importance of following the manufacturer's instructions with respect to homogenization of samples and to the correct orientation of vials in the spectrophotometer. There are many cases similar to this example, and if the COD information looks suspect when modeling, consider that the method used to determine it may be at fault.

- Check the size of the filter used to differentiate between TSS and DSS (typically 1.2 to 1.5 μm glass fiber filters should be used). This becomes important when evaluating fractions.
- Check that operators used appropriate sample preservation and storage techniques and met maximum allowable holding times.
- Check the quality assurance procedures. Are duplicates and blanks regularly sent to the laboratory?
- Check that sensors and other measurement equipment are regularly calibrated. For example,
 - Most TSS meters should be calibrated at least weekly.
 - If membrane electrodes are used for DO measurement, they should be replaced at least quarterly.

See Chapter 13 on instrumentation and controls for additional recommendations.

Example 3: Error in Calculation of Totalized Flow

At one treatment plant, comparison of instantaneous flow measurements to totalized flow showed large differences. An investigation revealed that the programmable logic controller (PLC) calculating the total flow contained an error, resulting in an underestimate of total plant inflow of approximately 25 percent (Third et al. 2006). In another instance, the flow meter was metering only one of two parallel streams. The PLC would multiply this by a factor of two for total plant flow. However, for the first several years, only one of the two flow trains was used and the flow was reported at double the actual flow.

Step 4: Compare measured ratios to typical values for domestic wastewater.

- COD/BOD: The COD/BOD ratio for influent wastewater that has a low detention time in the collection system (i.e., fresh wastewater) should be 2.2 or higher. Wastewater that travels through fairly flat collection lines and/or force mains ferments, which increases the BOD₅ but not the ultimate BOD and thus reduces the COD/ BOD ratio to around 2.0 or less. The COD/ BOD ratio will be higher when the VSS/ BOD ratio is higher.
- COD/VSS ratio: This ratio should be 1.42 to 1.48 mg COD per mg MLVSS.
- VSS/TSS ratio: This ratio should be on the order of 0.75 mg VSS/TSS for municipal wastewater and 0.83 mg VSS/TSS for primary effluent.
- COD/TKN ratio: Although TKN and COD concentrations vary in the plant influent, the ratio should be fairly constant. For raw domestic wastewater, the ratio varies from approximately 9.5 to 12.
- The COD/TP ratio: Values should range from 35 to 60.
- TKN/VSS ratio: This ratio should vary between 0.08 and 0.1 for mixed liquor VSS but may vary much more for raw domestic wastewater.
- Sludge generation (measured as mass VSS or TSS generated) per mass COD or BOD in influent: Check against similar plants with similar SRTs. Figure 7-1, which shows sludge production with and without primary treatment for different temperatures and SRTs, can be used as a guide.
- The TSS and BOD concentrations should be within 10 percent.

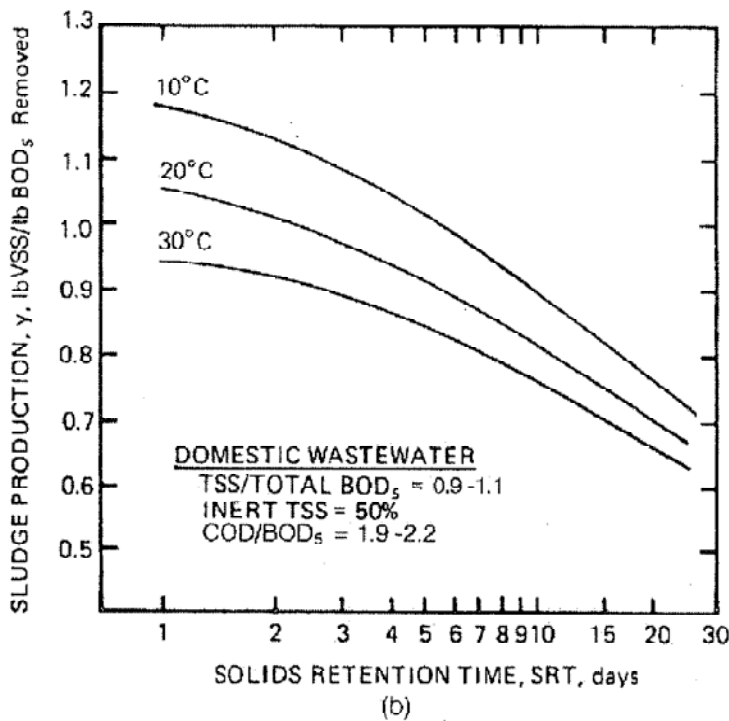
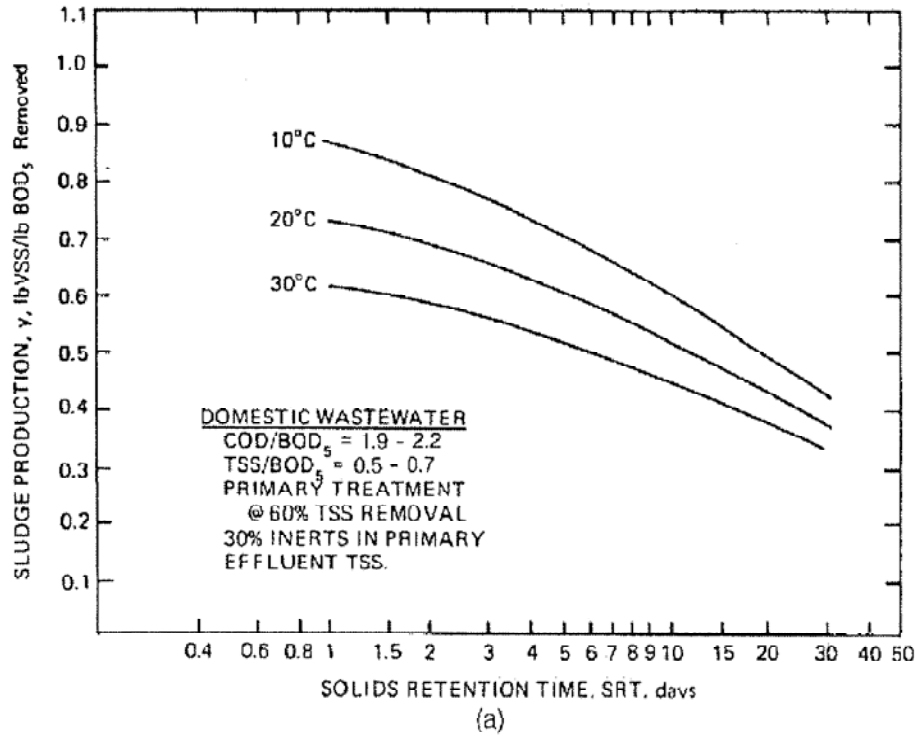

Figure 7-1. Net sludge production versus solids retention time and temperature (a) with primary treatment and (b) without primary treatment (lb/lb = kg/kg).

Source: WEF and ASCE 1998, Figure 11.7, p. 11-20. Reprinted with permission from Design of Municipal Wastewater Treatment Plants - MOP 8, 4th Edition, Copyright ©1998, Water Environment Federation and American Society of Civil Engineers, Alexandria, VA. www.wef.org

7.5 Target Effluent Concentrations for Total Nitrogen and Total Phosphorus

Plants should base their target effluent concentrations for total nitrogen (TN), and total phosphorus (TP) on the following:

- Nutrient limits in National Pollutant Discharge Elimination System (NPDES) permits including numeric limit and averaging period requirements
- An overall process design factor

In other words, the design value should be below the permitted value to provide a margin of safety. Issues related to NPDES permit limits are discussed in this section. Application of an overall process design factor (i.e., safety factor) is addressed in Section 7.9

NPDES permits are set on a 5-year cycle. Historically, NPDES permits sometimes included an effluent limit for ammonia-nitrogen but not TN or TP. Permits that included total nutrient limits often set maximum allowable values of 10 mg/L for TN and 1.0 mg/L for TP. Recognizing the harmful effects of eutrophication of the nation's waterways due to excessive nutrient loadings (see Chapter 2, Section 2.4 of this manual for a complete discussion), regulatory agencies have started setting lower nutrient limits in NPDES permits. TN limitations of 5.0 or 3.0 mg/L and TP limits of 0.5 and even 0.1 mg/L or less are becoming much more common.

Particularly in western portions of the country, nutrient-related water quality problems can occur on a seasonal basis. As a result, water quality-based effluent limitations for nutrients usually apply only during the "critical period." This period routinely occurs from late spring through early fall when stream flows are low and temperatures are warm.

The averaging period for the permit limits is an extremely important factor in selecting technologies, establishing design parameters, and operating plants for nutrient control. The following approaches to limiting effluent nitrogen and phosphorus have been used in NPDES permits, either alone or in combination:

- Annual average
- Quarterly average
- Maximum month
- Maximum week
- Maximum day
- Seasonal average

Table 7-4 provides several examples of NPDES permit limits for nutrients as presented during a 2008 workshop on nutrient removal. Other examples can be found in state records and throughout the related literature, and individual NPDES permits and fact sheets can be accessed through Envirofacts. Visit the EPA webpage <http://cfpub.epa.gov/npdes/permitissuance/permitscanning.cfm> for more information.

Table 7-4. Example Permit Limits for Nutrients

WWTP		Ann. Avg. Flow (MGD)	TN Limits		TP Limits		Citation
Name	Location		mg/L	Lbs/day	mg/L	Lbs/day	
Truckee Meadows Water Reclamation Facility	Reno, NV		2.0 daily max for nitrate	500	0.4 30-day avg	134	Gray 2008
River Oaks Advanced Wastewater Treatment Plant	Tampa, FL	10	6.00 daily max 4.50 wkly avg 3.75 monthly avg 3.00 annual avg		2.00 daily max 1.50 wkly avg 1.25 monthly avg 1.00 annual avg		Phillips 2008
Fiesta Village Advanced Wastewater Treatment Plant	Fort Myers, FL	5	6.0 single sample 4.5 wkly avg 3.0 monthly avg 3.0 annual avg		1.0 single sample 0.75 wkly avg 0.50 monthly avg 0.50 annual avg		Meyer 2008
Orange County Eastern Water Reclamation Facility	Orlando, FL	17.3	6.0 wkly avg 5.0 monthly avg 3.0 annual avg		2.4 weekly avg 2.0 monthly avg 1.0 annual avg		Madhanagopal 2008
Parkway Wastewater Treatment Plant	Laurel, MD	5.5 – 6	7.0 monthly avg and 11.0 wkly avg between 4/1 and 10/15		1.5 weekly avg 1.0 monthly avg		Selock 2008
Clark County Water Reclamation District	Las Vegas, NV	110	0.6 mg/L as ammonia	511 as ammonia	0.2 mg/L	176	Drury 2008
Rock Creek Advanced Wastewater Treatment Facility	Washington County, OR	30 (dry weather)	None provided		0.10 mg/L monthly median		Spani 2008
Blue Plains Advanced Wastewater Treatment Facility	Washington, DC	370 (dry weather)	7.5 annual avg changing to 4.2 annual avg in future		0.35 monthly avg 0.18 weekly avg		Baily 2008

Source: WEFTEC Technical Education Workshop No. 101: WEF/WERF: Demonstrated Processes for Limit of Technology Nutrient Removal: Achievable Limits and Statistical Reliability. Chicago, IL. October, 2008.

7.6 Goals for Reliability, Sustainability, and Process Flexibility

Reliability is the capability of a treatment process to perform its intended function without failure or interruption of treatment such as during floods, power failures, or in the event of equipment failure. Reliability goals of a nutrient removal process should depend on the permit limits and averaging period. The most common safety factor is to design for maximum month loadings. Reliability is more important and may necessitate larger safety factors if the average period is daily or weekly. Monthly, seasonal or yearly permit levels provide some degree of flexibility for unforeseen events without exceeding the permit level. See Chapter 6, Section 6.7 for additional discussion on reliability of technologies and effluent limits.

It is common for states to require that treatment components be designed to treat the average daily design flow with the largest unit out of service. Ten State Standards (2004) requires that all plants be provided with an alternative source of electric power or pumping capacity to allow continuity of operations during power failures. Methods of providing alternative power include connecting to at least two independent power sources and using backup power generators. Spare parts should be kept on site to ensure continuous nutrient removal capabilities, and equipment should be accessible for repairs.

Designers should strongly consider incorporating online instrumentation and controls into design. Online instrumentation can provide rapid feedback compared to grab sampling and enable operators to respond more quickly to environmental changes, thereby maintaining nutrient removal to desired levels. Automated control can significantly reduce workload while at the same time improving control of process parameters—thus improving treatment plant performance, often at reduced energy costs. Automated control is highly recommended for plants trying to achieve low effluent nutrient levels (e.g., TN < 3 mg/L or TP < 0.1 mg/L). See Chapter 13 of this manual for guidance on online instrumentation and controls.

Sustainability implies a simultaneous focus on economic, social, and environmental performance (USEPA 2008). One growing area of focus in recent years is the inter-relationship among water, energy, and greenhouse gas emissions. In its recently published document *Ensuring a Sustainable Future: An Energy Management Guidebook for Wastewater and Water Utilities*, EPA notes that energy management is at the heart of efforts to ensure sustainability for utilities (USEPA 2008b). When considering upgrades and retrofits to existing WWTPs for the purposes of removing nutrients, designers should work with owners to identify sustainability goals such as minimizing energy use, resource recovery, and reducing greenhouse gas emissions.

Flexibility in design can help address uncertainties in future conditions. For example, the design should include the flexibility to increase its treatment capacity if owners and regulators suspect that nutrient limits will decrease in the future based on new watershed analyses and the setting of numeric water quality criteria. Similarly, the design should address the elements of uncertainty in population projections and assumptions regarding the industrial and commercial components of wastewater. The changes in influent flow as a result of water conservation have been studied (AWWARF 1999) but are very area-specific. One method to address uncertainty in the design includes dividing projects into several phases to ease the financial burden on wastewater utilities. This phased approach also reduces uncertainty by meeting shorter-term design objectives first rather than constructing facilities to meet projected criteria through the end of a 20-year planning period. Turndown capacity of blowers has been found to be critical in the design of energy-efficient aeration systems and often compensates for protective design assumptions. WEF (2009) recommends a minimum turndown ratio of 5:1. Multiple blowers of more than one size also may be installed so that blowers can be turned off when possible. Automation of turnoffs has proven to improve energy efficiency.

Operational flexibility is often needed to remove nutrients to low levels in areas with significant cold weather periods. Such flexibility may also be advantageous for plants with highly variable influent flow and no flow equalization. One way to build operational flexibility into design is to include swing zones. Swing zones can be located between the anaerobic and anoxic zones, the anaerobic and aerobic zones, or the anoxic and aerobic zones depending upon the secondary processes selected (USEPA 2008). For example, a swing zone between the anoxic and aerobic zone would contain both mixers and diffusers. If more SRT were required for nitrification (e.g., during winter months), the diffusers could be

operated. During warmer months, the diffusers could be turned off to create anaerobic conditions and promote phosphorus removal.

Example 1: Successful Use of Swing Zones to Remove Phosphorus under Changing Conditions.

Jackson et al. (2007) report successful use of swing zones to provide phosphorus removal at a 5 MGD plant at The Colony, Texas. Based on new total nitrogen permit limits, the plant operation team had decided to retrofit their existing activated sludge process with an Integrated Fixed-Film Activated Sludge (IFAS) system and modify their existing contact stabilization process for plug flow. After the design was finalized and construction was about to begin, the team learned of a pending revision of their phosphorus effluent limit to 1 mg/L. The design was modified to include two anaerobic swing zones containing both coarse air diffusers and mixer systems. The authors report success in achieving both nitrogen and phosphorus removal by operating the zone anaerobically in all but the coldest months.

Safety and security are important considerations for any upgrade project. All new structures should be enclosed and should have signs discouraging entry of anyone but authorized personnel. Handrails and guardrails should be installed around tanks, trenches, pits, and other hazardous structures. Warning signs should be appropriately placed, and adequate ventilation should be provided. Designers should work with plant owners and other stakeholders to determine if additional security features such as lights, motion detectors, and cameras are needed.

7.7 Sludge Treatment Options

Both the quantity and quality of the sludge produced should be considered when establishing design criteria for nutrient removal processes. Biological nitrogen and phosphorus removal processes do not generally produce additional sludge quantities. In fact, in the case of nitrogen removal operated without the addition of an external carbon source, the biological nutrient removal processes will lower sludge quantities. The addition of chemical treatment for phosphorus removal, however, always produces additional sludge due to the generation of metal or calcium and phosphorus precipitates.

The addition of nutrient removal changes the sludge composition, which in turn can change the thickening and dewatering properties. Nitrogen and/or phosphorus removal can improve thickening characteristics due to decreased amounts of filamentous bacteria in the activated sludge. Sludge from biological phosphorus removal processes will contain additional phosphorus, but will otherwise be similar to sludge produced by conventional activated sludge systems. Sludge settling and dewatering characteristics are generally the same or improved. Potential issues include phosphorus release and struvite precipitation under anaerobic processing conditions. See Chapters 4 and 5 of this manual for additional discussions of the effects of nitrogen and phosphorus removal, respectively, on sludge handling.

7.8 Site Constraints

Site constraints can be a driving factor in selecting a nutrient removal technology. Particularly for larger WWTPs in urban areas, space can be limited. Attached growth and hybrid systems such as IFAS and moving bed bioreactors (MBBRs) can achieve nutrient removal in smaller footprints and can

often be used to retrofit an existing basin without increasing the footprint at all. Chapter 6 and Chapter 8 provide additional discussion of footprint requirements for nutrient removal technologies.

Odor can be a serious issue for WWTPs, particularly those in urban areas. Designers should always consider how a plant upgrade or retrofit for nutrient removal will impact the release of odors at the plant. Containment (e.g., covering of treatment units) and treatment of captured gas should be considered for each process upgrade. For example, the addition of fermentation to produce substrate for biological phosphorus removal can produce significant odors. For this reason, sludge thickeners for fermentation should be covered and the head space scrubbed to control odors. Many retrofits for biological nutrient removal, however, do not increase odors. For example, the addition of anaerobic zones for biological phosphorus removal does not increase odors because of the continuous addition of oxidized activated sludge to the zone and also because volatile compounds such as H₂S and volatile fatty acids (VFAs) are not being stripped and the VFAs are used by the phosphate accumulating organisms.

Because improvements to WWTPs directly impact the community, the public should be brought into the process as early as possible to educate them on the need for treatment changes and to obtain their support. Designers and owners should consider the following options for public involvement (WEF 2005):

- Schedule a public meeting at the beginning of the planning process to identify major issues. Schedule additional meetings throughout planning, design, and construction.
- Consider low-cost improvements such as tree planting and improved storm drainage to gain public support.
- Establish a citizen's advisory group for large projects.
- Develop procedures for dealing with public complaints.
- Communicate with the public regularly through flyers, newsletters, and interviews on local news stations. Regularly post project updates including pictures on the utility website.

7.9 Selecting an Overall Process Design Factor

Engineers routinely apply safety factors during design, particularly for sizing of basins and other capital equipment, to account for uncertainties in predicted conditions and technology performance. For design of nutrient removal systems, relevant uncertainties are:

- Variations in predicted influent flow rates and contaminant loadings.
- Uncertainty in predicted treatment performance (often driven by uncertainty in biokinetic parameters).
- Variability in mechanical equipment.

As uncertainty in each of these factors increases, so does the safety factor. Note, however, that in addition to inefficiencies in operation, oversized units also can result in reduced performance of

biological nutrient removal systems, particularly those that include enhanced biological phosphorus removal. For such system, the best safety factor is multiple trains rather than larger reactors. Then trains can be taken on or off line to maintain near optimum performance. Additional time spent early in the design process to carefully evaluate data and predict conditions throughout the design period can allow for the use of a smaller factor and save money in construction costs.

Safety factors are highly dependent on the extent of data collection, calibration, and type of process simulation modeling performed for the project. As confidence with model parameters increase, the size of the safety factor decreases. One major advantage of dynamic modeling is its ability to simulate a number of different future conditions and thus, enable the use of lower safety factors. See Chapter 10 for additional discussion.

7.10 References

- Bailey, W. 2008. Manager's Perspective on Multiple Step Chemical Addition (Blue Plains) for Low P. Presented at WEFTEC Technical Education Workshop No. 101, Demonstrated Processes for Limit of Technology Nutrient Removal: Achievable Limits and Statistical Reliability. WEF/WERF Chicago, IL. October, 2008.
- Bratby, J., J. Jimenez, D. Parker. 2008. Dissolved Organic Nitrogen – Is It Significant, and Can it be Removed? Presented at WEFTEC 2008.
- Drury, D. 2008. Manager's Perspective on Following BioP with Tertiary Chemical Removal Steps (Clark County). Presented at WEFTEC Technical Education Workshop No. 101, Demonstrated Processes for Limit of Technology Nutrient Removal: Achievable Limits and Statistical Reliability. WEF/WERF. Chicago, IL. October, 2008.
- Gray, R. 2008. Manager's Perspective on Separate Stage Fixed Film N and DN Processes for LOT (Truckee Meadows Water Reclamation Facility). Presented at WEFTEC Technical Education Workshop No. 101, Demonstrated Processes for Limit of Technology Nutrient Removal: Achievable Limits and Statistical Reliability. WEF/WERF. Chicago, IL. October, 2008.
- Jackson, D.R., L.E. Ripley, T. Maurina, and S. Hubbell. 2007. Up to the Challenge : IFAS Helps Growing Texas City Meet Discharge Limits, Expand Capacity. *Water Environment & Technology*. 19(11): 50-54.
- Jeyanayagam, S. and I. Venner. 2007. Wastewater Process Design with Energy Savings in Mind. *Florida Water Resources Journal*. January, PP. 28-33.
- Konen, T. P. 1995. Water Use and Efficiency Under the U.S. Energy Policy Act. Stevens Institute of Technology, Building Technology Research Laboratory. Hoboken, NJ.
- Lancaster, C.D. and J.E. Madden. Not So Fast! The Impact of Recalcitrant Phosphorus on the Ability to Meet Low Phosphorus Limits. Presented at WEFTEC 2008.
- Leenheer, J., A. Dotson, and P. Westerhoff. 2006. Dissolved Organic Nitrogen Fractionation. *Annals of Environmental Science*, Vol 1, 45-56.

- Madhanagopal, T. 2008. Manager's Perspective of a Combined Process (5-Stage Bardenpho) Process for LOW N (Eastern Water Reclamation Facility) – Moderate Climate. Presented at WEFTEC Technical Education Workshop No. 101, Demonstrated Processes for Limit of Technology Nutrient Removal: Achievable Limits and Statistical Reliability. WEF/WERF. Chicago, IL. October, 2008.
- Mayer, P.W., W.B. DeOreo, E.M. Opitz, J.C. Kiefer, W.Y. Davis, and B. Dziegielewski. 1999. Residential End Uses of Water. AWWA and AWWA Research Foundation.
- Melcer, H., P.L. Dold, R.M. Jones, C.M. Bye, I. Takacs, H.D. Stensel, A.W. Wilson, P. Sun, and S. Bury. 2003. Methods for Wastewater Characterization in Activated Sludge Modeling. WERF Final Report. Project 99-WWF-3.
- Meyer, J. 2008. Manager's Perspective on Following Separate Stage Nitrification with Fixed Film Systems for Low N (Fiesta Village). Presented at WEFTEC Technical Education Workshop No. 101, Demonstrated Processes for Limit of Technology Nutrient Removal: Achievable Limits and Statistical Reliability. WEF/WERF. Chicago, IL. October, 2008.
- Mulholland, M.R., N.G. Love, D.A. Bronk, V. Pattarkine, A. Pramanik, and H.D. Stensel. 2009. Establishing a Research Agenda for Assessing the Bioavailability of Wastewater Treatment Plant-Derived Effluent Organic Nitrogen in Treatment Systems and Receiving Waters. February 27.
- Mulholland, M.R., N.G. Love, V.M. Pattarkine, D.A. Bronk, and E. Canuel. 2007. Bioavailability of Organic Nitrogen from Treated Wastewater. STAC Publication 07-001. Available online: www.chesapeake.org.
- Pagilla, K. (2007) *Presentation at Water Environment Research Foundation and Chesapeake Bay Science and Technology Advisory Committee Workshop*, Baltimore, MD, September 27/28, 2007
- Pehlivanoglu-Mantas, E. and D.L. Sedlak. 2006. Wastewater-Derived Dissolved Organic Nitrogen: Analytical Methods, Characterization, and Effects - A Review. *Critical Reviews in Environmental Science and Technology*. 36:261-285.
- Phillips, D. 2008. Manager's Perspective on Separate Stage Suspended Growth N and DN Processes for LOT (River Oaks). Presented at WEFTEC Technical Education Workshop No. 101, Demonstrated Processes for Limit of Technology Nutrient Removal: Achievable Limits and Statistical Reliability. WEF/WERF. Chicago, IL. October, 2008.
- Sattayatewa, C. and K. Pagilla. 2008. Nitrogen Species Measurement in Low Total Nitrogen Effluents. Presented at WEFTEC 2008.
- Sedlak, D. 2007. The Chemistry of Organic Nitrogen in Wastewater Effluent: What It Is, What It Was, and What it Shall Be. Presentation at the STAC-WERF Workshop: Establishing a Research Agenda for Assessing the Bioavailability of Wastewater-Derived Organic Nitrogen in Treatment Systems and Receiving Waters. Baltimore, MD, September, 28, 2007.

- Sedlak, D.L. and E. Pehlivanoglu. (2007) rDON fate and availability to nitrogen-limited algae. *Presentation at Water Environment Research Foundation and Chesapeake Bay Science and Technology Advisory Committee Workshop*, Baltimore, MD, September 27/28, 2007
- Selock, K. 2008. Manager's Perspective of a Combined Process (5-Stage Bardenpho) Process for LOW N – Severe Climate (Parkway WWTP). Presented at WEFTEC Technical Education Workshop No. 101, Demonstrated Processes for Limit of Technology Nutrient Removal: Achievable Limits and Statistical Reliability. WEF/WERF. Chicago, IL. October, 2008.
- Spani, C. 2008. Manager's Perspective on Multiple Step Chemical Addition (Rock Creek) for Low P. Presented at WEFTEC Technical Education Workshop No. 101, Demonstrated Processes for Limit of Technology Nutrient Removal: Achievable Limits and Statistical Reliability. WEF/WERF. Chicago, IL. October, 2008.
- STAC-WERF. 2007. Workshop Considerations and Presentations. Establishing a Research Agenda for Assessing the Bioavailability of Wastewater-Derived Organic Nitrogen in Treatment Systems and Receiving Waters, Baltimore, MD, September, 28, 2007.
- Takács, I. 2009. Modeling 101, How Do Influent Characteristics Affect Model Outputs? Presented at Modeling 101 - How to Use Simulators in the Design and Operation of Wastewater Treatment Facilities. WEF® Distance Learning Webcast Series. Modeling Expert Group of the Americas. February 25, 2009.
- Tchobanoglous, G., F. L. Burton, and H.D. Stensel. 2003. *Wastewater Engineering: Treatment and Reuse*. New York, NY: McGraw-Hill.
- Ten States Standards. 2004. *Recommended Standards for Water Works, 2007 Edition: Policies for the Review and Approval of Plans and Specifications for Public Water Supplies*. Water Supply Committee of the Great Lakes - Upper Mississippi River Board of State and Provincial Public Health and Environmental Managers. Available online: <http://10statesstandards.com/waterstandards.html>
- USEPA. 2002. *Onsite Wastewater Treatment Systems Manual*. Office of Water and Office of Research and Development. EPA/625/R-00/008. Available online: <http://www.epa.gov/nrmrl/pubs/625r00008/html/625R00008.htm>
- USEPA. 2008a. *Municipal Nutrient Removal Technologies Reference Document*. Office of Wastewater Management, Municipal Support Division. EPA 832-R-08-006. Available online: <http://www.epa.gov/OWM/mtb/publications.htm>
- USEPA. 2008b. *Ensuring a Sustainable Future: An Energy Management Guidebook for Wastewater and Water Utilities*. January. Available online: http://www.epa.gov/waterinfrastructure/pdfs/guidebook_si_energymangement.pdf
- USEPA. 2009. Accessing Individual NPDES Permits and Fact Sheets through Envirofacts. National Pollutant Discharge Elimination System (NPDES). Website updated 13 February 2009. Website Accessed 29 April 2009. Available online: <http://cfpub.epa.gov/npdes/permitissuance/permitscanning.cfm>

- VA DEQ. 2004. Chapter 790. Sewage Collection and Treatment Regulations. Commonwealth of Virginia, State Water Control Board. 9 VAC 25-790. Available online:
http://www.deq.state.va.us/export/sites/default/wastewater/pdf/DEQ_SCAT_Reg.pdf
- WEF. 2005. *Upgrading and Retrofitting Water and Wastewater Treatment Plants*. Water Environment Federation Manual of Practice, No. 28. Alexandria, VA: WEFPress.
- WEF. 2009. Running An Energy-Efficient Wastewater Utility - Modifications That Can Improve Your Bottom Line. WEF® Distance Learning Webcast Series. Moderator: J.C. Cantwell. Webcast presented June 24, 3009.
- WEF and ASCE. 1998. *Design of Municipal Wastewater Treatment Plants - MOP 8, 4th Ed.* Water Environment Federation and American Society of Civil Engineers. Alexandria, VA: WEF.
- WERF. 2008. Dissolved Organic Nitrogen (DON) in Biological Nutrient Removal Wastewater Treatment Processes. H.D. Stensel, Lead Editor. WERF Dissolved Organic Nitrogen Compendium. Available online:
<http://www.werf.org/AM/Template.cfm?Section=Nutrients&CONTENTID=8726&TEMPLATE=/CM/ContentDisplay.cfm>
- Eleuterio, L. and J.B. Neethling. 2009. Low Phosphorus Analytical Measurement Study. Presented at Nutrient Removal 2009. Washington, DC. WEF.
- Wisconsin DNR. 2006. Guidance for Wastewater Treatment Facility, Design Flow Determinations. Available online : <http://dnr.wi.gov/org/water/wm/glwsp/facilities/designflow.htm>. Website updated 28 August 2006. Website Accessed : 29 April 2009.

This page left intentionally blank

8. Selecting Candidate Treatment Processes for Plant Upgrades

Chapter 8 covers:

- 8.1 Introduction
- 8.2 Technology Selection Factors
- 8.3 Advantages and Disadvantages of Technology Types
- 8.4 Overview of Recommended Approach
- 8.5 Recommended Use of Advanced Tools
- 8.6 Patent Issues
- 8.7 References

8.1 Introduction

Selection of candidate treatment processes for plant upgrades is based on many factors including target effluent limits, existing treatment, space available, and operator preference. Selection is more of an art than a science and is influenced by the experiences and preferences of the owner and design engineers. Guidance in Chapters 3 through 7 of this manual provides the basis for technology selection. This chapter summarizes the key factors in selecting candidate treatment processes for removing nitrogen, phosphorus, or both from wastewater.

8.2 Technology Selection Factors

First and foremost, the technology selected for the wastewater treatment plant (WWTP) needs to meet the target effluent limits for nitrogen and phosphorus. See Chapter 7 for guidelines on determining target effluent limits. Chapter 6 provides a discussion of attainable effluent limits for the various nutrient removal technologies. It is noted in Chapter 6 and worth reiterating here that these guidelines are not universal and that attainable nutrient removal is site specific and depends on a number of factors including wastewater characteristics, existing plant configuration, redundancy and reliability of equipment, and operation. This section provides a general discussion of some important factors affecting technology selection.

8.2.1 Seasonal Permit Limits

A seasonal permit limit can have a significant effect on the design criteria and technology selection. As noted in Chapter 7, it is common in arid regions of the country for regulatory agencies to require nitrogen removal only during the warm months, such as from May 1 through October 31. Under this scenario, WWTPs can stop nitrification each fall and restart it in the month of April when temperatures are warmer to bring the plant into compliance by the beginning of May. Another common approach is to base permit limits on annual average values. This approach allows the plant to maximize nitrogen removal during warm months and practice variable removal during the cold months as long as it can meet the annual average value.

Because complete nitrification can be achieved in warmer months using relatively short solids residence times (SRTs), the volumes of biological reactors and secondary clarifiers can be significantly reduced if the plant has a seasonal or annual average permit. Conventional biological nitrogen removal

schemes such as the Modified Ludzack Ettinger (MLE), Anaerobic/Anoxic/Oxic 3 Stage Pho-redox (A2/O), and Virginia Initiative Plant (VIP) processes, rather than advanced removal schemes such as the 4- or 5-stage Bardenpho, hybrid, or fixed film systems, may provide sufficient treatment to meet the seasonal permit conditions. Maintaining lower SRTs is not without operational disadvantages, however, because it increases the amount of waste biomass sludge produced and therefore increases sludge processing and disposal costs. On the positive side, reducing the SRT reduces the amount of energy required for aeration.

There are some advantages to operating under an annual average permit rather than a seasonal permit. It is more difficult to re-establish nitrification in April after it has been completely stopped, which is typical of seasonal permits, than when it has been partially maintained, as is typical of annual average permits. Also, with annual average permits, a specific effluent concentration does not have to be met in May.

It is important to note that biological phosphorus removal systems become more efficient as temperature decreases as long as VFAs do not become limiting and the recycle of electron acceptors (dissolved oxygen and nitrates) to the anaerobic zone is not significant. This is because GAOs, the primary competitors with PAOs for VFAs, depend upon glycolysis, which is more temperature sensitive than the energy generating system of the PAOs. Therefore, as the temperature decreases below 20 °C, the PAOs obtain an increasing fraction of the VFAs in the anaerobic zone, and their population increases relative to the GAOs. Therefore, even though PAO biochemical reactions slow down with temperature, as is typical of all biochemical reactors, performance often improves because of the increase in the PAO population relative to the GAO population.

Permits may require total nitrogen (TN) removal during some parts of the year, but limit only the ammonia to total Kjeldahl nitrogen (TKN) portion at other times of the year. If seasonal denitrification is attempted, the acclimation period required for the biomass with some external carbon sources needs to be accounted for in the operational start-up of denitrification. Providing sufficient time for acclimation is important to assuring that the system is operating for removal when the limits are applied. In some cases, operators using methanol as the carbon source for denitrification continue to feed small doses even when the carbon is not required just to maintain the methanol metabolizing biomass.

8.2.2 Footprint

The space available at the plant for upgrades can be the driving factor for selecting amongst various types of nutrient removal technologies. Technologies requiring large footprints may not be feasible in an urban area with limited space available for expansion.

Conventional nitrogen removal technologies typically have large footprints. If space is limited, there are many alternatives for reducing basin requirements for nitrification and denitrification as outlined in Section 8.4.

The footprint for the additional anaerobic zone for biological phosphorus removal is relatively small, varying from 5 to 15 percent of the total volume. Space may be needed for recycle piping but the piping frequently can be placed inside the existing reactor (which enables the use of low head propeller pumps). In many retrofits, the anaerobic zone can be created in an existing activated sludge basin using baffles.

The footprint for adding chemical feed facilities to precipitate phosphorus is typically small. A new solids removal process (tertiary clarification, effluent filtration) may require a larger footprint. High-rate clarification (HRC) can be used instead of conventional clarification to reduce the footprint size. Examples of patented HRC systems are provided in Chapter 6.

8.2.3 Hydraulic Considerations

Certain processes require additional pressure head, which is supplied by pumps. For example, pumping is typically required for plants with denitrifying filters because sufficient hydraulic head following the aeration basins is not usually available. Pumping is also usually required for effluent filtration. The addition of overflow baffles with different elevations to a treatment system may induce some head losses and require additional pumping. Underflow baffles provide an equal amount of protection against backflows if correctly designed, and do so without headloss.

Membrane bioreactors require additional pumping to force water through the membrane material. Pressure-driven systems are used if the membrane is configured after the aerobic and anoxic basins. Vacuum-driven systems use a pump to pull water through the membrane when it is submerged in a biological reactor.

8.2.4 Chemical Needs

The addition of any commercial chemical requires delivery, storage, and safety procedures in addition to mixing and dosing equipment. Three types of chemicals may be added to wastewater for nutrient removal: metal salts or lime to precipitate phosphorus; an external carbon source for BPR or denitrification; and lime, bicarbonates, or caustic soda to maintain alkalinity.

Metal salts or lime can be added to wastewater to precipitate phosphate and subsequently remove it using a solids separation process. Many plants that are required to meet low effluent total phosphorus (TP) limits that use BPR are incorporating chemical phosphorus removal as a back-up system to ensure that limits can be met in the event of a biological upset. Multiple feed points are also becoming more common.

As noted in the previous section, an external organic carbon source may be needed for BPR or denitrification. Common external sources include methanol, ethanol, and acetic acid, as well as simple sugars.

The nitrification process consumes alkalinity. Although the denitrification process can add alkalinity back to the mixed liquor for single-sludge treatment systems, there is still typically a net loss in alkalinity of 50 percent or more. Alkalinity depletion can result in pH decreases and interfere with biological processes. As previously noted, plants can add alkalinity to maintain adequate levels by adding lime, bicarbonates, or caustic soda to the influent.

8.2.5 Available Sludge Treatment and Options

As noted in Chapter 4 of this manual, less sludge production and better settling and thickening sludge is found for activated sludge systems using anoxic/aerobic treatment for nitrogen removal versus

aerobic treatment only. The impact this will have on total sludge production depends upon how much waste sludge is produced by other treatment units such as primary clarifiers and treatment with precipitating chemicals. As noted in Chapter 5, sludge from BPR processes will have higher phosphorus contents, and therefore a higher settling velocity, but will otherwise be similar to sludge from conventional activated sludge plants.

Additional sludge production is seen as one of the major disadvantages of chemical phosphorus removal compared with biological methods. The volume of additional sludge produced varies depending on the influent phosphorus concentration, chemical application point(s), chemical used, and target effluent limit. Chemically treated sludge has a higher inorganic content compared to primary and activated sludge and will increase the required size of aerobic and anaerobic digesters, as well as dewatering equipment. The use of metal salts can result in increased inorganic salts (salinity) in the sludge and in the effluent. Salinity can create problems when biosolids are land applied or when the effluent is returned to existing water supply reservoirs. Lime traditionally produces a higher sludge volume compared to metal salts because of its reaction with natural alkalinity.

Designers should carefully consider the impacts of sludge processing on nutrient release into recycle streams. Anaerobic digestion can release ammonia and phosphorus in large quantities, resulting in significant recycle loads to the biological nutrient removal (BNR) processes. Anaerobic digestion of BPR sludges also releases magnesium along with the ammonia and phosphorus, resulting in the formation of struvite. This struvite typically remains entrapped in the digested solids and reduces the loads in the liquid stream recycled back to the mainstream processes. Although phosphorus removal by struvite formation is a desirable phenomenon from the perspective of recycle load, struvite crystals can plug centrifuge ports, as well as pumps and pipes used to convey the sludge, if not controlled. However, because of the higher concentrations of magnesium and phosphorus in anaerobic digesters when BPR sludges are digested, most, if not all, of the struvite formation occurs within the sludge and remains with the sludge rather than staying in solution and forming struvite after leaving the digesters.

Innovative work is underway to recover nutrients from sludge (including struvite) and convert them into commercial fertilizers and other products in which they can be reused. See Chapter 14 for discussion of nutrient recovery technologies.

8.2.6 Energy Considerations

Treatment plant upgrades for nutrient removal often require additional energy to operate. If they do not already exist, addition of recycle streams for BNR will require additional pumping energy. Filters likely require additional electricity for pumping to provide the pressure head on the filters. Membranes have the highest pumping cost because they require the most pressure to push the water through the membrane material. The smaller the membrane pore size, the higher the pumping costs. Anaerobic zones, fermenters, and chemical feed pumps usually require a relatively small amount of energy (USEPA 2008a). Although some processes are inherently less energy intensive than others (e.g., oxidation ditch vs nitrifying diffused air activated sludge), energy requirements generally increase with level of treatment. The exception is when a primary anoxic zone is added for denitrification when nitrification is already being practiced. The reduction of biochemical oxygen demand (BOD) in the anoxic zone reduces the amount of energy needed to transfer oxygen in the aerobic zone. If the BNR system is an MLE or an A2/O configuration, the anticipated reduction in aeration energy is commonly about 20 percent. Also, using low head propeller pumps, or equivalent, and nitrate recycle lines that are

internal to the activated sludge basins will significantly reduce pumping energy compared to recycle pump stations.

Energy requirements for nutrient removal can be further minimized by implementing the following (Kang et al. 2009):

- Use of swing zones
- Step aeration in activated sludge basins
- Fermenters for in-plant carbon generation
- Automated control of aeration equipment
- Sidestream treatment
- Flow equalization for recycle flows

Energy required for nutrient removal can also be offset by energy conservation measures (ECMs). ECMs range from no-cost operational improvements such as peak load shaving and optimization of mixing and aeration, to plant upgrades such as pump replacements for more efficient variable frequency drives. Wastewater utilities have an opportunity to be energy generators by using biogas from anaerobic digestion to generate electricity onsite. Many energy efficiency measures have a short payback period for the wastewater utility to realize positive cost benefits.

Implementation of energy efficiency measures begins with benchmarking current performance and conducting an energy audit to identify areas of improvement. EPA has developed guidelines for energy efficiency based on the Plan-Do-Check-Act management system approach to help operators identify, implement, measure, and improve energy efficiency and renewable opportunities at their utilities. For more information and guidance, refer to the document, *Ensuring a Sustainable Future: An Energy Management Guidebook for Wastewater and Water Utilities*, available online at http://www.epa.gov/waterinfrastructure/pdfs/guidebook_si_energymangement.pdf.

8.2.7 Staffing and Training Requirements

A potential disadvantage to some emerging technologies is the amount of training required to operate a non-conventional system. Even though emerging technologies, over the long term, may be less complex than conventional systems, operators may have a preference for a more conventional type system that fits in with the existing technologies. However, many operators like to learn about innovative processes and frequently learn to operate them in ways that overcome design limitations. BNR processes have been operated very well by many operators after a relatively short training period. It is especially important that the operators understand the major operating factors that affect the performance of the BNR system. Automated process control can ease the burden on operators and is recommended for systems targeting very low effluent TN and TP levels.

8.2.8 Technology Selection Considerations for Small Flow Systems

Nutrient removal may be required for very small or decentralized wastewater treatment applications. Unique features of these treatment applications with regard to wastewater characteristics, operations and maintenance capabilities, and water reuse potential affect the process selection and design approaches. In contrast to larger flow systems, the diurnal variations in the wastewater flow rates and concentrations are much more dramatic, with a large increase in flow and

wastewater strength after day break and with minimal wastewater flows in the late evening and early morning hours. The wastewater strength is also typically much greater than that found for centralized wastewater treatment facilities much of the time, which greatly affects the process selection alternatives to meet low effluent nutrient concentrations.

Small flow and decentralized wastewater treatment systems generally have less resources for operational and maintenance staff, which favors selecting processes that have less mechanical complexity and/or exhibit a high degree of reliability, and process designs with higher safety factors. Many small flow and decentralized wastewater treatment facilities are located near applications for water reuse, such that the process selection includes both nutrient removal and required water quality for water reuse. As the need for higher treatment levels has evolved for small systems, many of the processes commonly used in the past may be outdated and new approaches are continually being developed. For additional guidance for small flow systems, please consult the EPA website at: http://cfpub.epa.gov/owm/septic/septic.cfm?page_id=268.

8.3 Advantages and Disadvantages of Technology Types

To assist in technology selection, Table 8-1 provides some very general advantages and disadvantages of some common technology types. A discussion follows the table.

Table 8-1. Advantages and Disadvantages of Technology Types

Technology Type	Advantages	Disadvantages
Attached growth compared to suspended growth	<ul style="list-style-type: none"> • Smaller footprint • Can biologically nitrify at lower SRTs • More resilient to shock loads • Less biological sludge production • Better settling sludge 	<ul style="list-style-type: none"> • High oxygen transfer requirements • Operation is less flexible (i.e., accumulation of nitrifying biomass is limited because of competition with heterotrophic microorganisms for DO and carbon) • Secondary process such as chemical precipitation is needed for phosphorus removal
Chemical phosphorus removal compared to biological phosphorus removal	<ul style="list-style-type: none"> • Not susceptible to biological upsets and is, thus, generally considered more reliable and controllable. • Can increase sludge settling rates. 	<ul style="list-style-type: none"> • Increased sludge volume • Consumes alkalinity, which can affect nitrification • If added to secondary treatment, increased MLSS concentration and therefore, increased clarifier volume • Chemical costs
Mainstream treatment compared to sidestream treatment of recycle streams	<ul style="list-style-type: none"> • Flow equalization can help with wet weather flows and can provide operational flexibility • Mainstream treatment is straightforward with existing processes, whereas sidestream treatment may require operating training and vendor support 	<ul style="list-style-type: none"> • Equalization (EQ) basins require additional space, high capital costs. Sidestream treatment requires an additional but smaller footprint than EQ basins • Continuous sludge dewatering requires 24-hour operation vs. daily operation
Emerging technologies compared to established technologies	<ul style="list-style-type: none"> • Can offer improved efficiency and operational cost savings 	<ul style="list-style-type: none"> • Limited experience under a variety of operating conditions

Attached growth systems can be used to considerable advantage for nitrification and denitrification—biological aerated filters (BAF) being an example—but they are difficult, though not impossible, to use for biological phosphorus removal. Consequently, when BAFs are used and phosphorus removal is also required, the phosphorus is almost always removed by chemical precipitation. The BAFs have a small footprint, which can be a major advantage, but they tend to have higher oxygen transfer energy costs when used for nitrification, and organic carbon has to be added for denitrification. Flexibility for treatment of changing flows and loads only comes from having multiple units, some of which can be taken on and off line at the appropriate times.

The addition of fixed film media to an activated sludge basin has several advantages. The attached biomass does not flow forward to the secondary clarifier, reducing the solids loading to the clarifier. The SRT of the attached biomass is long, so that the average SRT of the attached and suspended biomass is long enough to accomplish nitrification under conditions that would not be

conducive to nitrification with suspended biomass alone. The disadvantages are the costs and installation of the media and necessary appurtenances such as screens, air knives, recycle pumps and mixers, depending upon the type of media selected.

Chemical phosphorus removal using iron or aluminum salts can be used instead of BPR or as a supplement to BPR. The advantages of chemical phosphorus removal are that (1) the chemical addition can be turned on and off without an acclimation period or harm to the biological processes, (2) removals can be obtained even when there are biological upsets, (3) the process is easy to control for consistent removal to low levels, and (4) the addition of the chemicals increases the sludge settling rates when added directly to the mixed liquor. Disadvantages of chemical addition are (1) the increase in sludge production; (2) the cost of the chemicals and consumption of alkalinity by both iron and aluminum chemicals, which may result in a need to add alkalinity for both chemical coagulation and nitrification; (3) and increases in the MLSS concentrations in the reactors. It is important to note that addition of VFAs to a biological phosphorus removal process makes it easier to control similar to chemical addition for phosphorus removal, with a lesser increase in waste sludge production.

Sidestreams can be managed at the plant through mainstream treatment or can be treated separately using a conventional or advanced sidestream treatment process. Consistently low effluent TN does not require removal of nitrogen from sidestreams; mainstream treatment such as flow equalization or continuous dewatering operations can be just as effective (Barnard 2006). Mainstream treatment can be a lower cost option but often requires additional monitoring and controlled operation. Also, operators are more familiar with mainstream as compared to advanced treatment options. Advanced sidestream treatment methods, however, have been increasingly used in recent years. They typically have smaller overall footprints. See Chapter 6, Section 6.6 for a description of several advanced sidestream treatment processes.

8.4 Overview of Recommended Approach

Although selection of the most appropriate nutrient removal technology depends on many factors, designers can begin with a generalized approach based on a few important external conditions, namely:

- Target effluent limits for TN
- Target effluent limits for TP
- Available Space
- Temperature

As noted throughout this design manual, simulators are the best tool for process selection and design. See Chapter 6 for detailed information on the available technologies for nitrogen and phosphorus removal at WWTPs and Chapter 10 for guidance on process selection and design using models and simulators.

1. Target effluent limits for TN

- For up to 70 percent removal of TN from the wastewater and typically producing effluent concentrations **between 5 and 8 mg/L**, depending upon the internal recycle rate, the basic configuration of a single anoxic and aeration zone (e.g., the MLE process) with conventional

secondary clarifiers is often sufficient. Target effluent levels between 5 and 8 mg/L year round, however, may be difficult to achieve with this technology in areas with very cold climates or where water conservation has led to a more concentrated wastewater. Typically, however, effluent concentrations in that range can be obtained if the internal recycle rate can be increased to higher rates. This assumes the design permits the RAS rate to be increased to at least 100 percent of the influent, and preferably to 150 percent.

- For 70 to 90 percent removal of TN from wastewater and typically producing effluent concentrations **between 3 and 5 mg/L**, a second anoxic zone can be added after the aerobic zone such as in the 4-stage Bardenpho process configuration, or an effluent denitrification filter can be used to achieve the required removal by denitrifying the portion of the flow that is not recycled to the first anoxic zone. Complete denitrification by the 4-stage Bardenpho process typically requires addition of an external carbon source to the second anoxic zone unless a very large second anoxic zone is used. Removal can be improved through optimization of influent loading by equalization, or by controlling recycle streams and influent flow to prevent washout of nitrifiers.
- For 90 percent or more removal of TN from wastewater and typically producing effluent concentrations of **3 mg/L or less**, removal may become limited by dissolved organic nitrogen (DON) in the plant effluent. Based on a study of 188 plants, effluent DON (or EDON) typically ranges between 0.5 and 1.5 mg/L (Pagilla 2007). Research is ongoing into the design and operating conditions that can be used to minimize EDON. Process optimization and automated control systems become very important in achieving these low TN levels. Denitrification filters with supplemental carbon (e.g., methanol) addition can provide enhanced TN removal consistently to low effluent levels.
- See Chapter 6, Section 6.7, for additional discussion of attainable effluent TN.

2. Target effluent limits for TP

- For 80 to 90 percent removal of TP from wastewater and typically producing effluent concentrations of **0.5 to 1.0 mg/L**, BPR should be sufficient as long as the following conditions are met:
 - The ratio of readily biodegradable carbonaceous oxygen demand (rbCOD) to TP (rbCOD:TP) is sufficient. Typically, BPR will work for rbCOD:TP ratios of 10 to 16 or greater; see Chapter 5, Section 5.2 of this design manual for additional information.
 - The recycle of dissolved oxygen and nitrates to the anaerobic zone are controlled.
 - Large amounts of phosphorus are not released during sludge handling and recycled to the biological process influent.

To consistently achieve low levels under all conditions, chemical addition should be considered as a backup.

- For 90 percent or more removal of TP from wastewater and typically producing effluent concentrations ***less than 0.5 mg/L TP***, it is common for BPR plants with primary settling to need supplemental chemical addition unless sludge fermentation or supplemental organic carbon addition is practiced. The key to achieving low TP limits is the solids separation process. Conventional clarification is not sufficient in many cases. Low target limits may require advanced clarification processes or effluent filtration. Note that effluent TP concentrations of 0.2 mg/L or even less can be consistently achieved with BPR if adequate amounts of VFAs are present in the anaerobic zone (through favorable rbCOD:TP ratios in the influent or through VFA addition) and recycle streams are carefully controlled.
 - See Chapter 6, Section 6.7 for additional discussion of attainable effluent TP.
- 3. Available Space.** Retrofitting for BPR or adding chemicals for phosphorus removal requires very little in the way of additional space at the treatment plant. The footprint for the anaerobic zone for BPR is typically 5 to 15 percent of the total anaerobic/aerobic volume, and this can often be created using baffles in the existing basin. Chemical dosing equipment is relatively small and can usually be configured within the existing plant layout. Advanced solids/liquid separation technologies such as tertiary clarification or filtration can, however, have large footprints and require additional space. High-rate ballasted clarification (HRBC) should be considered when space is constrained.

Although space requirements for phosphorus removal are typically low, suspended growth aeration processes for nitrogen removal require high SRTs and thus, large basins compared to conventional activated sludge processes. If sufficient volume is available in the existing activated sludge basin, it can be modified to configure separate anoxic and aerobic zones by adding baffles, mixers and an internal recycle. The configuration of the activated sludge basin determines the complexity of the internal recycle system. Sometimes all that is needed is a port in one of the walls and a propeller pump installed in the port to pump the recycle through the wall to the adjacent basin. If sufficient volume is not available in the existing activated sludge basins (which is often the case), additional basins may be needed. Designers should consider the following approaches to minimize the footprint for biological nitrogen removal when space is constrained:

- Increase the biomass in the activated sludge basins using a combination suspended-attached growth system such as Integrated Fixed Film Activated Sludge (IFAS). This will reduce the size of the biological reactors and, therefore, the footprint.
- Use membrane bioreactors (MBR) for liquid-solids separation instead of conventional clarification. MBR systems can operate at a higher mixed liquor suspended solids (MLSS) concentration, thereby reducing basin requirements for the biological reactors.
- Use an attached growth reactor for nitrification such as a Biological Aerated Filter (BAF).
- Instead of a second anoxic zone, consider a denitrification filter. Denitrification filters have the added advantage of achieving low effluent TN limits but usually require a supplemental carbon source. They also require additional pumping to provide the pressure head to move water through the filter.

- Consider bioaugmentation of nitrifiers to reduce the needed SRT in the activated sludge basin and thus provide more treatment in a smaller volume.
- If peak flows are the issue, consider a step feed system to handle wet weather events instead of constructing additional basins.

4. Temperature. Biological treatment processes are sensitive to changes in temperature. The most sensitive process is nitrification, with the rate approximately doubling for every 8 to 10° C increase in temperature (WEF and ASCE, 2006). It is very important that designers consider the annual temperature range, not just the design temperature when selecting candidate technologies. In temperate regions of the country, fixed film systems such as BAF and hybrid systems such as IFAS compensate for temperature impacts by maintaining the nitrifiers in the system for very long SRTs. A swing zone that allows operators to switch between anoxic and aerobic zones also can help ensure consistent removal under varying temperature conditions. Low temperatures can also interfere with fermentation of wastewater in sewers and anaerobic zones and reduce the production of VFAs required for BPR. Onsite sludge fermentation has successfully been used in colder climates to address this issue. As previously noted, BPR process performance often improves with lower temperatures because of microbial population shifts that result in larger populations of PAOs relative to the GAOs, assuming the recycle of electron acceptors to the anaerobic zone is controlled. See Sections 4.5.3, 5.4.4, and 8.2.1 of this manual for additional information on the effects of temperature on BNR.

8.5 Recommended Use of Advanced Tools

This section introduces three advanced tools that can be used for designing upgrades for nutrient removal: pilot testing, mathematical modeling, and bench scale testing.

Pilot testing of the preferred nutrient removal alternative is very common in the wastewater industry. Testing typically takes 6 months to 1 year depending on seasonal variability and can be done during the planning or preliminary design phase. Although it can be expensive, pilot testing allows designers to size and configure unit processes based on actual wastewater and biomass characteristics and can reduce safety factors and thus, save capital costs considerably in excess of the cost of the study.

Mathematical equations representing wastewater treatment processes and simulation programs used to solve them have become increasingly powerful and common in recent years. Computer modeling has many benefits over traditional design approaches. Designers can use models to quickly test many different treatment configurations and design parameters in a fraction of the time and cost of performing traditional design calculations and laboratory or pilot tests. While setting up and calibrating models can be a complex process, it is ultimately easier and more powerful than traditional design methods, when done properly. Modeling has therefore become the preferred method of design for nutrient removal at WWTPs. Chapter 10 provides additional discussion of the benefits of mathematical modeling along with detailed guidance on setting up and running a process simulation model for nutrient removal.

Data from bench scale tests are commonly used to calibrate process simulation models. One of the most important tests for nitrification is the determination of maximum specific nitrifier growth rate. Chapter 10 discusses the importance of this parameter and summarizes proven characterization

methods. Bench scale tests can also provide very useful information on the relative fractions of particulate, soluble, and readily biodegradable organic material (which is very important for biological phosphorus removal) and can be used to estimate rDON. Determination of non-biodegradable suspended solids fractions is also very important for accurate estimates of design MLSS concentrations. Because reactions are complex and difficult to generalize, jar testing for chemical phosphorus removal is also highly recommended. Bench scale testing is also common and recommended for evaluating alternative carbon sources.

8.6 Patent issues

A patent is essentially a type of property right. It gives the patent holder the right to limit others from making, using, offering for sale, or selling the invention in the United States or importing the invention into the United States. In general, the term of a patent is 20 years from the date that the patent application was submitted. The U.S. Patent and Trademark Office (USPTO) is the government agency responsible for reviewing applications and issuing patents.

There are three types of patents (USPTO 2009):

- Utility patents may be granted to anyone who invents or discovers any new and useful process, machine, article of manufacture, or composition of matter, or any new and useful improvement thereof.
- Design patents may be granted to anyone who invents a new, original, and ornamental design for an article of manufacture.
- Plant patents may be granted to anyone who invents or discovers and reproduces any distinct and new variety of plant.

Patents for wastewater treatment technologies are usually **utility patents**.

If a patented process is selected for nutrient removal, license and royalty fees may apply and should be included in the cost analysis. Fees are usually negotiated between the patent holder and the plant owner. To search for patents, use the USPTO database, available online at <http://patft.uspto.gov/> or visit a patent and trademark depository library. Refer to http://www.uspto.gov/go/ptdl/ptdlib_1.html for library locations in your state.

In general, patent and licensing fees are not required for biological phosphorus removal systems. Some of the biological phosphorus removal technologies listed in Chapter 6 of this manual may have at one time been patented, but many have been in use longer than the patent period. Proprietary systems for attached growth nitrification and sidestream processes are patented, but the patent fees are included in the price from the manufacturer.

8.7 References

- Barnard, J.L. 2006. Biological Nutrient Removal: Where We Have Been, Where We are Going? In *Proceedings of the Water Environment Federation, WEFTEC 2006*.
- Bilyk, K., J. Rohrbacher, T. Bruton, P. Pitt, R. Latimer. 2009. Evaluating the Cost and Process Performance of Carbon Alternatives to Methanol. Presented at Nutrient Removal 2009. Washington, DC. WEF.
- deBarbadillo, C., J. Barnard, S. Tarallo, and M. Steichen. 2008. Got Carbon? Widespread biological nutrient removal is increasing the demand for supplemental sources. *Water Environment & Technology*. Alexandria, VA: WEF. 20(1): 49-53.
- deBarbadillo, C., P. Miller, and S. Ledwell. 2009. A Comparison of Operating Issues and Dosing Requirements for Alternative Carbon Sources in Denitrification Filters. Presented at Nutrient Removal 2009. Washington, DC. WEF.
- Copithorn, R. R., G. D. Farren, D. Sen and C. W. Randall. 1993. Full-Scale Evaluation of Nitrification and Denitrification on Fixed-Film Media (Ringlace) for Design of a Single-Sludge Nitrogen Removal System, *Proceedings Liquid Treatment Processes, 66th Annual Conference Water Environment Federation*, (3):137-148. Anaheim, California, October 30, 1993.
- Cherchi, C., A. Onnis-Hayden, and A.Z. Gu. 2009. Ability of Specific Enriched Denitrifying Culture to Utilize Other Carbon Sources. Presented at Nutrient Removal 2009. Washington, DC. WEF.
- Gellner, W. J., L. Samel, D. Howard, Al. Stone, and P. Pitt. 2008. When Conventional Design Bid Build Approach is Unconventional Design and Bidding of IFAS Full-Scale Pilot at Greensboro, North Carolina. In *Proceedings of the Water Environment Federation, WEFTEC 2008*.
- Johnson, T. L., J. McQuarrie, and A. Shaw. 2004. Integrated Fixed-Film Activated Sludge (IFAS): The New Choice for Nitrogen Removal Upgrades in the United States. In *Proceedings of the Water Environment Federation, WEFTEC 2004*.
- Kang, S.J., K.P. Olmstead, K.M. Takacs, J. Collins, J. Wheeler, and P. Zharaddine. 2009. Sustainability of Full-Scale Nutrient Removal Technologies. Presented at Nutrient Removal 2009. Washington, DC. WEF.
- Maquarrie, J., D. Waltrip, R. Rutherford, W. Thomas, C. Bott, R. Baumler, and D. Katehis. 2009. Full-Scale Design Challenges for the James River Treatment Plant IFAS Improvement Project: Using a Demonstration Scale Project to Optimize Final Design. Presented at Nutrient Removal 2009. Washington, DC. WEF.
- Majed, N., A. Onnis-Hayden, T. Welander, and A.Z. Gu. 2009. Decoupling and Optimization of Both P and N Removal in an Advanced IFAS-EBRP-MBR System. Presented at Nutrient Removal 2009. Washington, DC. WEF.
- Onnis-Hayden, A., N. Majed, K. McMahon., A. Gu. 2008. Phosphorus Removal and PAOs Populations at a Full-Scale Integrated Fixed Film Activated Sludge (IFAS) Plant. In *Proceedings of the Water Environment Federation, WEFTEC 2008*.

- Phillips, H. M. and E. Kobylinski. 2007. Sidestream Treatment vs. Mainstream Treatment of Nutrient Returns when Aiming for Low Effluent Nitrogen and Phosphorus. In *Proceedings of the Water Environment Federation, WEFTEC 2007*.
- Randall, C. W., and D. Sen. 1995. Full-Scale Evaluation of an Integrated Fixed-Film Activated Sludge (IFAS) Process for Enhanced Nitrogen Removal. *Wat. Sci. Tech.* (33)12: 155-162. Elsevier Science Ltd., GB.
- Sriwiriyarat, T., and Randall, C.W. 2005. Evaluation of IFAS Wastewater Treatment Processes at High MCRT and Low Temperatures. *Journal of Environmental Engineering*. ASCE. 131(11): 1550-1556.
- Tchobanoglous, G., F. L. Burton, and H.D. Stensel. 2003. *Wastewater Engineering: Treatment and Reuse*. New York, NY: McGraw-Hill.
- Thomas, W.A., C.B. Bott, P. Regmi, G. Schafran, J. McQuarrie, B. Rutherford, R. Baumler, and D. Waltrip. 2009. Evaluation of Nitrification Kinetics for a 2.0 MGD IFAS Process Demonstration. Presented at Nutrient Removal 2009. Washington, DC. WEF.
- USEPA. 2008a. Municipal Nutrient Removal Technologies Reference Document. Office of Wastewater Management, Municipal Support Division. EPA 832-R-08-006. Available online: <http://www.epa.gov/OWM/mtb/mnrt-volume1.pdf>
- USEPA. 2008b. Emerging Technologies for Wastewater Treatment and In-Plant Wet Weather Management. EPA 832-R-06-006. Available online: http://www.epa.gov/OW-OWM.html/mtb/emerging_technologies.pdf
- WEF and ASCE. 1998. Design of Municipal Wastewater Treatment Plants - MOP 8, 4th Ed. Water Environment Federation and American Society of Civil Engineers. Alexandria, VA: WEF.
- WEF and ASCE. 2006. Biological Nutrient Removal (BNR) Operation in Wastewater Treatment Plants - MOP 29. Water Environment Federation and the American Society of Civil Engineers. Alexandria, VA: WEF Press.
- WERF. 2008. Carbon Augmentation for Biological Nitrogen Removal. Julian Sandino, Lead Editor. WERF Dissolved Organic Nitrogen Compendium.
- U.S. Patent Office. 2009. United States Patent and Trademark Office, Main Webpage. Website Accessed 8 May 2009. <http://www.uspto.gov/main/patents.htm>

9. Design Approach for Phosphorus Removal by Chemical Addition

Chapter 9 covers:

- 9.1 Introduction
- 9.2 Selecting a Chemical Precipitant
- 9.3 Selecting Point(s) of Application
- 9.4 Determining Chemical Dose
- 9.5 Designing a Chemical Feed System
- 9.6 Designing for Rapid Mixing and Flocculation
- 9.7 Solids Separation Processes
- 9.8 Operational Factors
- 9.9 References

9.1 Introduction

Many wastewater treatment plants (WWTPs) that are required to remove phosphorus do so by adding chemicals to precipitate phosphate and then remove it using solids separation techniques. Chemicals may be added to primary, secondary, or tertiary processes, or at multiple locations in the plant. Chemicals used for phosphorus precipitation include metal salts, such as ferric chloride and aluminum sulfate (alum), and lime.

Chapter 3 explained the principles of phosphorus removal by chemical addition. The purpose of this chapter is to provide guidance on key design and operational issues. This chapter's discussion on solids separation focuses on advanced wastewater clarification, while effluent filtration is discussed in-depth in Chapter 11.

9.2 Selecting a Chemical Precipitant

Chemicals for precipitation are based on either aluminum (III), ferric (III), ferrous (II), or calcium (II) compounds that react with soluble phosphorus. The most common chemicals used are aluminum (III) and ferric (III) compounds; in particular, the two metal salts aluminum sulfate (alum) and ferric chloride. Alum and ferric chloride have similar properties and performance. Compared with lime, they create less sludge and tend to be more popular with operators. Polymers can be added with metal salts to improve settling or the removal of precipitated phosphate via filtration.

9.2.1 Advantages and Disadvantages of Metal Salts

Table 9-1 lists metal salts available for phosphorus removal and provides a summary of available forms and storage requirements, advantages, and disadvantages. A discussion of the advantages and disadvantages of lime is provided in section 9.2.2. Note that phosphorus removal by metal salts is based on stoichiometry whereas removal by lime is based on achieving a target pH range.

Table 9-1. Advantages and Disadvantages of Common Aluminum and Iron Salts

Type	Available Forms and Storage Issues	Advantages	Disadvantages
Aluminum			
Aluminum sulfate (alum)	<ul style="list-style-type: none"> Liquid or dry form Stable at room temperatures in closed containers under normal storage conditions Near unlimited shelf life Corrosive, dust is irritant 	<ul style="list-style-type: none"> Most common form of aluminum salt. Has been used to achieve low effluent phosphorus concentrations 	<ul style="list-style-type: none"> May need excess to depress the pH to an optimal operating environment Alum sludge may be more difficult to thicken and dewater than iron sludge
Sodium aluminate ¹	<ul style="list-style-type: none"> Liquid or dry form Liquid has 2-3 month shelf-life, strong alkali, handle as caustic Dry has 6 month shelf-life, non-corrosive, dust is irritant 	<ul style="list-style-type: none"> Does not consume alkalinity Appropriate for low alkalinity wastewater or where pH is already low and further depression should be avoided 	<ul style="list-style-type: none"> Dissolved CO₂ or other acidity is needed to avoid pH increase above optimum zone Performance considered inferior to alum
Polyaluminum Chloride (PACl)	<ul style="list-style-type: none"> Available as liquid, hydrate form. Available in different strengths Corrosive mineral acid. Requires acid-resistant materials like PVC, Teflon®, rubber, and ceramic materials 	<ul style="list-style-type: none"> Does not change pH of wastewater Various formulations (multiple aluminum atoms bonded with chloride) available depending on manufacturer Can help lower turbidity 	<ul style="list-style-type: none"> Not compatible with carbon steel, stainless steel, brass or aluminum Unit cost may be higher
Iron			
Ferric chloride ²	<ul style="list-style-type: none"> Available as liquid Very corrosive Stains concrete and other materials 	<ul style="list-style-type: none"> More common than ferrous chloride or ferrous sulfate Has been used to achieve low effluent phosphorus concentrations 	<ul style="list-style-type: none"> Especially corrosive and requires special piping In plants with poor solids capture, ferric chloride might impart a slight reddish color to effluent Can be an issue if UV disinfection is downstream³
Ferrous chloride	<ul style="list-style-type: none"> Available as liquid Slightly less corrosive than ferric chloride 	<ul style="list-style-type: none"> Can be available as a low-cost industrial byproduct 	<ul style="list-style-type: none"> If industrial byproducts, may have large amounts of impurities, such as free acid or metals Produces low phosphorus levels only at high pH
Ferrous sulfate	<ul style="list-style-type: none"> Available dry Acidic when dissolved Oxidizes in moist air Cakes at storage temp above 20°C 	<ul style="list-style-type: none"> Can be available as a low-cost industrial byproduct 	<ul style="list-style-type: none"> If industrial byproducts, may have large amounts of impurities, such as free acid Produces low phosphorus levels only at high pH

- Granular trihydrate is a common commercial form
- "Ferric" is also a common trade name for FeCl₃ and also 40 percent liquid FeCl₃ solution.
- Potential for problems depends on chemical application point. Of great concern if it is added in chemical treatment process preceding UV disinfection.

Source: WEF and ASCE (1998); USEPA (1987a); Gulbrandsen (2008); Tchobanoglous et al. (2003).

9.2.2 Advantages and Disadvantages of Lime

As explained in Chapter 3, lime first reacts with bicarbonate alkalinity to form calcium carbonate. As the pH increases, excess calcium ions will react with the phosphorus to precipitate hydroxylapatite ($\text{Ca}_5(\text{OH})(\text{PO}_4)_3$).

The primary reasons for infrequent use of lime for phosphorus removal are:

- The substantial increase in the mass of sludge to be handled compared to that from use of metal salts.
- Phosphorus precipitation to low concentrations occurs at high pH levels (11-12), and pH neutralization is required before effluent discharge.
- The operation and maintenance problems associated with the handling, storage, and feeding of lime.

Lime sludge can reach 0.5 percent of the volume of wastewater treated (Tchobanoglous et al. 2003). To avoid this large production of sludge, plants can consider adding lime in a tertiary process. Tertiary designs can be single-stage with one rapid mix, flocculation, sedimentation, and recarbonation basin or a two-stage process with a second sedimentation basin, which allows for better control and higher removal. Addition of lime to primary tanks has the advantage, however, of removing substantial amounts of total suspended solids (TSS) and biochemical oxygen demand (BOD), reducing secondary treatment requirements.

The key variable in phosphorus removal using lime is alkalinity. If the alkalinity is too low, lime addition will create a poorly settleable floc (WEF and ASCE 1998). If the alkalinity is moderate to high (> 150 milligrams per liter (mg/L)), the floc will contain a greater fraction of dense calcium carbonate precipitate, which leads to enhanced settling. WEF and ASCE (1998) report excellent phosphorus removal with high alkalinity waters with lime treatment to a pH of 9.5 to 10, but higher pH values are commonly used. Regardless of the application point, pH adjustment is needed following lime treatment and is usually accomplished by adding carbon dioxide or a liquid acid such as sulfuric acid, nitric acid, or hypochlorite (Tchobanoglous et al. 2003; USEPA 1999).

Chemical costs for lime can be reduced by recovering lime on-site using lime recalcination. Recalcination is achieved by heating the sludge to 980 °C to convert calcium carbonate to lime. The carbon dioxide from this process can be used as a source for recarbonation of the water for pH adjustment.

Lime requires special handling that sets it apart from metal salts. Carbonate scaling can form on equipment and pipes. Lime slaking, where quicklime (CaO) is reacted with water to form $\text{Ca}(\text{OH})_2$, is the biggest operational disadvantage. Section 9.5.2.3 provides a discussion of lime slaking.

Although lime had lost favor due to issues associated with chemical handling and sludge production, it has been regaining popularity because of its ability to reduce phosphorus to very low levels when combined with effluent filtration, as well as its beneficial microbial control properties during sludge digestion. WEF and ASCE (1998) report that residual phosphorus concentrations of 0.1 to 0.2 can be achieved with lime treatment and granular media filtration. The Upper Occoquan Sewage Authority Advanced Wastewater Treatment Plant, Fairfax County, VA, has routinely and consistently achieved effluent soluble phosphorus concentrations of less than 0.05 mg/L using high lime treatment followed

by sand filtration since July of 1978, a period of more than thirty years. The effluent requirement for the facility over the entire period of time has always been 0.1 mg/L TP.

9.2.3 Costs

According to the U.S. Geological Survey (USGS) 2007 Minerals Yearbook, the cost for quicklime in 2007 was \$76.70 per ton, and hydrated lime cost \$92.90 per ton (Miller 2008). Dry alum can cost around \$260 per ton, and a ton of liquid ferric chloride can cost around \$400 (Yuba City 2007; City of East Moline 2007; City of Santa Cruz 2006; Saginaw City Council 2006). Lime and other chemical costs are expected to continue to rise in the coming years with increasing global demand for chemicals, rising oil prices, and potential supply shortages, which can be worsened by certain local conditions like weather events that disrupt distribution systems (Plank 2008).

9.3 Selecting Point(s) of Application

Metal salts can be added at one or multiple locations within a treatment plant to remove phosphorus (see Figure 9-1 for possible points of chemical addition for a conventional WWTP). “Pre-precipitation” is when chemicals are added to raw water prior to primary clarification to precipitate phosphorus in the primary sedimentation basins. “Co-precipitation” involves adding chemicals directly to the biomass in the biological system to form precipitates that can be removed with biological sludge. “Post-precipitation” is when chemicals are added after secondary sedimentation and precipitants are removed in a tertiary process such as sedimentation or filtration (Tchobanoglous et al. 2003). Chemicals also can be added to waste or recycle streams to reduce the recycle of phosphorus released during sludge handling. For example, at the Alexandria Sanitary Authority Advanced Wastewater Treatment Plant, the alum in the return stream was reported to aid in phosphorus removal through the plant (EPA Region 10 2007).

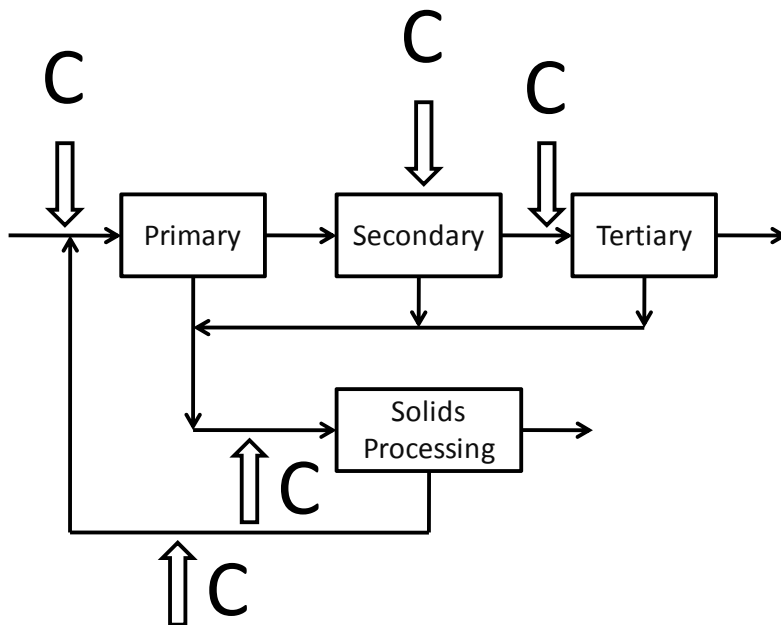

Figure 9-1. Possible application points for chemical addition (C).
 Source: Adapted from Bott et al. (2007), with Permission from the Water Environment Research Foundation.

Table 9-2 summarizes the advantages and disadvantages of possible feed points for metal salts. The optimal point of chemical addition is specific for a given plant and depends on the existing treatment configuration, treatment goals, choice of chemicals, and solids handling issues. One of the main advantages of multiple point addition is a savings in total chemical usage. The amount of metal salt per unit of phosphorus removal increases as the final phosphorus concentration decreases. By using multiple addition points, a large portion of the phosphorus removal can be done at a higher phosphorus concentration and lower metal/ phosphorus removal ratio.

Lime **cannot** be added directly to biological treatment processes because it raises the pH above 10 for phosphorus removal and activated sludge processes prefers pH levels below 8.5. Lime can be added to primary sedimentation tanks and removed with the primary sludge or it can be added as a tertiary treatment process after biological treatment. When added to primary tanks, it will also result in the removal of colloidal material through coagulation and settling, with a concomitant removal of TSS up to 80 percent and COD up to 60 percent. In either case, the need for pH adjustment for downstream processes should be considered and is typically accomplished by adding CO₂ or a liquid acid such as sulfuric acid, nitric acid, or hypochlorite (Tchobanoglous et al. 2003).

It is important to note that downstream biological treatment may be negatively affected if too much phosphorus is removed by chemical addition in primary treatment, as phosphorus is an essential nutrient for growth of microorganisms. For activated sludge, the minimum ratio of phosphorus to five-day biochemical oxygen demand (BOD₅) for a rapidly growing low solids retention time (SRT) system is typically about 1:100 (WEF and ASCE 1998). Note, however, that the amount of phosphorus (and all other nutrients) required is a function of net biomass yield and decreases as the operating SRT increases.

Table 9-2. Advantages and Disadvantages of Metal Salt Application Points

Application Point	Advantages	Disadvantages
Primary Clarifier only (pre-precipitation)	<ul style="list-style-type: none"> • Removes additional BOD and solids • Uses lower stoichiometric dose • Iron addition can reduce sulfide odors • Reduces oxygen transfer requirements in the biological process, and reduces the amount of excess biomass sludge produced. 	<ul style="list-style-type: none"> • Control issue of leaving enough P for biotreatment but low enough for effluent • Does not remove polyphosphates which will be converted to orthophosphate in the bioprocess • Competing reactions for hydroxides can decrease dose efficiency • Removes alkalinity before nitrification process, which can result in low pH levels that inhibit nitrification • Removes BOD that can be used downstream for denitrification. Can result in larger anoxic tanks or an increased need for an exogenous carbon source for nitrogen removal.
Secondary Treatment only , e.g., aeration basin or before secondary clarifier (co-precipitation)	<ul style="list-style-type: none"> • For effluent P less than 1.0 mg/L good final control point for chemical dosing • Polyphosphates converted so most of P is available • May help improve TSS removal in clarifiers • Help prevent fouling in MBR systems 	<ul style="list-style-type: none"> • Removes alkalinity within the biological nitrification process which can lower pH and inhibit nitrification • MLSS increases with production of chemical sludge, which increases the solids loading to the final clarifiers. May need larger activated sludge tanks or larger clarifiers.
Tertiary Treatment only (post-precipitation)	<ul style="list-style-type: none"> • For effluent P less than 0.5 mg/L good final control point for chemical dosing • Polyphosphates already converted so most of P is available • Will help improve TSS removal • Can recycle precipitant to headworks for added P removal 	<ul style="list-style-type: none"> • Filtration increases capital and operating costs • Filtration increases operational complexity and maintenance • Filter solids breakthrough can lead to spikes in effluent P • P removal to low levels can inhibit or prevent nitrogen removal by denitrification filters • Requires separate sludge handling
Multiple	<ul style="list-style-type: none"> • Can achieve lower effluent TP concentration • Optimization of chemical dose to lower requirements • Good control point at final dosing • Provides flexibility 	<ul style="list-style-type: none"> • Additional costs for chemical feed and control equipment in multiple locations. • Additional operational complexity

9.4 Determining the Chemical Dose

Chapter 3, Section 3.3.2 provides a detailed discussion of the reactions between phosphorus and chemical precipitants and of dosing theory. For phosphorus removal using metal salts, the molar ratio of the metal to the soluble phosphorus concentration (Me_{dose} / P_{ini}) is the basis for the chemical dose. As noted in Chapter 3, recent research by Smith et al. (2007) showed that for typical influent phosphate concentrations.

- Doses above 1.5 to 2.0 Me_{dose}/P_{ini} ratios are sufficient to remove 80 to 98 percent of soluble phosphorus.
- Reaching very low limits requires significantly higher ratios on the order of 6 to 7 Me_{dose}/P_{ini} .

See the example on the next page for an approach to calculating an initial ferric chloride dose using these guidelines.

For phosphorus removal using lime, the dose is generally independent of the phosphorus concentration because the lime first reacts with alkalinity to precipitate hydroxylapatite (see Chapter 3 for more information). The recommended dose of lime is typically 1.4 to 1.6 times the total alkalinity expressed as $CaCO_3$ (Tchobanoglous et al. 2003).

Example 9-1: Determining Initial Ferric Chloride Dose for Phosphorus Removal

Problem: A WWTP operator wants to use ferric chloride (FeCl_3) to remove phosphate in the secondary clarifier. The plant's flow rate is 1.0 MGD, and the measured phosphate concentration entering the secondary clarifier is 4 mg/L as P.

Assumptions and Constants:

Ferric chloride solution strength = 40 percent

Density of ferric chloride solution = 1.4 kg/L

Molecular weight of Fe = 55.85

Molecular weight of FeCl_3 = 162.2

Molecular weight of P = 30.97

Solution:

- Determine the weight of iron (Fe) available per liter of liquid ferric chloride.
 - The weight of FeCl_3/L per liter of ferric chloride solution is:
$$\text{FeCl}_3/\text{L} = (0.40)(1.4 \text{ kg/L}) = 0.56 \text{ kg/L}$$
 - The weight of Fe per liter of ferric chloride solution is:
$$\text{Fe/L} = \text{FeCl}_3/\text{L} \times \text{molecular weight of Fe} / \text{molecular weight of FeCl}_3$$
$$= (0.56 \text{ kg/L}) \times (55.85/162.2) = 0.193 \text{ kg/L}$$
- Determine the weight of Fe required per unit weight of P.
 - Target dosage = 2.0 mole Fe (Fe_{dose}) per 1.0 mole P (P_{ini}) to remove up to 98 percent of phosphate
 - Iron required = $2 \times (\text{Fe}_{\text{dose}}/\text{P}_{\text{ini}})$
$$= 2 \times (55.85/30.97) = 3.61 \text{ kg Fe/kg P}$$
- Determine the amount of ferric chloride solution required per kg P.
$$\text{Ferric chloride dose} = \frac{3.61 \text{ kg Fe}}{1 \text{ kg P}} \times \frac{\text{L ferric soln}}{0.193 \text{ kg Fe}} = 18.70 \text{ L ferric soln/kg P}$$
- Determine the amount of ferric chloride solution required per day
 - Convert 1.0 MGD to L/d = $1 \times 10^6 \text{ gal/d} \times 3.785 \text{ L/gal} = 3.785 \times 10^6 \text{ L/d}$
 - Ferric chloride solution /d =
$$\frac{(3.785 \times 10^6 \text{ L/d}) \times (4 \text{ mg P/L}) \times (18.65 \text{ L ferric soln/kg P})}{(1 \times 10^6 \text{ mg/kg})}$$
$$= 283 \text{ L ferric chloride solution/d} \times 1 \text{ gal}/3.785\text{L}$$
$$= 74.8 \text{ gal/d}$$

While the literature provides good general guidelines on chemical doses for phosphorus removal, it does not account for site specific factors such as the influence of competing reactions and the effects of pH and alkalinity. Thus, designers should conduct **jar testing** to determine the optimum dose and mixing conditions for the specific wastewater to be treated. Jar testing is a fast, low-cost procedure that is commonly used in the water and wastewater industry. It simulates rapid mixing and flocculation on a small scale to predict the performance of large scale treatment operations. Figure 9-2 shows a common jar test apparatus. Multiple tests can be conducted at the same time to compare alternative doses, pH ranges, or mixing speeds.

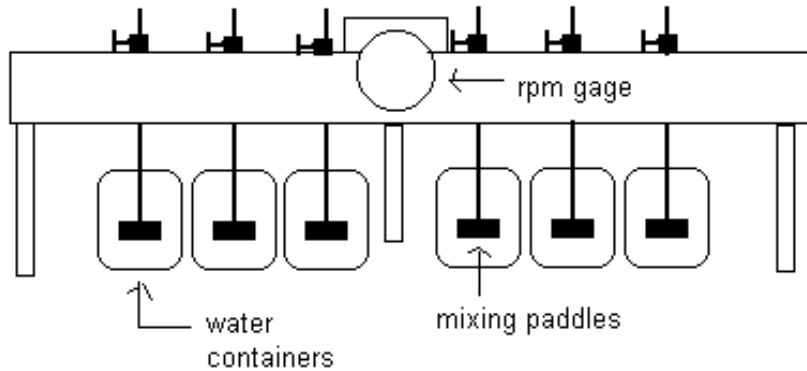

Figure 9-2. Schematic of common jar testing apparatus.

Source: Poland and Pagano, 1998, <http://www.cee.vt.edu/ewr/environmental/teach/wtprimer/jartest/jartest.html>

Although jar testing is common, careful planning is still required. Keys to successful jar testing are summarized in the text box below.

Keys to Successful Jar Testing

- Determine variables to be tested (i.e., effect of temperature, pH, mixing intensity, etc.)
- Vary only one parameter (e.g., alum dose) at a time. All of the other variables such as mixing rate and contact time should remain constant during a given test.
- Be careful to mix samples thoroughly prior to testing.
- Select reaction and flocculation times to mirror operational conditions at the plant.

Source: adapted from WERF 2008

9.5 Designing a Chemical Feed System

The objective of any feed system is to add the chemical to the wastewater at a controlled rate. Designers should always consider the properties of the chemical being added (as listed in the Material Safety Data Sheet) and state requirements when designing the chemical storage and feed system. Safety precautions such as containment in case of spill and personnel safety equipment requirements are extremely important.

Table 9-3 summarizes the types of chemical feeders typically used at municipal WWTPs. Section 9.5.1 provides guidance for design of liquid feed systems, followed by Section 9.5.2 with guidance on the design of dry feed systems, including lime.

Table 9-3. Types of Chemical Feeders

Category	Feeder Type	Use	Equipment Limitations		
			General	Capacity (m ³ /h) ¹	Feed rate range ²
Dry Feeder: Volumetric	Oscillating plate	Any material, granules, or powder		0.001 – 3.1	40 to 1
	Oscillating throat (universal)	Any material, any particle size		0.002 – 9.0	40 to 1
	Rotating disc	Most materials including NaF, granules, or powder	Use disk unloader for arching	0.001 – 0.09	20 to 1
	Rotating cylinder (star)	Any material, granules, or powder		0.7 – 180 0.65 – 27.0	10 to 1 or 100 to 1
	Screw	Dry, free flowing material, powder, or granular		0.005 – 1.7	20 to 1
	Ribbon	Dry, free flowing material, powder, granular, or lumps		0.002 – 0.015	10 to 1
	Belt	Dry, free flowing material up to 1.5-in size, powder, or granular		0.009 - 270	10 to 1
Dry Feeder: Gravimetric	Continuous—belt and scale	Dry, free flowing granular material, or floodable material	Use hopper or agitator to maintain constant density	0.002 – 0.18	100 to 1
	Loss in weight	Most materials, powder, granular, or lumps		0.002 – 7.2	100 to 1
Solution Feeder: Nonpositive Displacement	Decanter (lowering pipe)	Most solutions or light slurries		0.0009 – 0.9	100 to 1
	Orifice	Most solutions	No slurries	0.015 – 0.045	10 to 1
	Rotameter (calibrated valve)	Clear solutions	No slurries	0.0005 – 0.015 0.0002 – 0.018	10 to 1
	Loss-in-weight (tank w/control valve)	Most solutions	No slurries	0.0002 – 0.018	30 to 1
Solution Feed: Positive displacement	Rotating dipper	Most solutions or slurries		0.009 – 2.7	100 to 1
Proportional Pump	Diaphragm	Most solutions, Special unit for 5% slurries ³		0.0004 – 0.014	100 to 1
	Piston	Most solutions, light slurries		0.0001 – 15.3	20 to 1

1. Volumetric feed capacities are given because chemical specific gravities must be known to specify mass feed capacity.
2. Ranges apply to purchased equipment. Overall feed ranges can be extended more.
3. Use special heads and valves for slurries.

Source: WEF and ASCE 2009, Table 16.13

9.5.1 Liquid feed systems

Liquid or solution feed systems are typically used in the following cases (WEF and ASCE 1998):

- If chemicals are applied at low rates.
- If chemicals are less stable.
- When the dust of the dry form of the chemical is hazardous or difficult to handle.
- When only liquid chemicals are available.

9.5.1.1 Storage

Alum is typically stored without dilution at the shipping concentration received at the plant. Storage tanks located outside should be closed and vented, with provisions for heating to maintain temperatures above -4°C (25°F) to prevent crystallization. Liquid alum storage vessels are constructed of type 316 stainless steel, fiberglass-reinforced plastic (FRP), steel lined with rubber, or polyvinyl chloride (PVC). Liquid alum can be stored indefinitely.

Ferric compounds are acidic and require special storage and handling procedures. Fiberglass-reinforced plastic or polyethylene tanks can be used to store liquid ferric solutions (WEF and ASCE 2006).

Storage tanks should be sized to accommodate a 10-day to 2-week supply and should be capable of handling 1-1/2 times the maximum quantity shipped. Some state regulations require that storage times be related to potential delivery delays or specific periods at average chemical feed rates.

9.5.1.2 Feed Methods

Several alternatives are available for feeding liquid chemicals or chemical solutions. Descriptions of common feed systems are provided below. Selection of the feed method is site specific and depends on factors such as feed pressure, fluid properties, type of control, and treatment goals.

Manufacturers' recommendations should be followed regarding selection of pump materials for the specific chemical of interest. Because iron and aluminum salt solutions are acidic and corrosive, WEF and ASCE (2006, p. 297 and 303) recommend that pump heads be polyvinyl chloride (PVC) and that piping, fittings, and valves be PVC or chlorinated PVC (CPVC). Pipe selection for polymer service should be made after the type of polymer has been determined (plastic pipe or type 316 stainless steel is normally used). Pipes that are above ground in temperate regions may need to be heat-traced.

It is important to note that it is generally not necessary to dilute liquid alum or ferric chloride prior to feeding into the process. Addition of carrier water could raise the pH and result in formation of metal hydroxides which can precipitate and cause plating in chemical feed lines. If dilution is needed, carrier water should be added as close to the injection point as possible (WEF and ASCE 2006). For polymers, dilution of the stock solution is often practiced to allow better dispersion of the polymer in the wastewater.

Rotary Dipper Feeders or Rotameters

Rotary dipper feeders are reliable feeders that are commonly used for gravity flow applications. Feed rates can be varied based on a signal from a mainstream flow meter (flow proportional control). Rotameters in conjunction with control valves may also be used for small applications where frequent variation in chemical feed rate is not required. Rotameters should not be used with ferric chloride or other iron solutions because the sight glass will become stained and opaque.

Non-positive Displacement Pump

A non-positive displacement pump, or a kinetic pump, delivers water in a steady stream. Energy added to the fluid increases the flow velocity inside the pump relative to the velocity at discharge. Examples of kinetic pumps include solids-handling centrifugal pumps, recessed-impeller pump, screw/combination centrifugal pumps, and grinder pumps (WEF and ASCE 1998).

A centrifugal transfer pump is an example of a non-positive displacement pump. These pumps should be directly connected but not close-coupled to prevent leakage into the motor

Positive Displacement Pump

When the discharge volumes of a pump are separated by a period of no discharge, it is referred to as a positive displacement pump. A positive displacement pump pulls water into the pump chamber with a vacuum created by the withdrawal of a piston, which displaces a set volume of water from the chamber and forces it through the discharge valve and pipe (WEF 2008). Examples of positive displacement pump types are the plunger pump, the reciprocating piston, peristaltic pump, pneumatic ejector, rotary lobe pump, air-operated diaphragm pump, and progressing cavity pump (WEF and ASCE 1998). Metering pumps are either of the diaphragm or plunger type. Diaphragm pumps protected with internal or external relief valves are preferred. A back pressure valve is recommended to provide positive check valve operation.

Proportional Pumps

A proportional pump is a type of positive displacement pump commonly used for chemical feed. It is a type of diaphragm pump that has a flow rate that can be precisely adjusted via changing the length of the stroke or the stroke speed. The mechanism of a diaphragm pump is that the diaphragm is a part made of flexible rubber-type material fastened within a vertical cylinder. The diaphragm is raised, producing suction, and when it is dropped, it forces liquid out of a discharge valve (WEF 2008). It has been reported that this type of pump is very susceptible to clogging and that a filter should be installed to prevent any sediment from reaching the pump.

9.5.2 Dry Feed Systems

9.5.2.1 Storage

Bulk dry alum can be transferred with screw conveyors, bucket elevators, or pneumatic conveyors. Bags and drums of alum should be stored in dry locations. Day hoppers receiving alum from bags or drums should have a minimum storage capacity of eight hours at the maximum expected feed rate. Hopper bottoms should have a minimum wall slope of 60 degrees to prevent arching. A typical bulk storage tank for dry chemicals is shown in Figure 9-3.

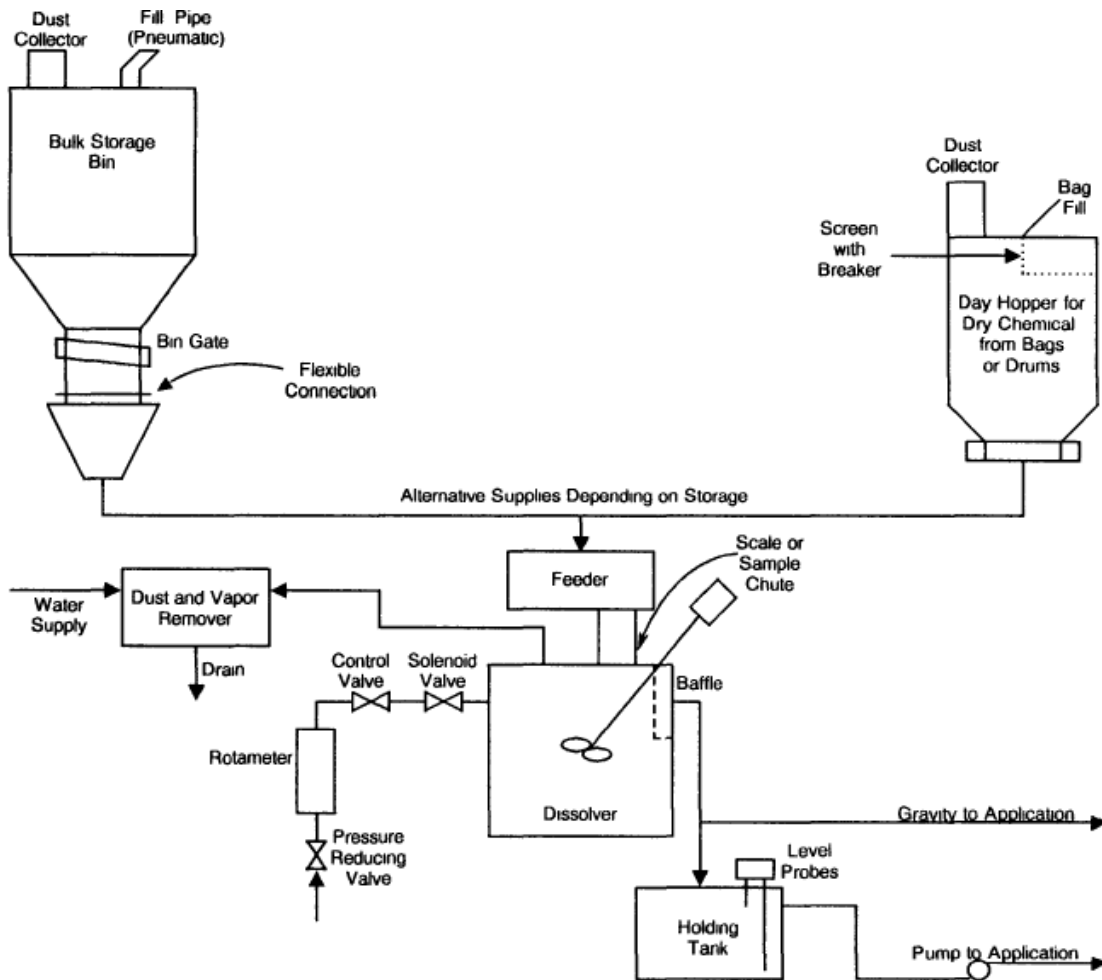

Figure 9-3. Typical dry chemical feed system.
 Source: USEPA (1987b), cited in Tchobanoglous et al. (2003)

9.5.2.2 Feed Methods

The following strategy for feeding applies to dry chemicals:

- Water is blended with the chemical in a mechanically-agitated dissolving tank or solution tank.
- For bulk chemicals, a water meter in conjunction with a variable rate feeder achieves a continuous stream of the solution at the proper strength.
- For bags or containers, the proper solution is made up manually on a batch basis.

Depending on the type of chemical, various feeding protocols are necessary:

- Alum, sodium aluminate or dry ferrous sulfate –

- Recommended minimum solution strength is 6 percent or 0.06 kg/liter of water (0.5 lb/gal).
- Detention time in the dissolver should be 5 minutes at the maximum feed rate.
- Ferric sulfate –
 - Solutions are made up at a water-to-chemical weight ratio of 2:1 to 8:1, with a typical ratio being 4:1 or 0.25 kg Fe₂SO₄/Liter of water (2.1 lb/gal).
 - Solutions under 1 percent strength are subject to hydrolysis and deposition of ferric hydroxide.

The degree of automation in dry chemical dissolution systems will depend on the size of the plant and daily chemical usage. For plants treating less than 1 million gallon per day (MGD), manual preparation of the chemical solution on a batch basis may be sufficient. This is typically accomplished in a day tank in which dry, bagged chemical is mechanically mixed with water to reach the desired concentration. For larger facilities, the chemical solution is prepared automatically using a controller that adjusts feed rate of dry chemical in proportion to potable water flow rate (as shown in Figure 9-3 in Section 9.5.2.1) (Daniels 1973).

Volumetric feeders are the least expensive option and can be used where cost is a concern, chemical delivery rates are low, and great accuracy is not required. Volumetric feeders generally employ a screw feed mechanism.

Loss-in-weight gravimetric feeders provide a high degree of accuracy (up to 99 percent accurate) and are recommended where close control of chemical dosages can result in substantial savings in chemical costs. Belt gravimetric feeders are intermediate in cost between volumetric and loss-in-weight gravimetric feeders, and can provide accurate and reliable service.

In general, closed construction is preferable for chemical feeders, because this exposes a minimum of operating components to the corrosive vapors from the dissolving or solution tank. Gravimetric feeders offer the following advantages over volumetric feeders:

- Calibration usually not required
- Greater accuracy and dependability
- Incorporation of totalizer to allow maintenance of accurate records and inventories
- Automatic proportioning
- Low maintenance; simple operation

9.5.2.3 Lime Slaking

Lime is available either as powdered hydrated lime or as pebble quicklime. Powdered hydrated lime tends to be more convenient because it has already gone through the slaking process. Slaking is a messy process that requires special considerations because of the inherent nature of lime:

- The reaction of lime and water generates a large amount of heat.
- Caustic properties create a hazard to operators and equipment.

- Chemical handling creates lime dust.
- Lime has a tendency to precipitate out during slaking.
- Lime can cake when exposed to moisture and carbon dioxide in air.
- Lime can form a hard scale on equipment.

Due to the added cost of slaking, hydrated lime costs about 30 percent more than quicklime and can produce extra dust during handling. However, the system can avoid the burden of slaking, and hydrated lime tends to have a more stable storage life. For plants that use at least 2 to 3 tons of lime per day, bulk quicklime may be the most affordable option. The best quality of quicklime has a high percentage of purity (greater than 62 percent quicklime) and quick slaking ability. For plants where lime use is not required daily, hydrated lime may be better in terms of convenience and storage (WEF and ASCE 1998).

9.6 Designing for Rapid Mix and Flocculation

Rapid mix is a brief process where the chemical dose is vigorously blended with wastewater. Chemicals should be dispersed uniformly to ensure formation of precipitates. Recent research has confirmed that rapid mixing at the point of chemical dosage is critical for efficient phosphorus removal using iron salts (Smith et al. 2007).

The rapid mixing process is followed by flocculation (slow mixing) to allow agglomeration of solids to form larger flocs with improved settling characteristics. It is important to minimize agitation of the water during flocculation to prevent floc destruction. Existing plant components such as aerated grit chambers, aerated distribution channels, or feed wells of clarifiers are commonly used for flocculation, often after some modification.

This section provides information on mixer configurations available for rapid mix and flocculation and guidance on setting design parameters.

9.6.1 Types of Mixers

Mixers are designed to achieve the goals of the type of mixing intended. Rapid mixing is a shorter, faster process meant to maximize contact of coagulants and polymer with the wastewater, while flocculation requires longer hydraulic retention times (HRTs) and more careful agitation to increase floc size and settling. Typical mixer designs for both rapid mix and flocculation are described in Table 9-4.

Table 9-4. Commonly Used Equipment for Rapid Mixing

Type of Mixing	Mixing Equipment	General Description	Design Options
Rapid Mix	Static in-line mixer	Unique in that they have no moving parts and provide mixing by using vanes or plates to cause sudden changes in flow direction. Most common type of in-line mixer.	Mixing time varies with length of mixer. Degree of mixing related to pressure drop through the mixer. Better mixing results in larger pressure drops.
	In-line mixer	Similar to static in-line but contain rotating mixing element to enhance process.	Power can be provided by an external source or by the turbulence created by the configuration of the mixer and rotating element.
	High-speed induction mixer	An impeller is rotated at a sufficient speed to cause a vacuum behind the impeller. This vacuum pressure is then used to draw chemicals to the impeller.	High speeds can result in instantaneous dispersion of chemicals.
	Pressurized water jets	Chemical is added through a high pressure water jet. The velocity of the jet must be high enough to mix water in all parts of the pipeline.	A small diameter reactor tube can increase mixing effectiveness; power provided by solution feed pump.
	Rotating impeller (Turbine or propeller)	Constructed with vertical shaft driven by electrical motor. Impellers mounted on the shaft provide mixing. Flow can be horizontal or vertical. Turbines are, in general, higher velocity, and greater turbulence leads to improved mixing. High-speed mixers with small impellers are better for rapid mix, while slow-speed mixers with larger impellers are used for flocculation.	Two basic impeller types are (1) radial-flow impellers with flat or curved blades mounted parallel to the axis of the shaft, and (2) axial-flow impellers at an angle < 90° with the drive shaft. Axial-flow impellers can be variable pitch-constant angle or constant pitch-variable angle. Small mixers revolve at 1750 rpm, large mixers revolve at 400 to 800 rpm; more than one propeller may be mounted on the same shaft.
Flocculation	Static	Wastewater is subjected to reversals in flow	May include flow channels laid out horizontally to cause energy-producing friction; channel spacing may be designed to decrease energy over time to keep large flocs from breaking apart
	Paddle	Consists of a series of paddles spaced apart and mounted to a shaft; slow moving paddles promote gentle flocculation. Less commonly used than other methods because of maintenance issues.	Paddles mounted on horizontal or vertical shaft; agitation speed important to promote floc formation and maintaining floc size for settleability.
	Turbine and Propeller	3 to 4 blades mounted to a vertical shaft.	Blades may be rectangular or hydrofoil shaped; specific design meant to reduce floc shearing; consider size related to power and pumping; tip speed and superficial velocity.
	Ballasted	Uses continuously recycled media and a variety of additives to improve settling properties of suspended solids through improved floc bridges.	Examples of proprietary designs include Actiflo®, DensaDeg®, CoMag®, and Lamella® plate clarification system.

Source: Tchobanoglous et al. (2003); USEPA (2003)

Often, movement of wastewater through the plant is sufficient for flocculation, although care should be taken not to disrupt floc formation through pumping or aeration. Another approach is to use a flocculating clarifier, in which an expanded center well provides the desired detention time for slow mixing. The contents of the flocculation well can be agitated by mechanical mixers or diffused air, although the hydraulic regime in the center well may be such that mechanical or air mixing does not provide additional benefit. Although not common, mechanical flocculation using a mixer or air agitation can be used to improve performance of clarifiers. Proprietary technologies using ballasted flocculation combine rapid mix, flocculation, and sedimentation in one unit. They can significantly reduce footprint requirements and can be very effective at phosphorus removal. Chapter 6, section 6.3.1 provides a description of several proprietary technologies.

9.6.2 Design Factors

The most important parameters for designing rapid mix and flocculation systems are the velocity gradient (G), the hydraulic detention time (t), and the vessel geometry. For static mixers, the degree of mixing is related to the headloss through the mixer. For any kind of rotating impeller system (for rapid mix or flocculation), the important design parameters are the rotational speed (n) and the ratio of the impeller diameter to the equivalent tank diameter (D/T_e). For paddle flocculators, the power is related to the drag force on the paddles. Each of these design factors is discussed below. A summary of key parameters is provided in Section 9.6.3. For additional guidance and example calculations, see Chapter 5 of Tchobanoglous et al. (2003) and WEF and ASCE (1998).

9.6.2.1 Velocity Gradient

The velocity gradient is a measure of the shear intensity imparted to a fluid. It can be estimated using the following equation (Tchobanoglous et al. 2003):

$$G = [P/V\mu]^{1/2} \quad \text{Eq. 9-1}$$

Where:

- G = Velocity gradient, second⁻¹
- P = Power requirement, W ($\text{kg m}^2 \text{s}^{-3}$)
- μ = Absolute fluid viscosity, $\text{kg m}^{-1} \text{second}^{-1}$
- V = Basin volume, m^3

For rapid mix, Smith et al. (2007) recommends G values greater than 300 seconds⁻¹, although velocity gradients of up to 1,000 seconds⁻¹ have been recommended (Barth and Stensel 1981). Velocity gradients for flocculation processes generally are 30-60 seconds⁻¹, depending on the chemicals added and point of addition (Tchobanoglous et al. 2003). Lower velocity gradients may yield floc particles with too much trapped water, whereas higher velocity gradients may cause excessive floc shear and floc deterioration.

In some cases, chemicals are added directly to the activated sludge process with no additional mixing other than that already designed for aeration and mixing of solids and mixed liquor in the basin. Although this practice can be effective, it represents less than ideal conditions for flocculation, as velocity gradients in aeration basins usually result in floc shear. In one study, air flowrates in the downstream end of the aeration basin were reduced to achieve a velocity gradient of 60 seconds⁻¹,

which was found to be optimum for flocculation using ferric chloride (Singhal 1980). Addition of anionic polymer prior to clarification assists in the agglomeration of sheared floc.

9.6.2.2 Power Requirements

If a target velocity gradient has been selected, designers can derive the theoretical power requirement using equation 9-1, solving for P as follows:

$$P = G^2 \mu V \quad \text{Eq. 9-2}$$

For rotating impeller systems, the power is related to the revolutions per second and diameter of the impeller by the following equation:

$$P = N_p \rho n^3 D^5 \quad \text{Eq. 9-3}$$

Where:

- P = Power input, W
- N_p = Power number for the impeller, unitless
- ρ = Mass density of the fluid, kg/m^3
- n = Impeller revolutions per second, s^{-1}
- D = Diameter of the impeller, m

Pumping capacity of the mixer can be estimated using similar inputs:

$$Q_i = N_Q n D^3 \quad \text{Eq. 9-4}$$

Where:

- Q_i = pump discharge, m^3/sec
- N_Q = flow number of the impeller, unitless

Power numbers and flow numbers for different types of impellers along with qualitative information on pumping capacity are provided in Table 9-5. Designers should consult manufacturers for power and flow numbers for a specific piece of mixing equipment.

Table 9-5. Values of N_p and N_Q for Various Types of Impellers

Type of Impeller	N_p	N_Q	Pumping Capacity
Vertical flat-blade turbine (VBT)	3.5 – 4	0.84 – 0.086	Low
Disk turbine			Low
Pitched-blade turbine (45° PBT)	1.6	0.084 – 0.086	
Pitched-blade turbine (32° PBT)	1.1	0.084 – 0.086	Moderate
Low-shear hydrofoil (LS, 3-blade)	0.30	0.50	High
Low-shear hydrofoil (LS, 4-blade)	0.60	0.55	High
Propeller			High

Source: Tchobanoglous et al. (2003), Table 5-12

Equation 9-3 applies if the flow is turbulent (i.e., the Reynolds number, N_R , is greater than 10,000), which is generally the case for rapid mix designs. When mechanical paddle mixers are used for flocculation, power is related to the drag force on the paddles as follows (Tchobanoglous et al. 2003):

$$P = (C_D A \rho v_p^2) / 2 \quad \text{Eq. 9-5}$$

Where:

- P = Power requirement, W
- C_D = Coefficient of drag of paddle moving perpendicular to fluid, unitless
- A = Cross sectional area of the paddles, m^2
- ρ = Mass density of the fluid, kg/m^3
- v_p = Relative velocity of the paddles with respect to the fluid, m/s, usually assumed to be 0.6 to 0.75 times the paddle-tip speed.

This equation can be rearranged to determine the required paddle area for the required power, as derived using equation 9-2.

For static mixers, the key parameter for design is not power required since there are no moving parts, but headloss through the mixer. The headloss can be estimated as follows:

$$h = K_{SM} v^2 \quad \text{Eq. 9-6}$$

Where:

- h = Headloss across the static mixer, m
- K_{SM} = Overall coefficient for the static mixer, sec^2/m , as provided by the manufacturer
- v = Approach velocity, m/sec

9.6.2.3 Hydraulic Retention Time

The hydraulic retention (or detention) time is the amount of time a unit of the process flow stays within a tank for a given flowrate. It is calculated as follows:

$$t = V/Q \quad \text{Eq. 9-7}$$

Where:

- t = Hydraulic retention time, seconds
- V = Reactor volume, ft^3 or m^3
- Q = Flow rate, ft^3/sec or m^3/sec

Depending on the mixing device and chemical coagulant chosen, a chemical addition process will require different rates of rapid mixing to ensure adequate hydraulic retention time, but still limit contact in the mixer. For example, static in-line mixers, in-line mixers, and high-speed induction mixers are used for alum, ferric chloride, and cationic polymer when instantaneous mixing is required. A hydraulic retention time of only 1 second or less is required for these types of mixers because the chemical precipitants tend to have a fast reaction rate. However, applications using lime may require between 10 and 30 seconds of hydraulic retention time since lime reacts more slowly with wastewater

(Tchobanoglous et al. 2003). Ten State Standards (2007) recommend a detention time of at least 30 seconds for basins equipped with mechanical mixing devices.

The process of the flocculation of small particles of solid phosphorus is not completely understood. These particles are affected by pH and the surface chemistry of the metal-to-phosphorus complexes (WERF 2008). Smith et al. (2008) reported that floc aging may contribute to a decrease in the phosphorus removal efficiency of wastewater. Spent flocs can be recycled to promote flocculation in the wastewater stream, but based on this research, the effect of floc age on decreasing floc surface area and the related ability to bind with phosphorus should be considered. Despite the somewhat lesser understood facts about flocculation, it is commonly known that polymer can improve flocculation. The polymer works by capturing small colloidal particles and helping them to join via the long chain polymer molecules to form larger particles that will settle out more readily.

9.6.2.4 Vessel Geometry

Vessels for rapid mixing should be designed to avoid the formation of vortices. If the vessel is small, the impellers should be mounted off-center or at an angle. For larger vessels, designers commonly avoid vortexing by installing four or more vertical baffles (also called stator baffles) extending approximately 1/10th to 1/12th of the diameter out from the wall (Tchobanoglous et al. 2003). Vortexing can also be minimized by choosing a flat bladed impeller instead of a fan or propeller impeller and introducing chemicals at the blade level.

The ratio of the impeller diameter to the effective tank diameter (D/T_e) is an important parameter for design and depends on whether the flow moves horizontally or vertically through the mixing vessel. Tchobanoglous et al. (2003) recommend D/T_e values of 0.25 to 0.4 for horizontal flow vessels and 0.40 to 0.60 for vertical flow vessels. Note that T_e for rectangular basins can be estimated as follows:

$$T_e = 1.13 (L \times W)^{1/2} \quad \text{Eq. 9-8}$$

Where:

- T_e = Effective diameter for a rectangular tank, m
- L = Basin length, m
- W = Basin width, m

9.6.3 Summary of Typical Design Parameters

Table 9-6 summarizes typical design parameters for rapid mix. These values should be used as general guidelines; final design values for velocity gradient and hydraulic retention time should be established during jar or pilot testing and based on manufacturers' recommendations. Design parameters for ballasted systems are provided in the EPA Wastewater Technology Fact Sheet, *Ballasted Flocculation* (USEPA 2003), available online at http://www.epa.gov/owm/mtb/ballasted_flocculation.pdf.

Table 9-6. Typical Design Parameters for Turbine and Propeller Mixers

Parameter	Symbol	Unit	Value
Horizontal-flow mixing			
Velocity gradient	G	1/s	500-2500
Rotational speed	N	rpm	40-125
Ratio impeller diameter to equivalent tank diameter	D/T_e	unitless	0.25-0.40
Vertical-flow mixing			
Velocity gradient	G	1/s	500-2500
Rotational speed	N	rpm	25-45
Ratio impeller diameter to equivalent tank diameter	D/T_e	unitless	0.40-0.60

Source: Tchobanoglous et al. (2003), Table 5-11

9.7 Solids Separation Processes

Although chemical addition remains a reliable method for phosphorus removal, there have been few dramatic changes in both the types of chemicals available and their applications. However, to fill the need for lower and lower effluent phosphorus requirements, the field of solids separation has expanded to provide more effective options for removing insoluble phosphorus.

The options for solids separation depend on a multiple barrier approach—stand alone processes may be used for solids separation, but depending on treatment goals, two or more systems together may be able to achieve lower and more reliable phosphorus concentrations. In general, the solids separation process ranges from the conventional to the advanced as follows (WERF 2008):

- Conventional sedimentation uses clarifiers for settling of floc, and, much of the time, follows that with the secondary barrier of a filtration process to remove additional solids.
- High rate flocculation and sedimentation includes a more advanced clarifier to process larger volumes of wastewater more quickly (e.g. ballasted flocculation/sedimentation, lamella® tube settlers). Commonly followed by filtration.
- The direct filtration method uses a single barrier approach with no sedimentation.
- Two-stage filtration uses multiple filters.
- Microfiltration or ultrafiltration theoretically removes all insoluble phosphorus since the filter size is under the 0.45 μm usually considered to be the limit of insolubility; in practice, membrane defects can lessen filter effectiveness.

- Ballasted separation and magnetic polishing, such as the patented CoMag® process discussed later in this section.

9.7.1 Primary and Secondary Clarification

Solids separation processes can be applied at various locations in the process train, typically directly following chemical addition. When chemicals are added prior to primary or secondary clarification, clarifier design becomes a key factor in removal of the precipitated phosphorus. Clarifiers used in chemical precipitation systems differ little from those employed in conventional biological treatment, although use of flocculation zones is recommended to allow flocculation to occur after addition of coagulants. Provision of distinct flocculation zones is recommended for either primary or secondary clarifiers, depending on the point of chemical addition. Distinct flocculation zones are particularly important for primary clarifiers, because there may be little opportunity for flocculation to occur in existing processes. For secondary chemical addition, flocculation can occur in aeration basins or channels preceding clarification, but the use of flocculation zones in secondary clarifiers is a recommended practice as it allows flexibility in the point of chemical addition and provides a zone in which direct control can be exercised over velocity gradients to achieve optimum flocculation.

The WEF Manual of Practice FD-8, Clarifier Design (WEF 2005) provides detailed design guidance for achieving solids removals in clarifiers including recommended design standards, software modeling, details on processes and equipment, and performance monitoring and control. Bott et al. (2007) report that solids removal through conventional clarifiers can reliably remove TP to effluent levels between 0.5 and 1.0 mg/L, and lower effluent levels can frequently be obtained.

9.7.2 Tertiary Processes

Tertiary processes (post-secondary treatment) use clarification, some form of filtration technology, or both and can be used to consistently remove phosphorus to very low (< 0.1 mg/L) concentrations. Tertiary clarifiers can be conventional, one or two sludge lime (second sludge includes recarbonation and settling), solids contact, high rate, and ballasted-high rate. They are sized on the same basis as primary and secondary units. High rate and ballasted high rate clarification is typically combined with flocculation and rapid mixing in proprietary systems. These proprietary systems have been described previously in Section 9.6. Chapter 6 summarizes tertiary filtration technologies with design guidelines presented in Chapter 11 of this manual.

9.8 Operational Factors

9.8.1 Dose Control

The success of phosphorus removal by chemical addition depends on proper instrumentation and control. Dosage control typically takes the form of manual operation (for small systems), adjustments based on automatic flow measurements, or the more advanced on-line analyzers with automated dosage control. Flow-paced dosing (feed-forward control) is common. More advanced control systems may use online phosphate analyzers or oxidation reduction potential (ORP) for control. See Chapter 13 of this design manual for additional information on control strategies.

9.8.2 Make-up Water

Chemical properties of any water used for making solutions should be considered—tap water high in dissolved solids could cause sludge to form when mixed with coagulants (WEF and ASCE 1998) and could lead to clogging of chemical feed lines.

9.8.3 Sludge Production and Handling

Chemical precipitation methods always produce additional solids due to generation of metal- or calcium- phosphate precipitates and additional suspended solids. Lime traditionally produces a higher sludge volume compared to metal salts because of its reaction with natural alkalinity. An advantage of lime sludge is that some stabilization can occur due to the high pH levels required. One disadvantage is that lime can cause scaling in mechanical thickening and dewatering systems. Although it tends to produce less sludge than do ferric salts, alum sludge can be more difficult to concentrate and dewater compared to the ferric sludge.

Stoichiometric equations for estimating sludge production are provided in Section 3.5 of this design manual, but a good rule of thumb is about 10 g of chemical sludge per g P removed by chemical treatment. Example calculations are provided in the text box on the next page.

Example 9-2: Determining Increase in Sludge Production from Addition of Ferric Chloride in Example 9-1

Problem: A WWTP operator wants to use ferric chloride (FeCl_3) to remove phosphate in the secondary clarifier. The plant's flow rate is 1.0 MGD, and the measured phosphate concentration entering the secondary clarifier is 4 mg/L as P. From Example 9-1 and confirmed through jar testing, 74.8 gallons of ferric chloride solution will be added per day to remove up to 98 percent of the phosphate. The operator wants to estimate the mass of additional solids that will need to be removed from the secondary clarifier as a result of the ferric chloride addition.

Constants:

Ferric chloride solution strength = 40 percent

Density of ferric chloride solution = 1.4 kg/L

Molecular weight of Fe = 55.85; Molecular weight of FeCl_3 = 162.2; Molecular weight of P = 30.97

Molecular weight of O = 16; Molecular weight of H = 1

Solution:

1. Assume that the phosphorus removed will be contained in the following precipitate with iron as $\text{Fe}_{1.6}(\text{H}_2\text{PO}_4)(\text{OH})_{3.8}$ and the remainder of the iron added will be as $\text{Fe}(\text{OH})_3$. See Chapter 3, Section 3.5 for additional discussion.
2. Calculate the millimoles per liter (mM/L) of iron added per day that precipitates as mM/L of $\text{Fe}_{1.6}(\text{H}_2\text{PO}_4)(\text{OH})_{3.8}$ and as mM/L of $\text{Fe}(\text{OH})_3$ precipitate.
 - a. P removed as mM/L = $(0.98)(4 \text{ mg P/L}) / (30.97 \text{ mg P/mM P}) = 0.127 \text{ mM P removed/L}$.
 - b. The amount of iron added was 2.0 mM Fe/mM P in feed. Fe added as mM/L = $(2.0 \text{ mM Fe/mM P})(4 \text{ mg P/L}) / (30.97 \text{ mg P/mM P}) = 0.258 \text{ mM Fe/L}$
 - c. Precipitate as mM Fe/L in $\text{Fe}_{1.6}(\text{H}_2\text{PO}_4)(\text{OH})_{3.8} = 1.6 \text{ mM Fe/mM P removed} = (1.6)(0.127 \text{ mM P removed/L}) = 0.203 \text{ mM Fe/L}$
 - d. Precipitate as Fe in $\text{Fe}(\text{OH})_3 = \text{mM/L of Fe added} - \text{mM/L of Fe in } \text{Fe}_{1.6}(\text{H}_2\text{PO}_4)(\text{OH})_{3.8} = 0.258 \text{ mM Fe added/L} - 0.203 \text{ mM Fe/L} = 0.055 \text{ mM Fe in } \text{Fe}(\text{OH})_3/\text{L}$
3. Calculate sludge production as sum of $\text{Fe}_{1.6}(\text{H}_2\text{PO}_4)(\text{OH})_{3.8}$ and $\text{Fe}(\text{OH})_3$.
 - a. MW of $\text{Fe}_{1.6}(\text{H}_2\text{PO}_4)(\text{OH})_{3.8} = 1.6(55.85) + 2 + 30.97 + (4)(16) + 3.8(16) + 3.8(1) = 250.9$; MW of $\text{Fe}(\text{OH})_3 = 55.85 + (3)(16) + (3)(1) = 106.85$
 - b. Sludge as $\text{Fe}_{1.6}(\text{H}_2\text{PO}_4)(\text{OH})_{3.8} = 0.203 \text{ mM Fe/L} (1.0 \text{ mM } \text{Fe}_{1.6}(\text{H}_2\text{PO}_4)(\text{OH})_{3.8} / 1.6 \text{ mM Fe})(250.9 \text{ mg/mM}) = 31.83 \text{ mg/L}$
 - c. Sludge as $\text{Fe}(\text{OH})_3 = 0.056 \text{ mM Fe/L} (1.0 \text{ mM } \text{Fe}(\text{OH})_3 / \text{mM Fe})(106.85) = 5.98 \text{ mg/L}$
 - d. Total sludge production from FeCl_3 addition = $31.83 + 5.98 = 37.8 \text{ mg/L} = (37.8 \text{ mg/L})(8.34 \text{ lb/MG-mg/L})(1.0 \text{ MGD}) = 315.4 \text{ lb/d} (143.1 \text{ Kg/d})$

The inorganic sludge production of 315.4 lb/d (143.1 kg/day) is in addition to what would be removed without the addition of ferric chloride. This is an initial design estimate and may vary depending on wastewater conditions and the point of addition.

9.8.4 pH Adjustment

Depending on the wastewater composition and pH, pH adjustment may be necessary to achieve efficient phosphorus removal with chemical addition. Other uses for pH adjustment include the neutralization of the wastewater flow either following chemical addition and prior to biological treatment, or prior to effluent discharge. The important components of a pH adjustment process include the wastewater flow rate, hydraulic retention time, and the precision of the chemical metering system. Laboratory titration experiments are generally necessary to determine the correct dose of acid or base (WEF and ASCE 1998). Target pH values for optimum results vary with the chemical being used, and typical values are given in the literature. However, jar tests should be used to determine and confirm the specific optimum value for the chemical and wastewater being reacted.

Raising the pH of an acidic wastewater stream is generally accomplished through the use of lime, such as high calcium lime, quicklime, hydrated or slaked lime, or dolomitic lime. Calcium and magnesium oxides or hydroxides may also be used in a mixture. Lime products tend to be insoluble and require longer retention times than other chemicals—calcium and magnesium oxides in particular require long HRTs, but are favored due to their relative low cost. As with other applications of lime, lime used for pH adjustment creates a significant amount of sludge. Caustic soda and soda ash are much more soluble, create less sludge, and react much more quickly with acid in wastewater. The higher cost of caustic soda and soda ash compared to lime compounds should be factored into any decision-making process. Dry soda ash can be fed by a continuous feeder using volumetric, gravimetric, or loss-in-weight gravimetric mechanical feeders, while a solution feed can be pumped (WEF and ASCE 1998).

Lowering a high pH to a more neutral level for effluent discharge may take place via an acid feed system that adds small quantities of sulfuric acid or hydrochloric acid to the wastewater. For larger systems, the acid solution may be applied at the point of discharge. Nitric acid is readily available but generally not preferred due to the addition of nitrogen species (WEF and ASCE 1998).

9.8.5 Effect on Biosolids Application

The use of metal salts can lead to large increases in inorganic solids in the sludge, which can result in increased inorganic salts (salinity) in sludge and in the effluent. Salinity can create problems when biosolids are land applied or when the effluent is returned to existing water supply reservoirs. Biological phosphorus removal was developed in South Africa due to the high rate of indirect recycling of wastewater effluent, which led to excessive total dissolved solids (TDS) during dry periods. High total salts can reduce germination rate for crops and negatively affect the soil structure.

9.9 References

10 States Standards. 2007. Recommended Standards for Water Works, 2007 Edition: Policies for the Review and Approval of Plans and Specifications for Public Water Supplies. Water Supply Committee of the Great Lakes - Upper Mississippi River Board of State and Provincial Public Health and Environmental Managers. Available online: <http://10statesstandards.com/waterstandards.html>

American Public Health Association (APHA), AWWA, and Water Environment Federation (WEF). 1998. *Standard Methods for the Examination of Water and Wastewater*. 20th Edition. 220 pp. Washington, D.C.: APHA, AWWA, and WEF.

- ASCE. 1977. Wastewater Treatment Plant Design. ASCE Manual No. 36. WPCF Manual of Practice No. 8, American Society of Civil Engineers, New York, NY and Water Pollution Control Federation, Washington, DC, 1977.
- Barth, E.F. and H.D. Stensel. 1981. International Nutrient Control Technology for Municipal Effluents. JWPCF 53(12):1691-1701.
- Black, S.A. 1980. *Experience with Phosphorus Removal at Existing Ontario Municipal Wastewater Treatment Plants*. In: Phosphorus Management Strategies for Lakes, eds: RC. Loehr, C.S. Martin, W. Rast. Ann Arbor Science Publishers, Inc. Ann Arbor, MI.
- Bott, C.B., S. N. Murthy, T. T. Spano, and C.W. Randall. 2007. WERF Workshop on Nutrient Removal: How Low Can We Go and What is Stopping Us from Going Lower? Alexandria, VA: WERF. ChemExpo. 2000. Online Chemical Exposition, Archives. May 2000.
- City of East Moline. 2007. Minutes of the Meeting of the Mayor and the Committee-of-the-Whole of the City of East Moline, Illinois. November 19. Available online: <http://www.eastmoline.com/Minutes/COW/11-19-07.cfm?MonthChange=None&eventid=78&LastDate=08/31/2008>
- City of Santa Cruz. 2006. Ferric Chloride for the Wastewater Treatment Facility – Amendment #1 to Sole Source Purchase Agreement. City Council Agenda Report. City of Santa Cruz, CA. February 9.
- Culp, R.L., Wesner, G.M. and G.L. Culp. 1978. *Handbook of Advanced Wastewater Treatment*. Second Edition. Van Nostrand Reinhold Company, New York.
- Daniels, S.L. 1973. Instrumentation and Automatic Control of Phosphorus Removal Processes. In: *Phosphorus Removal Design Seminar, Conference Proceedings No. 1*. Toronto, Canada. May 28-29.
- EPA Region 10. 2007. Advanced Wastewater Treatment to Achieve Low Concentration of Phosphorus. EPA 910-R-07-002.
- Infilco Degremont, 2000. Design information on the DensaDeg system.
- Gulbrandsen. 2008. Polyaluminum Chloride Solution Product Description. Clinton, NJ: Gulbrandsen Technologies, Inc. Available online: http://www.gulbrandsen.com/pdf/PolyalumCl_4.pdf
- Heim, N.E and B.E Burris. 1979. *Chemical Aids Manual for Wastewater Treatment Facilities*. NTIS No. PB-116816, U.S. Environmental Protection Agency, Office of Water Program Operations, Washington, DC. EPA-430/9-79 018.
- Hortskotte, G.A., D.G. Niles, D.S. Parker, and D. H. Caldwell. 1974. Full-scale testing of a water reclamation system. *Journal of the Water Pollution Control Federation*. 46(1): 181-197.
- Miller, M.M. 2008. 2007 Minerals Yearbook: Lime [Advance Release]. U.S. Geological Survey. U.S. Department of the Interior. Available online: <http://minerals.usgs.gov/minerals/pubs/commodity/lime/myb1-2007-lime.pdf>
- Plank, D. 2008. "Chemical Prices Skyrocket, No End in Sight." *E-Mainstream*. AWWA. Posted 15 July. Available online: <http://www.awwa.org/publications/MainStreamArticle.cfm?itemnumber=39577>

- Poland, J. and T. Pagano. 1998. Jar Testing. *Water Treatment Primer*, CE 4124: Environmental Information Management. Civil Engineering Dept. Virginia Tech. Available online: <http://www.cee.vt.edu/ewr/environmental/teach/wtprimer/jartest/jartest.html>
- Reardon, R.D. 2005. Tertiary Clarifier Design Concepts and Considerations. Presented at WEFTEC 2005.
- Saginaw City Council. 2006. Memo: Water Treatment Plant Liquid Ferric Chloride Purchase. Bids received for chemical supply from July 1, 2006 – June 30, 2008. City of Saginaw, MI. Available online: <http://www.saginaw-mi.com>.
- Singhal, A.K. 1980. Phosphorus and Nitrogen Removal at Cadillac, Michigan. *JWPCF*. 52(11):2762-2770.
- Smith, S., A. Szabó, I. Takács, S. Murthy, I. Licskó, and G. Daigger. 2007. The Significance of Chemical Phosphorus Removal Theory for Engineering Practice. In *Nutrient Removal 2007*. WEF.
- Szabó, A., I. Takács, S. Murthy, G.T. Daigger, I. Licskó, and S. Smith. 2008. Significance of Design and Operational Variables in Chemical Phosphorus Removal. *Water Environment Research*. 80(5):407-416. Alexandria, VA: WEF.
- Smith, S., I. Takács, S. Murthy, G.T. Daigger, and A. Szabó. Phosphate Complexation Model and Its Implications for Chemical Phosphorus Removal. 2008. *Water Environment Research*. 80(5): 428-438. Alexandria, VA: WEF.
- Tchobanoglous, G., F. L. Burton, and H.D. Stensel. 2003. *Wastewater Engineering: Treatment and Reuse*. New York, NY: McGraw-Hill.
- US Filter Kruger, 2000. Design information on the Actiflo® process for wastewater.
- USEPA. 1975. *Process Design Manual for Suspended Solids Removal*. EPA-625/1-75-003a, NTIS No. PB-259147, U.S. Environmental Protection Agency, Center for Environmental Research Information, Cincinnati, OH, 1975.
- USEPA. 1976. *Process Design Manual for Phosphorus Removal*. Great Lakes National Program Office. GLNPO Library. EPA 625/1-76-001a. April 1976.
- USEPA. 1987a. Design Manual: Phosphorus Removal. Center for Environmental Research Information. Cincinnati, OH. EPA/625/1-87/001.
- USEPA 1987b. Retrofitting POTWs for Phosphorus Removal in the Chesapeake Bay Drainage Basin. Cincinnati, OH. EPA/625/6-87/017
- USEPA. 1999. Enhanced Coagulation and Enhanced Precipitative Softening Guidance Manual. Office of Water. EPA 815-R-99-012.
- USEPA. 2000. Wastewater Technology Fact Sheet: Chemical Precipitation. Office of Water. EPA 832-F-00-018.
- USEPA. 2003. Wastewater Technology Fact Sheet: Ballasted Flocculation. Office of Waste Management. Municipal Technology Branch. EPA 832-F-03-010.

- USEPA. 2008. Emerging Technologies for Wastewater Treatment and In-Plant Wet Weather Management. EPA 832-R-06-006. Available online:
http://www.epa.gov/OW-OWM.html/mtb/emerging_technologies.pdf
- WEF. 1983. *Nutrient Control*. WEF Manual of Practice No. FD-7. Water Environment Federation. Washington, DC.
- WEF. 2005. *Clarifier Design, 2nd Edition*. WEF Manual of Practice No. FD-8, Water Environment Federation, Washington, DC.
- WEF. 2008. Operations Glossary. [Accessed 1 October 2008]. Available online:
http://www.wef.org/ConferencesTraining/SkillsBuilder/Operations_Glossary.htm
- WEF and ASCE. 1998. Design of Municipal Wastewater Treatment Plants - MOP 8, 4th Ed. Water Environment Federation and American Society of Civil Engineers. Alexandria, VA: WEF.
- WEF and ASCE. 2006. Biological Nutrient Removal (BNR) Operation in Wastewater Treatment Plants - MOP 29. Water Environment Federation and the American Society of Civil Engineers. Alexandria, VA: WEF Press.
- WEF and ASCE. 2009. *Design of Municipal Wastewater Treatment Plants – WEF Manual of Practice 8 and ASCE Manuals and Reports on Engineering Practice No. 76, 5th Ed.* Water Environment Federation, Alexandria, VA, and American Society of Civil Engineers Environment & Water Resources Institute, Reston, Va.
- WERF. 2008. Nutrient Compendium. Chapter 1, Tertiary Phosphorus Removal. Available online:
<http://www.werfnutrientchallenge.org/chapter1.asp?area=ch1>
- Wilkes, W. 1973. Phosphorus Removal by Chemical Addition Using Primary Treatment. In: *Phosphorus Removal Design Seminar, Conference Proceedings No.1*, Toronto, Canada, May 28-29.
- Yuba City. 2007. Agenda for Staff Report on Chemicals (FB 07-07). City of Yuba City, CA. Available online: <http://www.yubacity.net/documents/Agendas/2007/041707Council/041707AgendaItem9.pdf>

10. Design Approach for Biological Nutrient Removal

Chapter 10 covers:

- 10.1 Introduction
- 10.2 Preliminary Design Approach
- 10.3 Overview of Recommended Approach for Plant Modeling
- 10.4 Establishing Objectives and Requirements
- 10.5 Selecting a Process Simulator
- 10.6 Data Collection
- 10.7 Characterization of Organic Material
- 10.8 Characterization of Nutrient Fractions
- 10.9 Kinetic and Stoichiometric Parameters
- 10.10 Calibration
- 10.11 Validation
- 10.12 Simulation of Design Alternatives for Nutrient Removal
- 10.13 Additional Procedures for Design
- 10.14 Design Checks for Nitrogen and Phosphorus Removal
- 10.15 References

10.1 Introduction

By this stage of the process, design engineers should have completed the following steps:

- Reviewed the mechanisms for biological nutrient removal at wastewater treatment plants (WWTPs) (see Chapters 4 and 5).
- Characterized the wastewater and established design objectives (see Chapter 7).
- Reviewed flow sheets and other information on available treatment methods for biological nutrient removal (see Chapter 6).
- Selected candidate processes for the plant upgrade (see Chapter 8).

The designer is now ready to select and design the final upgrade option (or start process selection for Greenfield plants) and the operating conditions under which the plant can achieve desired objectives for nutrient reduction.

Although process design for WWTP upgrades for biological nutrient removal can still be done using traditional engineering methods (i.e., hand calculations or spreadsheets using theoretical equations), process simulators¹ have become increasingly powerful, easy to use, and widely accepted in

¹ For the purposes of this design manual, “mathematical models” or more simply “models” are sets of equations that describe a physical system. Examples include the activated sludge models (ASM), biofilm models, and computational fluid dynamic (CFD) models for secondary clarifiers. “Process simulators” or “simulators” are computer programs that allow the user to specify all the processes of a WWTP, select models for each, and solve the models to predict plant performance. Examples are BioWin and GPS-X (See Table 10-1 for a full list)

recent years. Simulators, which solve mathematical models and typically provide results in a user-friendly format, allow designers to study kinetic- as well as time-based solutions while determining the total mass balances of many constituents. WEF and ASCE (2010) note that “The complexity of biological activity and reactor behavior and the number of variables important to nutrient removal require the use of computer models for detailed solutions.”

Simulators have many additional advantages over traditional design. Designers can use simulators to quickly test many different treatment configurations and design parameters in a fraction of the time and cost it would take to perform traditional design calculations and laboratory or pilot tests. The additional cost of development (e.g., cost of setting up the simulator, special sampling to define inputs) is usually small compared to the monetary benefits of more accurate predictions and thus, lower safety factors in design. For these reasons, simulation has become the preferred method of process design for biological nutrient removal at WWTPs.

Benefits of Using Models for Process Design

The traditional approach for designing biological nutrient removal systems (e.g., for nitrification) was to determine solids residence time (SRT) based on kinetic equations, then to apply a safety factor based on engineering judgment. The new method currently being used by design engineers is to determine site specific nitrification kinetics based on influent quality and perform dynamic modeling of the system to capture variability. Lower safety factors can be used in design with more confidence that the plant can achieve the desired treatment objectives under a variety of operating conditions.

Although models are the preferred method for design of biological nutrient removal, there may be instances where preliminary hand or spreadsheet calculations can be useful alone or as a check on modeled output. Most engineering firms have used the mathematical equations found in Chapters 4 and 5 of this manual in a spreadsheet to estimate the basins sizes. Such spreadsheets can be developed to estimate the following:

- Size of the anaerobic zone.
- Solids Residence Time (SRT) requirements for nitrification at minimum expected mixed liquor temperature.
- Minimum requirements for denitrification zones.
- Mixed liquor recycle rates.
- Oxygen requirements for nitrification and carbon removal.
- Production of surplus, i.e. waste activated sludge (WAS).
- Clarifier size requirements.
- Return activated sludge (RAS) pumping ranges.
- Effect of approximate peaking factors.

Section 10.2 provides a methodology for a preliminary design approach using equations and graphs. The remainder of this chapter (Sections 10.3 through 10.14) presents the recommended modeling approach, providing practical guidance on how to use commercially available process simulators to design nutrient removal processes. This Chapter contains guidance on selecting a simulator, establishing model objectives and requirements, collecting and verifying data, calibrating and validating the model, and simulating alternatives. Examples are provided throughout.

This chapter assumes some familiarity with process simulators; readers using models for the first time should carefully review technical documentation and work with vendor representatives to get the simulator up and running properly. Readers are also encouraged to review industry standards and technical documents for additional recommendations on modeling protocols, wastewater characterization methods, and detailed calibration procedures. A particularly good reference is the 2003 Water Environment Research Foundation (WERF) report, *Methods for Wastewater Characterization in Activated Sludge Modeling* (Melcer et al. 2003). In addition, modelers should check for the pending publication of the International Water Association (IWA) Scientific Technical Report, *Good Modeling Practice (GMP) — Guidelines for Use of Activated Sludge Models* (IWA 2009). Historical background and information on underlying mathematical models is provided in Appendix C of this manual.

Accurate characterization of influent flow and plant operation is **critical** to modeling nutrient removal processes. Mistakes in characterization can have severe impacts on design. Thus, a good portion of this chapter is devoted to providing:

- Guidance on gathering input data
- Discussion of how the data are related
- Information on why these data are important in the design of nutrient removal processes

10.2 Preliminary Design Approach

For preliminary design, a simple step-by-step approach (provided below) can be used to estimate basin size for biological nutrient removal (nitrogen and phosphorus). Note that this methodology is not meant to be prescriptive – steps may be done in a different order and rules of thumb should be carefully evaluated by the designer and treatment plant operators. The key is that any methodology be based on the fundamental science of biological nutrient removal as presented in Chapters 4 and 5 of this manual. In addition to guidance in this section, the reader is also encouraged to review steps and example calculations provided in the USEPA Nitrogen Control Manual (1993) and newly updated Manual of Practice No. 8 by the Water Environment Federation (WEF) and the American Society of Civil Engineers (ASCE), *Design of Municipal Wastewater Treatment Plants* (WEF and ASCE 2010).

Step 1: Characterize the influent flow.

See Chapter 7, Section 7.4 for detailed guidance. Key factors for design are as follows:

- The lowest mixed liquor temperature for determination of required SRT. Usually based on the coldest temperature sustained for a two week period, but the period could be shorter if very low SRTs are being considered.

- The expected chemical oxygen demand (COD) to Total Kjeldahl Nitrogen (TKN) or biochemical oxygen demand (BOD²) to TKN ratio, and the COD to Total Phosphorus (TP) ratio. The desired ratio is that of the settled sewage if primary sedimentation is included in the treatment train. For complete denitrification, a COD/TKN ratio of more than 8 and a BOD/TKN ratio of more than 4 are needed. For biological phosphorus removal, a COD/TP ratio of greater than 40 and BOD/TKN ratio of more than 20 are needed when targeting effluent TP concentrations less than 1.0 mg/L. A more accurate ratio for enhanced biological phosphorus removal (EBPR) is the readily biodegradable COD (rbCOD) to TP ratio of the settled sewage (should be > 15, see Chapter 5 for discussion). Note that if rbCOD is present in a truly anaerobic reactor (no dissolved oxygen(DO), no nitrate or nitrite), some EBPR will always occur. The amount of soluble phosphorus in the plant effluent will depend upon the rbCOD/TP ratio available to the phosphorus storing (poly-P) bacteria in the anaerobic zone. The concentration of the poly-P bacteria in the activated sludge shifts as the rbCOD/TP ratio shifts.

Step 2: Determine the required SRT for nitrification.

Use graphs or equations provided in Chapter 4 to determine the minimum SRT for near complete nitrification. Multiply by a safety factor – this is typically greater than 2 or represented by the peak TKN divided by the median TKN in the process influent. Both of these approximations will provide a large safety factor that can be reduced using dynamic simulation with a calibrated computer model. Designers should carefully consider the effluent requirements including the required averaging period when selecting a safety factor for preliminary design. For example, if the effluent limit is 3.0 mg/L, a single value of 5.0 mg/L will be very difficult to average out if the averaging period is one month because there is little possibility of producing an effluent concentration of less than 3.0 mg/L for most wastewaters. However, if the averaging period is seasonal or annual, such an excursion is of significantly less concern and a smaller safety factor should be used.

Step 3: Determine required SRT for denitrification and phosphorus removal (if required).

Use graphs or equations provided in Chapter 4 to determine the denitrification rates at the lowest design temperature and use that value to determine the SRT required for the anoxic zones. Add the SRT requirements for denitrification to that required for nitrification. If biological phosphorus removal is required, add an anaerobic volume of 1.5 to 2 hours. Recognize, however, that complete characterization of the process influent wastewater and dynamic simulation might show that an anaerobic nominal HRT period as low as 0.5 hours would be sufficient for high rbCOD/TP ratios entering the plant, (for example, if the plant is fed by force mains and/or the wastewater is fully fermented when it reaches the plant as is likely to happen for high temperatures). The anaerobic volume can be significantly reduced by adding volatile fatty acids from pre-fermentation or by chemical addition for polishing.

Step 4: Determine Overall Sludge Inventory.

A preliminary estimate of the sludge inventory for the BNR activated sludge system to be designed can be derived from Figure 7-1, which is the same as Figure 14.20 from the WEF-ASCE Manual of Practice 8 (2010). For the total SRT and temperature as identified in Steps 1 through 3, estimate the

² For the purposes of this design manual “BOD” represents the 5-day BOD measurement method (sometimes referred to as BOD₅) unless otherwise noted.

net sludge production as a function of influent BOD (i.e., assume that 100 percent of the BOD will be removed during the treatment process). See Chapter 14 of MOP 8 (WEF and ASCE 2010) for guidance on performing detailed calculations and determining the overall sludge inventory. Estimate the sludge wastage rate as a function of the net sludge production and influent flow rate, i.e. calculate the mass of BOD that will be removed per day. This requires assuming a nominal hydraulic retention time for the total biological reactor volume. For conventional BNR activated sludge, this would be 6 to 10 hours depending upon the design temperature and the MLVSS concentration desired. Using the factor selected from Figure 7-1, calculate the mass of VSS that will be produced per day from the mass of BOD that will be removed per day. Divide this number by the selected SRT to determine a rough approximation of the waste activated sludge that will be produced per day.

Step 5: Estimate MLSS and Determine Overall Basin Volume.

Decide on a MLSS value, usually ranging from 2,200 to 3,500 mg/L if gravity sedimentation clarifiers are being used. The MLSS concentration is based on the secondary clarifier design, if gravity sedimentation, or on a reasonable concentration for membrane separation, e.g. 8,000 to 10,000 mg/L. If Integrated Fixed Film Activated Sludge (IFAS) is used, designers need to determine the biomass that will be attached to the media for the design operating conditions. That is best done using a computer model. Final selection of MLSS may be done by trial and error and should consider solids settling and thickening properties (WEF and ASCE 2010).

Multiply the SRT (days) from Steps 1 through 3 by the sludge wastage rate (mass /day) and divide by the MLSS concentration (mass per unit of area) to estimate the required minimum reactor volume.

Step 6: Determine Internal Recycle and RAS Pump Rates

Allow for mixed liquor internal recycle pumps that can return 2 to 4 times the influent flow for nitrate recycle from the end of the first aerobic zone to the influent end of the anoxic zone. Also, if the University of Capetown (UCT) or the Virginia Initiative Project (VIP) configurations are being used, recycle MLSS at a rate of approximately 1 times the influent flow from the end of the anoxic zone to the influent of the anaerobic zone for EBPR. The internal recycle to the anaerobic zone is not needed if the RAS is returned to the anaerobic reactor influent. Note that the most efficient internal nitrate recycle rate depends on the COD/TKN ratio entering the anoxic zone. Above this rate, there is insufficient BOD to reduce the quantity of nitrates entering the zone and additional recycle is detrimental rather than useful because internal recycle typically recycles DO as well as nitrates. There is rarely justification for recycle rates greater than 4 times the influent flow because of the increase in pumping costs for the same amount of additional nitrate that will be reduced, even if sufficient biodegradable COD is available.

The RAS rate should generally be 0.5 to 1.2 times the influent flow rate. The operator should be provided with substantial RAS rate flexibility so that adjustments can be made for variations in sludge settling rates and for changes in the MLSS concentration in the biological reactors.

Designers also should allow flexibility for when the plant is under loaded during the early years of operation or when the organic loading is considerably less than the design loading. Because under loaded BNR processes do not perform as effectively as fully loaded BNR processes, the use of multiple trains is the best way to provide flexibility during the under-loaded years. Also note that nitrification processes require minimum amounts of alkalinity to function optimally. The actual amounts of alkalinity

in the wastewater should be determined and compared to the net quantity that will be consumed by nitrification and phosphorus precipitating chemicals after correction for alkalinity that will be produced during denitrification.

10.3 Overview of Recommended Approach for Plant Modeling

Several groups have published recommended protocols and guidelines for activated sludge modeling (Petersen et al. 2002; Hulsbeek et al. 2002; Melcer et al. 2003; Shaw et al. 2007). Recognizing the need for a consistent protocol, IWA established a task group on good modeling practice to prepare guidelines for the use of activated sludge models. The task group hopes to finalize the guidance in 2010 (Rieger 2009).

To date, the task group has developed a Unified Protocol for modeling with the following five key steps:

1. Project description, including identification of objectives and model requirements
2. Data collection and reconciliation
3. Model set up
4. Calibration and validation
5. Simulation and results interpretation

Figure 10-1 shows the Unified Protocol as published by IWA. Modelers should generally follow this protocol when designing retrofits to an existing treatment plant to enhance nutrient removal.

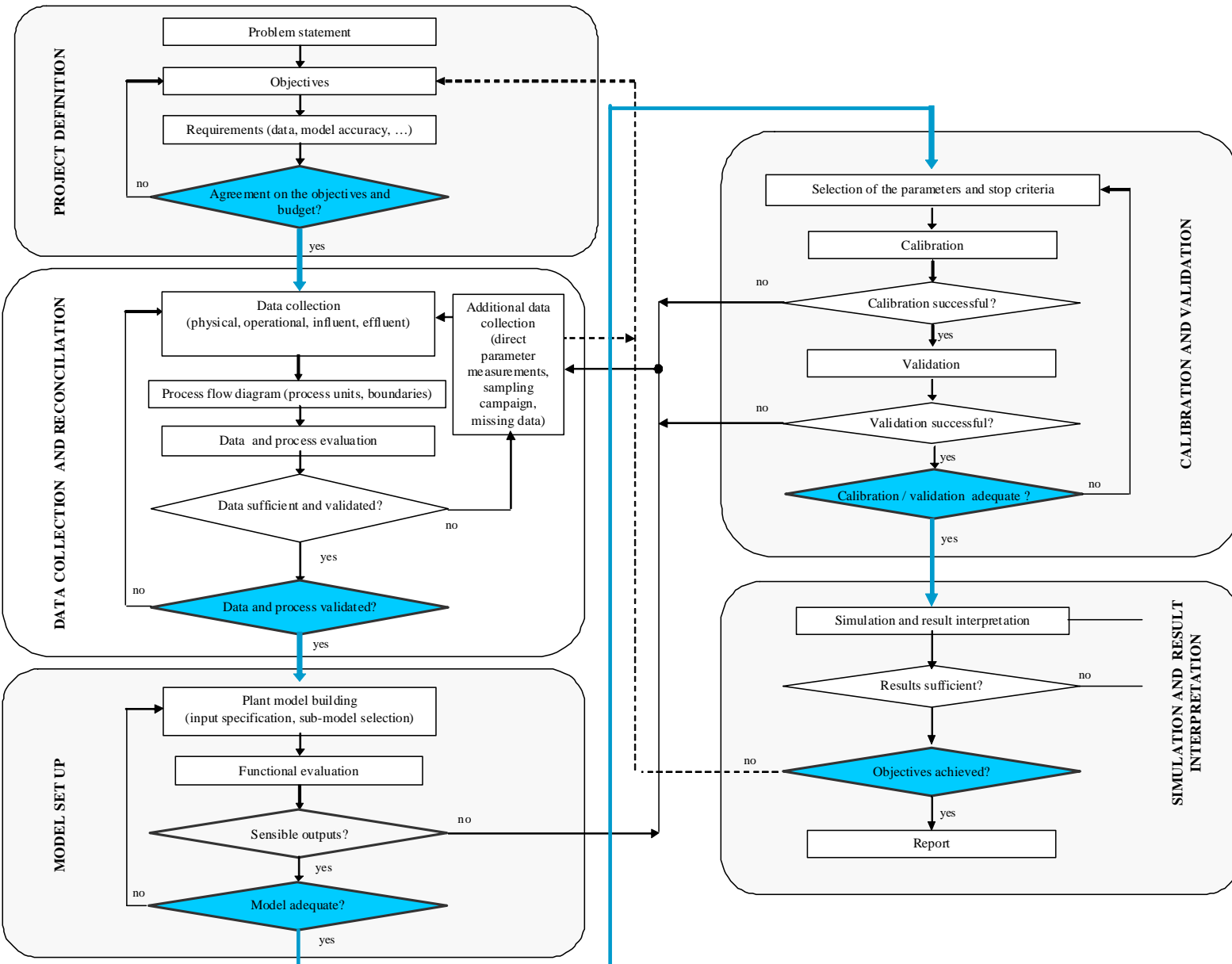

Figure 10-1. Unified protocol for activated sludge modeling.

Source: IWA, 2009. Used with permission from the IWA (http://www.modeleau.org/GMP_TG/UP.htm), from an upcoming report (<http://www.iwapublishing.com/template.cfm?name=isbn9781843391746&type=forthcoming>)

10.4 Establishing Objectives and Requirements

As early as possible in the modeling process, designers and plant operators should agree on the following:

- Modeling objectives
- Boundaries, answering questions such as “Under what environmental and operating conditions will the model be used?” and “What types of simulations will be performed?”
- Preconditions
- Performance criteria (e.g., goals for modeling accuracy)
- Responsibilities
- Required data
- Time and budget constraints

Three topics—intended use of modeling, goals for accuracy, and types of simulations—are particularly important in the design of nutrient removal systems and are discussed in subsequent subsections.

10.4.1 Intended Use of Modeling

This design manual assumes that modeling will be used for the design of retrofits to existing plants to enhance nitrogen and/or phosphorus removal, but can be used for green field designs as well. The same simulators developed for design purposes, however, can have many other functions. Simulators can be used to assess unit process capacities under different operating conditions to identify which processes are critical bottlenecks. They can be very useful as a process optimization tool through the manipulation of various controllable parameters. The same simulator used for design can be used to optimize performance once the retrofits are in place. Designers should also determine if the simulator will be used for operator training—for example, to simulate “what if?” scenarios that could have significant impacts on plant performance.

10.4.2 Goals for Modeling Accuracy

Because the simulator is a simplified representation and does not account for every biological process and chemical reaction that occurs in the real world, a perfect calibration to observed performance is not practically achievable and is not a recommended standard of modeling. An acceptable level of agreement is generally for observed and predicted values to be within 10 to 15 percent for an initial design when calculated on a monthly average basis and below 10 percent for a final design. With on-line instrumentation that can track the diurnal variations, it may be possible to approach 5 percent accuracy on a daily average basis for model calibration of most of the parameters such as sludge production, MLSS, effluent ammonia and soluble COD. Some effluent parameters such as nitrates are dependent on the degree of simultaneous nitrification and denitrification, which is more difficult to model. Agreement will be less for transient conditions further away from steady state such as storm events or spikes in nutrient loading. The goal for modeling accuracy should take into account the design criteria for nutrient limits. A smaller margin of error is preferable for very low target effluent levels for TN and/or TP.

Designers should coordinate closely with the plant owner to establish target accuracy prior to developing the model. Note that the model output is only as accurate as the input and the method

used to make the measurement for inputs and outputs. The better the input information, the lower the safety factor that is needed.

10.4.3 Dynamic vs. Steady State Simulation

Models can be run in steady state or dynamic simulation mode. Steady state simulations predict treatment plant performance when there is no variation in the load or flow to the plant. Diurnal patterns for influent flow volume and loadings (i.e., COD and TKN) may be used in steady state models, but the models will average the flow and load and produce steady state outputs. Dynamic models rely on the same mathematical relationships as steady-state models, but they can also simulate hourly variations in measured influent flow and operating parameters (e.g., recycle flows) over a number of days, months, or seasons.

Industry experts consider dynamic modeling to be superior to steady state modeling (Hulsbeek et al. 2002; Merlo et al. 2008; Alex et al. 2007). Dynamic simulations more closely approximate actual plant operations and allow for the use of smaller safety factors for design. They are extremely useful for wet weather modeling, determining daily maximum limits, and sizing aeration equipment for peak demand (Johnson 2009). Design objectives, however, should be balanced with significantly larger data requirements (e.g., hourly measurements of influent flow and nutrient loadings for several days) and hence, the higher costs associated with building a dynamic compared to a steady state model. As noted previously, however, the cost of more sampling and analysis is a fraction of the savings possible through a more accurate design and lower safety factors.

Dynamic modeling becomes particularly important and is recommended when **targeting very low nutrient limits** such as 3.0 mg/L for total nitrogen (TN) and/or 0.1 mg/L for total phosphorus (TP). Reasons for this are discussed below.

Because nitrifying bacteria do not have adsorptive capacity, the rate at which they can reduce ammonia is directly related to the mass of nitrifiers in the mixed liquor, which is in turn determined by the average influent ammonia load and the SRT in the aerated basin. Influent ammonia concentrations vary, with peaks occurring during the day and much lower concentrations occurring overnight. In fact, peak ammonia load during the morning can be as high as 2.8 times the average (Barnard 1975). Influent ammonia concentrations can be greatly increased by concentrated ammonia in return streams from sludge dewatering operations. In many plants, dewatering of digested sludge occurs during the day, and the supernatant from the dewatering operation is returned to the head of the plant in the afternoon. The combination of peak ammonia loads from the influent wastewater and additional ammonia from return streams can result in peaks that cannot be fully oxidized by the available nitrifiers resulting in peaks of ammonia in the effluent. The size of the peaks will also be related to the SRT and is not necessarily an indication of imminent plant failure, i.e. nitrifier washout. Steady state modeling would not capture this scenario. When there are substantial daily ammonia peaks, the steady state model may show that nitrification is possible while the diurnal model may indicate inadequate performance of the nitrifiers because of ammonia breakthroughs. For example, when the average influent nitrogen is 30 mg/L and there is an increase to 60 mg/L without an increase in the SRT during the transition from 30 to 60 mg/L, some ammonia will bleed through until the mass of nitrifiers has doubled. In simulation or actual practice, this would take a significant number of days. It is unlikely that the high load will persist long enough for the increase in nitrifiers to take place unless there has been a permanent addition to the ammonia load. Therefore, significant variations in the effluent ammonia concentration could be observed but there is little or no danger of losing nitrification. Note also that

since the nitrifier population is a low fraction of the total MLSS, the total MLSS will increase only slightly (2 to 3 percent) if a permanent increase in ammonia loading has occurred.

Similar to the reduced treatment capacity of nitrification systems caused by ammonia in recycle from sludge dewatering units, reduced phosphorus removal can be caused by nitrates in the recycle stream. This is because some heterotrophic aerobic organisms, including some phosphorus storing organisms, can use nitrate as an electron acceptor and will compete with the phosphate accumulating organisms (PAOs) for volatile fatty acids (VFAs). See Chapter 5 for additional information on the biological phosphorus removal process and inhibitory effects of nitrate in the recycle stream.

The main simulator models incorporate a one-dimensional (1D) mathematical model for secondary clarifiers based on the mixed liquor settling characteristics as represented by the Vesilind equations (Vesilind 1968; Zhou et al. 1982). These 1D models can predict the behavior of transient loads through the secondary clarifiers during dynamic modeling, which is extremely important when removing nutrients to low levels. The 1D models, however, are limited because they assume ideal layered clarification and thickening. Two or three dimensional (2D or 3D) computational fluid dynamic (CFD) models can more accurately represent the dynamic behavior of specific clarifier configurations (Merlo et al. 2007). CFD models could be coupled with the overall simulator models; however, they require a very large computer memory to run, which slows down the iterations required to solve the multiple interrelated biological equations. Most designers use the 1D models for solving the biological reactions and the effect of transient loads, then study the final clarifiers using CFD modeling.

If designers would like to see the effect of dynamic modeling but only daily average and some peak flow values are available, they can use typical patterns for flow and concentration derived from similar plants (it should be noted on the outputs that these are estimates). Designers can use a separate input of clean water to simulate a storm event of fixed duration then mix this input with regular plant influent. The storm could be simulated at various times during a 24-hour period to assess its potential impact. Recycle flows can also be simulated as being stored and fed at various times within a 24-hour period under various stress conditions, such as low temperature or low VFAs in the plant influent. For example, the centrate from digested sludge could be modeled for return over 8 hours, 24 hours, or to be discharged during the night when the incoming ammonia load is low. Some plants may run out of alkalinity required for nitrification at low flows and some programs can simulate this.

10.5 Selecting a Process Simulator

Process simulators allow users to link unit treatment processes such as bioreactors and clarifiers together according to the configuration of a particular plant. Each unit process incorporates a mathematical model to represent biological, physical, and/or chemical interactions within that unit. The process simulator uses this information to mimic the performance of a plant under specific operating and influent loading conditions. Each individual biological reactor in the models is assumed to be completely mixed.

Table 10-1 lists the commonly used commercially available simulators (this is not an exhaustive list as the simulator market is continually changing). Each simulator is COD-based, allows dynamic and steady state simulations, has graphical interface and graphical output, and computes true mass balances. Each simulator can also perform “whole plant” modeling, which includes not only primary treatment processes, but also solids treatment and recycle streams. Commercially available simulators vary, however, according to their graphic interface, the mathematical models included for specific

treatment processes, the degree of customization available, the degree of knowledge required, and cost.

Table 10-1. Commonly Used Process Simulators

Simulator	Distributor to U.S.	Description	Use	Website
Biowin	Evirosim Associates Ltd. (Flamborough, Ontario)	Uses a proprietary combined model that is based on the ASM models but integrates them with models for fixed film, digestion, settling, chemical addition, and filtration (“supermodel” approach). It is customizable and compatible with Excel, and has a unique pH calculator that can determine pH changes caused by wastewater reactions and model precipitation of struvite and other minerals.	Along with GPS-X, dominant in North America	http://www.envirosim.com
GPS-X	Hydromantis Inc. (Hamilton, Ontario)	Uses a proprietary model based on the ASM models. Includes models for fixed film, digestion, settling, chemical addition, and filtration. It is customizable and compatible with Excel and Matlab. It is able to perform automatic sensitivity analyses and has an extensive process model library.	Along with BioWin, dominant in North America	http://www.hydromantis.com
SIMBA	ifak e. V (Germany)	Based on the ASM models, also has models for settling and digestion. It is customizable and uses Matlab as a basis. Well designed to look at control elements, it can link with collection system and stream models.	Mainly Germany and Holland	http://simba.ifak-md.de/simba/index.php?option=com_content&task=view&id=34&Itemid=104&lang=en
STOAT	WRc plc (Swindon, England)	Allows use of modified version of ASM models that are based on BOD instead of COD. It is customizable and can perform automatic sensitivity analyses. UK specific data.	Predominantly United Kingdom	http://www.wrcplc.co.uk/default.aspx?item=1052
WEST	DHI Water (Hørsholm, Denmark)	“Open” system, i.e., can use any mathematical model to predict plant performance.	Belgium and Europe	http://www.dhigroup.com/Solutions/SolutionSoftware/WEST.aspx
AQUIFAS	Aquaregen Mountain View, CA USA	An internet available program based on the ASM models that utilizes Excel. It includes models for the incorporation of all types of fixed-film media into activated sludge bioreactors. Also MBR and whole plant simulation.	Developed in the USA, but currently used in several countries around the world.	http://www.aquifas.com

Source: Melcer et al. 2003; Shaw 2009. Sen and Randall 2008a,b,&c. Weblinks current as of March 23, 2010.

Two simulators, BioWin and GPS-X, dominate the market in North America. Both are relatively easy to use and produce output data in simple graphical format (Shaw et al. 2007). In 1995, the Dutch Foundation of Applied Water Research (STOWA) recommended the use of SIMBA, which prompted its adoption by more than 100 plants in the Netherlands (Hulsbeek et al. 2002). STOAT, on the other hand,

is the only simulator that includes biochemical oxygen demand (BOD)-based models. West is popular with some in the academic community because of its ability to accommodate any model and because it runs in a transparent environment.

New simulators are continually being developed, some to meet specific needs of certain users. For example, AQUASIM and ASIM are produced by EAWAG and have found high usage among academics (for more information on these models, see <http://www.asim.eawag.ch/>). Sen and Randall (2008a, 2008b, and 2008c) developed an internet available spreadsheet model called “Aquifas” primarily for modeling attached growth processes including membrane bioreactors (MBR), integrated fixed film activated sludge (IFAS) systems, and moving bed bioreactors (MBBR), but it can be used for whole plant simulations of all types of activated sludge systems, including headworks, anaerobic digesters and sludge processing, and is adaptable for fixed film processes such as trickling filters and RBCs. Users have the option of selecting empirical models or biofilm diffusion models for predicting performance and can run both steady state and dynamic simulations. Aquifas is available free of charge at <http://www.aquifas.com/>.

While no set of mathematical equations can perfectly replicate a system, designers should be careful to select a simulator that contains all significant treatment processes occurring in the plant and candidate processes under consideration for upgrades. The choice of simulators will also depend on user preference and skill level. While some simulators allow a great deal of flexibility to adjust and change models, they also require greater skill and understanding of the process. The graphical interface, user friendliness, and compatibility with existing software will also be important factors. Some programs have a high initial cost but will most likely offer training and a higher degree of customer support, while others cost less but do not provide as much support. The text box on the next page provides a list of questions that should be considered by designers prior to selecting a process simulator.

What questions should I ask before selecting a process simulator?

- How will you use the simulator? What do you want the simulator to do now and in the future?
 - Decide on FEATURES.
- Who will run the simulations and keep the models up to date?
 - Determine expertise needed to run and maintain the simulator.
- Questions for Vendors:
 - What processes and functions will it model?
 - How does it interface with other software such as Excel?
 - Is there a lease option? This type of agreement can be very cost effective.
 - What is the cost and availability of training?
 - What type of support (from company and/or user groups) is offered?
 - How extensive are the documentation and help functions?

Source: Shaw 2009.

10.6 Data Collection

Figure 10-2, adapted from Wilson and Dold (1998), shows the inputs needed to set up a process simulator for an existing WWTP. Input data that can be obtained from plant records or by direct measurement include:

- **Process configuration** data such as plant layout, reactor sizing, and recycle streams
- **Process operating conditions** such as flows through each process and flow rates of recycle streams
- **Process inputs**, namely wastewater characteristics and influent loading data

Rieger (2009) estimates that 50 to 60 percent of the entire modeling effort goes into data collection and reconciliation.

Subsections 10.6.1 and 10.6.2 discuss process configuration and operating conditions, respectively. Guidance for wastewater characterization and influent loading data is provided in Chapter 7. For guidance on estimating fractions of organic substrate and nutrient loading parameters, see Sections 10.7 and 10.8, respectively. Estimating kinetic and stoichiometric parameters for process models are discussed in Section 10.9.

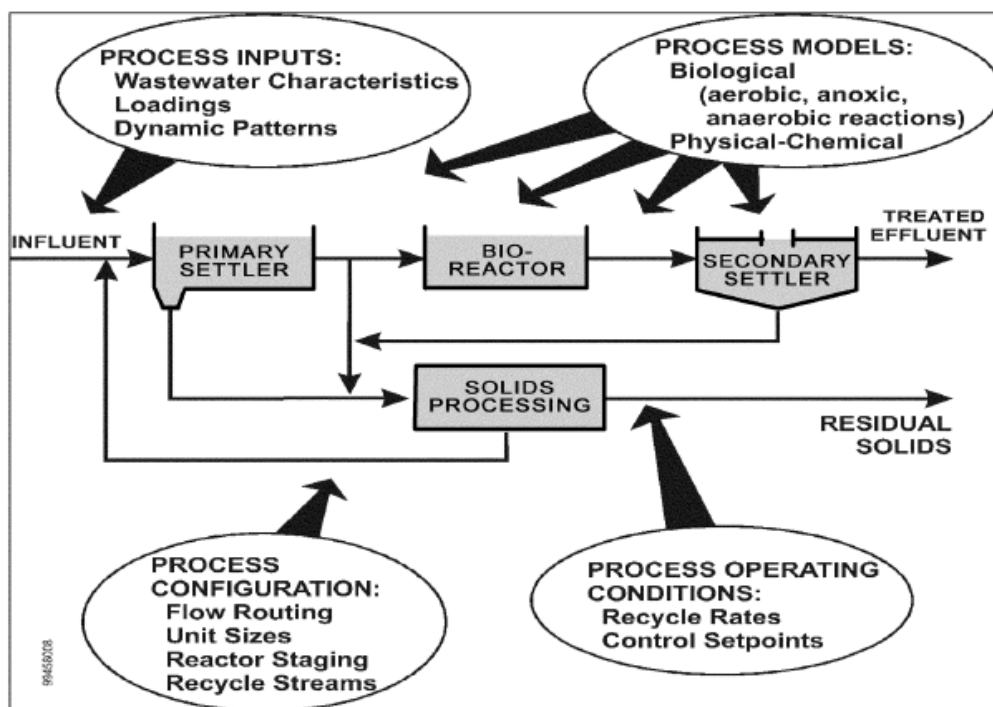

Figure 10-2. Essential requirements for wastewater treatment process simulation.

Source: Wilson and Dold 1998. Reprinted with permission from *Proceedings of WEFTEC®.1998, the 71st Annual Water Environment Federation Technical Exhibition and Conference*, Orlando, Florida, October 3-7, 1998. Copyright © 1998, Water Environment Federation, Alexandria, Virginia, www.wef.org.

The accuracy of any simulator is highly dependent on the quality of the data used to build it. Designers should critically evaluate data to ensure that they are logical (i.e., data are not outside the normal range for WWTPs) and measured parameters are as expected for each sampling location given the upstream treatment processes. Chapter 7, Section 7.4.2 recommends data checks that should be completed prior to entering information into the model. Mass balances to further validate influent loading and plant operating data are discussed in Section 10.10 (model calibration).

10.6.1 Process Configuration

Simulators require users to configure unit processes as they occur at the WWTP and enter information on the size of each component, points of input and output, and recycle streams such as the RAS and MLSS recycle. Most simulators allow users to “build” a plant by selecting icons for unit processes and entering basic data for each (e.g., volume, length, width, and depth for aeration basins and clarifiers). The end result is a visual representation of the existing WWTP to be upgraded or retrofitted or the concept for the Greenfield plant. See Figure 10-3 for an example of a simulator configuration for a Three-stage Phoredox Process (A2O) plant with primary sedimentation tanks, a fermenter for VFA generation, waste activated sludge thickening, digestion, and dewatering. Designers should always consider “whole plant modeling” for nutrient removal processes, meaning that sludge production and recycle streams are configured in the simulator rather than just the major treatment processes.

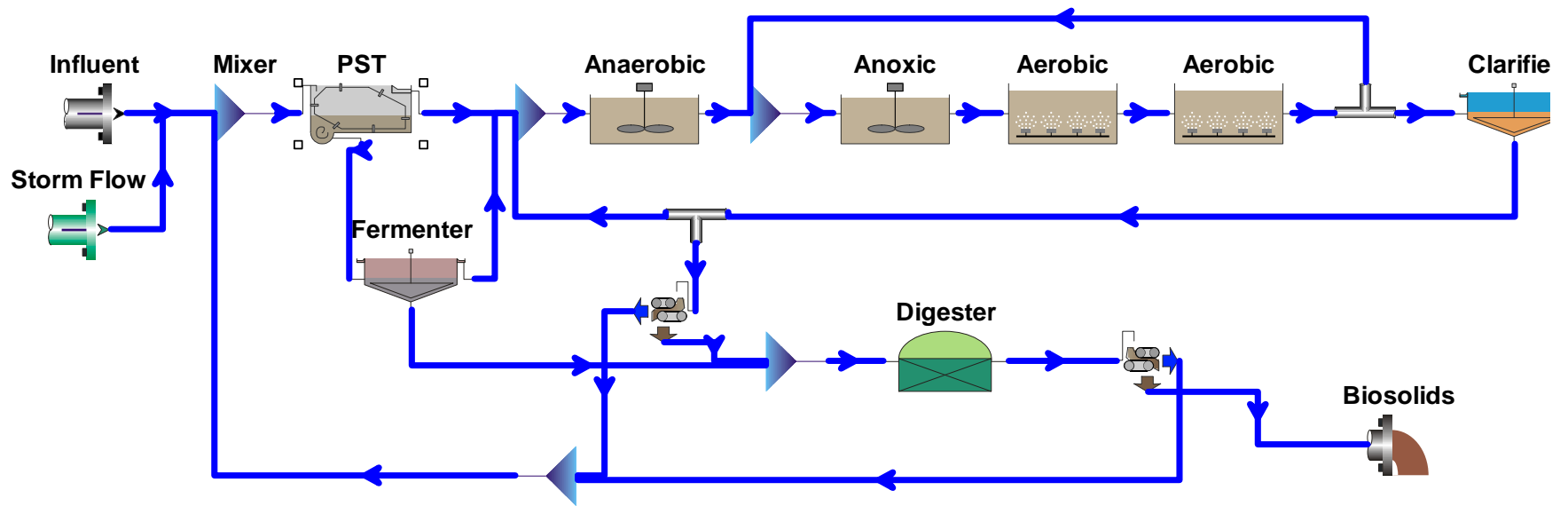

Figure 10-3. Example simulator configuration for a biological nutrient removal plant (courtesy of EnviroSim Associates, LTD).

All the major processes including secondary clarifiers, bioreactors, and any filters should be included. If an objective of modeling is to evaluate aeration system performance, diffuser dimensions and densities should also be included (Melcer et al. 2003). It is not usually necessary to include sludge treatment process (e.g., digestion), although any return streams from these processes should be specified. If possible, parallel treatment processes should be modeled as individual units (Shaw et al. 2007).

Information on physical configuration can be obtained from plant managers or operators or can be obtained from as-built construction records. During initial model setup, designers should compare design capacities for each unit to the modeled outputs during maximum operating capacity (Third et al. 2006). See Section 10.9 for additional information on model runs and calibration.

The set up of **suspended growth bioreactors** is very important for accurate modeling of carbon removal and nitrification. The simulators use continuous stirred tank reactors (CSTRs) to represent the suspended growth activated sludge systems, meaning that a drop of water is instantaneously mixed with the rest of the water as soon as it enters that reactor. In real plants, the flow through bioreactors is somewhere between plug flow and completely mixed depending on design and operational factors such as shape of the reactor, flow rate, baffling, and mixing pattern of aeration equipment. To account for non-ideal mixing conditions, individual bioreactors should be represented by **at least two CSTRs in series** for square tanks and more than two for rectangular tanks in the model.

If the design of the reactor favors plug flow conditions (e.g., long narrow tanks with no dividing wall between cells), designers can use the following formula to estimate the number of CSTRs in series for the model:

$$N = 7.4 * \frac{L * Q (1 + RR)}{W * H} \quad \text{Eq. 10-1}$$

Where:

- N = equivalent number of tanks-in-series (should never be greater than 12)
- L = aeration tank length (m)
- Q = wastewater flow (m³/sec)
- RR = RAS recycle ratio (dimensionless)
- W = aeration tank width (m)
- H = water depth (m)

This formula was developed by the Water Research Centre in the United Kingdom. For additional information, see Melcer et al. (2003).

Another more rigorous approach to characterizing flow through a bioreactor is to perform a tracer test. A slug of inert tracer (e.g., lithium or fluorescent dye) is added to the head of the tank and monitored to develop a washout curve. See the publication *Guidance Manual for Sewage Treatment Plant Liquid Train Process Audits* (Environment Canada 1995) for the detailed methodology.

The main reason for matching the number of individual completely mixed tanks with the shape of the existing or proposed tank is to simulate the different operating conditions in different zones. E.g. if the length to width ratio for the aeration section is 3, the oxygen demand in the first section will be

higher while the dissolved oxygen level in this section must at least 2 mg/L to minimize bulking sludge development and to enhance both nitrification and biological phosphorus uptake. In contrast, by the time the mixed liquor reaches the third section, the ammonia may be depleted resulting in a drop in oxygen demand which may lead to over-aeration. Air flows to the different zones should match the demand to save energy and ensure that the biological functions work optimally. In addition, there may be a mixed liquor recycle from the aeration basin to the anoxic zone which would change the flow patterns in the aeration basin

10.6.2 Operating Conditions

The following operating parameters are important model inputs and are available at most WWTPs:

- Flow routing into and out of major unit treatment processes
- RAS and mixed liquor recycle rates
- Primary and secondary wastage flows (with schedules in cases of intermittent wasting)
- Flow rate and schedule for return streams that contain high solids, nitrogen, or phosphorus
- Control schemes for mechanical equipment such as aerators and pumps (based on SCADA system records or interviews with plant operators)

Designers should review several years of data to determine operating conditions under ***dry weather, normal operation*** rather than taking an average of several months of data. Operating parameters should also be established for extreme conditions such as peak wet weather events.

Plants may be missing operating information, such as the proportion of flow going to multiple treatment trains. Designers should interview operators to approximate missing operational data or use portable equipment (e.g., flow meters) to directly measure and record missing parameters. Site visits to the treatment plant to interview operators, conduct a walk-through of the plant, and observe treatment processes are highly recommended (Hulsbeek et al. 2002).

A common suspect operating parameter is ***wastage flow*** due to the difficulty in measuring sludge densities over the full period of wastage (Melcer et al. 2003). See Section 10.10 for guidance on checking wastage flow rates during calibration.

10.7 Characterization of Organic Material

When using models for design, organic compounds need to be differentiated into a number of separate components based on their characteristics, namely whether the material is soluble³ and/or biodegradable. The relative fractions of organic material in wastewater are very important because they determine the amount of substrate available to microorganisms for biological nutrient removal processes and affect the amount of DO required and the volume of sludge produced. Most models

³ Melcer et al. (2003) reports a lack of clarity in use of the term “soluble.” Most technical references define soluble as material passing through a 0.45 micron (µm) membrane filter. Total dissolved solids (TDS), however, are routinely measured using glass-fiber filters with nominal pore sizes of 1.2 to 1.5 µm. The difference is in the colloidal material, with most colloidal COD passing through a glass-fiber filter but retained on a 0.45 µm filter. It is therefore very important to note the filter type used when examining historical data and document the filter type used for all experiments.

include default values for organic fractions; however, *site-specific characterization* is strongly recommended for the design of nutrient removal systems.

Characterization of organic material is almost always in terms of COD rather than BOD⁴. Even if the simulators allow users to enter BOD values, they are converted to COD for mass balances or simulations, using the COD fractions in the model. For additional rationale, see the text box in Chapter 7, Section 7.4.1. When COD data are not available, COD can be estimated based on its relationship to measured BOD and VSS values (see Section 10.7.1 for guidelines). It is also common when only BOD values are available to run a series of BOD and COD determinations on the same samples to find a reasonable correlation curve which can be used to determine the COD for every BOD value.

Figure 10-4 provides a schematic representation of the COD components in wastewater. Commonly used symbols for each component along with a description and overview of measurement methods are provided in Table 10-2. The naming convention for the symbols is “S” for soluble, “X” for particulate, “I” for unbiodegradable or inert. COD components are typically reported in milligrams per liter (mg/L), but can also be represented as fractions of the total as indicated by the letter “F” with the symbol as a subscript (e.g., F_{SI} = the fraction of total COD that is soluble and unbiodegradable).

As shown in Figure 10-4, total COD in the plant influent is the sum of the soluble biodegradable portion, including both volatile fatty acids (VFAs) and non-VFA compounds; the soluble unbiodegradable (or “inert”) material; slowly biodegradable material, which can be either colloidal or particulate; and particulate unbiodegradable material. As a formula, this relationship is expressed as:

$$\text{COD}_{\text{TINF}} = S_A + S_F + S_I + S_{\text{COL}} + X_S + X_I \quad \text{Eq. 10-2}$$

Where:

COD_{TINF} = Total influent COD concentration

S_A = Volatile fatty acids

S_F = Complex biodegradable soluble COD

S_I = Soluble unbiodegradable COD

S_{COL} = Slowly biodegradable colloidal COD

X_S = Slowly biodegradable particulate COD

X_I = Particulate unbiodegradable COD

⁴ The STOAT simulator contains modified mathematical expressions that allow the user to characterize wastewater using BOD instead of COD. STOAT is the only one of the commonly used process simulators shown in Table 10-1 with this feature.

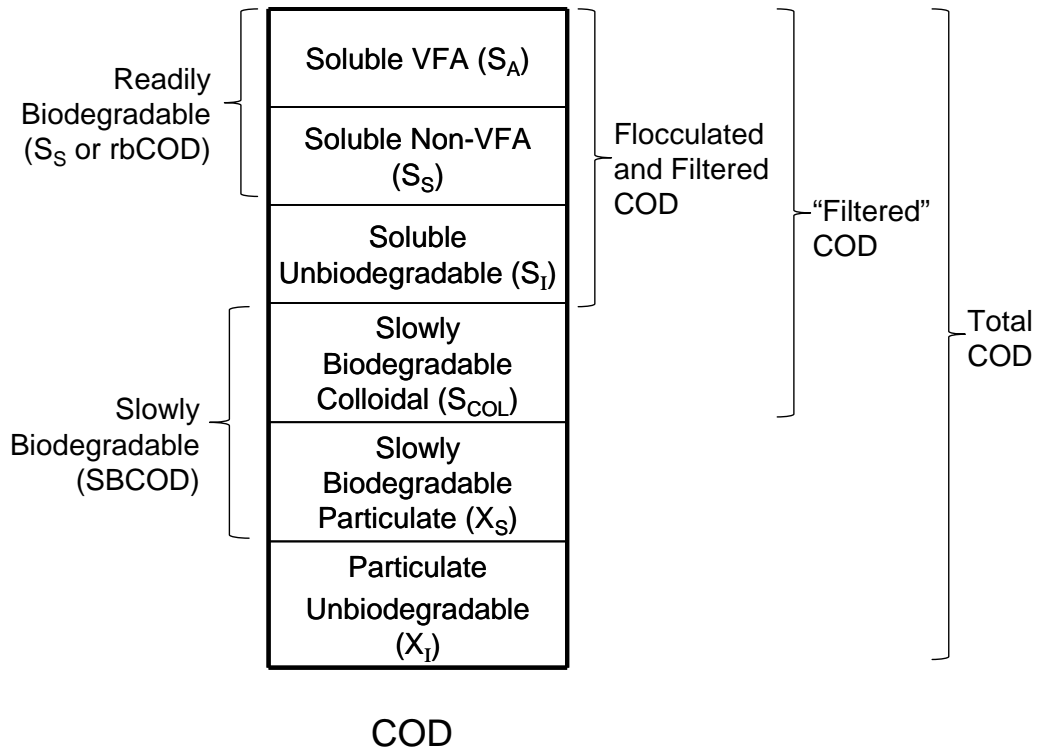

Figure 10-4. COD components for municipal wastewater

Note: COD fractions are not to scale and vary from plant to plant.

Source: Derived from Melcer, H., P.L. Dold, R.M. Jones, C.M. Bye, I. Takacs, H.D. Stensel, A.W. Wilson, P. Sun, and S. Bury. 2003. Figure 4-5, with Permission from the Water Environment Research Foundation.

Table 10-2. COD and Particulate Fractions in Municipal Wastewater

Fraction	Symbol ¹	Description	How It Can Be Measured	Concentration in Municipal Wastewater ² (mg/L)
Total Influent COD	$COD_{T,INF}$	Quantifies “strength” of organic material in the influent	Directly measured or estimated based on relationship to BOD	250 – 700
Readily Biodegradable COD	S_S (or rbCOD)	Can be easily absorbed by organisms and used for energy and synthesis of cell mass. Is the sum of S_A and S_F	Directly measured by respirometry, but other methods are available using simplifying assumptions	25 – 125
Volatile Fatty Acids	S_A (or VFAs)	A fraction of S_S	Directly measured using ion or gas chromatography	
Complex Biodegradable Soluble COD	S_F	The fraction of S_S that is not VFA	$S_S - S_A$	
Soluble Unbiodegradable COD	S_I	Portion of soluble COD unaffected by biological reactions at the plant. Leaves the secondary clarifier at same concentration as influent	Approximated as the soluble (filtered) COD of a well nitrified plant effluent	20 – 50
Slowly Biodegradable COD	SBCOD	Portion of biodegradable COD that requires extracellular enzymatic breakdown prior to adsorption and utilization. Is the sum of S_{COL} and X_S	Typically determined as $COD_{T,INF} - S_I - S_S - X_I$	200 – 400
Slowly Biodegradable colloidal COD	S_{COL}	Portion of SBCOD that is colloidal and typically not settleable	The difference between the filtered COD and the ffCOD of the effluent	
Slowly Biodegradable Particulate COD	X_S	Portion of SBCOD that is particulate and settleable	$SBCOD - S_{COL}$	
Particulate Unbiodegradable COD	X_I	Portion of particulate COD unaffected by biological reactions at the plant. Accumulates in sludge mass.	Determined from the model or estimated based on influent COD, BOD, and TSS	35 – 110

Notes:

1. The literature contains more than one symbol for some components. The symbols shown are generally consistent with Melcer et al. (2003). Other commonly used symbols are included in parentheses. Note that the symbol shown represents concentration, expressed as milligrams per liter (mg/L). Fractions of total COD are represented by the letter “F” and a subscript (e.g. F_{S_I} is the fraction of the influent COD that is unbiodegradable and soluble).
2. Derived from Melcer et al. (2003), Table 4-2 and experience with systems. Concentration may vary due to variable per capita water consumption.

The significance of the COD fractions on wastewater treatment is described below.

- **Readily biodegradable COD (S_s or rbCOD)** is an extremely important modeling variable for biological phosphorus removal (BPR) systems as it determines the amount of substrate available for PAOs to use in the anaerobic zone. It includes VFAs and soluble, readily biodegradable COD that are not VFAs but can degrade to VFAs in the anaerobic zone.
- **Slowly biodegradable COD (SBCOD)** is made up of particulate and colloidal material that requires extracellular breakdown prior to adsorption by microorganisms. The difference between the particulate fraction (X_s) and the colloidal fraction (X_{COL}) is important when modeling performance of primary clarifiers because a portion of the particulate fraction will settle and be removed with the waste sludge while all the colloidal matter will pass through to the aerobic process.
- **Soluble unbiodegradable COD (S_I)** is significant in that it passes through the plant and ends up in the plant effluent. It is important to distinguish this portion from the soluble biodegradable fraction in the plant influent. S_I is typically a small fraction of the total.
- **Particulate unbiodegradable COD (X_I)** will accumulate in the waste sludge. From a mass balance perspective, the mass of X_I in the system is equal to the mass coming into the system per day multiplied by the SRT. X_I accounts for increasing VSS in the sludge with increasing SRT.

In addition to the organic matter fractions described above, active biomass will be captured by total COD measurement methods and is reflected in particulate COD fractions (X_I and X_s). Orhon and Cokgor (1997) estimate that active biomass makes up between 7 and 25 percent of total COD in municipal wastewater. Active biomass COD is not typically measured or taken into account for modeling and will not significantly impact model predictions of plant performance except in some high rate (low hydraulic residence time(HRT)) systems. See Melcer et al. (2003) for determining active biomass COD if you believe that it might be a significant fraction in your system.

The aggregations on the right side of the schematic in Figure 10-4 relate measurement methods to the representative fractions. The filtered COD is measured after the sample has been filtered through a 0.45 μm filter and represents both very fine colloidal and soluble material. The colloidal material can be removed by flocculating the sample before filtering it. The result, called the flocculated and filtered COD or ffCOD, represents only the readily biodegradable and truly soluble unbiodegradable COD.

Important relationships between organic and particulate material are discussed in Section 10.7.1. Section 10.7.2 presents various methods for determining COD fractions for a given wastewater. Recommended data checks for COD fractions are provided in Section 10.7.3.

10.7.1 Relationship of Organic Material and Suspended Solids in Wastewater

Figure 10-5 shows the relationships between BOD, COD, TSS, and VSS along with key fractions of each. Understanding these relationships can help designers estimate COD fractions when data are not available or check results against other parameters when COD fraction data are available.

The particulate fraction of COD can be correlated to historical data on VSS of the mixed liquor (MLVSS). This ratio is typically between 1.42 and 1.48 mg COD per mg MLVSS; however, the ratio can be higher for solids other than biomass. Some models use a constant COD/VSS ratio to determine VSS throughout the plant, while others may allow different values for different solids fractions such as biomass, X_I , and X_S .

What if the plant does not have COD data? This is a common problem. Many plants measure BOD_5 instead of COD because the BOD method has been in use for a long time and it is often the basis for regulatory compliance. If COD measurements are not available, COD can be approximated by establishing the ratio of COD/BOD or COD/VSS. While some programs may take BOD as the input, it is still necessary to adjust the COD fractions for good correlation.

Although measured values of BOD, COD, and VSS in the plant influent vary greatly, the ratios are generally consistent for a specific wastewater. COD/BOD ratios are typically 1.9 to 2.2, with the higher ratios for relatively fresh wastewater. COD/VSS should range from 1.42 to 1.48 mg COD per mg MLVSS. Estimating the ratio of COD/BOD is more common than COD/VSS.

To determine the COD:BOD ratio for a specific wastewater:

- Collect several samples (10 to 20 are recommended) of influent wastewater. The samples should be representative of total influent flow and taken at different times of the day at low and high influent flow rate.
- Split the samples, taking care to homogenize them thoroughly.
- Analyze each sample for COD and BOD. Use the same method for BOD that is used for the available plant data. (BOD_5 is most common, although some plants will have $cBOD_5$ data. For most municipal wastewaters there is very little difference in BOD_5 and $cBOD_5$ if settled primary sludge is used as the seed because very few nitrifiers will be present and they grow too slowly to significantly affect the results after just five days. If, on the other hand, effluent from a nitrifying plant is used as the seed, the results will be substantially influenced by nitrification and the answer will misrepresent the biodegradable organic matter in the wastewater.)
- Determine the average COD:BOD ratio for all samples.
- Repeat the test with primary effluent

Designers can then apply this ratio to historical BOD data to determine COD.

10.7.2 Methods for Determining COD Fractions

Industry literature provides many different approaches for site-specific characterization of COD fractions. This section presents the following three possible approaches, moving from the easiest to the most complex:

1. Conduct a mass balance of the COD/ VSS ratio and BOD around the primary clarifier using model default values for COD fractions. This method requires minimal sampling and can be a good first screening step based on existing data.
2. Conduct special sampling of the plant influent and effluent to estimate each fraction. Several measurement methods and approaches for approximating fractions are available. At minimum, this method requires a dataset for filtered COD and flocculated and filtered COD (ffCOD) for the plant influent and effluent. Advanced measurement techniques such as respirometry are recommended in some cases.
3. Bench scale sequencing batch reactor (SBR) tests (also called the Low F/M SBR test). This approach requires a 6-week start-up period and 2 weeks of intensive monitoring (Reiger 2009). It is the most expensive (approximately \$50,000) but can provide excellent characterization of COD fractions, TKN fractions, and nitrifier growth rate.

METHOD 1: Mass Balance around the Primary Clarifier

Because a large portion of the VSS will be removed in the primary sludge and the soluble COD passes into the effluent, a mass balance around the primary clarifier can provide significant information on COD fractions. The COD removed in the primary clarifiers should correlate with the removal of BOD and VSS since the latter also registers as COD.

The mass balance requires the following information:

- COD and BOD data for the clarifier influent and effluent.
- TSS and VSS data for the clarifier influent and effluent. If either TSS or VSS data are not available, they can be approximated by assuming a VSS/TSS ratio of 0.75 for clarifier influent and 0.83 for clarifier effluent.
- Flow rate into and out of the clarifier.
- Wastage rate.
- Percent solids removal.

Enter these data into the model and use default values for COD fractions. Run a mass balance around the primary clarifier. If the mass balance closes (i.e., the effluent BOD calculated in the model approximate the actual BOD effluent) and the predicted effluent COD and TSS values match the actual values, the default values for COD fractions are good approximations. If the mass balance does not

close or the predicted and actual values do not match, then the default values for the COD fractions need to be adjusted. See Methods 2 and 3.

METHOD 2: Special Sampling of Plant Influent and Effluent

This section presents recommended methods for estimating each COD fraction. In many cases, more than one method is available.

Readily Biodegradable COD (S_s)

The simplest way to determine S_s is to measure flocculated and filtered COD (ffCOD) of the influent and effluent of a plant producing low effluent ammonia and BOD, and assume the following:

- All of the readily biodegradable COD (S_I) is consumed in the plant and negligible in the plant effluent.
- There is no generation of soluble unbiodegradable COD (S_I) in the plant (i.e., it is the same concentration in the influent and effluent).

S_s is then determined as the difference between the influent and the effluent ffCOD.

The assumption that effluent S_s is zero generally holds when the sludge age is 3 days or older. The assumption regarding the generation of S_I can be checked by measuring both the influent and effluent. If either assumption is not valid or if results are not as expected, S_s can be determined using respirometric techniques. Several techniques are available and can be found in Melcer et al. (2003).

To distinguish between the VFA portion of S_s , measure VFA in the plant influent directly using ion or gas chromatography.

Soluble Unbiodegradable COD (S_I)

S_I can be determined based on the following assumptions:

- There is no generation of S_I within the system. While it is possible that some microbial processes may add S_I , this is generally a small portion of the total.
- The soluble biodegradable COD in the plant effluent is negligible compared to the unbiodegradable portion. This is particularly true if the effluent ammonia is less than 0.2 mg/L. The effluent soluble biodegradable COD is assumed to be zero.
- The effluent has very little colloidal matter because it is absorbed on mixed liquor solids (this is generally the case for municipal wastewaters but may not hold true for industrial wastes). Therefore, effluent colloidal COD is assumed to be zero. If colloidal matter is present, it can be flocculated and filtered out.

It follows that S_I can be approximated by measuring the soluble COD (i.e., the portion passing through a 0.45 μm filter) in the plant effluent.

Slowly Biodegradable COD (SBCOD)

SBCOD includes both particulate and colloidal COD and can generally be found by subtracting the other portions of the COD from the total using the following equation:

$$\text{SBCOD} = \text{COD}_{\text{T,INF}} - S_1 - S_5 - X_1 \quad \text{Eq. 10-3}$$

To distinguish between the colloidal and particulate fractions of SBCOD, designers can compare the filtered COD results to fCOD results for influent samples. The difference is the slowly biodegradable colloidal COD (X_5)

Particulate Unbiodegradable COD (X_1)

Several methods are available for estimating X_1 . Melcer et al. (2003) reports that it is most easily estimated by an iterative approach where X_1 is adjusted in the simulator until the predicted MLVSS matches the observed values. Changing X_1 will also change the oxygen uptake rate (OUR), so OUR should be checked to make sure it does not exceed the limits of the aeration system.

The X_1 fraction can also be estimated using historical plant data for COD, BOD, and VSS by assuming a value for the COD/VSS ratio of the influent solids. See Melcer et al. (2003), Section 6.8 for the calculation procedure.

METHOD 3: Bench-Scale Tests

Laboratory bench-scale analysis can provide accurate estimates of COD fractions as well as other useful information such as TKN and TP fractions and nitrifier-specific growth rates. These analyses, however, are labor intensive and time consuming (approximately 8 weeks). Melcer et al. (2003) recommends that they be considered if plant data are not available or if results are unusual.

The recommended approach is to use a laboratory scale fill-and-draw sequencing batch reactor (SBR) system. The designer should select a sludge age for the system that allows good solid liquid separation (the example from Melcer et al. used a sludge age of 15 days). At startup, the SBR is seeded with microorganisms from the activated sludge system. Wastewater is added to the system where it is treated through the standard fill-react-settle-waste-draw SBR cycle. The SBR should be operated over at least 2 to 3 sludge ages to achieve steady state. Intensive monitoring can then be used to characterize COD and TKN fractions and nitrification kinetics. See Appendix D of Melcer et al. (2003) for the full method description.

The cost of an SBR bench-scale test is estimated to be around **\$50,000** (Takacs 2009).

10.7.3 Data Checks

The following should be true for COD fractions for most municipal wastewaters:

- X_1 should be 20 to 40 percent of VSS.

- The S_s (or rbCOD) fraction is higher when conditions in the collection system are favorable for fermentation (i.e., warm climate, flat sewers, many force mains—see Chapter 5 for background).
- When TSS in the plant influent is higher than normal, the particulate unbiodegradable COD fraction may be higher than normal.

10.8 Characterization of Nutrient Fractions

10.8.1 Nitrogen

Total nitrogen in municipal wastewater is typically characterized by TKN. In some cases, although rarely, nitrate or nitrite nitrogen (NO_x) may be present, such as when recycle streams return appreciable amounts of NO_x to the head of the plant or the sewers have very steep slopes resulting in rapid sheet flow within the sewers. NO_x should then be included as an influent characteristic separate from TKN.

Figure 10-6 shows the TKN fractions that are used in modeling. Table 10-3 provides a description, the measurement method, and a range of expected concentrations for key nitrogen fractions. Ammonia (both free and saline) makes up 60 to 75 percent of TKN, with the remaining portion as organically bound biodegradable and unbiodegradable material. The **ammonia/TKN ratio** is of particular importance in determining the effects of nitrification on pH. While nitrification of ammonia to nitrate consumes alkalinity, hydrolysis of organically bound TKN adds alkalinity. If the latter is not considered, the model could predict an unrealistically low pH.

Soluble unbiodegradable (inert) nitrogen, sometimes referred to as recalcitrant dissolved organic nitrogen (rDON), has become increasingly important for plants trying to achieve low effluent TN concentrations, as it passes through the plant and into the effluent. The higher the rDON, the lower the concentrations of ammonia and NO_x must be to achieve a certain effluent TN concentration.

WWTPs will usually have historic data for influent and effluent TKN or ammonia. Historical data may only contain ammonia, which may be reported as total nitrogen, and additional tests may be needed to determine the ammonia/TKN ratio. Plants may also have ammonia or nitrate concentrations depending on permit requirements and monitoring practices.

Recommendations for estimating the remaining nitrogen fractions are provided below.

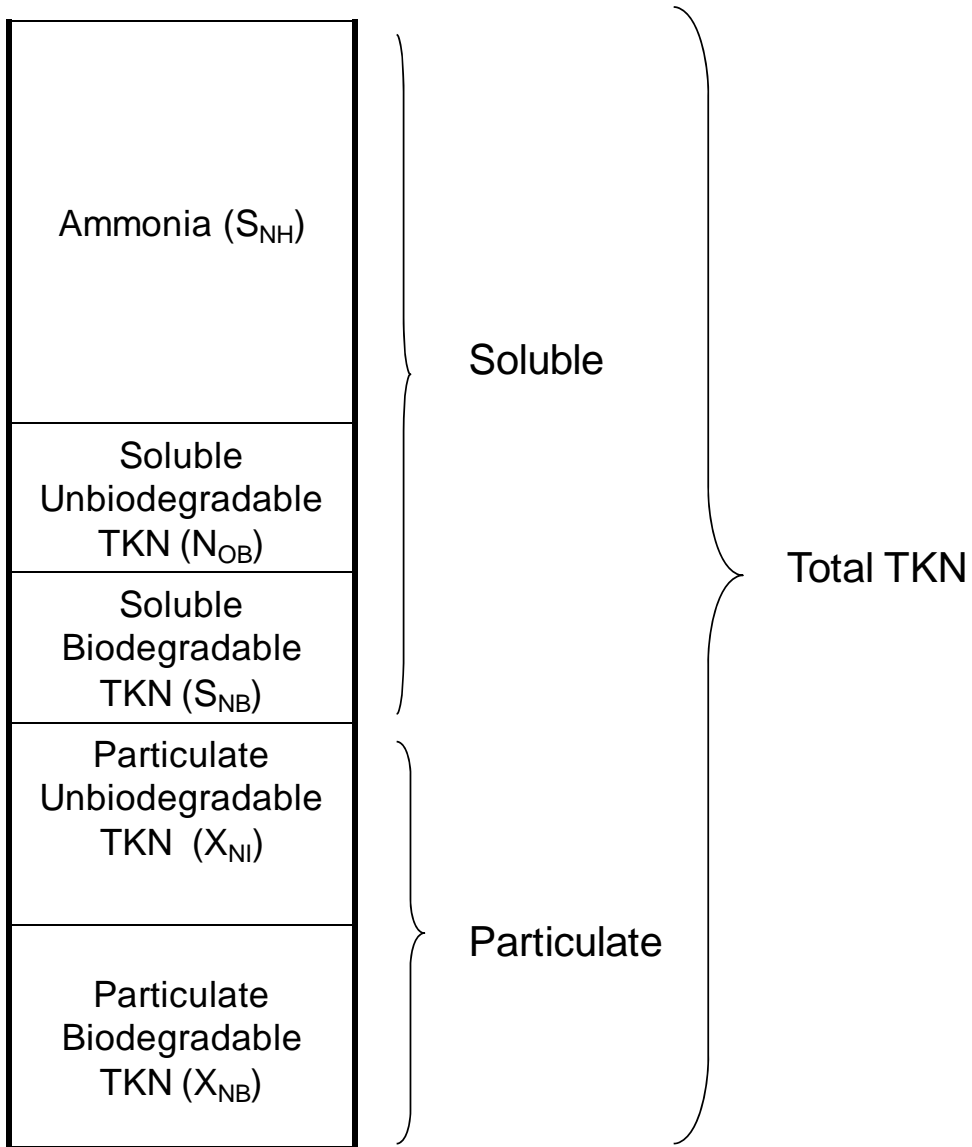

Figure 10-6. TKN components for municipal wastewater.
 Note: TKN fractions are not to scale and vary from plant to plant.

Table 10-3. TKN Fractions in Municipal Wastewater

Fraction	Symbol ¹	Description	Measurement Method(s)	Typical Concentration in Municipal Wastewater ² (mg/L)
Total Kjeldahl Nitrogen	TKN_{INF}	The total nitrogen load on the plant	Directly measured using colorimetric or titration techniques	25 – 70 depending on per capita water consumption
Ammonia (free and saline)	S_{NH}	The total ammonia	Directly measured	20 – 30
Soluble Unbiodegradable TKN	N_{UB} (rDON)	Soluble unbiodegradable dissolved organic nitrogen that passes through the plant untouched	Difficult to determine, default values often used	0.5 – 1.5. Higher values when specific industrial wastes are added
Soluble Biodegradable TKN	S_{NB}	The portion of biodegradable nitrogen that is soluble	Total soluble fraction determined by filtering sample, measuring TKN, and subtracting ammonia. The biodegradable portion is determined using assumptions	$S_{NB} + X_{NB} = 0 - 10$
Particulate Unbiodegradable TKN	X_{NI}	The portion of particulate bound nitrogen that is not biodegradable	Total particulate fraction determined by filtering sample and subtracting the soluble TKN. The unbiodegradable fraction is determined using assumptions.	2 – 8
Particulate Biodegradable TKN	X_{NB}	The portion of particulate bound nitrogen that is biodegradable	Total particulate fraction determined by filtering sample and subtracting the soluble TKN. The biodegradable fraction is determined using assumptions.	$S_{NB} + X_{NB} = 0 - 10$

Notes:

¹ The literature contains more than one symbol for some components. The symbols shown are generally consistent with Melcer et al. (2003). Other commonly used symbols are included in parentheses. Note that the symbol shown represents concentration, expressed as milligrams per liter (mg/L). Fractions of total COD are represented by the letter “F” and a subscript to represent the influent COD fraction (e.g. F_{SI} is the fraction of the influent COD that is unbiodegradable and soluble).

² Derived from Melcer et al. (2003), Table 4-2.

Ammonia (S_{NH})

When characterizing TKN, the most important fraction is the ammonia fraction, S_{NH} . It is the largest fraction and the component of TKN that is oxidized to nitrite then nitrate during nitrification. Ammonia is measured directly using standard laboratory methods or with online analyzers.

Soluble Nitrogen Fractions

Soluble unbiodegradable nitrogen (S_{NI}) is also often referred to as rDON. rDON is important because it passes through the plant unreacted and can limit the amount of nitrogen removal that is possible. Soluble biodegradable nitrogen (S_{NB}) is organically bound nitrogen that has not yet been converted to ammonia.

The total soluble nitrogen can be determined by subtracting the ammonia concentration from the TKN concentration of a filtered sample. Unfortunately, there is no rapid method for experimentally differentiating between S_{NB} and rDON. The most straightforward way to determine rDON is to run a pilot or bench scale test at a long SRT (> 12 days). Designers should check that all other requirements for nitrification such as DO and pH are met and then determine the concentration of ammonia and TKN in the effluent. The ammonia should be below 0.1 mg/L, and the bio-degradable organic nitrogen would also be very low. The remainder of TKN is then rDON.

Site specific determination of rDON becomes very important for plants targeting low effluent concentrations for TN (e.g., 3.0 mg/L). In other cases, default model values often suffice as the fractions are generally a small percentage of the total (< 3 percent).

Particulate Nitrogen Fractions

Particulate nitrogen can be biodegradable (X_{NB}) or unbiodegradable (X_{NI}). As with the soluble TKN fraction, it is not possible to directly measure the biodegradable and unbiodegradable fractions. The particulate unbiodegradable portion, however, can be derived based on its relationship to particulate unbiodegradable COD (X_I) in the mixed liquor solids. The ratio of TKN to COD in the mixed liquor solids is known to be approximately 0.07 mg N/mg COD. Therefore, X_{NI} can be calculated as:

$$X_{NI} = 0.07 X_I \quad \text{Eq. 10-4}$$

As a check, results should be compared to total influent TKN. Melcer et al. (2003) report that X_{NI} is approximately 10 percent of influent TKN for municipal wastewater.

10.8.2 Phosphorus

Knowing the phosphorus fractionation is important for plants that provide biological phosphorus removal. The P/VSS ratio is important in sizing the anaerobic zone and will also be a factor in designing the denitrification process. Figure 10-7 shows the fractions of total phosphorus. Table 10-4 provides a description, the measurement method, and a range of expected concentrations for key phosphorus fractions. All fractions are expressed as phosphorus in mg P/L.

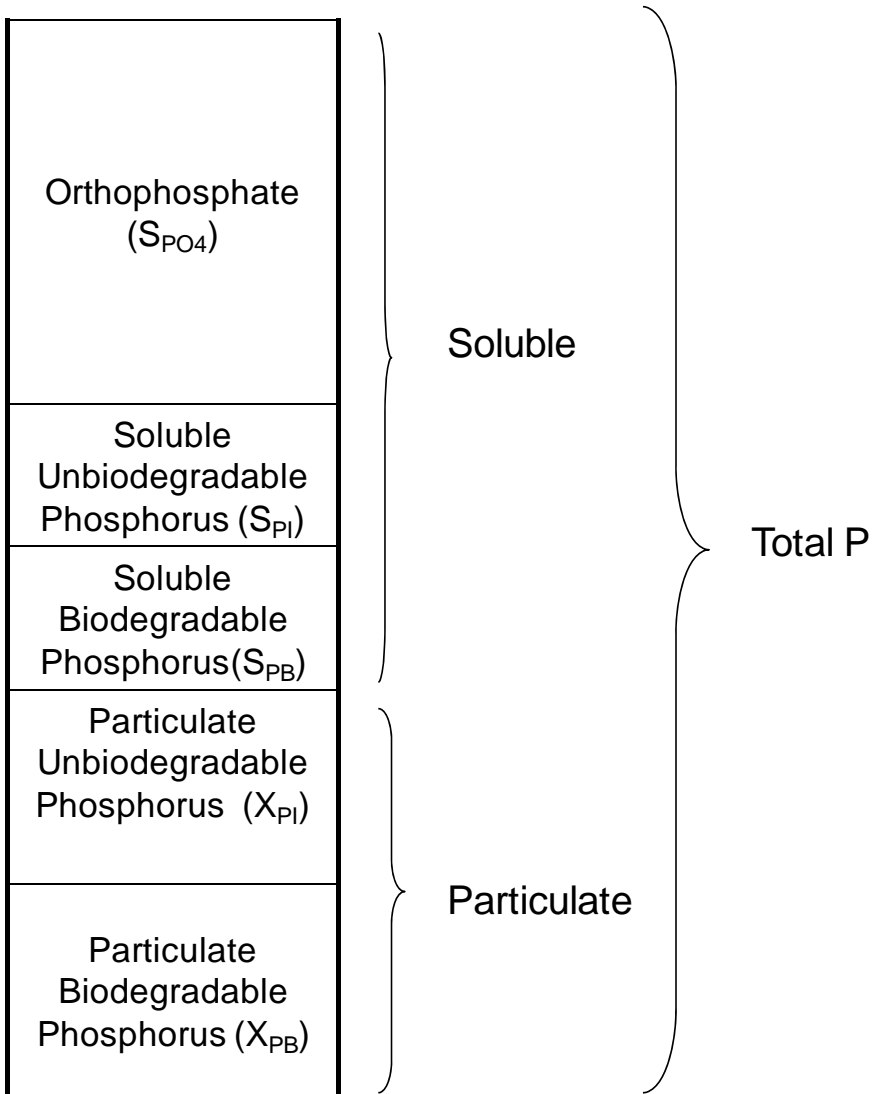

Figure 10-7. Phosphorus components in municipal wastewater.
 Note: TP fractions are not to scale and vary from plant to plant.

Table 10-4. Total Phosphorus Fractions in Municipal Wastewater

Fraction	Symbol ¹	Description	Measurement Method(s)	Typical Concentration in Municipal Wastewater ² (mg/L)
Total Phosphorus	TP	The total phosphorus load on the plant	Measured as ortho-phosphorus following chemical conversion	4 – 15
Orthophosphate	S_{PO_4}	The total orthophosphate	Directly measured	2 – 12
Soluble Unbiodegradable Phosphorus	S_{PI}	Soluble unbiodegradable phosphorus	Total soluble fraction measured for filtered sample, estimate for unbiodegradable portion	
Soluble Biodegradable Phosphorus	S_{PB}	The portion of biodegradable phosphorus that is soluble	Total soluble fraction measured for filtered sample, estimate for biodegradable portion	With X_{PB} 0 – 10
Particulate Unbiodegradable Phosphorus	X_{PI}	The portion of particulate bound phosphorus that is not biodegradable	Total particulate fraction measured by subtracting soluble from total, estimate for biodegradable portion	1 – 4
Particulate Biodegradable Phosphorus	X_{PB}	The portion of particulate bound phosphorus that is biodegradable	Total soluble fraction measured by subtracting soluble from total, estimate for biodegradable portion	With S_{PB} 0 - 10

Notes:

1. The literature contains more than one symbol for some components. The symbols shown are generally consistent with Melcer et al. (2003). Other commonly used symbols are included in parentheses. Note that the symbol shown represents concentration, expressed as milligrams per liter (mg/L). Fractions of total COD are represented by the letter “F” and a subscript to represent the influent COD fraction (e.g. F_{SI} is the fraction of the influent COD that is unbiodegradable and soluble).

2. Derived from Melcer et al. (2003), Table 4-2.

Orthophosphate

Orthophosphate is determined by direct measurement. Along with soluble biodegradable phosphorus, it represents the phosphorus that will be taken up by PAOs in the aerobic zone. Complex soluble phosphorus and some particulate phosphorus are hydrolyzed to mostly orthophosphate in the first stage of treatment. Orthophosphate typically makes up a large portion of TP in municipal wastewater (50 to as high as 80 percent). After primary sedimentation, nearly all of the remaining phosphorus is rapidly converted to orthophosphorus in the first bioreactor. Almost all of the effluent soluble phosphorus is orthophosphate.

Soluble Fractions

Soluble fractions of phosphorus represent the organic phosphorus that is not particulate bound. The biodegradable portion (S_{PB}) represents organically bound phosphorus that is taken up into the biomass for growth. The unbiodegradable portion (S_{PI}) is finely colloidal or soluble organic compounds, some of which are associated with the soluble unbiodegradable COD. The total soluble portion can be determined by filtering a sample and measuring total phosphorus in the filtrate. S_{PI} and S_{PB} are not easily differentiated. Generally a default value can be used for the fraction of TP that is S_{PI} . S_{PB} is then determined by subtracting S_{PI} .

Particulate Fractions

The particulate fractions are organically bound phosphorus within particles. The biodegradable portion (X_{PB}) is associated with the biodegradable particulate COD. The unbiodegradable portion (X_{PI}) is associated with unbiodegradable COD. The total particulate fraction is determined by subtracting the total soluble fraction as determined above from the total phosphorus. X_{PI} can be determined as it is a given fraction of the unbiodegradable COD. Typically a value of 0.02 to 0.03 is used. X_{PB} can then be determined by subtracting X_{PI} from the total particulate phosphorus.

10.9 Kinetic and Stoichiometric Parameters

Mathematical models require estimates of kinetic and stoichiometric parameters such as yield and growth rates to predict performance of wastewater treatment processes. Model default values for these parameters are based on thousands of observations and should generally be acceptable for most plants. The exception is ***nitrification rates***.

The maximum specific nitrifier growth rate, μ_{AUT} , and the endogenous nitrifier decay rate, b_{AUT} , are extremely important in the design of activated sludge nitrification systems. This is because the net growth rate ($\mu_{AUT} - b_{AUT}$) determines minimum SRT needed for complete nitrification to occur during steady state conditions. In equation format,

$$SRT = 1 / (\mu_{AUT} - b_{AUT}) \quad \text{Eq. 10-5}$$

Where:

SRT = Solids residence time (days)

μ_{AUT} = Specific nitrifier growth rate (d^{-1})

b_{AUT} = Endogenous nitrifier decay rate (d^{-1})

(Source: adapted from WEF and ASCE 2006, equation 3.8)

The literature reports little variation in endogenous nitrifier decay rate, b_{AUT} , from plant to plant. Previously, b_{AUT} was considered to be low compared to μ_{AUT} and, for this reason, it was excluded from much of the previous literature on nitrification rates. Recent results summarized by Melcer et al. (2003) show that experimental methods underestimated b_{AUT} and that it is more significant than previously reported (b_{AUT} was previously thought to be between 0 and $0.05 d^{-1}$; however, new data showed that it could be as high as $0.2 d^{-1}$ at $20^{\circ}C$). Underestimates of b_{AUT} have resulted in underestimates of μ_{AUT} by a factor of 2 in some cases (Melcer et al. 2003). Although not an issue for

completely nitrifying systems, an underestimate in μ_{AUT} could lead to conservative predictions of performance for low SRT systems. See Chapter 4 for additional discussion of nitrification kinetics.

Melcer et al. includes new methods for site specific determination of b_{AUT} . In the absence of more specific data, the authors provide the following as a reasonable estimate of b_{AUT} :

$$b_{\text{AUT}} = 0.17 * 1.029^{(T-20)} \text{ d}^{-1} \quad \text{Eq. 10-6}$$

Where:

T = Temperature in °C

d = Days

Although b_{AUT} is believed to be fairly consistent from plant to plant, researchers have observed significant variation in μ_{AUT} , with measured values at 20 °C (μ_{AU20}) of 0.2 to 1.0 per day. Factors affecting the rate of nitrification include industrial input, dissolved oxygen concentration, temperature, alkalinity, pH, and hydraulics within the reactor. Recent studies report μ_{AU20} ranges from 0.7 to 1.0 if no inhibition is experienced (Melcer et al. 2003). See Chapter 4 for an in-depth discussion of the nitrification process.

Because of its importance in designing nitrification systems, μ_{AUT} should be based on site-specific characterization of the influent wastewater. Melcer et al. (2003) presents three rapid methods for measuring μ_{AUT} : Low F/M SBR, High F/M, and the washout method. Each method has its distinct advantages and disadvantages. The methods have produced the same results when conducted in parallel; therefore, the choice of the method depends on the preferences of the designer. It is important to note that each of these three methods determines the net growth rate ($\mu_{\text{AUT}} - b_{\text{AUT}}$), not μ_{AUT} explicitly. b_{AUT} must therefore be estimated separately or assumed.

In some cases, it may be possible to use the model to estimate μ_{AUT} by adjusting it until model predictions match observed effluent quality (e.g., ammonia concentration) from the nitrification process. This iterative approach requires extensive data collection and is only meaningful when there are diurnal ammonia influent and effluent data. In fully nitrifying plants operating at high SRTs, the effluent ammonia will always be low, and this method would not apply.

10.10 Calibration

Calibration is the process of adjusting simulation parameters to match performance of a WWTP. Calibration has three main objectives, as summarized below.

- 1) To minimize the error between predicted and measured performance: The acceptable level of agreement should match objectives (see Section 10.4.2). Typical goals are no more than 10 to 15 percent difference for initial design and 5 percent for final design, although larger deviations during dynamic simulations are commonly accepted. Error can be determined either by visual analysis of observed and predicted data or statistical analysis. A perfect match is not achievable and should not be a goal of calibration.
- 2) To define the accuracy of the model: Based on the final agreement between measured and predicted values, the expected accuracy of the model can be defined for individual unit processes and constituents (e.g., COD, N).

- 3) To establish the circumstances under which the model can be used to simulate the treatment plant, also referred to as the model “design space”: A model should not be used for conditions for which it has not been calibrated to actual plant performance (e.g., extreme flow conditions such as a storm event).

The calibration process depends on the extent and quality of available data and the complexity of the existing treatment processes. The intended use and goals of modeling define the level of calibration (i.e., the acceptable error and whether or not the model needs to be calibrated to dynamic operating conditions). Good calibration requires detailed understanding of the fundamental treatment processes at the plant and of the principles of the model. Overriding principles of calibration are provided in the text box on the next page.

In an ideal situation, historical data for influent loading and plant operations are accurate and meet calibration needs. However, this is rarely the case. As noted earlier in this chapter, a ***tiered approach*** is recommended whereby designers first attempt to calibrate the model with existing data then collect additional data based on calibration results. Data checking and additional data gathering occur throughout the calibration procedure. This iterative approach is often time consuming and will require several rounds of data checking, operator interviews, and in some cases additional sampling. Several references (e.g., Petersen et al. 2002; Hulsbeek et al. 2002) report that the time required for calibration is often longer than expected.

Calibration should follow a stepwise, iterative procedure starting with sludge production and proceeding to composition, aeration, nitrification, denitrification, and biological phosphorus removal. Mass balances are an integral part of calibration and are incorporated throughout the procedure. Designers should first calibrate the model for steady state conditions (e.g., average concentrations in influent, effluent, and waste streams during normal dry weather conditions), then calibrate it for dynamic conditions. For dynamic simulations, it is important to initialize the model properly to establish operating conditions consistent with observed data to be used for calibration.

An overall recommended approach to calibration, including mass balance checks, is provided below. The recommended approach has 6 steps, assuming that the reader has already gone through the data checks in Chapter 7. The approach is based on a review of several publications on the topic (Third et al. 2007; Gernaey et al. 2002; Melcer et al. 2003; Hulsbeek et al. 2002; and Petersen et al. 2002). The 6-step calibration approach is not the only valid one—alternative approaches can work just as well as long as designers adhere to the overriding principles of calibration as stated in the text box on the following page. Readers should also consult the GMP Unified Protocol when it becomes available from IWA. Technical papers such as McConnell et al. (2008) and Latimer et al. (2008) provide additional examples calibration experiences and may be useful references for the reader.

Principles of Calibration

- Use a process engineering approach. Adjust parameters one by one based on the experience of the designer and an in-depth understanding of fundamental wastewater treatment processes.
- If the modeled treatment plant performance deviates substantially from observed values, it may result from errors in the hydraulic model (e.g., flow splits, recycle flow rate, wastage rate not properly configured). The problem could also be major operational set points such as minimum DO concentration and aeration rate. Operational data have a large influence on model outputs compared to wastewater characterization and kinetic/stoichiometric parameters (Gernaey et al. 2003). Another problem may be changes in the influent characteristics that are not modeled such as chlorine addition in the collection system for odor control.
- Adjust kinetic and stoichiometric parameters only as a last resort. The default kinetic and stoichiometric values in models represent averages of thousands of measured values from hundreds of plants. With few exceptions (see below), they should not deviate substantially from plant to plant. If predicted results do not agree with measured values, designers should always first ask the questions, “Is there something happening at the plant that could cause this result?” and “What are the possible reasons that the plant is not performing in the model as predicted?” The exception is the maximum specific nitrifier growth rate (μ_{AUT}), which could be very low if there is nitrifying inhibitors in the waste stream or higher if fewer than average inhibitors are present.
- Justify and document changes to kinetic and stoichiometric parameters and estimated constituent fractions.

Step 1. Check Process Configuration and Plant Hydraulics

- Compare design capacities of each unit process to modeled outputs with maximum operating capacities (Third et al. 2007).
- Perform total flow balance for the WWTP. Most simulators will automatically perform a flow balance around the plant. In simple terms, influent flow should equal effluent flow plus waste stream flows.
- Perform flow balances for each unit process considering wastage and recycle flows.

Step 2. Calibrate Sludge Production and Characteristics

- If not done already, perform mass balance for COD and TSS/VSS around the primary clarifier (see Section 10.7.2, Method 1).

- Perform mass balance of the inert fractions through the plant. Because it is not changed during biological reactions, the mass of inert solids in and out of the plant should balance. Take into account that phosphorus and magnesium removed either by chemicals or biology will register as inert material. Also, the metals used for precipitation would add to this fraction. If the inert mass of the solids in the waste products of the existing plant does not balance, check the following:
 - Wastage rate (this is a very common problem)
 - RAS flow rate
- The predicted mass balance for total solids in the simulator model should correlate with that in the full-scale plant, taking into account the issue of inert solids as discussed above.
- A mass balance for nitrogen is not possible because of the denitrified nitrogen that is released to the atmosphere.
- Perform mass balance for phosphorus, which cannot be destroyed and has no gaseous phase, by measuring influent, effluent, and wasted sludge concentrations. Results can be used to check the mass of sludge wasted.

Step 3. Calibrate the Aeration Process

- A COD balance can be used to check the oxygen uptake at the WWTP. For the following equation, solve for OUR:

$$\text{COD}_{\text{T,INF}} = \text{COD}_e + \text{OUR} + (N_d * 2.86) + Q_s * G_{s,\text{org}} * 1.42 - (4.56 * N_n) \quad \text{Eq. 10-7}$$

Where:

- $\text{COD}_{\text{T,INF}}$ = COD load in the influent (kg O₂/d)
- COD_e = COD load in the effluent (kg O₂/d)
- OUR = Oxygen uptake rate (kg O₂/d)
- N_d = Total denitrified nitrogen load (kg/d)
- 2.86 = Oxygen reduction-equivalent (1 kg NO₃-N is equivalent to 2.68 kg O₂)
- Q_s = Daily volume of excess sludge (m³/d)
- $G_{s,\text{org}}$ = Concentration of VSS in the excess sludge (kg VSS/m³)
- 1.42 = Conversion fraction from VSS to COD equivalents (kg COD/kg VSS)
- 4.56 = Conversion factor for calculation of oxygen uptake during nitrification
- N_n = Total nitrified nitrogen load (kg/d)

(Hulsbeek et al. 2002, equation 3)

Designers can use the estimated OUR to check the aeration efficiency of the plant (kg O₂ / kWh) or to detect errors in the setup of aerators.

Step 4. Calibrate the Nitrification Process

- Compare observed effluent $\text{NH}_3\text{-N}$ concentrations to simulation results. If results do not match, check the following:
 - Predicted vs. observed DO concentration in aeration basin
 - Basin hydraulics for short circuiting
 - Alkalinity depletion
 - Method for determining maximum nitrifier specific growth rate and decay rate (see section 10.9)

Recheck sludge production (Step 2).

Step 5. Calibrate the Denitrification Process

- Make sure that the model function for carrying DO from one basin to the next is on. This will model the transfer of oxygen in the recycled mixed liquor.
- Compare observed effluent $\text{NO}_3\text{-N}$ concentrations to simulation results. If results do not match, check the following:
 - Denitrification in return sludge
 - Re-aeration of denitrification process (e.g., from pumps or overflow weirs)

If this does not solve the problem, consider modifying the anoxic reduction factor or possibly the heterotrophic decay factor (Hulsbeek et al. 2002).

Recheck sludge production (Step 2).

Step 6. Calibrate the Biological Phosphorus Removal Process

- Compare observed effluent TP concentrations to simulation results. If results do not match, check for the following:
 - DO and nitrate in the anaerobic zone
 - rbCOD in the anaerobic zone
 - Addition of oxidizing agent such as chlorine to the influent that will result in inhibition of fermentation in the anaerobic zone

10.11 Validation

Whereas calibration ensures the model fits the original data set, validation seeks to ensure that the model is valid over a wider range of conditions. Validation includes running the model with a second set of data, different than the original calibration data. It also includes checking the model results to ensure they make sense with the physical system. The new set of data does not need to be as extensive as the original calibration data. An additional set of typically measured wastewater influent characteristics and flows along with effluent data should be sufficient. The data should be under

different conditions than the calibration data, but should still remain within the conditions under which the model is valid.

The new data should be entered into the model and the model run. If the model predicts the effluent data within an acceptable error, the model can be considered validated. If not, the model calibration procedure may need to be repeated. The following are common checks that should be conducted with the new data set to validate the model.

- **Check mass balances.** Using the new set of data, check the mass balances for flow and solids again. If an error is found, the sludge wastage rate and sludge composition are factors that should be examined.
- **Check nutrient balances.** Check the balances for phosphorus and nitrogen again with the new data. Model parameters to check include the nitrifier growth rate, the nitrogen content of inert particles, and the ammonia and oxygen half saturation constants for heterotrophs and autotrophs.
- **Check alkalinity balance.** The difference between the influent alkalinity and the effluent alkalinity should equal the net consumption of alkalinity from the biological reactions.
- **Check solids production and net solids yield.** If these values are off, they could indicate errors in the sludge wastage rate or solids content.
- **Check nitrification and denitrification rates.** Reasonable values of rate constants can be found in Jeppsson (1996) and Hulsbeek et al. (2002).
- **Check residence times (SRT and HRT).** The residence times in the reactors should be checked using the validated data. If the times are not reasonable and do not correlate with actual plant data, the model should be recalibrated.

10.12 Simulation of Design Alternatives for Nutrient Removal

Once the designer has calibrated and validated the model, the next step is to set up and run design scenarios for biological nutrient removal that answer the questions laid out in the modeling objectives. In simple terms, the influent flow and wastewater characteristics are modified to match design conditions, and the configuration of the existing plant is modified to incorporate candidate treatment processes as identified in Chapter 8 of this design manual. Designers should then conduct the following simulations to determine if the candidate treatment processes meet the design objectives (Rieger 2009):

- Steady state simulations, checking for:
 - Overall mass balancing
 - Long-term performance by evaluating effluent quality
- Dynamic simulations as follows:
 - Simulate diurnal peaks to determine equipment limits
 - Determine set points for controller design

- Simulate seasonal changes to establish long-term operational strategies
- Simulate storm events to determine optimal handling

It is in this step that designers realize the benefits of the effort required to set up and calibrate a detailed simulator of the existing WWTP. A large number of operating adjustments and treatment alternatives can be rapidly simulated to determine their effectiveness. Dynamic modeling is an extremely powerful tool in determining the most efficient operations for biological nutrient removal.

For the most promising biological nutrient removal technologies evaluated, designers should summarize information on long-term performance during a variety of operating conditions, if possible, and operating requirements (e.g., energy requirements, chemical addition, etc.).

10.13 Additional Procedures for Design

This section provides recommendations for design, equipment specification, and operation of the following nutrient removal technologies:

- Sequencing Batch Reactors
- Denitrification Filters
- Primary Sludge Fermenters

10.13.1 Sequencing Batch Reactors (SBRs)

SBRs are fill and draw systems that combine equalization, biological treatment, and secondary clarification in one tank using a time control sequence. As noted in Chapter 6, they can be designed and operated for nitrogen and phosphorus removal by cycling through aerobic, anoxic, and anaerobic conditions (USEPA 1999). Recommendations for the design and operation for nutrient removal are presented below.

- Designs should have a minimum of two SBR basins to allow for maintenance, handling of high flows, and seasonal variations. Designs should also consider influent equalization basins with capacity to hold peak flows during one treatment cycle.
- For nitrogen removal, an initial anoxic phase (mixing only, no aeration) should be followed by an aerobic phase, mimicking the Modified Ludzack Ettinger (MLE) process. Multiple anoxic phases within a single SBR cycle can improve performance (i.e., a second anoxic phase after the aerobic phase can be used to mimic a 4-stage Bardenpho process).
- Alkalinity may need to be added to keep it in the range of 40 to 70 mg/L as CaCO₃. Methanol or another external organic carbon source may need to be added for denitrification to maintain a relatively high rate of denitrification, although this is not common.
- SBRs can be designed for biological phosphorus removal (BPR) by using a large batch reactor with a reseeded anaerobic zone (WEF and ASCE 2006). If the biodegradable COD to TKN plus TP ratio is sufficiently large, BPR can be accomplished by maintaining non-aerated conditions after all of the nitrates have been denitrified, i.e. after the system has become truly anaerobic. It is necessary for VFAs to be available during the anaerobic period for BPR to occur. The effluent

soluble phosphorus concentration will be determined by the VFA to TP ratio during that period of time, assuming that conditions are suitable for phosphorus uptake during the subsequent aerated period. Many SBR systems successfully remove phosphorus by adding a metal salt either upstream of the SBR, during the react phase, or following the SBR if effluent filtration is in place (Young, 2008).

- Typical design parameters are as follows (WEF and ASCE 2006, Table 5.2):
 - SRT (including anaerobic and anoxic zones): 20 to 40 days, although SRTs considerably less than 20 days can be used. The primary purpose of long SRTs is to minimize the production of WAS
 - MLSS: 3 to 4 g/L
 - HRT (in terms of average flow):
 - Anaerobic period: 1.5 to 3 hrs
 - Anoxic period: 1 to 3 hrs
 - Aerobic period: 2 to 4 hrs
 - Settling period: 0.5 to 1 hr
 - Decant period: 0.2 to 1 hr

Note that an anaerobic period cannot be obtained in an SBR where nitrification is obtained until all of the nitrates have been reduced to nitrogen gas. Influent BOD is used for nitrification resulting in reduction of rbCOD needed for BPR.

Some simulator packages have models for simulating a variety of SBR processes. The input of wastewater data and plant specific characteristics such as nitrification rates can be introduced as for modeling the flow through process. Because an SBR is never at steady state, diurnal modeling should be used. The simulator may need to be run for a long period to ensure stabilization.

10.13.2 Denitrification Filters

Traditional design of denitrifying filters is done by first calculating a required surface area based on an assumed loading rate. Loading rates of 1.5 to 2 gpm/ft² and media depths of 6 to 9 feet are commonly used. For down-flow filters, the backwash is designed to minimize the amount of air introduced. The influent weir is also designed to avoid introduction of air. Upflow filters have the advantage of not requiring backwash. The methanol feed system should be designed to adjust the feed of methanol based on the COD in the influent. EPA has prepared a fact sheet on denitrification filters that includes the following information (USEPA 2007):

- Filter design characteristics, including:
 - Influent weirs
 - Media
 - Underdrain system
 - Nitrogen release cycle
 - Backwashing and filter controls
 - Methanol feed control system

- A comparison of denitrification filter manufacturers and equipment
- Cost factors

The fact sheet can be accessed at <http://www.epa.gov/OWM//mtb/mtbfact.htm> .

10.13.3 Primary Sludge Fermenters

Section 5.3.2 of this design manual describes the wide variety of approaches that can be used to achieve fermentation of primary sludge for BPR. The following should be considered as general guidelines for design and equipment specification regardless of configuration (WEF and ASCE 2006; Chanono 2006; Chen 2004):

- Sludge collector designs should be higher torque than conventional designs due to increased solids loading.
- The maximum SRT should depend on the temperature to avoid methanogenesis. It may range from 2 to 8 days.
- Air spargers may be used to reduce methanogenesis.
- A temperature between 16 and 25 degrees Celsius has been found optimal but many fermenters work at lower temperatures. Covering and insulation in cold climates has merit.
- The sludge concentration into the thickener will depend on the flow rate of the primary sludge. A continuous flow of around 2 to 4 percent of the influent is recommended to allow liquid for VFA elutriation. In a static fermenter the sludge could be thickened to 6 percent solids provided the sludge pumps can handle the dense sludge. The denser the sludge the more VFA will be elutriated.
- Because of the potential to produce carbon dioxide and hydrogen sulfide, corrosion-resistant materials should be used.
- Primary and fermented sludge pumps should generally be of the positive displacement type. Recessed impeller centrifugal pumps can be used for lower solids content streams such as fermentate.
- Sludge grinders or screens should be installed on sludge recycle lines to prevent clogging of the pumps.
- For complete mix tanks, slow speed mixers that impart 8 to 10 W/m³ energy into the liquid are recommended.
- Scum removal should be provided on mixing tanks and thickeners.
- Thickeners should be covered and the headspace scrubbed to control odor.

- Measuring oxidation reduction potential and keeping it above -600 mV by intermittently bubbling air through may help prevent methanogenesis in completely mixed fermenters. Adding some nitrified effluent to the static fermenter feed will serve the same purpose
- Installation of hydrogen sulfide sensors and alarms is a good idea to ensure worker safety and prevent methanogenesis since both tend to be generated at the same oxidation reduction potential.
- Sludge density meters and pH meters can aid in process control. A pH level of around 5 is an indication of good acid fermentation.

10.14 Design Checks for Biological Nitrogen and Phosphorus Removal

Tables 10-5 and 10-6 provide key design checks for biological nitrogen and phosphorus removal systems, respectively. These tables synthesize information presented throughout this design manual and can be used at various steps in the design process to ensure that key factors are considered.

Table 10-5. Design Checks for Biological Nitrogen Removal

Question	Yes	No
<p>1. Is the nitrification process designed for cold weather conditions? <i>The rate of nitrification is significantly impacted by temperature. It will decrease by approximately half for every 8 to 10°C decrease in operating temperature.</i></p>		
<p>2. Does the nitrification system design consider the impact of diurnal loadings of ammonia? <i>Influent ammonia concentrations vary, with peaks occurring during the day and much lower concentrations occurring overnight. Peak loads during the day are typically 1.5 to 2.0 times the average with some observations as high as 2.8 times the average.</i></p>		
<p>3. Does the nitrification system design account for recycles, including realistic predicted constituent loadings, flow rate, and schedule? <i>Return streams from sludge dewatering operations can add significant ammonia to the head of the plant. In many plants, supernatant from sludge dewatering is discharged during the day, which coincides with peak ammonia loadings to the plant.</i></p>		
<p>4. How does the design of the nitrification system take into account wet weather flows? <i>Wet weather flows can significantly increase hydraulic loading to the treatment plant, change the nature of the influent wastewater, and potentially washout the nitrification system. Strategies for managing wet weather flows range from collection system improvements to in-plant designs such as equalization basins.</i></p>		
<p>5. Is the operating DO for nitrification at least 2.0 mg/L? <i>In general, the DO at the influent end of the aeration basin should be at least 2.0 mg/L. For longer SRT systems, it can taper to 0.5 mg/L at the end of the basin. There are many benefits to designing flexible aeration systems that allow operators to reduce the DO at the end of the basin after the ammonia has been oxidized and less oxygen transfer is required. Integrated Fixed-film Activated Sludge (IFAS) systems may require higher DO concentrations in the mixed liquor to maintain the oxygen needed for attached biomass if maximum nitrification rates are desired. However, if simultaneous denitrification is desired in an IFAS system, lower DO concentrations can both stimulate denitrification and reduce the oxygen requirement in the aerated bioreactor because of COD stabilized using NO_x as the electron acceptor. This can be an effective method of nitrogen removal and can remove as much as 30% of the influent nitrogen. In long nominal hydraulic retention time systems such as oxidation ditches or extended aeration systems, DO concentrations between 0.25 and 0.50 mg/L can produce excellent simultaneous nitrification/denitrification in the same bioreactor because the rate of oxygen transfer does not control the rate of nitrification in such a process, stoichiometry does(i.e. the balance between electron donors (BOD) and electron acceptors (DO, NO_x) in the bioreactor).</i></p>		

Table 10-5. Design Checks for Biological Nitrogen Removal (Continued)

Question	Yes	No
<p>6. Does the design consider impacts of nitrification on alkalinity and pH? <i>The nitrification process consumes alkalinity. If the influent alkalinity is low, nitrification may reduce the mixed liquor pH, which can have an impact on performance because pH values below 7.0 significantly inhibit nitrification and pH values below 6.5 strongly inhibit nitrification and may result in nitrifier washout. Denitrification, however, partially replenishes alkalinity (50 percent of the alkalinity destroyed by complete nitrification of 1 mg/L of NH₄-N is restored by denitrification of 1 mg/L NO₃-N). Addition of lime, sodium hydroxide, or soda ash can be used to add alkalinity if low alkalinity is determined to be a problem.</i></p>		
<p>7. Is the design of the nitrification system based on site-specific determination of the nitrification rate? <i>The nitrification rate is extremely important because it determines the minimum SRT needed for complete nitrification to occur during steady state conditions. The nitrification rate varies significantly from plant to plant and can be low if inhibitors such as heavy metals are present. Melcer et al. (2003) presents three rapid methods for measuring maximum specific nitrifier growth rate, μ_{AUT}.</i></p>		
<p>8. Does the design minimize the amount of oxygen in the denitrification system? <i>Design and operation methods that minimize DO quantities entering the anoxic zones can reduce the amount of exogenous carbon needed and provide a more stable operation.</i></p>		
<p>9. If an external carbon source is added for denitrification, does the design include an analysis of possible increased sludge volume? <i>If an external carbon source is added to improve denitrification, there may be a small increase in waste sludge production. The magnitude of the increase depends on the amount and type of organic carbon added. Nitrification processes usually decrease the amount of sludge produced, however, so net production for the design of a new combined nitrification/ denitrification system may be equal to or less than sludge production by the same size conventional activated sludge plant.</i></p>		
<p>10. If the design calls for methanol to be added for denitrification, are proper safety and handling procedures considered? <i>Methanol is corrosive and combustible and requires special handling to meet Occupational Safety and Health Administration (OSHA) and other requirements.</i></p>		
<p>11. If biological or chemical phosphorus removal is also being practiced, does the design consider the possible impacts of phosphorus depletion on nitrification and denitrification? <i>Phosphorus is a necessary nutrient for microbial growth. If TP is reduced too low before nitrification or denitrification, the growth of the microorganisms could be inhibited, thereby requiring the addition of supplemental phosphorus. This is most likely to occur when tertiary denitrification filters are used, but inhibition of nitrification also has been observed in plants practicing chemical phosphorus removal in the primary clarifiers. It is also important to note that both BPR and denitrification require BOD to drive the reactions. If BPR is consuming some of the BOD, there will be less for denitrification.</i></p>		

Table 10-6. Design Checks for Biological Phosphorus Removal

Question	Yes	No
<p>1. Is the rbCOD:TP ratio of the influent consistently 15:1 or higher? <i>If not, consider a strategy to increase rbCOD such as fermenting primary sludge or adding a commercial product (e.g., acetic acid).</i></p>		
<p>2. Are odor control strategies used in the collection system (e.g., chlorination, addition of nitrate salts)? <i>If yes, the collection system managers should use strategies that do not prevent fermentation of rbCOD to VFA (e.g., ferric iron addition for odor control or modifying the pH to between 9 and 10).</i></p>		
<p>3. In situations where BPR is operated without nitrification, is the design SRT for the entire BPR system at least 3 to 4 days in temperate regions? <i>The minimum SRT to prevent wash-out of BPR is a function of the mixed liquor temperature, and BPR can be accomplished at SRTs less than 4 days if the temperature is high. Because BPR is driven primarily by microbial population dynamics resulting from the available VFA to available TP ratio in the anaerobic zone, SRT values above the minimum value up to 25 days or more have little effect upon the phosphorus removal accomplished by the process. Population dynamics also result in better steady-state performance of BPR at low temperatures because the primary competitors of the PAOs, the glycogen accumulating organisms (GAOs), are more strongly inhibited by temperature than PAOs.</i></p>		
<p>4. Does the design SRT for fermenters consider operating temperature? <i>VFA formation in the sewers is temperature dependent. Check the winter production. Higher SRTs (> 4 days) may be needed in colder climates to account for slower fermentation of rbCOD to VFA.</i></p>		
<p>5. Does the design take into account wet weather flows? <i>As with all biological wastewater treatment processes, BPR works best under steady state conditions. Equalization basins can be very effective at managing storm flows as well as nutrient rich recycle streams. Designs should also consider flexibility in aeration basins to take basins or compartments on and offline in response to seasonally changing flows.</i></p>		
<p>6. Does the design allow for flexibility of operations? <i>Most plants initially operate well below the design load. The design should allow for the flexible operation of various anaerobic, anoxic, and aerobic zones to match changes in operating conditions (e.g., turn down on blowers, recycle pumps, or less mixing energy in the aeration basin). A good approach to use when flows and loads are low is multiple treatment trains, of which one or more can be taken out of service.</i></p>		

Table 10-6. Design Checks for Biological Phosphorus Removal (Continued)

Question	Yes	No
<p>7. Does the design HRT of the anaerobic zone consider secondary release? <i>If the HRT of the anaerobic basin is too long, secondary release of phosphorus can occur after depletion of VFA. The anaerobic HRT is recommended to be 5 to 15 percent of the total HRT of the BPR system. HRTs on the lower side may be used in warm climates and on the higher side in colder climates. Note, however, that the development of anaerobic conditions in the latter part of the anoxic zone typically does not cause secondary release, but adds to the VFA uptake accomplished in the anaerobic zone, resulting in greater phosphorus removal by the total system. Also note that an oversized aerobic zone will result in excessive glycogen depletion in the PAOs, resulting in less VFA storage in the anaerobic zone and less overall phosphorus removal.</i></p>		
<p>8. Does the design take into account DO or nitrates in recycle streams to the anaerobic zone? <i>The design should minimize introduction of dissolved oxygen or nitrates to the anaerobic zone from recycle streams. Any DO or NO_x in the anaerobic zone will reduce VFA storage by the PAOs, and, thus, the total phosphorus removal obtained.</i></p>		
<p>9. Are measures in place to prevent backmixing? <i>If the anaerobic zone is followed immediately by an anoxic or aerobic zone, the configuration should prevent mixed liquor from seeping back into the anaerobic zone. Aerated zones have a higher water surface than unaerated zones. Use an overflow baffle between zones or an underflow baffle with openings small enough to maintain a forward velocity of at least 1 foot per second. Modeling can also be used to ensure that the configuration, mixing rate, and overall hydraulics are such that no backmixing occurs.</i></p>		
<p>10. Will chemical addition or nitrification cause the pH of the anaerobic zone to regularly fall below 6.9? <i>If yes, consider adding alkalinity to increase pH to more than 7.0. However, note that BPR can be accomplished at pH values in the anaerobic zone as low as 6.3, but at significantly slower rates than at pH values about 7. If the anaerobic zone pH is less than 6.0, BPR will be completely inhibited. A common pH profile for a BPR process is 6.8 to 7.0 in the anaerobic zone, but 7.8 to 8.2 in the aerobic zone, particularly if the system includes an anoxic zone between them.</i></p>		
<p>11. Does the design take into account phosphates in return streams from sludge dewatering? <i>In BPR plants, anaerobic digestion of sludge can release phosphorus into the liquid stream, which is normally returned to the plant after sludge dewatering. Much of the released phosphorus can, however, precipitate within the digester as struvite, calcium phosphate precipitates, or vivianite. Dissolved air flotation (DAF) or mechanical thickening can be used instead of gravity thickening to reduce phosphorus release during WAS processing.</i></p>		

Table 10-6. Design Checks for Biological Phosphorus Removal (Continued)

Question	Yes	No
<p>12. If phosphorus removal is accompanied by nitrification in a single sludge system, does the design factor consider nitrate in the RAS and its impact on BPR? <i>Nitrate can act as an electron acceptor for some heterotrophs, allowing them to use VFA in the anaerobic zone in the absence of oxygen. It will also prevent fermentation of the rbCOD to VFA. The model will generally account for this.</i></p>		
<p>13 Does the design take into account possible struvite formation? <i>When BPR is practiced, struvite may precipitate in anaerobic sludge handling processes. Depending on where they form, struvite crystals can plug centrifuge ports and the pipes and pumps used to convey sludge. Some models predict struvite formation, but not the impacts of it. Note that models do not capture all phosphorus precipitation or adsorption mechanism in the digester and thus may under-predict struvite precipitation and over-predict phosphate in the recycle stream.</i></p>		

10.15 References

- Albertson, O.E. 1995. Is CBOD5 Test Viable for Raw and Settled Wastewater? *Journal of Environmental Engineering*. 121(7): 515-520.
- Alex, J., M. Wichern, V. Spring, N. Halft, M. Ahnert, T. Frehmann, I. Hobus, G. Langergraber, M. Plattes, S. Winkler, and D. Woerner. 2007. A Method to Use Dynamic Simulation in Compliance to Design Rules to Refine WWTP Planning. In *Proceedings 10th IWA Specialised Conference on Design, Operation, and Economics of Large Wastewater Treatment Plants*. September 9-13. IWA.
- American Public Health Association (APHA), American Water Works Association (AWWA) & Water Environment Federation (WEF). 2005. *Standard Methods for the Examination of Water and Wastewater, 21st Edition*. Eds. A.D. Eaton, L.S. Clesceri, E.W. Rice, A.E. Greenberg, and M.H. Franson.
- Aquifas. 2009. Aquifas - Unified Model for Activated Sludge, Membrane Bioreactor - MBR, IFAS, MBBR and BAF. Cupertino, CA: MEC Technologies. Available online: www.aquifas.com
- ASIM. 2009. ASIM Version 4.0.2.4. EAWAG, The Swiss Federal Institute of Aquatic Science and Technology. Dübendorf, Switzerland: EAWAG. Available online: <http://www.asim.eawag.ch/>
- Baird, R. and R. Smith. 2002. Third Century of Biochemical Oxygen Demand. WEF.
- Barker, P.S. and P.L. Dold. 1997. General Model for Biological Nutrient Removal Activated Sludge Systems: Model Presentation. *Water Environment Research*. 69(5): 969-999.
- Barnard, J.L. 1975. Biological nutrient removal without the addition of chemicals. *Water Research*, 9(5/6), 485-490.

- Bilyk, K., I. Takács, J. Rohrbacher, P. Pitt, R. Latimer, and P. Dold. Full-Scale Dynamic Testing Advances Fundamental Understanding of Denitrification Filters. In *WEFTEC 2008*. Chicago, IL.
- Brdjanovic, D., M.C.M. van Loosdrecht, P. Versteeg, C.M. Hooijmans, G.J. Alaerts, and J.J. Heijnen. 2000. Modeling COD, N and P Removal in a Full-scale WWTP Haarlem Waarderpolder. *Water Research*. 34(3): 846–858.
- Borger, A.R., I. Takács, P.M. Roeleveld, H.W. de Mooij. SHARON Process Stability Modeled by BioWin. In *WEFTEC 2008*. WEF.
- Capuno, R.E., N.G. Love, A. Terada, S. Lackner, and B.F. Smets. 2008. Model Prediction of Completely Autotrophic Nitrogen Removal under Different Reactor Configurations. In *WEFTEC 2008*. WEF.
- Chanono, J., J. Ribes, A. Seco, and J. Ferrer. 2006. Optimum Design and Operation of Primary Sludge Fermentation Schemes for Volatile Fatty Acids Production. *Water Research*. 40(1):53 – 60.
- Chen, W., F.M. Steen, P.G. Green. 2004. Key Influential Factors for Sludge Pre-fermentation Process Design: A Case Study. *Environmental Technology*. 25(4):381 – 390.
- Comeau, Y., and I. Takács. 2008. Schematic Representation of Activated Sludge Models. In *WEFTEC 2008*. WEF.
- Copp, J. 2009. Modelling 101, How Can I Use a Process Model to Help Me Run My Plant or Design Plant Upgrades? WEF® Distance Learning Webcast Series. Modeling Expert Group of the Americas. February 25, 2009.
- Environment Canada. 1995. *Guidance Manual for Sewage Treatment Plant Liquid Train Process Audits*. Ontario Ministry of Environment and Energy. Prepared by CH2MHill and Hydromantis, Inc. Toronto ON, Canada: Ontario Ministry of Environment and Energy.
- Gernaey, K.V., M.C.M. VanLoosdracht, M. Henze, M. Lind, and S.B. Jorgensen. 2004. Activated Sludge Wastewater Treatment Plant Modeling and Simulation: State of the Art. *Environmental Modeling and Software*. 19: 763-783.
- Grady, C.P.L., G.T. Daigger, and H.C. Lim. 1999. *Biological Wastewater Treatment*. New York: Marcel Dekker.
- Gujer, W. , M. Henze, T. Mino, and M.C.M. van Loostrecht. 1999. Activated Sludge Model No. 3. *Water Science and Technology*. 39(1):183-193.
- Henze, M., W. Gujer, T. Mino, T. Matsuo, M. Wentzel, and G.v.R. Marais. 1995. Activated Sludge Model No. 2. IAWPRC Scientific and Technical Report No. 3. London, UK. IWA.
- Hu, Z., M.C. Wentzel, and G.A. Ekama. 2007. A General Kinetic Model for Biological Nutrient Removal Activated Sludge Systems – Model Development. *Biotech. Bioeng.* 98(6) 1242-1258.

- Hulsbeek, J. J.W., J. Kruit, P.J. Roeleveld, and M.C.M. van Loosdrecht. 2002. A Practical Protocol for Dynamic Modelling of Activated Sludge Systems. *Water Science and Technology*. 45(6)127–136. IWA Publishing.
- IWA. 2009. Good Modeling Practice: Guidelines for Use of Activated Sludge Models. IWA Taskgroup. International Water Association. Website accessed 26 January 2009. Available online: http://www.modeleau.org/GMP_TG/UP.htm
- Johnson, B. What Is Modeling? Presented at Modeling 101 - How to Use Simulators in the Design and Operation of Wastewater Treatment Facilities. WEF® Distance Learning Webcast Series. Modeling Expert Group of the Americas. February 25, 2009.
- Kissel, J.C., P.L. McCarty, and R.L. Street. 1984. Numerical Simulations of Mixed-Culture Biofilms. *Journal of Environmental Engineering*. 110: 393-411.
- Latimer, R.J., P.E. Paul, A. Pitt, and J. Rohrbacher. 2007. BNR/ENR Model Calibration Experience Indicates Deviations in Key Modeling Parameters. *Nutrient Removal 2007*. WEF.
- Latimer, R. J., P. Pitt, P. Dold, I. Takacs, and T. Lynch. 2008. Kinetic Parameters for Modeling Two-Step Nitrification and Denitrification – Case Study. In *WEFTEC 2008*. WEF
- McConnell, W.C., D. M. Hurtado, T. Cote. 2008. How Much Nitrogen can this Plant Remove? In *WEFTEC 2008*. WEF.
- Melcer, H., P.L. Dold, R.M. Jones, C.M. Bye, I. Takacs, H.D. Stensel, A.W. Wilson, P. Sun, and S. Bury. 2003. Methods for Wastewater Characterization in Activated Sludge Modeling. WERF Final Report. Project 99-WWF-3.
- Merlo, R., D. Parker, J. Jimenez, E. Wahlberg, and J. Bratby. 2008. Alternative Levels of Process Modeling in Consulting – What is Best for our Clients? In *WEFTEC 2008*. WEF.
- Merlo, R., D. Parker, and E. Wahlberg. 2007. Clarifying CFD Modeling's Benefits. *Water Environment & Technology*. 19(4): 48-53. WEF.
- Orhon, D. and E.U. Çokgör. 1997. COD Fractionation in Wastewater Characterization - the State of the Art. *J. Chem. Tech. Biotechnol*. 68:283-293.
- Petersen, B., K. Gernaey, M. Henze and P.A. Vanrolleghem. 2002. Evaluation of an ASM1 Model Calibration Procedure on a Municipal–Industrial Wastewater Treatment Plant. *Journal of Hydroinformatics*. 4(1):15-38. IWA Publishing.
- Reichert, P. 1998. AQUASIM 2.0 User Manual. Swiss Federal Institute for Environmental Science and Technology (EAWAG). Dubendorf, Switzerland.
- Rieger, L. 2009. Modelling 101, How Do I Carry Out a Successful Modelling Project?: The GMP Unified Protocol. Presented at Modeling 101 - How to Use Simulators in the Design and Operation of Wastewater Treatment Facilities. WEF® Distance Learning Webcast Series. Modeling Expert Group of the Americas. February 25, 2009.

- Rittmann, B.E. and P.L. McCarty. 2001. *Environmental Biotechnology: Principles and Applications*. McGraw Hill NY.
- Saez, P.B. and B.E. Rittmann. 1992. Accurate Pseudoanalytical Solution for Steady State Biofilms. *Biotechnology and Bioengineering*. 39:790-793
- Sen, D. and C.W. Randall. 2008a. Improved Computational Model (AQUIFAS) for Activated Sludge, Integrated Fixed-Film Activated Sludge, and Moving-Bed Biofilm Reactor Systems, Part I: Semi-Empirical Model Development. *Water Environment Research*. Alexandria, VA: WEF. 80(5):439-453.
- Sen, D. and C.W. Randall. 2008b. Improved Computational Model (AQUIFAS) for Activated Sludge, IFAS and MBBR Systems, Part II: Biofilm Diffusional Model. *Water Environment Research*. 80(7): 624-632.
- Sen, D. and C.W. Randall. 2008c. Improved Computational Model (AQUIFAS) for Activated Sludge, IFAS and MBBR Systems, Part III: Analysis and Verification. *Water Environment Research*. 80(7): 633-645.
- Shaw, A. 2009. Modelling 101, What Should I Consider When Selecting a Process Simulator? Presented at Modeling 101 - How to Use Simulators in the Design and Operation of Wastewater Treatment Facilities. WEF® Distance Learning Webcast Series. Modeling Expert Group of the Americas. February 25, 2009.
- Shaw, A., H.M. Phillips, B. Sabherwal, and C. deBarbadillo. 2007. Succeeding at Simulation. *Water Environment & Technology*. 19(4): 54-58. WEF.
- STOWA. 1996. Methods for Influence Characterization, Inventory and Guidelines, Report NR 96-08, in Dutch.
- STOWA. 1999. Influent Characterisation of Raw and Pre-Treated Wastewater. Report NR 99-13, in Dutch.
- Takács, I. 2009. Modeling 101, How Do Influent Characteristics Affect Model Outputs? Presented at Modeling 101 - How to Use Simulators in the Design and Operation of Wastewater Treatment Facilities. WEF® Distance Learning Webcast Series. Modeling Expert Group of the Americas. February 25, 2009.
- Third, K.A., A.R. Shaw, and L. Ng. 2006. Application of the Good Modelling Practice Unified Protocol to a Plant Wide Process Model for Beenyup WWTP Design Upgrade. London, UK: IWA Publishing.
- USEPA. 1993. *Nitrogen Control Manual*. Office of Research and Development. EPA/625/R-93/010. September 1993.
- USEPA. 1999. Wastewater Technology Fact Sheet: Sequencing Batch Reactors. EPA 832-F-99-073. Available online: http://www.epa.gov/owm/mtb/sbr_new.pdf
- USEPA. 2007. Wastewater Management Fact Sheet: Denitrifying Filters. EPA 832-F-07-014. Available online: www.epa.gov/OWM/mtb/etfs_denitrifying.pdf

Wanner, O., and W. Gujer. 1986. A Multispecies Biofilm Model. *Biotechnology and Bioengineering*. 28:314-328.

WEF and ASCE. 1998. *Design of Municipal Wastewater Treatment Plants - MOP 8, 4th Ed.* Water Environment Federation and American Society of Civil Engineers. Alexandria, VA: WEF.

WEF and ASCE. 2006. *Biological Nutrient Removal (BNR) Operation in Wastewater Treatment Plants - MOP 29.* Water Environment Federation and the American Society of Civil Engineers. Alexandria, VA: WEF Press.

WEF and ASCE. 2010. *Design of Municipal Wastewater Treatment Plants – WEF Manual of Practice 8 and ASCE Manuals and Reports on Engineering Practice No. 76, 5th Ed.* Water Environment Federation, Alexandria, VA, and American Society of Civil Engineers Environment & Water Resources Institute, Reston, Va.

WEF. 2009. Modeling 101 - How to Use Simulators in the Design and Operation of Wastewater Treatment Facilities. WEF® Distance Learning Webcast Series. Modeling Expert Group of the Americas. February 25, 2009.

Wett, B., S. Murthy, M. O'Shaughnessy, J. Sizemore, I. Takács, W. Bailey, M. Musabyimana, P. Sanjines, D. Katehis, and G.T. Daigger. 2008. Design Considerations for SBRs Used in Digestion Liquor Sidestream Treatment. 2008. In *WEFTEC 2008*. WEF.

Wilson, A.W. and P.L Dold. 1998. General Methodology for Applying Process Stimulators to Wastewater Treatment Plants. In *Proc. 71st Annual Conference of the Water Environment Federation*, Orlando, FL. Alexandria, VA: Water Environment Federation.

Vesilind, P.A. 1968. The Influence of Stirring in the Thickening of Biological Sludge. Ph.D. dissertation, University of North Carolina, Chapel Hill, N.C.

Young, T., S. Crosswell, and J. Wendle. 2008. Comparison of Nitrogen Removal Performance in SBR Systems. In *WEFTEC 2008*.

Zhou, S., J.A. McCorquodale, and Z. Vitasovic. 1992. Influences of Density Currents on Circular Clarifiers with Baffles. *Journal of Envir. Engineering*. ASCE. 118(6): 829-847.

11. Design Approach for Effluent Filtration

Chapter 11 covers:

- 11.1 Introduction
- 11.2 Selection of Filtration Technology
- 11.3 Granular Media Filters
- 11.4 Cloth Media Filters
- 11.5 Low-Pressure Membranes
- 11.6 Emerging Filtration Technologies for Phosphorus Removal
- 11.7 References

11.1 Introduction

Effluent (or tertiary) filtration is a process to physically separate solids from wastewater during tertiary treatment, either with or without tertiary clarification. Tertiary filtration is used for effluent polishing and can be very effective in removing particulate and colloidal phosphorus from wastewater. When combined with chemical treatment, tertiary filtration can achieve very low total phosphorus (TP) levels in plant effluents. Tertiary filtration also reduces total suspended solids (TSS) to very low levels, which in turn can result in more efficient disinfection and allow for the possible use of alternative disinfectants to chlorine such as ultraviolet light (UV) (EPA Region 10 2007). Turbidity is often used as the measure of tertiary filter performance instead of TSS because turbidity can be monitored continuously using online instruments.

Filtration technologies for wastewater treatment are continuing to evolve. Historically, granular media filtration was the most common type used at wastewater treatment plants (WWTPs), particularly for large systems. It provides physical straining of solids as water moves through filter beds containing sand and other media (e.g., anthracite). Downflow systems are the most common type, but continuous backwashing upflow systems (e.g., Dynasand®) are becoming more popular. Granular filters come in a variety of configurations based on depth, media, driving force (e.g., gravity or applied pressure through pumping), and method of flow control.

Advanced filtration technologies have been developed to provide enhanced performance and, in some cases, reduced footprint requirements. Some are adaptations of conventional granular media filtration. For example, the pulsed bed filter intermittently pulses air through a shallow sand bed to bring clean sand to the top and bury trapped solids, thereby making use of the full depth of a single filter media. The traveling bridge filter is a shallow, low-pressure head filter with an overhead traveling bridge assembly for collecting backwash water. Membrane filters have smaller pore sizes and can remove solids to very low levels, but they require higher pressures to operate. Specialty media filters have been designed specifically to remove additional phosphorus. See Chapter 6, Section 6.5 for a summary of available effluent filtration technologies.

Several publications provide detailed design guidance for effluent filtration (e.g., WEF and ASCE 2010; WEF 2006; Tchobanoglous et al. 2003). The purpose of this chapter is to provide key design factors that affect the performance of effluent filtration for the purposes of removing TP to low effluent

levels. Many states also have design criteria for filtration processes; designers should carefully review state requirements and guidelines. Because of the inherent variability in influent solids to be filtered, designers should strongly consider pilot testing to establish the design parameters for full scale effluent filtration (Tchobanoglous et al. 2003).

A new tool for the design of tertiary filters is computational fluid dynamic (CFD) modeling. CFD modeling can be used to predict filter performance prior to design. It can be used to complement laboratory or bench scale tests. Water Online (2009) reports that CFD modeling was used to predict performance of a deep bed granular media filtration technology for an upgrade to the Blue Plains WWTP in Washington, D.C.

11.2 Selection of Filtration Technology

Selection of a filtration process depends on many factors including effluent goals, available space, operational considerations, reliability, and costs. Chapter 8 of this design manual provides general guidelines for selecting candidate treatment processes for plant upgrades. Some key considerations for selecting a specific tertiary filtration technology are highlighted below.

- **Desired Effluent TP.** When operated properly, most conventional granular media filters can achieve consistent effluent levels of less than 0.1 milligrams per liter (mg/L) TP (as long as soluble phosphorus has been removed to less than that concentration) and less than 5 mg/L TSS¹. Combination technologies, membranes, and some emerging technologies can achieve additional TP removal. Technologies that can potentially achieve extremely low effluent TP levels of less than 0.05 to 0.01 mg/L include the following (Bott et al. 2007; Barnard et al. 2008; EPA Region 10 2007):
 - Two-stage filtration.
 - Enhanced clarification and tertiary filtration. Enhanced clarification may include high rate ballasted sedimentation or sludge blanket clarification.
 - Membrane filtration (microfiltration or ultrafiltration).
 - Specialty filters (e.g., an iron oxide coated sand filter).

As noted elsewhere in this design manual, removing phosphorus through chemical/physical processes requires a chemical addition step to convert soluble reactive phosphorus to a particulate or colloidal form. This conversion is typically accomplished by adding a metal salt such as alum or ferric chloride and requires proper mixing. See Chapters 3 and 9 of this design manual for details about the theory of phosphorus removal by chemical addition and the design of chemical feed and mixing systems.

- **Mode of Operation.** Operational considerations are important when evaluating filter technologies. Some technologies, such as the continuous upflow backwashing filters and

¹ Although these effluent concentrations have been observed in the field, technology performance depends on a number of factors and low limits are may not be consistently achievable in all cases. See Chapter 6 for full discussion of technology performance.

the traveling bridge filter, do not need to be taken out of service for backwashing. Shallow bed systems such as pulsed bed and traveling bridge filters require a lower flow rate and generate less backwash water compared to conventional granular media systems. The traveling bridge filter produces a relatively constant amount of backwash when the filter is in operation, which may eliminate the need for storage of the backwash water before it is introduced to the head of the treatment plant.

- **Size Constraints.** The surface area required for filtration depends on the hydraulic loading rate. Cloth, disk, and membrane filters operate at higher loading rates and thus, have smaller footprints than traditional granular media filters. Pulsed bed and traveling bridge filters have large footprints but have relatively shallow filter beds and thus, may require less pumping for regular operation.
- **Flexibility in Operations.** The total filter area should be provided in two or more units, allowing for continued operation if one filter needs to be taken off-line for backwashing or maintenance.
- **Costs.** Costs can be one of the most important factors in selecting a WWTP upgrade option. Cost estimates for comparing filtration technologies should be life cycle costs and should include all capital costs for construction, as well as operations and maintenance costs. For tertiary systems, it is important to weigh the additional capital and operating costs for advanced systems with more operator training and time required for less advanced, manually operated and adjusted systems. Cost estimates vary widely from facility to facility; refer to the USEPA Municipal Nutrient Removal Technologies Reference Document (2008b) for an evaluation of cost factors that should be considered for tertiary filtration systems.

11.3 Granular Media Filters

Granular media filters remove solid material from wastewater by passing the water through a filter bed containing media such as sand or anthracite. Suspended solids are removed primarily through physical straining—particles larger than the pore spaces are removed mechanically, while solids smaller than the pore spaces can be removed through chance contact. As solids accumulate within the filter media, flow will decrease and headloss will increase. Filters are periodically taken out of service and backwashed, typically on the basis of effluent quality or measured headloss, to remove the accumulated solids from the media.

The filter medium can be a single type (typically sand), dual media (commonly sand and anthracite), or multimedia (e.g., sand, anthracite, and garnet or ilmenite). The depth of the filter is classified as conventional (typically 2 feet) or deep bed (typically 4 to 6 feet). The filter medium commonly rests on a layer of gravel, which then rests on a filter underdrain system, although a direct media retention drain can be used which does not require gravel. The deeper the bed, the longer the filter can typically operate without backwashing, but a higher degree of pumping is required.

Downflow filters are equipped with an inlet channel to disperse the water evenly over the filter. They have a backwash system with control valves to stop the influent flow, a pump to force water up through the bed to expand the media, and collection troughs above the top of the media to collect the backwash water. Clean water for backwashing is usually pumped from a filtered water clearwell or

provided by gravity from an elevated tank (Tchobanoglous et al. 2003). A surface wash may be used prior to backwashing to break up the solids that accumulate on the top of the filter.

As effluent filtration has become more common for wastewater treatment, designers and manufacturers have modified the conventional downflow technologies in different ways to improve performance. Traveling bridge filters and upflow continuous backwashing filters do not need to be taken off-line for cleaning. Pulsed bed filters make efficient use of the entire depth of a single medium. As noted in the previous section, designers may want to consider one of these modifications for improved operations and performance depending on plant conditions and treatment goals.

The following are key design factors for removing particulate phosphorus from wastewater and are discussed in this section:

- Influent water quality
- Media specifications
- Filter loading rate
- Headloss
- Backwashing
- Flow control

Additional information and guidelines for design are provided in standard industry references such as Water Environment Federation (WEF) and American Society of Civil Engineers (ASCE) *Manual of Practice No. 8* and Tchobanoglous et al. (2003).

11.3.1 Influent Water Quality

The most important influent characteristics for designing a tertiary filter system are (1) the TSS concentration, (2) the particle size and distribution, and (3) the floc strength. The TSS of secondary effluent typically ranges from 6 to 30 mg/L, with corresponding turbidity values of 3 to 15 nephelometric turbidity units (NTU). The distribution of particles tends to be bimodal, meaning that there are two distinct peaks. One is typically between 0.8 and 1.2 micrometers (μm), and the second is between 5 and 100 μm (Tchobanoglous et al. 2003). There are also a few larger particles that do not readily settle in secondary clarifiers. Pilot testing is recommended to address the inherent variability in influent water quality.

If a chemical coagulant such as alum or ferric chloride is added directly prior to the filter for phosphate removal, the chemical should be well mixed to ensure formation of the solid precipitate. Organic polymers can be added to increase particle size and improve filtration performance. Jar testing should be used to determine coagulant and/or polymer dose. Pipes or conduits ahead of filters should be designed to minimize shearing of floc particles (Ten State Standards 2004).

11.3.2 Media Specifications

In a mono-media filter, larger media will settle to the bottom and smaller media will settle at the top during backwashing. This settling pattern results in a large proportion of solids being removed in the first few inches of the bed, leaving the rest of the bed unused and resulting in high headloss and short filter runs. Dual and multimedia filters are more commonly designed to utilize the entire filter bed by

layering the media with larger, lighter media on the top (e.g., anthracite) and smaller, heavier media (e.g., sand and garnet) on the bottom. During the backwash, media will stratify as they settle, retaining the desired gradation.

Important characteristics of granular filter media are density, sphericity, size, uniformity coefficient, and depth of media. Table 11-1 lists the most common filter media along with information on density and sphericity. Table 11-2 provides some typical values for depth, particle size, and uniformity coefficient for different filter types.

Table 11-1. Common Filter Media and Characteristics

Media	Density (Typical),	Sphericity
Sand	2.65	0.40 – 0.60
Anthracite	1.6	0.75 – 0.85
Garnet	4.2	0.60 – 0.80
Ilmenite	4.5	N/A

Source: Tchobanoglous et al. (2003)

Table 11-2. Filter Media Depths and Particle Sizes

Media	Depth (in)	Effective Particle Size (mm)	Uniformity Coefficient
Conventional Single Media (Sand or Anthracite)			
Sand	18 – 30	0.015 – 0.03	1.2 – 1.6
Anthracite	24 – 36	0.03 – 0.08	1.3 – 1.8
Deep Bed Single Media (Sand or Anthracite)			
Sand	36 – 72	0.08 – 0.12	1.2 – 1.6
Anthracite	36 – 84	0.08 – 0.16	1.3 – 1.8
Dual Media			
Sand	7 – 15	0.015 – 0.03	1.2 – 1.6
Anthracite	15 – 36	0.03 – 0.08	1.3 – 1.6
Multimedia			
Garnet	2 – 6	0.008 – 0.024	1.5 – 1.8
Sand	9 – 20	0.015 – 0.03	1.3 – 1.8
Anthracite	9 – 24	0.04 – 0.08	1.4 – 1.8

Source: Tchobanoglous et al. (2003)

The depth of the filter bed will depend on the media size and the desired operation. Deeper beds can go longer between backwashes; however, they will incur larger headloss and require more vigorous backwashing. The effective particle size is defined as the 10 percent size by mass and may be designated as d_{10} . The uniformity coefficient is a measure of the uniformity of the size of the media. It is defined as the ratio of the 60th percentile diameter to the 10th percentile diameter. While perfectly uniform media is not necessary, too large a uniformity coefficient can lead to smaller particles filling in the pore spaces between larger particles, which can cause filter clogging to happen earlier. The uniformity coefficient should be 1.7 or less (WEF and ASCE 1998; Ten State Standards 2004). Typically the effective size and uniformity coefficient values are used to specify granular media.

11.3.3 Filter Loading Rate

The filter loading rate, also called the filtration rate, is the flow per unit area applied to a filter, typically expressed in gallons per square foot per minute (gal/ft²·min) or liters per square meter per minute (L/m²·min). The design rate depends primarily on the floc strength and size of filter media and typically varies between 2 and 8 gal/ft²·min (Tchobanoglous et al. 2003).

The number and area of the filters should be such that the design filter loading rate is not exceeded when one filter is taken off-line for backwashing. It may be desirable to have flow equalization before the filters to avoid large peaks in loading rates.

11.3.4 Headloss

The operational headloss through the filters can be especially important for retrofits where a limited amount of pressure head to the filters is available before additional pumping is required. Two important design parameters are clean filter headloss and terminal headloss (i.e., maximum headloss before the filter is backwashed).

Several equations exist for headloss in a clean filter. One equation popular in the water industry is the Kozeny equation (AWWA 1999):

$$h = Lk\mu/\rho g * (1-\varepsilon)^2/\varepsilon^3 S_v^2 V \quad \text{Eq. 11-1}$$

Where:

- h = Headloss in ft
- L = Depth of the filter bed in ft
- k = Kozeny constant which is approximately 5 for most filter media
- μ = Viscosity of water in lb*s/ft²
- ρ = Density of water in lb/ft³
- g = Acceleration due to gravity (32 ft/s²)
- ε = Porosity of the media
- S_v = Specific surface, the ratio of volume to surface area for a particle
- V = Filtration velocity in ft/s, which is the filter loading rate divided by the total filter area

For dual and multimedia filters, the equation is calculated for each media layer and summed to get the total. The size fractions are determined by a sieve analysis of the media. Porosity and the specific surface depend on the characteristics of the media. The specific surface can also be denoted as 6/φd where φ is the sphericity and diameter. The media supplier should be able to supply values of sphericity, porosity, and sieve analysis results for the media to be used.

The terminal headloss of a granular media filter is the clean bed head loss plus the increase in headloss from removal of particulate material from the water. The design value depends on the solids storage capacity and solids capture efficiency of the filter and is usually based on prior experience or pilot studies (AWWA 1999).

11.3.5 Backwash Requirements

The purpose of the backwash is to remove trapped solids from the filter. In a conventional filter, backwash is accomplished by closing the filter effluent valve, stopping flow into the filter, and pumping clean water back through the media from the underdrains to the surface. The backwash velocity is increased until the bed is fluidized and expanded. The velocity of the water and the abrasion from particle collisions causes particles to separate from the filter media. The lighter entrapped particles are carried upward by the fluid velocity and collected in the backwash trough. The filter media settles back into the bed once the backwash is stopped. Backwash water is typically returned to the primary clarifiers (WEF and ASCE 2010).

The following equation can be used to estimate the expanded bed depth (Tchobanoglous et al. 2003):

$$L_e/L = (1 - \alpha)/(1 - (v/v_s)^{0.22}) \quad \text{Eq. 11-2}$$

Where:

- L = Unexpanded bed depth in meters (m)
- L_e = Expanded bed depth in m
- α = Porosity
- v = Backwash velocity in m/s
- v_s = Particle settling velocity in m/s

The particle settling velocity, V_s , is given by:

$$v_s = g(sg_p - 1)d_p^2/18\nu \quad \text{Eq. 11-3}$$

Where:

- g = Acceleration due to gravity, 9.8 m/s²
- sg_p = Specific gravity of the media
- d_p = Diameter of the media in m
- ν = Kinematic viscosity in m²/s

L_e/L is important in determining the required freeboard and the distance from the top of the unexpanded filter bed to the bottom of the backwash trough. Tchobanoglous et al. (2003) recommends that the backwash troughs be set 2 to 6 inches above the expanded filter bed and have a minimum freeboard of 24 inches at the upper end of the trough.

Because of the nature of wastewater, additional abrasion may be necessary to achieve proper filter cleaning. This is especially true with anthracite media, which (because of its nature) can adsorb organic components such as oils and greases. Additional scour can be obtained by adding air to the backwash and/or by a surface scour. Care should be taken to minimize loss of anthracite media during the design of the air scour system. It is important to note that deep bed filters cannot be fully fluidized and will require air scouring to achieve proper cleaning.

Filters can be backwashed either at set intervals or based on a given headloss or effluent turbidity. They can also be operated with a combination of the two, backwashing the filter on set time

intervals with an alarm set to automatically backwash the filter if turbidity or headloss levels get too high.

One way to extend the time between backwashes is pulsed bed filters. Pulsed bed filters are proprietary shallow bed filters. They use the entire bed of the filter to capture and store solids. Pulsed bed filters have air trapped in the underdrain system. A pulse of air is periodically released and allowed to flow upward through the media bed. The air disrupts the filter bed and allows the solids to penetrate further into the bed, breaking up the mat of solids that would otherwise form on the surface of the filter and enabling longer filter runs.

Automatic Backwash Designs

Figure 11-1 shows a schematic of an upflow continuous backwashing filter. The water is introduced at the bottom of the media and allowed to flow upward through the media. It is collected at the top of the filter and sent to the effluent. Media are allowed to flow downward through the filter and are collected at the bottom. An airlift pipe at the bottom of the filter collects spent media and transports it to the top of the filter using compressed air. As the spent media and water are transported upward by the compressed air, captured particles are scoured from the media. The media and dirty water are discharged into a washing chamber at the top of the filter. The spent sand is allowed to settle and is then returned back to the top of the filter. The captured particles and water carrying them are discharged through a reject compartment as backwash water. A common trade name for this kind of filter is Dynasand®.

Continuous backwash filters have several advantages, including capability to handle higher TSS concentrations without binding, low maintenance due to no moving mechanical parts, low headloss, and no equalization required for backwash water. Disadvantages are the foreign objects can plug the air lift pipe and most units are proprietary.

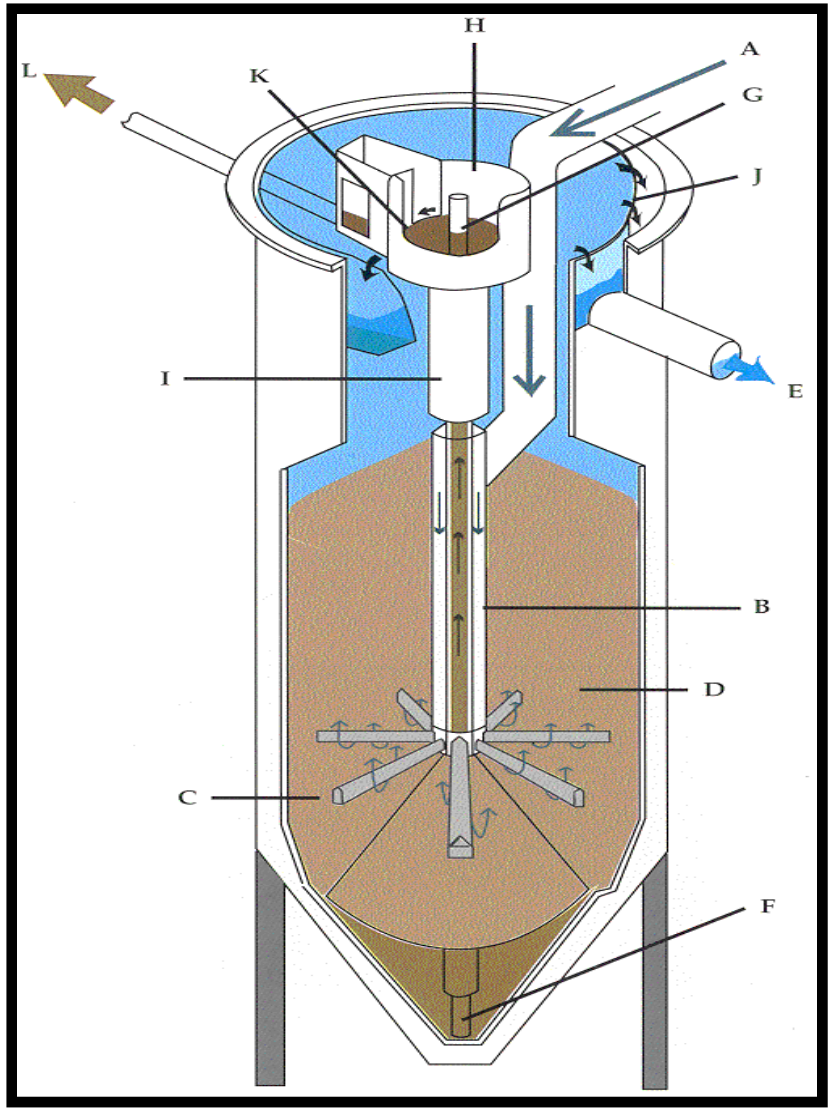

- A- Feed
- B- Feed assembly
- C- Distribution
- D- Sand bed
- E- Filtrate
- F- Airlift pump
- G- Airlift discharge
- H- Reject compartment
- I- Washer section
- J- Filtrate weir
- K- Reject weir
- L- Reject line

Figure 11-1. Example of Upflow Continuous Backflow Filter (DynaSand® Filter)
 Source: Courtesy of Parkson Corporation

11.3.6 Flow Control

There are several ways to control the flow rate through a conventional downflow granular media filter. The most common methods are constant-rate filtration with a fixed head, constant-rate filtration with a variable head, and variable-declining-rate filtration. In constant-rate filtration with a fixed head, the filtration rate is kept constant. Pumps, weirs, or effluent control valves are used to maintain a constant flow and constant water level in the filters as solids accumulate and the headloss increases. In constant-rate filtration with variable head, pumps and weirs are used to keep the flow through the filter constant, but the water level above the filters is allowed to change. The filter is backwashed when the level reaches a pre-set level. In variable-declining-rate filtration, the flow is allowed to decrease as the headloss in the filter builds up. The filter is backwashed when the minimum design flow is reached.

It is also possible to have pressure filters where the filter is contained in a pressure vessel, and a high pressure is applied to drive the liquid through the filter. These filters can achieve higher filtration rates than conventional filters and require less space. They are generally used at smaller treatment plants but do require more maintenance and care.

11.4 Cloth Media Filters

Cloth media filters remove solids by passing water through a cloth disk. The cloth panels are installed vertically inside a tank with water moving horizontally through the panels. Cloth filters are generally designed in one of two configurations, although nearly all of them are proprietary and will involve slight differences. In one configuration, two or more cloth disks are installed vertically inside a tank. Water to be filtered is introduced between the disks and flows outward through the cloth. The disks slowly rotate with approximately 60 to 70 percent of the surface area submerged at any given time. The un-submerged portion is sprayed with backwash water to remove accumulated solids. The dislodged solids are collected in a backwash trough and recycled to the head of the plant. The backwash can be applied continuously and does not require taking the unit off-line.

Another configuration also consists of a series of vertical disks covered with cloth submerged in a tank. In this case, flow is from one side of the tank through the cloth and into a collection tube or header. The disks do not rotate and are fully submerged. When the pressure drop reaches a pre-determined level, the unit is taken off-line and backwashed. Because of the nature of the cloth material, cleaning with a jet spray is occasionally needed. Figure 11-2 shows an example of this configuration.

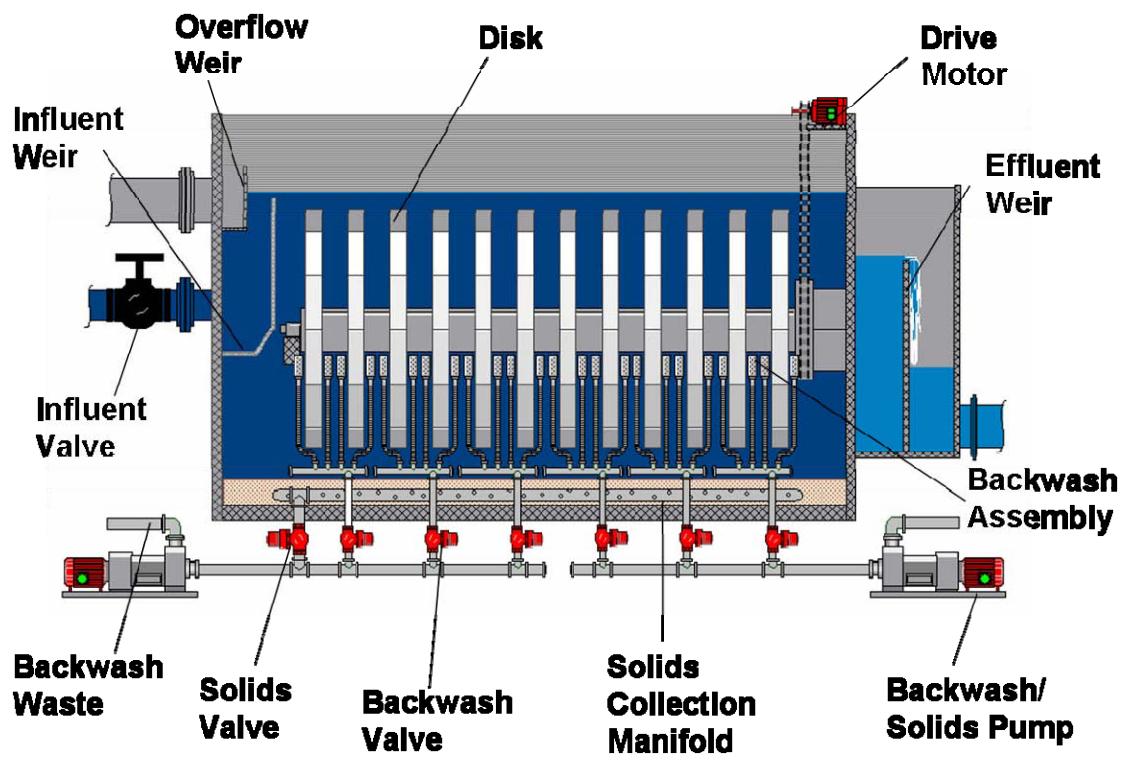

Figure 11-2. Cutaway view of AquaDisk® cloth media filter.

Source: <http://www.aqua-aerobic.com/default.asp> , reprinted with Permission from Aqua-Aerobic Systems, Inc.

Cloth filters have pore sizes on the order of 10 to 30 μm . They can operate at a higher hydraulic loading rate than granular media filters and require a lower backwash rate since the media do not need to be fluidized. They have been traditionally installed in small plants (5 to 10 MGD) but have recently been used at larger installations (USEPA 2008b).

Lin (2007) reported results from two pilot tests of AquaDisk[®] cloth media filters with respect to phosphorus removal. Design flows were approximately 2 and 6 MGD, respectively, and hydraulic loading rates to the filter ranged from 3 to 6.7 gpm/ft^2 . Prior to filtration, a two-stage system provided rapid mix of ferric sulfate and polymer followed by flocculation. Pilot testing results showed that both ferric sulfate and polymer addition were key to TP removal to concentrations of less than 0.3 mg/L .

A new filtration technology, the Ultrascreen[®] Microfilter was recently tested at the Southern Water Reclamation Facility in Palm Beach, FL. The unit is a cloth disk filter but unique in that the disks are mounted at less than 90 degrees, resulting in tangential filtration. Dalton et al. (2008) observed that it can operate at higher hydraulic loading rates (up to 12 gpm/ft^2) compared to traditional disk filters. The authors did not evaluate effluent TP levels but observed very low effluent turbidity of 2 NTU.

11.5 Low-Pressure Membranes²

Membrane filtration removes particles by forcing water through a porous membrane. Membranes can be classified by the pressures used to operate them, the pore size, or the mechanism by which separation is achieved. Microfiltration (MF) and ultrafiltration (UF) are considered low pressure membranes with operating pressures up to about 90 pounds per square inch (psi). They have relatively well defined pores and generally operate based on size exclusion, with particles larger than the average pore size being rejected and those smaller passing through the membrane. MF and UF systems used for wastewater treatment have pore sizes that typically range from 0.04 to 0.2 microns. Nanofiltration (NF) and reverse osmosis (RO) are high pressure membranes, operating at pressures up to 1,200 psi, and are typically used for water reuse applications. Table 11-3 shows the characteristics of different membrane types.

Table 11-3. Membrane Characteristics

Membrane Type		Pore Size (microns)	Operating Pressure (psi)
Low Pressure	Microfiltration (MF)	0.1 – 10	1 – 30
	Ultrafiltration (UF)	0.01 – 0.1	3 – 80
High Pressure	Nanofiltration (NF)	0.001 – 0.01	70 – 220
	Reverse Osmosis (RO)	< 0.001	800 – 1200

Source: WEF (2006)

In recent years, low-pressure membranes have been considered for tertiary filtration. Low-pressure membranes can consistently achieve significant reductions in TP as long as it has been

² Note that this section discusses membrane technologies for effluent filtration. See Chapter 6 for a discussion of membrane bioreactors (MBR).

converted to particulate and colloidal form. Significant phosphorus removal to less than 0.01 mg/L has also been reported for pilot and demonstration studies (Bott et al. 2007; see Section 11.5.6 for more information). WEF (2006) reports that based on results of a 2003 survey of full-scale systems, the largest use of low-pressure membranes is to pre-treat prior to high-pressure membrane systems such as reverse osmosis (RO) for the purposes of reuse.

This section highlights key design parameters for low-pressure membrane systems for the purposes of tertiary filtration. Designers should refer to the WEF publication, "Membrane Systems for Wastewater Treatment" (2006) for additional information.

11.5.1 Membrane Material

Membranes used in wastewater processes are generally made of cellulose or other organic polymers. Although inorganic membrane materials exist, they are generally expensive and have not found wide use in municipal wastewater processes. Elements to consider in selecting a membrane material include thermal stability, chemical stability, cost, and chlorine resistance.

Thermal stability can be important in areas experiencing high temperatures. Some membrane materials can degrade at high temperatures; for example, cellulose acetate membranes cannot be used at temperatures higher than 86°F. Different types of membrane materials can be degraded by different types of chemicals such as aromatic hydrocarbons, acids, and chlorine. Table 11-4 shows the advantages and disadvantages of various membrane materials.

Table 11-4. Advantages and Disadvantages of Membrane Materials

Material	Advantages	Disadvantages
Cellulose Acetate	Inexpensive Easy to fabricate	Temperature limited to below 86°F pH limited to between 3 and 6 Poor mechanical stability Biodegradable Limited chlorine resistance
Polyamide	Thermally stable to 122° F Stable for pH 3 to 11	Chlorine sensitive
Polypropylene	Moderate thermal stability	Less chemical-resistant than polytetrafluoroethylene Elongated pores Chlorine sensitive
Polysulfone	Thermally stable to 167° F pH range of 1 to 13 Good chlorine resistance Resistant to aliphatic hydrocarbons, fully halogenated hydrocarbons, alcohols, and acids	Poor resistance to aromatic hydrocarbons, ketones, ethers, and esters Low pressure limits (25 – 100 psi)
Polytetrafluoroethylene	Very hydrophobic Excellent organic resistance Excellent stability with acids, bases, and solvents Stable over all probable temperatures	Pore sizes below MF unavailable Expensive
Polyvinylidene Fluoride	Autoclavable Good solvent resistance	Less chemically resistant than polytetrafluoroethylene Pore sizes below UF unavailable

11.5.2 Membrane Configuration

Membranes are available in a number of configurations. Individual membranes can be constructed in flat sheets, hollow fibers, tubes, and spiral wound configurations.

Flat sheet membranes are secured within supporting plates and placed in a housing parallel to many other flat sheets. Water is filtered as it passes through the channels between the plates.

Hollow fiber membranes consist of small diameter hollow fiber bunched together in bundles consisting of hundreds or even thousands of fibers. Water to be filtered is introduced into the inside of the fiber and flows to the outside. Hollow fiber membranes are popular because the small diameter allows for a large number of membranes to be grouped together with a much greater surface area per volume ratio than other membrane configurations. They also require lower pressure to drive the filtration. This configuration can lead to lower life cycle costs.

Tubular membranes are similar to hollow fiber membranes except that the size of the hollow tube is about an order of magnitude greater. Hollow fibers are typically on the order of a few millimeters in diameter, while tubular membranes are on the order of centimeters. The larger size of tubular membranes makes them easier to clean and better for waters with higher solids content.

Spiral wound membranes consist of a flexible permeate spacer placed between two membrane sheets, which are then wrapped in a spiral configuration around a perforated pipe. The membrane is

sealed on all sides except the side exposed to the perforated pipe. Permeate is introduced along the spacer parallel to the pipe and flows through the membranes into the perforated pipe.

Membranes can either be housed in a pressure vessel or submerged directly in an open channel or chamber. Flat sheet membranes and hollow fiber membranes can be used in open channels or pressure vessels. Spiral wound and tubular membranes are used in pressure vessels.

Flow through a membrane can be of two types: cross flow and direct feed flow. In cross flow mode, water flows tangential to the membrane. Water that does not pass through the membrane is collected at the end of the unit and recirculated with additional feed water. Direct feed flow requires all the water to pass through the membrane on the first pass.

11.5.3 Process Considerations

Process considerations for designing membrane systems include pretreatment, backwashing, cleaning, and integrity testing.

Solids, filamentous or fibrous material, metals, microbial growth, and some organics can cause fouling of membranes. Fouling can lead to increased cleaning frequency and shorter membrane life leading to lower flow rates and higher costs. Various pretreatment facilities can be installed to reduce fouling and increase membrane life. Straining should be done to remove filamentous material prior to the membranes. Typically strainers with an opening of 2 mm or less are used. Granular media and cartridge filters are also used to remove larger particulates prior to the membranes. For NF and RO systems where solids removal is more important, low-pressure membranes such as MF or UF are often installed as a pretreatment step.

Membranes are backwashed to remove solids that have accumulated on the feed side of the membrane. Backwashing is accomplished by taking the membrane out of service and reversing the flow. Backwashes are more frequent with membrane applications than conventional filtration, with typical periods between backwashes on the order of 15 minutes to an hour. Backwash is typically initiated based on changes in transmembrane pressure (TMP). As with conventional filtration, sufficient membrane units should be in place so that no one unit is overloaded if one membrane is off-line for backwashing or cleaning. Backwash water is usually returned to the head of the treatment plant. WEF (2006) reports that the total backwash volume is between 2 and 10 percent of average daily flow.

Although backwashing can be very effective in removing most contaminants, it cannot remove all contaminants or compounds embedded in the membrane itself. For this reason, most low-pressure membrane technologies come equipped with chemical cleaning capabilities, or clean-in-place (CIP) systems. Procedures for cleaning may include a prolonged backwash with chemical addition or immersion in a chemical bath. Cleaning chemicals include acids, bases, and surfactants. Designers should consult the manufacturer to ensure use of chemicals suitable for the membrane material. CIP chemicals will require a storage tank, mixing system, and a chemical feed pump. UF and MF membranes are typically cleaned once every three to four months.

Integrity testing of membranes is not generally required for wastewater systems; however, it is recommended to ensure that none of the membranes are damaged. Integrity testing can be indirect or direct. Indirect methods measure water quality parameters such as turbidity or particle counts to determine if the membrane is not functioning properly. They are not as sensitive as direct methods but

do not require taking the membrane off-line. Direct methods generally are based on filling the permeate side of the membrane with air. If the membrane is wet, increased pressure will be required to push water through the membrane due to the surface tension within the pores. The pressure decay test, diffusive air flow test, bubble point test, and sonic testing are different methods that can detect leaks in a membrane. The frequency of testing is a balance between the inconvenience of taking a unit off-line for testing and the need for ensuring effluent quality.

11.5.4 Pressure Drop

Pressure drop across the membrane is important for determining the required energy necessary for the filtration process. For membranes in a cross flow configuration, the transmembrane pressure (TMP) can be calculated using the following equation:

$$P_{tm} = (P_f + P_c)/2 - P_p \quad \text{Eq. 11-4}$$

Where:

- P_{tm} = Transmembrane pressure in bars
- P_f = Pressure of the feed stream in bars
- P_c = Pressure of the concentrate stream in bars
- P_p = Pressure of the permeate stream in bars

For membranes in a direct feed configuration, the equation is:

$$P_{tm} = P_f - P_p \quad \text{Eq. 11-5}$$

The transmembrane pressure in combination with the required flux across the membrane will determine the required membrane area.

11.5.5 Flux Determination

Flux is the flow per unit area across a membrane, typically reported in liters/meters²-hour (L/m²-hr) or gpd/ft². The membrane filtration system can be operated in one of three ways: (1) the pressure can be kept constant and the flux allowed to vary, (2) the flux can be kept constant and the pressure allowed to vary, or (3) both pressure and flux can be allowed to vary. Nearly all municipal membrane systems operate according to the first, on a constant flux basis. One study, however, indicated that allowing both pressure and flux to vary may be the most effective mode of operation (Bourgeois et al. 1999).

The flux is related to flow and area by the equation:

$$Q_p = F_w A \quad \text{Eq. 11-6}$$

Where:

- Q_p = Permeate flow rate in m³/s
- F_w = Transmembrane flux rate in m/s
- A = Membrane area in m²

The flux can be related to the pressure drop by the equation:

$$F_w = A_p(P_T - P_O) \quad \text{Eq. 11-7}$$

Where A_p is the membrane permeability coefficient in $L/m^2 \cdot h/kPa$, P_T is the transmembrane pressure in kPa or psi, and P_O is the osmotic pressure of the feed solution in kPa or psi.

K_w will vary depending on the temperature, membrane characteristics, and influent water characteristics. In general during design, an operating pressure will be chosen and the flux determined for the desired flow rate. The area of membrane required can then be calculated. The process can be iterated if the given area is not feasible. Typical operating pressures and fluxes can be obtained from the manufacturer for a given membrane. Immersed membranes typically operate between 16 and 24 gpd/ft^2 . Pressurized inside and outside, they can operate at high flux values of between 30 and 35 gpd/ft^2 (WEF 2006).

11.5.6 Performance Data

Table 11-5 summarizes results from recent pilot studies to evaluate the removal of phosphorus using low-pressure membranes as tertiary filters.

Table 11-5. Phosphorus Removal Reported From Membrane Pilot Studies

Location	Type of Study and Test Period	Membrane Tested	Configuration	Operating Flux (gpd/ft^2)	Effluent TP (mg/L)	Comments
Spokane, WA	Demonstration pilot, Aug to Dec 2007	Submerged hollow fiber UF with nominal pore size of 0.05 by Koch	Two 30 m^2 modules and tank	20 - 34	0.3 to 1.7, (Avg = 0.7)	Removal was highly dependent on alum addition prior to filter
Coeur D'Alene, ID	Pilot, May to Oct 2006	Immersed hollow fiber UF with nominal pore size of 0.04. ZeeWeed 500 system by Zenon	<i>Not reported</i>	<i>Not reported</i>	0.024 to 0.067	Excursions caused by problems with alum feed or inadequate pH control

Sources: Stahyamoorthy et al. (2008); Benisch et al. (2008)

11.6 Emerging Filtration Technologies for Phosphorus Removal

11.6.1 Two-Stage Filtration

Two filters in series can provide enhanced solids removal and process control. EPA Region 10 (2007) reported excellent phosphorus removal for the Breckenridge, the Snake River, and the Alexandria WWTPs using a two-stage treatment process with chemical addition and tertiary settling prior to filtration. A proprietary two-stage filter, the Dynasand D2 filtration system by Parkson, has been tested at several facilities and is reported to achieve extremely low effluent TP levels when combined with chemical addition (EPA Region 10 2007; Bott et al. 2007). Benish et al. (2008) reported operational

problems, however, during pilot testing that resulted in effluent TP levels averaging 0.084 mg/L compared to the target effluent limit of 0.050 mg/L.

The Dynasand D2 filter consists of two continuously cleaning upflow granular media filters in series (see Figure 11-3 for a typical configuration). The first is a deep bed filter containing large sand grains. It employs a proprietary process called continuous contact filtration (CCF) where coagulation, flocculation, and solids removal occur within the filter bed. The second filter is a polishing filter and has smaller sand grains and a shallower bed. The water is introduced into the bottom of the sand bed through a number of radial arms. Particulates are removed as the water flows upward through the bed. Sand media is continuously drawn into the airlift pipe at the bottom of the filter where it is scoured and returned to the top through a central assembly. The reject rate reported by the manufacturer is 0.5 percent of feed flow, although higher rates have been reported (EPA Region 10 2007).

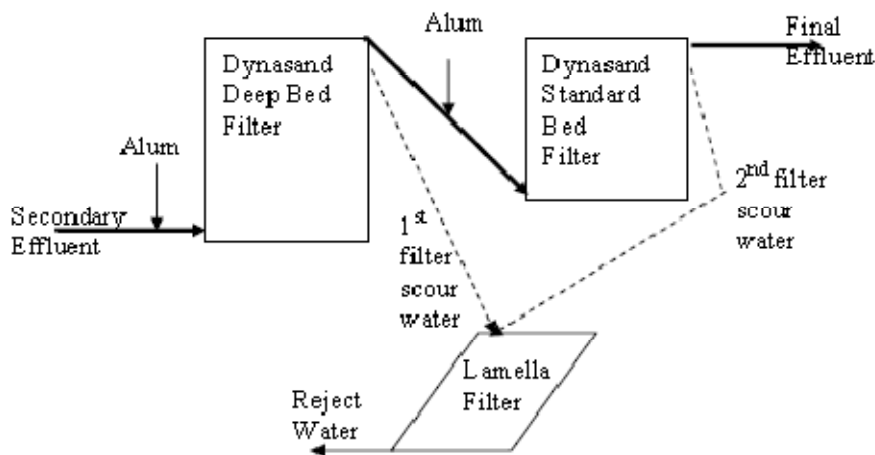

Figure 11-3. Parkson Dynasand D2 advanced filter system.
Source: USEPA 2008b, Figure2-18.

11.6.2 Iron Oxide Coated Media

The Blue PRO™ process is a continuous upflow backwashing filter designed specifically to remove phosphorus to extremely low effluent levels through adsorption of precipitated phosphorus. The filter was originally developed at the University of Idaho and has been tested at WWTPs in Idaho and Florida. Skid-mounted systems can treat between 5 and 100 gpm, and concrete slab units can treat up to 1 MGD. USEPA (2008a) reports that this particular system is not suitable for plants treating more than 10 MGD due to the sheer number of units that would be required.

The filter media (sand) is coated with a hydrous ferric oxide coating, which enhances phosphorus removal through adsorption. A ferric salt is added prior to the filter to aid in coagulation and to replace the ferric coating, which is abraded from the sand during operation. Water flows up through the filter while the sand travels down. An airlift tube at the bottom of the filter carries the sand upward. Turbulence from the compressed air dislodges accumulated iron and phosphorus along with any solids. The iron, phosphorus, and particles are wasted, while the clean sand is deposited on the top of the bed. The Blue PRO® filter runs continuously and does not need to be taken off-line for backwashing. It has an

added advantage of recycling material instead of accumulating phosphorus in sludge where it is susceptible to secondary release during processing.

See Figure 11-4 for a typical two-stage configuration. Results from pilot studies are summarized in Table 11-6.

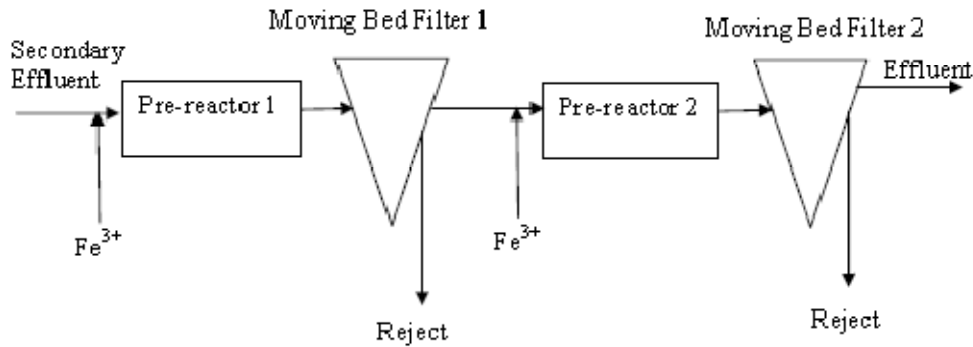

Figure 11-4. Blue-PRO® process.
Source: USEPA 2008b, Figure 2-20.

Table 11-6. Pilot Test Results for the Blue Water Blue PRO® System

Location	Flow (MGD)	Duration of Study	Influent TP (mg/L)	Effluent TP (mg/L)	Operational Factors
Hayden Wastewater Research Facility, Hayden ID	0.25	3 months (Dec 05 – Feb 06)	6 mg/L	Avg of 0.011	Fe dose = 5 mg/L
Coeur D’Alene, ID				0.013 – 0.034 (Avg of 0.021)	Fe dose = 38 mg/L
Eastern Florida (test results reported by manufacturer)	0.0144 (10 gpm)	2 months (Nov – Dec 07)	4 mg/L	All results < 0.010	Optimized Fe dose was key to performance

Sources: Newcombe et al. (2008); Benisch et al. (2007); Blue Water Technologies (2008)

11.7 References

- AWWA. 1999. *Water Quality & Treatment: A Handbook of Community Water Supplies, 5th Edition*. Letterman, R.D., Technical Ed. McGraw-Hill, Inc.
- Barnard, J.L., H. Phillips, B. Sabherwal, C. deBarbadillo. 2008. Driving Membrane Bio-Reactors to Limit of Technology. Presented at WEFTEC 2008.
- Benisch, M., D. Clark, Neethling, J.B., H.S. Fredrickson, A. Gu. 2007. Can Tertiary Phosphorus Removal Reliably Produce 10 ug/L?: Pilot Results from Coeur D’Alene, ID. Presented at Nutrient Removal 2007. WEF.

- Blue Water Technologies. 2008. Blue Pro Pilot Project Report: Phosphorus Removal from Wastewater Located at a Municipal Wastewater Treatment Plant in Florida. Blue Water Technologies, Inc. Hayden, Idaho.
- Borgeous, K., G. Tchobanoglous, and J. Darby. 1999. Performance Evaluation of the Koch Ultrafiltration Membrane System for Wastewater Reclamation. Center for Environmental and Water Resources Engineering. Report No. 99-2, Department of Civil and Environmental Engineering, University of California Davis, CA.
- Bott, C.B., S. N. Murthy, T. T. Spano, and C.W. Randall. 2007. WERF Workshop on Nutrient Removal: How Low Can We Go and What is Stopping Us from Going Lower? Alexandria, VA: WERF.
- Caliskaner, O. and G. Tchobanoglous. 2005. Modeling Depth Filtration of Activated Sludge Effluent Using a Compressible Medium Filter. *Water Environment Research*. 77(7): 3080.
- Caliskaner, O. and G. Tchobanoglous. 2008. Development and Solution of Depth Filtration Equation. Presented at WEFTEC 2008.
- Chalmers, R.B., M. Patel, B. Dunnivin, and D. Cutler. 2008. Orange County Water District's Groundwater Replenishment System is Now Producing Water. Presented at WEFTEC 2008.
- Dalton, D., D.E. Loy, M.G. Schill. 2008. Demonstration of "Dynamic Tangential Filtration" at Palm Beach County to Produce High Quality Reuse Water. Presented at WEFTEC 2008.
- EPA Region 10. 2007. Advanced Wastewater Treatment to Achieve Low Concentration of Phosphorus. EPA Region 10. EPA 910-R-07-002. Available online: [http://yosemite.epa.gov/r10/water.nsf/Water+Quality+Standards/AWT-Phosphorus/\\$FILE/AWT+Report.pdf](http://yosemite.epa.gov/r10/water.nsf/Water+Quality+Standards/AWT-Phosphorus/$FILE/AWT+Report.pdf)
- Hendron, L., M. Laquidara, S. Sathyamoorthy, G. Shrope, Gale Olrich, and J. Barr. 2008. Water Reuse as Part of the City of Spokane's Integrated Approach to Reduce Phosphorus Discharge. Presented at WEFTEC 2008.
- Lin, H., D.J. Binder, and L.W. Johnson. 2008. Effect of Particle Removal by OptiFiber® PA-13 Nylon Pile Media on Particle Size Distribution and Correlation between Turbidity and Total Suspended Solids. Presented at WEFTEC 2008.
- Möller, G. 2006. Absolute (1000-fold) Phosphorus Removal: Performance, mechanisms and engineering analysis of iron-based reactive filtration and coupled CEPT at the Hayden, Idaho WWTP. University of Idaho.
- Newcombe, R.L., R.A. Rule, B.K. Hart, and G. Möller. 2008a. Phosphorus Removal from Municipal Wastewater by Hydrous Ferric Oxide Reactive Filtration and Coupled Chemically Enhanced Secondary Treatment: Part I - Performance. *Water Environment Research*. 80(3):238-247.
- Newcombe, R.L., D.G. Strawn, T.M. Grant, S.E. Childers, and G. Möller. 2008b. Phosphorus Removal from Municipal Wastewater by Hydrous Ferric Oxide Reactive Filtration and Coupled Chemically Enhanced Secondary Treatment: Part II - Mechanism. *Water Environment Research*. 80(3):238-247.

- Olivier, M. and D. Dalton. 2002. Filter Fresh: Cloth-Media Filters Improve a Florida Facility's Water Reclamation Efforts. *Water Environment & Technology*. 14(11). Alexandria, VA: WEF.
- Sathyamoorthy, S., M. Laquidara, N. Anand, Z. Nikolic, S. Dukes, and A. von Gottberg. 2008. Operation of Submerged Hollow Fiber Ultrafiltration Membrane for Treatment of Secondary Effluent. Presented at WEFTEC 2008.
- Scott, S.A. and E.A. Lawrence. 2007. Pilot Study Application of Tertiary Clarification and Filtration to Meet Proposed Ultra Low Phosphorus Discharge Limits on the Spokane River. Presented at Nutrient Removal 2007. WEF.
- Tchobanoglous, G., F. L. Burton, and H.D. Stensel. 2003. *Wastewater Engineering: Treatment and Reuse*. New York, NY: McGraw-Hill.
- Ten States Standards. 2007. Recommended Standards for Water Works, 2007 Edition: Policies for the Review and Approval of Plans and Specifications for Public Water Supplies. Water Supply Committee of the Great Lakes - Upper Mississippi River Board of State and Provincial Public Health and Environmental Managers. Available online: <http://10statesstandards.com/waterstandards.html>
- USEPA. 2008a. Emerging Technologies for Wastewater Treatment and In-Plant Wet Weather Management. EPA 832-R-06-006. Available online: http://www.epa.gov/OW-OWM.html/mtb/emerging_technologies.pdf
- USEPA. 2008b. Municipal Nutrient Removal Technologies Reference Document., Volume 1 - Technical Report. Office of Wastewater Management, Municipal Support Division. EPA 832-R-08-006. Available online: <http://www.epa.gov/OWM/mtb/mnrt-volume1.pdf>
- Water Online. 2009. ITT Leopold Completes Tertiary Filtration Project for Wastewater Treatment Plant in Washington, D.C. Website accessed 9 April 2009. Available online: <http://www.wateronline.com/article.mvc/ITT-Leopold-Completes-Wastewater-Project-In-N-0001>
- WEF and ASCE. 1998. Design of Municipal Wastewater Treatment Plants - MOP 8, 4th Ed. Water Environment Federation and American Society of Civil Engineers. Alexandria, VA: WEF.
- WEF and ASCE. 2010. *Design of Municipal Wastewater Treatment Plants – WEF Manual of Practice 8 and ASCE Manuals and Reports on Engineering Practice No. 76, 5th Ed.* Water Environment Federation, Alexandria, VA, and American Society of Civil Engineers Environment & Water Resources Institute, Reston, Va.
- WEF. 2006. Membrane Systems for Wastewater Treatment. Alexandria, VA: WEFPress.
- WERF. 2008. WERF Nutrient Challenge, Chapter 1: Tertiary Phosphorus Removal. Accessed 11 March 2009. Available online: <http://www.werfnutrientchallenge.org/chapter1.asp?area=ch1>

12. Operation and Optimization to Enhance Biological Nutrient Removal

Chapter 12 covers:

- 12.1 Introduction
- 12.2 Analysis of Existing Operations
- 12.3 Incorporating SCADA and other Instrumentation
- 12.4 Common Operational Changes
- 12.5 References

12.1 Introduction

Depending on the existing plant configuration and operating conditions, it may be possible for plants to meet new performance goals by optimizing existing treatment processes, particularly if biological nutrient removal is already being practiced. It is often more cost effective to optimize operations than to add a new treatment process or to construct new reactor volumes.

Process simulation models can be extremely useful in optimizing the operation of an existing wastewater treatment plant (WWTP). Operators can adjust parameters and predict their impact without having to do extensive testing at the plant. Models can also help to identify bottlenecks at the plant.

This chapter provides general guidelines for evaluating an existing plant and changing plant operation to improve performance. While this chapter includes many examples of plant operational improvements, each plant is unique, and alternative approaches may work better for a given situation. Operators and designers should always apply the fundamental process information provided in Chapters 3 through 5 of this manual to address operational issues and improve performance.

12.2 Analysis of Existing Operations

Process optimization begins with an analysis of the performance of each treatment process at the existing plant. The purpose of this analysis is to answer questions such as:

- What are the factors that are limiting nutrient removal?
- Where are the hydraulic bottlenecks?
- Do parallel treatment units achieve different performance levels for nutrient removal? If so, why?
- What is causing variability in effluent quality with respect to nutrients?
- What are the causes of intermittent increases in nutrient concentrations in the plant effluent?

This section describes data analysis and modeling techniques that can be used to answer these questions and ultimately improve performance of the existing WWTP.

12.2.1 Data Analysis

The following 4-step procedure is one possible approach to collecting and analyzing plant data for the purposes of process optimization. Alternative approaches can be found in Chapter 15 of Tchobanoglous et al. (2003) and Chapter 12 of WEF and ASCE (2006). Note that all data analyses should be done in close coordination with plant operations staff. Plant personnel may have unique insight into the influence of operational changes on measured parameters, and vice versa, that could be extremely valuable for process optimization.

Note that all influent, primary effluent, secondary effluent, and plant effluent samples should be 24-hour composite samples. Grab samples will not usually provide the necessary accuracy, and results can be very misleading.

Step 1: Compile Existing Data

Obtain as much data as possible for the influent, primary effluent, secondary effluent, and plant effluent. See Table 12-1 for a list of recommended parameters for data analysis.

Step 2: Collect Additional Data

If the data are not sufficient to evaluate plant operations or if designers suspect that some data may not be accurate, consider collecting and analyzing additional samples to characterize plant performance. At least some form of special sampling is usually needed for process optimization. A successful sampling campaign requires careful planning and execution using proper techniques for sample collection, handling, and laboratory analysis. See Chapter 7, Section 7.4, for recommendations regarding measurement campaigns. Below are additional considerations for sampling for the purposes of process optimization.

- If operators suspect inconsistent performance among parallel treatment trains, each should be sampled separately. Alternatively, intense sampling can be done for many locations along one treatment train. Include flow measurements for each of the parallel trains. Consider performing a flow balance for the entire treatment system as a check (include comparison of influent and effluent flows).
- Consider interval sampling, particularly if plant personnel suspect that short-term variations in influent quality and/or intermittent discharge of recycle streams have a significant impact on the nutrient loading to the plant. Samplers can be programmed to segregate samples for specific time periods (WEF and ASCE 2006). A duration of 2 to 3 days is typically sufficient for interval sampling.
- Consider installing online monitoring equipment. If they are integrated into the process control system, online monitors can provide the added benefit of enabling real-time operational changes. See Section 12.3 for additional discussion of automated process control.

Table 12-1. Recommended Parameters for Data Evaluation

Parameter ¹	Location(s)	Rationale
Flow	Influent, effluent, flow splits, recycles	Essential for developing mass balances, which are essential for a complete understanding of the treatment system.
Total BOD/COD Soluble ¹ BOD/COD	Influent, primary effluent, effluent, anaerobic & anoxic zone effluents	Can be used to evaluate substrate availability for biological processes. High effluent BOD could indicate activated sludge performance problem.
TSS, VSS	Primary effluent, secondary effluent, final effluent	Important if phosphorus is removed chemically. Used to calculate ISS, determine clarification efficiency, and determine an accurate solids residence time (SRT) for the bacteria.
DO	Aerobic, anaerobic, and anoxic zones (multiple locations recommended)	Minimum DO of 2.0 is usually needed to minimize oxygen limitation of nitrification rates, which is important for low SRT/HRT systems. DO should not be present in anoxic or anaerobic zones.
pH	Influent, mixed liquors, effluent	Should be above 6.5 and below 9.0 for biological nitrogen removal. Low pH or wide swings in pH could mean significant industrial component. Could affect BPR and nitrification.
Alkalinity	Influent, primary effluent, mixed liquor supernatants, effluent	If effluent is below 50, there is probable nitrification inhibition, and process is susceptible to large pH drops as a result of nitrification or chemical addition for phosphorus removal.
Temperature	Influent, mixed liquors of reactors, effluent	Low temperatures can significantly reduce nitrification rate. For the typical range between 10 and 25 °C, the rate will drop by half for every 8 to 10 °C reduction in mixed liquor temperature. Reactor temperatures are likely to be significantly different from influent temperature because of aeration.
NH ₃ -N or TKN	Influent, primary effluent, reactor mixed liquors, secondary effluent, effluent	Can be used to evaluate load to and performance of biological nitrification kinetics.
Nitrate	Influent, reactor mixed liquors, secondary effluent, effluent	A check on nitrification, and can be used with TKN to calculate denitrification.
Total Phosphorus	Influent, primary & secondary WAS, plant effluent	Used to calculate phosphorus removal efficiency by treatment processes.
Phosphate	Reactor mixed liquors, primary & secondary effluents, effluent	Used to determine release and uptake in reactors, release in secondary clarifier, and phosphorus removal efficiency.
ORP	Anaerobic & anoxic reactor mixed liquors	Measures the balance between oxidized and reduced compounds present in solution. Will detect presence of significant concentrations of oxidized compounds. Can be used for automatic detection of excess electron acceptors (DO, nitrate, and nitrite) in reactors.
VFA or rbCOD	Influent, primary effluent	Can be used to evaluate substrate availability for enhanced biological phosphorus removal.
MLSS & MLVSS test and WAS test	MLSS & MLVSS: well-mixed location in aeration basin WAS: well-mixed and representative sample from the WAS pipe (may need composite sample)	MLSS and WAS tests provide suspended solids concentrations and can be used to determine percent phosphorus in sludge. This information, in conjunction with aeration basin volume and WAS flow, can be used to calculate SRT. Maintaining SRT is critical for nitrification and, sometimes, for enhanced biological phosphorus removal.

¹. BOD = biochemical oxygen demand (5-day unless otherwise noted)

COD = chemical oxygen demand

TSS = total suspended solids

DO = dissolved oxygen

TKN = total Kjeldahl Nitrogen

VFA = volatile fatty acids

MLSS = mixed liquor suspended solids

MLVSS = mixed liquor volatile suspended solids; Inorganic suspended solids (ISS) = MLSS - MLVSS

Total BOD/COD = unfiltered BOD/COD

Soluble BOD/COD = BOD/COD of filtrate from 0.45 µm pore size filter

VSS = volatile suspended solids

ORP = oxidation reduction potential

NH₃-N = ammonia Nitrogen

rbCOD = readily biodegradable COD

WAS = waste activated sludge

Source: WEF and ASCE (2006)

Step 3: Review and Summarize Data

Review data for anomalies and possible sampling errors. This step is also called data cleaning or data verification. See Section 7.4.2 of this design manual for recommended data checks. Mass balance diagrams are particularly helpful, and should be developed for all loading information and for inert fractions (ISS) through the plant. Additional samples may need to be taken as a result of these steps.

The evaluation of plant performance is facilitated by presenting data in carefully annotated tables, graphs, and figures. Below are possible approaches to organizing plant data for analysis:

- Summarize key parameters in tabular form.
- Consider annotating a process flow diagram with flow weighted averaged data (Frank et al. 2008).
- Plot sampling results for key parameters over time to assess temporal trends and at different locations to assess spatial trends.
- Consider using histograms to depict the proportion of measured values that fall in distinct categories.
- Consider plotting multiple parameters measured at a specific location together on the same plot to evaluate possible relationships.
- 3-dimensional graphs with measured data (e.g., ammonia), sampling location, and time are an informative way to display both spatial and temporal trends. See Figure 12-1 for an example using special sampling data from the Washington Suburban Sanitary Commission (Frank et al. 2008).

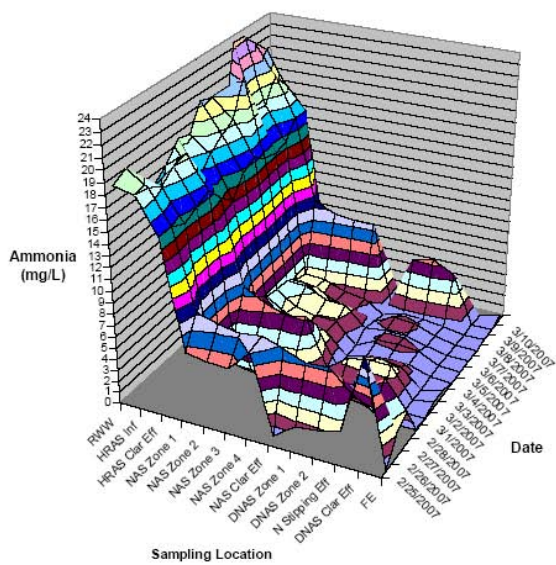

(a)

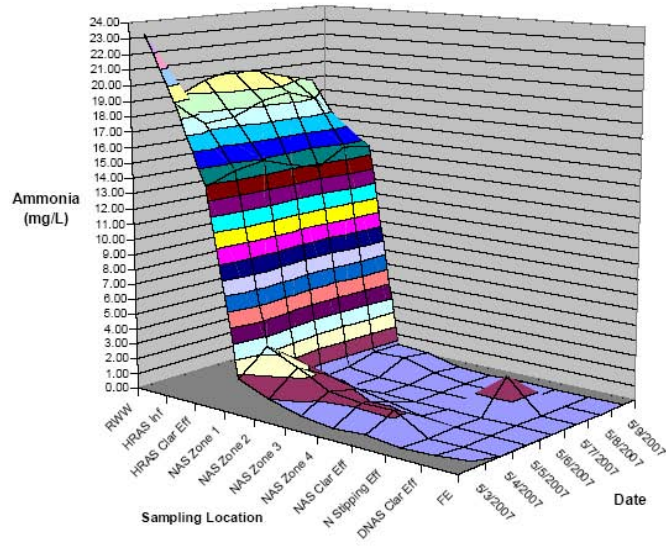

(b)

Figure 12-1. Spatial and temporal profiles of ammonia.

Source: Frank et al. (2008), Figure 6. Reprinted with permission from Proceedings of WEFTEC®.2008, the 81st Annual Water Environment Federation Technical Exhibition and Conference, Chicago, Illinois, October 18-22. Copyright ©2008 Water Environment Federation, Alexandria, VA., www.wef.org.

Step 4: Evaluate Relationships between Key Parameters

Statistical analyses can provide very useful information. Consider linear regression analysis to evaluate the relationship between water quality and operational parameters.

12.2.2 Use of Process Simulation Models

Process simulation models, particularly if they have been calibrated to dynamic operating conditions, can be extremely useful tools for process optimization. Designers can use models to simulate many different operating scenarios and analyze results to determine if nutrient removal efficiencies can be improved. For example, designers can simulate changes in aeration rates to gauge the effects on nitrification, or simulate increased wastage rate from the secondary clarifier to determine the effect on SRT. Dynamic modeling can also be used to check the plant's ability to treat peak loads. For example, dynamic modeling of the Beenyup plant in Western Australia showed that the nitrification process was limited by the capacity of the diffusers to meet the peak air demand (Third et al. 2006). In addition to dynamic simulations, steady state modeling can be useful in determining major process bottlenecks by comparing simulated operating conditions with original process design capacities. Steady state modeling can also be used to compare performance under different operating scenarios.

The usefulness of simulation models for process optimization relies heavily on proper model development and calibration. See Chapter 10 of this design manual for guidance on model development and calibration.

12.3 Incorporating SCADA and other Instrumentation

Compared to grab sampling, online monitoring can give real-time information on processes occurring within the treatment plant and is not susceptible to improper sampling, holding times, or inconsistencies in laboratory analysis. Chapter 13 describes the types of instruments and control systems for nutrient removal.

On the most basic level, online sensors can provide information to operators and assist them in making operational decisions. More advanced online monitoring applications feed the measured data into a controller. The controller can be programmed to automatically adjust a control parameter (e.g., diffuser setting) depending on the measured value. This set up is referred to as a “control loop” for automated process control.

Historically, the lack of reliable sensors has been the biggest barrier to implementing automated process control. Recent improvements in basic and advanced online sensors have made them more reliable and more commonly used (Jeppsson et al. 2002). Automated control has many advantages including reducing staff workload, allowing for more precise control of process parameters, and providing automatic data logging and archiving (Tchobanoglous et al. 2003).

In the past, proprietary distributed control systems were recommended for WWTPs (WEF and ASCE 2006). More and more facilities, however, are implementing comprehensive supervisory control and data acquisition (SCADA) systems. SCADA systems encompass process control; data acquisition; supervisory control; distributed alarming; historical collection, display, and analysis; information systems; and security. See Chapter 13, Section 13.8 for additional discussion of SCADA functionality.

12.4 Common Operational Changes

12.4.1 Adjust SRT

Nitrification is highly dependent on sufficient SRT in the aerobic basin. Denitrification can be limited by the anoxic SRT. Biological phosphorus removal can also wash out at low temperature-low SRT combinations. Higher SRTs are needed for colder temperatures and vice versa.

Capital improvements to increase SRT include constructing additional basin volume; installing a fixed film media in the basin, such as integrated-fixed film media (IFAS); or using membrane bioreactors (MBRR). Operational improvements can sometimes be implemented at a much lower cost. Operating changes that can be used to increase SRT include:

- Increase the MLSS/MLVSS concentration in the aeration basin. However, this is limited by the solids separation process.
- Incorporate swing zones to utilize the maximum available aeration volume or the maximum anoxic volume during peak loadings. This increases the aerobic or anoxic SRT.

12.4.2 Adjust Aeration Rates

Tapered aeration with lower DO levels at the end of the aeration basin can promote simultaneous nitrification-denitrification (SNdN). SNdN can also be increased by cycling the air on and off. It can be optimized by automating the DO level for the former case, or the on-off cycling times for the latter case, via automatic monitoring of ammonium and nitrate using probes and feedback to a control system. Tapered aeration also optimizes the utilization of DO and the need to transfer DO, resulting in the reduction of energy requirements. If anoxic reactions are increased, the amount of WAS produced also is reduced.

12.4.3 Add Baffles to Create High Food to Microorganism (F/M) Conditions

The performance of existing continuous flow, activated sludge BNR systems can generally be improved by using plug flow rather than complete-mix configurations, and the plug flow units can be improved by using baffles to divide the anaerobic, anoxic, and aerobic zones into two or more sections each. The use of multiple sections (2 or 3) in anaerobic zones is particularly beneficial because it increases the substrate concentrations surrounding the activated sludge microorganisms in the first section. This increases the rates of reaction within the section, which reduces the total volume needed for the zone. Additionally, the first section protects the remaining section(s) from influent nitrates and DO, which helps ensure the development of anaerobic conditions within the zone and provides a safety factor against nitrate and DO excursions. Similar statements can be made regarding the anoxic zone where the purpose of baffling is to provide protection from the recirculation of unusually high DO concentrations, thus ensuring that anoxic conditions are obtained within the zone in addition to obtaining higher rates of reaction in the first section.

There is less justification for the use of baffles in the aerobic zone because (1) the phosphorus removal rates of reaction are fast relative to the nitrification rates, (2) high DO concentrations increase both reactions, and (3) there are no other electron acceptors that interfere with the desired reactions. Note that soluble substrate is usually near effluent concentrations when the flow enters the aerobic zone if a full BNR system (i.e. with anaerobic, anoxic, and aerobic zones) is used. Baffling for a small aerobic effluent section could be used to reduce the DO concentrations recycled to the anoxic zone and entering the secondary clarifiers, the latter of which would reduce the DO recycled to the anaerobic zone in the return activated sludge (RAS). However, adequate reduction of DO in the aeration basin effluent can generally be accomplished by simply reducing the amount of air delivered to the last 5 percent of the aeration basin.

Baffles should always be designed to prevent backmixing. Because the water surface elevation in aerated zones are higher than those in non-aerated zones, backmixing of DO and nitrates can cause floating scum. Underflow baffles with tops that extend above the water surfaces are excellent protection against backmixing. A minimum forward flow of 1 foot per second is recommended through the underflow openings to prevent backmixing during low flow periods.

12.4.4 Change Aeration Settings in Plug Flow Basins

There are many instances where enterprising operators at conventional plants with plug flow aeration basins have achieved 80 percent or more phosphorus removal with less than 1 mg/L total

phosphorus (TP) in the plant effluent by turning off air or mixers. Switching off aeration at the inlet side of the basin system will create an initial anaerobic zone. As long as there is enough readily biodegradable chemical oxygen demand (rbCOD) in the plant influent, Phosphate Accumulating Organisms (PAOs) will grow and remove phosphorus. It is important to ensure that the processes still have sufficient SRT, particularly for nitrification in the aerated portions of the basin.

The Piney Water, CO, plant is a 5-stage Bardenpho plant with no primary sedimentation and few VFAs in the influent, which resulted in little phosphorus removal. By switching off a mixer in one of the anaerobic zones, sludge settled to the bottom and fermented, which supplied the VFAs for reducing the orthophosphate to less than 0.2 mg/L. A similar operation at the Henderson, NV, plant in a Johannesburg Process (JHB) had the same effect.

Some plug flow aeration plants succeeded in reducing phosphorus to below 1 mg/L by turning off aeration at the feed end of the plant, such as the Blue Lakes and Seneca plants operated by the Metropolitan Council Environmental Service in Minnesota and the St. Cloud, MN, plant.

12.4.5 Minimize Impact of Recycle Streams

Discharge of supernatant from sludge handling operations can have a significant impact on BNR processes, particularly for medium and small WWTPs that discharge recycled flows intermittently. For example, a WWTP treating approximately 4 MGD correlated increased effluent TP concentrations with discharge from sludge handling facilities. Plant operations staff tracked the problem to phosphorus release in sludge holding tanks. Improved aeration within the holding tanks prevented phosphorus release, reduced intermittent phosphorus loading, and subsequently allowed the plant to achieve more consistent effluent TP levels (Smith et al. 2008).

A second potential problem is increased ammonia load in return streams from sludge dewatering operations. In some plants, dewatering is operated during the day and supernatant from digested sludge is returned to the head of the plant in the afternoon. This coincides with a diurnal ammonia peak in residential systems and can overwhelm nitrification processes. WEF and ASCE (2006) report that a small tank can significantly reduce variation of influent ammonia load by storing recycle flow from the dewatering facility. The tank can be filled during peak hours and emptied during off-peak hours using a simple timer.

12.4.6 Reconfigure Flow through Existing Units

Some plants may find opportunities to reconfigure flow through existing basins to enhance BNR. For example, plant operators in the City of Xenia, OH, reconfigured their existing BNR system to include a swing zone that could be adjusted to respond to short-term variations in hydraulic and organic loading conditions (Smith et al. 2008). This modification allowed the plant to achieve enhanced biological phosphorus removal to effluent TP levels of 0.5 mg/L (annual average).

The West Hickman Creek Treatment Plant in Lexington, KY, reported successful conversion of existing primary clarifiers to anaerobic zones for biological phosphorus removal (Water and Wastewater Asia 2006). To convert the primary clarifiers, the plant operations staff installed fine screens at the influent and converted the anaerobic digesters to aerobic sludge holding tanks. They used respirometry techniques to assess the availability of VFAs, evaluated the hydraulics of the existing primary clarifiers, and determined that it was sufficient for biological phosphorus removal. The plant experienced

additional benefits of improved settling and clarification and reduced use of coagulant dose for chemical polishing.

12.4.7 Increase VFAs for Biological Phosphorus Removal

The amount of readily biodegradable organic material determines the amount of biological phosphorus removal that can be achieved at a given plant. As stated in Chapter 5, the minimum rbCOD/TP ratio for complete biological phosphorus removal is 10 to 16 (Barnard 2006). If this minimum is not being met, consider the following approaches:

- Check odor control practices. Odor control in the collection system can reduce anaerobic conditions, which can reduce the formation of VFAs in the system. Consider odor control practices that do not adversely affect VFA production such as iron addition and pH control between 9 and 10. See Chapter 5, Section 5.3.1 for more information.
- Consider fermenting the primary sludge by increasing the depth of the sludge blanket in the existing basin.

Although not a strictly operational improvement, addition of fermenters has been very successful for providing substrate for biological phosphorus removal, particularly in cold climates. For example, a complete mix tank can be installed ahead of the primary clarifier for fermentation of the VFAs. See Section 5.3.2 of this manual for a discussion of the principles of primary or RAS sludge fermentation. See Chapter 10 for additional design guidance.

12.5 References

- Barnard, J.L. 2006. Biological Nutrient Removal: Where We Have Been, Where We are Going? In *WEFTEC 2006*.
- Frank, K., G. Davies, N. Shirodkar, and A. Sauvageau. 2008. Full-Scale Performance Testing and Optimization of an Old-School Process with Limit of Technology Nutrient Removal Capabilities. In *WEFTEC 2008*.
- Jeppsson, U., J. Alex, M.N. Pons, H. Spanjers, and P.A. Vanrolleghem. 2002. Status and Future Trends of ICA in Wastewater Treatment – A European Perspective. *Water Science Technology*. 45(4-5): 485-494.
- Lopez, C., R. Wachter, C. Meyer, B. Narayanan, and C. Baer. 2008. Optimization of Biological Nutrient Removal Systems in Response to Increased Loadings. In *WEFTEC 2008*.
- Quast, D., P. LaMontagne, and R. Knuteson. 2008. Putting the Operator in Charge; Improving Human Machine Interface Leads to Significant Centrifuge Operation Savings. In *WEFTEC 2008*.
- Smith, R.C., J. Tincu, and S. Jeyanayagam. 2008. Maximizing EBPR: Going from a 'Black Box' to a 'Glass Box' Approach. In *WEFTEC 2008*.

- Swift, J., D. Bradshaw, L. Pierce, W. Robinson, P. Williamson, P. Jue, J. Damitio, D. Welce, and J. Dufresne. 2008. Full-Scale Evaluation of On-Line Ultraviolet Nitrate and Nitrite Monitoring Systems. In *WEFTEC 2008*.
- Tchobanoglous, G., F. L. Burton, and H.D. Stensel. 2003. *Wastewater Engineering: Treatment and Reuse*. New York, NY: McGraw-Hill.
- Third, K.A., A.R. Shaw, and L. Ng. 2006. Application of the Good Modelling Practice Unified Protocol to a Plant Wide Process Model for Beenyup WWTP Design Upgrade. London, UK: IWA Publishing.
- Wahlberg, E.J., B. Browne, N. Fulcher, Biju George, D. Linn, L. Scanlan, D. Siler, W. Anderson, M. Daniels, St. Rogowski, and S. Walker. 2008. Process Optimization Saves Money and Unlocks Capacity. In *WEFTEC 2008*.
- Water & Wastewater Asia. 2006. Biological Nutrient Removal: Online Sludge Level Monitoring Supports Efficient Nutrient Removal. *Water & Wastewater Asia*. January/February 2006. Available online: http://www.waterwastewaterasia.com/WWA_archive/JanFeb06/hach.pdf
- WEF and ASCE. 2006. *Biological Nutrient Removal (BNR) Operation in Wastewater Treatment Plants - MOP 29*. Water Environment Federation and the American Society of Civil Engineers. Alexandria, VA: WEFPress.

13. Instrumentation and Controls

Chapter 13 covers:

- 13.1 Introduction
- 13.2 Factors in Selecting Instrumentation
- 13.3 Basic Online Instrumentation
- 13.4 Online Instrumentation for Nutrient Control
- 13.5 Types of Control
- 13.6 Control Equipment—SCADA
- 13.7 References

13.1 Introduction

Nutrient removal at wastewater treatment plants (WWTPs) requires knowledge and careful control of many key variables. Variables such as dissolved oxygen (DO) concentration, nutrient concentrations, solids content, and flow rates are important to monitor throughout the process. Control of variables such as DO, solids residence time (SRT), hydraulic retention time (HRT), and return flows can be key to achieving low nutrient concentrations in the effluent. Using instrumentation to monitor these and other variables and automatically control certain operating parameters can lead to process optimization and more stable performance. Use of advanced instrumentation and automatic control is strongly recommended for plants targeting very low effluent total nitrogen (TN) levels and/or total phosphorus (TP) levels.

This chapter will begin with a discussion of factors to consider when selecting instrumentation and control strategies. It then provides a brief description of the types of on-line instrumentation available (basic and instrumentation developed specifically for controlling nutrient removal processes). Following is a general discussion of the various types of logic used in control processes and the types of equipment used.

The following technical references provide additional information on instrumentation for nutrient removal processes:

- Chapter 7, *Process Instrumentation* in the Water Environment Federation (WEF) Manual of Practice (MOP) 11, Operation of Municipal Wastewater Treatment Plants, 6th Edition (WEF 2007).
- Chapter 13, *Instrumentation and Automated Process Control* in the WEF MOP 29, Biological Nutrient Removal (BNR) Operation in Wastewater Treatment Plants (WEF and ASCE 2006).
- *Sensing and Control Systems: A Review of Municipal and Industrial Experiences*. (Hill et al. 2002).

- *Design of Municipal Wastewater Treatment Plants* – WEF MOP 8 and ASCE Manuals and Reports on Engineering Practice No. 76, 5th Ed. (WEF and ASCE 2010)
- The Instrumentation Test Association (ITA) offering test reports, studies, and workshop proceedings regarding online instrumentation and automation for water and wastewater treatment applications. Information is available online at <http://www.instrument.org>.
- The International Water Association (IWA) Task Group on Benchmarking of Control Strategies for WWTPs. Information available online at <http://www.benchmarkwwtp.org/>

It is important to note that technology often changes faster than books and large studies. Designers should check with professional associations such as their local WEF chapter, other utilities, and manufacturers for the latest information. Onsite testing of various brands of the different types of instruments under consideration can provide excellent data for analysis of the specific wastewater based on the most current instrument models.

13.2 Factors in Selecting Instrumentation

Several factors should be considered when selecting instrumentation for nutrient removal processes.

- **Online analyzers compared to offline sampling.** Grab samples may be adequate for parameters that change slowly and don't require tight control. However, much can be gained in process control by online equipment that can provide operators with real-time measurements, particularly for plants trying to achieve very low TN and/or TP effluent limits.
- **Accuracy and reliability.** Accuracy represents how close a measured value is to the true value, whereas reliability (or repeatability) is the measure of agreement among a number of measurements with the same input values and operating conditions. For the purposes of control, reliability and reproducibility are more important than accuracy. WEF and ASCE (2006) note that it is better to use a reliable, low-maintenance meter than a very accurate meter that requires significant maintenance. The exception is pH—accurate pH readings within +/- 0.1 unit are desirable.
- **Operations and maintenance requirements.** A key factor in selecting instrumentation is the amount of operator attention required to calibrate, clean, and maintain the equipment. If staff is not available to perform these duties, more durable and maintenance free instruments should be chosen. Automated cleaning and calibration are available for some instruments. The additional capital costs required for these features are often small compared to the reduced operator requirements and risks of failure.
- **Sample collection and pretreatment.** Proper design and maintenance of the sample pump, piping, and pretreatment (e.g., as required for analysis of nutrients) are key to obtaining reliable readings. WEF and ASCE (2006) note that these components often cost more than the instruments themselves and recommend that designers check the manufacturers' plant installation list to learn more about successful sample collection and pretreatment systems.

Note that some manufacturers avoid sample pumps and piping by offering probes which can be installed directly in the water.

It is important to use instruments specifically designed for wastewater—in the past, attempts were made to adapt equipment from the drinking water industry to wastewater. These attempts were largely unsuccessful due to the high solids and microbiological populations in wastewater.

13.3 Basic Online Instrumentation

Online instrumentation has been used for many years in wastewater applications. Many plants have online monitors for DO and total suspended solids (TSS) for basic process control. Some biological nutrient removal (BNR) plants also use online pH and oxidation reduction potential (ORP) meters. For the most part, the available instruments can take real-time measurements and provide high reliability. Table 13-1 summarizes the instruments used for basic measurements and lists advantages and disadvantages of each type.

Table 13-1. Summary of Basic On-Line Instrumentation

Analyte	Type of Measurement	Advantages	Disadvantages
Flow	Mechanical	Accurate	Wear down
	Pressure Drop	Low cost	Highly dependent on installation, pressure drop
	Magnetic	No moving parts, no wear	High cost, inaccurate at low flow
	Reflective Sonic	No pressure drop, low maintenance, low cost	Limited size of conduit, can't use aggregate lined pipe, inaccurate at low flow
	Parshall Flume	Simple, wide flow range	Pressure drop, requires cleaning, slow response
TSS	Light scattering (back scattered)	Better sensitivity, wider measuring range	Needs effective cleaning system
	Light Adsorption	Less sensitive, smaller range, inaccurate at low ranges	Able to handle fouling better without cleaning system
	Ultrasonic	Insensitive to color	Fouling, background reading required
	Microwave	Insensitive to interference	High cost, only works for high TSS
Sludge blanket monitor	Ultrasonic	Low maintenance	
	TSS or Turbidity	See TSS	
DO	Membrane electrode	Low cost	High maintenance
	Galvanic electrode	Durable, reliable	Interference from hydrogen sulfide, needs frequent calibration
	Optical probe	Durable, low maintenance, reliable	Higher initial cost
pH	Electrode		Fouling
ORP	Electrode	Indicates true oxidizing environment (anaerobic, anoxic, or aerobic)	Indirect measurement

13.3.1 Flow

Flow rate is an extremely important parameter for control at wastewater plants. Various types of flow meters are available. Mechanical flow meters depend on an impeller turning as the fluid passes

through the meter or by moving known volumes of fluid through a series of gears. Other flow meters measure the pressure drop as the fluid passes through a flow constriction. Magnetic meters measure the voltage generated by a magnetic field across the flow. Reflective sonic and transmissive sonic meters can also be used. Measuring the level in a Parshall flume is a method used for open channels.

Mechanical meters can be very accurate but need to be replaced more frequently due to the abrasive nature of wastewater. Magnetic meters will last longer as they have no moving parts and are unaffected by the nature of the wastewater. They are expensive, however, compared to mechanical meters and can perform poorly at low flow.

Differential pressure meters have a range of accuracy depending on how they were installed. Improper installation can result in very inaccurate readings. They also have a limited range, with the maximum and minimum flows needing to be within a factor of four of each other. Differential pressure meters also cause a head loss in the flow.

Reflective sonic instruments installed in open channels have good accuracy, low maintenance, and do not cause a pressure drop. They are limited in the size of the conduit. Reflective sonic instruments installed outside a closed pipe are less accurate than those installed in the pipe but still do not cause pressure drop and are a low cost and low maintenance option. They can also have problems measuring flow in clean fluids.

Many types of flumes are available for measuring flow in open channels; however Parshall flumes are by far the most common (WEF and ASCE 2009). Parshall flumes are very easy to use and come in prefabricated designs; they do, however, create head loss and have a slower response time compared to other types of flow measurement devices.

13.3.2 Total Suspended Solids (TSS)

TSS meters are based on optical scattering of light or on the difference in the velocity of ultrasonic waves. Microwave instruments can be used for very high TSS concentrations (> 10,000 mg/L). Light is emitted from a light source and then measured by a receptor at a given point. The two principle types use either forward scattered light or backscattered light. Some sensors will try to improve reliability by adding multiple beams and sensors. These multichannel instruments may also help provide color independent analysis, as it can be more difficult to get a reliable reading in a very concentrated dark sludge.¹ Ultrasonic meters require the measurement of a background velocity in a microbial-free sample.

TSS meters can become fouled in wastewater. Automatic cleaning systems are important for maintaining sensor reliability. Types of cleaning systems include water or air purging, wipers, or ultrasonic systems. Although some sensors may be able to maintain reliable functionality with only occasional manual cleaning, it is a good idea to have automatic systems installed to ensure regular and effective cleaning.

¹ Note, however, that most light scatter and light absorption methods utilize near-infrared light sources at 860 nanometers, which removes color issues since the light source is not a white light source.

13.3.3 Sludge Blanket Depth

Sludge blanket depth is an important parameter for optimizing settling within clarifiers. Controlling the sludge blanket depth can be used to prevent excessive denitrification in the blanket and the secondary release of phosphorus.

New sludge blanket monitors use sonic techniques to determine the position of the sludge blanket. These instruments work by sending an ultrasonic pulse from the instrument down to the sludge blanket and analyzing the time for the pulse to travel back to the instrument. Units typically are equipped with a cleaning mechanism to prevent buildup. Other units detect the height of the sludge blanket by multiple depth readings to determine the point of largest change in TSS or turbidity.

13.3.4 Dissolved Oxygen (DO)

DO is a key control parameter in achieving nutrient removal. It can be a good indicator of biological activity, especially nitrification. Having poor control of DO can lead to inadequate nitrification and phosphorus removal, disinfection problems, and high energy costs. It is estimated that tight control of DO can save a wastewater plant between 10 and 30 percent of operating costs (WEF and ASCE 2006).

DO can be measured by membrane electrodes, galvanic electrodes, and optical DO probes. Membrane electrodes allow diffusion of oxygen across a membrane and measure the oxygen gas at an electrode in the inner chamber. Galvanic electrodes such as the proprietary Zullig technology, use a galvanic current to measure the oxygen. Optical methods measure changes in light emitted by a luminescent chemical and relate the rate of change to the DO in solution.

Membrane electrodes are reliable and easy to use but must be calibrated frequently (typically once per week or per month depending on the manufacturer). They can also experience interference from chlorine, iron, and hydrogen sulfide. Galvanic electrodes are more expensive but tend to be more durable and reliable than membrane electrodes. Optical DO probes, the latest technology in DO measurement, do not consume oxygen or electrolytes and are very reliable.

13.3.5 pH

pH is an important variable in any biological treatment process. Online monitoring can help operators respond to changes in pH due to wastewater composition or chemical additions. It is also an important parameter for nitrification. The nitrification process produces acid and, if there is insufficient alkalinity present in the wastewater, will decrease the pH to a point that will inhibit the organisms responsible for nitrification. Online monitoring of pH can prompt the operator to add alkalinity when necessary. Also, the rate of nitrification varies with the pH, and maintaining an optimal pH (7-8) sometimes can be used to maintain near complete nitrification at low temperatures.

All pH meters are based on potential measurement using an electrode. The meter consists of two primary parts, a measurement electrode and a reference electrode. They can be configured as an electrode pair or a combination electrode in one single glass body assembly, with the latter being more common (WEF and ASCE 2006). Although interference from other ions in solution is not likely, sodium ions can have an affect (WEF 2007). Like most electrodes, pH meters can foul and will need to be calibrated and replaced more frequently than in water applications.

13.3.6 Oxidation-Reduction Potential (ORP)

ORP probes are electrodes that measure the oxidizing and reducing activity in a solution, i.e. which dominates and by how much. They can be used to detect changes in the oxidation state of the process water and to determine if aerobic, anaerobic, and anoxic zones are being correctly maintained. The readout of the sensor is in millivolts (mV), with positive readings indicating an oxidative state and negative readings indicating a reductive state (WEF and ASCE 2006) when the standard hydrogen electrode (SHE) is used as the reference. However, the standard calomel electrode is commonly used as the reference electrode for field measurements and it has a +241 mV reading when the SHE is zero. The calomel electrode is more robust than the SHE, and gives relatively stable readings. Operators need to ensure that the adjustment is made to the SHE when the calomel electrode is used.

The ORP of influent wastewater typically ranges from -50 mV to -400 mV (WEF 2007) because it is typically reduced when it reaches the wastewater treatment plant. Because ORP is a non-specific measurement, absolute values based on industry standards are not typically used for control. Instead, operators can evaluate ORP for sudden changes or gradual changes over time compared to other operating parameters.

As previously noted, ORP meters are similar to pH meters in that they consist of a measuring electrode and a reference electrode. The reference electrode is typically the same calomel electrode used in pH instruments (WEF and ASCE 2006). Depending on the manufacturer, ORP meters need to be cleaned often or equipped with automated cleaning (typically using air or water jets).

13.4 Online Instrumentation for Nutrient Control

Although it is more expensive and requires more attention than basic instrumentation, online instrumentation specifically for nutrient control can be very important in optimizing nitrogen and phosphorus removal processes. It can also lead to associated energy (and cost) savings via the use of automated control systems. The next several sections discuss techniques and instrumentation available for online monitoring for nutrient control

13.4.1 Nitrogen Compounds

Online monitoring of ammonia after the nitrification basin, in the effluent, and in return streams from anaerobic digestion may be very useful for process control and optimization. Measurement of nitrate and nitrite are important in determining 1) the load recycled to the anaerobic reactor of BPR processes, 2) the load to the denitrification process, 3) the load in the denitrification process effluent and 4) the control of external carbon addition for denitrification.

In general, manufacturers of online instruments for the various nitrogen species use one of three methods (Palmer et al. 2007):

- **Colorimetric approach.** Colorimetric meters typically withdraw a sample from the wastewater and give periodic readings and require the sample to be pretreated through a filter.
- **Ion sensitive electrodes (ISEs).** These are mounted directly in the water and can give real-time readings. This method is similar to Standard Methods 4500-NH₃-D (APHA et al. 2005)

- **UV absorbance or multiple wavelength UV absorbance spectrophotometers.** This method is based on Standard Methods nitrogen-persulfate digestion method 4500-N-B and nitrate, ultraviolet spectrophotometric method 4500 NO₃ - B (APHA et al. 2005).

Instruments based on colorimetry typically have an accuracy of 3 to 5 percent. ISEs are much faster and are similarly reliable—within 2 to 5 percent. ISEs require more maintenance than colorimetric methods because the electrode is placed directly in the wastewater stream. Electrodes can also experience interference and have a limited pH range in which they will function.

The most common measurement technique for nitrate and nitrite is UV absorbance. Online instruments direct UV light through the sample and measure the amount of light that is absorbed at a specific wavelength. Because suspended solids interfere with the measurement method, filtration or solids compensation is needed. The chemical oxygen demand (COD) of the water can also interfere with spectrometer readings. To account for these interferences, manufacturers have incorporated multi-wavelength measures or recommend membrane filtration (e.g., ultrafiltration) prior to sample analysis. ISE and colorimetric techniques can also be used to measure nitrate and nitrite; however, the UV absorbance method is most common (WEF and ASCE 2006).

Palmer et al. (2007) presents test data on commercially available in-situ UV absorption analyzers for nitrate. The authors evaluated accuracy in measurements by comparing them to lab values. They also collected information on capital costs, installation requirements, calibration requirements, and annual maintenance costs. Some key results of the study are summarized in Table 13-2.

Table 13-2. Comparison of On-Line Nitrate Analyzers¹

Manufacturer	Model	Mean Deviation from Laboratory Conformance Test	Correlation to Laboratory Conformance Test (R ²)	Number of Field-Test Maintenance and Calibration Events
Endress+Hauser	Stamo-Sens CNM750/CNS70	-0.08	0.92	None
HACH	Evita Insitu 5100 (Danfoss) ²	2.88	0.02	3
HACH	NITRATAX plus sc	0.68	0.97	1
s::can Messtechnik GmbH	82 N Nitrolyser sensor / 8580 Constat analyzer	0.26	0.91	3
Wedgewood Analytical/E+H	STIP-scan	0.55	0.61	3

1. Note that results based on test data from one facility
2. Hach Evita Insitu 5100 sensor is no longer on the market (discontinued in 2007)

Source: Palmer et al. 2007

13.4.2 Phosphate and Total Phosphorus

Monitoring phosphate (PO₄) and total phosphorus (TP) is important in establishing the phosphorus load on the plant, to control the phosphorus removal processes, and for compliance with

permits. Measurements may be taken in the influent, effluent, anaerobic zone, anoxic zone, aerobic zone, and return streams from digestion processes. Most online instruments measure PO_4 . Note that a reading of 3 milligrams per liter (mg/L) as PO_4 is roughly equivalent to 1 mg/L of phosphorus. Operators should consider reporting results as P rather than as PO_4 , i.e. as $\text{PO}_4\text{-P}$. to avoid confusion (WEF and ASCE 2006).

Phosphate monitors typically use colorimetric techniques, especially for measurement at low (0.1 mg/L or less) concentrations. The two most commonly used techniques are the Molybdenum blue technique and the molybdovanadate technique, also called the “yellow” method. The molybdenum blue technique generally has a range of 0.01 to 5 mg/L $\text{PO}_4\text{-P}$, while the yellow method has a range of 0.1 to 50 mg/L $\text{PO}_4\text{-P}$. Both monitors typically have accuracy and repeatability of approximately 2 percent of reading. The yellow method is more common due to the relative simplicity of the instrument and reagents, but the blue method is required for confirming very low orthophosphate concentrations in the plant effluent (WEF and ASCE 2006).

Total phosphorus instruments typically convert polyphosphate and organic phosphorus to phosphate and then measure phosphate using one of the above mentioned methods. Because the conversion steps require high temperatures and pressures, online total phosphorus monitors are very expensive and typically only used for effluent monitoring, if at all. Many plants measure orthophosphate in the effluent as a surrogate parameter. Accurate estimates of total phosphorus can be obtained by combining it with the effluent TSS measurements.

Neupane et al. (2009) reports very recent findings in a study of orthophosphate and nitrogen species analyzers as part of a pilot study of a Moving Bed Bioreactor (MBBR) at the Blue Plains Advanced WWTP in Washington, DC. The ChemScan analyzer (UV 6101) was used to measure orthophosphate at seven locations and compared to laboratory analysis of grab samples for a total of 6 months. The ChemScan uses UV absorbance for all parameters and reports a detection limit of 0.05 mg/L for orthophosphate. Neupane et al. (2009) noted that to maintain instrument accuracy, frequent cross checks with the lab and recalibration were required. Weekly checking and replenishing of reagents was also needed. However, authors report that the ChemScan OP readings were very accurate at concentrations between 0.5 and 1.0 mg/L. The ChemScan could not read orthophosphate accurately at the lower end of its calibration range.

13.4.3 NADH (active biomass)

A new technology developed in the Netherlands uses fluorescence to measure changes in intracellular nicotinamide adenine dinucleotide (NADH) of microorganisms, which can provide information on the status of biological wastewater treatment processes such as nitrification and denitrification. The NADH sensor requires minimal maintenance and can provide real time information for process control (Weerapperuma and de Silva 2004). NADH and DO monitoring can be used to achieve simultaneous nitrification and denitrification in the same basin.

13.4.4 Respirometry

Respirometry involves measurement of the oxygen uptake rate (OUR) by a biological treatment culture. In bench-scale respirometry experiments, a sample of mixed liquor, possibly amended with an organic substrate or ammonia, is placed in a sealed vessel. The rate of oxygen consumption within the

vessel is monitored over time. Alkalinity often needs to be added to nitrifying cultures to maintain a neutral pH.

Online respirometers can be set up in several modes for process control. They all require a biomass source representing the biomass in the reactor receiving influent wastewater. This can be biomass from the process itself, the return activated sludge line, or from an off-line pilot reactor (Love 2002). The biomass, substrate if added, liquid phase, and oxygen are contained in a flow through system or well mixed batch reactor. It is important that sufficient oxygen be present in the liquid or gas phase to prevent oxygen limiting conditions (Love 2000). Oxygen is measured during the experiments to determine oxygen uptake rates under normal operating conditions.

Online respirometry has several applications for activated sludge and nitrification treatment processes. It can be used instead of online DO measurements to determine and control aeration requirements and reduce electricity needs. One study in Chicago showed that this control is technically feasible using a feed forward control strategy (Tata et al. 2000). It can also be useful as an upset early warning device for the nitrification process. As explained in Chapter 4 of this manual, nitrifying bacteria are vulnerable to inhibition from a number of different compounds. As part of a WERF study of upset early warning devices, Love (2000) reviewed and documented several commercial devices that monitor for inhibition of nitrification activities based on ammonia consumption or ratio of ammonia to BOD.

13.5 Types of Control

Regardless of the community they serve and treatment configuration, all plants experience changes in external conditions, such as flow rate and constituent loading, and internal conditions, such as growth of certain types of organisms. Control systems for wastewater treatment attempt to respond to these changes by maintaining control parameters (e.g., DO) at target values by changing manipulated parameters (e.g., aeration rate).

In the past and still the case for many (especially smaller) utilities, plants were operated manually with operators collecting samples from various locations at the plant, bringing them back to the laboratory for analysis (which could take several hours), evaluating the results, and changing operating parameters to maintain desired control parameters. Automated systems essentially perform these same tasks using online analyzers, computers, actuators, and communications systems. Automated control can significantly reduce workload while at the same time improve control of process parameters and thus, improve treatment plant performance, often at reduced operating costs.

There are several different types of control systems. Selection of the most appropriate one depends on many factors including the specific control and manipulated parameters. The main types of control—feed-forward, feedback, cascade, and advanced—are discussed below.

13.5.1 Feed-forward

Feed-forward control adjusts a parameter based on a measured change in another variable. The parameter is adjusted in proportion to the measured variable. The value of the adjusted parameter can be represented by:

$$Q_a = K * Q_m \qquad \text{Eq. 13-1}$$

Where Q_a is the adjusted parameter, K is a constant, and Q_m is the measured parameter. Feed-forward control is commonly used when a parameter can be set based on flow rate. Examples include chemical addition processes and return activated sludge flow rates.

13.5.2 Feedback

Feedback control is based on adjusting a parameter to correct an undesirable situation. The adjusted parameter is changed in response to the measured parameter departing from a desired value or set point. Dissolved oxygen control in aerated zones is often feedback type.

There are several types of feedback control including On/Off, proportional, integral, proportional-integral, proportional-derivative, and proportional-integral-derivative. The control types vary in how the adjusted parameter is changed in response to the departure of the measured parameter from the setpoint.

On/Off control is the simplest type of feedback control. In it, a piece of machinery is turned on when the measured variable falls outside of a set range and turned off when the measured variable returns to that range. Examples include turning on air blowers when DO level in the aeration basin drops below a set level. Proportional control adjusts a parameter in proportion to the departure of the measured parameter from a setpoint. Integral control varies the adjusted parameter in proportion to the area under a plot of the difference from the offset over time. Proportional integral control is a combination of proportional and integral control. Proportional-derivative control adds a response that is proportional to the derivative of the difference between the measured value and the setpoint. The added derivative control makes the system much faster to respond, but also more likely to experience chatter as the controller searches for the correct value around the setpoint. This type of control is not as popular. Proportional integral-derivative control combines all three feedback control methods. While this type of control combines the benefits of all three types of control, it can be harder to tune the controller because of the larger number of variables.

13.5.3 Feed-forward and feedback

Feed-forward and feedback control combines the two control strategies. The controller initially responds to a disturbance from the set point using a feed-forward control strategy. The response is then fine-tuned using a feedback control. Again, while combining strengths of the two strategies, this type of control can be difficult to tune.

13.5.4 Cascade

In cascade control, one feedback controller sets the setpoint for a second controller. This configuration is used where two control loops may interact with each other. For example, control of air controllers and control of DO concentrations interact and can be a candidate for this type of control.

13.5.5 Advanced Control

Advanced control systems apply unique algorithms specific to a given treatment configuration through use of a computer or other programmable devices. They use input from many sensors and

mathematical models, equations, or condition matrices to manipulate equipment to obtain the desired outcome. Other straightforward control systems such as feed-forward or feedback are often part of an advanced system. Control can be based on mathematical models such as ASM1 (see Chapter 10 for additional information on the many uses of models for plant design, operation, and optimization).

13.6 Control Equipment—SCADA

Supervisory Control and Data Acquisition (SCADA) systems involve a central computer that is linked to various devices by means of a communications system. The central computer receives and sends information by means of the communications system, which can be through phone lines or radio waves. SCADA systems can be used for continuous process control, data acquisition, supervisory control, alarming, historical data collection, as an information database, and to provide security for stored information.

A SCADA system will constantly monitor and may be used to control the wastewater process. The central server can communicate with individual sensors and make control decisions based on process logic contained in the server. Communication with operator consoles occurs through either proprietary protocols, TCP/IP protocols, or through OPC protocols. Program logic should meet IEC 61131-3 standards.

The SCADA system will also monitor all sensors throughout the plant. The data are collected and can then be used for other functions such as control, display for operators, or historical storage.

Supervisory control is one of the essential features of a SCADA system. It allows operators to make changes to the automatic control of the plant by changing set points and starting and stopping machinery. The SCADA system will also allow the operator to monitor the various processes from a central point.

SCADA systems also perform the important function of notification of problems through a hierarchy of alarms. The SCADA system will record alarm conditions, prioritize alarms, notify operators through audible and visible alarms, and allow alarm acknowledgement. SCADA systems can also be set to notify off-site personnel through phone messages or text messages.

SCADA systems can archive all data collected such as process variables, alarm logs, and operating conditions. These data can be displayed at any time for troubleshooting and analysis of the plant. Data can be analyzed using functions on the SCADA computer and can also be used as inputs for wastewater models and other analytic tools. The SCADA system stores all information in a central database where it can be accessed by all plant personnel for various purposes including preparing reports, troubleshooting, and monitoring the plant.

Security is an essential component of a SCADA system. The security is set up to prevent unauthorized use and also to specify what function each authorized user can perform depending on that person's responsibilities.

13.7 References

- Akin, B.S. and A. Ugurlu. 2005. Monitoring and Control of Biological Nutrient Removal in a Sequencing Batch Reactor. *Process Biochemistry*. 40(8): 2873-2888.
- American Public Health Association (APHA), American Water Works Association (AWWA) & Water Environment Federation (WEF). 2005. *Standard Methods for the Examination of Water and Wastewater, 21st Edition*. Eds. A.D. Eaton, L.S. Clesceri, E.W. Rice, A.E. Greenberg, and M.H. Franson.
- Baeza, J.A., D. Gabriel, and J. Lafuente. 2004. Effect of Internal Recycle on the Nitrogen Removal Efficiency of an Anaerobic/Anoxic/Oxic (A2O) Wastewater Treatment Plant. *Process Biochemistry*. 39(11): 1615-1624.
- Baeza, J.A., E.C. Ferreira, and J. Lafuente. 2003. Knowledge Based Supervision and Control of Wastewater Treatment Plant Real Time Implementation. *Water Science and Technology*. 14(12): 129-137.
- Barnard, J. L., A. Shaw, J.B. Watts. 2003. Optimized Control of Nitrifying Suspended Growth Systems Using Respirometry. Proceedings of the Ozwater Convention and Exhibition, AWA 20th Convention, Perth, Australia. Sydney: Australian Water Association.
- Ekster, A. and I. Rodríguez-Roda. 2003. The Effect of Sludge Age on the Operation Cost of Activated Sludge System. Presented at WEFTEC 2003.
- Hill, R.D., R.C. Manross, E.V. Davidson, T.M. Palmer, M.C. Ross, S.G. Nutt. 2002. Sensing and Control Systems: A Review of Municipal and Industrial Experiences. WERF Report 99-WWF-4. WERF. Alexandria, VA.
- Isaacs, S., M. Henze, and M. Kummel. 1995. An Adaptive Algorithm for External Carbon Addition to an Alternating Activated Sludge Process for Nutrient Removal from Wastewater. *Chemical Engineering Science*. 50(4): 617-629.
- Kestel, S., G.J. Duffy, M. Gray, T. Stahl, and G. Lee. 2009. DO Control Based on On-line Ammonia Measurement. Presented at Nutrient Removal 2009. Washington, DC. WEF.
- Lara, J.M.V. and B.E.A. Milani. 2005. Control of Nitrate Flow in Pre-nitrification Systems Using Long Range Identification for Predictive Control. Decision and Control. 2005 European Conference.
- Love, N.G. 2000. A review and Needs Survey of Upset Early Warning Devices. WERF Report 99-WWF-2. WERF. Alexandria, VA
- Liu, W., G. Lee, and J. Goodley. 2003. Using On-Line Ammonia and Nitrate Instruments to Control Modified Ludzack-Ettinger (MLE) Process. Presented at WEFTEC 2003.
- Ma, Y., Y. Peng, and S. Wang. 2005. New Automatic Control Strategy for Sludge Recycling and Wastage for the Optimum Operation of Pre-denitrification Processes. *Journal of Chemical Technology and Biotechnology*. 81(1): 41-47.

- Manning, A. 2008. Automation, Instrumentation Generations 2, 3 and Beyond: Let's Get it Right This Time. Presented at WEFTEC 2008.
- Meyer, J. 2008. Fiesta Village Advanced Wastewater Treatment Plant: Manager's Perspective on Following Separate Stage Denitrification with Fixed Film Systems for Low Nitrogen. Presented at *WEF/WERF: Demonstrated Processes for Limit of Technology Nutrient Removal: Achievable Limits and Statistical Reliability*. October 18, 2008. Chicago, IL.
- Neupane, D., M. Peric, B. Stinson, M. Laquidara, S. Kharkar, N. Passarelli, S. Murthy, W. Bailey, R. DerMinassian, and M. Sultan. 2009. Comparative Study of On-line Instruments for Monitoring Low Nutrient Concentrations. Presented at Nutrient Removal 2009. Washington, DC. WEF.
- Palmer, T. 2007. On-Line Nitrogen Monitoring and Control Strategies. Report: 03-CTS-8. Alexandria, VA: WERF.
- Puznavan, N., S. Zeghel, and E. Reddet. 1998. Simple Control Strategies of Methanol Dosing for Post-denitrification. *Water Science and Technology*. 38(3): 291-297.
- Samueleson, P., Carlsson, B. 2001. *Control of Aeration Volume in an Activated Sludge for Nutrient Removal*. Proceedings of the first IWA Conference on Instrumentation, Control and Automation. Malmo, Sweden, June 3 – 7. pg. 429 - 437
- Tata, P., K. Patel, S. Soszynski, C. Lue-Hing, K. Carns, and D. Perkins. Potential for the Use of On-line Respirometry for the Control of Aeration. Presented at WEFTEC 2000.
- Tchobanoglous, G., F. L. Burton, and H.D. Stensel. 2003. *Wastewater Engineering: Treatment and Reuse*. New York, NY: McGraw-Hill.
- Weerapperuma, D. and V. de Silva. 2004. On-line Analyzer Applications for BNR Control. Presented at WEFTEC 2004.
- WEF, 2007. *Operation of Municipal Wastewater Treatment Plants – MOP 11, 6th Ed*. Water Environment Federation. Alexandria, VA. WEFPress.
- WEF and ASCE. 1998. *Design of Municipal Wastewater Treatment Plants - MOP 8, 4th Ed*. Water Environment Federation and American Society of Civil Engineers. Alexandria, VA: WEF.
- WEF and ASCE. 2006. *Biological Nutrient Removal (BNR) Operation in Wastewater Treatment Plants - MOP 29*. Water Environment Federation and the American Society of Civil Engineers. Alexandria, VA: WEFPress.
- WEF and ASCE. 200. *Design of Municipal Wastewater Treatment Plants – WEF Manual of Practice 8 and ASCE Manuals and Reports on Engineering Practice No. 76, 5th Ed*. Water Environment Federation, Alexandria, VA, and American Society of Civil Engineers Environment & Water Resources Institute, Reston, Va.
- Yuan, Z., H. Bogaert, P. Vanrolleghem, C. Thoeye, G. Vansteenkiste, and W. Verstaete. 1997. *Journal Environmental Engineering*. 123(11): 1080-1086.

Yuan, Z. and J. Keller. 2003. Integrated Control of Nitrate Recirculation and External Carbon Addition in a Predenitrification System. *Water Science and Technology*. 48(11-12): 345-354.

14. Sustainable Nutrient Recovery and Reuse

Chapter 14 covers:

- 14.1 Introduction
- 14.2 Separating and Treating Waste On-Site
- 14.3 Using Wastewater Treatment Byproducts
- 14.4 References

14.1 Introduction

Sustainable nutrient recovery and reuse is gaining national and international attention as wastewater utilities look for ways to decrease energy costs and greenhouse gas emissions, utilize excess capacity, generate new revenue, and address ever more stringent regulatory requirements. This evolution in thinking is moving wastewater treatment to enhanced energy efficiency and changing the role of wastewater treatment facilities from waste generators to resource providers.

In the United States and abroad, research on innovative sustainable nutrient recovery systems is changing the way liquid and solid waste is being treated and reused. This chapter will describe some of the on-site and centralized technologies and approaches currently being investigated and implemented.

14.2 Separating and Treating Waste On-Site

A number of European countries including Switzerland, Sweden, and the Netherlands are conducting research on innovative sustainable nutrient recovery systems. The concept behind these new technologies is to separate toilet waste before it leaves the home or building and mixes with the larger waste stream to be carried to wastewater treatment plants (WWTPs). Recent studies have shown that about 80 percent of the nitrogen and 50 percent of the phosphorus in wastewater are derived from urine, even though urine makes up only 1 percent of the volume of wastewater (Larsen and Leinert 2007). Separating the urine from wastewater could offer various advantages: WWTPs could be built on a smaller scale, water bodies would be better protected from nitrogen and phosphorus pollution, nutrients could be recycled for agricultural use, and various constituents of concern including hormones and pharmaceutical compounds found in urine could be removed without being mixed with wastewater and released to the environment. A major benefit would be reduced energy consumption at WWTPs as a result of reduced treatment requirements for nitrogen. Also, separating 50 to 60 percent of urine could reduce in-plant nitrogen gas discharges and result in fewer impurities in methane captured from sludge digestion.

Organizations such as the Swiss Federal Institute of Aquatic Science and Technology (EAWAG) are currently experimenting with the development and application of “NoMix technology” to separate urine from solid waste at the toilet bowl. While similar in size and shape to current toilets, this new technology has two waste pipes—a small front one that collects and diverts urine into a storage tank, and a larger rear waste pipe that operates like a standard toilet. The first of these toilets were installed in two “eco-villages” in Sweden in 1994 and since then have spread to other locations throughout the country and to Denmark, the Netherlands, and Switzerland. The concept is now taking hold in Austria

and Germany. While the urine, or “urevit,” can be spray-applied directly onto agricultural fields, a company called Grontmij in the Netherlands transports stored urine to a special treatment plant where the phosphate is precipitated out as struvite (magnesium-ammonium-phosphate) and used as a fertilizer.

EAWAG is also experimenting with a pilot decentralized basement sewage plant in which domestic wastewater is treated in a membrane bioreactor (MBR) so it can be reused for flushing the toilets or watering the garden and the sludge is composted. While still experimental, some of these technologies may have practical future applications if widely applicable low-cost solutions can be found for urine transport, or stable and cost-effective technologies can be developed for decentralized treatment. While studies of consumer attitudes and acceptance appear to be positive, technological improvements are still needed to prevent clogging in pipes, to identify best treatment options that can be applied in practice, and to identify how and where to convert urine to fertilizer.

14.3 Using Wastewater Treatment Byproducts

Sustainability concerns are also driving the wastewater treatment industry to look at liquids and sludge as renewable resources. Historically, agricultural use has been the traditional approach for disposal of municipal sludge due to its high nutrient content for fertilizing crops and its low cost. As scientific advances detect smaller and smaller quantities of chemicals, heavy metals, pathogenic microorganisms, pharmaceuticals, and personal care products, concerns are being raised about continuing this practice.

Researchers are exploring alternative approaches to treating and using the valuable products generated from sewage treatment byproducts such as energy extracted from anaerobic digestion, construction materials such as cement and bricks, and nutrients such as phosphorus that can be extracted from sludge and used as fertilizer. Liquids generated through the treatment process are also being harvested for nutrients for fertilizers and reused as non-potable sources of water for agriculture, landscape irrigation, and indirect potable reuse such as aquifer storage and recovery. It has also been demonstrated that struvite will form in anaerobic digesters treating biological phosphorus removal (BPR) sludges and will remain in the sludge rather than subsequently precipitate in the outflow pipes. The sludge can then be sterilized by further processing such as composting. Additionally, several processes have been developed for the precipitation of struvite from highly concentrated waste streams such as digester supernatants and dewatering filtrates. Several different processes have been proposed that rely on precipitation of the phosphorus as either struvite or calcium phosphate. Scope (2004) reported that at the time, work was underway in Italy, Germany, the Netherlands, and Canada.

In February 2008, the non-profit Global Water Research Coalition, an international water research alliance formed by 12 world-leading research organizations, released a report in collaboration with USEPA and the Water Environment Research Foundation (WERF) titled, *State of Science Report: Energy and Resource Recovery from Sludge* (Kalogo and Monteith 2008). The report focuses on:

- The international situation of energy and resource recovery from sludge.
- How the use of different sludge treatment processes affects the possibility of recovering energy and/or materials from the residual sludge.
- The influence of market and regulatory drivers on the fate of the sludge end-product.

- The feasibility of energy and resource recovery from sludge.
- The social, economic, and environmental performance (triple bottom line or TBL assessment) of current alternative technologies.

In the report, energy recovery technologies are classified into the following processes: sludge-to-biogas, sludge-to-syngas, sludge-to-oil, and sludge-to-liquid. The technologies available for resource recovery discussed in the report include those to recover phosphorus, building materials, nitrogen, and volatile acids. The report, which covers both established and emerging technologies, forms the basis of the coalition’s strategic research plan on energy and recovery from sludge. As a technical resource, it provides a valuable overview of sludge disposal practices in various countries such as the United States, the Netherlands, the United Kingdom, Germany, Sweden, Japan, and China, as well as a number of treatment processes for resource recovery.

Examples of these processes are described below.

14.3.1 Durham, OR, Advanced Wastewater Treatment Facility

Operated by Clean Water Services, the Durham Advanced Wastewater Treatment Facility in Tigard, OR, has incorporated a new technology from Ostara Nutrient Recovery Technologies, Inc. to extract phosphorus and other nutrients from wastewater and recycle them into an environmentally safe commercial fertilizer called Crystal Green®. Rather than reprocessing the sludge liquids back through the wastewater system, the Ostara proprietary fluidized bed reactor uses magnesium to recover ammonia and phosphate and turns them into a fertilizer pellet. By extracting these nutrients, the concrete-like scale of pure mineral called “struvite” (magnesium-ammonium-phosphate) no longer clogs the facility’s pipes, valves, and other equipment, thereby increasing plant capacity and reducing maintenance costs, while creating a revenue-generating by-product. Struvite is a very valuable slow-release fertilizer. Full-scale plant operation began in May, 2009. It is projected that more than 90 percent of the phosphorus in the return streams will be removed and more than 500 tons of struvite fertilizer will be produced annually and sold to commercial enterprises. Clean Water Services expects that the initial investment of \$2.5 million will be paid back within five years. For more information, see the Clean Water Services website at

<http://www.cleanwaterservices.org/AboutUs/WastewaterAndStormwater/Ostara.aspx>

In addition to phosphorus recovery, the Ostara process:

- Reduces pollution
- Reduces chemical use
- Removes about 20 percent of the nitrogen in the return streams
- Generates revenue from the sale of the fertilizer
- Increases the reliability and capacity of the wastewater facility
- Reduces operation and maintenance costs
- Reduces greenhouse gas emissions through reduced energy use
- Potentially generates carbon credits

The process does not have a significant impact on how wastewater is treated. Moreover, it does not require further chemical phosphorus precipitation from the return stream while it removes some of the ammonia that will otherwise need to be oxidized and denitrified in the main stream. This technology is particularly suited for WWTPs that employ biological phosphorus removal and anaerobic sludge digestion.

14.3.2 East Bay Municipal Utility District, CA

East Bay Municipal Utility District (EBMUD) has applied its biosolids to agricultural lands for decades, returning nutrients to the soil. Biosolids are rich in nutrients such as nitrogen and phosphorus, and the benefits of land application are well known. However, many agricultural communities are adopting more stringent land application standards because of concerns regarding pathogens. EBMUD has conducted research to develop economical alternatives for the production of Class A (“pathogen free”) biosolids, including thermophilic anaerobic digestion. EBMUD holds a patent for a thermophilic anaerobic digestion process. In 2005, EBMUD developed an environmental management system (EMS) to identify cost and environmental savings, ensure regulatory compliance, and increase public awareness and involvement in the biosolids program. As part of this program EBMUD undergoes third party audits. For results, see EBMUD’s website at <http://www.ebmud.com/our-water/wastewater-treatment/wastewater-treatment-programs/environmental-management-system>.

EBMUD also captures and reuses biogas from its anaerobic digesters. Methane from the biogas is used to fuel a 6 megawatt on-site power plant. To increase methane production, EBMUD implemented a trucked waste program whereby they accept liquid and solid waste streams from outside their service area and process it at the plant to increase methane production. Wallis et al. (2008) reported a doubling of energy production over the past six years. EBMUD plans to add two 4.5 megawatt turbines that will allow them to generate 100 percent of their energy needs onsite by the end of 2010. For more information on EBMUD’s sustainability programs, see <http://www.ebmud.com/environment/sustainability>.

14.4 References

- Kalogo, Y., and H. Monteith. 2008. State of Science Report: Energy and Resource Recovery from Sludge. Prepared for Global Water Research Coalition, by WERF, STOWA, and UK Water Industry Research Limited.
- Larsen, T.A., and J. Leinert, Eds. 2007. Novaquatis Final Report. NoMix – A New Approach to Urban Water Management. Switzerland: EAWAG, Novaquatis.
- SCOPE. 2004. Newsletter No. 57. July. Centre Européen d’Etudes sur les Polyphosphates. Brussels, Belgium. Available online: <http://www.ceep-phosphates.org/Files/Newsletter/Scope%20Newsletter%2057%20Struvite%20conference.pdf>
- Wallis, M., M. Ambrose, and C. Chan. 2008. Climate Change: Charting a Water Course in an Uncertain Future. *Journal AWWA* 100:6, June 2008.
- Water & Wastewater News*. 2008. Oregon Plant Recycles Nutrients into Fertilizer. L.K. Williams, Ed. October 2, 2008. Available online: <http://www.wwn-online.com/print.aspx?aid=68074>.

Appendix A.

Recommendations for Methanol Safety

Appendix A. Recommendations for Methanol Safety

Methanol (CH₃OH) is a relatively simple compound with a single carbon bond. Clear and colorless at room temperature, it is fully soluble in water and has a faintly sweet pungent odor. It is typically made from natural gas, although it can be generated using renewable materials such as wood.

As noted in Chapter 4, methanol is the most common external carbon source for denitrification because of its historically low cost and relatively low cell yield. The use of methanol, however, poses several safety and health risks:

- **Risk of Fire.** Methanol is highly flammable, with a flashpoint of 12 °C (54 °F). Even mixtures containing as little as 25 percent of methanol by weight are flammable. Because methanol is heavier than air, vapors can travel to a source of ignition and flash back. Vapors can also accumulate in confined spaces and may explode if ignited. Containers of methanol solution can rupture if exposed to fire or excessive heat for a long duration. Methanol burns with a clear blue flame. During daylight hours, methanol fires may not be visible to the naked eye. The U.S. Department of Transportation (DOT) ranks methanol and solutions of methanol with strengths of greater than 25% as Class 3 Flammable Liquids, meaning that they could ignite under almost all ambient conditions.
- **Health Risks:** Methanol is irritating to the eyes, skin, and respiratory track and is very harmful if swallowed or absorbed through the skin. Swallowing as little as 50 milliliters of methanol (1/4 of a cup) can be fatal. Inhalation is the most common form of exposure and can lead to respiratory problems. Methanol can also affect the nervous system and cause a loss of consciousness. Repeated exposures to low concentrations may accumulate in the body and cause illness. For additional information on the health effects of methanol, see information from EPA's Integrated Risk Information System (IRIS) at <http://www.epa.gov/iris/subst/0305.htm>.

This appendix contains recommendations for methanol handling. Literature reviewed for the appendix included a report by the U.S. Chemical Safety and Hazard Investigation Board on the Bethune Point Wastewater Treatment Plant accident, a Water Environment Federation (WEF) webcast entitled, *Methanol Safety: Understanding and Managing Risks*, and proceedings from *WEFTEC 2008*. When designing and operating a methanol feed system, plants should always follow guidelines in the manufacturer's **Material Safety Data Sheet** (MSDS). A good clearinghouse of information on methanol is provided online by the Methanol Institute, <http://www.methanol.org/>. Wastewater utilities should also always follow Occupational Safety & Health Administration (OSHA) regulations and National Fire Protection Association (NFPA) codes and standards.

A.1 Preventative Measures

It is imperative to keep open flames, sparks, and oxidants away from methanol. The best way to prevent fire is to eliminate the source of ignition. Operators and maintenance personnel should always use hand tools that do not spark.

Methanol storage and handling areas should be equipped with the following:

- Local exhaust
- Safety shower and eyewash station
- Smoke and/or heat detectors
- Fire suppression system (extinguishing materials including dry chemical powder, alcohol resistant foam, and water)
- Supply of absorbent, non-combustible materials in event of small spill
- Control measures to limit spread of spill or fire (i.e., secondary containment)

Wastewater utilities should consider monitoring for methanol vapors using detector tubes, electronic instruments, absorbent tubes, or biological monitoring (Dolan 2007).

Methanol is non-corrosive to most metals, the exceptions being lead, magnesium, and platinum. Mild steel is commonly used for methanol storage. Vapor controls include internal or external floating roofs, inert gas blanketing (such as dry nitrogen), and pressure vacuum relief to control tank pressures (Methanex 2006). Flame arresters can be attached to vent pipes to allow passage of methanol vapors but prevent flame from moving into the pipe by transferring heat to metal wires or plates. Flame arresters may become ineffective if they contain any blockages or corrosion.

When designing and constructing a new methanol feed system, consider involving local fire officials in the process. At the Stamford Water Pollution Control Authority (WPCA), the Fire Marshall was present at the start up of the methanol system and witnessed the initial foam fire suppression system test. The Fire Marshall's office periodically inspects the facility and alarm, sprinkler, and foam suppression systems (Brown 2007).

Operations manuals should specify regular inspections and maintenance of methanol handling equipment. Operators should undergo regular training on methanol handling and safety.

A.2 Addressing a Spill

The method for cleaning up a methanol spill depends on its size. For small spills (generally less than the contents of a 55 gallon drum), methanol can be absorbed with earth, sand, or other non-combustible material. Material should be stored in a sealed container and disposed of at a facility licensed to handle hazardous waste. A fine water spray or vapor suppressing foam can be used to reduce vapor. Personnel should wear protective gloves, fire retardant clothing (e.g., rubber), and safety goggles or other form of eye protection.

For larger spills, it is important to follow local emergency protocols and treat the spill as a hazardous situation. Wastewater utility personnel should eliminate ignition sources, secure the area up to a 500 meter radius, restrict access, move personnel upwind, and decontaminate personnel and equipment. All personnel allowed entry should wear a full chemical suit, compressed air breathing apparatus (CABA), rubber boots, and gloves. Although methanol biodegrades quickly in soil and water, measures should be taken to prevent methanol from entering waterways, sewers, basements, or confined areas.

In the event of a fire, utility personnel should follow written emergency response procedures and should immediately notify local authorities including the fire department and Emergency

Management Services (EMS) personnel. Powder extinguisher, alcohol-resistant foam, carbon dioxide, and large amounts of water can be used to suppress the fire in the event of an emergency. Water can be less effective than other methods; however, it may be useful in diluting methanol to a non-flammable level. Avoid using straight streams of water to prevent spread of contamination. Drums should be kept cool by spraying them with water to prevent explosion.

A.3 References

Brown, J.A. 2007. Methanol Storage and Delivery System. WERF External Carbon Workshop. Stamford WPCA. December 12, 2007. Washington, DC.

deBarbadillo, C., J. Barnard, S. Tarallo, and M. Steichen. 2008a. Got Carbon? : Widespread Biological Nutrient Removal is Increasing the Demand for Supplemental Sources. *Water Environment & Technology*. Alexandria, VA: WEF. 20(1): 48-53.

deBarbadillo, C., P. Miller, S. Ledwell. 2008b. A Comparison of Operating Issues and Dosing Requirements for Alternative Carbon Sources in Denitrification Filters. In *Proceedings of WEFTEC 2008*. Alexandria, VA: WEF.

Dolan, G. 2007. Methanol Safe Handling. WERF Carbon Sources Seminar. Methanol Institute. December 12, 2007. Washington, DC.

EDIE. Methanol Storage and Dosing for Denitrification. Gee& Company Product Information. Environmental Data Interactive Exchange. Surrey, England: Faversham House Group. Accessed July 24, 2008. Available online: http://www.edie.net/products/view_entry.asp?id=2401

IPCS. 2004. Methanol Data Sheet: 0057. International Programme on Chemical Safety. Available online: http://www.ilo.org/public/english/protection/safework/cis/products/icsc/dtasht/_icsc00/icsc0057.htm

Methanex Corporation. 2006. Technical Information & Safe Handling Guide for Methanol, Version 3.0. Vancouver, British Columbia, Canada: Methanex.

Methanex Corporation. Methanol Safe Handling and Storage, Distributed Generation Code Workshop. Vancouver, British Columbia, Canada: Methanex.

Methanol Institute. Methanol Emergency Response Factsheet. Arlington, VA: Methanol Institute.

Methanol Institute. Methanol Health Effects Factsheet. Arlington, VA: Methanol Institute.

Methanol Institute. 2005. Methanol and Wastewater Denitrification. Arlington, VA: Methanol Institute.

Methanol Institute. Wastewater Treatment with Methanol Denitrification. Arlington, VA: Methanol Institute.

NPI. 2007. Methanol: Rank 24 of 90 Substances. Australian Government. Department of the Environment and Water Resources. National Pollutant Inventory. Last updated October 26, 2007. Available online: <http://www.npi.gov.au/database/substance-info/profiles/54.html>

Onnis-Hayden, A. and A.Z. Gu. 2008. Comparisons of Organic Sources for Denitrification: Biodegradability, Denitrification Rates, Kinetic Constants and Practical Implication for Their Applications in WWTPs. In Proceedings of *WEFTEC 2008*. Alexandria, VA: WEF.

Terra Nitrogen Corporation. 2001. Material Safety Data Sheet: Methanol. MSDS Number 2016. Sioux City, Iowa: Terra.

U.S. Chemical Safety and Hazard Investigation Board. 2003. Public Board Meeting. March 6, Houston, Texas.

U.S. Chemical Safety and Hazard Investigation Board. 2007. Investigation Report: Methanol Tank Explosion and Fire, Bethune Point Wastewater Treatment Plant, City of Daytona Beach, FL, January 11, 2006. Report 2006-03-I-FL.

WEF. 2008. Methanol Safety: Understanding and Managing Risks. Webcast organized by the WEF Safety, Security, and Occupational Health Committee (SSoHC) with the WEF Municipal Wastewater Design Committee, the Methanol Institute, and the Chemical Safety Board. 23 July 2008.

This page left intentionally blank

Appendix B.

Organic Compounds and Inhibitory Concentrations to Nitrification

Appendix B. Organic Compounds and Inhibitory Concentrations to Nitrification

Organic Compound	Inhibitory Concentration (mg/L)
Acetone	2 000
Allyl alcohol	19.5
Allyl chloride	180
Allyl isothiocyanate	1.9
Allyl thiourea	1.2
AM (2-amino-4-chloro-6-methylprimidine)	50
Amino acids	1-1 000
Aminoethanol	12.2
Aminoguanidine	74.0
2-Aminophenol	0.27
4-Aminophinol	0.07
Aminopropiophenone	43
Aminotriazole	70.0
Ammonium	1 000
Aniline	7.7
1-Arginine	1.7
Benzene	13.00
Benzidine dihydrochloride	50.0
Benzocaine	100
Benzothiazole disulphide	38.0
Benzylamine	100
Benzyltrimethylammonium chloride	2.0
Benzylthiuronium chloride	40.0
2,2' Bipyridine	10.0
Bisphenol A	100
Bromodichloropropane	84.0
2-Bromophenol	0.35
4-Bromophenol	0.83
<i>n</i> -Butanol	8 200
Cadmium	14.3
Carbamate	2

Organic Compound	Inhibitory Concentration (mg/L)
Carbon disulphide	35.0
Chlorine	1
Chlorobenzene	0.71, 500
Chloroform	18.0
2-Chloronaphthol	14.3
2-Chlorophenol	2.70
3-Chlorophenol	0.20
4-Chlorophenol	0.73
5-Chloro 1-pentyne	0.59
2-Chloro-6-trichloromethyl-pyridine	11.0
<i>m</i> -Cresol	01.-100
<i>o</i> -Cresol	11.4
<i>p</i> -Cresol	12.8
Cyanide	16.5
Cyclohexylamine	0.500
Di-allyl ether	100
1,2-Dibromoethane	50.0
Dibromethane	60
1,2-Dichlorobenzene	100
1,1-Dichloroethane	0.91
2,4-Dichloroethane	0.79
1,5-Dichloropentane	13.00
2,3-Dichlorophenol	0.42
2,3-Dichlorophenol	0.61
2,6-Dichlorophenol	8.10
3,5-Dichlorophenol	3.00
1,3-Dichloropropene	0.67
1,3-Dichloropropene	0.48
Dicyandiamide	250
Dicyclohexylcarbodiimide	10.0
Diethyl dithiothiosemicarbazide	0.1
Diguanide	50.0
Dimethylgloxime	140

Organic Compound	Inhibitory Concentration (mg/L)
Dimethylhydrazine	19.2
Dimethyl <i>p</i> -nitrosoaniline	19.0
Dimethyl <i>p</i> -nitrosoaniline	30
2,4-Dinitrophenol	37.0
Diphenylthiocarbazon	7.5
Dithio-oxamide	1
Dodecylamine	<1
Erythromycin	50.0
Ethanol	2 400
Ethanolamine	100
Ethyl acetate	18
Ethylenediamine	100
Ethyl urethane	1 000
Ethyl xanthate	10
Flavonoids	0.01
Guanidine	4.7
Hexamethylene diamine	85
Histidine	5
Hydrazine	58.0
Hydrazine sulphate	200
Hydrogen sulfide	50
8-Hydroxyquiniline mercaptobenzothiazole	1
Lauryl benzenesulphonate	118
1-Lysine	4.0
Mercaptobenzothiazole	3
Methanol	160
Methionine	9.0
<i>n</i> -Methylaniline	<1
Methylhydrazine	12.3
Methyl isothiocyanate	0.800
Methyl mercaptan	300
Methyl pyridines	100
2-Methylpyridine	100

Organic Compound	Inhibitory Concentration (mg/L)
4-Methylpyridine	100
Methylthiourea	0.455
Methyl thiuronium sulphate	1
Methylamine hydrochloride	100
Methylene blue	30
Monethanolamine	>200
N-serve	10
Napthylethylenediamine dihydrochloride	23
Ninhydrin	10.0
<i>p</i> -Nitroaniline	10.0
<i>p</i> -Nitrobenzaldehyde	50.0
Nitrobenzene	50.0
4-Nitrophenol	2.60
2-Nitrophenol	11.00
2-Nitrophenol	50.0
Nitrourea	1.0
Panθοthenic acid	50
Pentachloroethane	7.90
Perchloroethylene phenol	5.6
Phenolics (substituted)	100
Phenolic acids	0.01
<i>p</i> -Phenylazoaniline	100
Potassium chromate	800
Potassium chlorate	2 500
Potassium dichromate	6.0
Potassium thiocyanate	300
<i>n</i> -Propanol	20.0
Purines	50
Pyridine	10.0
Primidines	50
Pyruvate	400
Resurcinol	7.80
Skatole	7.0

Organic Compound	Inhibitory Concentration (mg/L)
Sodium azide	23.0
Sodium azide	20
Sodium arsenite	2 000
Sodium chloride	35 000
Sodium cyanate	100
Sodium cyanide	1
Sodium dimethyl dithiocarbamate	13.6
Sodium methyl dithiocarbamate	0.90
Sodium pluoride	1 218
Sodium methyldithiocarbamate	1
ST (sulfathiazole)	50
Strychnine	100
Sulphides	5.0
Tannin	0.01
Tetrabromobisphenol	100
1,2,3,4-Tetrachlorobenzene	20.00
1,2,4,5-Tetrachlorobenzene	9.80
1,1,1,2-Tetrachloroethane	8.70
1,1,2,2-Tetrachloroethene	1.40
1,2,3,5,6-Tetrachlorophenol	1.30
Tetramethylammonium chloride	2 200
Tetramethyl thiuram disulfide	5
Thiamine	0.530
Thioacetamide	500
Thiocyanates	0.180
Thiosemicarbazide (Aminothiurea)	0.760
Thiourea	1
Thiourea (substituted)	3.6
1 -Threonine	5
Threonine	50.0
2,4,6-Tribromophenol	7.70
2,4,6-Tribromophenol	50
2,4,6-Tribromophenol	2.5

Organic Compound	Inhibitory Concentration (mg/L)
2,2,2-Trichloroethanol	2.00
1,1,2-Trichloroethane	1.90
Trichloroethylene	0.81
Trichlorophenol	100
2,3,5-Trichlorophenol	3.90
2,3,6-Trichlorophenol	0.42
2,4,6-Trichlorophenol	7.90
Triethylamine	100
Trimethylamine	118
2,4,6-Trimethylphenol	30.0
1-Valine	1.8
Vitamins riboflavin, A-lipolic acid, B-pyridoxine HCL	50

Source: Reprinted with permission from *Biological Nutrient Removal Operation in Wastewater Treatment Plants*, Copyright © 2005, Water Environment Federation Alexandria, VA, www.wef.org. From Blum and Speece, 1991; Christensen and Harremoës, 1977; Hockenbury and Grady, 1977; Painter, 1970; Payne, 1973; Richardson, 1985; Sharma and Ahlert, 1977.

This page left intentionally blank

Appendix C.

Mathematical Models for Wastewater Treatment

Appendix C. Mathematical Models for Wastewater Treatment

Models are sets of equations which describe a physical system. Wastewater modeling has advanced from a rudimentary understanding of the activated sludge process to complex systems of equations representing all the processes occurring in a wastewater plant. Figure C-1 shows a brief outline of the development of modeling of activated sludge processes. Activated sludge modeling first began to find widespread use in the wastewater industry after the International Water Association (IWA) produced the first Activated Sludge Model (ASM1) in 1986. Since then many enhancements have been added to ASM1 resulting in several improved versions of the basic ASM models. Several other models have also been developed to address specific processes within the activated sludge process as well as models for fixed film processes and settling. Powerful simulation packages have also been developed, capable of linking several models representing each process in the plant from primary settling through the activated sludge process to secondary clarification and sludge digestion.

Activated Sludge Modeling Timeline

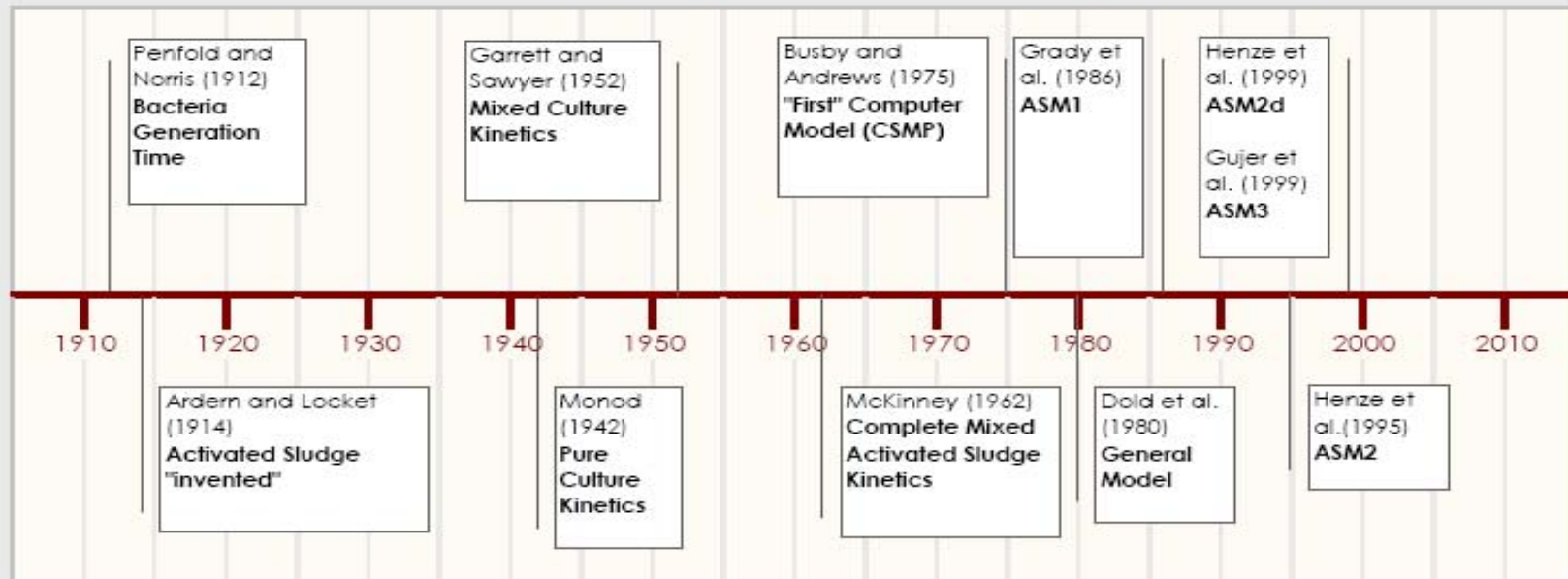

Empirical Design
Piloting & Guesswork

Kinetics-Based
Design

Whole-Plant
Simulators

Figure C-1 The Development of Activated Sludge Models.

Source: Johnson, 2009, slide 6. Reprinted with permission from the Distance Learning Webcast Series, February 25, 2009, Copyright © 2009, Water Environment Federation, Alexandria, VA, www.wef.org.

Models can be either black box models or white box models. Black box models fit a set of experimental data to an empirical equation. White box models are based on actual knowledge of the processes and their description in mathematical terms. Although some work has been done using black box models in wastewater, most commonly used models for design are white box models. This appendix will focus on those white box models commonly used for design of wastewater nutrient removal.

There are many excellent references on mathematical modeling of wastewater treatment plants. Gerbaey et al., (2004) provide a concise summary of existing models and their underlying assumptions. Comeau and Takács (2008) propose schematic representations for the mathematical models and a standardized list of symbols to further understanding of the models' mechanisms, use, and limitations. Additional information on fixed film mathematical models can be found in Wanner et al., (2006). References for individual models can be found in tables C-1 and C-2.

C.1 Description of Available Models

Settling

Models available for settling are well known and are generally based on mathematical concepts. Most simulators use similar one-dimensional (1D) settling models for primary and secondary clarifiers. The models may differ slightly in terms of the number of layers used to model the clarifier and the methods for determining the settling velocities of particles. These models do not generally take into account any biological reactions occurring in the clarifier or compression of the sludge blanket. Recently, some models have integrated an activated sludge model to account for reactions taking place in the clarifier.

One dimensional clarifier models typically are based on mass flux theory which calculates settling in one dimension based on the sludge characteristics. One dimensional models cannot take into account density currents and other non-vertical flows in a clarifier and thus represent an idealized condition. In order to more properly represent actual clarifier performance 2 and 3 dimensional models are necessary. These models have been constructed using computational fluid dynamics (CFD). CFD is a mathematical modeling method which uses numerical techniques to solve the mass and energy conservation equations in two and three dimensions. These models, while more complicated, can model the currents caused by density differences and also flow currents due to baffling and other structural features. A literature review of CFD techniques and studies can be found in Brouckaert and Buckley (1998).

Activated Sludge

The most significant decision is in the selection of a model to describe the activated sludge system. Activated sludge modeling first gained wide acceptance when the International Water Association (IWA) released the activated sludge model, later known as ASM1. Although very sophisticated, there are numerous simplifying assumptions underlying ASM1. These include constant temperature and pH and no dependence of the biological reaction rates on food source. The model also did not include phosphorus removal. ASM2 and ASM2d were developed to capture biological phosphorus removal. ASM3 followed and includes a wider temperature range and allows for the effects of different food sources. Additional equations can be added to ASM3 to account for biological phosphorus removal. The metabolic biological phosphorus model of the Delft University of Technology

(TUDP) was developed to fully account for the metabolism occurring in phosphorus accumulating organisms (PAOs) during enhanced biological phosphorus removal. Barker and Dold (1997) developed a model to include different rates of growth depending on the carbon source. The UCTPHO+ model is able to model uptake of phosphorus under both anoxic and anaerobic conditions. Table C-1 lists the activated sludge models available for various suspended growth biological treatment processes.

Table C-1. Available Activated Sludge Models for Suspended Growth Processes

Model Name	Wastewater Treatment Unit Processes	Reference
ASM1	Carbon oxidation, nitrification, de-nitrification	Henze et al. 1987
ASM2	Carbon oxidation, nitrification, de-nitrification, enhanced biological phosphorus removal, fermentation, chemical phosphorus removal	Henze et al. 1995
ASM2d	Carbon oxidation, nitrification, de-nitrification, enhanced biological phosphorus removal, fermentation, chemical phosphorus removal	Henze et al. 2000
ASM3	Carbon oxidation, nitrification, de-nitrification	Gujer et al. 1999
ASM3 w/ BioP	Carbon oxidation, nitrification, de-nitrification, enhanced biological phosphorus removal	Reiger et al. 2001
TUDP	Carbon oxidation, nitrification, de-nitrification, enhanced biological phosphorus removal, fermentation	Brdjanovic et al. 2000
B&D	Carbon oxidation, nitrification, de-nitrification, enhanced biological phosphorus removal, fermentation	Barker and Dold 1997
UCTPHO+	Carbon oxidation, nitrification, denitrification, biological phosphorus removal	Hu et al. 2007

Sources: WERF 2003, Gernaey et al. 2004, Comeau et al. 2008

Some reaction rates predicted by the ASM family of models for the liquid phase may be valid for biofilm reactions as well, but the transfer of material to and from the biofilm for reaction cannot be handled. Therefore, attached or fixed-growth processes require a different mathematical model to represent transport of substrate to the biofilm, consumption of the substrate in the biofilm, and then transport of the products out of the biofilm.

There are numerous mathematical models capable of modeling attached growth processes. Unfortunately they are not as standardized as the activated sludge models and there are a considerable number of them. As with activated sludge models, a model fully describing all aspects of the biofilm process would be exceedingly complex and would require large amounts of computing power to solve. Therefore numerous simplifying assumptions are made.

Biofilm models can be categorized as analytical, pseudo-analytical, 1-dimensional, and multidimensional. In analytical models, enough assumptions are made that the equations can be solved analytically. Pseudo-analytical models make a few less simplifying assumptions but require simple numerical procedures to find a solution. One-dimensional models make less assumptions but must be solved numerically, although they can still be solved using a desktop computer. Two and 3-dimensional models are very complex and although they have fewer assumptions they require significantly more computing time. These multi-dimensional models have not found wide use in industry and are not included in any widely available simulators. They will not be discussed further. Table C.2 lists some references available describing pseudo-analytical and 1-dimensional models.

Table C-2. References for Biofilm Models

Model Type	References
Psuedo-Analytical	Rittmann and McCarty 2001, Grady et al. 1999, Saez and Rittmann 1992
1-Dimensional	Kissel et al. 1984, Wanner and Gujer 1986, Reichert 1998

In addition, work is continually being done to develop models for new and innovative processes. For example, investigators have adapted biofilm models to simulate the Annamox process (Capuno et al. 2008; Dapena Mora et al. 2004). Models have also been developed to describe other emerging processes such as SHARON (Volcke et al. 2006; Wett and Rauch 2003; Borger et al. 2008), DEMON and STRASS (Wett et al. 2008). These models for new processes can be linked with the existing models for activated sludge plants using simulators to model newer flow diagrams.

C.2 Comparison of Mathematical Models

Suspended Growth Activated Sludge Models

As summarized in Table C-1, there are a number of models available to represent activated sludge processes. The list in C-1 is not exhaustive, but only represents the major models in use today. Each model has its own set of state variables. A state variable is a parameter used to describe the condition of the system. In the case of activated sludge models they are the species that make up the system such as particulate organic carbon and heterotrophic biomass. Each model is also represented by a set of reactions which describe the transformations undergone by the state variables. Table C-3 summarizes the number of state variables and reactions each of the major models use.

Table C-3. State Variables and Reactions for Activated Sludge Models

Model	Number of State Variables	Number of Reactions
ASM1	13	8
ASM2	19	19
ASM2d	19	21
ASM3	12	12
ASM3w/BioP	16	23
TUDP	14	21
Barker and Dold	19	36
UCTPHO+	16	35

Source(s): Comeau and Takács (2008), Gernaey et al, (2004)

While a complete list of all the state variables and reactions is beyond the scope of this appendix, Table C-4 gives an example of the state variables used for the ASM3w/BioP model.

Table C-4 State Variables for the ASM3w/BioP Model

State Variable	Description	Units
S_s	Readily biodegradable organic matter	mg COD/L
S_i	Soluble unbiodegradable organic matter	mg COD/L
S_o	Dissolved oxygen	mg O ₂ /L
X_s	Slowly biodegradable organic matter	mg COD/L
X_{STO}	General storage compound	mg COD/L
X_{PHA}	Stored PHA	mg COD/L
X_i	Particulate unbiodegradable organic matter	mg COD/L
S_{NH}	Total ammonia	mg N/L
S_{NO}	Total nitrate and nitrite	mg N/L
S_{N2}	Nitrogen gas	mg N/L
S_{PO4}	Inorganic soluble phosphorus	mg P/L
X_{PP}	Stored polyphosphate	mg P/L
X_H	Ordinary heterotrophic organisms	mg COD/L
X_A	Nitrifying organisms	mg COD/L
X_{PAO}	Phosphorus accumulating organisms	mg COD/L
S_{HCO}	Soluble inorganic carbon	mmol C/L
X_{TSS}	Total suspended solids	mg TSS/L

Source: Comeau and Takács (2008)

The reactions of each model represent the transformation of the state variables. Comeau and Takács (2008) have developed a schematic representation of these reactions. Figure C-2 shows such a schematic representation of the ASM3wBio/P model. Each line with an arrow represents a reaction in the model. Each reaction is represented by constants which indicate the rate of the reaction and the stoichiometry of the reaction. For example in the diagram the area proceeding from S_s to X_{STO} shows that readily biodegradable matter in the presence of oxygen or nitrate is converted into general storage compound in ordinary heterotrophic organisms. A reaction line meeting a vertical line outside the dotted boundary represents the production of energy.

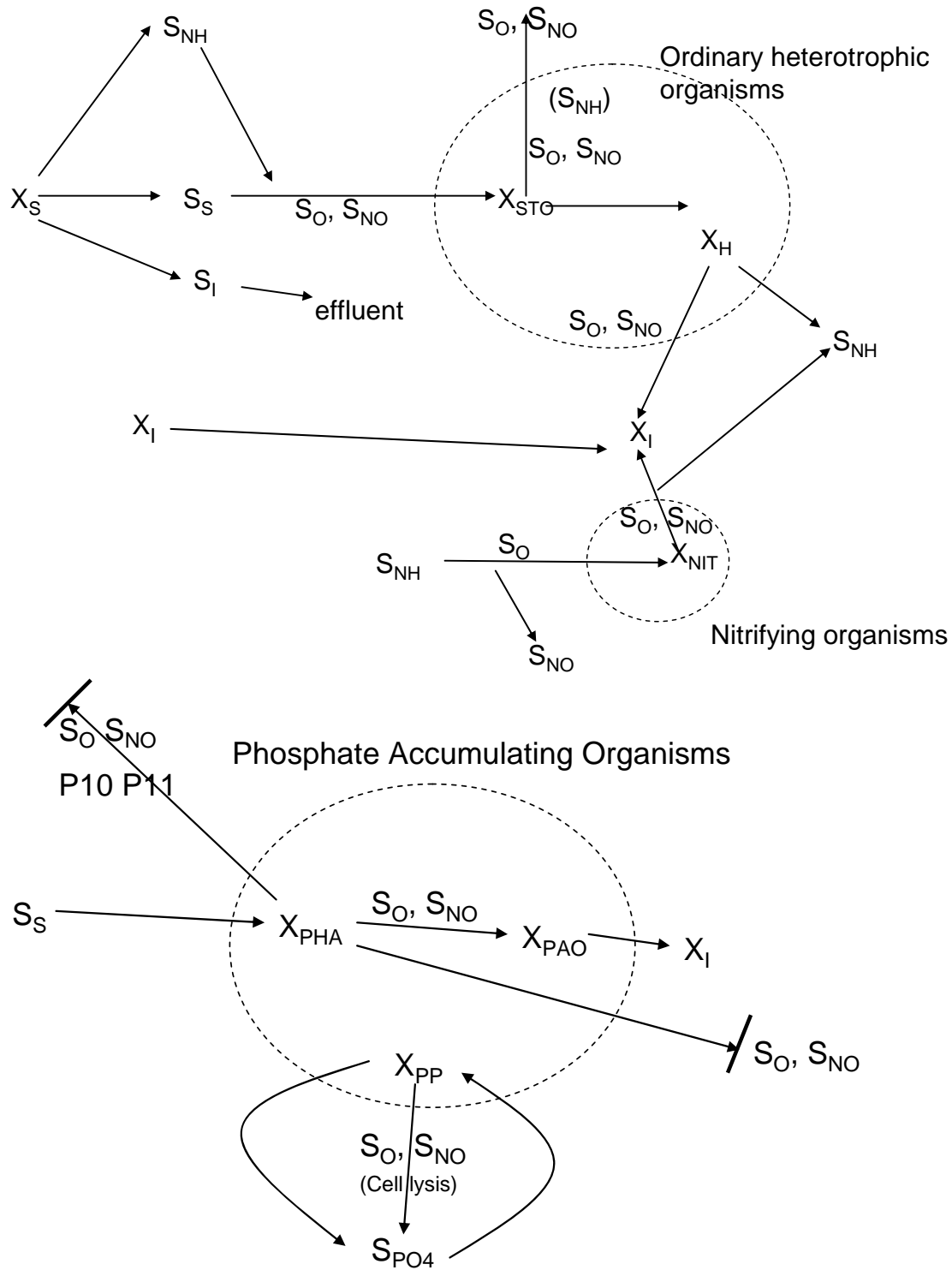

Figure C-2 Schematic Representation of ASM3 w/BioP
 Source: Comeau and Takács 2008 from WEFTEC conference 2008. Reprinted with permission from *Proceedings of WEFTEC®.08, the 81st Annual Water Environment Federation Technical Exhibition and Conference, Chicago, IL, October 18-22, 2008*.
 Copyright © 2008 Water Environment Federation, Alexandria, Virginia, www.wef.org.

Each model has its own set of reactions along with a set of assumptions underlying those assumptions. Table C-5 shows the major models and some of the key assumptions. A discussion of each follows the table.

Table C-5. Assumptions of Activated Sludge Models

Model	Temperature Dependent	Microbial Growth	Heterotroph Growth Rate Dependent on Food Source	PAOs can Denitrify	PAO Decay Dependent on Food Source
ASM1	N	DR	N	N	NA
ASM2	Y	DR	N	N	N
ASM2d	Y	DR	N	Y	N
ASM3	Y	ER	Y	N	NA
ASM3 w/ BioP	Y	ER	Y	Y	Y
TUDP	Y	DR	N	Y	Y
Barker and Dold	Y	DR	Y	Y	Y
UCTPHO+	Y	ER	Y	Y	Y

Key: DR – death-regeneration; ER- endogenous respiration; NA – not applicable.

Source: Gernaey et al. 2004

Most reactions are temperature dependent. ASM1 does not include temperature dependence, instead including a choice of either 10 or 20 degrees Celsius. The other models do include temperature dependent terms. Temperature dependent terms, however, are often limited in their applicability. For example, the terms used in ASM2 are only valid between 10 and 25 degrees Celsius.

Microbial growth is generally described in one of two ways; death-regeneration or endogenous respiration. The death-regeneration concept sets separate rates for the growth and decay of microorganisms. Endogenous respiration assumes a maintenance concept where microorganisms use a portion of their mass to provide energy. Each approach has its strengths and weaknesses. Death-regeneration allows the model to take into account different reactions occurring upon death of the microorganism and different fates of the material. It lumps together, however, the reactions of heterotrophs and autotrophs. The endogenous respiration concept clearly separates heterotroph and autotroph reactions but cannot take into account the different reactions occurring on the death of the microorganisms.

Microbes can utilize some food sources more easily than others. For example, while both methanol and VFA can be used as a substrate for denitrifying bacteria, only VFA can be used as a food source for phosphorus accumulating organisms (PAO). Also bacterial growth rates can differ depending on the carbon source. Many models do not take this into account.

It has been shown that denitrification can be accomplished by PAOs in the anaerobic zone of biological phosphorus removal plants. Some of the biological phosphorus models include this option.

Important limitations of various models are listed below:

- ASM1 models do not take into account either nitrite production or production of nitrogen gas. Therefore it is not possible to close the nitrogen balance using the ASM1 model.

- The ASM2, ASM2d, and TUDP models do not account for GAO competition with PAOs during biological phosphorus removal.

None of the models listed in Table C-2 can account for filamentous biomass or sludge bulking. Biological phosphorus models cannot handle total depletion of substrate or the simultaneous presence of substrate and another food source.

Biofilm Models

Characterization for the biofilm models are based on model type and assumptions about not only kinetics and biological growth but also transport and the nature of the biofilm. Table C-6 summarizes each type of model and the assumptions and types of problems it can solve.

Table C-6. Applicability of Biofilm Models

Model Type	Assumptions
Analytical	1 substrate is rate limiting, homogenous 1-D biofilm, first or zero order kinetics
Pseudo-Analytical	1 microbial species limited ability to model multiple species, 1 rate limiting substrate, monod kinetics
1-Dimensional	Heterogenous biomass, mass transfer in biofilm

Analytical models are very simple and can only handle very simple problems. They are limited to biofilms of even thickness and made up of a single species. Only a single rate limiting substrate can be used. This does not mean that the reaction of more than one substrate cannot be handled, but that microbial growth can only be limited by one of them. For example, consumption of both nitrate and oxygen can be modeled, but the modeler must decide beforehand which will be the rate limiting concentration for microbial growth. Analytical models can only use first or zero order rate constants instead of the more realistic monod rate constants. Although no system matches these details exactly, some may be close enough depending on the objective. If the only interest is in steady-state consumption of a single substrate (e.g. nitrate) and the biofilm is fairly even, the analytical model may be appropriate. Non-monod kinetics may be appropriate if the half saturation constant is not near the concentration of substrate in the bulk solution. If the substrate concentration is much less than the half saturation constant, first order kinetics can be used. If the substrate concentration is much greater than the half saturation constant, zero order kinetics are appropriate. If the substrate concentration and half saturation constant are about the same magnitude, analytical models are not appropriate.

Pseudo-analytical models use most of the same assumptions about biomass as the analytical models. They still generally only take into account a single species and rate limiting substrate. Some modifications can be made to handle multiple species if each species has only one limiting substrate. The biggest advantage of the pseudo-analytical model is that it can include monod kinetics. Otherwise its applicability is similar to the analytical model.

The 1-dimensional models keep separate track of dissolved and particulate components and can model the concentration of a substrate throughout the biofilm with time. These models are able to use

any kinetic expressions and can handle multiple species and multiple rate limiting substrates. They cannot handle the effects of fluid velocity on substrate transfer or biofilm growth. They also cannot handle uneven biofilm growth. The disadvantage to the 1-dimensional models is they require more computing power and time, although many simulator programs today now include 1-dimensional models.

C.3 References

- Barker, P.S. and P.L. Dold. 1997. General Model for Biological Nutrient Removal Activated Sludge Systems: Model Presentation. *Water Environment Research*. 69(5): 969-999.
- Borger, A.R., I. Takács, P.M. Roeveld, and H.W. de Mooij. 2008. SHARON Process Stability Modeled by BioWin. Presented at WEFTEC 2008.
- Brdjanovic, D., M.C.M. van Loosdrecht, P. Versteeg, C.M. Hooijmans, G.J. Alaerts, and J.J. Heijnen. 2000. Modeling COD, N and P Removal in a Full-scale WWTP Haarlem Waarderpolder. *Water Research*. 34(3): 846–858.
- Brouckaert, C.J., and C.A. Buckley. 1998. Research on the Application of Computational Fluid Dynamics to Improving the Design and Operation of Water and Wastewater Treatment Plants. University of Natal, Durban, South Africa.
- Capuno, R.E., N.G. Love, A. Terada, S. Lackner, and B.F. Smets. 2008. Model Prediction of Completely Autotrophic Nitrogen Removal under Different Reactor Configurations. Presented at WEFTEC 2008.
- Comeau, Y. and I. Takács. 2008. Schematic Representation of Activated Sludge Models. Presented at WEFTEC 2008.
- Dapena-Mora, A., S.W.H. Van Hulle, J.L. Campos, R. Mendez, P.A. Vanrolleghem, and M. Jetten. 2004. Enrichment of Anammox Biomass from Municipal Activated Sludge: Experimental and Modeling Results. *Journal of Chemical Technology and Biotechnology*. 79(12): 1421-1428.
- Gerges, H. and A. McCorquodale. 2008. Thirty Years of Sedimentation Tanks Modeling Learning from Experience. Presented at WEFTEC 2008.
- K.V. Gernaey, M.C.M van Loosdrecht, M. Henze, M. Lind, and S.B. Jorgensen. 2004. Activated Sludge Wastewater Treatment Plant Modelling and Simulation: State of the Art. *Environmental Modelling and Software*. 19(9): 763-783.
- Grady, C.P.L., G.T. Daigger, and H.C. Lim. 1999. *Biological Wastewater Treatment*. New York: Marcel Dekker.
- Gujer, W. , M. Henze, T. Mino, and M.C.M. van Loostrecht. 1999. Activated Sludge Model No. 3. *Water Science and Technology*. 39(1):183-193.
- Henze, M., C.P.L. Grady, W. Gujer, G.v.R. Marais, and T. Matsuo. 1987. *Activated Sludge Model No. 1*, IAWQ, London UK.

- Henze, M., W. Gujer, T. Mino, T. Matsuo, M. Wentzel, and G.v.R. Marais. 1995. Activated Sludge Model No. 2. IAWPRC Scientific and Technical Report No. 3. London, UK. IWA
- Henze, M., W. Gujer, T. Mino, and M.C.M. van Loosdrecht. 2000. Activated Sludge Models ASM1, ASM2, ASM2d and ASM3. IWA Scientific and Technical Report. IWA Publishing. London, UK.
- Hu, Z., M.C. Wentzel, and G.A. Ekama. 2007. A General Kinetic Model for Biological Nutrient Removal Activated Sludge Systems – Model Development. *Biotech. Bioeng.* 98(6) 1242-1258.
- Jeppsson, U. 1996. Modelling Aspects of Wastewater Treatment Processes. Thesis Lund Institute of Technology. Lund, Sweden.
- Johnson, B.R. 2009. What is Modeling? Presented in the WEF webinar: Modeling 101 - How to Use Simulators in the Design and Operation of Wastewater Treatment Facilities. WEF® Distance Learning Webcast Series. Modeling Expert Group of the Americas. February 25, 2009.
- Kissel, J.C., P.L. McCarty, and R.L. Street. 1984. Numerical Simulations of Mixed-Culture Biofilms. *Journal of Environmental Engineering.* 110: 393-411
- Merlo R., D. Parker, and E. Wahlberg. 2007. Clarifying CFD Modeling's Benefits. *Water and Environment Technology.* (19): 48-53.
- Merlo, R., D. Parker, and E. Wahlberg. 2007. Clarifying CFD Modeling's Benefits. *Water Environment & Technology.* 19(4): 48-53. Alexandria, VA: WEF.
- Narayanan, B., S. Parker, J. Demir, J.K. Esler, S.P. Zhou, S. Stinebaugh, J. Schwall, and M. Kumel. 2002. Side-by-Side Hydrodynamic Modeling and Full-scale Hydraulic Testing of Secondary Clarifiers. Proceedings of WEFTEC 2002.
- Reichert, P. 1998. AQUASIM 2.0 – User Manual. Swiss Federal Institute for Environmental Science and Technology. Dübendorf, Switzerland.
- Rieger, L., G. Koch, M. Kuhni, W. Gujer, and H. Siegrist. 2001. The EAWAG Bio-P Module for Activated Sludge Model No. 3. *Water Res.* 35(16): 3887-3903.
- Rittmann, B.E. and P.L. McCarty. 1980. Model of Steady-State-Biofilm Kinetics. *Biotechnology and Bioengineering.* 22: 2343-2357.
- Robinson, C.M.E., D.J. Burt, D.A. Egarr, and A.K. Nair. 2008. Development and Application of an Automated CFD Tool for Modeling Wastewater Clarifiers. Presented at WEFTEC 2008.
- Saez, P.B. and B.E. Rittmann. 1992. Accurate Pseudoanalytical Solution for Steady State Biofilms. *Biotechnology and Bioengineering.* 39:790-793.
- Volcke, E.I.P., M. Loccupier, E.J.L. Noldus, and P.A. Vanrolleghem. 2007. Operation of a SHARON Nitritation Reactor: Practical Implications from a Theoretical Study. *Water Science and Technology.* 56(6):145-154.

Wanner, O., H. Eberl, E. Morgenroth, D. Noguera, C. Picioreanu, B. Rittmann, and M. van Loosdrecht. 2006. *Mathematical Modeling of Biofilms*. IWA publishing, London.

Wanner, O., and W. Gujer. 1986. A Multispecies Biofilm Model. *Biotechnology and Bioengineering*. 28:314-328.

WERF. 2003. Executive Summary: Methods for Wastewater Characterization in Activated Sludge Modeling. Alexandria, VA: WERF and IWA Publishing.

Wett, B., S. Murthy, M. O'Shaughnessy, J. Sizeore, I. Takács, W. Bailey, M. Musabyimana, P. Sanjines, D. Katehis, and G.T. Daigger. 2008. Design Considerations for SBRs Used in Digestion Liquor Sidestream Treatment. Presented at WEFTEC 2008.