



PDHonline Course C645 (2 PDH)

An Introduction to Retaining Walls and Excavation Support Systems

Instructor: J. Paul Guyer, P.E., R.A., Fellow ASCE, Fellow AEI

2020

PDH Online | PDH Center

5272 Meadow Estates Drive
Fairfax, VA 22030-6658
Phone: 703-988-0088
www.PDHonline.com

An Approved Continuing Education Provider

An Introduction to Retaining Walls and Excavation Support Structures

J. Paul Guyer, P.E., R.A.

CONTENTS

- 1. DESIGN CONSIDERATIONS FOR RETAINING WALLS**
- 2. EARTH PRESSURES**
- 3. EQUIVALENT FLUID PRESSURES**
- 4. DESIGN PROCEDURES FOR RETAINING WALLS**
- 5. CRIB WALL**
- 6. EXCAVATION SUPPORT SYSTEMS**
- 7. STRUTTED EXCAVATIONS**
- 8. STABILITY OF BOTTOM OF EXCAVATION**
- 9. ANCHORED WALLS**

(This publication is adapted from the *Unified Facilities Criteria* of the United States government which are in the public domain, have been authorized for unlimited distribution, and are not copyrighted.)

(The figures, tables and formulas in this publication may at times be a little difficult to read, but they are the best available. **DO NOT PURCHASE THIS PUBLICATION IF THIS LIMITATION IS NOT ACCEPTABLE TO YOU.**)

1. DESIGN CONSIDERATIONS FOR RETAINING WALLS.

1.1 GENERAL. Retaining walls must be designed so that foundation pressures do not exceed allowable bearing pressures, wall settlements are tolerable, safety factors against sliding and overturning are adequate, and the wall possesses adequate structural strength. Methods for evaluating earth pressures on retaining walls and design procedures are summarized herein for cohesionless backfill materials, which should be used whenever practicable.

1.2 FORCES ACTING ON RETAINING WALLS. Forces include earth pressures, seepage and uplift pressures, surcharge loads, and weight of the wall. Typical load diagrams for principal wall types are shown in figure 1. The magnitude and distribution of active and passive earth pressures are developed from the earth theory for walls over 20 feet high and from semi-empirical curves for lower walls. The subgrade reaction along the base is assumed linearly distributed.

2. EARTH PRESSURES.

2.1 EARTH PRESSURE AT REST. For cohesionless soils, with a horizontal surface, determine the coefficient of earth pressure at rest, K_0 , from the following:

$$K_0 = 1 - \sin \Phi \quad (\text{eq 1})$$

2.2 ACTIVE EARTH PRESSURE. Formulas for calculating the coefficient of active earth pressure for a cohesionless soil with planar boundaries are presented in figure 2.

2.3 PASSIVE EARTH PRESSURE. Formulas for calculating the coefficient of passive earth pressure for a cohesionless soil with planar boundaries are presented in figure 3.

2.4 EARTH PRESSURE CHARTS. Earth pressure coefficients based on planar sliding surfaces are presented in figure 4. The assumption of a planar sliding surface is sufficiently accurate for the majority of practical problems. A logarithmic spiral failure surface should be assumed when passive earth pressure is calculated and the angle of wall friction, δ , exceeds $\Phi' / 3$. Earth pressure coefficients based on a logarithmic spiral sliding surface are presented in textbooks on geotechnical engineering. Passive pressure should not be based on Coulomb theory since it overestimates passive resistance. Because small movements mobilize δ and concrete walls are relatively rough, the wall friction can be considered when estimating earth pressures. In general, values of δ for active earth pressures should not exceed $\theta' / 2$ and for passive earth pressures should not exceed $\theta' / 3$. The angle of wall friction for walls subjected to vibration should be assumed to be zero.

2.5 DISTRIBUTION OF EARTH PRESSURE. A presentation of detailed analyses is beyond the scope of this manual. However, it is sufficiently accurate to assume the following locations of the earth pressure resultant:

2.5.1 FOR WALLS ON ROCK:

- 0.38H above base for horizontal or downward sloping backfill
- 0.45H above base for upward sloping backfill

2.5.2 FOR WALLS ON SOIL:

- 0.33H above base of horizontal backfill
- 0.38H above base of upward sloping backfill

Water pressures are handled separately.

2.6 SURCHARGE LOADS. Equations for concentrated point and line load are presented in figure 5. For uniform or non-uniform surcharge pressure acting on an irregular area, use influence charts based on the Boussinesq equations for horizontal loads and double the horizontal pressures obtained.

2.7 DYNAMIC LOADS. The effects of dynamic loading on earth pressures are beyond the scope of this publication. Refer to geotechnical engineering textbooks dealing with the subject.

3. EQUIVALENT FLUID PRESSURES. The equivalent fluid method is recommended for retaining walls less than 20 feet high. Assign available backfill material to a category listed in figure 6. If the wall must be designed without knowledge of backfill properties, estimate backfill pressures on the basis of the most unsuitable material that may be used. Equivalent fluid pressures are shown in figure 6 for the straight slope backfill and in figure 7 for the broken slope backfill. Dead load surcharges are included as an equivalent weight of backfill. If the wall rests on a compressible foundation and moves downward with respect to the backfill, pressures should be increased 50 percent for backfill types 1, 2, 3, and 5. Although equivalent fluid pressures include seepage effects and time-conditioned changes in the backfill material, adequate drainage should be provided.

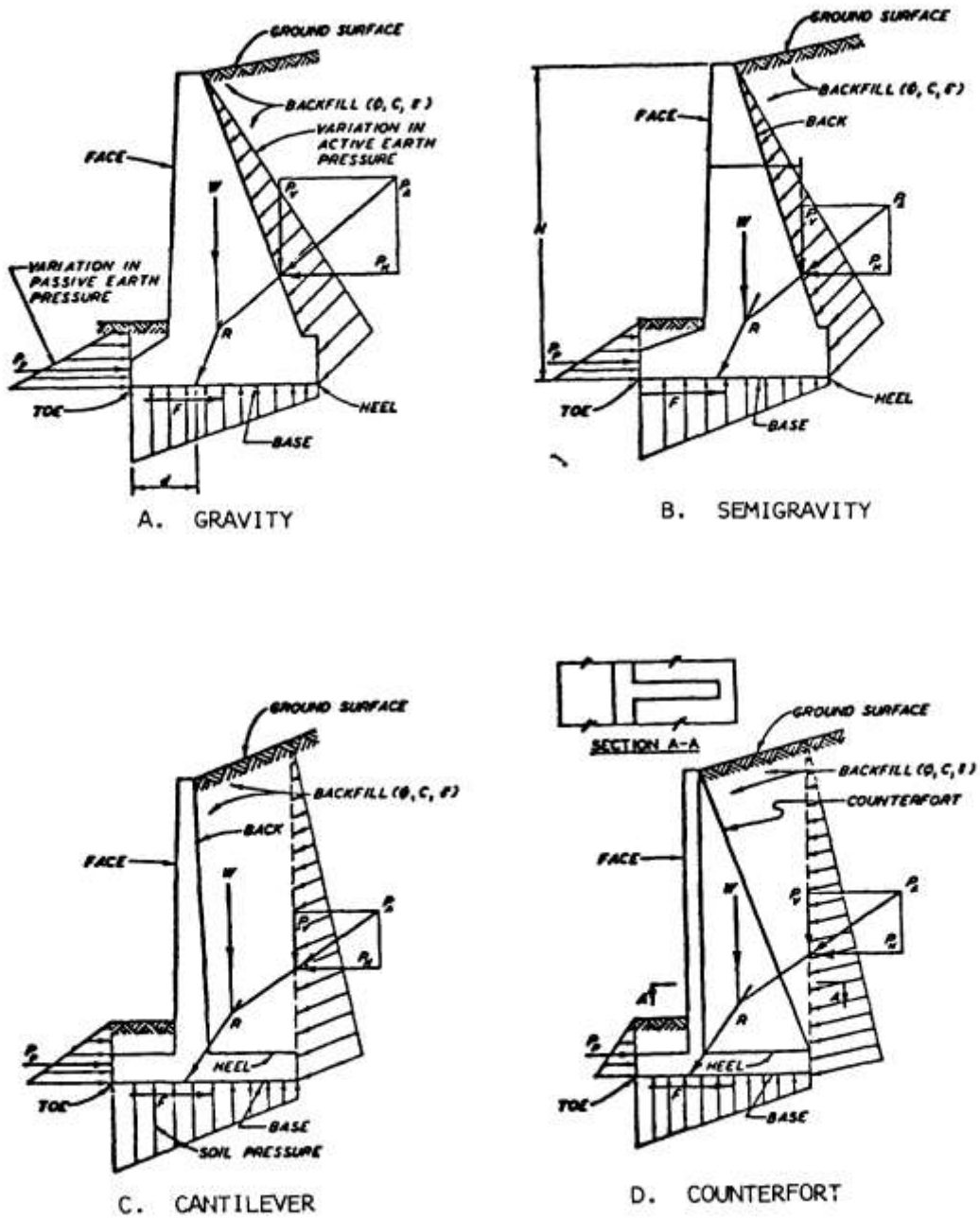
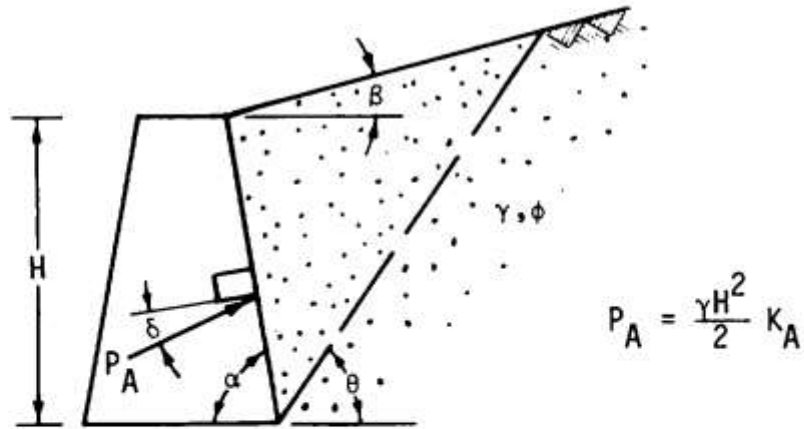

Figure 1
Load diagrams for retaining walls



$$P_A = \frac{\gamma H^2}{2} K_A$$

Where
$$K_A = \frac{\sin^2 (\alpha + \phi)}{\sin^2 \alpha \sin(\alpha - \delta) \left[1 + \sqrt{\frac{\sin(\phi + \delta) \sin(\phi - \beta)}{\sin(\alpha - \delta) \sin(\alpha + \beta)}} \right]^2}$$

∴ Component of P_A perpendicular to wall back is:

$$P_{AN} = P_A \cos \delta = \frac{\gamma H^2}{2} K_A \cos \delta$$

Special cases

① If $\alpha = 90^\circ$, $\beta = 0^\circ$, then:

$$P_A = \frac{\gamma H^2}{2} K_A$$

where
$$K_A = \left[\frac{\cos \phi}{\sqrt{\cos \delta} + \sqrt{\sin(\delta + \phi) \sin \phi}} \right]^2$$

(Typical K_A values for this case are given in Fig. 14-4.)

② If, in addition, $\delta = 0$:

$$K_A = \frac{\cos^2 \phi}{(1 + \sin \phi)^2} = \frac{1 - \sin \phi}{1 + \sin \phi} = \tan^2 \left(45 - \frac{\phi}{2} \right)$$

Figure 2

Active pressure of sand with planar boundaries

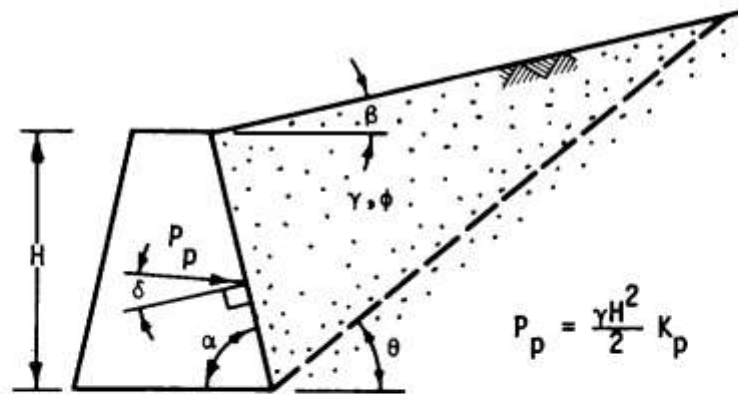

Where $K_p = \frac{\sin^2(\alpha - \phi)}{\sin^2 \alpha \sin(\alpha + \delta) \left[1 - \sqrt{\frac{\sin(\phi + \delta) \sin(\phi + \beta)}{\sin(\alpha + \delta) \sin(\alpha + \beta)}} \right]^2}$

∴ Component of P_p perpendicular to wall back is:

$$P_{pn} = P_p \cos \delta = \frac{\gamma H^2}{2} K_p \cos \delta$$

Special cases

① If $\alpha = 90^\circ$, $\beta = 0^\circ$, then:

$$P_p = \frac{\gamma H^2}{2} K_p$$

where $K_p = \left[\frac{\cos \phi}{\sqrt{\cos \delta} - \sqrt{\sin(\phi + \delta) \sin \delta}} \right]^2$

② If, in addition, $\delta = 0$:

$$K_p = \frac{\cos^2 \phi}{(1 - \sin \phi)^2} = \frac{1 + \sin \phi}{1 - \sin \phi} = \tan^2 \left(45 + \frac{\phi}{2} \right)$$

(Typical values for this case are given in Fig. 14-4.)

Note: Equations are unconservative and should not be used for $\delta > \frac{\phi}{3}$; they are satisfactory for $\delta \leq \frac{\phi}{3}$.

Figure 3

Passive pressure of sand with planar boundaries

4. DESIGN PROCEDURES FOR RETAINING WALLS.

4.1 CRITERIA FOR SELECTING EARTH PRESSURES.

- The equivalent fluid method should be used for estimating active earth pressures on retaining structures up to 20 feet high, with the addition to earth pressures resulting from backfill compaction (fig 8).
- For walls higher than 20 feet, charts, equations, or graphical solutions should be used for computing lateral earth pressures, with the addition of earth pressures resulting from backfill compaction.
- Use at-rest pressures for rigid retaining structures resting on rock or batter piles. Design cantilever walls founded on rock or restrained from lateral movement for at-rest pressures near the base of the wall, active pressures along the upper portions of the wall, and compaction-induced earth pressures from the top to the depth at which they no longer increase lateral earth pressures (fig 8/14-8). Generally, a linear variation in earth pressure coefficients with depth may be assumed between the sections of wall.
- Consider passive pressures in the design if applied loads force the structure to move against the soil. Passive pressures in front of retaining walls are partially effective in resisting horizontal sliding.

4.2 OVERTURNING. Calculate the factor of safety, FS, against overturning, defined as the ratio of resisting moments to the overturning moments. Calculate the resultant force using load diagrams shown in figure 1, as well as other loadings that may be applicable. Use only half of the ultimate passive resistance in calculating the safety factor. The resultant of all forces acting on the retaining wall should fall within the middle third to provide a safety factor with respect to overturning equal to or greater than 1.5.

(Refer to: *R. B. Peck, W. E. Hanson, and T. H. Thornburn, Foundation Engineering, 1974, p 309, John Wiley & Sons. Inc., New York.*)

aFigure 4

Active and passive earth pressure coefficients according to Coulomb theory

4.3 SLIDING.

- The factor of safety against sliding, calculated as the ratio of forces resisting movement to the horizontal component of earth plus water pressure on the back wall, should be not less than 2.0. If soil in front of the toe is disturbed or loses its strength because of possible excavation, ponding, or freezing and thawing, passive resistance at the toe, P_p , should be neglected and the minimum factor of safety lowered to 1.5; but if the potential maximum passive resistance is small, the safety factor should remain at 2.0 or higher.
- For high walls, determine the shearing resistance between the base of wall and soil from laboratory direct shear tests in which the adhesion between the concrete and the undisturbed soil is measured. In the absence of tests, the coefficient of friction between concrete and soil may be taken as 0.55 for coarse-grained soils without silt, 0.45 for coarse-grained soils with silt, and 0.35 for silt. The soil in a layer beneath the base may be weaker, and the shearing resistance between the base of wall and soil should never be assumed to exceed the soil strength. Consider maximum uplift pressures that may develop beneath the base.
- If the factor of safety against sliding is insufficient, increase resistance by either increasing the width of the base or lowering the base elevation. If the wall is founded on clay, the resistance against sliding should be based on s_u for short-term analysis and Φ' for long-term analysis.

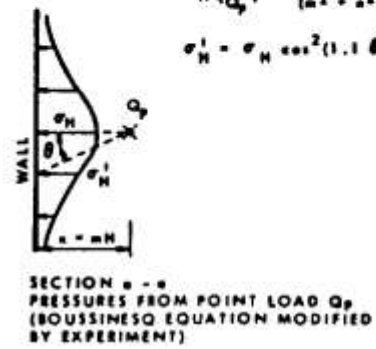
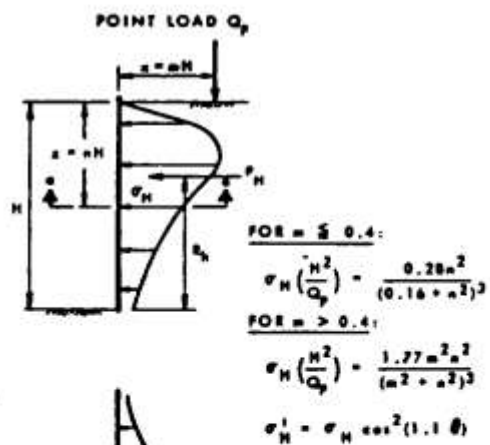
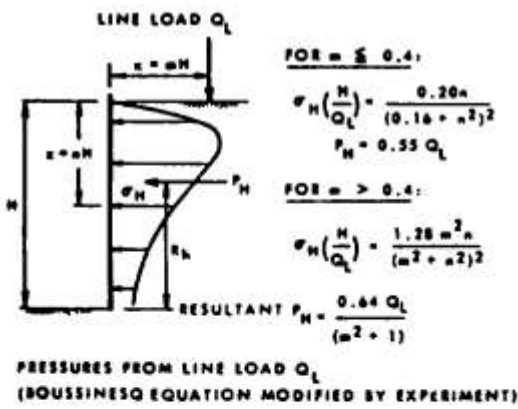
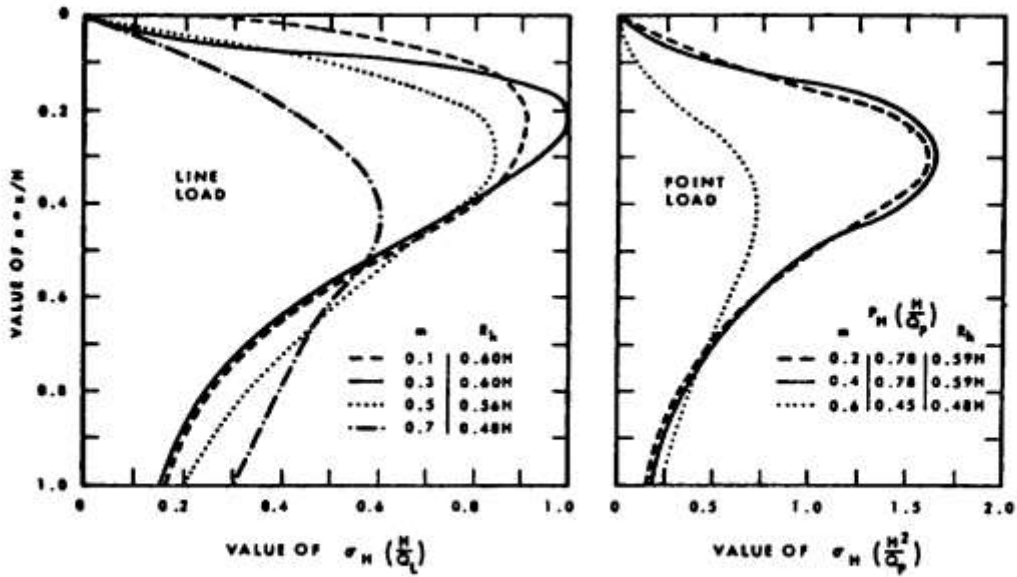
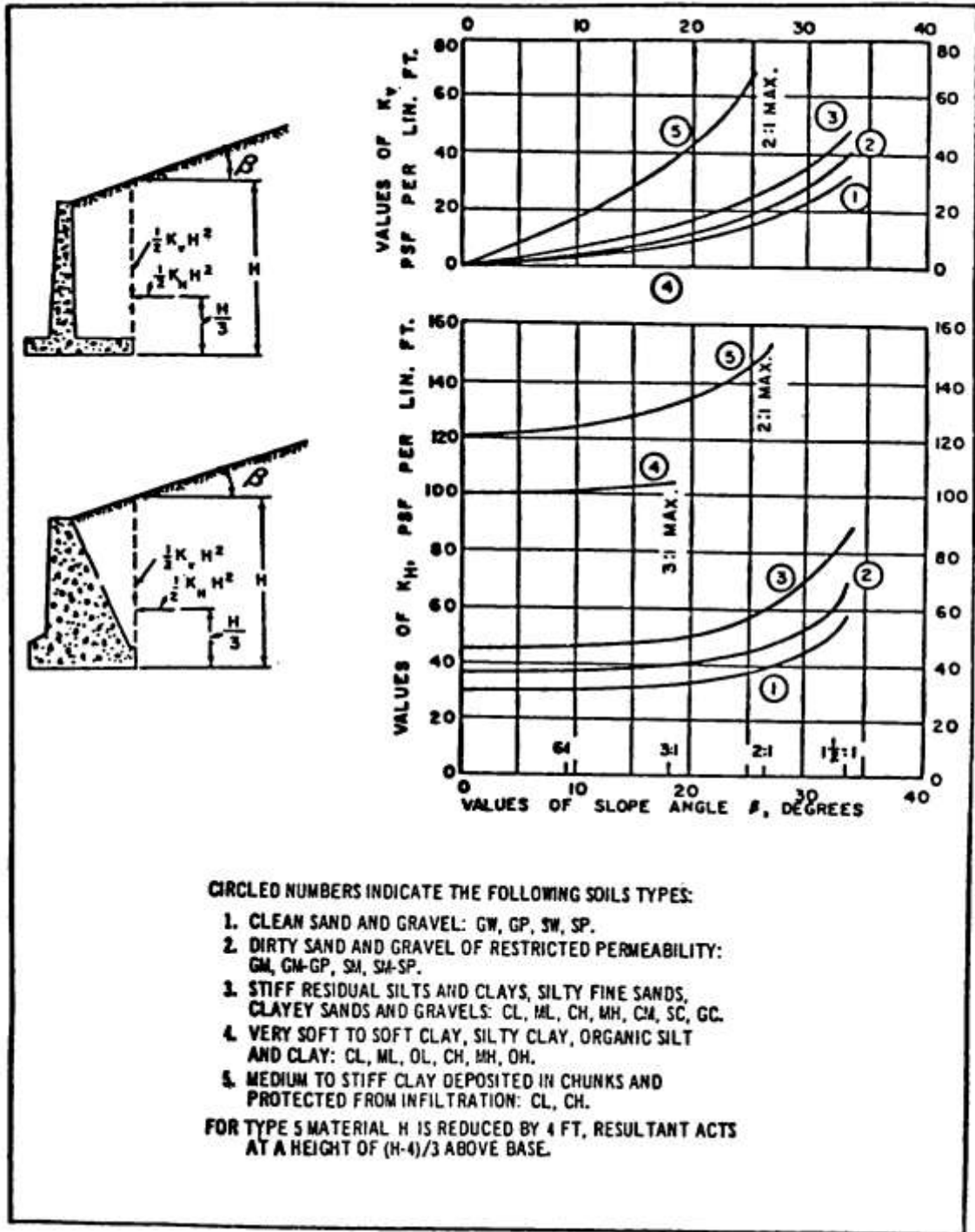

Figure 5
Horizontal pressures on walls due to surcharge



(NAVFAC DM-7)

Figure 6

Design loads for low retaining walls, straight slope backfill

4.4 BEARING CAPACITY. Calculate from the bearing capacity analysis. Consider local building codes or experience where applicable.

4.5 SETTLEMENT AND TILTING. When a high retaining wall is to be founded on compressible soils, estimate total and differential settlements using accepted procedures. Reduce excessive total settlement by enlarging the base width of the wall or by using lightweight backfill material. Reduce tilting induced by differential settlement by proportioning the size of the base such that the resultant force falls close to the center of the base. Limit differential settlement to the amount of tilting that should not exceed $0.05H$. If settlements are excessive, stabilize compressible soils by surcharge loading or a support wall on piles.

4.6 DEEP-SEATED FAILURE. Check the overall stability of the retaining wall against a deep-seated foundation failure using accepted methods of analysis in the technical literature. Forces considered include weight of retaining wall, weight of soil, unbalanced water pressure, equipment, and future construction. The minimum safety factor is 1.5.

4.7 USE OF PILES. When stability against bearing capacity failure cannot be satisfied or settlement is excessive, consider a pile foundation. Use batter piles if the horizontal thrust of the lateral earth pressure is high.

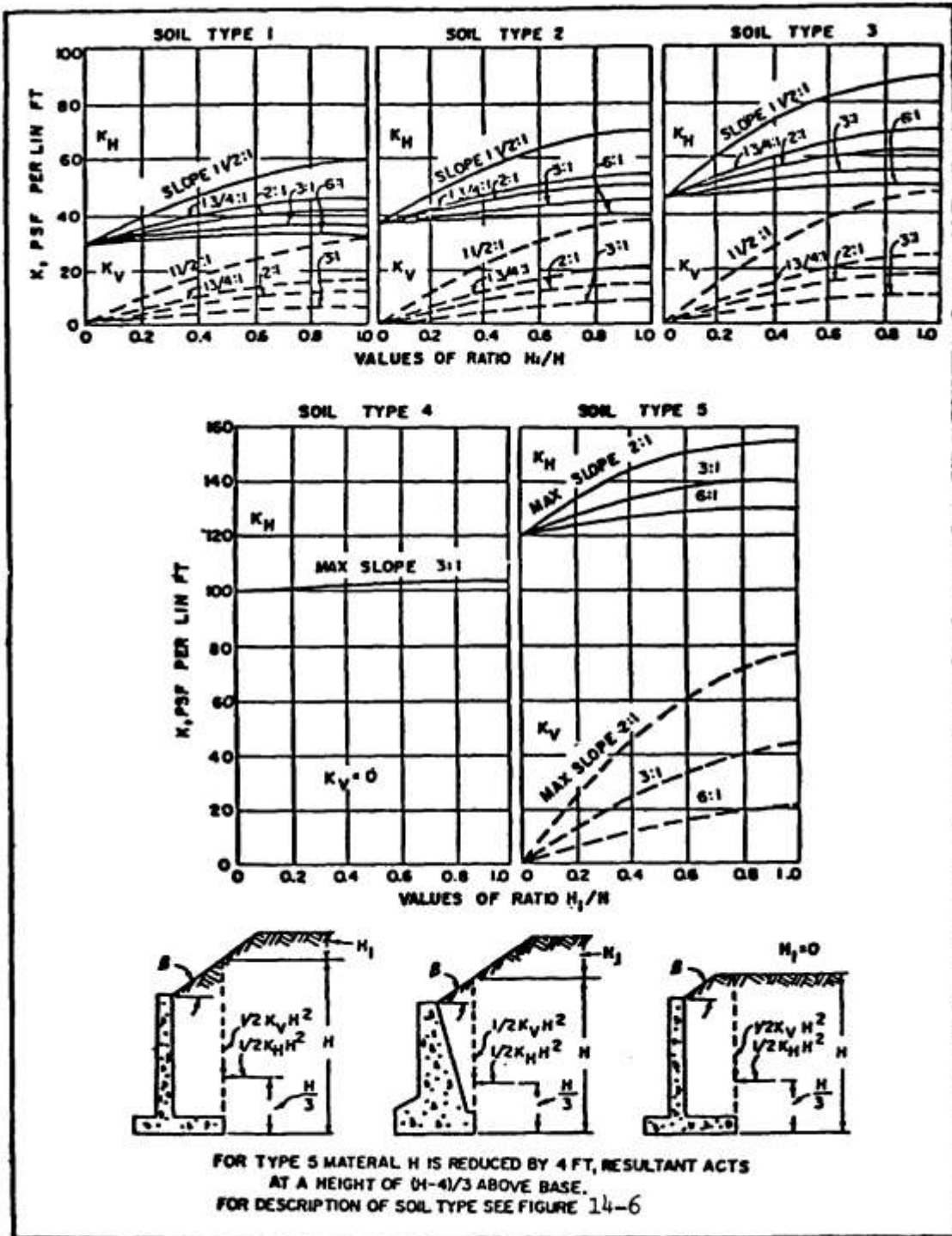

(NAVFAC DM-7)

Figure 7
Design loads for low retaining walls, broken slope backfill

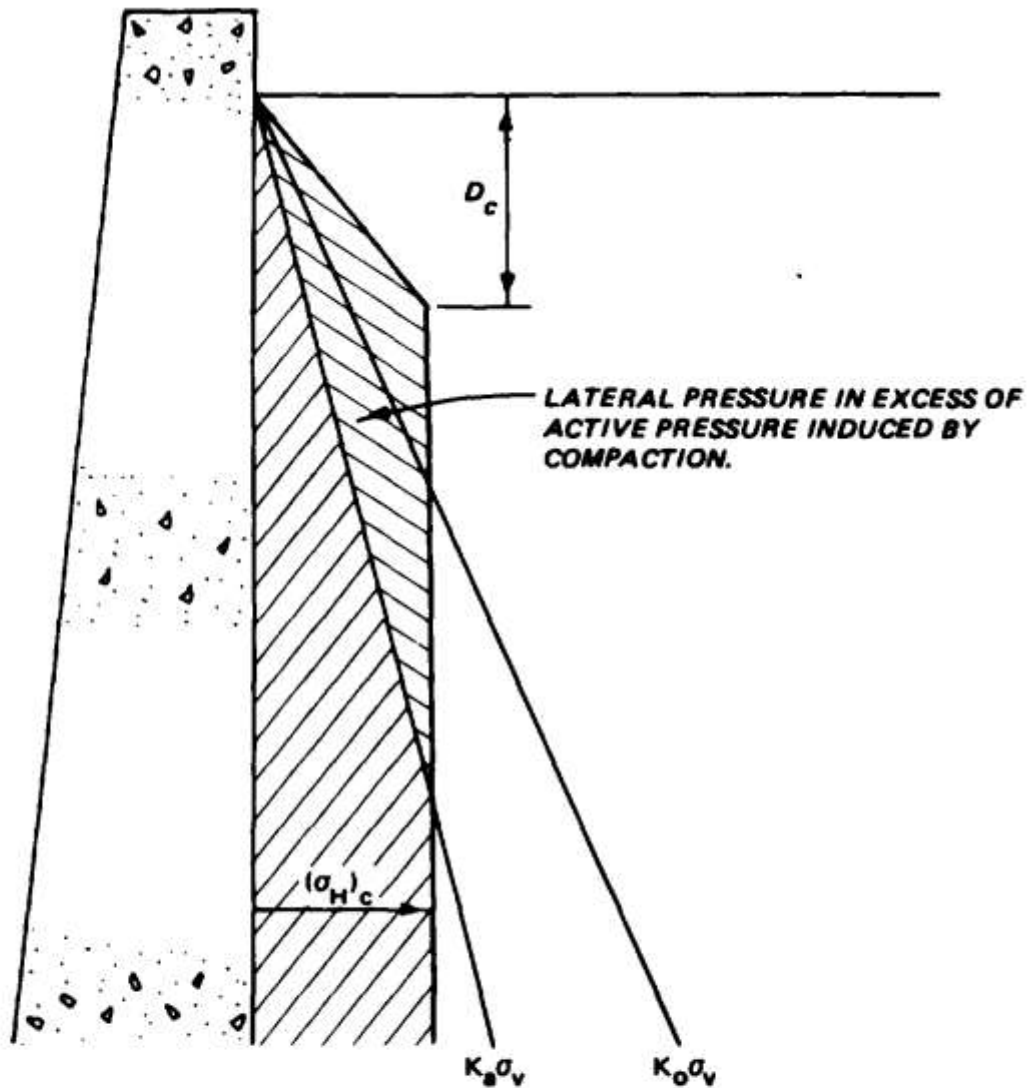

<u>COMPACTION EQUIPMENT</u>	<u>CRITICAL DEPTH, D_c, ft</u>	<u>$(\sigma_H)_c$ psf</u>
10-TON SMOOTH WHEEL ROLLER	1.9	420
3.2-TON VIBRATORY ROLLER	1.7	400
1.4-TON VIBRATORY ROLLER	1.2	260
400-KG VIBRATORY PLATE	1.5	340
120-KG VIBRATORY PLATE	1.0	240

Figure 8
 Estimate of increased pressure induced by compaction

5. CRIB WALL. Design criteria of crib walls are presented in figure 9.

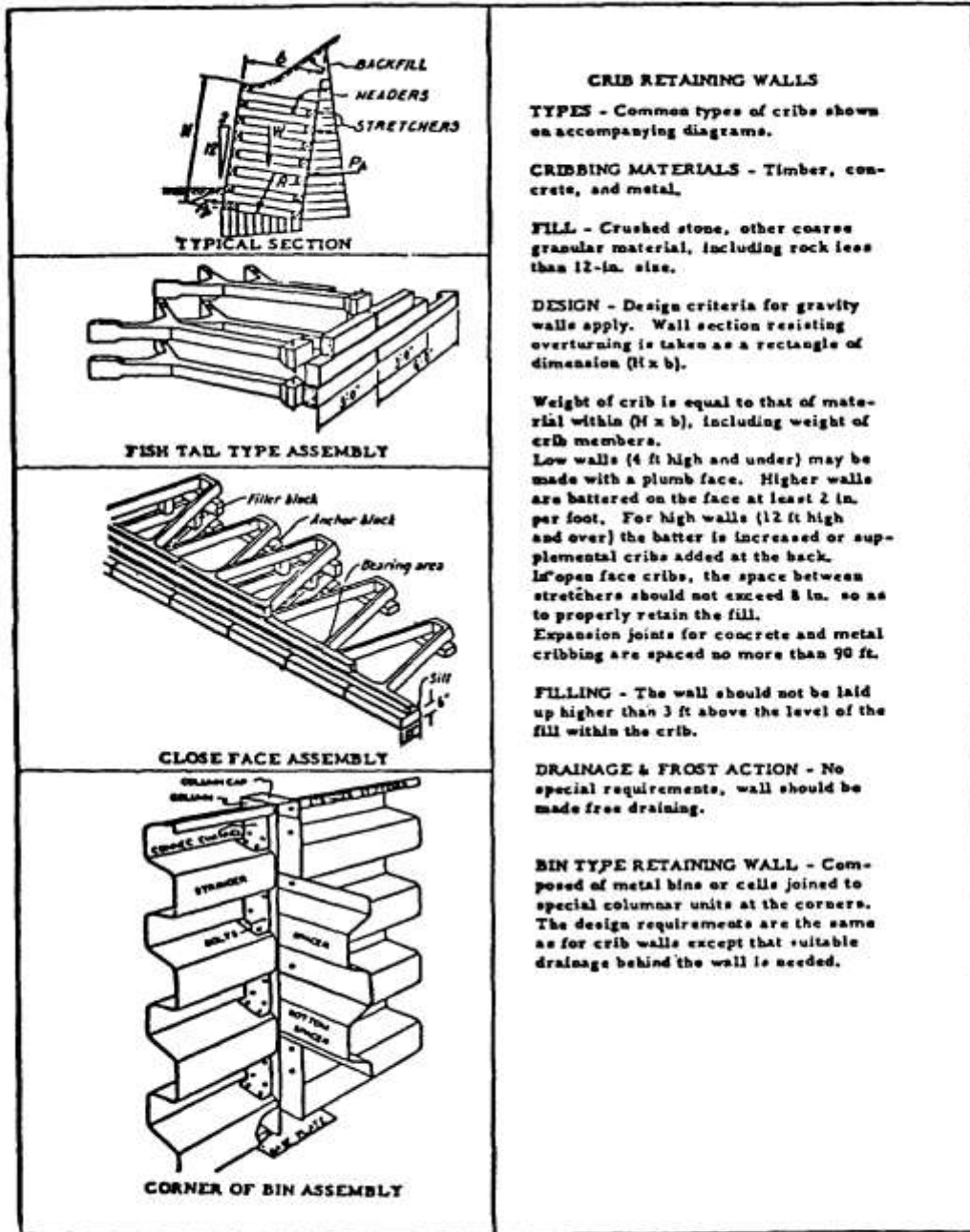

CRIB RETAINING WALLS

TYPES - Common types of cribs shown on accompanying diagrams.

CRIBBING MATERIALS - Timber, concrete, and metal.

FILL - Crushed stone, other coarse granular material, including rock less than 12-in. size.

DESIGN - Design criteria for gravity walls apply. Wall section resisting overturning is taken as a rectangle of dimension (H x b).

Weight of crib is equal to that of material within (H x b), including weight of crib members.

Low walls (4 ft high and under) may be made with a plumb face. Higher walls are battered on the face at least 2 in. per foot. For high walls (12 ft high and over) the batter is increased or supplemental cribs added at the back.

In open face cribs, the space between stretchers should not exceed 8 in. so as to properly retain the fill.

Expansion joints for concrete and metal cribbing are spaced no more than 90 ft.

FILLING - The wall should not be laid up higher than 3 ft above the level of the fill within the crib.

DRAINAGE & FROST ACTION - No special requirements, wall should be made free draining.

BIN TYPE RETAINING WALL - Composed of metal bins or cells joined to special columnar units at the corners. The design requirements are the same as for crib walls except that suitable drainage behind the wall is needed.

(NAVFAC DM-7)

Figure 9
Design criteria for crib and bin walls

6. EXCAVATION SUPPORT SYSTEMS. The use of steep or vertical slopes for a deep excavation is often necessitated by land area availability or economics. Such

slopes are commonly supported by a cantilever wall (only for shallow excavations), a braced wall, or a tieback wall (fig 10). In some cases, it may be economical to mix systems, such as a free slope and a tieback wall or a tieback wall and a braced wall. Table 1 summarizes the wall types with their typical properties and advantages and disadvantages. Table 2 lists factors for selecting wall support systems for a deep excavation (>20 feet). Table 3 gives design parameters, such as factors of safety, heave problems, and supplemental references.

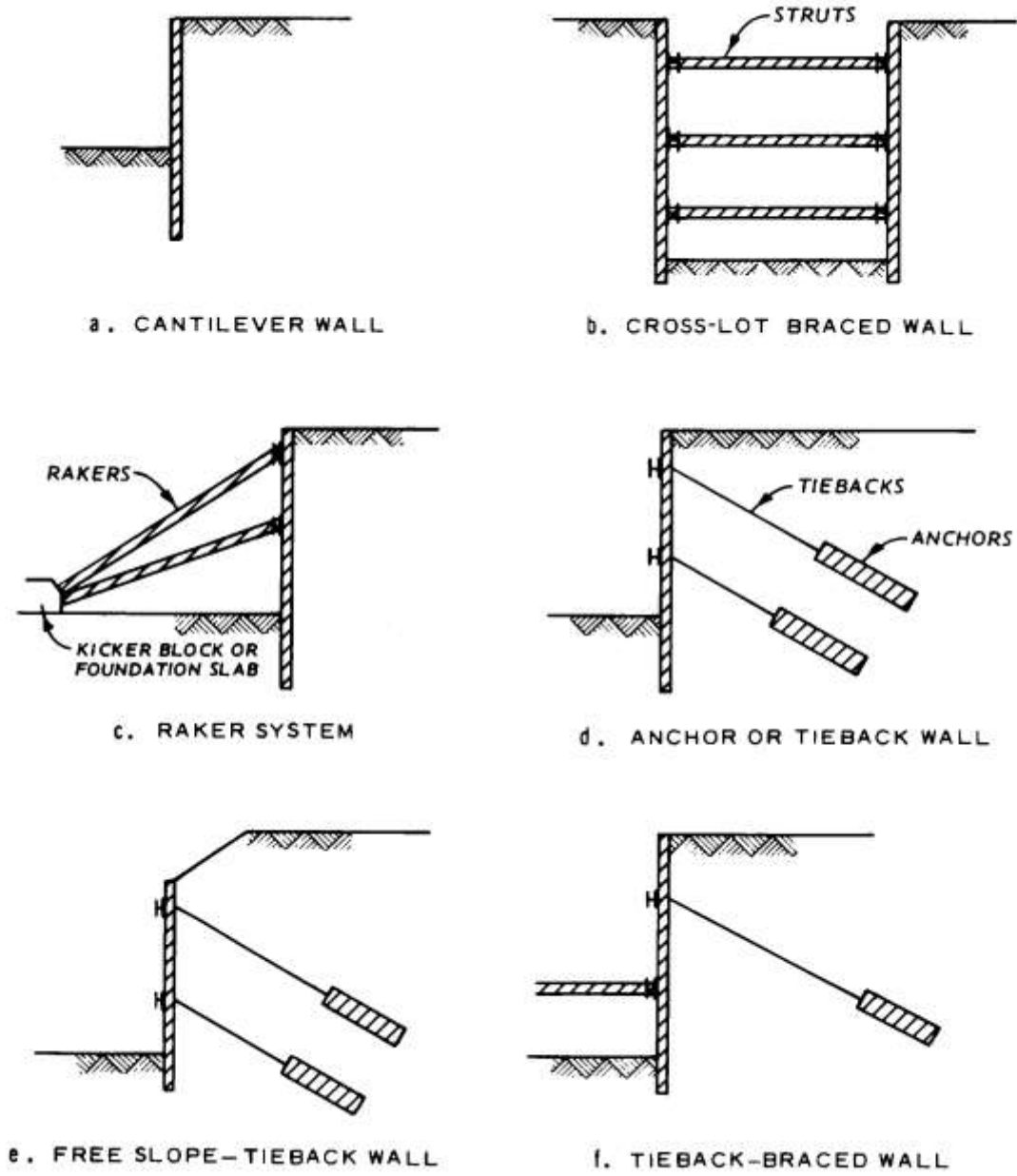

Figure 10
Types of support systems for excavations

7. STRUTTED EXCAVATIONS.

7.1 EMPIRICAL DESIGN EARTH PRESSURE DIAGRAMS developed from observations are shown in figure 11. In soft to medium clays, a value of $m = 1.0$ should be applied if a stiff stratum is present at or near the base of the excavation. If the soft material extends to a sufficient depth below the bottom of the excavation and significant plastic yielding occurs, a value of 0.4 should be used for m . The degree of plastic yielding beneath an excavation is governed by the stability number N expressed as:

$$N = \gamma H / s_u \quad (\text{eq 2})$$

where γ , H , and s_u , are defined in figure 11. If N exceeds about 4, $m < 1.0$.

7.2 FOR STIFF-FISSURED CLAYS, diagram (c) of figure 11 applies for any value of N . If soft clays, diagram (b) applies except when the computed maximum pressure falls below the value of the maximum pressure in diagram (c). In these cases, generally for $N < 5$ or 6, diagram (c) is used as a lower limit. There are no design rules for stiff intact clays and for soils characterized by both c and f such as sandy clays, clayey sands, or cohesive silts.

7.3 THE UPPER TIER OF BRACING should always be installed near the top of the cut, although computations may indicate that it could be installed at a greater depth. Its location should not exceed $2s_u$ below the top of the wall.

7.4 UNBALANCED WATER PRESSURES should be added to the earth pressures where the water can move freely through the soil during the life of the excavation. Buoyant unit weight is used for the soil below water. Where undrained behavior of a soil is considered to apply, the use of total unit weights in calculating earth pressures automatically accounts for the loads produced by groundwater (fig 11). Pressures due

to the surcharge load are computed as indicated in previous discussions and added to the earth and water pressures.

7.5 EACH STRUT is assumed to support an area extending halfway to the adjacent strut (fig 11). The strut load is obtained by summing the pressure over the corresponding tributary area. Temperature effects, such as temperature increase or freezing of the retained material, may significantly increase strut loads.

7.6 SUPPORT is carried to the sheeting between the struts by horizontal structural members (wales). The wale members should be designed to support a uniformly distributed load equal to the maximum pressure determined from figure 11 times the spacing between the wales. The wales may be assumed to be simply supported (pinned) at the struts.

Name	Section	Typical EI values per foot, ksf	Advantages	Disadvantages
Steel sheeting		900-90,000	(1) Can be impervious (2) Easy to handle and construct (3) Low initial cost	(1) Limited stiffness (2) Interlocks can be lost in hard driving or in gravelly soils
Soldier pile and lagging		2,000-120,000	(1) Easy to handle and construct (2) Low initial cost (3) Can be driven or augered	(1) Wall is pervious (2) Requires care in placement of lagging
Cast-in-place concrete slurry wall		288,000 – 2,300,000	(1) Can be impervious (2) High stiffness (3) Can be part of permanent structure	(1) High initial cost (2) Specialty contractor required to construct (3) Extensive slurry disposal needed (4) Surface can be rough
Precast concrete slurry		288,000 – 2,300,000	(1) Can be impervious (2) High stiffness (3) Can be part of permanent structure (4) Can be precast	(1) High initial cost (2) Specialty contractor required to construct (3) Slurry disposal needed (4) Permits some yielding of subsoils
Cylinder pile wall		115,000 – 1,000,000	(1) Secant piles impervious (2) High stiffness (3) Highly specialized equipment not needed for tangent piles (4) Slurry not needed	(1) High initial cost (2) Secant piles require special equipment

Table 1
Types of walls

Requirement	Lends itself to use of	Downgrades utility of	Comment
1. Open excavation area	Tiebacks or rakers or cantilever walls (shallow excavation)	Crosslot struts	
2. Low initial cost	Soldier pile or sheetpile walls; combined soil slope with wall	Diaphragm walls, cylinder pile walls	Depends somewhat on 3
3. Use as part of permanent structure	Diaphragm or cylinder pile walls	Sheetpile or soldier pile walls	Diaphragm wall most common as permanent wall
4. Deep, soft clay, subsurface conditions	Strutted or raker supported diaphragm or cylinder pile walls	Tiebacks, flexible walls	Tieback capacity not adequate in soft clays
5. Dense, gravelly sand	Soldier pile, diaphragm or clay subsoils	Sheetpile walls or cylinder pile	Sheetpile walls lose interlock on hard driving
6. Deep over-consolidated clays	Struts, long tiebacks or combination tiebacks and struts (figure 10)	Short tiebacks	High lateral stresses are relieved in O.C. soils and lateral movements
7. Avoid dewatering	Diaphragm walls, possibly sheetpile walls in soft subsoils	Soldier pile wall	Soldier pile wall is pervious
8. Minimize movements	High preloads on stiff strutted or tied-back wall	Flexible walls	Analyze for stability of bottom of excavation
9. Wide excavation (greater than 20 m wide)	Tiebacks or rakers	Crosslot struts	Tiebacks preferable except in very soft clay subsoils
10. Narrow excavation (less than 20 m wide)	Crosslot struts	Tiebacks or rakers	Struts more economical but tiebacks still may be preferred to keep excavation open

Table 2
Factors involved in choice of a support system for a deep excavation

1. Earth loads	For struts, select from the semiempirical diagrams (fig. 14-10); for walls and wales use lower loads - reduce by 25 percent from strut loading. Tiebacks may be designed for lower loads than struts unless preloaded to higher values to reduce movements	
2. Water loads	Often greater than earth load on impervious wall. Should consider possible lower water pressures as a result of seepage through or under wall. Dewatering can be used to reduce water loads	
3. Stability	Consider possible instability in any berm or exposed slope. Sliding potential beneath the wall or behind tiebacks should be evaluated. Deep seated bearing failure under weight of supported soil to be checked in soft cohesive soils (fig. 12)	
4. Piping	Loss of ground caused by high groundwater tables and silty soils. Difficulties occur due to flow beneath wall, through bad joints in wall, or through unsealed sheetpile handling holes. Dewatering may be required.	
5. Movements	Movements can be minimized through use of stiff impervious wall supported by preloaded tieback or braced system. Preloads should be at the level of load diagrams (fig. 11) for minimizing movements	
6. Dewatering – recharge	Dewatering reduces loads on wall systems and minimizes possible loss of ground due to piping. May cause settlements and will then need to recharge outside of support system. Not applicable in clayey soils	
7. Surcharge	Storage of construction materials usually carried out near wall systems. Allowance should always be made for surcharge, especially in upper members	
8. Preloading	Useful to remove slack from system and minimize soil movements. Preload up to the load diagram loads (fig. 14-10) to minimize movements	
9. Construction sequence	Sequence used to build wall important in loads and movements of system. Moments in walls should be checked at every major construction stage for maximum condition. Upper struts should be installed early	
10. Temperature	Struts subject to load fluctuation due to temperature loads; may be important for long struts	
11. Frost penetration	In very cold climates, frost penetration can cause significant loading on wall system. Design of upper portion of system should be conservative. Anchors may have to be heated	
12. Earthquakes	Seismic loads may be induced during earthquake. Local codes often govern.	
13. Codes	For shallow excavations, codes completely specify support system. Varies from locality to locality. Consult OSHA requirements	
14. Factors of safety	Item	Minimum design factor of safety
	Earth berms	2.0
	Critical slopes	1.5
	Non-critical slopes	1.2
	Basal heaves	1.5
	General stability	1.5

Table 3

Design considerations for braced and tieback walls

8. STABILITY OF BOTTOM OF EXCAVATION.

8.1 PIPING IN SAND. The base of an excavation in sand is usually stable unless an unbalanced hydrostatic head creates a "quick" condition. Among the methods to eliminate instability are dewatering, application of a surcharge load at the bottom of the excavation, and deeper penetration of the piling.

8.2 HEAVING IN CLAYS. The stability against heave of the bottom of an excavation in soft clay may be evaluated from figure 12. If the factor of safety is less than 1.5, the piling should be extended below the base of the excavation. Heave may also occur because of unrelieved hydrostatic pressures in a permeable layer located below the clay.

8.3 CARE OF SEEPAGE. Small amounts of seepage into the excavation can be controlled by pumping from sumps. Such seepage can be expected if the excavation extends below the water table into permeable soils. If the soils consist of fine sands and silts, the sumps should be routinely monitored for evidence of fines being washed from the soil by seepage. If large quantities of fine-grained materials are found in the sumps, precautionary steps should be taken to make the lagging or sheeting watertight to avoid excessive settlements adjacent to the excavation.

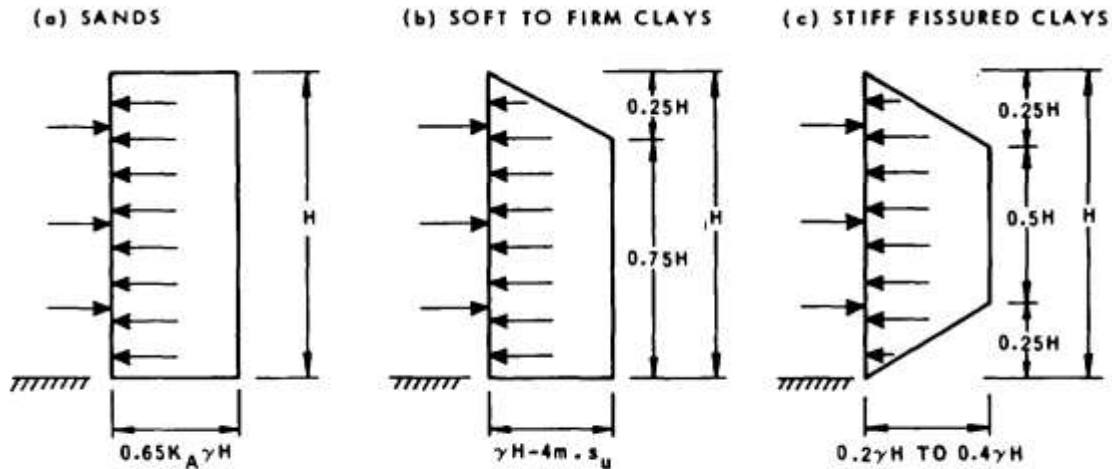

NOTES:

1. CHECK SYSTEM FOR PARTIAL EXCAVATION CONDITION
2. IF THE FREE WATER LEVEL IS ABOVE THE BASE OF THE EXCAVATION THE HYDROSTATIC PRESSURE MUST BE ADDED TO THE ABOVE PRESSURE DISTRIBUTION IN SANDS
3. IF SURCHARGE LOADINGS ARE PRESENT AT OR NEAR THE GROUND SURFACE THESE MUST BE INCLUDED IN THE LATERAL PRESSURE CALCULATION.
4. VALUES OF m ARE GIVEN IN PARAGRAPH 14-7.
5. γ = UNIT WEIGHT OF SOIL.
 s_u = UNDRAINED SHEAR STRENGTH.

Figure 11
 Pressure distribution – complete excavation

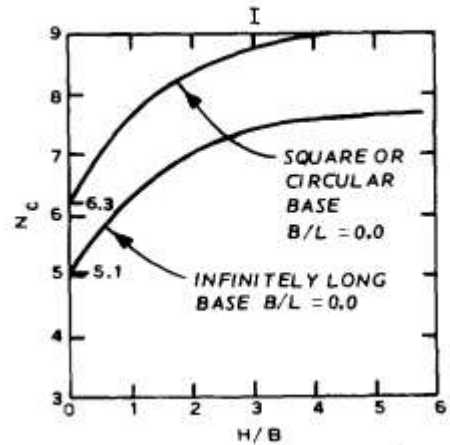
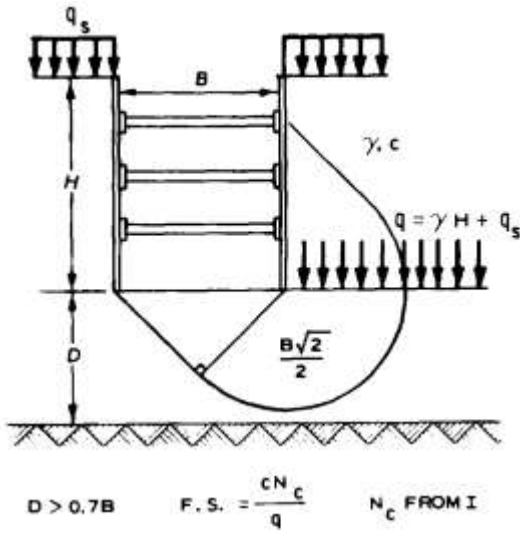

RECTANGULAR BASE $N_c = \left(1 + 0.2 \frac{B}{L}\right) N_c \text{ inf.}$
 WHERE L = LENGTH OF EXCAVATION

a.

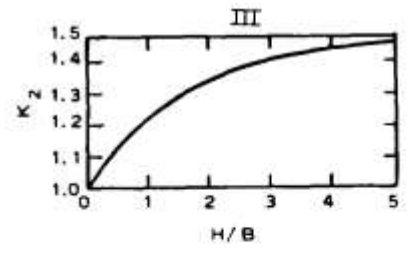
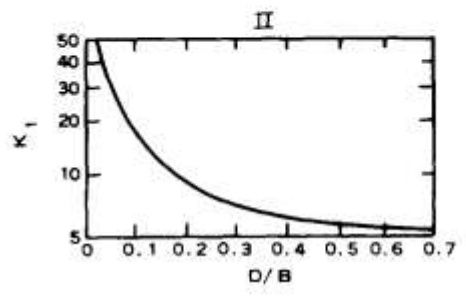
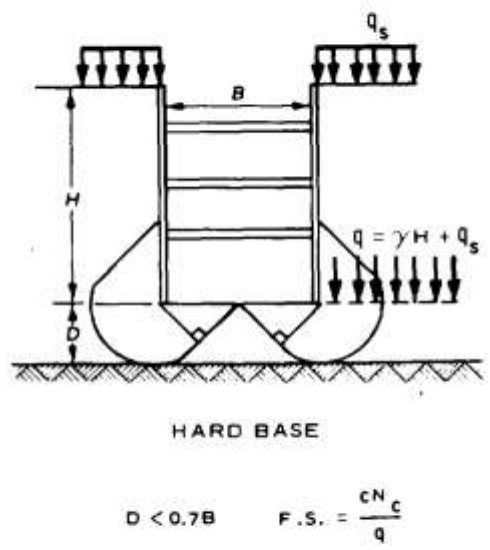

LONG EXCAVATION:
 $N_c \text{ inf.} = f(D/B, H/3) = K_1 K_2$
 RECTANGULAR EXCAVATION:
 $N_c = \left(1 + 0.2 \frac{B}{L}\right) N_c \text{ inf.}$

b.

Figure 12
 Stability of bottom of excavation in clay

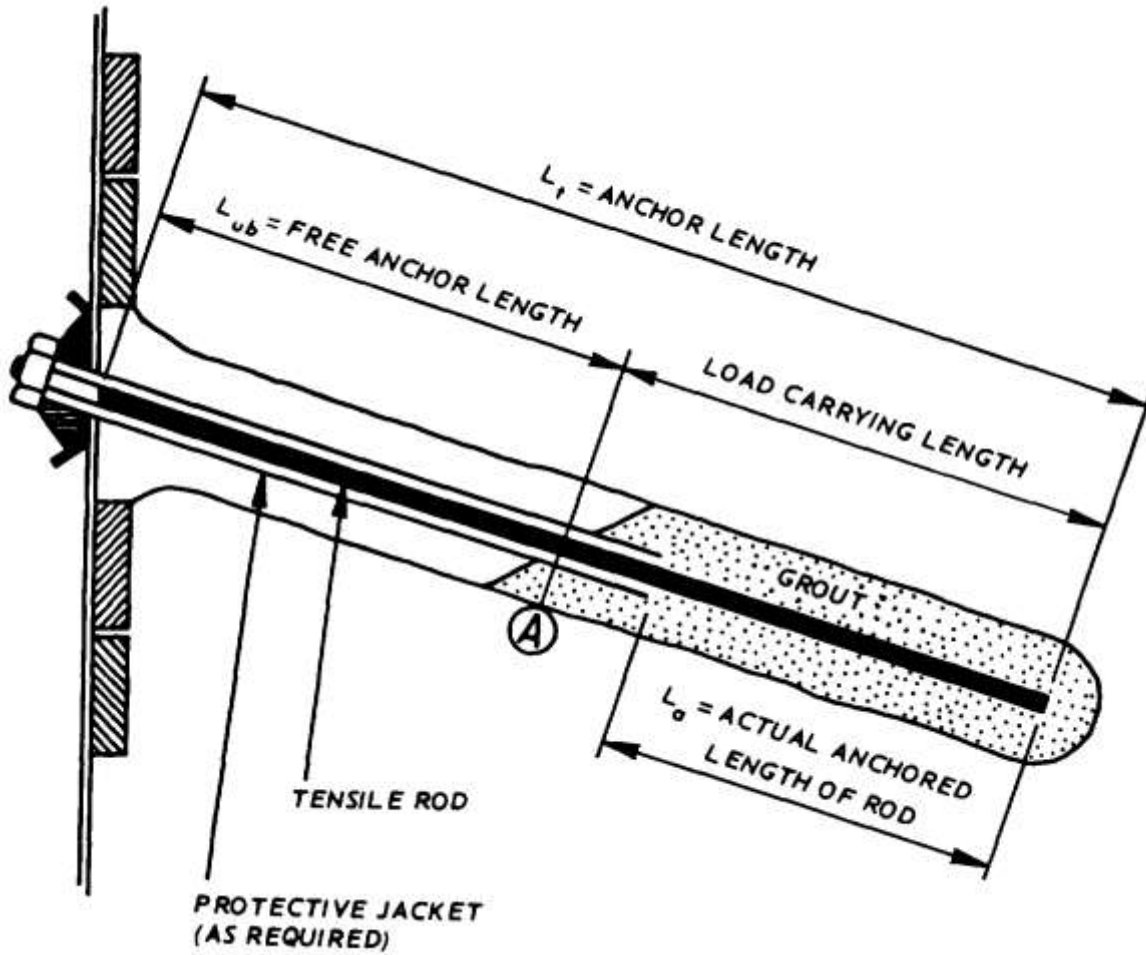
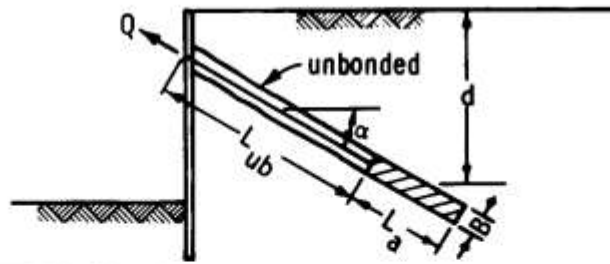

Figure 13
Typical tieback details

Case 1 - Straight Shaft Anchors



$$Q_u = \pi B (c_a + \sigma_n \tan \delta) L_a$$

- c_a = adhesion on shaft
- $c_a = s_u$ in clay with $s_u < 0.5$ tsf
- $c_a = 0.5$ tsf in clay with $s_u > 0.5$ tsf
- $c_a = 0$ in sand

δ = angle of frictional resistance at grout-soil interface
commonly $\delta \cong \phi$

B = diameter of hole for tremie or if hole was cased
= diameter computed from grout volume and L_a as

$$B = \sqrt{\frac{Vg}{0.7854 L_a}}$$

σ_n = normal stress on center of anchor; determine as per Mohr circle. If grouted anchor, σ_n may be higher

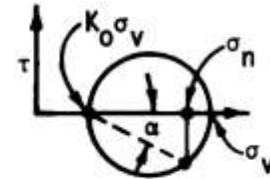

Vg = volume of grout in length L_a

Case 2 - Underreamed Anchor (Clays Only)

Drill case embedded to form seal

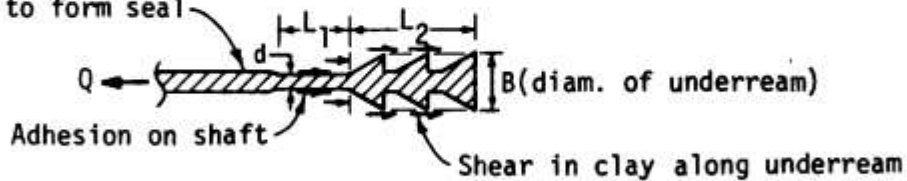

$$Q_u = \pi B L_2 s_u F_1 + \frac{\pi}{4} (B^2 - d^2) N_c s_u + \pi d L c_a$$

F_1 ranges from 1 to 0.75 depending upon amount of disturbance
 $N_c = 9$ (range of 5.7 to 9 depending on depth)

Figure 14
Methods of calculating anchor capacities in soil

9. ANCHORED WALLS.

9.1 TIEBACKS have supplanted both strut and raker systems in many instances to support wide excavations. The tieback (fig 13) connects the wall to an anchorage located in a zone where significant soil movements do not occur. The anchorage may be in soil or rock; soft clays probably present the only condition where an anchorage in soil cannot be obtained reliably. In figure 13, the distance L_{ub} should extend beyond the "Rankine" zone some distance. This distance is necessary, in part, to obtain sufficient elongation in anchored length of rod L_a during jacking so that soil creep leaves sufficient elongation that the design load is retained in the tendon. After jacking, if the soil is corrosive and the excavation is open for a long time, the zone L_{ub} may be grouted. Alternatively, the length of tendon L_{ub} is painted or wrapped with a grease impregnated wrapper (prior to placing in position).

9.2 THE TIEBACK TENDON may be either a single high-strength bar or several high-strength cables (f_y on the order of 200 to 270 kips per square inch) bunched. It is usually inclined so as to reach better bearing material, to avoid hole collapse during drilling, and to pass under utilities. Since only the horizontal component of the tendon force holds the wall, the tendon should be inclined a minimum.

9.3 TIEBACK ANCHORAGES may be drilled using continuous flight earth augers (commonly 4 to 7 inches in diameter) and may require casing to hold the hole until grout is placed in the zone L_a of figure 13, at which time the casing is withdrawn. Grout is commonly used under a pressure ranging from 5 to 150 pounds per square inch. Under-reaming may be used to increase the anchor capacity in cohesive soil. Belling is not possible in cohesionless soils because of hole caving. Typical formulas that can be used to compute the capacity of tieback anchorages are given in figure 14.

9.4 EXACT KNOWLEDGE OF THE ANCHOR CAPACITY IS NOT NEEDED as all the anchors are effectively "proof-tested" (about 120 to 150 percent of design load) when

the tendons are tensioned for the design load. One or more anchors may be loaded to failure; however, as the cost of replacing a failed anchor is often two to three times the cost of an initial insertion, care should be taken not to fail a large number of anchors in any-test program. If the tieback extends into the property of others, permission, and possibly a fee, will be required. The tieback tendons and anchorages should normally be left in situ after construction is completed. See table 3 for additional design considerations.