



# Technical Manual for Dam Owners

Impacts of Animals on Earthen Dams

FEMA 473 / September 2005



FEMA

Twenty-five states across the U.S. can write headlines of dam failure caused by nuisance wildlife intrusions, and many dam owners find the struggle to adequately manage nuisance wildlife at their dams a never-ending story. The Federal Emergency Management Agency (FEMA) has funded the development of this manual with the understanding that safe dam operation includes comprehensive, state-of-practice guidance on timely inspection and observation of wildlife damages, accurate wildlife identification and mitigation, and appropriate dam design, repair, and preventive measures. It is hoped that the information and methods contained in this manual will compose the core of dam management routines practiced by dam specialists across the country. Armed with education and diligence, dam specialists can prevent animal intrusion dam failure from becoming headline news.

No. 6

# Dam Safety Outlet



## DAM SAFETY PROGRAM

September 2002

Montana Department of Natural Resources and Conservation

---

### Rodent Hole Suspected Cause of Dam Failure in Garfield County

**A**n irrigation dam in Garfield County failed on June 23, 2002. The dam was located on Taylor Creek approximately 22 miles southeast of Jordan, Montana. The estimated capacity of the dam when filled to the emergency spillway crest was 1,000 acre-feet. The height of the dam was approximately 32 feet.

Flash flood warnings had been issued the previous night, with a total of 3 to 5 inches of rainfall expected in Garfield County. At 6:00 a.m. on Sunday, June 23, the dam owner went to see how much water had accumulated in the large reservoir. When he arrived, water was running through the emergency spillway and leaking through a gopher hole on the embankment (near the top portion). The owner promptly called all of his downstream neighbors. The water created a larger leak through this area and by 9:00 a.m. breached the embankment. There was no evidence of dam overtopping. Fortunately, downstream



*Taylor Creek Dam Failure - Photo by Candace Lindler, NRCS*

damage was minimal. Several gravel roads were washed out. Damage also occurred to a bridge on U.S. Highway 200. The basement of one house downstream was flooded. The dam failure also reportedly caused downstream stock dams to break. ◀

(Source: National Weather Service Report, Glasgow, Montana, U.S. Natural Resources and Conservation Service Engineering Trip Report, Glasgow, Montana)

# Technical Manual for Dam Owners

Impacts of Animals on Earthen Dams



FEMA



# Table of Contents

<b>1.0 Introduction and Purpose of Manual</b>	1
1.1 Background	1
1.2 Target Audience, Purpose, and Application of This Manual	2
1.3 Technical Resources Cited	3
<b>2.0 Impacts of Wildlife on Earthen Dams</b>	4
2.1 Background	4
2.2 Hydraulic Alteration	5
2.3 Structural Integrity Losses	6
2.4 Surface Erosion	6
<b>3.0 Dam Inspection From Two Perspectives: Engineering Function and Biological Potential</b>	8
3.1 Wildlife and the Earthen Dam	8
3.2 Two-Perspective Dam Inspection Methodology	9
3.2.1 Zone 1: Upstream Slope Area	9
3.2.2 Zone 2: Dam Crest Area	10
3.2.3 Zone 3: Upper Downstream Slope Area	12
3.2.4 Zone 4: Lower Downstream Slope Area	13
3.2.5 Zone 5: Downstream Toe Area	13
3.2.6 Zone 6: Spillway, Outlets, and General Areas	14
<b>4.0 Overview and Identification of Nuisance Wildlife</b>	15
4.1 The Importance of Accurate Wildlife Identification	15
4.2 Identifying Nuisance Wildlife	17
4.2.1 Muskrat Overview	17
4.2.2 Beaver Overview	19
4.2.3 Mountain Beaver Overview	22
4.2.4 Groundhog Overview	24
4.2.5 Pocket Gopher Overview	26
4.2.6 North American Badger Overview	29
4.2.7 Nutria Overview	31
4.2.8 Prairie Dog Overview	33
4.2.9 Ground Squirrel Overview	35
4.2.10 Armadillo Overview	37
4.2.11 Livestock Overview	39
4.2.12 Crayfish Overview	41
4.2.13 Coyote Overview	42
4.2.14 Moles and Voles Overview	44
4.2.15 River Otter Overview	47
4.2.16 Gopher Tortoise Overview	48
4.2.17 Red Fox and Gray Fox Overview	50
4.2.18 Canada Goose Overview	52
4.2.19 American Alligator Overview	54
4.2.20 Ants Overview	55
<b>5.0 Dam Repair and Intrusion Prevention Through Design</b>	57
5.1 Conformity to the Clean Water Act of 1972	57
5.2 The Role of Vegetation Management	58
5.3 Burrow Repair Procedures	58
5.3.1 Restoration Measures	58
5.3.2 Preventive Measures	59

5.4	Dam Repair Zones.....	59
5.4.1	Dam Repair Zone 1 .....	60
5.4.2	Dam Repair Zone 2 .....	62
5.4.3	Dam Repair Zone 3 .....	62
5.4.4	Dam Repair Zone 4 .....	63
5.4.5	Dam Repair Zone 5 .....	63
5.5	Professional Dam Safety Review .....	64
5.6	Sequenced Repair Program .....	64
5.7	Mitigation Through Design .....	64
5.7.1	Muskrat .....	64
5.7.2	Beaver .....	66
5.7.3	Mountain Beaver .....	68
5.7.4	Groundhog .....	68
5.7.5	Pocket Gopher .....	68
5.7.6	North American Badger.....	68
5.7.7	Nutria.....	68
5.7.8	Prairie Dog .....	68
5.7.9	Ground Squirrel .....	68
5.7.10	Armadillo .....	69
5.7.11	Livestock .....	69
5.7.12	Crayfish .....	69
5.7.13	Coyote.....	69
5.7.14	Mole and Vole.....	69
5.7.15	River Otter .....	69
5.7.16	Gopher Tortoise .....	70
5.7.17	Red and Gray Fox .....	70
5.7.18	Canada Goose.....	70
5.7.19	American Alligator .....	70
5.7.20	Ants .....	70
5.8	Monitoring .....	70
<b>6.0</b>	<b>Mitigating Damaging Wildlife .....</b>	<b>71</b>
6.1	Compliance with State and Federal Regulations.....	71
6.1.1	Conformity to Federal Regulations.....	71
6.1.2	Conformity to State Regulations.....	72
6.2	Muskrat Management Methods .....	73
6.2.1	Muskrat Control Through Habitat Modification .....	73
6.2.2	Muskrat Control Through Trapping .....	73
6.2.3	Muskrat Control Through Fumigants .....	75
6.2.4	Muskrat Control Through Toxicants .....	75
6.2.5	Muskrat Control Through Frightening .....	76
6.2.6	Muskrat Control Through Repellents .....	76
6.2.7	Muskrat Control Through Shooting .....	76
6.3	Beaver Management Methods.....	76
6.3.1	Beaver Control Through Habitat Modification .....	76
6.3.2	Beaver Control Through Trapping .....	76
6.3.3	Beaver Control Through Fumigants .....	77
6.3.4	Beaver Control Through Toxicants .....	77
6.3.5	Beaver Control Through Frightening .....	77
6.3.6	Beaver Control Through Repellents .....	77
6.3.7	Beaver Control Through Shooting.....	77

6.4	Mountain Beaver Management Methods .....	77
6.4.1	Mountain Beaver Control Through Habitat Modification .....	77
6.4.2	Mountain Beaver Control Through Trapping .....	77
6.4.3	Mountain Beaver Control Through Fumigants .....	77
6.4.4	Mountain Beaver Control Through Toxicants .....	78
6.4.5	Mountain Beaver Control Through Frightening .....	78
6.4.6	Mountain Beaver Control Through Repellents .....	78
6.4.7	Mountain Beaver Control Through Shooting .....	78
6.5	Groundhog Management Methods.....	78
6.5.1	Groundhog Control Through Habitat Modification .....	78
6.5.2	Groundhog Control Through Trapping .....	78
6.5.3	Groundhog Control Through Fumigants .....	78
6.5.4	Groundhog Control Through Toxicants .....	78
6.5.5	Groundhog Control Through Frightening .....	78
6.5.6	Groundhog Control Through Repellents .....	79
6.5.7	Groundhog Control Through Shooting .....	79
6.6	Pocket Gopher Management Methods.....	79
6.6.1	Pocket Gopher Control Through Habitat Modification .....	79
6.6.2	Pocket Gopher Control Through Trapping .....	79
6.6.3	Pocket Gopher Control Through Fumigants .....	80
6.6.4	Pocket Gopher Control Through Toxicants .....	80
6.6.5	Pocket Gopher Control Through Frightening.....	81
6.6.6	Pocket Gopher Control Through Repellents .....	81
6.6.7	Pocket Gopher Control Through Shooting .....	82
6.7	North American Badger Management Methods.....	82
6.7.1	North American Badger Control Through Habitat Modification .....	82
6.7.2	North American Badger Control Through Trapping .....	82
6.7.3	North American Badger Control Through Fumigants .....	82
6.7.4	North American Badger Control Through Toxicants .....	82
6.7.5	North American Badger Control Through Frightening .....	82
6.7.6	North American Badger Control Through Repellents .....	82
6.7.7	North American Badger Control Through Shooting .....	82
6.8	Nutria Management Methods.....	82
6.8.1	Nutria Control Through Habitat Modification .....	82
6.8.2	Nutria Control Through Trapping .....	83
6.8.3	Nutria Control Through Fumigants .....	83
6.8.4	Nutria Control Through Toxicants .....	83
6.8.5	Nutria Control Through Frightening .....	83
6.8.6	Nutria Control Through Repellents .....	83
6.8.7	Nutria Control Through Shooting .....	84
6.9	Prairie Dog Management Methods.....	84
6.9.1	Prairie Dog Control Through Habitat Modification .....	84
6.9.2	Prairie Dog Control Through Trapping .....	84
6.9.3	Prairie Dog Control Through Fumigants .....	84
6.9.4	Prairie Dog Control Through Toxicants .....	85
6.9.5	Prairie Dog Control Through Frightening.....	85
6.9.6	Prairie Dog Control Through Repellents .....	85
6.9.7	Prairie Dog Control Through Shooting .....	85
6.10	Ground Squirrel Management Methods .....	85

6.10.1	Ground Squirrel Control Through Habitat Modification .....	86
6.10.2	Ground Squirrel Control Through Trapping .....	86
6.10.3	Ground Squirrel Control Through Fumigants .....	86
6.10.4	Ground Squirrel Control Through Toxicants .....	86
6.10.5	Ground Squirrel Control Through Frightening .....	87
6.10.6	Ground Squirrel Control Through Repellents .....	87
6.10.7	Ground Squirrel Control Through Shooting .....	87
6.11	Armadillo Management Methods .....	87
6.11.1	Armadillo Control Through Habitat Modification .....	87
6.11.2	Armadillo Control Through Trapping .....	87
6.11.3	Armadillo Control Through Fumigants .....	88
6.11.4	Armadillo Control Through Toxicants .....	88
6.11.5	Armadillo Control Through Frightening.....	88
6.11.6	Armadillo Control Through Repellents .....	88
6.11.7	Armadillo Control Through Shooting .....	88
6.12	Livestock (Cow, Sheep, Horse, Pig, and Wild Pig) Management Methods .....	88
6.12.1	Livestock Control Through Habitat Modification .....	88
6.12.2	Livestock Control Through Trapping .....	88
6.12.3	Livestock Control Through Fumigants .....	89
6.12.4	Livestock Control Through Toxicants .....	89
6.12.5	Livestock Control Through Frightening .....	89
6.12.6	Livestock Control Through Repellents .....	89
6.12.7	Livestock Control Through Shooting .....	89
6.13	Crayfish Management Methods .....	89
6.13.1	Crayfish Control Through Habitat Modification .....	89
6.13.2	Crayfish Control Through Trapping .....	89
6.13.3	Crayfish Control Through Fumigants .....	89
6.13.4	Crayfish Control Through Toxicants .....	89
6.13.5	Crayfish Control Through Frightening.....	89
6.13.6	Crayfish Control Through Repellents.....	89
6.13.7	Crayfish Control Through Shooting.....	89
6.14	Coyote Management Methods.....	89
6.14.1	Coyote Control Through Habitat Modification .....	89
6.14.2	Coyote Control Through Trapping .....	89
6.14.3	Coyote Control Through Fumigants .....	90
6.14.4	Coyote Control Through Toxicants .....	90
6.14.5	Coyote Control Through Frightening .....	90
6.14.6	Coyote Control Through Repellents .....	90
6.14.7	Coyote Control Through Shooting .....	90
6.15	Mole and Vole Management Methods .....	90
6.15.1	Mole and Vole Control Through Habitat Modification .....	90
6.15.2	Mole and Vole Control Through Trapping .....	90
6.15.3	Mole and Vole Control Through Fumigants .....	91
6.15.4	Mole and Vole Control Through Toxicants .....	91
6.15.5	Mole and Vole Control Through Frightening .....	91
6.15.6	Mole and Vole Control Through Repellents .....	91
6.15.7	Mole and Vole Control Through Shooting .....	91
6.16	River Otter Management Methods .....	91



6.16.1	River Otter Control Through Habitat Modification .....	91
6.16.2	River Otter Control Through Trapping .....	92
6.16.3	River Otter Control Through Fumigants .....	92
6.16.4	River Otter Control Through Toxicants .....	92
6.16.5	River Otter Control Through Frightening .....	92
6.16.6	River Otter Control Through Repellents .....	92
6.16.7	River Otter Control Through Shooting .....	92
6.17	Gopher Tortoise Management Methods .....	92
6.17.1	Gopher Tortoise Control Through Habitat Modification .....	92
6.17.2	Gopher Tortoise Control Through Trapping .....	92
6.17.3	Gopher Tortoise Control Through Fumigants .....	92
6.17.4	Gopher Tortoise Control Through Toxicants .....	92
6.17.5	Gopher Tortoise Control Through Frightening .....	92
6.17.6	Gopher Tortoise Control Through Repellents .....	92
6.17.7	Gopher Tortoise Control Through Shooting .....	92
6.18	Red Fox and Gray Fox Management Methods .....	93
6.18.1	Red Fox and Gray Fox Control Through Habitat Modification .....	93
6.18.2	Red Fox and Gray Fox Control Through Trapping .....	93
6.18.3	Red Fox and Gray Fox Control Through Fumigants .....	93
6.18.4	Red Fox and Gray Fox Control Through Toxicants .....	93
6.18.5	Red Fox and Gray Fox Control Through Frightening .....	93
6.18.6	Red Fox and Gray Fox Control Through Repellents .....	93
6.18.7	Red Fox and Gray Fox Control Through Shooting .....	93
6.19	Canada Goose Management Methods .....	93
6.19.1	Canada Goose Control Through Habitat Modification .....	93
6.19.2	Canada Goose Control Through Trapping .....	94
6.19.3	Canada Goose Control Through Fumigants .....	94
6.19.4	Canada Goose Control Through Toxicants .....	94
6.19.5	Canada Goose Control Through Frightening .....	94
6.19.6	Canada Goose Control Through Repellents .....	95
6.19.7	Canada Goose Control Through Shooting .....	95
6.19.8	Other Methods of Canada Goose Control .....	95
6.20	American Alligator Management Methods .....	95
6.20.1	American Alligator Control Through Habitat Modification .....	95
6.20.2	American Alligator Control Through Trapping .....	95
6.20.3	American Alligator Control Through Fumigants .....	95
6.20.4	American Alligator Control Through Toxicants .....	95
6.20.5	American Alligator Control Through Frightening .....	95
6.20.6	American Alligator Control Through Repellents .....	95
6.20.7	American Alligator Control Through Shooting .....	96
6.21	Ant Management Methods .....	96
6.21.1	Ant Control Through Habitat Modification .....	96
6.21.2	Ant Control Through Trapping .....	96
6.21.3	Ant Control Through Fumigants .....	96
6.21.4	Ant Control Through Toxicants .....	96
6.21.5	Ant Control Through Frightening .....	96
6.21.6	Ant Control Through Repellents .....	96
6.21.7	Ant Control Through Shooting .....	96

<b>7.0 Fiscal Considerations for Managing Animal Damage on Earthen Dams</b> .....	97
7.1 Fiscal Considerations for the Reluctant Dam Owner.....	97
7.2 Fiscal Considerations of the Willing Dam Owner.....	97
7.3 Overcoming the Economic Hurdles.....	98
<b>8.0 References</b> .....	102
<b>Appendix A</b> .....	105
<b>Appendix B</b> .....	109

# 1.0 Introduction and Purpose of Manual

An aerial photograph of a large dam and reservoir, with a winding road visible on the right side of the dam structure. The water is a deep blue, and the surrounding land is green and brown.

## 1.1 Background

In 1999, the Federal Emergency Management Agency (FEMA) and the Association of State Dam Safety Officials (ASDSO) jointly conducted research and a workshop to shed light on the national problem of animal intrusion damage to earthen dams and the resulting safety issues. The FEMA/ASDSO survey and workshop united dam owners, engineers, state and federal regulators, wildlife managers, foresters, and academia to form an educated and experienced front against the growing problem of earthen dam damage and failures due to animal intrusion. The information generated by roundtable discussions and survey answers indicates that while most states recognize animal intrusion as a problem, only a handful know of guidance on dams and wildlife management practices available to the dam professionals and owners. Based on input from the dam communities, FEMA/ASDSO's mission to develop a guidance manual on the proper management of nuisance wildlife in the earthen dam environment became clear.

To determine the information needs of the dam community—and therefore the most appropriate focus of this manual—FEMA/ASDSO issued a survey in 1999 and used the survey input from the 48 state dam safety officials

representatives and 11 federal agencies representing the Interagency Committee on Dam Safety (ICODS). Additionally, a second survey was issued in 2003 to identify the current needs of each state, determine what nuisance wildlife and damages the states encounter, and understand which mitigation methods are being used with success or failure. Four main ideas emerged from the two survey efforts; these ideas consequently steered the direction of this manual:

- Cumulatively, the states indicated a range of problems caused by numerous wildlife species relative to the operation of dams. This manual discusses 23 species with regard to their habitat, behavior, threat to dams, food habits, identifying characteristics, and management options: Muskrat, Beaver, Mountain Beaver, Groundhog, Pocket Gopher, North American Badger, Nutria, Prairie Dog, Ground Squirrel, Armadillo, Livestock (cow, sheep, horse, pig and wild pig), Crayfish, Coyote, Moles and Voles, River Otter, Gopher Tortoise, Red Fox and Gray Fox, Canada Goose, American Alligator, and Ants.
- While the states are fully aware of the potential adverse impacts wildlife activity can have on earthen dams (such as failure), private dam owners and local dam operators are often not aware of potential problems, and thus may

25: number of states that indicate animal activity has caused or contributed to unsafe dam operation or outright failure within the state.

9: number of states aware of information or guidance on the effects of animal activity on dams.

not conduct inspections with wildlife damage in mind. Local dam owners may not typically mitigate existing wildlife intrusion problems or prevent them in the future.

- States want to know how other states are successfully mitigating wildlife damages. Further, mitigation and prevention guidance should be developed and conveyed to the dam communities.
- Guidance booklets for local dam owners are needed to assist dam inspectors in identifying and mitigating animal intrusion issues.

Out of 48 states that responded to FEMA and ASDSO surveys, 25 document nuisance animals as the cause of dam failures or unsafe dam operations in their states. The U.S. Bureau of Reclamation, the National Park Service, and the U.S. Department of Agriculture document several similar cases at the federal level. State dam safety officials and federal agencies agree that animal burrows within dams can cause substantial and costly damage if left unmitigated and are consequently a major concern.

## 1.2 Target Audience, Purpose, and Application of This Manual

This manual provides technical guidance to dam specialists (including dam owners, operators, inspectors, state dam officials, and consulting engineers) in areas of focus identified through the two survey efforts and workshop. The purposes of this manual are to:

- Assist dam specialists in understanding the impacts wildlife can have on earthen dams.
- Provide dam specialists with basic information on habitat, range, description, and behavior of common nuisance wildlife to aid in their proper identification at the dam.
- Describe state-of-practice methods to prevent and mitigate adverse wildlife impacts on earthen dams.
- Provide state-of-practice design guidance for repair and preventive design associated with nuisance wildlife intrusion.

It is envisioned that the entire dam specialist community will use this manual to augment their routine duties in earthen dam management. This manual is presented as a process toward dam inspection and management that includes wildlife damage identification and control. This manual provides technical information and guidance on:

- How wildlife damage adversely affects the safe operation of earthen dams; specifically, hydraulic alteration, internal and external erosion, and structural integrity losses (Chapter 2.0).
- Dam inspections that incorporate a biological component to sensitize dam specialists to the aspects of their dams that attract wildlife and to understand where nuisance wildlife are likely to occur on the dam (Chapter 3.0).
- Biological data for specific nuisance wildlife to assist the dam specialist in identifying which nuisance wildlife inhabits the dam. Biological data will also assist in controlling nuisance wildlife (e.g., listed food sources can be removed to encourage the animal to leave the area) (Chapter 4.0).

- Dam design specifications and methods that can be incorporated into repair of existing dams or new dam designs to prevent wildlife intrusions (Chapter 5.0).
- Guidelines to determine when wildlife management should occur at a dam (beyond dam repair and prevention actions) and wildlife management methods that can be implemented when control of specific nuisance wildlife populations is deemed necessary. Specific methods discussed include habitat modification, use of toxicants and fumigants, trapping, and shooting (Chapter 6.0).
- The fiscal issues related to appropriate and timely wildlife management at earthen dams (Chapter 7.0).

### 1.3 Technical Resources Cited

The technical information provided in this manual represents the most current practices in the areas of wildlife data and management and engineering inspection and repair, as they relate to nuisance wildlife and their effects on safe dam operations. While numerous technical sources are cited throughout the document, three main sources form the backbone of this manual's technical understanding and recommendations. The first source is a manual titled *Prevention and Control of Wildlife Damage* (University of Nebraska, 1994). The data contained in the 1994 manual are considered the industry standard for pest control, and the manual is used as the handbook for those testing for licensure as pest control managers. It should be noted that the 1994 manual is under revision and a revised version will be completed February 2005. Until the release of the revised manual, the 1994 edition remains the leading guidance literature in this field and is accepted as the most current practice in nuisance wildlife management (Smith, Pers. comm., 2003; 2004). The second source is a booklet called *Prevention and Control of Animal Damage to Hydraulic Structures* (USDA, 1991). The 1991 booklet adapts some of the 1994 manual data for application to the dam environment. The last source is technical data on remedial dam repair design by Dr. B. Dan Marks, as presented in the 2001 ASDSO West Region Seminar on Plant and Animal Penetrations for Earthen Dams (ASDSO, 2001). Many other sources are also used throughout this manual to provide a cross-reference of data as well as a broad spectrum of information.

# 2.0 Impacts of Wildlife on Earthen Dams

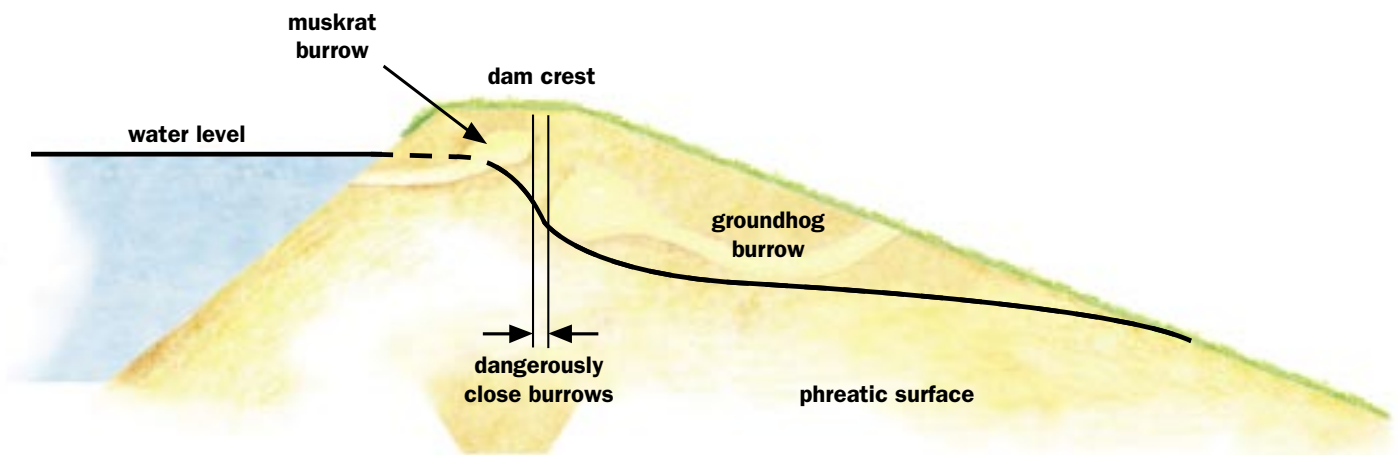

Figure 2-1. Upstream and downstream burrows can become dangerously close, causing internal erosion that may lead to dam failure.

Earthen embankment dams are used by private landowners and state and federal agencies to store farm water supplies, city water supplies, recreational waters, flood waters, and wastewater lagoons. Earthen dams rely on a thick placement of compacted soils to withstand the water pressure of the pool contained behind the embankment. Often constructed outside of developed areas, the earthen dam environment is usually near a water source and can contain a variety of vegetation; given these characteristics, earthen dam environments can be naturally conducive to use by wildlife. Wildlife inhabiting the dam can alter the dam environment through habitat establishment and use—beaver build dams, muskrat excavate dens, livestock feed on stabilizing vegetation. The natural instincts of wildlife to adapt and use their environment toward their survival can compromise the balance of engineered functions that maintain the viability of an earthen dam.

The first step in fortifying a dam against unsafe operations caused by wildlife damage is to understand what could go wrong if wildlife damage is left unchecked. While a dam owner may observe a few small burrows on the upstream and downstream slopes, it is important to understand that potential problems, like those burrows, often run deep

below the surface. As such, the purpose of this Chapter is to discuss adverse engineering effects stemming from nuisance wildlife activity. Adverse effects caused by specific wildlife (as well as their identification and mitigation) are discussed in Chapters 4.0, 5.0, and 6.0.

## 2.1 Background

Embankment dams are vulnerable to damage from wildlife intrusions. Twenty-five states indicate that animal activity has caused or contributed to unsafe operation or outright failure of an embankment dam. Several animal species excavate burrows, tunnels, and den entrances for shelter, while other predatory animals will enlarge these structures via digging in search of prey. Similarly, herbivorous species will forage on vegetation growing on embankment dams. All of these occurrences create open areas in the embankment fill which are detrimental to the safety and performance of embankment dams. Some of these effects can be easily identified, such as surface erosion; other effects such as internal erosion may not become visible until dam safety is jeopardized.

*Homogeneous and zoned embankment dams are equally susceptible to damage from animal intrusions. The ultimate consequence from the intrusions depends on the specific engineering and biological characteristics of an individual dam.*

Embankment dams can be generally categorized as either homogeneous (containing one material) or zoned (containing multiple materials). Zoned embankment dams usually contain a central core designed to produce a lower phreatic surface (static water level within a dam embankment) within the downstream slope than the theoretical surface often assumed for homogeneous embankments. Due to the variability of zoned embankments, this manual discusses only homogeneous embankments.

## 2.2 Hydraulic Alteration

The most significant and often least obvious impact of wildlife intrusions on embankment dams is hydraulic alteration. Hydraulic alteration and its effects can manifest in different ways depending on the type and location of intrusion, including flownet distortion and physical barriers to flow.

A distorted flownet may not be a visible problem but it can have the most dramatic impact. Flownet is a term referring to the theoretical description of water flow through and under an embankment dam. The phreatic surface, equal potential lines and flow lines associated with a flownet are defined by the physical dimensions of the dam, classification

of soils in the dam, and variability of the reservoir normal pool. As such, each dam has a unique flownet. The presence of animal burrows, either on the upstream or downstream slope, can distort the established phreatic surface and impact the flownet. As illustrated on Figure 2-2, upstream burrows can allow the normal pool elevation to extend into the dam embankment, forcing the phreatic surface further into the embankment. Likewise, downstream intrusions can allow the phreatic surface to day-light higher on the downstream slope. The overall effect can be a significant alteration to the phreatic surface. Dramatic changes to the phreatic surface can shorten seepage paths, increase seepage volumes, decrease the factor of safety against slope failure, and cause internal erosion of embankment materials (piping).

Of these impacts, piping is most often cited as the greatest concern among dam safety professionals because it is progressive and can rapidly lead to failure of the dam. Piping is the uncontrolled movement of soil particles caused by flowing water. As shown on Figure 2-3, piping will often start in a burrow on the downstream slope. Flowing water moves soil particles from the embankment to the burrow, leaving a void that is quickly filled with soil particles from deeper within the embankment. Because water pressure and flow generally increase further into the dam embankment, the rate of movement of soil particles will also increase. A pipe is rapidly formed extending from the downstream slope to the upstream slope. A dam breach is almost certain to develop in these instances.

External problems can also arise from wildlife activity around an embankment dam. Though hydraulic barriers can result from the activities of several species, beaver cause perhaps the largest array of adverse effects. To create deep waters in which to hide from predators, beavers compact felled tree trunks, limbs, and other materials into a mound to restrict the natural flow of a water source. As a result, the hydraulic function of the dam is altered in several ways. First, beaver mounds may block principal and emergency spillways and riser outlets, resulting in increased normal pool levels and reduced spillway discharge capacity. Second, sudden high discharges from the dam could occur if the beaver dam fails. Third, beaver dams located upstream of the embankment dam can clog water control structures as debris from the beaver dam floats downstream. Finally, erosion of the downstream toe of the dam can occur as a result of elevated tailwater caused by beaver activity.

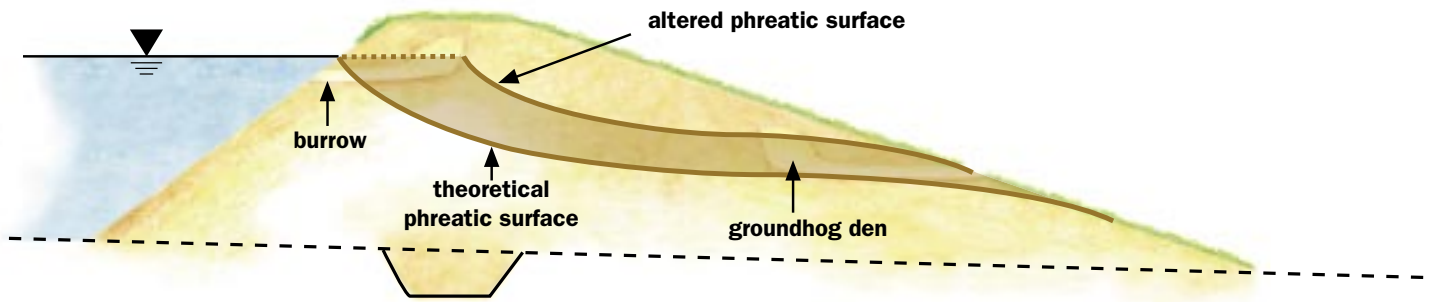

Figure 2-2. Burrows can alter dam hydraulics by shortening seepage paths.

### 2.3 Structural Integrity Losses

Wildlife excavate dens, burrows, and tunnels within embankment dams, causing large voids that weaken the structural integrity of the dam. Typical voids can range from the size of a bowling ball to a beach ball and much larger. Heavy rain and snow melt loosen soils surrounding a burrow, causing a localized collapse inside the burrow. In addition, a burrowing animal may encounter loose zones in the embankment (due to variability of constructed embankments) during burrow excavation, leading to a localized collapse. Animal dens also erode and collapse under the load of heavy equipment and other vehicles that use the crest of the dam as a throughway.

The collapsing soils will progressively lead to sinkholes or depressions appearing on the embankment surface. Because burrows can be under several feet of soil, the deformation or sinkhole visible at the surface could be several times the size of the original burrow. As illustrated on Figure 2-4, the collapsed soils can represent a significant portion of the

dam embankment. Under the right circumstances, localized slope instability can result from a collapsed animal burrow. Depending on the location and number of collapsed burrows, dam safety or operation could be jeopardized. If portions of the crest are affected, a loss of freeboard can result, thus endangering the dam during storm events. Downstream slope failures, regardless of their extent, weaken embankment soils and reduce confinement of surrounding soils, thereby resulting in further weakening of embankment soils. Depending upon site and weather conditions, the process can progress slowly or rapidly, potentially leading to massive slope instability.

### 2.4 Surface Erosion

The foraging behavior of some animals on open area vegetation associated with dam embankments can reduce or eliminate vegetative cover on a dam. This increased feeding pressure on the dam's vegetative groundcover can lead to erosion paths and decreased soil retention on the dam's crest and slope. In addition, dams that are grazed by live-

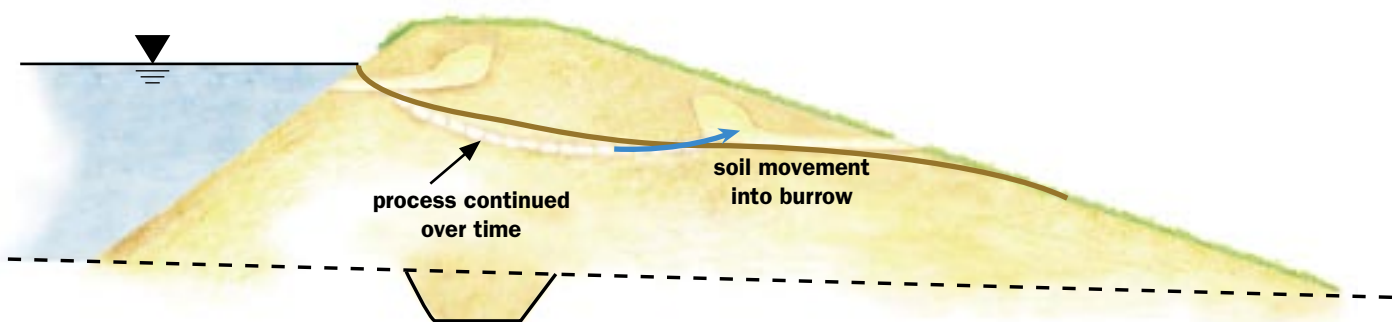

Figure 2-3. Burrows can lead to piping within an embankment.



stock often show increased rates of soil erosion because of the lack of stabilizing vegetation from grazing and trafficking, which can lead to irregular surface erosion and the formation of rills and gullies.

With continued neglect, these areas will require more than simple maintenance. In fact, given enough time, external erosion can lead to a reduction in freeboard and loss of cross section. In turn, these impacts can increase the dam's vulnerability to damage from high water during large storm events.

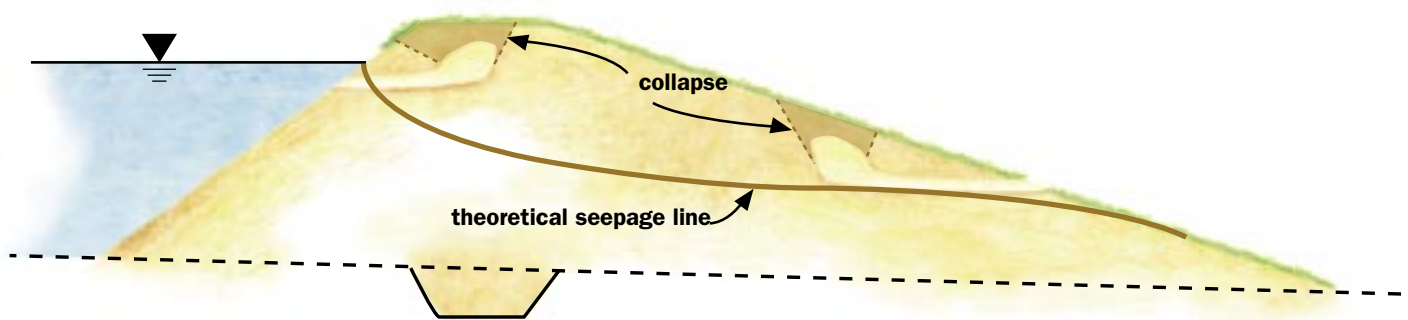

Figure 2-4. Burrows can collapse, leading to formation of sinkholes and loss of structural integrity.



# 3.0 Dam Inspection From Two Perspectives: Engineering Function and Biological Potential

The second step toward fortifying a dam against the effects of nuisance wildlife damage is the observation of clues left by wildlife in the dam environment. As such, regular inspection of the dam that incorporates wildlife activity recognition must be conducted by the dam owner, who is the first line of defense in protecting earthen dams. While the dam inspection is focused primarily on seepage, deformation, and structural deficiencies, the inspectors must also perceive wildlife clues left behind by dam inhabitants whose presence could cause trouble down the road. Toward this goal, this Chapter details an inspection procedure that pairs engineering inspection with key biological considerations to assist the dam specialist in viewing the dam from both perspectives (this methodology should be applied using the specific wildlife clues data presented in Chapter 4.0 of this manual).

## 3.1 Wildlife And The Earthen Dam

Through their natural desire to create dens, search for food, or escape predators, wildlife can cause a host of adverse impacts to an earthen dam which can lead to dam failure (refer to Chapter 2.0 of this manual for detail on the adverse impacts of wildlife activities). Though earthen dams are

manmade, wildlife interacts with the earthen dam environment as if it were natural field or forest. To protect their dams, dam owners should know the biological potential of their dams—can wildlife find a suitable environment at the dam, and if so, which kind of wildlife will inhabit which locations of the dam? In answering these questions, it is helpful to know the characteristics that compose favorable habitat, and to realize that dams with diverse vegetation and site features often support a wide variety of wildlife. In assessing the dam for its biological potential, review the following relative to the dam area and surrounding areas (adapted from Benyus, 1989):

- **Vegetation Vitality:** Do the dam and adjacent areas contain dense vegetation at all levels (e.g., grass, shrub, and tree)? In general, greater variety of dense vegetation at levels ranging from groundcover to understory to canopy (regardless of vegetation type) allows for a greater variety of wildlife to inhabit the area. Small mammals, such as those discussed in this manual, prefer sites with adequate vegetation cover to hide from predators (see Chapter 5.2 for a discussion on appropriate vegetation at a dam).

- **Mini-habitats:** Do the dam and surrounding area offer vegetative diversity? Different landscapes such as prairie and forest? Sun and shade? Deep and shallow water? An environment with a mosaic landscape provides several habitat types in one area, which can support a wider variety of wildlife.
- **Transition Zones:** Is there a clear edge between one habitat type and another? At the dam environment, the dam area (a lake/pond environment) may be surrounded by a grassy field environment, a shrub edge, or a forested environment. The junction where two environments meet is called an edge, and edges are the most heavily trafficked areas in an environment (a good place to view the wildlife in and around the dam area) because they provide safe travel corridors between the two habitat types and create a more diverse habitat than either of the two habitat types.
- **Size:** Does the dam environment provide a large land area that allows wildlife to meander without having to cross roadways or come into contact with people? Most species of wildlife prefer large parcels of land that provide habitat variety without human influence.
- **Unique Characteristics:** Does the dam contain unique land features? By its very nature, the dam environment is unique because it contains a water source. Wildlife prefers a constant water source, so dams with a permanent pool will be preferable to those with a fluctuating pool, such as those used for flood control or irrigation. However, any water source will attract wildlife to some degree.

### 3.2 Two-Perspective Dam Inspection Methodology

The typical dam safety inspection checklist requires observation of every dam feature. The checklist is developed by an individual state's dam safety program or federal organization such as the U.S. Bureau of Reclamation, U.S. Army Corps of Engineers, U.S. Fish and Wildlife Service, or the Federal Energy Regulatory Commission. All inspections focus on distinct physical regions, although the inspection checklists vary in length, listed inspection items, and required observations. Generally, the features are divided into clear components including:

- Upstream Slope
- Downstream Slope
- Crest

- Embankment-Abutment Contact (Groin)
- Principal Spillway
- Emergency Spillway
- Lake Drain or Outlet Works

Although inspection for animal intrusions is a facet of most if not all state inspection checklists, it is certainly not a major part of the inspection. Specific guidance on identifying animal intrusions or the typical intrusion locations of specific animals is not provided on the checklists. An inspector lacking this information may be unable to adequately inspect their dam for animal intrusions, much less adequately identify and mitigate the nuisance animal. As such, this manual presents an inspection methodology that combines engineering and biological considerations, which when viewed together, allow a dam specialist to view the dam comprehensively.

For the purposes of this manual, the dam is divided into six zones: Upstream Slope, Dam Crest, Upper Downstream Slope, Lower Downstream Slope, Downstream Toe, and Spillway, Outlets, and General Areas (Figure 3-1). The risk posed by animal intrusions is greater in some zones than in others. As such, the zones are overlapped to emphasize the critical nature of the area and to require inspection of the area twice to ensure that biological clues are sighted (ASDSO, 2001). Further discussion of the six zones relative to risk, restoration, and repair of animal intrusions is provided in Chapters 5.3 and 5.4.

When considering animal intrusions, inspection of each zone should consider not only physical evidence of an animal presence (e.g., burrow entrance), but also the habitat and biological factors that attract wildlife to the dam and sustain them once they have become established (Figure 3-2). Understanding both the engineering and biological aspects of animal intrusions into embankment dams is critical in eliminating or at least controlling the intrusions.

#### 3.2.1 Zone 1: Upstream Slope Area

**Engineering Perspective:** The goal of inspecting the upstream slope of the earthen dam is to see the entire surface clearly. To ensure the inspector views the entire slope surface, the inspector must walk back and forth across the slope utilizing one of two patterns: zig-zag or parallel. In general, the zig-zag method is best for small dams and mild slopes (Figure 3-3, shown on page 17). It may prove difficult to move in a zig-zag pattern on large dams and steeper slopes, and in these cases the parallel pattern is suggested (Figure 3-4, shown on page 17).

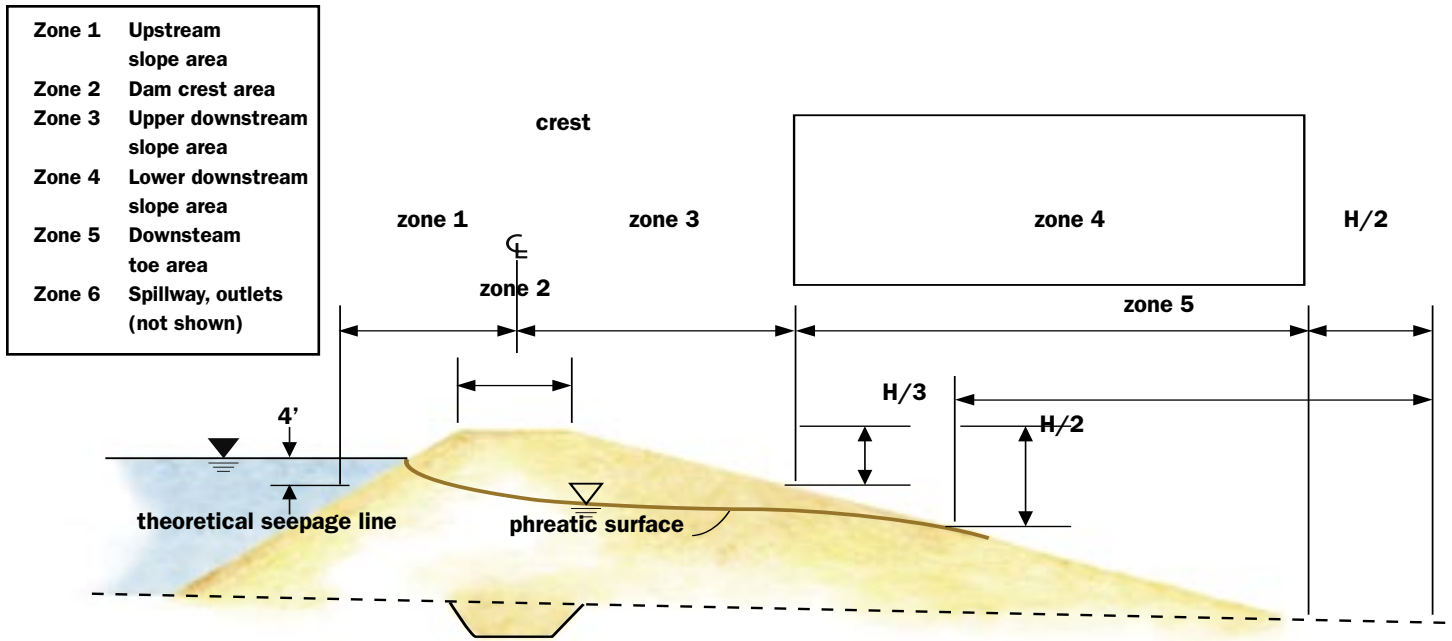

Figure 3-1. Dam Inspection Zones.

While walking the slope, the inspectors should routinely stop and view the alignment of the surface by turning their gaze a full 360 degrees. Checking the slope frequently and from many viewpoints and distances can reveal deficiencies and distortions (such as surface distortions or vegetation changes) that might otherwise go undetected. The inspectors should observe berms on the upstream slope by centering their eyes on the line being viewed and moving their body from side to side to view the line from several angles. This approach will help the inspector identify misalignments.

A typical dam safety inspection report should comment on vegetation, slope protection, erosion, instabilities, and animal burrows observed in Zone 1. When specifically considering animal burrows and other deficiencies resulting from animal activity, the inspector should look for the following: animal burrow entrances, mounds of excavated soil, debris (evidence of beaver activity), cracks, depressions, erosion, sinkholes, paths and ruts, sloughs, slides, and scarps. These conditions often indicate damaging animal activity. The inspection report should note whether the deficiencies warrant monitoring, repair, or further investigation.

**Biological Perspective:** This zone is primary habitat for aquatic burrowers such as muskrat and beaver, which generally burrow from 6 inches to 4 feet below the water line upward toward the crest. Nutria prefer to dig dens in the zone where land and water meet, which could be dominated by aquatic vegetation. River otters are often found living in abandoned muskrat, beaver, and nutria burrows, and can construct slides on slopes and bare areas where they repeatedly enter and exit the water. Livestock often traverse the upstream slope area—look for hoof tracks, rills, and eroded pathways. Canada geese and livestock feed on embankment slopes causing eroded areas and ruts. Crayfish and alligator may inhabit the banks and shallows of the upstream slope area. Ants may dig tunnels in the slope, loosening existing cracks. Mountain beaver or armadillo may be found along the wet edge of the pond, especially if a forest fringe or wooded area is nearby. Moles may hunt in the moist soils near the reservoir.

### 3.2.2 Zone 2: Dam Crest Area

**Engineering Perspective:** Similar to inspecting the upstream slope, the crest can be viewed using either a zig-zag or parallel pattern, with the primary goal being to view the

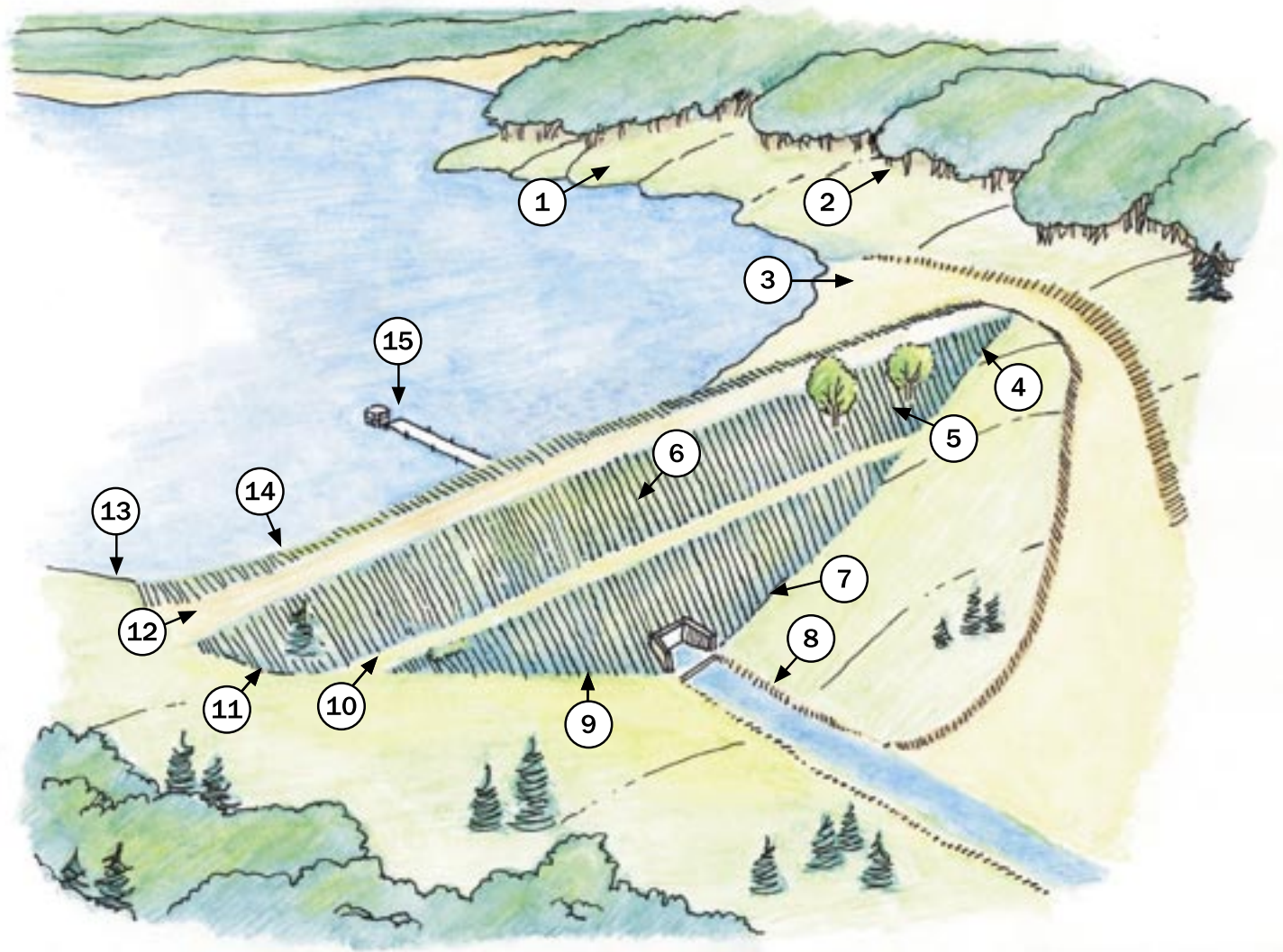

Figure 3-2. The Earthen Dam from Biological and Engineering Perspectives.

- 1. Upland Areas.** Many species live in the upland areas, away from the water. Even the downstream slope, abutments, and groin areas of the dam can be considered upland in terms of habitat.
- 2. Forest Fringe.** The zone between two environments (the edge) is the best place to observe those species living at and around the dam. The more habitat types at the dam, the greater number of species likely to inhabit the dam. Mountain beaver or armadillo prefer forested/wooded areas.
- 3. Emergency Spillway.** Beaver often dam the spillway, causing the pond water levels to rise.
- 4. Left Abutment contact.**
- 5. Inappropriate Vegetation on Embankment.** Many dams contain vegetation other than mowed grass. Improper vegetation provides cover and food supply, which encourage animals to inhabit the dam.
- 6. Downstream Slope.** This area is often the location where groundhogs, coyote, and fox excavate burrows. Canada geese will feed on the downstream slope, which could cause loss of protective vegetative cover and associated erosion. Species that prefer upland areas could be found in this area.
- 7. Left Groin.**
- 8. Discharge Conduit and Outlet Channel.** Beaver can dam the outlet structure. Aquatic species may inhabit this area depending on water flow and availability of vegetation.
- 9. Toe of Embankment and right groin.**
- 10. Erosion Pathways on the Embankment.** Livestock traverse the embankment creating erosion pathways.
- 11. Right abutment contact.**
- 12. Crest.** Livestock traverse the crest which creates ruts. The ceilings of beaver and muskrat burrows in the upstream slope are often just below the dam crest.
- 13. Aquatic Fringe.** The zone where the bank meets the pond usually contains aquatic vegetation preferred by many animals such as nutria.
- 14. Upstream Slope.** Beaver, muskrat, and nutria prefer the upstream slope for burrow excavation. Alligators, otters, and turtles usually live in the shallow waters near the upstream slope.
- 15. Principal Spillway (with riser and trash rack).** Beavers can block principal spillways by constructing dams.

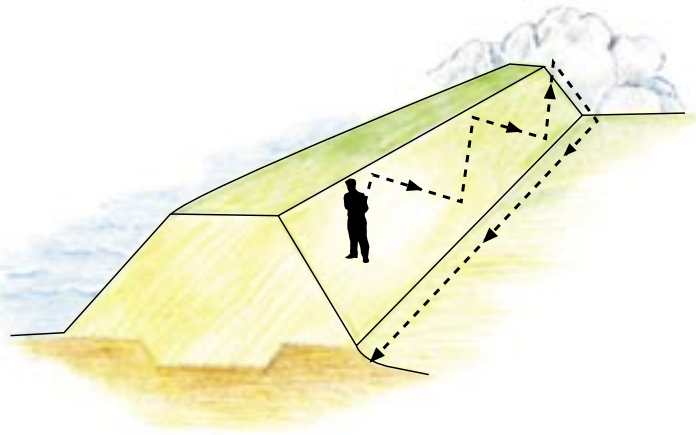

Figure 3-3. The zig-zag method of inspection is best used on small dams and mild slopes.

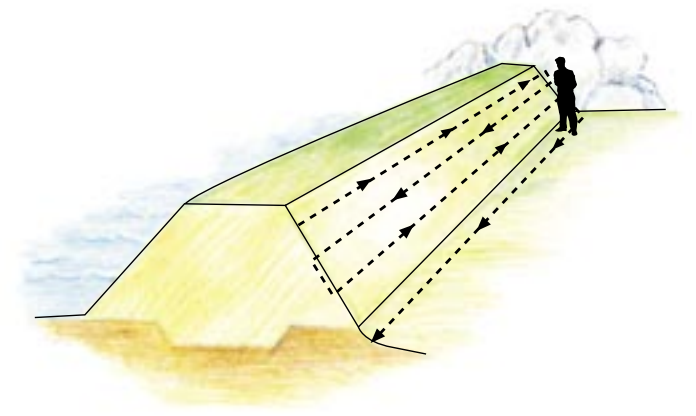

Figure 3-4. The parallel method of inspection is best used for dams with steep slopes.

entire crest from several perspectives and distances. Similar to the upstream slope inspection, the inspectors should center their eyes on the crest line, moving their body from side to side to view the line from several angles. Fixed features that can mark horizontal and vertical points along a dam can be used as reference lines; guardrails, a row of posts, or parapet walls are good reference lines (use caution when using man-made reference lines which can be moved). The reference line must be viewed from several different perspectives; first, the inspectors should sight directly on the reference line and then move their body to either side. This method will assist the inspector in detecting a change in the uniformity of the crest. Zone 2 overlaps Zone 1 on one-half of the crest width. This is intentional, and is meant to em-

phasize the critical nature of the area by requiring inspection of the area twice (ASDSO, 2001).

A typical dam safety inspection report should comment on width, alignment, vegetation, erosion, instabilities, and animal burrows observed in Zone 2. When specifically considering animal burrows and other deficiencies resulting from animal activity, the inspector should observe the following: animal burrow entrances, mounds of excavated soil, cracks, depressions, erosion, sinkholes, paths and ruts, sloughs, slides, and scarps. As with Zone 1, these issues can indicate animal activity. The inspection report should note whether the deficiencies warrant monitoring, repair, or further investigation.

**Biological Perspective:** Dens of beaver and muskrat are typically located just below the crest (look for depressions in the crest since the burrow entrance is typically underwater), and livestock often traverse the crest (look for hoof tracks, rills, gullies, and eroded pathways). Terrestrial wildlife such as groundhogs, ground squirrels, pocket gophers, foxes, coyote, and badgers may inhabit or hunt in the crest area. Moles may dig burrows in the dry, upland area of the upper upstream slope/crest that lead to their hunting grounds in the cool, moist soils near the reservoir pool. Vehicular traffic on crests may discourage wildlife establishment. Additionally, the crest is often constructed of well-compacted material, which is not attractive to most burrowing wildlife. Ants may dig tunnels in the crest, loosening existing cracks.

### 3.2.3 Zone 3: Upper Downstream Slope Area

**Engineering Perspective:** Inspecting the downstream slope is similar in method to inspecting the upstream slope. It is suggested that the downstream slope be viewed from a distance at a time of day when the angle of the sun is low so that wet areas, which will reflect sunlight, are seen more easily. Zone 2 overlaps Zone 3 on one-half of the crest in order to draw additional attention to the crest area.

A typical dam safety inspection report should comment on alignment, vegetation, erosion, instabilities, and animal burrows observed in Zone 3. When specifically considering animal burrows and other deficiencies resulting from animal activity, the inspector should observe the following: animal burrow entrances, mounds of excavated soil, cracks, depressions, erosion, sinkholes, paths and ruts, sloughs, slides, and scarps. As with the previous zones, these issues can indicate animal activity. The inspection report should

note whether the deficiencies warrant monitoring, repair, or further investigation.

**Biological Perspective:** This zone is the most attractive for terrestrial animal activity and is preferred by groundhog, fox, and coyote for burrow and den sites. Prairie dog, pocket gopher, ground squirrel, and groundhog may inhabit the downstream slope area; if they do, predators such as badger, coyote, and foxes may choose this zone as a hunting ground. Gopher tortoises, which are strictly terrestrial, would prefer this zone as it is dry and located well-above the phreatic surface. Look for large dens, burrows, and piles of dirt outside of small burrows. Ants may dig tunnels in the slope, loosening existing cracks. Livestock and Canada geese may graze on the stabilizing vegetation. Moles may inhabit this area and dig burrows from the slope area to an adjacent outlet or spillway for the moist soils they prefer as a hunting ground. Armadillo, mountain beaver, or voles may inhabit this area if the dam is improperly vegetated with trees, shrubs, or a thick understory.

### 3.2.4 Zone 4: Lower Downstream Slope Area

**Engineering Perspective:** Inspection of this zone is similar to inspecting the upstream and upper downstream slopes, but the inspector should give greater scrutiny to the downstream slope below the pool elevation. In most embankment dams, the potential for seepage through the embankment materials day-lighting on the downstream slope increases dramatically further down the downstream slope. As shown on Figure 3-1, the theoretical phreatic surface typical for homogeneous embankment dams intersects the downstream slope. Therefore, the presence of an animal burrow in this area could shorten seepage paths, increase hydraulic gradients, and ultimately cause internal erosion of the embankment materials. A more detailed description of the potential impacts from animal intrusions is provided in Chapter 2.0.

A typical dam safety inspection report should comment on vegetation, erosion, instabilities, seepage, and animal burrows. The potential for uncontrolled seepage through animal burrows in Zone 4 is significantly greater than in the three previous zones. Therefore, seepage observations are important in Zone 4. When specifically considering animal burrows and other deficiencies resulting from animal activity, the inspector should scrutinize the following: animal burrow entrances, mounds of excavated soil, concentrated seeps, wet/spongy areas, cracks, depressions, erosion, sinkholes, paths and ruts, sloughs, slides, and scarps. As with

previous zones, these issues can indicate animal activity. The inspection report should also note whether the deficiencies warrant monitoring, repair, or further investigation

**Biological Perspective:** This zone would also likely support terrestrial wildlife as described under Zone 3. Burrows constructed in lower Zone 4 (where it overlaps with Zone 5) will become saturated depending on depth, which is not preferred by most burrowing animals; therefore, burrows of terrestrial animals (i.e., gopher tortoise, fox, coyote, and groundhog) will occur in upper Zone 4. If a resident beaver constructs a dam that retains water, then muskrat, beaver, and otter will occupy inundated downstream slopes and outlet areas. Moles may hunt in the downstream slope if soils are moist, and the mountain beaver or armadillo may inhabit this area if the vegetation includes trees, shrubs, and a thick understory. Ants may dig tunnels in the slope, loosening existing cracks. Livestock and Canada geese may graze on stabilizing vegetation.

### 3.2.5 Zone 5: Downstream Toe Area

**Engineering Perspective:** Inspection of this zone is similar to inspecting the upstream slope and upper/lower downstream slopes, but Zone 5 is the most critical area because of the potential proximity of the phreatic surface to the downstream slope in this zone. Therefore, as in Zone 4, the presence of animal burrows in this area could shorten seepage paths, increase hydraulic gradients, and ultimately cause internal erosion of the embankment materials.

A typical dam safety inspection report should comment on vegetation, erosion, instabilities, seepage and animal burrows in Zone 5. The potential for uncontrolled seepage through animal burrows in Zone 5 is significantly greater than in Zones 1 through 3, and somewhat greater than in Zone 4. Therefore, seepage observations are critical in Zone 5. When specifically considering animal burrows and other deficiencies resulting from animal activity, the inspectors should observe the following: animal burrow entrances, mounds of excavated soil, concentrated seeps, wet/spongy areas, cracks, depressions, erosion, sinkholes, paths and ruts, sloughs, slides, and scarps. As with previous zones, these issues can indicate animal activity. The inspection report should note whether the deficiencies warrant monitoring, repair, or further investigation.

**Biological Perspective:** Burrows constructed in Zone 5 will become saturated depending on depth, which is not preferred by burrowing terrestrial animals (i.e., armadillo,

mountain beaver, vole, mole, gopher tortoise, fox, coyote, and groundhog). If a resident beaver builds a dam that retains water, then muskrat, beaver, nutria, and otter will occupy inundated downstream slopes and outlet areas, if appropriate vegetation has become established. Ants may dig tunnels in the slope, loosening existing cracks. Livestock and Canada geese may graze on stabilizing vegetation.

### 3.2.6 Zone 6: Spillway, Outlets, and General Areas

**Engineering Perspective:** The best approach to inspecting spillways and outlets is to view all surface and internal areas by walking closely along or within the structure, observing confined space entry requirements. The inspector should enter the conduit and view the internal structure using a flashlight, providing the conduit is of the appropriate size and in safe repair. The inspector should use binoculars or a camera/video camera with the appropriate lens to document the conduit condition if the conduit is not accessible (e.g., located in the water separated from the shoreline or embankment). Underwater features can be viewed via use of boats or underwater divers. Shorelines and upstream areas should be inspected by walking or using vehicles to traverse the inspection areas. Other appurtenant works should be inspected up-close.

**Biological Perspective:** Beaver will construct dams at the spillway locations to capture and reroute water flow. Look for gnaw marks in a circular pattern on tree trunks, beaver dams, and otters playing in the beaver dam waters. Aquatic animals such as muskrat and nutria may be found at these locations if the beaver dam retains water, and if sufficient aquatic vegetation has become established. Armadillo or mountain beaver may inhabit the area if a forest fringe or wooded area is adjacent to the water source.



# 4.0 Overview and Identification of Nuisance Wildlife

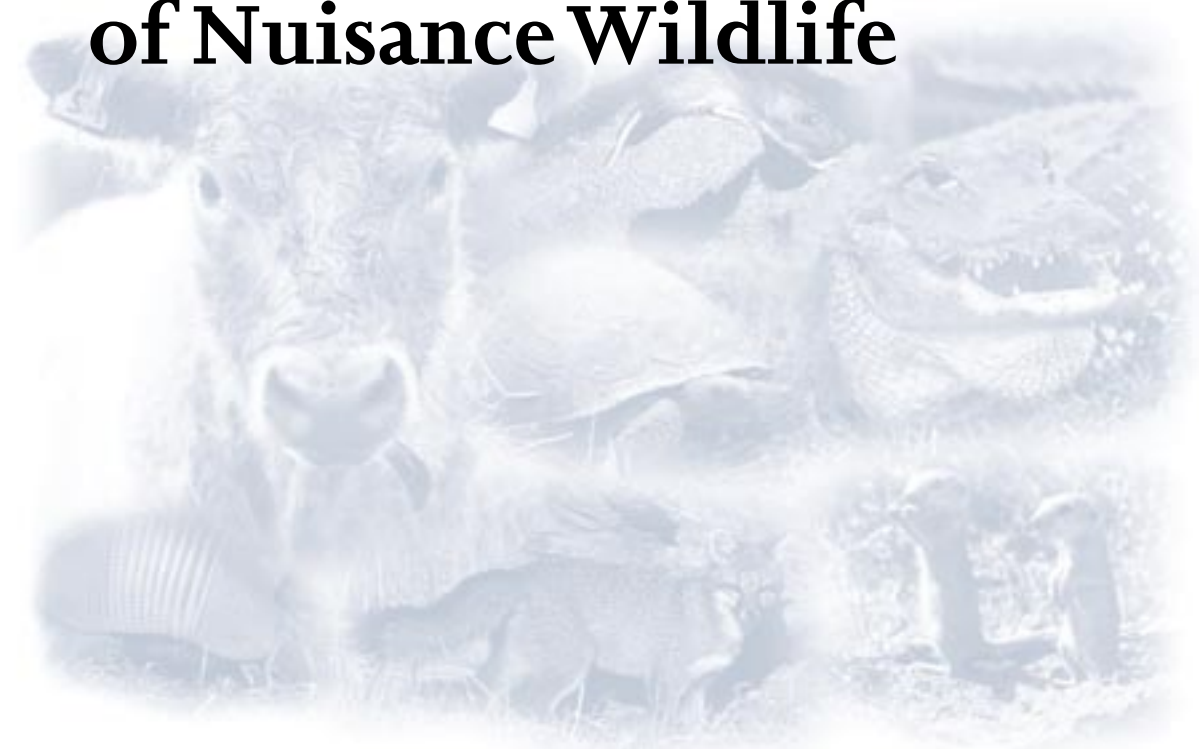

The FEMA/ASDSO workshop and 2003 dam safety specialist surveys indicate that several species damage earthen dams across the nation. This Chapter discusses 23 animals identified by the states as presenting the greatest threats to safe dam operations. Tracks, photographs, and range maps are provided for each animal, as well as a description of the specific threats each animal poses to the earthen dam environment, its preferred habitat, food habits, behavior, and field-identifying tips specific to each animal. It should be noted that some information is difficult to present depending on the animal (e.g., crayfish tracks) and in these cases, such information is omitted.

In a general sense, it is envisioned that a dam specialist will use this information to gain a better understanding of the wildlife that inhabits a dam. To a greater degree, it is hoped that this information will go hand in hand with overall dam management to assist a dam specialist in knowing where to look for wildlife damage (e.g., burrow sites), indicate which animals caused the damage via specific descriptors, and lead the dam specialist toward appropriate damage repair, prevention, and wildlife management (see Chapters 5.0 and 6.0 for dam repair, damage prevention, and wildlife management methods).

## 4.1 The Importance of Accurate Wildlife Identification

During the regular dam inspection detailed in Chapter 3.0 of this manual, the dam specialist will have viewed the dam from both engineering and biological perspectives. In doing so, the specialist may have identified burrows just below the water-line, observed floating rafts of vegetation on the water, trails from the water to the bank, and noted an abundance of aquatic vegetation along the shoreline. Application of the information in this chapter will assist the dam specialist in putting the above clues together to determine which animal is damaging the embankment.

Given the dynamic nature of wildlife and its desire to avoid human interaction, a dam owner will seldom witness wildlife causing damage to dams. However, proper identification of nuisance wildlife is critical so that dam repair and wildlife management methods can be appropriately and lawfully applied to mitigate specific species and their impacts to the earthen dam.

A dam environment that has high biological potential (refer to Chapter 3.1 for discussion of biological potential) will most likely support several nuisance species; however, not all

species living at the dam are necessarily in need of management. To apply mitigation that blankets all animals seen at the dam may be a waste of time and money, not to mention unnecessarily damaging to the environment. For this reason it is important to carefully evaluate the biological evidence at the dam to accurately identify the species responsible for the damage. For example, beaver and otters often live in the same environment, and otters often opt to use beaver dens instead of creating their own. In this case, the otter may be seen living in the den, but the beaver is the species actually responsible for the burrowing activity. Therefore, mitigation should be geared toward the beaver, and not necessarily the otter, which will live in hollow logs and rock crevices just as comfortably. On the other hand, several species may be responsible for compromising activities at the dam, and dam repair, prevention action, and wildlife mitigation will need to be geared toward several species. In essence, application of the information provided in this Chapter will assist in accurate identification of the problematic species, which will help the dam specialist appropriately manage the dam without spending unnecessary energy or funds.

Misidentification of a wildlife species may result in inadequate mitigation, which could allow damage to continue, perhaps leading to dam failure. As wildlife identification can be difficult, a dam owner may benefit from using a wildlife specialist or professional trapper to positively identify the species so that proper wildlife mitigation can be developed. Appendix A contains state wildlife contacts, and state trapper information can be obtained at [www.nationaltrappers.com](http://www.nationaltrappers.com).

## 4.2 Identifying Nuisance Wildlife

### 4.2.1 Muskrat Overview



Muskrat (*Ondatra zibethicus*) are semi-aquatic rodents with brownish-black fur and with a body 10-14 inches long and a tail 8-11 inches long. Muskrats have large, partially-webbed hind feet and a vertically flattened tail, which they use to propel themselves through water.

**Threat to Dams:** Muskrats dig fairly large burrows that can lead to internal erosion and structural integrity losses in the earthen dam. Muskrats will continue to dig upward into the embankment as the phreatic surface rises; internal burrows can become extensive.

**Habitat and Home** (Figure 4-1): Muskrats inhabit freshwater and saltwater marshes, lakes, ponds, rivers, and other water-courses, where water is calm or very slowly moving. Muskrats prefer water courses that are about 3-4 feet deep that don't freeze completely in the winter and contain abundant cattails or aquatic vegetation. Muskrats typically burrow

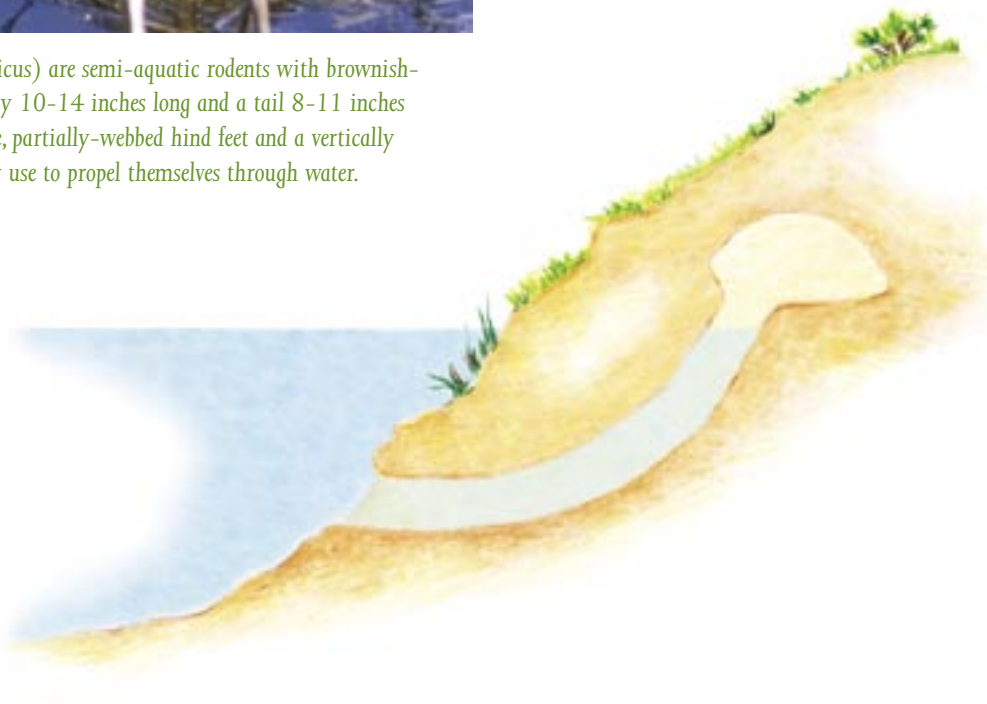
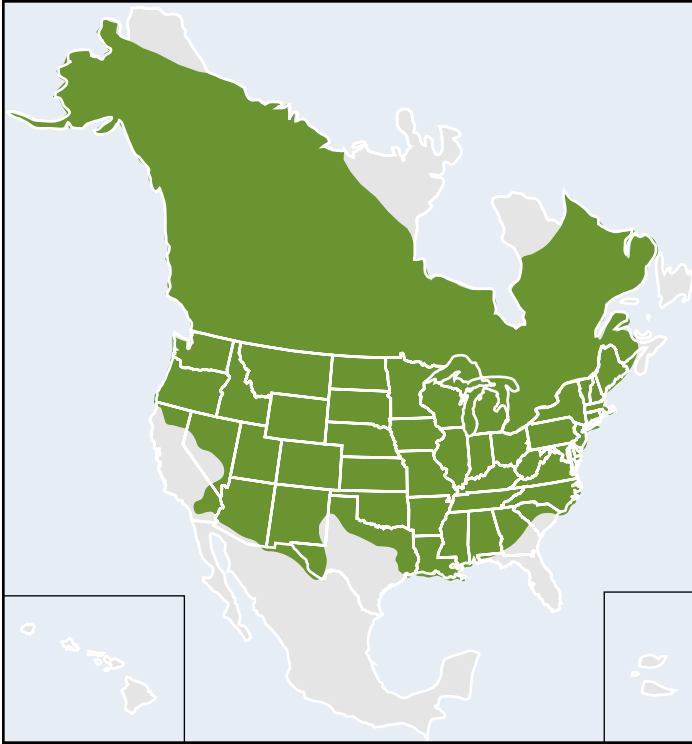

Figure 4-1. Muskrat dig dens in the upstream slope, with the entrance tunnel beginning about 6-18 inches below the water line.



Range of the muskrat in North America.

into a dam's upstream face. Their burrows begin from 6 to 18 inches below the water surface, and breather holes and escape holes can be observed above the water line. If the water level rises, the muskrat will excavate a dry chamber by digging higher into the embankment at an upward slant. Muskrats also build conical houses out of marsh vegetation, but usually excavate and use burrows when inhabiting earthen dams and other hydraulic structures (USDA, 1991). Detection of muskrat can be difficult if slopes of the dam are improperly vegetated, as their burrows may be covered over (see Chapter 5.2 for a discussion on improper vegetation at an earthen dam).

*Muskrats are considered a significant dam safety issue in 71% of the surveyed states.*

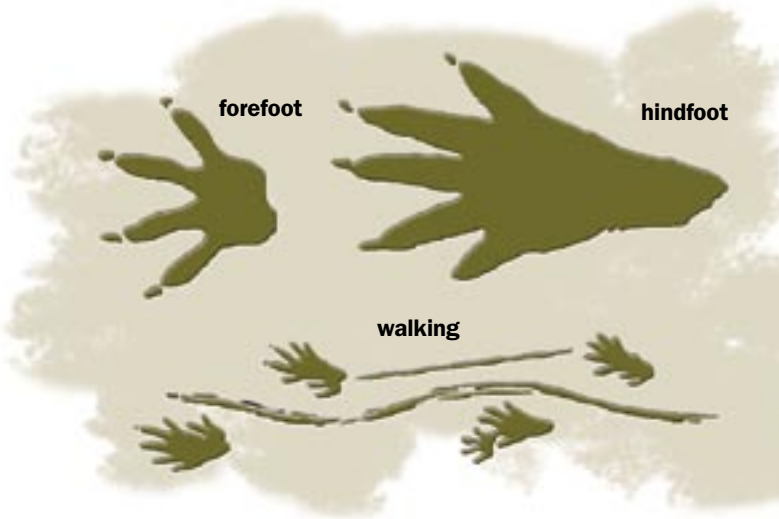

*In very clear tracks, a small fifth toe can be seen on the outside of the front foot pad. All toes, except the nubbin, will show claw prints. The muskrat's vertically flattened, bare tail will create a drag mark in the center of the prints.*

**Food Habits:** Muskrats are primarily herbivores and prefer to feed on cattails, grasses, smartweed, duck potato, water lily, sedges, and other aquatic plants. When vegetation is scarce, muskrat will feed on bivalves, crustaceans, insects, and sometimes fish (University of Nebraska, 1994).

**Behavior:** Muskrats can often be seen swimming at any hour of the day however they are most active at twilight. Muskrats often construct roofs over floating rafts of vegetation so that they have a covered place to eat. These huts can be found floating on the water and are especially important to the muskrat in winter when cooler weather can chill the animal's naked tail and feet (USDA, 1991; Benyus, 1989).

**Field Tip:** Listen for a loud splash when nearing the water. Muskrats plop into the water when approached to alert other muskrat of human activity. Muskrats sometimes hold their tails out of the water as they swim (Benyus, 1989).

## 4.2.2 Beaver Overview



The Beaver (*Castor canadensis*) is the largest rodent in North America weighing 45-60 pounds, with a body measuring 25-30 inches and a tail measuring 9-10 inches. Beavers are typically aquatic mammals, with webbed feet that are adapted for swimming and a flattened tail. Beavers vary in color but the most common body fur is reddish-brown and the belly fur is usually gray (USDA, 1991).

**Threat to Dams:** Beaver can cause extensive damage to earthen dams by excavating bank burrows, which can cause internal erosion or structural integrity losses. Beaver dams constructed across spillways can cause adverse hydraulic effects and result in flooding or failure of the spillway or the earthen dam itself. Beavers often clog the intake and outlet structures with their cuttings.

**Habitat and Home:** (Figures 4-2, 4-3, 4-3A and 4-4): Beaver can be found throughout the continental United States wherever there is a year-round source of water. However, beaver will avoid an aquatic site that does not contain preferred foods or have adequate sites for lodges, dens, or dams (University of Nebraska, 1994). Beaver lodges are easy to identify; they are dome-shaped, built of limbs and

Beavers are considered a significant dam safety issue in 67% of the surveyed states.

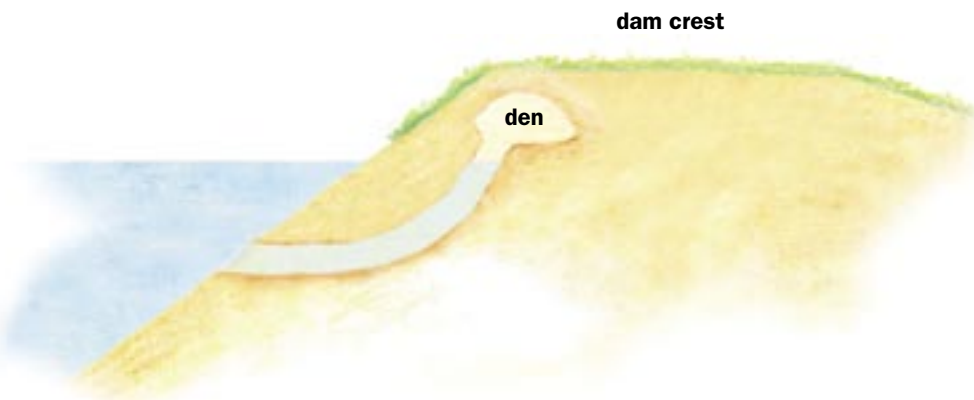
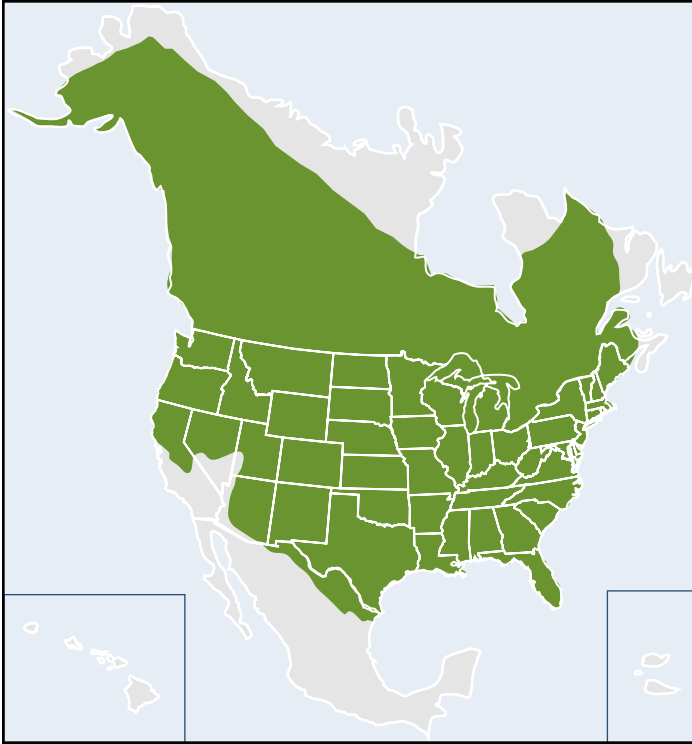

Figure 4-2. The ceiling of a beaver den is often just below the crest of the dam.



Range of the beaver in the North America.

logs, may reach 5-6 feet above the water line, and be 12-14 feet wide (Benyus, 1989). Beavers have also been known to create tunnels and dens. Beaver tunnel entrances have been observed 1-4 feet below the water level. Beavers burrow into the dam from below the water line upwards toward the crest, where the beaver will excavate their den. The entrance to the lodge or bank den is typically under water, with the interior den being several inches above the water surface. All lodges and bank dens have at least two entrances, and perhaps four or more (University of Nebraska, 1994).

*Beaver dens are often excavated just below the dam crest within the dam. A den roof collapse at this location can create voids in the crest and upstream slope.*

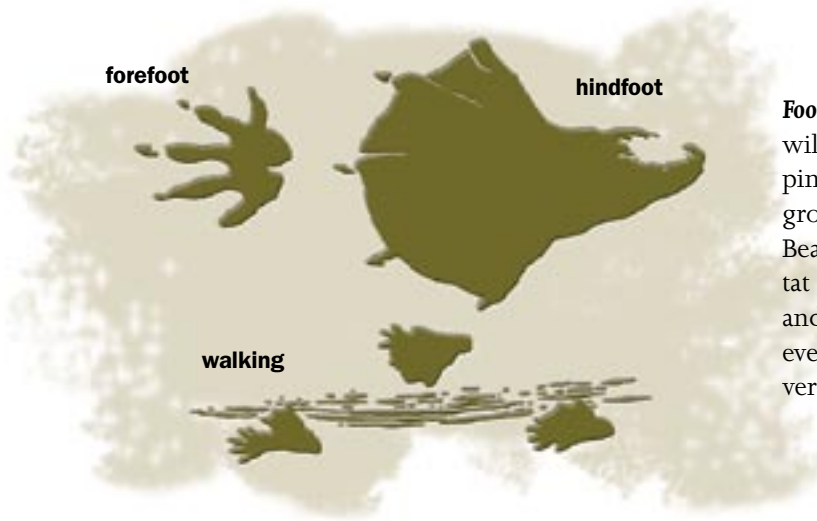

**Food Habits:** Beaver prefer to eat tree species such as aspen, willow, poplar, cottonwood, sweetgum, blackgum, and pine, although beaver will also eat most woody plants that grow near water, as well as herbaceous and aquatic plants. Beavers will travel 100 yards or more from their water habitat to cut down crops or trees growing in adjacent habitats and drag them back to their pond home. Beaver use whatever vegetation they don't eat for dam construction (University of Nebraska, 1994).

*Beaver tracks are not a reliable way to identify their presence due to their walking pattern. The beaver's hind foot is placed on top of the front foot's track and the wide tail, which drags along the ground, smears both to a point where identification becomes nearly impossible.*



Figures 4-3 and 4-3A. Beaver dams can block emergency spillways causing water levels behind the dam to rise.



Figure 4-4. A lodge can reach 5-6 feet above the waterline.

The ranges for beaver, nutria and muskrat overlap, and their damages can appear similar. Careful examination of the damage, burrows, and proper use of the field tips listed in this manual will assist in accurate species identification and management.

**Behavior:** Beavers construct dams to create a depth of water suitable for them to hide from predators as they travel to their shore feeding grounds. Beaver use a variety of materials to construct these dams—the use of wood, fiber, metal, wire, and rocks is not uncommon. Beavers leave their lodge at dusk and spend most of the night working (removing shoreline trees, constructing dams, gathering food). However, in the fall season it is not uncommon to see a beaver working in the daytime as they gather food for the winter (Benyus, 1989).

**Field Tip:** Perhaps the best indication of beaver is their dams. Dams are typically a few feet long, but can be up to several hundreds of feet long. A second indication is the presence of canals, which beaver build in the water to help them transport the trees they fell to construct the dams. Gnaw marks in a circular pattern on tree trunks are also good indicators of beaver, and trees cut by beavers show a distinctive tapered cone at the end of the trunk. An audible sign of beaver is the loud slap of their horizontally flattened tail on the surface of the water to alert other beaver to the presence of predators (Benyus, 1989).

### 4.2.3 Mountain Beaver Overview



Mountain Beaver (*Aplodontia rufa*) is typically found in Washington, Oregon, and portions of California. Mountain beaver neither prefer mountainous habitat nor are true beavers. These rodents have short, heavy bodies and are dark brown above and lighter brown below; they resemble a tailless muskrat. Mountain beavers have long, strong claws, which they use to create burrows up to 19 inches in diameter in wet soil near dense water-side vegetation.

**Threat to Dams:** Mountain beavers divert waterflow by blocking water with vegetation. The shallow location of the extensive burrows will often cause the ground to cave in. The mountain beaver's activities could result in hydraulic alteration and structural losses.

**Habitat and Home:** Mountain beavers prefer habitats in forested areas where the canopy is open enough to allow dense understory vegetation. If a dam is covered with trees and thick understory, then a mountain beaver will likely find a comfortable habitat. Within this area, mountain beaver prefer moist gullies, and vegetated hillsides or flat areas that are not prone to flooding. Habitats dominated by red alder, salmonberry, huckleberry, and bracken and sword ferns are preferred by the mountain beaver. Mountain beavers dig extensive burrows that can cover a quarter-acre, are usually located near vegetative cover, and are generally 1-6 feet deep with 10-30 open entrances. The burrows contain deep (1-9 feet) nesting and food chambers usually located about 3 feet below ground surface; the chambers can be large, usually measuring 2 feet in height and 2 feet in diameter. Mountain beavers do not like their burrows to be wet and will leave a burrow once it is flooded (University of Nebraska, 1994) (Figure 4-5).

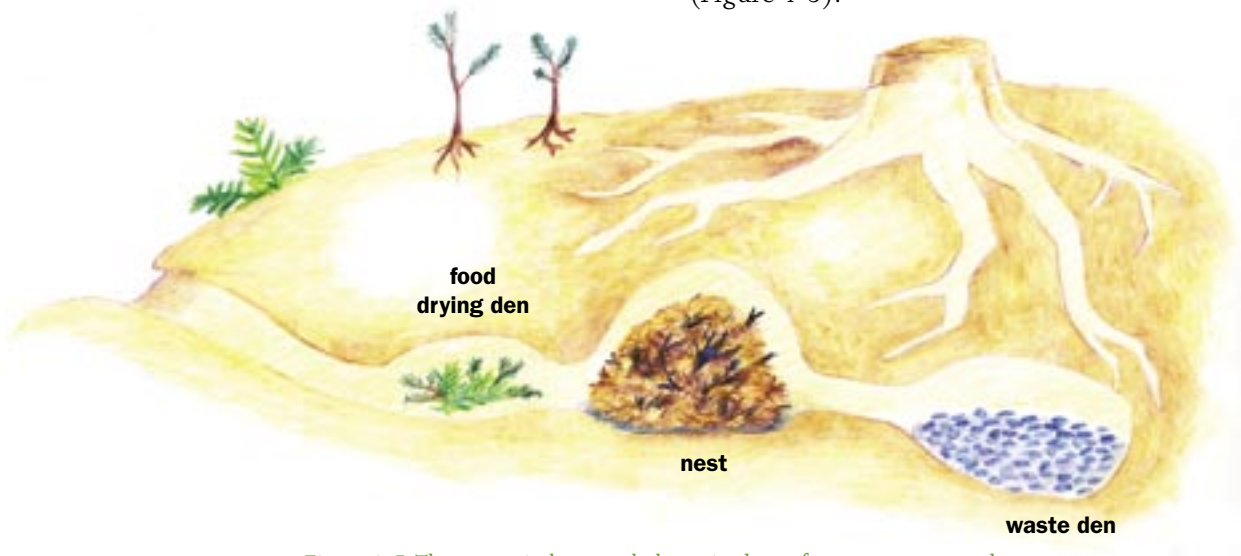
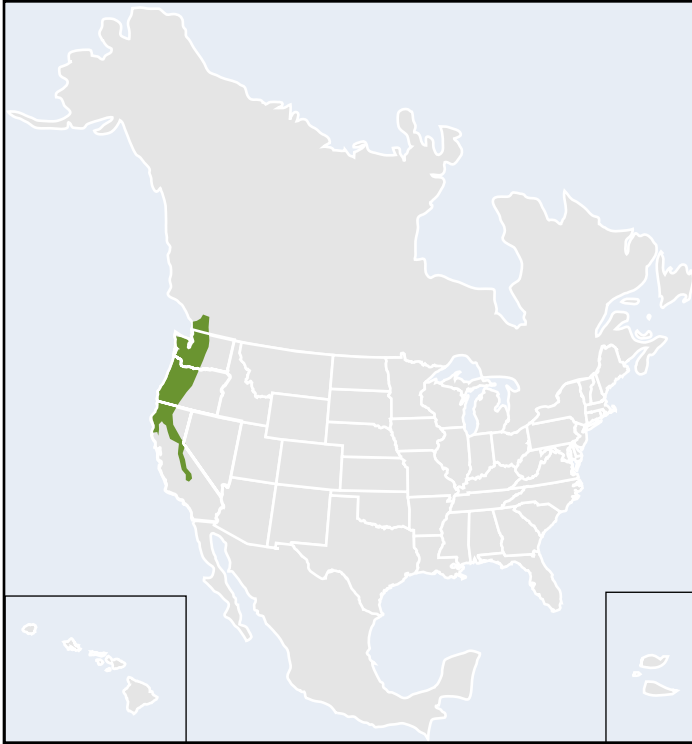

Figure 4-5. The mountain beaver only leaves its den to forage or create new dens.





Range of the mountain beaver in North America.

**Food Habits:** Mountain beavers are herbivores and eat any type of succulent vegetation, with sword fern and bracken fern being favorites (University of Nebraska, 1994). Mountain beavers will also girdle the base of trees and feed on small stems (Figure 4-6). Plants that are gathered by the mountain beaver are often dried near the burrow and are probably used for storage or nesting material. Mountain beavers dry their food by stacking vegetation on a nearby log or rock, which is termed “haystacking” (Figure 4-7). Mountain beaver usually feed on plants located within 50 feet of their burrows (University of Nebraska, 1994).



Figure 4-6. Mountain beavers girdle trees and feed on small stems.

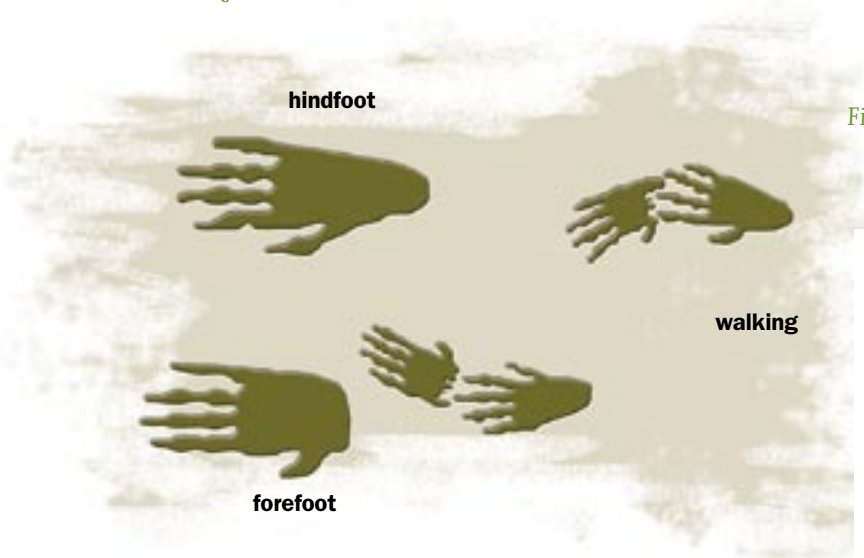

The identifying characteristic of a mountain beaver track is a front foot print that has a square heel and a hind print that displays a tapered heel.



Figure 4-7. Mountain beavers dry their vegetation on logs, known as “haystacking,” before moving it into their burrows. Haystacks can be up to 2 feet high.



Figure 4-8. Ferns and Douglas fir branches placed in a burrow is a reliable field sign of mountain beaver.

**Behavior:** Mountain beavers are nocturnal animals. They are superb diggers and spend much of the night digging and maintaining their labyrinth of burrows. Mountain beavers often stack cut vegetation in a burrow entrance, presumably to lower the vegetation's moisture content before storing it in the burrow (University of Nebraska, 1994).

**Field Tip:** Stem and branch cutting within the vicinity of the dam may be a positive sign of mountain beavers. Signs of mountain beaver include freshly dug soil and chewed vegetation in proximity to a 6 to 8-inch diameter hole. Look for haystacks near the burrow entrance and vegetation piled in the burrow entrance (Figure 4-8).



#### 4.2.4 Groundhog Overview



Groundhog (*Marmota monax*) (also known as Woodchuck or Rockchuck) are large burrowing rodents that weigh an average of 5 to 10 pounds and have an average body length of 16-20 inches. Groundhogs are usually grizzled brownish gray, although white and black individuals may occasionally be found. The groundhog's forefeet have long, curved claws that are well adapted to digging burrows (University of Nebraska, 1994).

**Threat to Dams:** Groundhog burrows in earthen dams can weaken the embankment and act as a pathway for seepage.

**Habitat and Home:** The groundhog generally prefers open farmland and woody or brushy areas adjacent to open land. Groundhog burrows are usually located in fields or near grassy pastures or meadows, along fence rows, stone walls, roadsides, and near building foundations or the bases of trees (University of Nebraska, 1994) (Figure 4-9, shown on page 31). Groundhogs will burrow into earthen dams, generally on the downstream side of the dam, as this environment can be similar to their preferred habitat (Michigan State University Extension, 1998). Their burrows can be distinguished by the large mound of excavated earth deposited by the main entrance. Two or more entrances generally exist for each burrow system. Burrows are often well-hidden and may be difficult to locate.

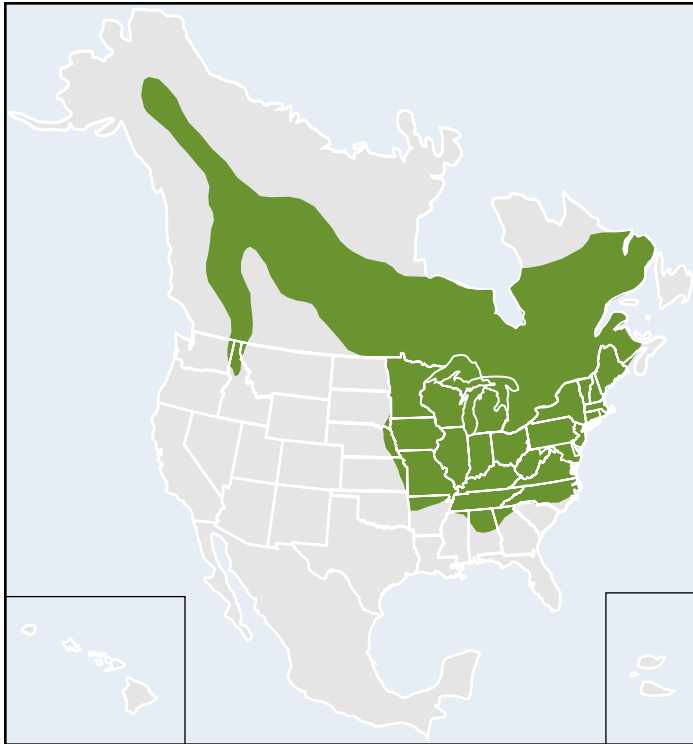

Range of the groundhog in the North America.

**Food Habits:** Groundhogs are strict herbivores. They feed on a variety of vegetables, grasses, and legumes, including beans, peas, carrot tops, alfalfa, and clover. Groundhogs prefer to feed in the early morning and evening hours (University of Nebraska, 1994).

**Behavior:** Groundhogs are usually only active during the day. During warm periods, they can often be found basking in the sun near their burrows. Groundhogs are one of the few mammals that enter a true hibernation period. Hibernation generally occurs from late October or early November to late February or March, although the exact timing depends on the latitude (University of Nebraska, 1994). New burrow construction occurs in late summer (USFS, 1994).

**Field Tip:** When approached or startled, a groundhog will often emit a shrill whistle followed by a low, rapid warble (University of Nebraska, 1994). An indicative sign of a groundhog burrow is the spring cleaning performed by the groundhog, which results in a mound of fresh dirt outside the burrow entrance. Adjacent trees may be girdled or clawed (Indiana Department of Natural Resources, 2003). Look for burrow construction in the late summer months.

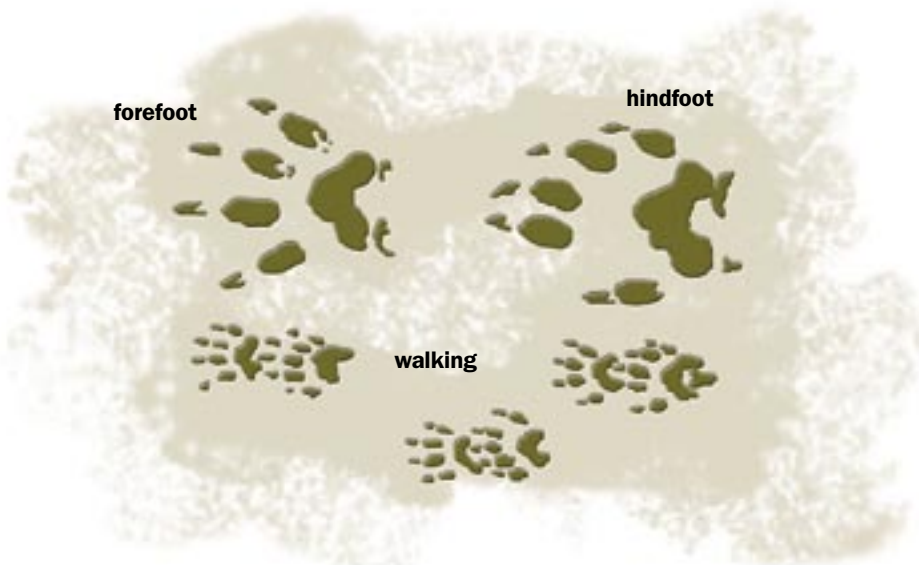

It may be difficult to tell the front and back tracks apart because when a groundhog walks, it puts its hind foot in the track of its front foot.

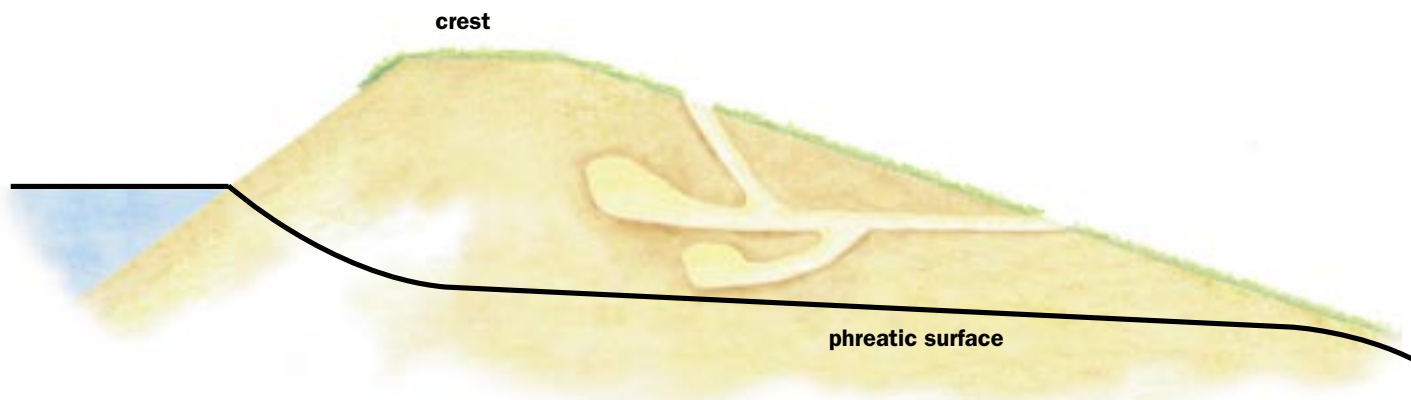

Figure 4-9. Groundhog burrows are extensive and irregular in pattern.

#### 4.2.5 Pocket Gopher Overview



Pocket Gopher (*Geomys* spp., *Thomomys* spp., and *Pappogeomys castanops*) are medium-sized burrowing rodents that weigh an average of 3 to 20 ounces and have an average body length of 5 to 14 inches. Their fine fur is highly variable in color, ranging from nearly black to pale brown to almost white. Pocket gophers have fur-lined pouches outside of the mouth that are used for carrying food. They have yellowish-colored incisor teeth that are always exposed, even when the mouth is closed.

Pocket gophers are considered a significant dam safety issue in 23% of the surveyed states.

**Threat to Dams:** Pocket gophers are generally only a threat to small earthen dams. They dig burrows that can lead to internal erosion and structural integrity losses in the dam. The presence of pocket gophers also increases the likelihood of badger activity. Badgers are one of the primary predators of pocket gophers. Badgers will attempt to dig gophers out of their burrows, which can be very destructive to earthen dams (See Chapter 4.2.6 for a discussion on badgers). Pocket gophers can also damage underground utilities, such as irrigation pipes or electric cables (USDA, 1991).

**Habitat and Home:** There are 10 species of pocket gopher with substantial populations in the United States, but only one species is typically found in an area (USFS, 1994). They can occupy a wide range of habitats, from low coastal areas

Range of the pocket gopher in North America.

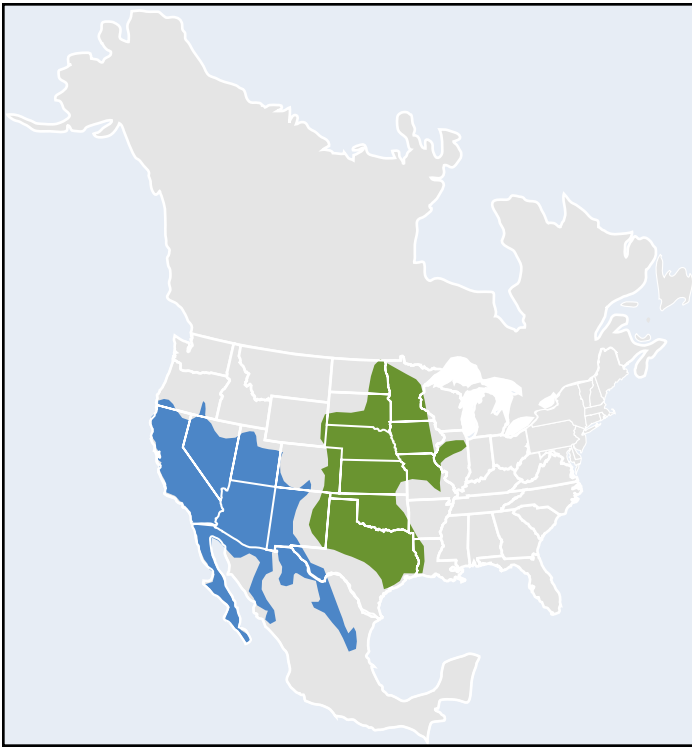

Plains (*Geomys bursarius*), and Botta (*Thomomys botta*) Pocket Gophers

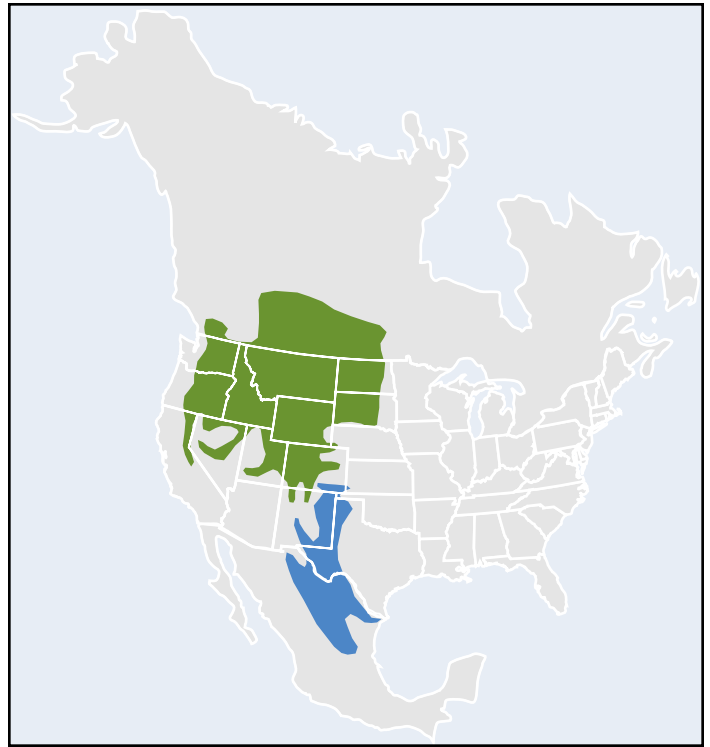

Northern (*Thomomys talpoides*), and Yellow-Faced (*Pappogeomys castanops*) Pocket Gophers

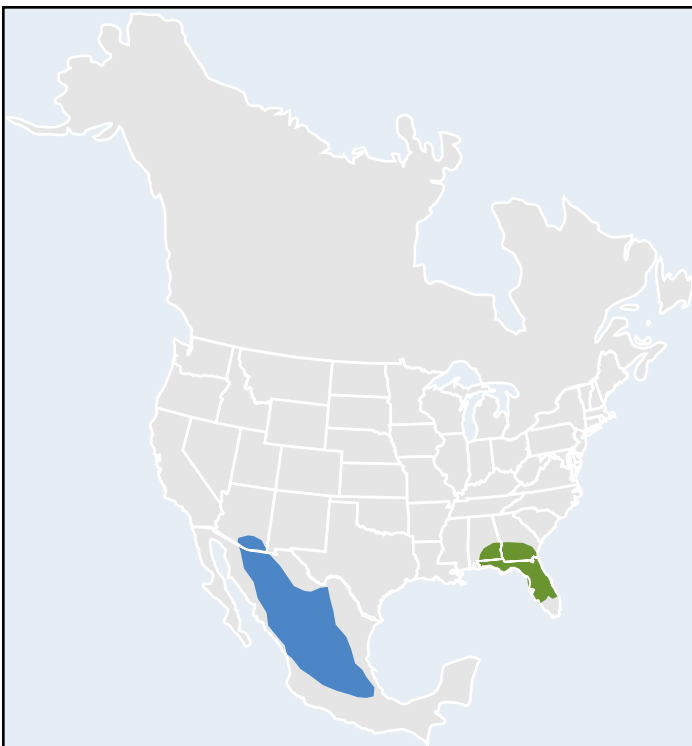

Southeastern (*Geomys pinetis*), and Southern (*Thomomys umbrinus*) Pocket Gophers

to mountains (USDA, 1991). Horseshoe-, fan- or kidney-shaped mounds of soil are characteristic evidence of pocket gopher burrows. Their burrows are nearly always kept closed with an earthen plug (University of Nebraska, 1994) (Figure 4-10).

**Food Habits:** Pocket gophers are strict herbivores, eating all types of forbs, grasses, shrubs, and trees. Roots are the major food source, although during the growing season, pocket gophers will also eat the above-ground portions of plants (University of Nebraska, 1994).

**Behavior:** Pocket gophers are solitary animals that spend much of their time underground. There is typically only one gopher per burrow, except during breeding season (USDA, 1991).



**Field Tip:** Pocket gopher activity can be distinguished from that of other burrowing animals by their burrow characteristics, particularly the fan-shaped mounds of soil and plugged burrow entrances. Pocket gophers will tunnel through the snow, pushing soil from below ground into the snow tunnels. When the snow melts, the soil “casts” or tubes can be found on the ground surface (USFS, 1994). Horseshoe-shaped mounds of soil are created in summer or late fall.

Pocket gopher tracks will show five toes on the hindfoot and four toes on the slightly smaller forefoot. Claw marks are usually well-defined.

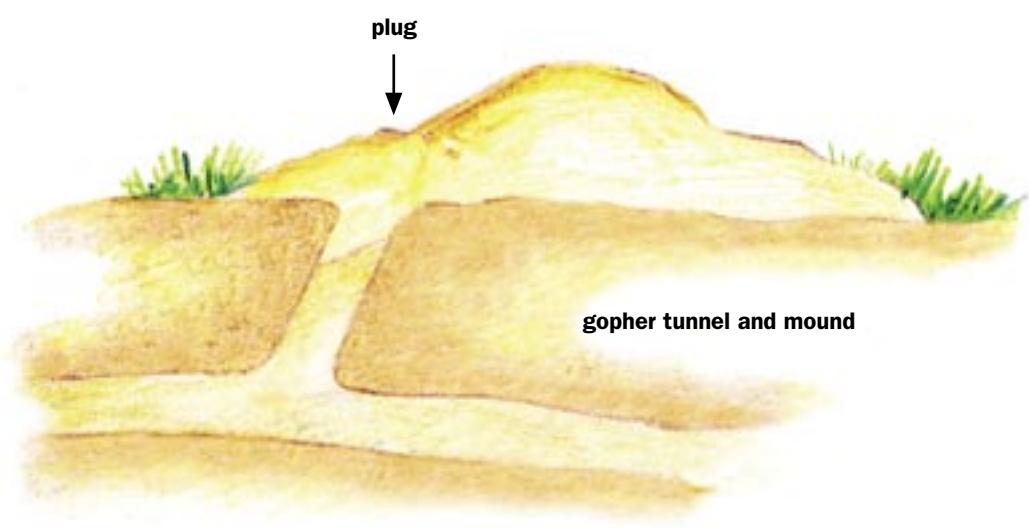

Figure 4-10. Lateral burrows of the pocket gopher end in a soil mound or a soil plug.

#### 4.2.6 North American Badger Overview



The North American Badger (*Taxidea taxus*) is a stocky animal that can grow up to 30 inches long. It has grayish yellow fur with pale underparts, long claws, a short, bushy tail, and black feet. Badgers can weigh from 19 to 30 pounds and can be identified by a white stripe that runs from its nose to the back of its head (University of Nebraska, 1994).

**Threat to Dams:** Badgers are especially adapted for digging and dig in pursuit of prey and to construct dens for shelter. Badgers can cause severe damage to hydraulic structures. Badgers can exacerbate internal and external erosion in an earthen dam by enlarging existing burrows of prairie dog, pocket gopher, or ground squirrels, all of which can inhabit an earthen dam and are a preferred food of the badger. Badger dens create large voids in the earthen dam, compromising structural integrity.

*Badgers are considered a significant dam safety issue in 17% of the surveyed states.*

**Habitat and Home:** Badgers prefer pastures or rangelands with light to moderate cover and few trees. Habitats with sandy or porous soils are preferred. Female badgers dig large burrows (5-30 feet long) with a large chamber 2-3 feet below the ground surface for birthing. Dens have one entrance that is usually elliptical in shape (University of Nebraska, 1994).

**Food Habits:** North American badgers are opportunist omnivores that feed on earthworms, mammals, birds, reptiles, grains, and fruits. Prairie dog, pocket gopher, and ground squirrels are common in badger diets.

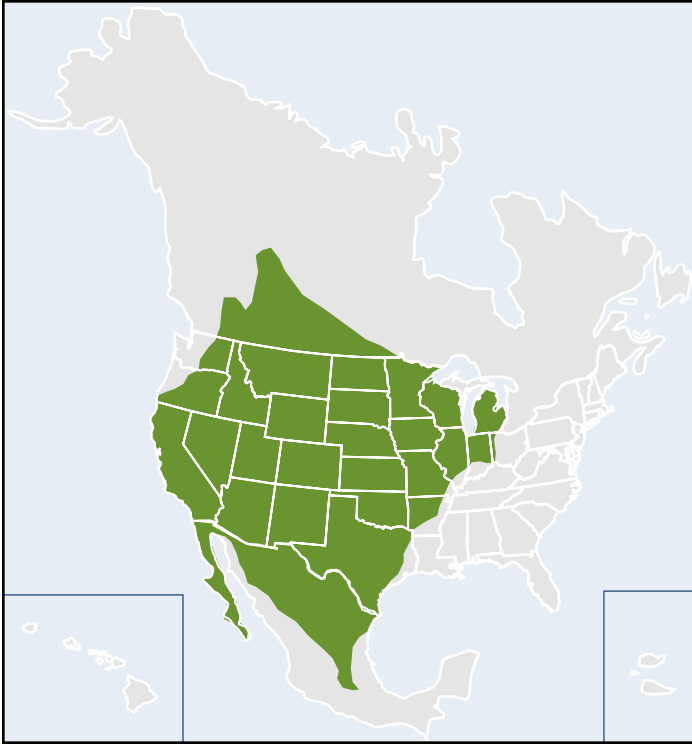

Range of the badger in North America.

**Behavior:** Badgers are adept at pursuit and capture of ground-dwelling prey. A typical burrow dug in pursuit of prey is shallow and about 1 foot in diameter (University of Nebraska, 1994). Badgers are mostly nocturnal but will be active during the day if the area is quiet. Badgers are usually solitary.

**Field Tip:** Large piles of dirt and rock left near animal burrows can indicate badger hunting activity. Badgers maintain the condition of their claws by sharpening them on trees or fence posts; claw marks can indicate badger presence (University of Nebraska, 1994).

Badger tunnels and dirt mounds resulting from prey pursuit can cover an area the size of a car.

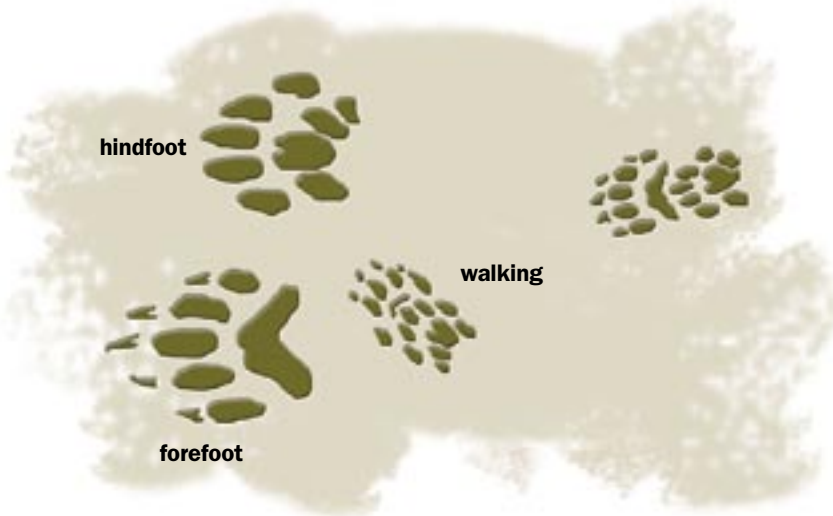

Badger tracks are similar to coyote tracks, but are distinct in the long claw marks on the front feet and the presence of five toes. Badger tracks are typically turned inward toward each other, and the hindprints are narrower than the foreprints.



#### 4.2.7 Nutria Overview



Nutria (*Myocastor coypus*) With an average weight of 8 pounds and a body length of 24 inches (tail is an additional 16 inches long), nutria are larger than muskrat, but much smaller than beaver. With a preferred habitat that includes permanent water, nutria are excellent swimmers with webbed hind feet, but move awkwardly on land.

*Look closely! Nutria are aquatic rodents often misidentified as either a muskrat or beaver.*

*Nutria are considered a significant dam safety issue in 4% of the surveyed states.*

**Threat to Dams:** Nutria construct extensive burrows as shelter in the upstream slope. Burrows can weaken an earthen dam to the point of collapse when soil becomes saturated by precipitation or high water, or when heavy vehicles cross the crest. Nutria are notorious for breaking through water-retaining levees in Louisiana and Texas (University of Nebraska, 1994).

*In some cases, nutria tunnels have been so extensive that water flowed unobstructed through the embankment necessitating its complete reconstruction.*

**Habitat and Home:** Nutria can adapt to a variety of habitats, but prefer a semi-aquatic environment and particularly, the zone between land and permanent water. This zone is preferred for its abundance of aquatic vegetation. For the most part, any substantial nutria populations in the United States occur in freshwater marshes of coastal areas (University of Nebraska, 1994). Nutria are ground-dwellers during the summer, preferring to live in dense vegetation. The rest of the year nutria live in burrows they have dug, or that have been abandoned by armadillos, muskrat, or beaver. Nutria construct burrow entrances in vegetated banks of dams and waterways; a bank that has a slope greater than 45 degrees is a preferred location (University of Nebraska, 1994). Nutria burrows can be simple or complex; a complex burrow may have several tunnels and entrances at different levels in the bank. A burrow system will contain compartments (ranging from 1-3 feet across) for resting, feeding, and shelter from the weather and predators. Tunnels can be 4-6 feet in length.

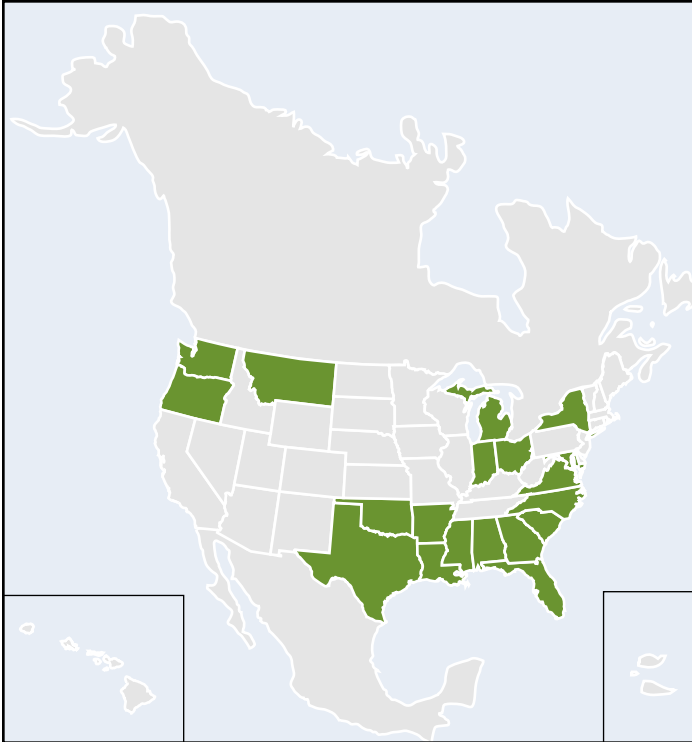

Range of the nutria in North America.

**Food Habits:** Nutria prefer aquatic plants such as sedges, rushes, cattails, and arrowheads, however the bark of black willow and bald-cypress may be eaten in the winter. Nutria eat food in a number of places including feeding platforms on the water (floating mats of vegetation or even on top of beaver and muskrat houses), in the water itself, or on land.

**Behavior:** Nutria feed at night when food is plentiful, but will feed during the day if food is limited. Nutria can scratch or bite aggressively if captured or cornered.

**Field Tip:** Unlike muskrat or beaver, a nutria's tail is round with scant hair, the whiskers are long (around 4 inches) and whitish, and nutria have prominent red-orange incisors. Trees girdled by nutria will show no teeth marks.

Nutria construct platforms of floating vegetation used for loafing, grooming, birthing, and escape, which are often mistaken for muskrat houses.

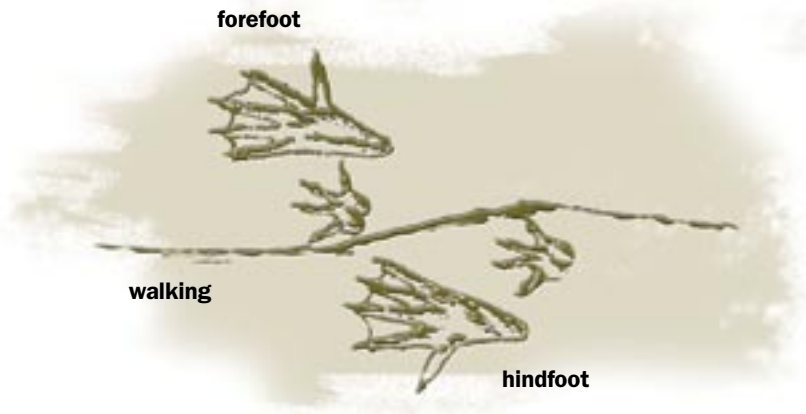

Tracks left by nutria may also have tail drag marks, or sometimes chest marks, as a nutria may drag its chest when on land.

#### 4.2.8 Prairie Dog Overview



Prairie Dogs (*Cynomys* spp.) are squirrel-like, burrowing rodents with squat, muscular bodies and short tails and ears. Their fur is sandy brown to cinnamon in color with grizzled black and buff-colored tips. Adult prairie dogs grow to a length of 13 to 17 inches and weigh approximately 2 to 4 pounds (USDA, 1991).

Prairie dogs are considered a significant dam safety issue in 8% of the surveyed states.

**Threat to Dams:** Prairie dogs dig burrows that can lead to internal erosion and structural integrity losses in earthen dams.

**Habitat and Home:** Prairie dogs prefer grassland or short shrubland habitats. They often establish colonies near intermittent streams or water impoundments (USDA, 1991). Prairie dog burrows are found in open areas with low vegetation. Their burrows are distinguished by relatively large holes and cone-shaped mounds. Prairie dogs remove the vegetation from around their burrows and use it for food or nesting material (USDA, 1991). Other animals often make their homes in prairie dog burrows, including the federally protected black-footed ferret and burrowing owl.

**Food Habits:** Prairie dogs eat mostly grass, although they will also eat flowers, seeds, shoots, roots, and insects when available (University of Nebraska, 1994).

**Behavior:** Prairie dogs live in large colonies known as “towns.” Each town is made up of a complex series of tunnels and may have as many as 20 to 50 burrow entrances. Prairie dogs are social animals that are most active during the day (University of Nebraska, 1994).

**Field Tip:** Look for mounds of earth about 1 to 2 feet high that resemble miniature volcanoes.

Range of the prairie dog in North America.

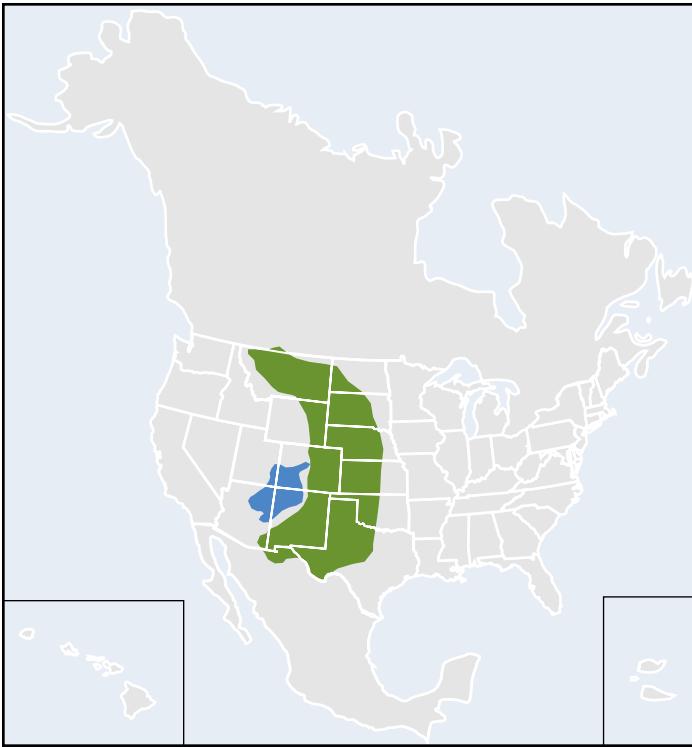

Black-Tailed (*Cynomys ludovicianus*), and Gunnison (*Cynomys gnnisoni*) prairie dogs

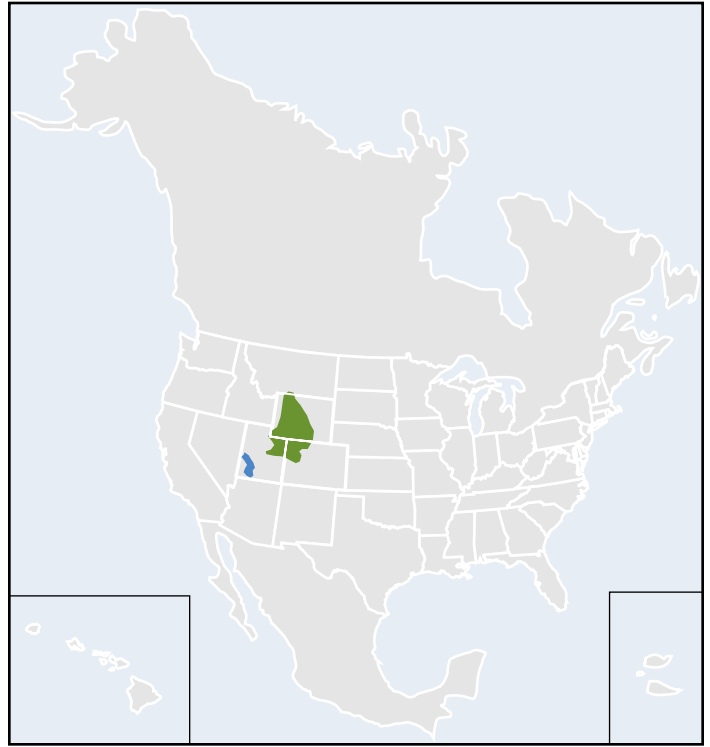

White-Tailed (*Cynomys leucurus*), and Mexican (*Cynomys mexicanus*) prairie dogs

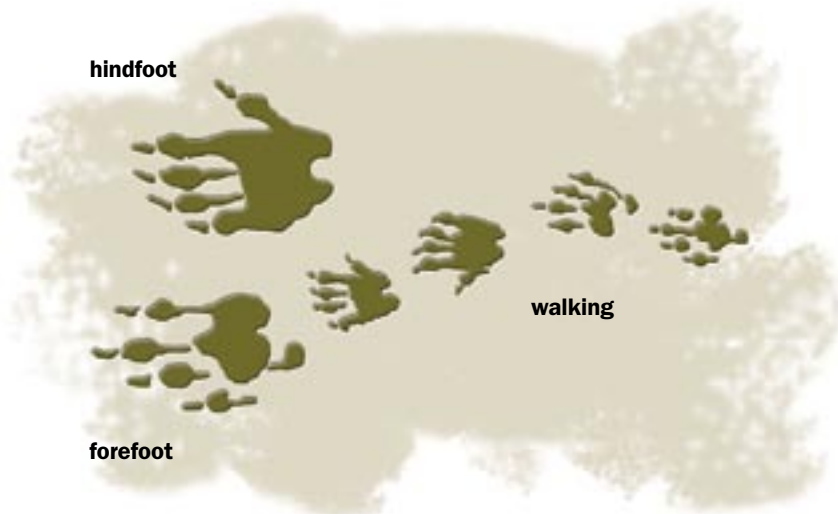

Prairie dog tracks will show five toes on the hindfoot and four toes on the slightly smaller forefoot.

#### 4.2.9 Ground Squirrel Overview



Ground Squirrel (*Spermophilus* spp.) are small to medium-sized burrowing rodents. Twenty-three species of ground squirrels live in the United States (University of Nebraska, 1994). They vary in size, with lengths ranging from 6 to 20 inches and weight ranging from 0.25 to 2.5 pounds. They also vary in color, ranging from brown to reddish brown to gray. Some species have markings, such as spots or stripes. Some species have long bushy tails, while others have short tails with short hair (USDA, 1991).

**Threat to Dam:** Ground squirrels dig burrows that can lead to internal erosion and structural integrity losses in earthen dams. The presence of ground squirrels also increases the likelihood of badger activity. Badgers will pursue ground squirrels into their burrows, which can be very destructive to earthen dams (USDA, 1991).

**Habitat and Home:** Ground squirrels can be found in at least 27 states west of Ohio. They occupy a wide range of habitats from low coastal areas to mountains. Ground squirrels keep their burrows unplugged. Specific burrow design varies with species, soil type, habitat and climate. Some species of ground squirrels are colonial, which means that several individuals live in the same burrow system. These systems consist of clustered, above-ground mounds that resemble prairie dog burrows. They are generally easier to spot than the burrows of solitary ground squirrel species, which tend to be scattered and inconspicuous (USDA, 1991).

Range of the ground squirrel in North America.

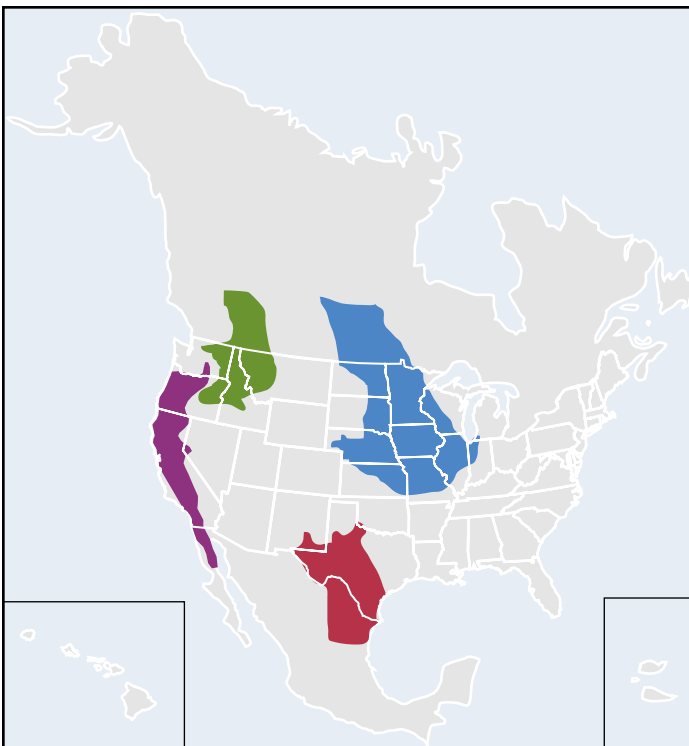

Columbian (*Spermophilus columbianus*), Franklin (*Spermophilus franklinii*), California (*Spermophilus beecheyi*), and Mexican (*Spermophilus mexicanus*), ground squirrels

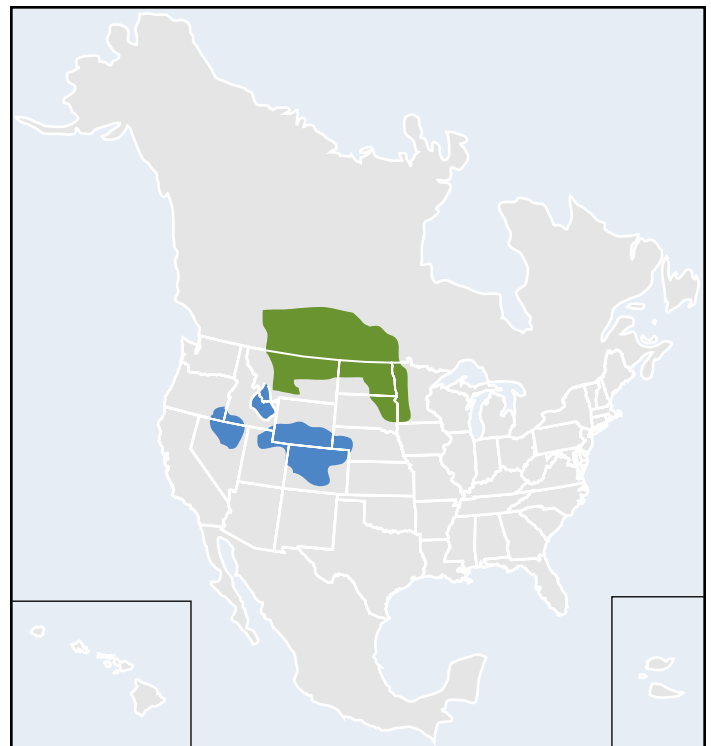

Richardson (*Spermophilus richardson*), and Wyoming (*Spermophilus elegans*) ground squirrels

Range of the ground squirrel in North America (continued).

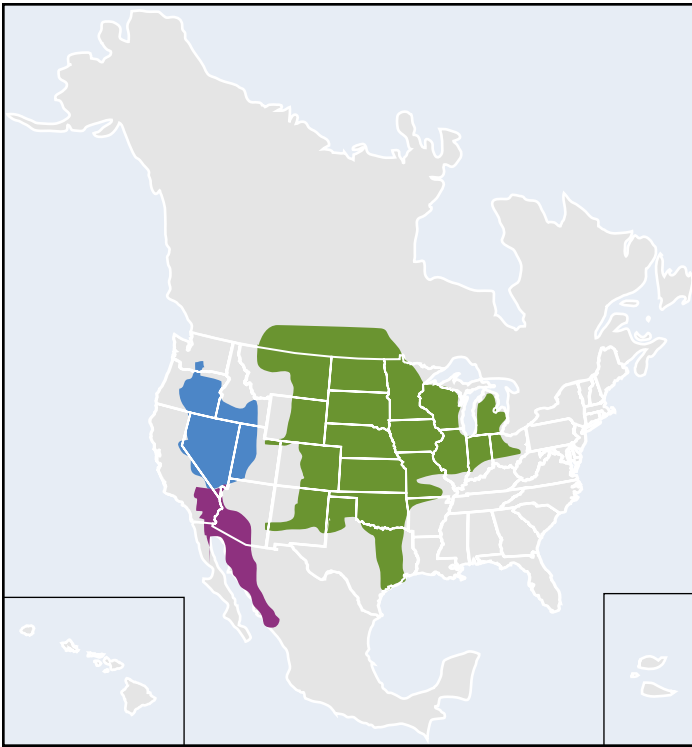

Townsend (*Spermophilus townsendi*), Thirteen-lined (*Spermophilus tridecemlineatus*), and Round-tailed (*Spermophilus tereticaudus*) ground squirrels

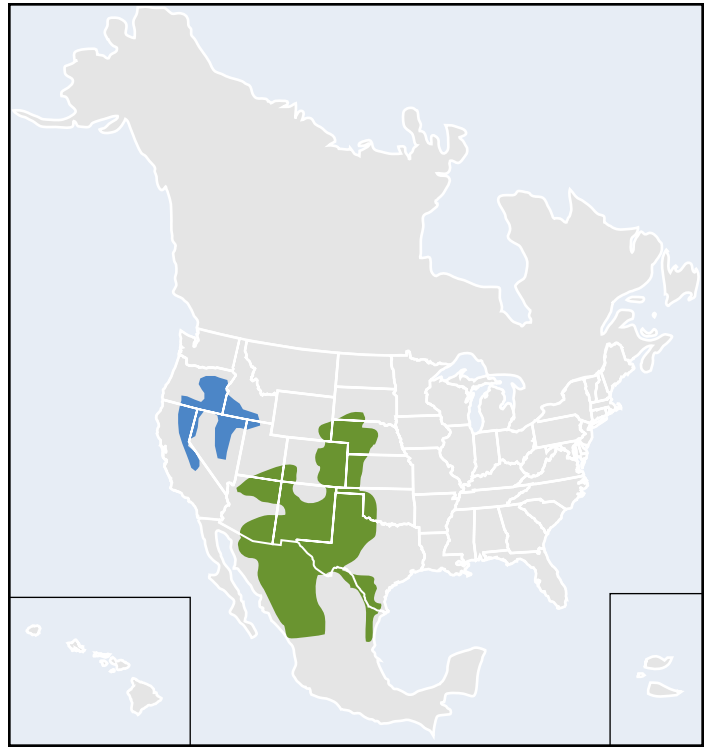

Belding (*Spermophilus beldingi*) and Spotted (*Spermophilus spilosoma*) ground squirrels

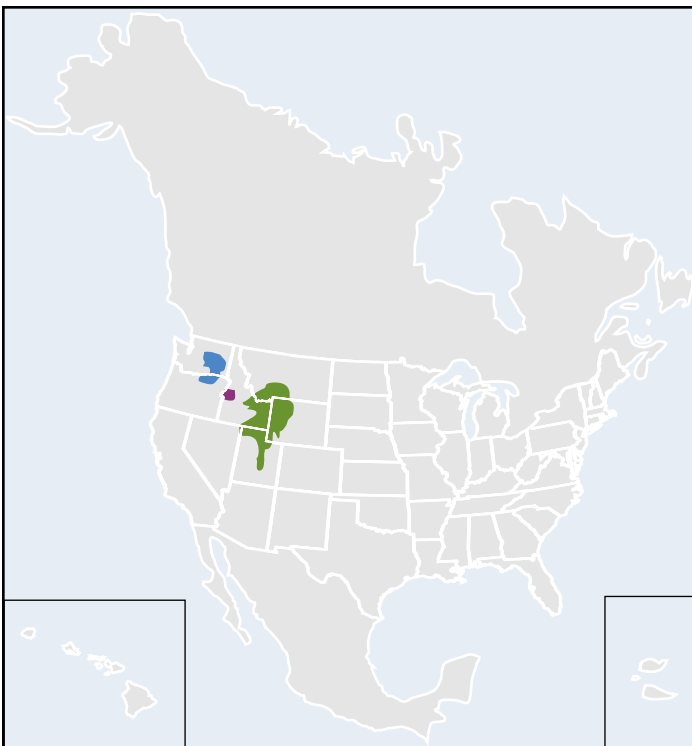

Washington (*Spermophilus washingtoni*), Idaho (*Spermophilus brunneus*), and Uinta (*Spermophilus armatus*) ground squirrels

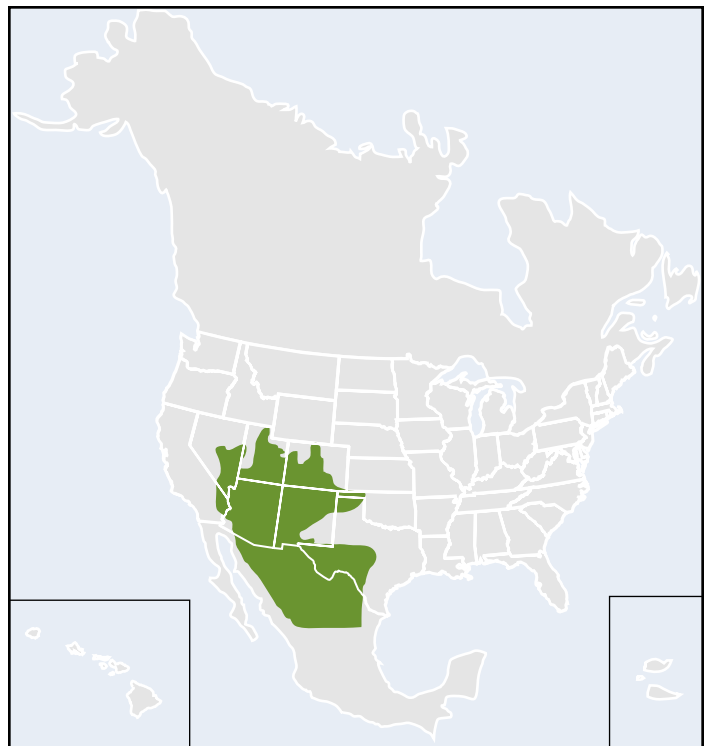

Rock (*Spermophilus variegatus*) ground squirrels

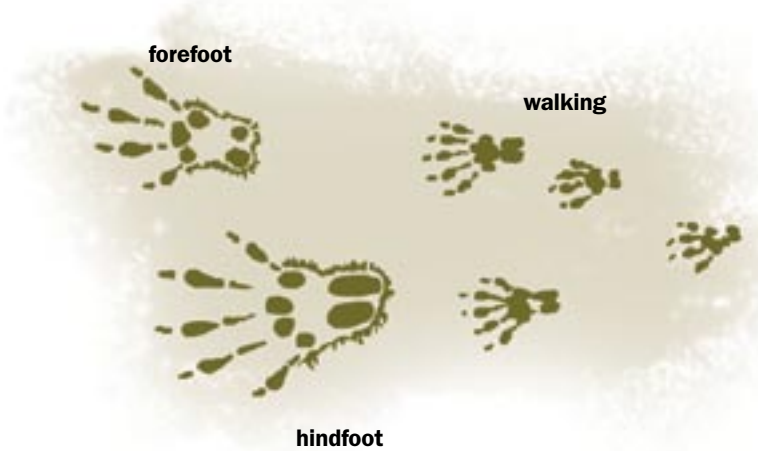

Although ground squirrel tracks will vary in size, they generally show five toes on the hindfoot and four toes on the smaller and rounder forefoot.

**Food Habits:** Ground squirrels mostly eat plant material, although some species may also eat insects, eggs, carrion, and other animal material (USDA, 1991).

**Behavior:** Ground squirrels are only active during the day, and they are most active during mid-morning and late afternoon. They hibernate in the winter, and most species estivate in summer as well (USDA, 1991).

**Field Tip:** During warm months, ground squirrels are quite active during the day and can be easily spotted. Unplugged burrows are a distinctive characteristic of ground squirrel inhabitation (USDA, 1991).

Ground squirrels are considered a significant dam safety issue in 15% of the surveyed states.

#### 4.2.10 Armadillo Overview



The Armadillo (*Dasyus novemcinctus*) is a medium-sized animal, about 8 to 17 pounds, with a protective, armor-like shell on its head, body, and tail. It has nine movable bands across its back, and the tail is covered with a series of overlapping rings. The armadillo has a small head with a long, narrow, piglike snout (University of Nebraska, 1994).

**Threat to Dams:** Armadillos dig burrows that can result in internal erosion and structural integrity losses in dams.

**Habitat and Home:** It prefers forest, woodland and brush habitat, as well as areas near creeks and rivers. The armadillo will also inhabit areas with rocks, cracks, and crevices that are suitable for burrows (University of Nebraska, 1994). Armadillos generally dig burrows 7 to 8 inches in diameter and up to 15 feet in length. They can be found in rock piles, around stumps, brush piles, or terraces around brush or dense woodlands. Armadillos usually have more than one den in an area (University of Nebraska, 1994).

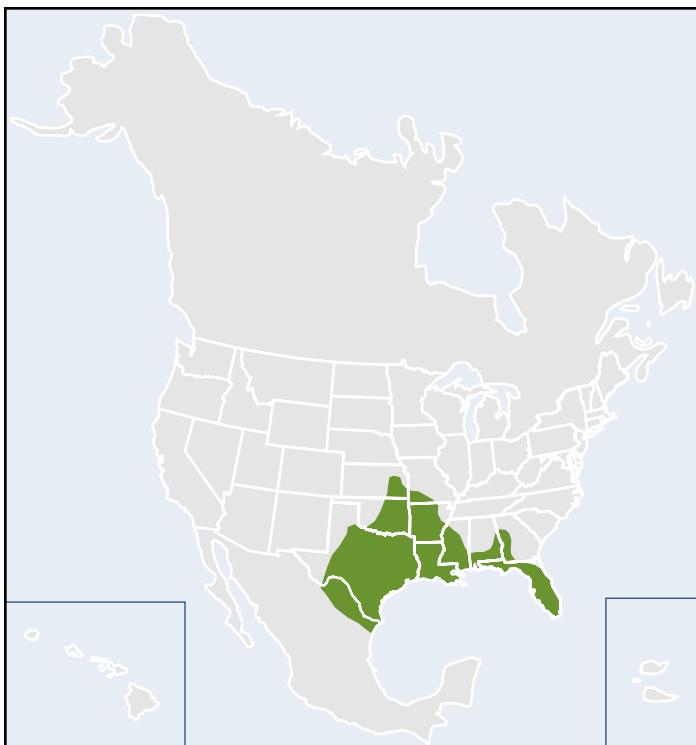

Range of the armadillo in North America.

**Food Habits:** The armadillo primarily eats insects and their larvae. They also feed on spiders, earthworms, scorpions, and other invertebrates. To a lesser extent, they may eat some fruit and vegetable matter (University of Nebraska, 1994).

*Armadillos are considered a significant dam safety issue in 4% of the surveyed states.*

**Behavior:** During the summer, the armadillo is active from twilight through early morning hours, but in the winter, it is usually only active during the day. The armadillo has poor eyesight, but a keen sense of smell. It can run fast when in danger and is also a good swimmer (USDA, 1991).

**Field Tip:** Characteristic signs of armadillo activity are shallow holes, about 1 to 3 inches deep and 3 to 5 inches wide, dug in search of food (University of Nebraska, 1994).

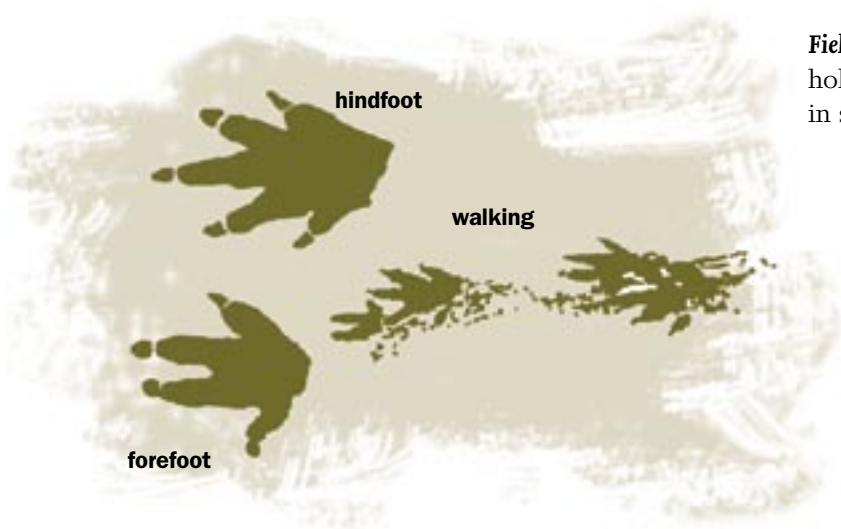

*Armadillos have four toes on their forefeet and five toes on their hindfeet, although not all toes may show up in their tracks. Sharp claw marks are often visible.*



#### 4.2.11 Livestock Overview



Livestock can include cattle, horses, sheep, goats, and pigs of all varieties, domesticated and wild. Livestock exist widely across the United States and utilize earthen dams and farm ponds for grazing and drinking.

**Threat to Dams:** Livestock can damage an earthen dam by removing stabilizing vegetation through grazing, trampling, and rooting. External erosion can occur without vegetative cover, and erosion pathways can be created as livestock traverse the embankment (Figures 4-11 and 4-12). Damages are most severe in arid regions, and damage is often not noted until the wet season when precipitation collects in holes and along erosion pathways. Livestock carcasses could alter or block water flow if located at control structures. Wild pigs commonly damage farm ponds and can cause substantial damage to a grassy area in a single night (University of Nebraska, 1994).

*Livestock are considered a significant dam safety issue in 25% of the surveyed states.*

**Habitat and Home:** Livestock can occur anywhere in the United States. In some cases, several livestock species will graze in one area. Wild pigs can exist in a variety of habitats but prefer dense brush or marsh vegetation as cover. Wild pigs are often found inhabiting livestock-producing areas (University of Nebraska, 1994).

**Food Habits:** Most livestock, including cows, sheep, goats, and horses, are grazers. Pigs, however, generally root for underground vegetation, in addition to feeding on acorns and

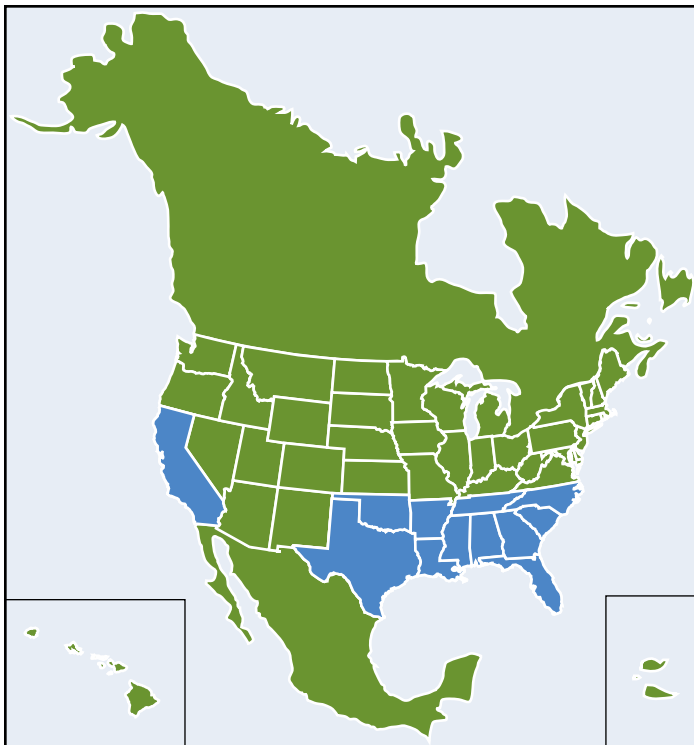

Range of livestock, and wild pigs in North America.

other mast. Livestock disturb soil and vegetation through their feeding methods.

**Behavior:** Location to a water source is considered the primary influence on livestock’s activity within a given grazing area, followed by desirable forage and topography of the grazing area. In hot weather, pigs will wallow in ponds, springs, or streams that contain or are near vegetative cover.

**Field Tip:** Livestock are easily identified as they are often intentionally grazed on lands near farm dams. Wild pigs are obvious if observed, otherwise look for wallows.

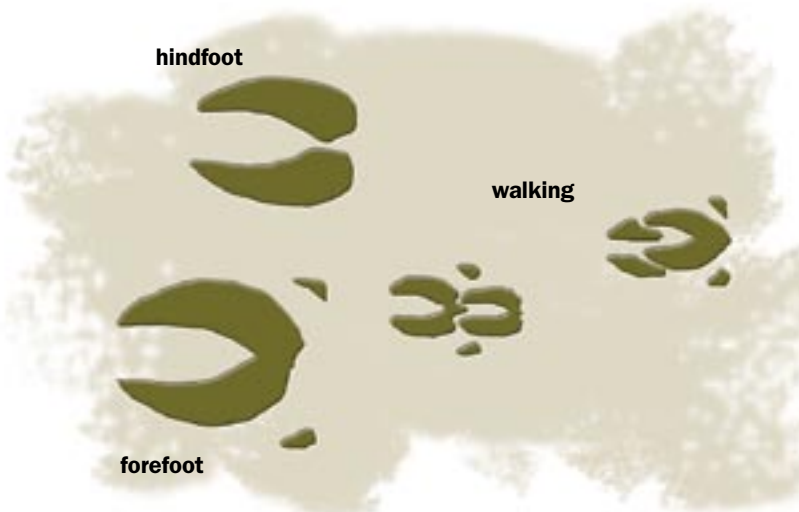

Tracks can be used to identify wild pigs. Tracks are generally not needed to identify other types of livestock since they are often intentionally grazed on lands near farm dams.



Figure 4-11. Livestock can cause external erosion by creating ruts and erosion paths via hoof traffic.

One milk-producing Jersey cow can drink up to 12 gallons of water a day. Herds of dairy cows typically include 50 to 100 animals. That’s a lot of hoof-traffic at an earthen dam!



Figure 4-12. Livestock can remove stabilizing vegetation through grazing and hoof traffic.

#### 4.2.12 Crayfish Overview



Crayfish (*Cambarus* spp.) resemble miniature lobsters. There are over 300 species of various sizes, shapes, and colors in the United States (University of Nebraska, 1994).

Crayfish are considered a significant dam safety issue in 4% of the surveyed states.

**Threat to Dams:** Crayfish burrow into earthen dam embankments; extensive burrowing may cause internal erosion and structural integrity losses.

**Habitat and Home:** Crayfish are found in a variety of fresh water habitats, including streams, rivers, ponds, lakes, swamps, and wet meadows (Peckarsky et al, 1990). Crayfish burrows are usually located along the shoreline close to the water's edge. They may be anywhere from a few inches to three feet deep. The opening is generally about ¼ to 2 inches in diameter with a cone-shaped mound, known as a "chimney," plugging the burrow (Virginia Cooperative Extension, 2001a) (Figure 4-13).

**Food Habits:** Crayfish eat both living and dead plant and animal material. Almost half of their diet consists of bottom-dwelling worms and insects. The rest of their diet consists of

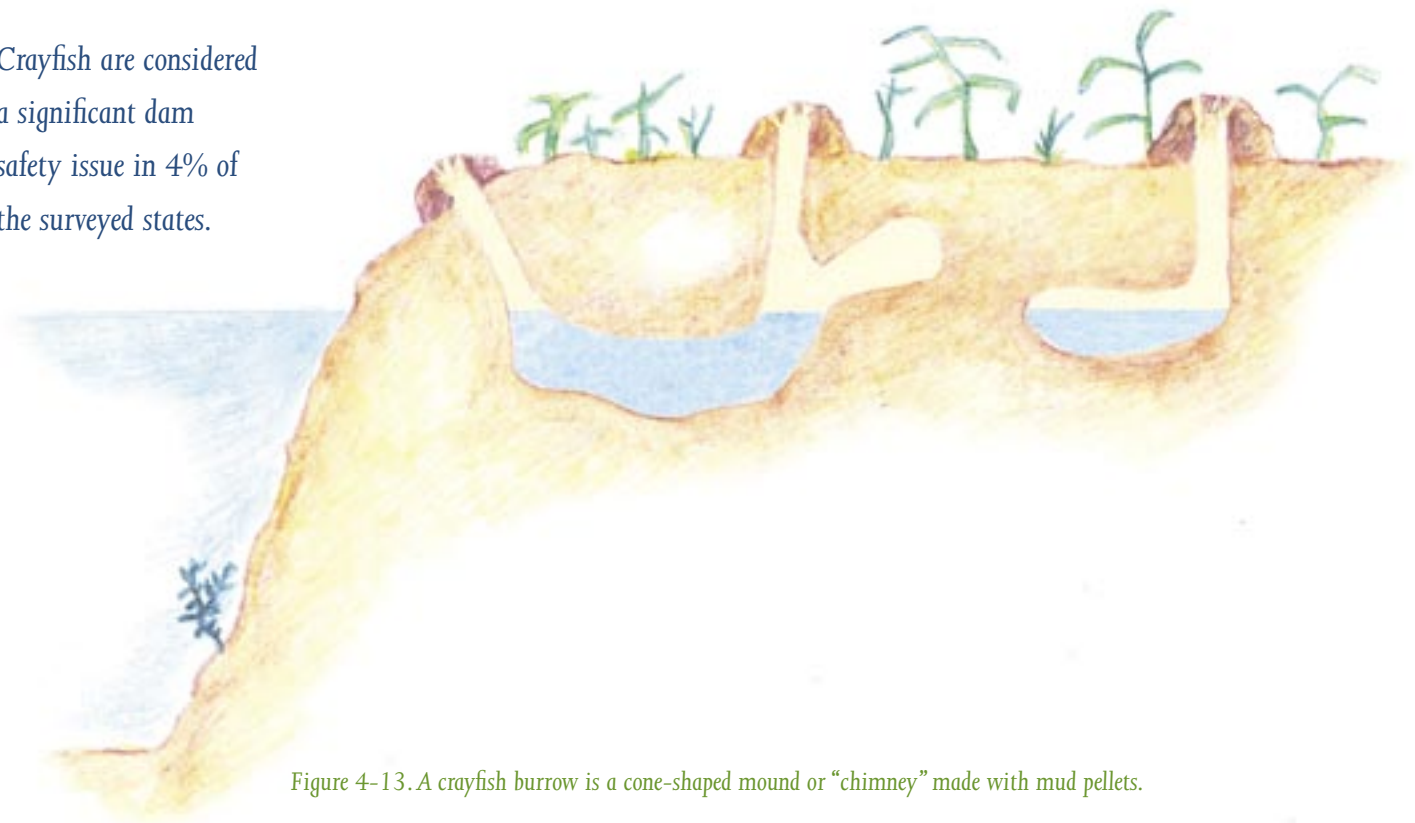

Figure 4-13. A crayfish burrow is a cone-shaped mound or "chimney" made with mud pellets.



Range of the crayfish in North America.

living and decaying aquatic vegetation (Virginia Cooperative Extension, 2001a).

**Behavior:** A crayfish will molt several times in its short lifespan. They can be quite aggressive towards each other and toward anything they perceive as a threat (Peckarsky et al, 1990). Most crayfish dig burrows to use as a refuge from predators and as a resting place during molting and inactive periods (Virginia Cooperative Extension, 2001a).

**Field Tip:** Crayfish stay in their burrows or in mud bottoms during cold weather. They will emerge, and be easier to spot, once the water warms up (Virginia Cooperative Extension, 2001a).

#### 4.2.13 Coyote Overview



The Coyote (*Canis latrans*) is a member of the dog family, and in size and shape, it resembles a small German shepherd, with erect pointed ears, slender muzzle, and a bushy tail. Coyotes are generally brownish-gray with a lighter colored belly, although this varies widely across local populations. In the west, adult males typically weigh 25 to 45 pounds and adult females typically weigh 22 to 35 pounds. Coyotes in the east are usually larger, with adult males weighing about 45 pounds and adult females weighing about 30 pounds (University of Nebraska, 1994).

**Threat to Dams:** Although coyotes do not pose a large threat to earthen dams, den construction or enlargement, and digging out prey that live at the dam can cause structural integrity losses.

*Coyote are considered a significant dam safety issue in 4% of the surveyed states.*

**Habitat and Home:** Coyotes exist in virtually any type of habitat, arctic to tropic. High densities of coyotes even appear in the suburbs of major western cities such as Los Angeles and Phoenix. Their dens are often found in steep banks, rock crevices, sinkholes, and underbrush, as well as open areas. Dens are usually located close to water. Coyotes will often dig out and enlarge burrows of other animals. Size of coyote dens varies from a few feet to 50 feet, and each den often has several openings (University of Nebraska, 1994).



Range of the coyote in North America.

**Food Habits:** Coyotes eat a variety of animals, insects, fruits, and vegetables (University of Nebraska, 1994).

**Behavior:** During hot summer months, coyotes are most active at night and during the early morning hours. During cooler weather, and in areas with minimal human activity, coyotes may be active throughout the day. Coyotes have good eyesight and hearing and a keen sense of smell. Their adaptable behavior and social system allows them to survive, and even flourish, in the presence of humans (University of Nebraska, 1994).

**Field Tip:** Coyotes can often be identified by their tracks, although it should be noted that regular dog tracks are often mistaken for coyote tracks. Coyote dens are often located in the downstream slope.

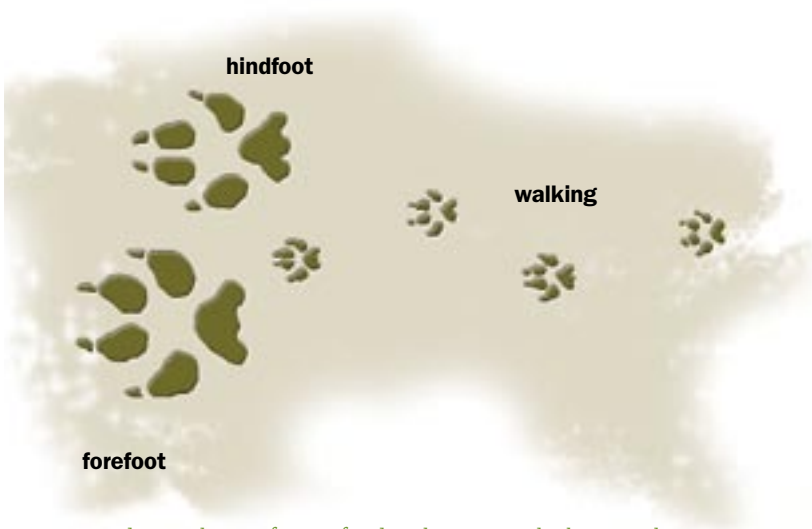

Badger tracks are often confused with coyote tracks, but note that coyotes only have four toes on each foot, while badgers have five toes.

#### 4.2.14 Moles and Voles Overview



Moles (*Scapanus* spp.) are small insectivores that are often confused with voles, shrews, and pocket gophers. Moles, however, can be distinguished by their hairless, pointed snout, small eyes, and webbed forefeet. There are seven different species of moles living in the United States. Adult males grow to a length of about 7 inches and weigh about 4 ounces; adult females are slightly smaller (University of Nebraska, 1994).



Voles (*Microtus* spp.) also known as meadow mice or field mice, are compact rodents with short legs and short tails. There are 23 species of voles in the United States. Most are gray or brown, and about 4 to 8 inches long; although both size and coloration varies across species.

**Threat to Dams:** Earthen dams may provide good hunting grounds for moles. Although they usually make their home burrows in dry, upland areas, they prefer to hunt in areas that are cool and moist. They construct tunnels from their dens to their hunting grounds. If located in an earthen dam, these tunnels may cause internal erosion and structural integrity losses. When present in large numbers, voles may also cause damage to earthen dams. They dig extensive burrow systems that could lead to internal erosion and structural integrity losses in the dam (University of Nebraska, 1994).

*Moles and voles are considered a significant dam safety issue in 10% of the surveyed states.*

**Habitat and Home:** Moles can be found across most of the United States. As mentioned above, they generally construct their burrows in dry, upland areas. Deep runways connect their dens to their hunting grounds (University of Nebraska, 1994) (Figures 4-14 and 4-15, shown on page 51). Voles can also be found across most of the United States. They prefer areas of heavy ground cover, although they can survive in a wide variety of habitats. Burrow systems consist of a series of tunnels and surface runways, and often have several entrances (University of Nebraska, 1994) (Figure 4-16, shown on page 51).

**Food Habits:** Moles primarily eat insects, grubs, and worms. Voles are mostly herbivorous, primarily eating grasses and forbs. Voles will also occasionally eat snails, insects, or animal remains (University of Nebraska, 1994).

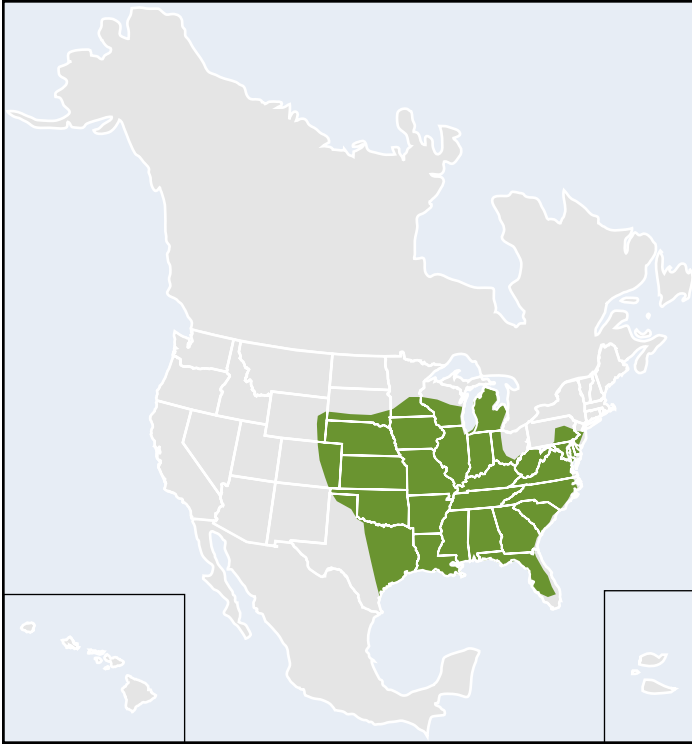

Range of the mole in North America.



Range of the vole in North America.

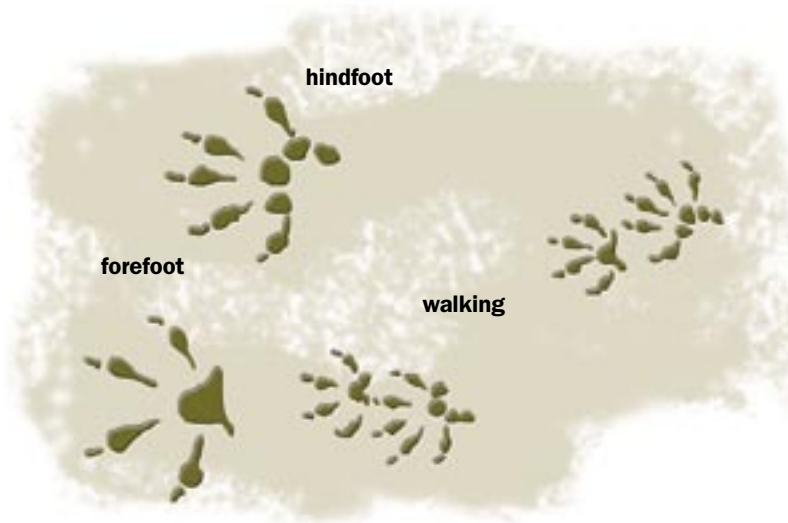

Vole tracks.

**Behavior:** Moles are solitary animals, and they spend most of their time underground. They are active through all seasons of the year. Voles are also active throughout the year, both day and night. They are excellent swimmers and often try to escape from predators through the water (University of Nebraska, 1994).

**Field Tip:** Moles push up volcano-shaped mounds of soil when they are building tunnels. The mounds may be anywhere from 2 to 24 inches tall. Surface tunnels or ridges are also an indication of mole activity. Voles can be identified by their extensive surface runway systems. These runways are generally 1 to 2 inches in width.

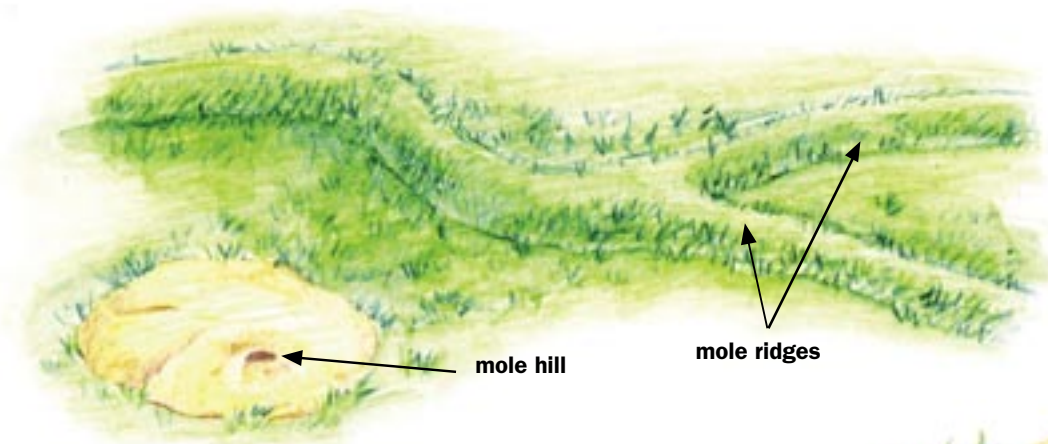

Figure 4-14. Mole burrows form ridges visible from the surface.



Figure 4-15. Moles push dirt vertically to the surface, which forms a mound.

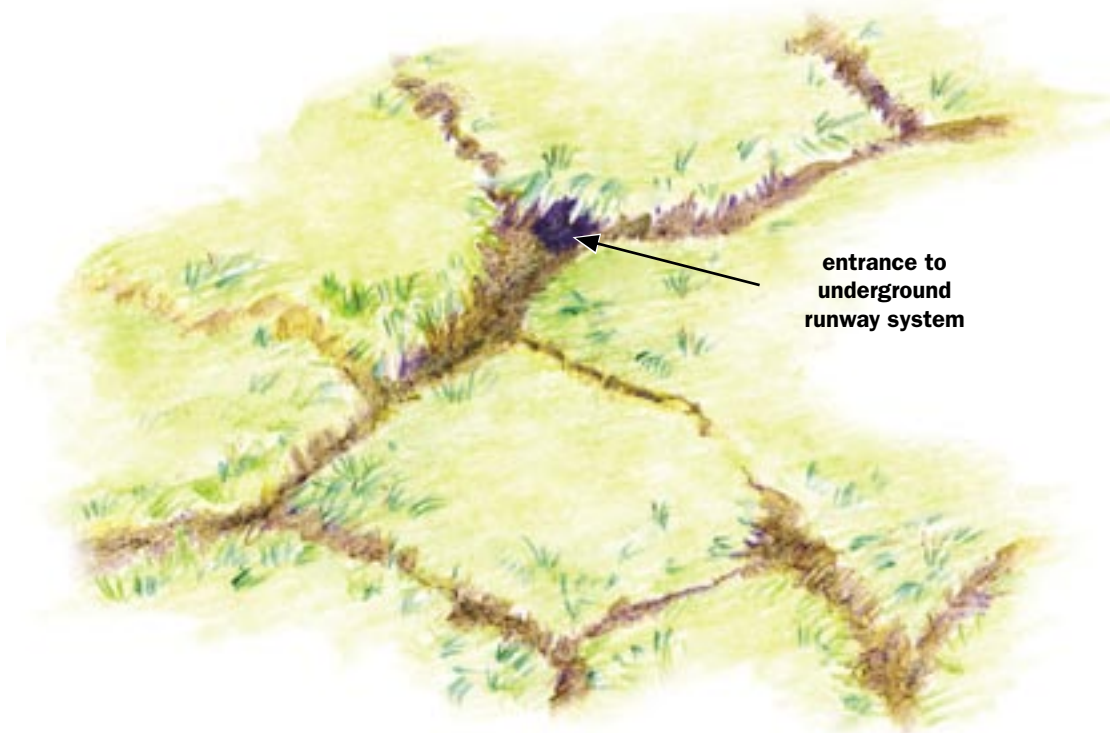

Figure 4-16. Voles are most easily identified by an extensive surface runway system with many burrows.



#### 4.2.15 River Otter Overview



The River Otter's (*Lutra canadensis*) sleek body, short legs, webbed toes, and tapered tail help it thrive in its aquatic environment. Otter fur is thick and shaded from brown to near black on most of the body, with a lighter brown to beige on the belly, chin, throat, cheeks, and chest (University of Nebraska, 1994).

River otters are considered a significant dam safety issue in 4% of the surveyed states.

**Threat to Dams:** Otters sometimes dig bank dens for shelter with an underwater entrance for use in the winter and an above-water entrance for use in the summer (Benyus, 1989). Dens can cause large voids in the dam embankment, and underwater entrances provide pathways for internal erosion and wave action if water levels rise into the embankment den.

**Habitat and Home:** Otters are associated almost invariably with water environments no matter the water type: fresh, brackish, or salt. Water quality, available fish forage, and available den sites are the most important factors in determining otter habitat. Otters can be found in lakes, rivers, streams, bays, estuaries and associated riparian habitat. Otters most often utilize existing bank dens and lodges constructed by beaver, muskrat, and nutria. Otherwise, otters use hollow logs and rock crevices as their shelter and construct natal dens on small streams that lead to major drainages (University of Nebraska, 1994).

**Food Habits:** Otters prefer fish of several varieties, but also feed on shellfish, crayfish, reptiles, and amphibians.

**Behavior:** Otters spend most of the day feeding and participating in group play. Otters are superb swimmers and very alert.

**Field Tip:** Look for slides into the water or snowbank (in winter) where otters play. Look for “haul-outs,” worn areas along the bank where otters consistently pull themselves out of the water. If this area is indeed a haul-out, there will be a trail leading away from the haul-out to a patch of trampled vegetation where otters roll around to dry themselves after a swim or to leave their scent (Benyus, 1989). Listen for the blow and sniff sounds of a surfacing otter.

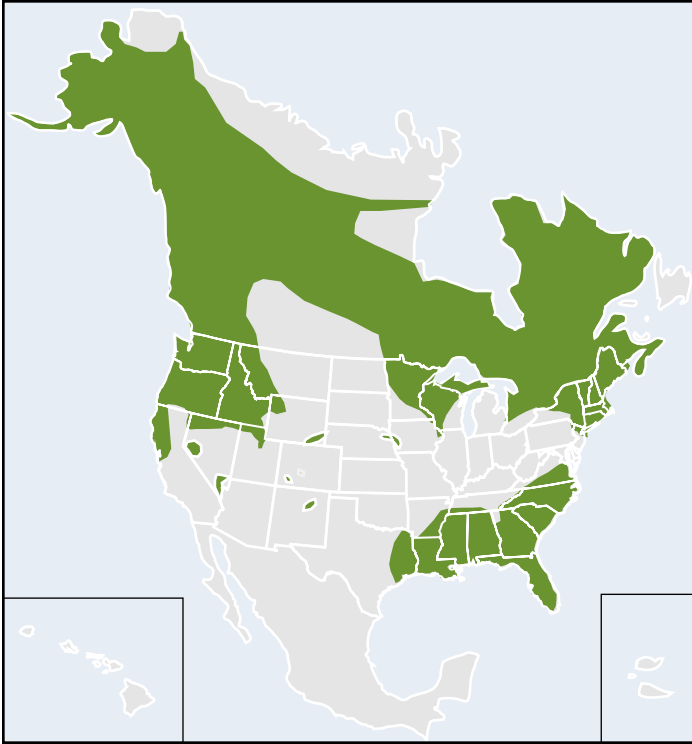

Range of the river otter in North America.

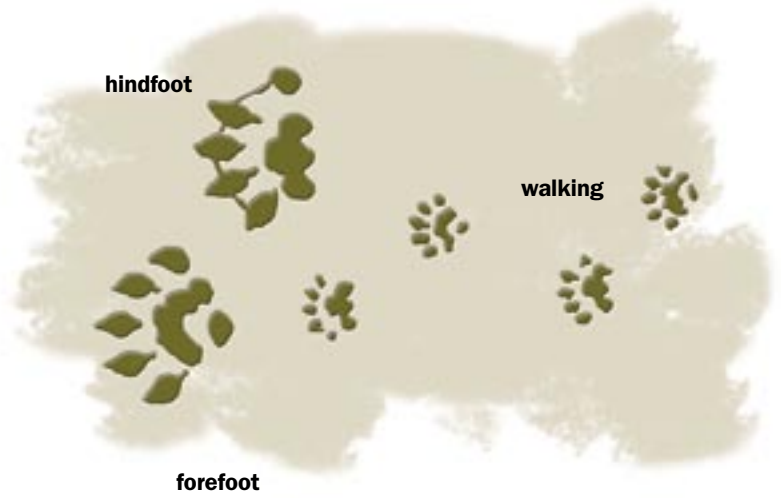

The inner toe of the otter's hind paw juts out to the side.

#### 4.2.16 Gopher Tortoise Overview



Gopher Tortoise (*Gopherus polyphemus*) are large, terrestrial tortoises with a shell length of 10 to 15 inches that weigh about 9 pounds. The gopher tortoise is a protected species and a permit is always required to possess, study, remove, or relocate a specimen (Gopher Tortoise Council, 2001). The burrows of the gopher tortoise are also protected by law. Over 360 animal species have been documented inhabiting a gopher tortoise burrow so use caution when investigating a burrow. Many of the species which coexist in or use gopher tortoise burrows are also protected by state and federal laws, such as the burrowing owl and indigo snake.

**Threat to Dams:** The gopher tortoise's strong claws make it an effective burrower. Burrows can be 40 feet long and 10 feet deep and will include a spacious chamber used to cool off during the heat of the day (Gopher Tortoise Council, 2001). Gopher tortoise burrows can cause structural integrity losses.

Tortoises are considered a significant dam safety issue in 4% of the surveyed states.

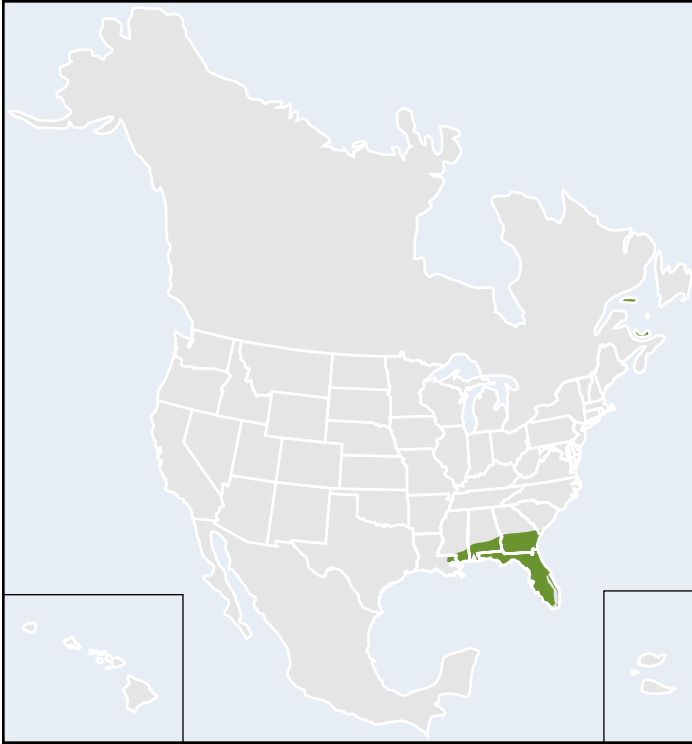

Range of the gopher tortoise in the United States.

**Habitat and Home:** Gopher tortoises prefer to dig their burrows in dry, upland habitats especially where saw-palmetto is present in the understory and sandy soils dominate. Gopher tortoises can live in grassy areas, pastures, and old fields as long as there are well-drained sandy soils, herbaceous plants, and sunny, open areas for nesting and basking (Gopher Tortoise Council, 2001). Look for burrows on the southeastern side of sandy hills (such as old dunes that are covered in vegetation) at a 30-degree angle from the surface (Benyus, 1989; Enchanted Forest Nature Sanctuary, 2003). The burrow entrance, or “apron,” will be marked by a characteristic mound of loose sand. The downstream slope and toe of a dam may be suitable for gopher tortoises, as might a forest fringe in a dam area.

Note: In some cases, snapping turtles may hibernate or lay eggs in an existing muskrat den and as such, are often identified as the responsible burrowing animal. In truth, turtles are more correctly simply associated with burrowing animals, rather than responsible for burrows. Depending on its size, the snapping turtle may enlarge an existing muskrat den.

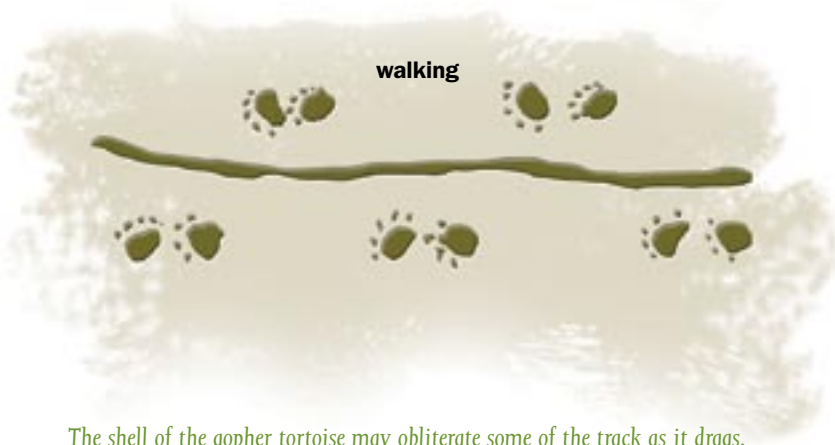

The shell of the gopher tortoise may obliterate some of the track as it drags.

*An east-central Florida study indicates that a male gopher tortoise constructs and uses an average of 17 burrows. Some males construct and use as many as 35 burrows.*

**Food Habits:** Primary food sources of the gopher tortoise include low-growing grasses, herbs, and berries.

**Behavior:** Gopher tortoises emerge from their burrows in the morning to feed and return to the burrows if temperatures get too hot or cold.

**Field Tip:** Look for large mounds of loose sand created as the gopher tortoise digs its burrow.

#### 4.2.17 Red Fox and Gray Fox Overview



The Red Fox (*Vulpes vulpes*) is dog-like in appearance with large pointed ears and an elongated pointed muzzle. It typically has a light orange-red coat with lighter colored underfur, black legs, and a white-tipped tail. Coat coloration can vary from red to gray to black, but the tail tip is always white. Adult red foxes can weigh anywhere from 7.7 to 15.4 pounds; males are about 2.2 pounds heavier than females (University of Nebraska, 1994).

Fox are considered a significant dam safety issue in 4% of the surveyed states.



The Gray Fox (*Urocyon cinereoargenteus*) has a long, bushy tail with a black tip. It is salt-and-pepper gray over most of its body, with some rusty yellow spots on the sides of the neck, back of the ears, legs and feet. Adult gray foxes weigh about 7 to 13 pounds, and measure about 32 to 45 inches from nose to tip of tail (University of Nebraska, 1994).



Range of the red fox in the North America.

**Threat to Dams:** Foxes do not pose a great threat to earthen dams. It is possible that they could cause damage by digging out burrowing animals for food. This type of damage may be prevented with good rodent control and vegetative management.

**Habitat and Home:** The red fox prefers open country with moderate cover, although it is generally adaptable to any habitat within its range. Red foxes are commonly found in urban areas. They may either dig their own dens or use abandoned groundhog or badger burrows. The gray fox prefers areas of dense cover such as swamp land or thickets. Gray foxes can also be found in urban areas. They commonly use wood piles, rocky outcrops, or hollow trees as den sites (University of Nebraska, 1994).

**Food Habits:** Foxes mostly eat rabbits, mice, bird eggs, insects, and fruit (University of Nebraska, 1994).

**Behavior:** Foxes are solitary animals that are most active during twilight and early morning hours. They have a variety of calls that sound like barks, screams, howls, yaps, growls, and hiccups (University of Nebraska, 1994).

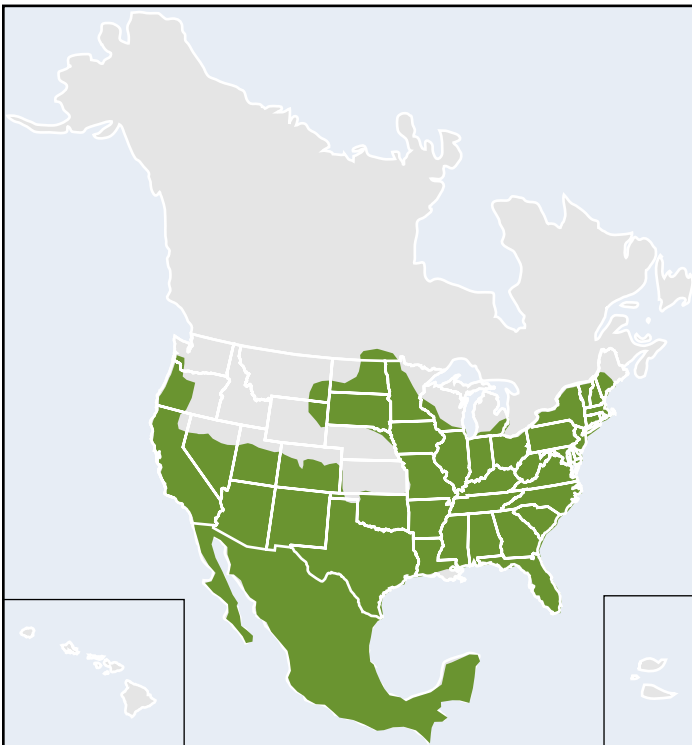

Range of the gray fox in North America.

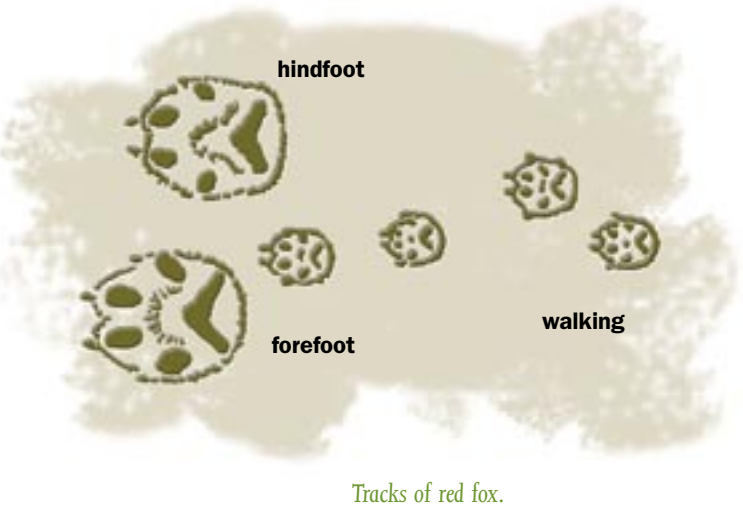

Tracks of red fox.

**Field Tip:** Fox dens may be identified by several 10-inch wide entrance holes, with sandy aprons of soil spilling from them (Benyus, 1989).



Tracks of gray fox.

#### 4.2.18 Canada Goose Overview

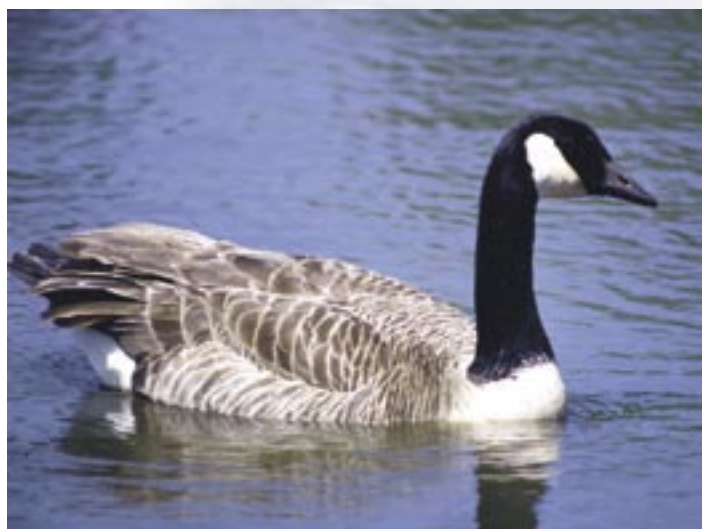

The Canada Goose (*Branta canadensis*) is a large bird that grows to a height of 2 to 3 feet and weighs approximately 10 to 12 pounds. It has a grayish-brown body and wings; black feet, bill and neck; a white underside; and a white patch on each cheek (USDA, 2003). There are 11 subspecies that live in the United States (Virginia Cooperative Extension, 2001b).

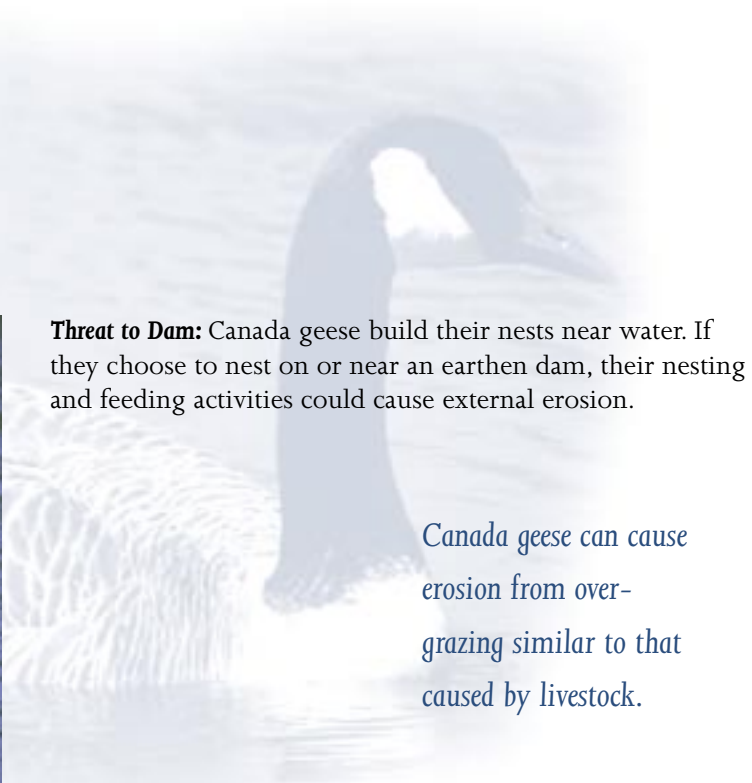

**Threat to Dam:** Canada geese build their nests near water. If they choose to nest on or near an earthen dam, their nesting and feeding activities could cause external erosion.

Canada geese can cause erosion from over-grazing similar to that caused by livestock.

**Habitat and Home:** Canada geese are found across the United States. Many Canada geese spend their summers in Canada and migrate south to the United States during the winter. Some geese, known as resident Canada geese, spend most of the year in the same general area and fly only far enough to find food or open water (Virginia Cooperative Extension, 2001b). Canada geese nest in areas near open water, such as swamps, marshes, meadows and lakes. Nests are typi-



Range of the Canada goose in North America.

cally made from weeds, twigs, grass, moss, and pine needles (University of Michigan Museum of Zoology, 2002).

**Food Habits:** Canada geese eat a variety of grasses and aquatic plants. They will also eat crops such as corn, soybeans, and wheat. Young Canada geese require more protein, and will consequently eat insects, small crustaceans, and mollusks (Virginia Cooperative Extension, 2001b).

**Behavior:** Canada geese are social animals that communicate to each other through a series of calls. They tend to be aggressive birds, particularly the males. They will vigorously defend their territory, nests, and eggs from intruders (University of Michigan Museum of Zoology, 2002).

**Field Tip:** Canada geese can be easily identified by the white patches on their cheeks. In absence of the birds themselves, Canada geese can be identified by their long, black, cylindrical droppings.



Tracks of the Canada goose.

#### 4.2.19 American Alligator Overview



The American Alligator (*Alligator mississippiensis*) is one of the largest animals in North America. Adult males can grow to a length of 14 feet and weight up to 1,000 pounds. Adult females can grow to a length of 10 feet and weigh up to 250 pounds. They have a rounded snout and black and yellow-white coloration (University of Nebraska, 1994). Alligator hunting is allowed in several states under strict quota or licence guidelines.

**Threat to Dam:** Alligators sometimes dig burrows or dens for refuge from cold temperatures, drought, and predators. These burrows can cause internal erosion and structural integrity losses in earthen dams (University of Nebraska, 1994).

**Habitat and Home:** Alligators can be found in almost any type of fresh water, including wetlands, lakes, canals, and streams. They will occasionally inhabit brackish or salt water environments (University of Nebraska, 1994).

*Alligators are considered a significant dam safety issue in 2% of the surveyed states.*

**Food Habits:** Alligators will prey upon whatever creatures are most available, including fish, turtles, birds, mammals, and other alligators. Alligators are opportunistic feeders and will eat carrion if it is available and they are sufficiently hungry. If they are near human environments, they may also eat pets and livestock (University of Nebraska, 1994).



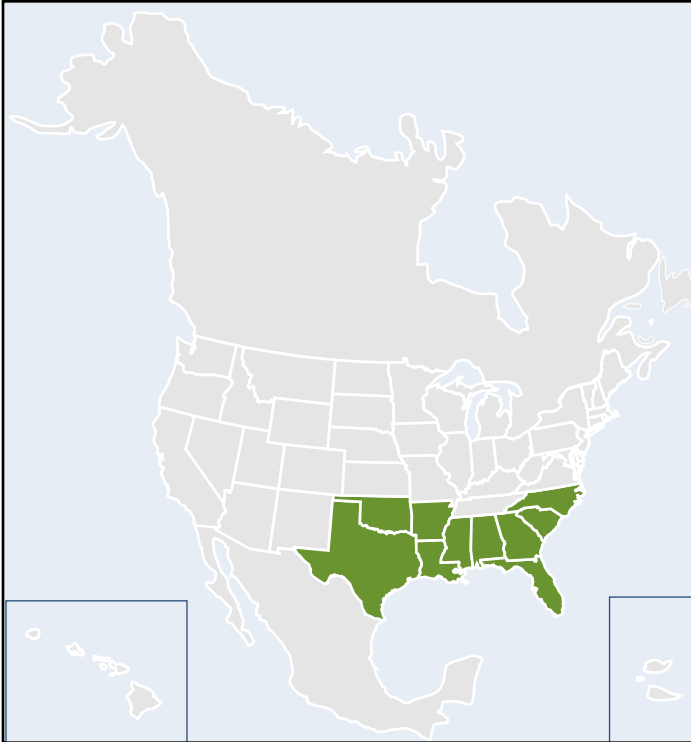

Range of the American alligator in North America.

**Behavior:** Because they are cold-blooded, alligators are most active when the temperature is warm. When the temperature drops below 70°F, alligators will stop feeding, and when the temperature drops below 55°F, they become dormant. Alligators are not typically aggressive toward humans, but they can and will attack if provoked (University of Nebraska, 1994).

**Field Tip:** Alligators are large animals, but they blend into their surroundings. It is important to be vigilant and cautious around any water body in the alligator's range.

#### 4.2.20 Ants Overview



Ants (*Formicidae* spp.) are small insects that live in large colonies. The body of an ant is clearly divided into three sections. Many different species of ants live in the United States. Color and size varies widely across species (University of Florida Cooperative Extension Service, 2002).

**Threat to Dam:** Ants often build their homes underground. Their colonies consist of a complex series of tunnels that exacerbate existing cracks and can “soften” the embankment, threatening the structural integrity of an earthen dam.

**Habitat and Home:** Ants can be found across the United States in a variety of habitats. Most ants live in the soil, although some also live in wood or in the cavities of plants (University of Arizona, 1997).

*Ants are considered a significant dam safety issue in 4% of the surveyed states.*



Range of the ant in North America.

**Food Habits:** Ants eat a variety of foods, including plants, sugars, seeds, and small insects (University of Florida Cooperative Extension Service, 2002).

**Behavior:** Ants are social animals. They live in colonies comprised of one or a few queens and many workers. Some ants have a potent sting (University of Arizona, 1997).

**Field Tip:** Small mounds of soil are often indicative of ant inhabitation.

# 5.0 Dam Repair And Intrusion Prevention Through Design

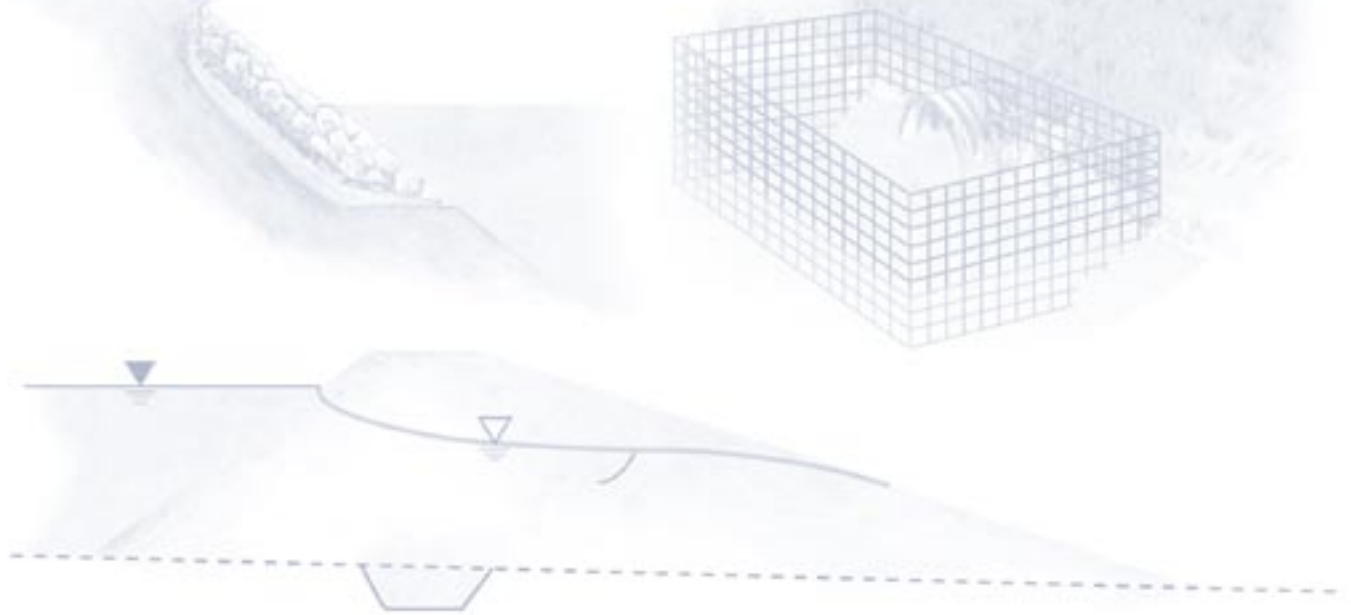

Once the inspection is completed according to the guidelines (refer to Chapter 3.0) and considering the biological perspectives presented in Chapter 4.0, the dam specialist will need to take action relative to damages found at the dam. Specifically, the dam owner will need to repair burrow or beaver dam damage, and determine the appropriate level and type of prevention action (e.g., reinforced concrete wall and slab system on upstream slope to prevent muskrat burrows). This Chapter first outlines burrow repair procedures, followed by a discussion of each earthen dam zone (which corresponds to the zones described in Chapter 3.3 of this manual) with regard to the relative priority of prevention action for each zone. Lastly, design options to mitigate and prevent future animal intrusions are presented for each wildlife species. The prevention methods in this chapter relate to modification of the dam or its structures; a discussion of prevention through animal control methods (e.g., trapping) is presented in Chapter 6.0.

The majority of the prevention action design criteria of this Chapter are meant to be incorporated when major features of the dam can be easily altered such as during new dam construction or dam repair construction, when the majority of the dam or a large portion of the dam will be reworked.

The input of a professional engineer is required to ensure proper design and construction of prevention actions.

## 5.1 Conformity to the Clean Water Act of 1972

The Clean Water Act of 1972 (CWA) is the primary guidance for protecting surface water quality in the United States. The goals of the CWA are to restore and maintain the chemical, physical, and biological integrity of the nation's waters so that they can support "the protection and propagation of fish, shellfish, and wildlife and recreation in and on the water." Towards these goals, the CWA sets water quality standards for waterbodies, which are upheld by antidegradation policies and programs, ambient monitoring, and pollutant load reduction strategies as necessary.

In the dam environment, extensive vegetation removal, burrow excavation and repair, and dam restoration measures could trigger the CWA if dredged or fill materials could be deposited into wetlands or Waters of the United States. As such, all remediation activities must be completed in accordance with the CWA and its provisions, and coordination with the State Dam Safety Official and the State Water Resources Agency is required.

## 5.2 The Role of Vegetation Management

Proper vegetation management is a cornerstone of effective wildlife intrusion management. In most cases, wildlife will not inhabit an earthen dam that does not provide vegetation for food supply, protective cover, or shelter. If a variety of vegetation exists at the dam, then wildlife will choose to inhabit the earthen dam environment over other areas lacking in vegetation or without a water supply. Ideally, the earthen dam environment will contain appropriate grass species maintained such that dam inspections can be conducted easily without visual obstruction of the embankment and other appurtenant structures. Vegetation such as dense groundcover and thick, woody trees and shrubs not only hinder dam inspections, but can also obscure indicators of potential performance problems such as animal burrows, settlement, depressions, cracks, and similar issues. If vegetation is too thick, animal burrows can go undiscovered and proper animal intrusion mitigation may not occur.

In general, it is advised to limit vegetation at the earthen dam to low-growing native grass that is mowed regularly, and to keep the embankment and spillway inlet and outlets free of vegetation. Vegetated emergency spillways should be maintained in a similar fashion as the dam embankment. Maintained grass will accommodate thorough inspections and limit the number of wildlife species that can easily inhabit the dam. If a dam contains vegetation other than appropriate grasses, then the dam owner should complete mitigation and management as outlined in the FEMA document, *A Technical Manual on the Effects of Tree and Woody Vegetation Root Penetrations on the Safety of Earthen Dams* (FEMA, 2002) and the FEMA brochure, *Dam Owner's Guide to Plant Intrusion of Earthen Dams* (FEMA, 2003).

## 5.3 Burrow Repair Procedures

Repair actions can be separated into two categories: restoration measures and preventive measures. As the names imply, restoration measures address repairing a deficiency, whereas preventive measures prevent or avert future damage in the area. Specific restoration and preventive measures applicable for various locations in the dam are discussed below.

### 5.3.1 Restoration Measures

Damage from animal intrusions can occur throughout the dam. The damage can include removal of surface vegetation, rutting, and burrowing. Regardless of the damage location, applicable restoration options depend upon the judged severity of the damage.

## Filling Ruts and Near Surface Deformation

Ruts, near surface deformation, and loss of vegetation can be the result of frequent animal crossings, most likely by livestock. Repair of these deficiencies is generally considered not critical. However, if left unattended for a sufficiently long period of time, these deficiencies can result in a progressive loss of vegetation and surface soils due to erosion. In extreme cases, the damage can lead to increasing amounts of erosion in localized areas, jeopardizing performance and requiring significant maintenance. Timely repair of ruts and vegetation loss can save considerable effort and expense later.

The repair methodology for ruts, surface deformation, and vegetation loss includes the following steps:

1. Fill the rut with soil of a similar type to that of the dam embankment. Overfill the rut slightly to account for compaction of the fill material.
2. Compact the soil using hand held or walk behind equipment. In order to achieve reasonable compaction, the fill material should not contain particle sizes greater than 1 inch in diameter. For larger ruts, and ruts created by vehicles, larger diameter material may be acceptable. The compacted surface should be smooth and level with the surrounding ground.
3. Revegetate the area with grass species appropriate for the region (see Chapter 5.2).

## Filling Burrows

Methods for repairing or filling an animal burrow are essentially limited to two basic types. The first method considers filling the burrow without excavation while the second method considers excavating the burrow and backfilling the area. Details for each method are discussed below.

Observed burrows without signs of embankment distress (e.g., cracking, slumping) in the area may simply require filling with an impervious material or cementitious grout. To fill the entire burrow, a process often referred to as “mud-packing” can be applied. This method consists of placing one or two lengths of metal stove or vent pipe vertically into the burrow. When the pipe is properly sealed, a slurry of 90% earth and 10% concrete, plus an appropriate amount of water to make the slurry flow, is placed in the pipe and allowed to flow into the burrow (Virginia Dam

Safety Program, 2003). The last 6 inches is filled with dirt that will support grass growth.

On the other hand, signs of embankment stress surrounding a burrow may indicate massive soil movement into the burrow. In these cases and at the owner's discretion, complete removal of the burrow is preferred. Shovels or backhoes could be necessary during excavation depending upon the burrow location, size, and depth. Excavation limits will be defined by the burrow size and location as well as the density and type of embankment material. Prior to excavation, dam safety professionals and dam owners should examine potential consequences of soil removal, including slope instability and increased hydraulic gradient. The completed excavation should be thoroughly inspected for adequate removal of the animal burrow. Voids remaining from an animal burrow can develop into potential internal erosion pathways or sinkholes.

Once excavation is complete, the resulting hole must be properly backfilled in a timely manner. Acceptable backfill

*A local dam safety professional should be notified prior to any excavation activities in an embankment dam.*

material should consist of soil types (e.g., sand, clay, etc.) similar to that of the surrounding embankment. If desired, laboratory index testing such as grain size and Atterberg Limits of the backfill and embankment materials may be performed. To achieve adequate compaction of the backfill materials, necessary laboratory testing of backfill materials should include a maximum dry density determination by either the Standard or Modified Proctor test (ASTM D-698 or ASTM D-1557). Backfill material should be compacted to a minimum of 95% of the maximum dry density and within +/- 2% of the optimum moisture content, as determined by ASTM D-698. The completed backfilled surface should be smooth and approximately level with the surrounding ground surface. Backfill should be placed and compacted in lifts of no more than 8 inches thick. A 2 to 4-inch gap can be left between the top of the completed backfill surface and surrounding ground surface to accommodate topsoil.

The final step is to revegetate the disturbed area. Native grass species appropriate for embankment dam slopes should be provided (see Chapter 5.2).

### 5.3.2 Preventive Measures

For a specific animal intrusion or animal related deficiency, appropriate preventive measures are highly dependent on the affected area's location on the dam. Therefore, common preventive measures are discussed in the context of the Repair Zone in the following section. The use and effectiveness of preventive measures should be assessed by the dam owner in conjunction with a dam safety professional. It may not be cost effective to employ these measures for treatment of animal intrusions alone; however, coincident benefits such as protection against wave erosion and plant intrusion may make the measure more fiscally viable.

### 5.4 Dam Repair Zones

As discussed in this manual, a variety of animals can damage an embankment dam. The damage can be surficial with minor impact to dam safety or performance, or the damage can directly threaten the integrity of the dam, potentially leading to failure. However, all animal impacts should be considered undesirable and must be repaired. Dam regulators, owners, and engineers should develop an understanding of the potential impact of an animal intrusion to properly evaluate its impact on the safety and performance of the dam (refer to chapter 2.0 for a discussion on animal intrusion impacts).

Prioritization of necessary repairs is critical to maintain a proactive approach to repair and maintenance of a dam. With limited available capital, many dam owners may delay or avoid necessary dam repairs. In addition, routine safety inspections by either regulatory personnel or consulting engineers tend to overwhelm dam owners by listing all observed deficiencies without a clear indication of the relative importance or seriousness of each deficiency. The relative importance and criticality of a specific deficiency depends on the size and nature of the observation (length, width, depth, area, etc.) as well as its location.

Developing a well-defined methodology for evaluating observed deficiencies will permit dam safety professionals to accurately communicate repair prioritization to dam owners. Chapter 3.0 describes an inspection process that considers both engineering and biological perspectives for a dam divided into five distinct zones. These dam zones cor-

respond to specific physical areas of the dam as illustrated on Figure 5-1 (ASDSO, 2001). The intent of the zones is to differentiate and prioritize animal intrusion damages based on their potential impact to dam safety or performance. Depending on the type of animal intrusion or deficiency observed, one or more zones may be considered critical and require near term or immediate repair. However, these critical zones will vary with the dam as well as the dam inspection. Therefore, the zones are not ordered by their importance; rather they are simply ordered from upstream to downstream.

The following sections provide a description of each repair zone, potential damage from animal intrusion, and suggested preventive measures. These descriptions are limited to animal intrusions and their impact to embankment dams. However, other deficiencies such as plant intrusion and erosion can occur within each repair zone. Where appropriate, restoration and preventive measures should consider all observed deficiencies in the area.

### 5.4.1 Dam Repair Zone 1

Zone 1 begins on the upstream slope at a point approximately 4 vertical feet below the normal pool elevation and extends to the center of the crest. A 4-foot vertical distance was recommended by Marks, et.al. (ASDSO, 2001) to account for average fluctuations in the normal pool and typical underwater animal burrows. The size of Zone 1 can vary significantly from dam to dam because it depends upon the distance between the crest elevation and the normal pool elevation. This distance is often referred to as freeboard.

The relative importance of Zone 1 depends upon the crest width and freeboard. For a dam with a wide crest and large freeboard, animal intrusion within Zone 1 becomes less critical. However, as the crest narrows and freeboard lessens, the importance of repairing deficiencies in Zone 1 increases rapidly.

The most common animal intrusions within Zone 1 are muskrat burrows in which the burrow entrance is underwater as shown on Figure 5-2. However, other intrusions are possible depending upon the specific characteristics of the

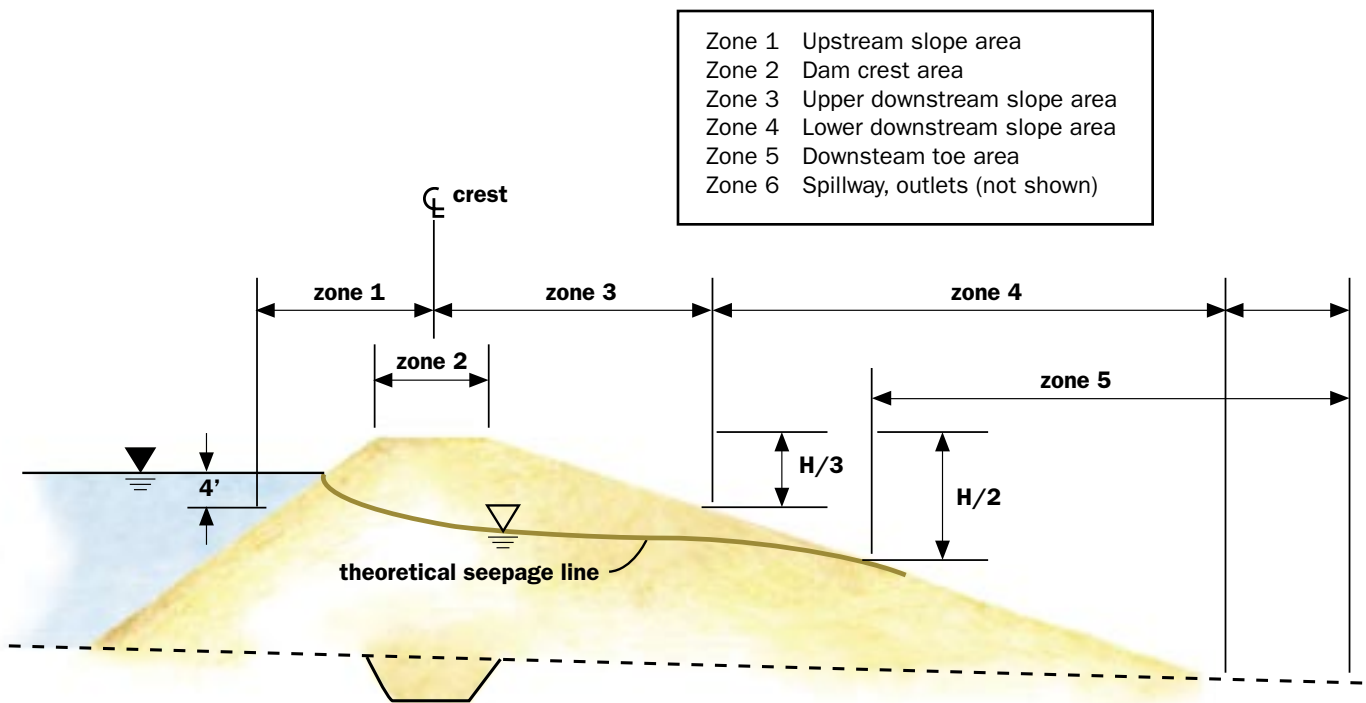

Figure 5-1. Remedial dam repair zones.

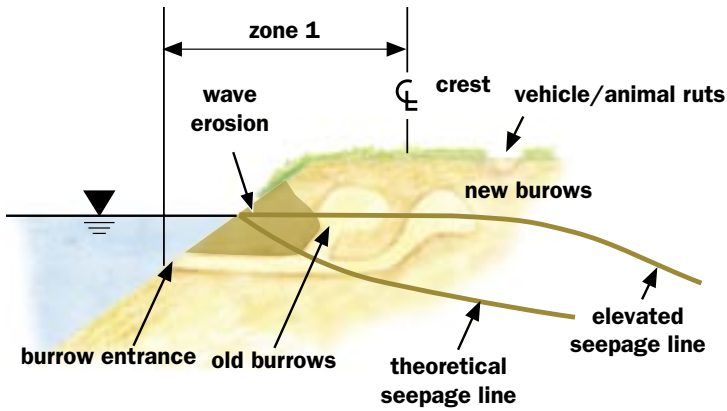

Figure 5-2. Zone 1 Penetration Problems.

dam and reservoir that include geographic location of the dam, proximate vegetation, and prevailing weather patterns. Zone 1 is also susceptible to other forms of deterioration including wave erosion, vehicle access, surface water erosion, and plant intrusion.

To effectively repair animal intrusions in Zone 1, the reservoir pool must be lowered as far below the observed deficiencies as necessary to allow proper access during construction. If the dam owner is unable or unwilling to lower the reservoir pool, then the repair costs will likely increase dramatically to account for necessary water management and diversion.

Preventive measures acceptable for use along the upstream slope generally consist of hardened or structural features. The intent is to provide a physical barrier to the animal, thus making the area much less attractive as a burrow site. These features include riprap, concrete facing, revetment mats, gabions, large gauge wire mesh, and mechanically stabilized earth walls among others. With proper design and installation procedures, each of the methods can be successful. Two of the more common measures are riprap and concrete facing because they are relatively simple to design and provide protection from wave action and plant intrusion as well as animal intrusion.

- A typical cross section of riprap, shown on Figure 5-3 (Ohio DNR, 1999) should consist of a layer of rock riprap overlying bedding material and filter material or a geotextile separator. Limits of the protection should extend at least 4 feet below the normal pool elevation and several feet above depending on estimated wave

heights and average reservoir fluctuation. Rock size and layer thickness will vary significantly from dam to dam depending on the reservoir size, prevailing winds and other physical characteristics of the area. Therefore, material (e.g. riprap, bedding and filter) sizes and layer thickness, must be based on the anticipated wave action, ice thickness, and compatibility with neighboring materials. A number of guidelines including Technical Release No. 69 developed by USDA, Natural Resources Conservation Service can assist dam safety professionals in detailed design for riprap slope protection.

- A typical cross section of concrete facing as shown on Figure 5-4 (Ohio DNR, 1999) will resemble riprap in that the concrete will overlie a filter material. As with riprap, the concrete facing limits should extend at least

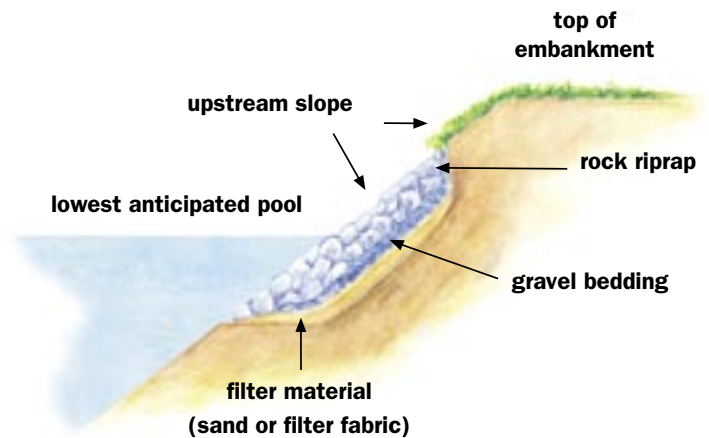

Figure 5-3. Riprap Repair in Zone 1.

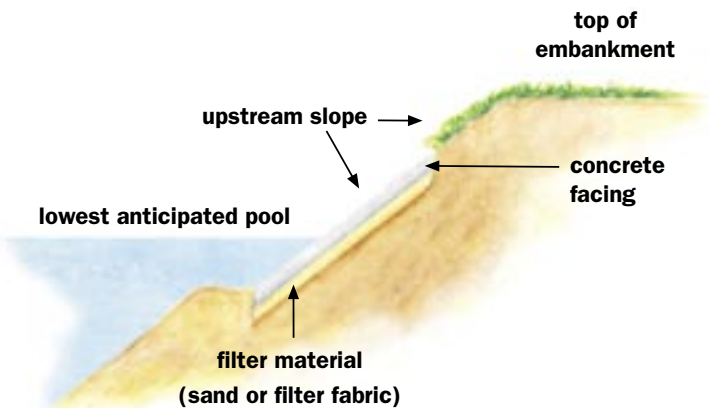

Figure 5-4. Concrete Facing in Zone 1.

4 feet below the normal pool elevation and several feet above, depending on estimated wave heights and average reservoir fluctuation. Concrete thickness, compressive strength, and reinforcing depend on wave action, freeze/thaw cycles and other factors.

Regardless of the measure selected, proper implementation requires specific design recommendations from a qualified dam safety professional.

### 5.4.2 Dam Repair Zone 2

Repair Zone 2 corresponds to the limits of the dam crest and, therefore, overlaps with Zone 1 by one-half of the crest width. Overlapping a portion of Zone 1 with Zone 2 emphasizes the importance and critical nature of both zones. This overlap essentially suggests that both zones be inspected twice during a dam safety inspection.

As with Zone 1, the relative importance of Zone 2 depends upon the crest width and freeboard. For a dam with a wide crest and large freeboard, animal intrusion within Zone 2 becomes less critical. However, as the crest narrows and freeboard lessens, the importance of repairing deficiencies increases rapidly. These intrusions may include terrestrial animal burrows such those made by groundhog, but most typically include ruts and other minor deformations. Zone 2 is also susceptible to other forms of deterioration including vehicle access, surface water erosion, and plant intrusion.

Restoration of animal penetrations within Zone 2 should follow the guidelines presented in Chapter 5.3. Any excavation activities within a dam embankment should be coordinated with a dam safety professional.

Applicable preventive measures for Zone 2 include hardening the crest surface with stone, concrete, or asphalt. These measures tend to prevent rutting from animal and vehicular traffic. Design of these measures depends upon the specific characteristics of the dam and expected loading conditions.

### 5.4.3 Dam Repair Zone 3

Repair Zone 3 begins at the crest centerline and extends to a point on the downstream slope equivalent to one-third the structural height of the dam below the dam crest elevation. As with Zone 2, Zone 3 overlaps Zone 2 by one-half of the crest width to emphasize the importance of the dam crest area. However, the remaining portion of Zone 3 is typically considered the least critical dam repair zone relative to dam

safety issues (ASDSO, 2001). The phreatic surface and zone of saturation within the embankment are generally below the depths of average animal burrows and should not interfere with restoration activities.

Zone 3 is the most attractive area for burrows of terrestrial animal, including groundhog, fox, and coyote. Similar to all other zones, Zone 3 is also susceptible to other forms of deterioration including vehicle access, surface water erosion, and plant intrusion.

Restoration of animal penetrations within Zone 3 should follow the guidelines presented in Chapter 5.3.1 and as shown on Figure 5-5. Any excavation activities within a dam embankment should be coordinated with a dam safety professional.

Applicable preventive measures for Zone 3 (beyond the limits of Zone 2) are limited. Use of hardening materials such as stone, riprap, or concrete is generally discouraged by dam safety professionals because they obscure the surface and prevent detailed inspection. Installation of wire mesh or fencing (e.g., chain link fencing) directly on the ground surface can effectively deter to burrowing animals. With properly sized openings, the wire mesh deters animal intruders and accommodates inspection of the area. However, these materials can represent an obstacle to routine maintenance activities such as mowing and be viewed as a tripping hazard.

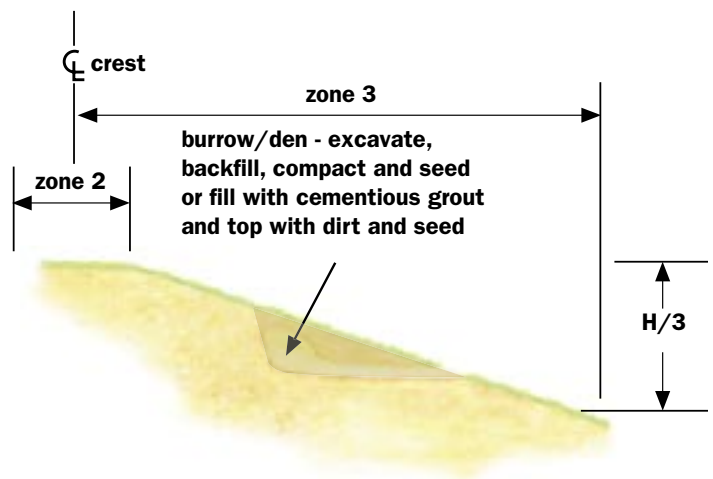

Figure 5-5. Zone 2 and 3 Repair Procedures.



#### 5.4.4 Dam Repair Zone 4

Repair Zone 4 extends from the point on the downstream slope that is one-third the dam's structural height below the crest to the toe of the downstream slope. Zone 4 is one of the two most critical dam repair zones relative to dam safety issues because of the proximity of the phreatic surface and zone of saturation to the embankment slope.

Animal and plant intrusions within this repair zone should be of major concern to dam owners and dam safety professionals. Any animal intrusion or dam penetration should be thoroughly evaluated for potential impact to dam safety and for the required repair.

Restoration of animal burrows within Zone 4 should follow procedures presented in Chapter 5.3. However, due to the proximity of the phreatic surface to the animal burrow, the increased potential of soil migration and, therefore controlling water in the restored burrow must be considered. As shown in Figure 5-6, the use of filter materials within the backfilled burrow can control internal erosion, and with small diameter plastic piping, can manage the flow of water in the area.

Similar to Zone 3, use of hardening materials such as stone, riprap, or concrete is generally discouraged by dam safety professionals because they obscure the surface and prevent detailed inspection. The use of wire mesh or fencing as discussed for Zone 3 is also applicable to Zone 4. It is essential that restoration and preventive measures in Zone 4 undergo review from a dam safety professional prior to implementation.

#### 5.4.5 Dam Repair Zone 5

Repair Zone 5 begins at the mid-height of the downstream slope and extends to a distance of one-half of the dam's structural height horizontally beyond the downstream toe. Zone 5 overlaps a large portion of Zone 4 to emphasize the most critical portions of both zones and heighten scrutiny during inspection. Zone 5 is typically considered the most critical zone relative to dam safety issues (ASDSO, 2001) because the interception of the phreatic surface and downstream slope is typically located in this zone for homogeneous dams.

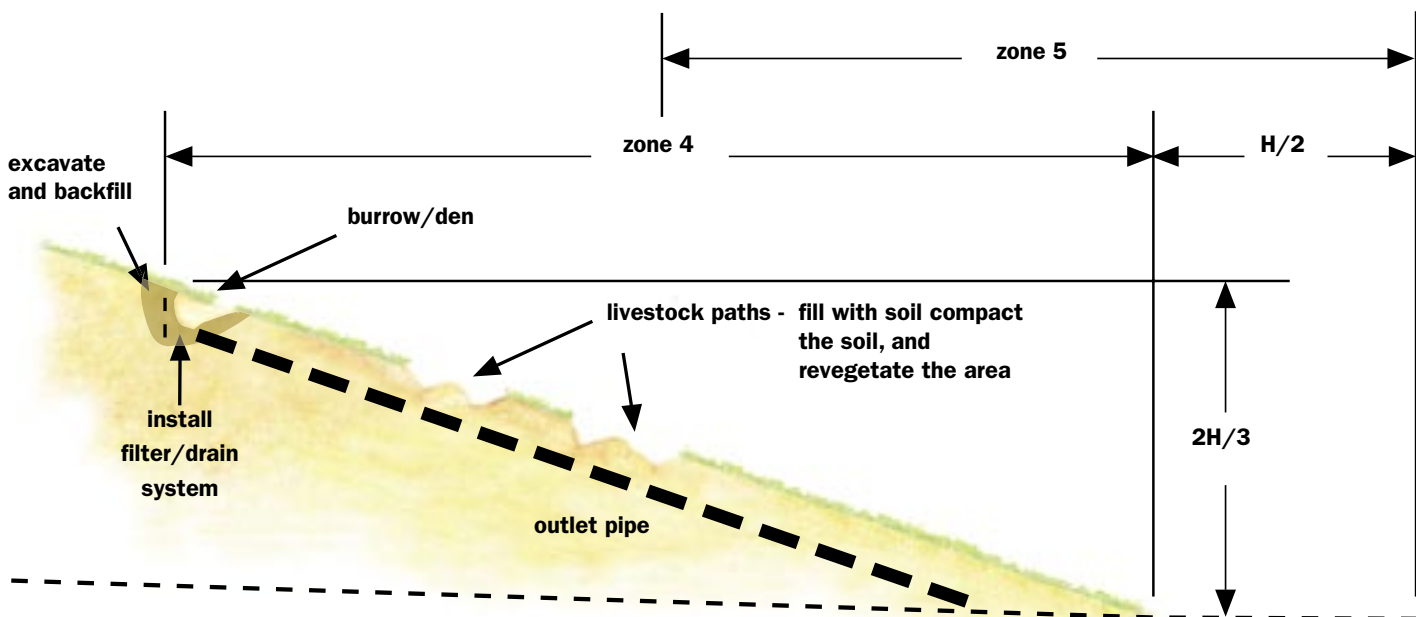

Figure 5-6. Zone 4 and 5 Repair Procedures.

Animal and plant intrusions in this zone often develop into serious conditions involving seepage and piping that are progressive and can lead to dam failure if left untreated. The installation of filter and drain systems to control soil migration and manage seepage must be considered in Zone 5. Similar to Zone 3 and 4, the use of wire mesh or fencing to deter animal intruders can also be considered in Zone 5. It is essential that restoration and preventive measures in Zone 5 undergo review from a dam safety professional prior to implementation.

## 5.5 Professional Dam Safety Review

Construction or repair activities on an embankment dam should be reviewed by a dam safety professional prior to initiation. Due to the complexity of interaction among animal penetrations, the phreatic surface, slope stability, and other deficiencies, the impact of excavation activities on a dam can be unpredictable without thorough review by a qualified professional. This review should include the following elements at a minimum:

- Evaluation of the existing dam relative to the position of the phreatic surface and slope stability through review of pre-existing inspection reports, design drawings, design memoranda, and owner observations.
- Assessment of the impact of excavation given the phreatic surface position and physical characteristics of embankment materials (material type, density, plasticity, etc.).
- Evaluation of the restoration and preventive scheme proposed.

## 5.6 Sequenced Repair Program

Currently, dam safety inspections provide a comprehensive list of deficiencies observed at the time of the inspection. The list is generally separated into physical areas of the dam including the upstream slope, crest, downstream slope, emergency spillway, and principal spillway. However, in most cases, the list is not prioritized for the dam owner. Consequently, the dam owner is left with a long list of deficiencies with little guidance on immediate, near-term, and long-term repair items.

Considering that most dam owners do not have the financial means to address all deficiencies quickly, a prioritization methodology should be established for dam repair. The following sequence is one that provides the owner, regulator,

and dam safety engineer with a reasonable opportunity to effectively evaluate the condition of an earthen dam (ASDSO, 2001). It must be noted that the following sequence is intended for general guidance only. Specific dam inspections may substantially deviate from the following sequence based on the needs and requirements of the individual dam.

- **Year 1.** (from date of last inspection) Repair animal penetrations that exhibit seepage, soil migration, or have caused slope instability in Zones 1, 4, or 5. Preventive measures should be installed where appropriate.
- **Year 2.** Repair penetrations in Zones 2 and 3. If deemed necessary, initiate investigation, analysis, and preliminary design of major repair activities.
- **Year 3.** Complete design and begin construction of major repair activities.
- **Year 4.** Complete construction of major repair activities and establish an operation and maintenance program that will manage animal intrusions and penetrations on a frequent and regular basis.

If dam failure is judged imminent or if dam safety or operation has greatly diminished, the above sequence may not be applicable. In these cases, a dam safety professional must be advised of the situation to develop a revised schedule.

## 5.7 Mitigation Through Design

### 5.7.1 Muskrat

Some of these design criteria are referred to as “overbuilding” however, they are generally effective at preventing serious muskrat burrow damages. The design measures are adapted from the following references: University of Nebraska, 1994; University of Missouri Extension, 1999; ASDSO, 2001; Connecticut DEP, 1999; USDA, 1991; and South Carolina DNR, 2003.

- Construct the upstream slope of the dam to a 3H to 1V slope. Muskrats favor steep slopes so gentle slopes will be less attractive (Figure 5-7).
- Construct the downstream slope of the dam at a 2H to 1V slope with a crest width of not less than 8 feet, preferably 10 to 12 feet.

## Proper Embankment Construction

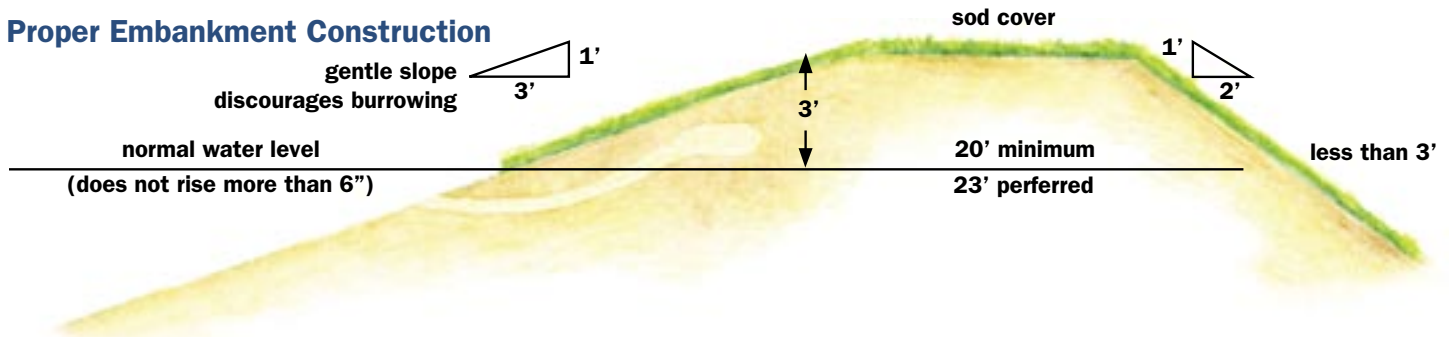

## Improper Embankment Construction

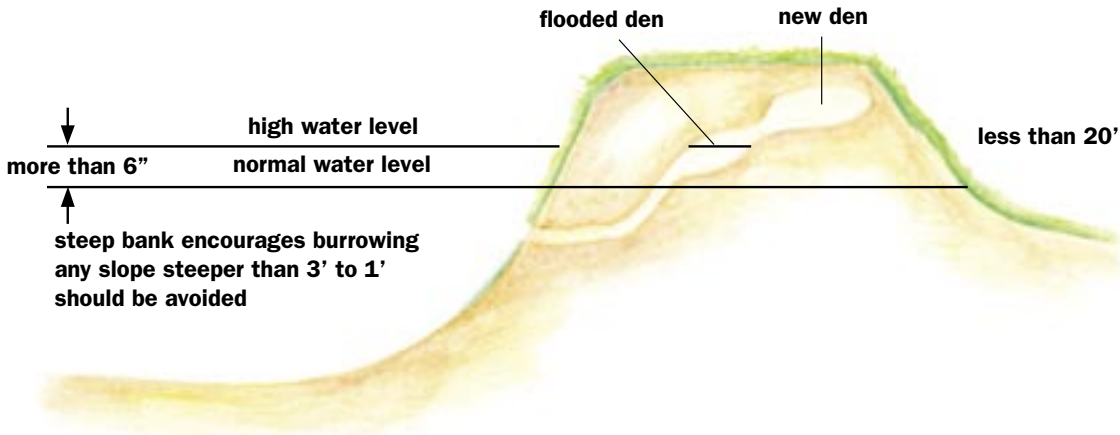

Figure 5-7. Proper dam construction can reduce muskrat damage.

- The normal water level in the pond should be at least 3 feet below the top of the dam and the spillway should be wide enough that relatively frequent storms (less than the 10 year storm event) will not increase the level of the water for any length of time.
- Design for a minimum width of 20 feet at normal water level.
- Bind soil adequately by sodding well.
- Protect the crest from muskrat by applying compacted dense-graded aggregate base course 4 to 6 inches thick.
- Construct a 10-foot-wide shelf projecting from the face of the dam into the reservoir at the water line. This shelf will act as a muskrat barrier and also reduce wave action erosion.
- Place stone rip-rap underlain by fine filter stone and geotextile (high strength, non-woven) extending from 3 to 4 feet below the water line to 1 foot above the water line. Riprap size and thickness will depend upon specific reservoir characteristics. The riprap will prevent muskrat from burrowing into the dam.
- Use an appropriate gabion wall system and/or enlarged reinforced concrete outlet works structures to act as exclusion systems at the toe of the downstream slope.
- Embed 1 to 2-inch welded wire or chain link fencing into the dam upstream face. Mesh wire should extend from 3 to 4 feet below the water line to 1 foot above the water line. Lay the wire flat against the banks and fasten it down every few feet to secure the wire. It is likely that portions of the mesh below the water surface will corrode over time and require replacement.
- Using a narrow trenching machine, cut a vertical trench extending the full length of the embankment in the centerline of the earth fill. The trench should extend from 3 to 4 feet below the water line to 1 foot above the water line. Fill the trench with concrete to create a core that will prevent muskrat from digging through the embankment.

The South Carolina Dam Safety Office indicates that using siphons and other “non-trickle” principal spillway systems may be effective against beaver, but their success is not documented.

- Design water control structures with a concrete apron to prevent muskrat burrows from damaging these facilities.

Several of the above design components indicate placement of the barrier 3 to 4 feet below the water line of the normal pool. It should be noted that if the barriers are not placed at least 3 feet (and preferably 4 feet) below the water line, then the muskrat will burrow underneath the barrier and penetrate the embankment; failure of the slope protection system and embankment damages will result.

### 5.7.2 Beaver

Structures or techniques to prevent beaver damage can often be included in initial engineering plans or added during dam upgrades and repairs. The following techniques have been adapted from the following references: University of Nebraska, 1994; North Carolina State University, 1994; Wilson, 2001; New York State DEC, 2002; Porter, 2003; Barnes, 1991; Virginia Cooperative Extension, 2000; and FEMA, 2000.

- Gently slope the embankment (3H to 1V or flatter) to discourage burrowing and minimize the probability of beaver dam construction.
- Install spillway risers so that they open upstream instead of toward the dam.
- Place riser structures far from the face of the dam in the deepest water possible.

- Protect large risers from clogging by installing mesh bars (at least 5 inches square) or hog pen panel (4 x 4 inches). This will prevent beaver from entering the trash rack.
- Protect intakes with a deep water cage or fence to prevent plugging.
- Replace the standard manhole cover on top of the riser tower with a “beehive” grate. This cast iron dome allows drainage during high water events, even if the lower orifices are blocked.
- Install a single strand, high-tensile electric wire across active beaver paths or around the shoreline just above the slope where beavers would exit the water. The electric wire should be staked about 3 to 4 inches above the soil surface and can be powered by a direct 110-volt charger or a rechargeable battery pack. After repeated shocks, the beaver will usually relocate to another area. Public safety issues and concerns must be addressed when considering this option.
- Install fencing around outlets to prevent plugging. Secure the fence to the reservoir bottom with metal posts. Fencing should be about 5 feet high, made of heavy-gauge woven wire with no larger than 6-inch openings. It should extend 10 to 20 feet out from the outlet. Before installing the fence, debris should be removed from the outlet (Figure 5-8).

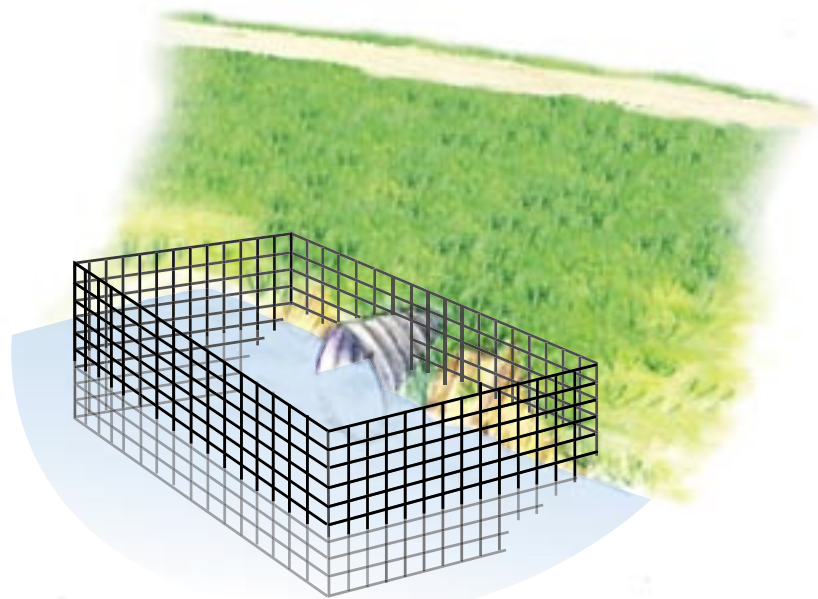

Figure 5-8. Install fencing around culverts and outlets to prevent beavers from blocking flow.

# Avoid These Water Level Control Devices at Dams

Because these devices require partial obstruction of spillways or outlet pipes, their use at a dam should be strictly prohibited. Obstruction of spillways or outlets can cause reservoir levels to rise resulting in overtopping of the dam, erosion of earthen spillways and other detrimental impacts.

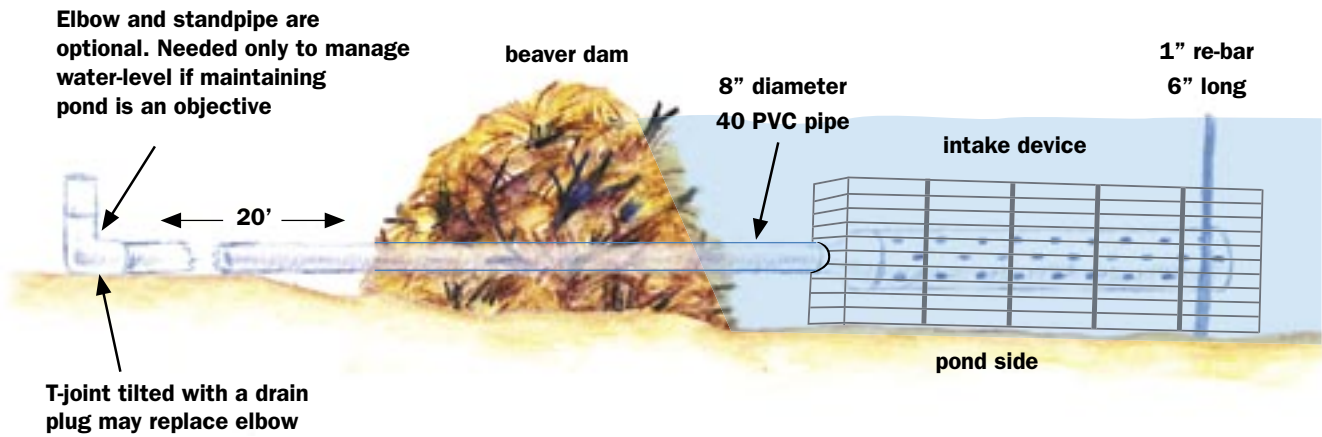

Figure 5-9. The Clemson Beaver Pond Leveler is a passive but effective means to control water levels through a beaver dam.

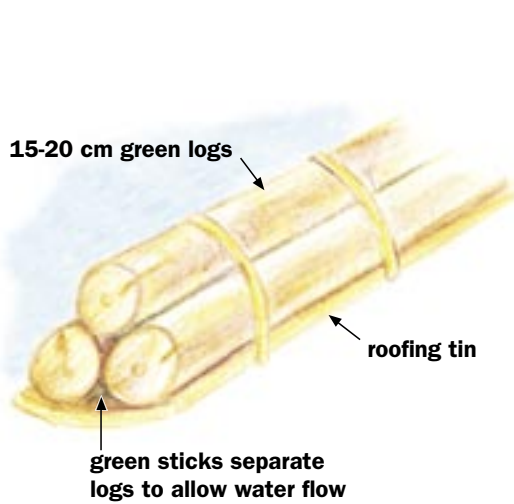

Figure 5-10. A 3-log drain manipulates water levels through a beaver dam.

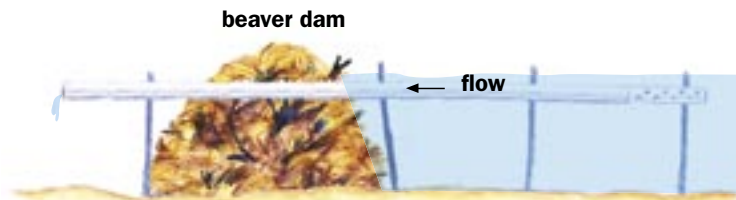

Figure 5-11. PVC Beaver Drain Pipe



Figure 5-12. Massachusetts Beaver Pond Leveler

- Install a layer of riprap on the upstream side of the embankment to prevent burrowing. The riprap should extend from 4 feet below to 2 feet above normal water levels.

### 5.7.3 Mountain Beaver

It may be possible to exclude mountain beavers from a dam by installing a rabbit-proof fence (chain-link, chicken wire, etc.) around the embankment. The bottom of the fence must be tight against the ground or, for better protection, buried about 1 to 2 feet (Pehling, 2003).

### 5.7.4 Groundhog

It is possible to discourage groundhogs from burrowing in an earthen dam by armoring the structure with rock or other hard materials (Michigan State University Extension, 1998).

It is also possible to exclude groundhogs from an earthen dam by installing a fence around the area of concern. Groundhogs are good climbers so the fence should be at least 3 feet high and made of heavy poultry wire or 2-inch mesh woven wire. To prevent burrowing underneath the fence, it should be buried 10 to 12 inches into the ground or bent into an L-shaped angle (pointing away from the excluded area) buried 1 to 2 inches into the ground. For added protection, an electric wire placed 4 to 5 inches off the ground and 4 to 5 inches away from the fence may be installed (University of Nebraska, 1994). Public safety issues and concerns must be addressed when considering this option.

### 5.7.5 Pocket Gopher

Fencing is of limited use for protecting earthen dams from pocket gophers; the method is expensive and generally not practical because pocket gophers burrow so deeply underground. However, if fencing is used to exclude pocket gophers from the dam, it should be buried at least 20 inches into the ground and extend 6 to 8 inches above the ground (USDA, 1991).

### 5.7.6 North American Badger

Fencing may be used to exclude badgers from an earthen dam. The fence should be made of mesh wire and it should be buried to a depth of 12 to 18 inches to prevent badgers from burrowing underneath. This control method may not

be practical for protecting large areas because installation can be costly and time consuming (University of Nebraska, 1994).

### 5.7.7 Nutria

There are several design measures that can be implemented to reduce nutria damage.

- Install fencing around the dam embankment. Fences should be about 4 feet high with at least 6 inches of fencing buried underground.
- Armor the embankment with riprap to discourage burrowing.
- Contour embankment slopes to an angle less than 45° to discourage burrowing.

### 5.7.8 Prairie Dog

The use of fencing to exclude prairie dogs from a dam is a potential management tool, although it is rarely practical because prairie dogs burrow so deeply underground. If fencing is chosen as a control method, a tight-mesh, heavy-gauge, galvanized wire fence should be used, with 2 feet buried in the ground and 3 feet remaining above ground (University of Nebraska, 1994).

Visual barriers may also discourage prairie dogs from inhabiting an area. Prairie dogs prefer areas of low vegetation to provide a clear view of their surroundings and to improve their ability to detect predators. Objects such as fences or hay bales that are strategically placed to block prairie dog views may reduce suitability of the habitat. High construction and maintenance costs generally reduce the viability of this option (University of Nebraska, 1994).

### 5.7.9 Ground Squirrel

Fencing is not usually a practical method of control for ground squirrels because they are able to climb over or burrow under most exclusion structures. Routine weed control and vegetative management may limit some damage, but the effectiveness of this method is usually limited as well (USDA, 1991).

### 5.7.10 Armadillo

It is possible to exclude armadillos from an earthen dam by installing a fence or barrier around areas of concern. Armadillos can both climb and burrow so the fence should be slanted outward at a 40° angle with a portion buried underground sufficient to maintain the fence's pitch.

### 5.7.11 Livestock

Fencing is a highly effective method of protecting earthen dams from domestic livestock and is moderately effective with free-ranging or wild grazing animals (USDA, 1991). Heavy wire fences, wooden post fences, or electric fences may be used (University of Nebraska, 1994).

### 5.7.12 Crayfish

No design techniques are effective at discouraging crayfish inhabitation.

### 5.7.13 Coyote

Fencing can be used to exclude coyotes from a dam. Both wire and electric fences will work, and a combination of the two will probably be most effective. Net wire fences should be about 5 feet high with barbed wire at ground level or a buried wire apron. Horizontal spacing of the mesh should be less than 6 inches and vertical spacing should be less than 4 inches. Electric fences usually consist of strands of smooth, high-tensile wire stretched to a tension of 200 to 300 pounds. Studies have shown that 13 strands of charged wire effectively protected pastures from coyote predation (University of Nebraska, 1994).

*Studies have shown that 13 strands of charged wire effectively protected pastures from coyote predation.*

### 5.7.14 Mole and Vole

Fencing may be useful for mole control in small dams. The fence should be made of rolled sheet metal or hardware cloth, with at least 12 inches buried underground and 12 inches extending aboveground. It is also possible to discourage moles from burrowing in an earthen dam by packing the soil with a roller to reduce soil moisture. This will

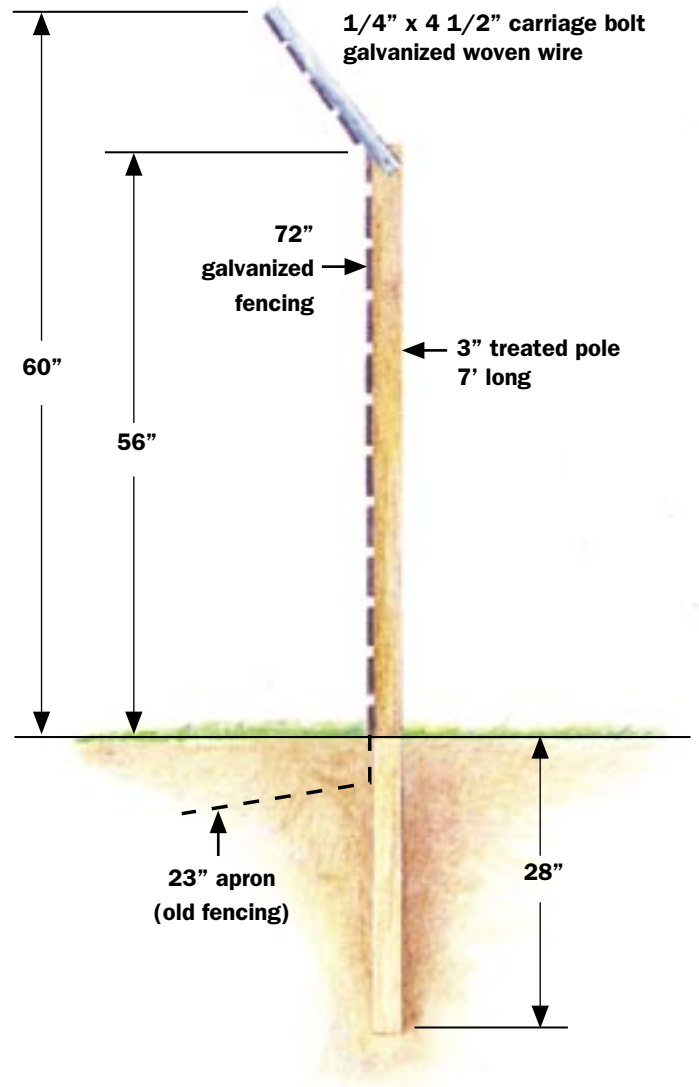

Figure 5-13. Installation of a net fence with wire overhang and buried apron is an effective coyote exclusion method.

reduce the habitat's attractiveness to moles (University of Nebraska, 1994).

Fencing of large-scale areas is generally not a cost-effective method of vole control (University of Nebraska, 1994).

### 5.7.15 River Otter

Fencing may be used to exclude river otters from an earthen dam. The fence should be constructed of mesh wire (3 x 3-inch or smaller) or hog-wire. Dam owners should regularly check the fence to ensure that it has not been spread apart

or raised to allow otters to enter (University of Nebraska, 1994).

#### 5.7.16 Gopher Tortoise

Fencing the dam embankment may be practical for protecting small areas from gopher tortoise damage (University of Nebraska, 1994).

#### 5.7.17 Red and Gray Fox

Fencing can be used to exclude foxes from an area of concern. Both wire and electric fences will work, and a combination of the two will probably be most effective. Net wire fences should be constructed so that all openings are less than 3 inches. The bottom should be buried 1 to 2 feet into the ground with at least 1 foot above ground. For an effective electric fence, there should be at least three charged wires spaced 6 inches, 12 inches, and 18 inches above the ground (University of Nebraska, 1994).

#### 5.7.18 Canada Goose

It is often possible to discourage Canada goose inhabitation by installing fencing, rock barriers, or vegetative barriers around shorelines. Fencing can be constructed out of a variety of materials including mylar tape, metal mesh, plastic or synthetic mesh, electric wires, or wood. Fences should be at least 25 inches tall and should not contain openings greater than 3 inches (Virginia Cooperative Extension, 2001b).

#### 5.7.19 American Alligator

Fencing may be used to exclude alligators from earthen dams. The fence should be at least 5 feet high with the top edge angled outward (University of Nebraska, 1994).

#### 5.7.20 Ants

There are no exclusion methods or design measures effective against ant inhabitation.

### 5.8 Monitoring

Once a dam specialist identifies the burrow and the species creating or occupying it, the burrow(s) would be filled and a prevention technique implemented as appropriate. The next step to maintaining safe dam operation is to monitor the effectiveness of the remedial action (e.g., has the rip-rap effectively deterred muskrat activity?). In many cases,

regular dam inspections and swift burrow mitigation (and preventive actions when needed) will adequately preserve safe dam operations. However, it is possible for a dam to become overrun by nuisance animals, or for several species to cumulatively compromise safe dam operations. In these cases, repair actions are only partial solutions. Monitoring can help the dam owner determine whether additional mitigation is necessary.

In general, it is recommended that the dam owner inspect the dam once every 3 months after first finding and repairing animal damage. The frequency is aimed at confirming the animal has not returned to the dam once the burrow is removed. Once burrows are identified, the owner should consider implementing a preventive action if a burrow occurred in one of the critical dam zones (see Chapter 5.4 for a discussion on animal burrows in critical dam zones). Understanding the potential fiscal limitations of dam owners, the most realistic approach is to use the fewest actions needed to ensure dam safety. As a guideline, if the dam owner finds new animal burrows in the dam on two consecutive inspections following repair and preventive actions, then implementing a wildlife control strategy is probably necessary to maintain safe dam operations (see Chapter 6.0 for a discussion on wildlife control).



# 6.0 Mitigating Damaging Wildlife



This chapter of the manual details methods for managing wildlife populations. General wildlife management information is provided first, followed by specific management information for the 23 species considered in this manual. The application of this data in the dam environment can be beneficial and at times necessary to protect human populations from the disastrous effects of dam failure. However, applied indiscriminately, these methods can adversely affect the dam environment, protected wildlife species, and even human populations. For this reason, nuisance wildlife management practices should be implemented only with coordination and input from state and federal wildlife agencies and the county agent responsible for toxicant and fumigant registration and application (Appendix A contains state wildlife contacts).

## 6.1 Compliance with State and Federal Regulations

### 6.1.1 Conformity to Federal Regulations

As the vast majority of surveyed states indicate, the dam owner is responsible for the identification and mitigation of nuisance wildlife at dams. Although the dam owner is empowered by the state dam safety official to manage a

dam toward safe operation, the dam owner must abide by applicable federal and state regulations when implementing nuisance wildlife management measures. The Endangered Species Act of 1973 (ESA), the Migratory Bird Treaty Act of 1918 (MBTA), and the Federal Insecticide, Fungicide, and Rodenticide Act of 1996 (FIFRA) are three federal laws that must be complied with during application of wildlife management methods. The ESA protects species of plants and animals that are in danger of extinction. Under the ESA, it is illegal for anyone to “take” a species listed as threatened or endangered.

The ESA defines “take” as, “to harass, harm, pursue, hunt, shoot, wound, kill, trap, capture, or collect or attempt to engage in any such conduct” (USFWS, 2002a). The MBTA was established to conserve migratory bird species in the United States and prohibits the hunting, trapping, possession, and transfer of listed species except under the terms of a valid permit or during authorized hunting seasons (USFWS, 2002b).

Species that are discussed in this manual and protected under the ESA and the MBTA include:

- Gopher Tortoise (*Gopherus polyphemus*). This species is listed as Threatened under the ESA throughout its range of Mississippi, Louisiana, and portions of Alabama, and is protected by state laws in Alabama, Georgia, Florida, and South Carolina.
- The American Alligator (*Alligator mississippiensis*). This species is listed as “Threatened by Similarity of Appearance to a Threatened Taxon” under the ESA throughout its range of Alabama, Arkansas, Florida, Georgia, Louisiana, Mississippi, North Carolina, Oklahoma, South Carolina, and Texas. This designation means that the American Alligator is protected under the ESA because of its similarity in appearance to the American Crocodile (*Crocodylus acutus*). The American Crocodile is classified as Endangered under the ESA. The USFWS determined that in order to adequately protect the American Crocodile, which is often mistaken for the American Alligator, the USFWS must also protect the American Alligator. Therefore, though populations of the American Alligator are healthy throughout its range, it is afforded full protection under the ESA.
- Point Arena Mountain Beaver (*Aplodontia rufa nigra*). This subspecies is listed as Endangered throughout its range of California.
- Utah Prairie Dog (*Cynomys parvidens*). This species is listed as Threatened throughout its range of Utah.
- Northern Idaho Ground Squirrel (*Spermophilus brunneus brunneus*). This subspecies is listed as Threatened throughout its range of Idaho.
- Canada Goose (*Branta canadensis*). This species is protected under the MBTA throughout its range of the United States.

If dam owners suspect that one of these species is damaging the earthen dam, then the dam owner must contact the USFWS and the state wildlife agency to discuss management options. While it is often possible to relocate these animals with permits and guidance from the USFWS and the state wildlife agency, the permitting agency must be consulted prior to taking any action. It should be noted that the list of protected species can and does change, and regular contact with an agency is required to ensure that no protected species are adversely affected.

While difficult to predict each potential circumstance, there may be cases when management of a species not protected by the ESA or MBTA may result in the illegal taking of a protected species that is associated with the targeted nuisance species. For example, the endangered black-footed ferret (*Mustela nigripes*) depends on the burrows of prairie dog colonies for survival. Mitigation against the prairie dog may impact the ferret. Similarly, the eastern indigo snake (*Drymarchon corais couperi*) is afforded refuge by gopher tortoise burrows; thus, managing a dam for the tortoise could have secondary effects on the indigo snake. As some species show interdependencies on others, it is recommended that coordination with state and federal wildlife agencies be conducted before management of any species, protected or not, occurs.

Last, FIFRA divides pesticides, including toxicants and fumigants, into two categories: General Use Pesticides and Restricted Use Pesticides. General Use Pesticides will not ordinarily cause unreasonable adverse effects on the user or the environment when used as directed and as such, they are commercially available to the public. Restricted Use Pesticides, however, could cause adverse effects to the user or the environment even when used correctly. Restricted Use Pesticides can only be purchased by a certified pesticide applicator and applied by or under the supervision of a certified pesticide applicator, in accordance with FIFRA. Appropriate disposal of pesticide containers is also required.

### 6.1.2 Conformity to State Regulations

Certain wildlife species are protected by the state even though they are not listed as Federally threatened or endangered; each state determines its own regulations with regard to protected species. Furthermore, hunting and trapping regulations in regard to furbearer, game, and non-game species vary from state to state. For these reasons, it is recommended that a dam owner contact the appropriate state wildlife agency for information about mitigation of wildlife species, and hunting and trapping seasons, licenses, and permits before attempting to remove an animal from the dam environment or before any wildlife management actions are taken. As with federal laws, the list of protected species can change from year to year and regular contact with an agency is required to ensure that no protected species are adversely affected.

Finally, legal use of specific toxicants and fumigants varies from state to state; one state may allow a toxicant that is banned in another. As such, it is recommended that coor-

dination with the state wildlife agency or county agent be conducted to determine which substances are allowed for use in each state. If toxicants or fumigants are selected as the management option, it is recommended that:

- The substance is used according to direction and precaution;
- The substance is stored securely in original containers away from children, animals, food, and feed;
- The substance is applied so as not to endanger humans, livestock, crops, beneficial wildlife, or water supply, or leave illegal residues;
- Excess substance is not dumped, and associated equipment is not cleaned near ponds, streams, or wells; and
- Substance containers are disposed of properly at an appropriate landfill facility.

## 6.2 Muskrat Management Methods

### 6.2.1 Muskrat Control Through Habitat Modification (South Carolina DNR, 2003; University of Nebraska, 1994; Michigan State University Extension, 1998; USDA, 1991)

**Mow regularly to remove food supply.** Specifically, remove cattails, arrowhead, and other plants that grow on the fringe of the reservoir.

**Implement an aquatic vegetation control program** to reduce aquatic vegetation preferred by the muskrat for food and cover. Muskrat populations can be effectively managed by eliminating food sources. The vegetation control program can be achieved through several management approaches:

- **Herbicides** are widely used to control aquatic vegetation. Out of the 200 herbicides registered with the U.S. Environmental Protection Agency, only 8 are available for aquatic uses, and only 6 of those 8 are widely used (2 herbicides are limited to use in 17 western States' irrigation systems under Bureau of Reclamation control). Coordination with the state agency responsible for aquatic plant management is required to ensure that the appropriate herbicide is selected based on management goals and that herbicides are lawfully applied.

- **Hand Removal** of preferred muskrat vegetation can be implemented; however this method is labor-intensive and needs to be repeated frequently to keep vegetation, especially perennial plants, under adequate control. Hand removal can be combined with herbicide application.
- **Mechanical Removal** utilizes small and large weed harvesters to remove vegetation around the shoreline. This method achieves immediate vegetation control in small dams and does not carry water-use restrictions after treatment, unlike herbicide application. However, weed harvesters cannot be used in all environments—for example, obstructions may preclude harvester use. This method is usually higher in cost, slower, and less efficient than other available methods.

**Manipulate water levels** in the reservoir to create an undesirable habitat for the muskrat. A 2-foot drawdown in the reservoir during the winter months can be an effective muskrat management tool. Drawdown allows a dam specialist to identify and repair muskrat holes in the upstream slope (refer to Chapter 5.3.1 for burrow repair discussion), and may drive away resident muskrats, which need adequate water levels. It is recommended that muskrats be trapped and removed during the drawdown; however, trapping and relocation should be coordinated with the appropriate state agency, since a permit may be required.

A secondary benefit of water level manipulation is the potential drying and freezing of aquatic plants—the muskrat's primary food supply—as the plants are exposed to air. It should be noted that some aquatic plants are tolerant of drawdown and may actually increase after a drawdown; therefore, drawdown as a primary aquatic plant management method is not recommended.

### 6.2.2 Muskrat Control Through Trapping (University of Nebraska, 1994; South Carolina DNR, 2003)

The most effective types of traps for muskrat include the Conibear® traps No. 110 and 120, and leghold traps like the long spring No. 1, 1½ or 2, and similar coil spring traps (Figure 6-1 and 6-2). The Conibear® traps are preferred because they are effective in shallow and deep water settings, easy to set up, and kill the muskrat quickly, preventing escapes. The Conibear® and leghold traps are most effective when set close to the den entrance in the “runs” or trails carved into the reservoir bottom by the muskrat's hind feet. Runs can be easily seen in clear water, or can be felt with



**Leghold Trap**



**Conibear® - Type Body Gripping Traps**

Field testing in a 100-acre rice field (36 Conibear® 110 traps were set) and a 60-acre minnow pond (24 1½ leghold traps were set) yielded an effective muskrat removal rate of 93.3% and 87.5% for the Conibear® and leghold traps, respectively. All tripped traps were 100% effective.

Figure 6-1. To capture muskrats, leghold traps should be set along runways, den openings, or natural resting areas. Conibear No. 110 traps should be set in the water.

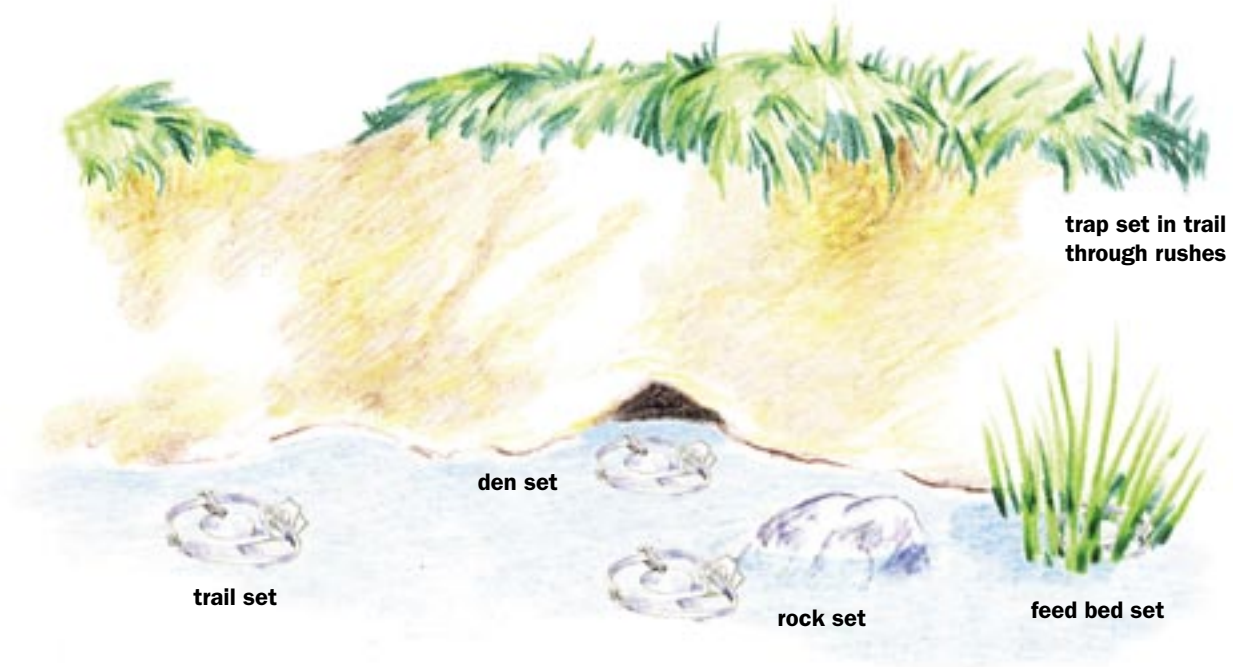

**trap set in trail through rushes**

**den set**

**trail set**

**rock set**

**feed bed set**

Figure 6-2. Muskrat traps can be effectively set in four locations. Bait traps with carrots, potatoes, sweet potatoes, or apples.

the hands or feet in murky or deep water. Poles can be used to anchor the trap in front of the den (Figure 6-3).

Where legal, homemade stovepipe traps can also be effective. This type of trap is cheap, simple, and easy to make, but it requires more time and effort to set. A trap can be constructed by forming sheet metal into a 6 x 6-inch rectangular box, 30 to 36 inches long with heavy-gauge hardware cloth or welded wire doors. The doors should be hinged at the top to allow entry from either end, but no escape out of the box. The trap should be set right up against the primary den entrance to be most effective.

### 6.2.3 Muskrat Control Through Fumigants (University of Nebraska, 1994)

No fumigants are registered for muskrat control.

### 6.2.4 Muskrat Control Through Toxicants (University of Nebraska, 1994)

Zinc phosphide (63% concentration) is the only toxicant Federally registered for muskrat control. To make a bait, vegetable oil is applied to cubes of apples, sweet potatoes, or carrots; the zinc phosphide is sprinkled on top; and the ingredients are mixed together thoroughly. The bait is then placed at the burrow entrance, on floating platforms (Figure 6-4), or on feeding houses. Zinc phosphide is a Restricted Use Pesticide and may therefore, only be purchased and applied by a certified pesticide applicator. Zinc phosphide should always be used as directed. Dam owners should contact the appropriate state wildlife agency regarding legality of toxicant use in their state.

Anticoagulants such as pivalyl, warfarin, diphacinone, and chlorophacinone have also been registered for muskrat control in some states. These anticoagulants come in the form of a “lollipop” made of grain, pesticide, and melted paraffin. As with zinc phosphide, anticoagulant baits can

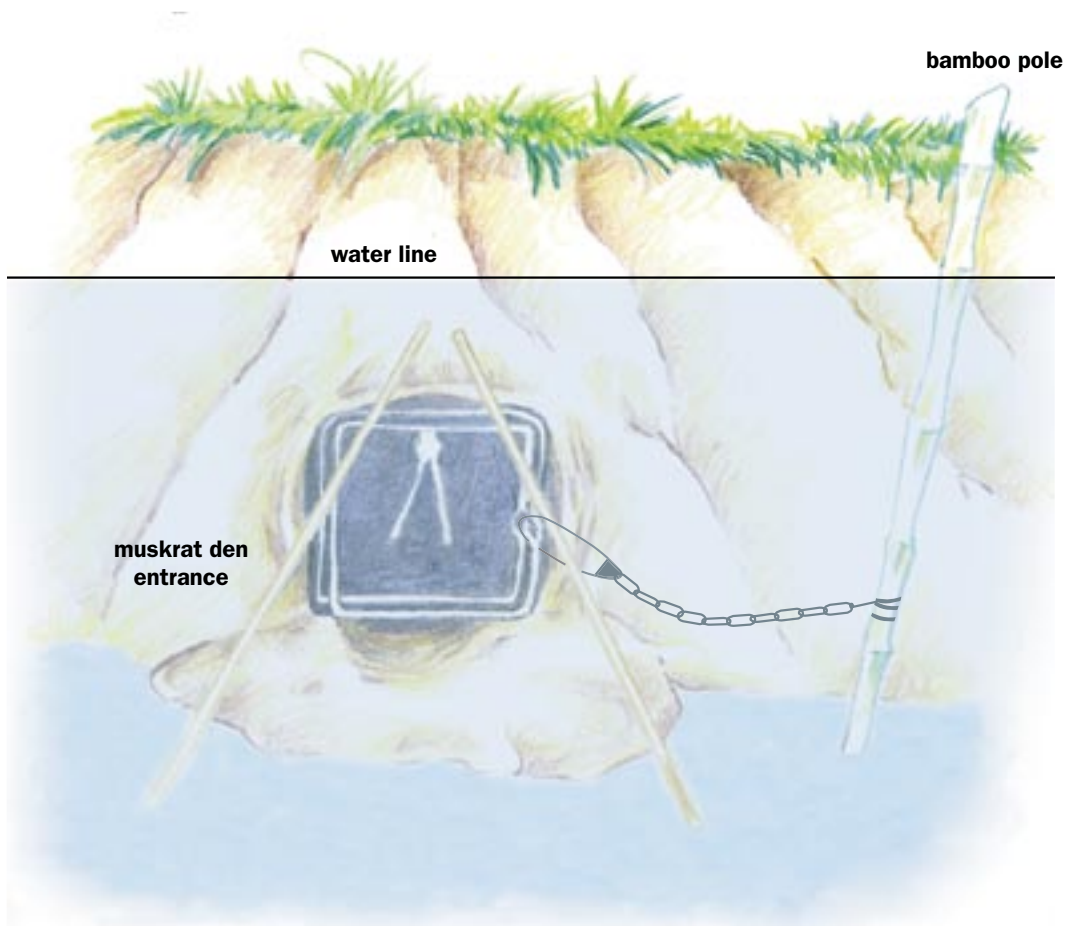

Figure 6-3. Pole set at muskrat den.

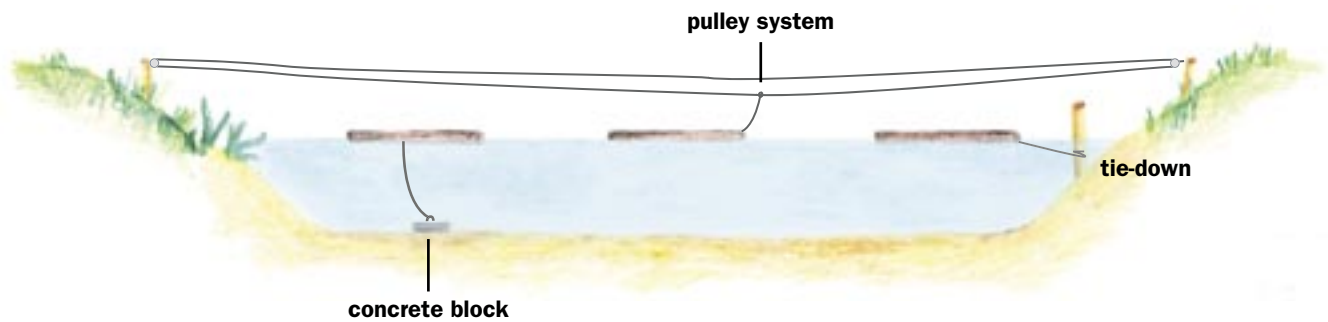

Figure 6-4. Toxicant bait platforms.

be placed at burrow entrances, on floating platforms, or on feeding houses. Dam owners should contact their state wildlife agency to see which, if any, anticoagulants are registered in their state.

#### 6.2.5 Muskrat Control Through Frightening (University of Nebraska, 1994)

Frightening is not an effective method of muskrat control.

#### 6.2.6 Muskrat Control Through Repellents (University of Nebraska, 1994)

No repellents are registered for muskrat control.

#### 6.2.7 Muskrat Control Through Shooting (University of Nebraska, 1994)

Shooting can be an effective method of eliminating a few individual muskrats. Hunting efforts are most successful at dawn and dusk. Dam owners should contact their state wildlife agency for information on hunting regulations and restrictions.

### 6.3 Beaver Management Methods

#### 6.3.1 Beaver Control Through Habitat Modification (University of Nebraska, 1994; University of New Hampshire Cooperative Extension, 1997; USDA, 1994)

Clearing trees and shrubs near the reservoir will reduce potential food sources and habitat and may discourage beaver inhabitation of a dam. Daily destruction of existing dams

Researchers in Louisiana found that deep water beaver dams could be removed more effectively than shallow water beaver dams, and that it was more effective to remove beaver dams in later summer rather than early or midsummer.

and removal of dam construction material will sometimes cause existing beaver colonies or individuals to relocate.

#### 6.3.2 Beaver Control Through Trapping (University of Nebraska, 1994)

In most situations, trapping is the most effective and economical method of controlling beaver damage. Various types of traps can be used, but the Conibear® No. 330 is generally considered the most effective (refer to Figure 6-1 for trap types). It is designed primarily for water use, and works equally well in deep and shallow areas. Conibear®-type traps should be set on dry, solid ground to prevent injury to the person setting the trap. Once the trap is set, it can be

moved to the water and anchored down with stakes. Traps can be effectively set in front of lodge entrances, in front of a hole in the beaver dam, or on underwater beaver trails.

Leghold traps (No. 3 double spring or larger) are also commonly used to capture beavers. This type of trap should be used with a drowning set attachment so that the captured beaver cannot escape. Proper placement is very important with leghold traps. They should be set just at the water's edge, slightly underwater, with the pan, jaws, and springs covered lightly with leaves or debris. There must be a cavity under the pan for the trap to properly trigger. Leghold traps are most effective when they are set slightly off-center on an underwater beaver trail.

Snares can also be used to capture beavers. The equipment costs less than trapping equipment, and snares can be set so that the beaver is caught alive and can then be relocated. Snares are frequently set under logs, near bank dens, and next to castor mounds.

Dam owners should contact their state wildlife agency regarding trapping regulations and seasons and regulations regarding live trapping and relocation.

### 6.3.3 Beaver Control Through Fumigants (University of Nebraska, 1994)

No fumigants are registered for beaver control.

### 6.3.4 Beaver Control Through Toxicants (University of Nebraska, 1994)

No toxicants are registered for beaver control.

### 6.3.5 Beaver Control Through Frightening (University of Nebraska, 1994)

Frightening is not an effective method of beaver control.

### 6.3.6 Beaver Control Through Repellents (University of Nebraska, 1994)

No repellents are Federally registered for beaver control.

### 6.3.7 Beaver Control Through Shooting

Shooting may also be used to remove small populations of beavers. If permitted by law, night shooting is most effective; however, hunting in the early evening and early morn-

ing hours can also be effective. Dam owners should contact their state wildlife agency for information on hunting regulations and restrictions.

## 6.4 Mountain Beaver Management Methods

The Point Arena mountain beaver is a Federally listed endangered subspecies and therefore subject to the provisions of the Endangered Species Act. This subspecies is found only in California. Dam owners in California who suspect that they have a mountain beaver problem should contact the USFWS and the California Department of Fish and Game for definitive species identification and management guidance.

### 6.4.1 Mountain Beaver Control Through Habitat Modification (University of Nebraska, 1994)

Removal of plants such as sword fern, bracken fern, or salal may reduce the attractiveness of a site to mountain beavers.

### 6.4.2 Mountain Beaver Control Through Trapping (University of Nebraska, 1994)

Trapping is an effective method of controlling mountain beavers. The Conibear® No. 110 is most commonly used (refer to Figure 6-1). The trap should be set in the main burrow entrance, anchored with three stakes. Trapping is most effective in warm months when mountain beaver are most active.

Live trapping is also possible using double-door wire mesh traps such as the Tomahawk. This method of trapping is recommended in areas where pets or livestock could accidentally be captured. The trap should be placed in the main burrow entrance with vegetation arranged along the inside and outside of the trap. The trap should be wrapped with black plastic and covered with soil to protect the captured mountain beavers from the weather. Captured animals should be placed in a dry burlap sack and euthanized or relocated to an appropriate location.

Dam owners should contact their state wildlife agency regarding trapping regulations and seasons and requirements for euthanasia or relocation.

### 6.4.3 Mountain Beaver Control Through Fumigants (University of Nebraska, 1994)

No fumigants are registered for mountain beaver control.

#### 6.4.4 Mountain Beaver Control Through Toxicants (University of Nebraska, 1994)

No toxicants are Federally registered for mountain beaver control. Some toxicants may be registered in certain states, though, so dam owners should contact their state wildlife agency regarding this option.

#### 6.4.5 Mountain Beaver Control Through Frightening (University of Nebraska, 1994)

Frightening is not an effective method of controlling mountain beaver.

#### 6.4.6 Mountain Beaver Control Through Repellents (University of Nebraska, 1994)

Repellents are effective for controlling mountain beaver that are causing damage to trees/seedlings, but this method is not practical for preventing damage to earthen dams.

#### 6.4.7 Mountain Beaver Control Through Shooting (University of Nebraska, 1994)

Mountain beavers are nocturnal animals that spend most of their time below ground; therefore, shooting is not a practical method of mountain beaver control.

### 6.5 Groundhog Management Methods

#### 6.5.1 Groundhog Control Through Habitat Modification (Michigan State University Extension, 1998)

It is possible to discourage groundhog inhabitation by mowing vegetated areas of the earthen dam to remove cover.

#### 6.5.2 Groundhog Control Through Trapping (USDA, 1991; University of Nebraska, 1994)

Trapping is an effective method of controlling limited populations of groundhogs. Steel leghold traps (No. 2) (refer to Figure 6-1) and live traps are both commonly used. Traps should be set at the main burrow entrance or on major travel lanes. Live traps, which can be purchased commercially or home-built, require bait such as apple slices, carrots, or lettuce. Groundhogs captured in live traps should be euthanized or relocated to a suitable habitat where they will not cause further damage.

Conibear® traps (110, 160, or 220) may also be used in certain situations (refer to Figure 6-1). They should not be used where they could capture domestic animals or live-stock. Conibear® traps should be set in major travelways or at the main entrance of a burrow system. No bait is necessary.

Dam owners should consult with their state wildlife agency regarding specific trapping regulations and requirements for euthanasia or relocation.

#### 6.5.3 Groundhog Control Through Fumigants (University of Nebraska, 1994)

Use of the commercial gas cartridge is the most common method of groundhog control. The cartridge is ignited and placed in the burrow with all other entrances sealed. As the cartridge burns, it produces carbon monoxide and other gases lethal to the groundhog. Gas cartridges are General Use Pesticides that can usually be purchased at local farm supply stores or pesticide dealers. They should be used with caution and in accordance with the directions on the label.

Aluminum phosphide is a Restricted Use Pesticide that may be applied by a certified pesticide applicator to control groundhogs. The legal application of aluminum phosphide may vary from state to state, so dam owners should consult with their state wildlife agency or state pesticide registration board before implementing this control method. Aluminum phosphide comes in tablet form. Two to four tablets should be inserted into the main burrow and then all burrow entrances must be tightly sealed. Aluminum phosphide should always be used as directed on the label.

Dam owners should consult with their state wildlife agency for information on state and local regulations regarding the use of fumigants to control groundhogs.

#### 6.5.4 Groundhog Control Through Toxicants (University of Nebraska, 1994)

No toxicants are registered for groundhog control.

#### 6.5.5 Groundhog Control Through Frightening (University of Nebraska, 1994)

Scarecrows or other effigies may be installed on or around the earthen dam to frighten groundhogs. This method of control works best if the scarecrows are moved regularly and if there is a high level of human activity around the dam.



### 6.5.6 Groundhog Control Through Repellents (University of Nebraska, 1994)

No repellents are registered for groundhog control.

### 6.5.7 Groundhog Control Through Shooting (University of Nebraska, 1994)

Shooting is most effective if used as a follow-up to other control measures. Groundhogs are considered game animals in most states; therefore a hunting license may be required. Dam owners should consult with their state wildlife agency regarding specific hunting regulations and requirements.

## 6.6 Pocket Gopher Management Methods

### 6.6.1 Pocket Gopher Control Through Habitat Modification (Colorado State University Cooperative Extension, 2003)

Removal of forbs, through either chemical or mechanical treatment, may control some pocket gopher damage. This technique is generally effective only for individuals of the genera *Thomomys*, because they prefer the underground storage structure of forbs. Other species easily survive on grass and therefore will not likely be deterred by this technique.

### 6.6.2 Pocket Gopher Control Through Trapping (USDA, 1994; University of Nebraska, 1994)

Trapping can be extremely effective for pocket gopher control in small areas or when used in conjunction with toxicants. There are many types of traps available for pocket gopher control. The Macabee® gopher trap is the most popular, but other traps are also commonly used, including the Victor® Gopher Getter, the Death-Klutch 1 gopher and mole trap, and the Guardian gopher trap (Figures 6-5 through 6-8). Traps may be set in either the main tunnel or in one of the lateral tunnels (Figure 6-9). Trapping is most effective in the spring and fall, when gophers are pushing up new mounds, although it can be done year-round. Dam owners should consult with their state wildlife agency regarding specific trapping regulations.

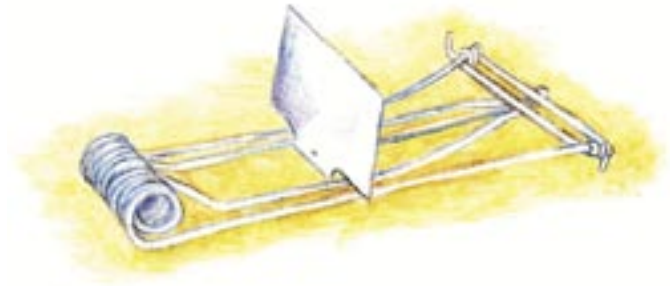

Figure 6-5. Macabee® gopher trap.

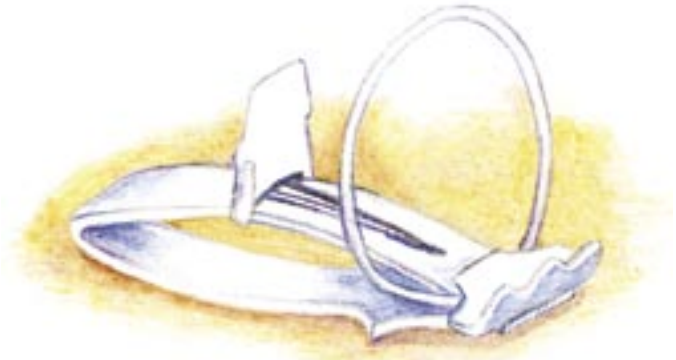

Figure 6-6. Victor® Gopher Getter.

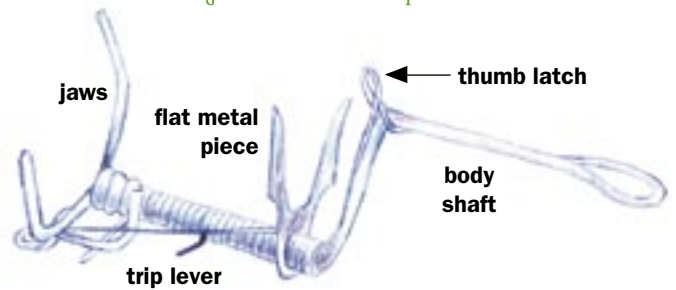

Figure 6-7. Death-Klutch 1 gopher and mole trap.

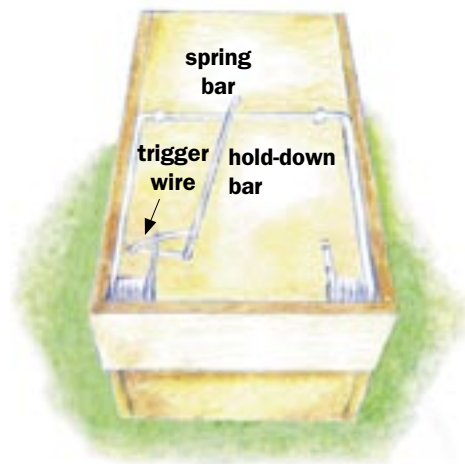

Figure 6-8. Guardian (California box-type) gopher trap.

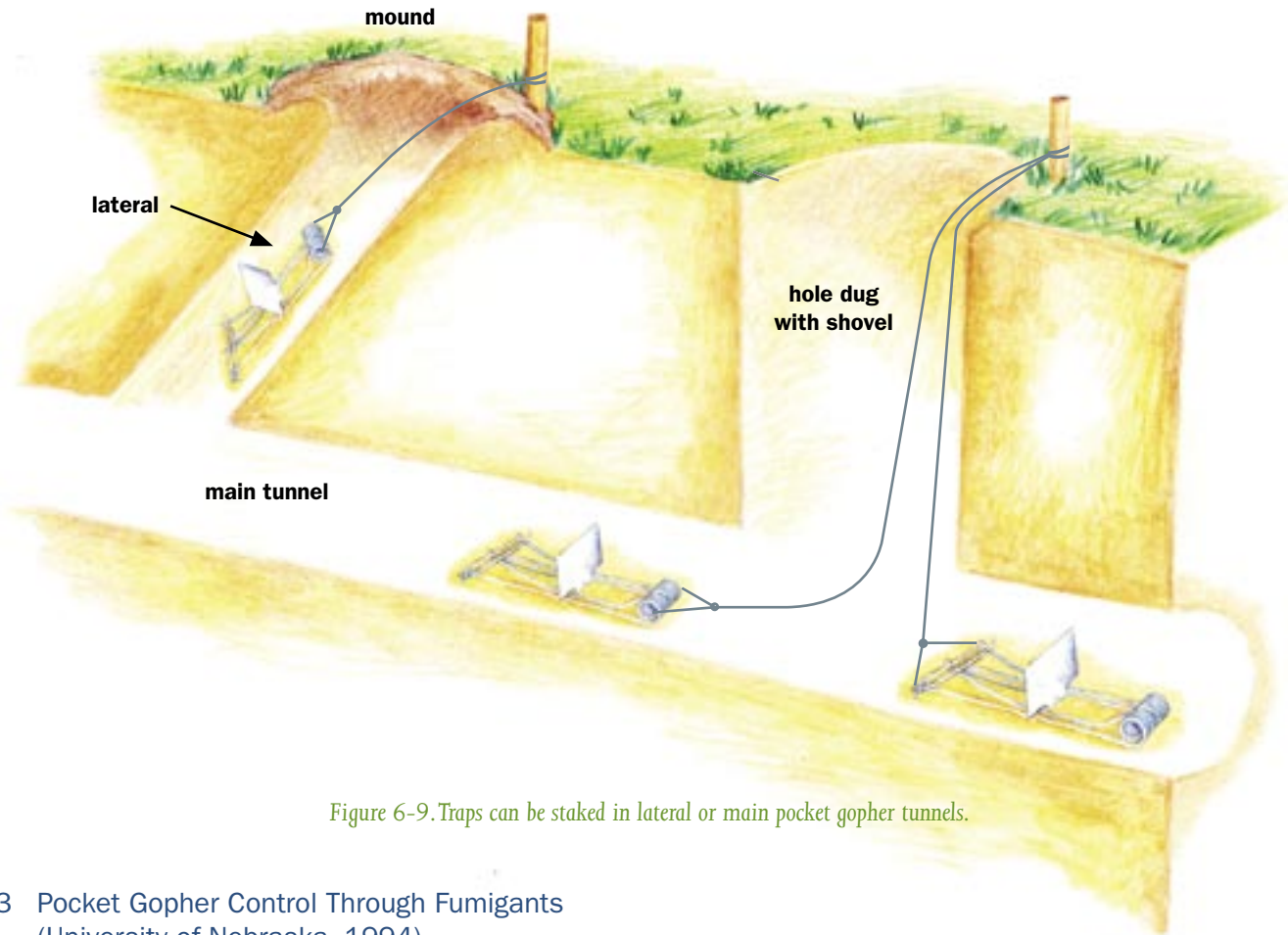

Figure 6-9. Traps can be staked in lateral or main pocket gopher tunnels.

### 6.6.3 Pocket Gopher Control Through Fumigants (University of Nebraska, 1994)

Aluminum phosphide and gas cartridges are both Federally registered for pocket gopher control. They are generally not effective though because the gas moves slowly through the tunnel system, allowing the fumigant to diffuse through the soil and escape to the surface. Carbon monoxide from automobile exhaust has proven more effective because of its greater volume and pressure. To implement this method of control, connect a hose or pipe to the engine exhaust and place it in a burrow opening near a fresh soil mound. Tightly pack soil around the hose or pipe and allow the engine to run for at least 3 minutes. This method is generally 90% effective and requires no federal registration. Dam owners should consult with their state wildlife agency for information on state and local regulations regarding fumigants.

### 6.6.4 Pocket Gopher Control Through Toxicants (University of Nebraska, 1994)

Several rodenticides are currently registered for pocket gopher control. Strychnine alkaloid (0.3 to 0.5% active

*Carbon monoxide is generally 90% effective for pocket gopher control and requires no Federal registration.*

ingredient) on grain baits is the most widely used. It is classified as a Restricted Use Pesticide and can only be sold to and used by a certified pesticide applicator. Applying 1 to 2 pounds per acre of 0.3 to 0.5% strychnine alkaloid grain with a burrow builder should provide an 85% to 95% reduction in the pocket gopher population. Zinc phosphide (2%) is also a registered toxicant for pocket gopher control, though it is less effective than strychnine. Additionally,

two anticoagulants (chlorophacinone and diphacinone) are registered for pocket gopher control. Bait can be placed in a pocket gopher burrow system by hand, using a special hand-operated bait dispenser probe or with a mechanical burrow builder (Figures 6-10 and 6-11).

The first step to hand baiting with the bait dispenser is finding the main burrow, which is generally located 12 to 18 inches away from a plugged mound. Once the main burrow is located, place the probe over the burrow and push down until there is decreased resistance on the probe. Then push the button on the bait dispenser to release a metered dose of bait. For best results, each burrow should be baited in two or three locations.

*Properly applied, strychnine alkaloid can provide an 85% to 95% reduction in a pocket gopher population.*

The burrow builder is a tractor-drawn device that mechanically delivers bait underground. As the burrow builder moves along, it makes an artificial burrow, dispenses the bait into the newly formed burrow, and then closes up the hole. Artificial burrows should be constructed at depths similar to those constructed by pocket gophers in the area.

All toxicant products should be used as directed on the label. Dam owners should consult with their state wildlife agency regarding legality of toxicant use in their state before implementing any control measures.

#### 6.6.5 Pocket Gopher Control Through Frightening

No frightening methods are effective for pocket gopher control.

#### 6.6.6 Pocket Gopher Control Through Repellents (University of Nebraska, 1994; Witmer et al., 1995)

Repellents may be used to discourage pocket gopher inhabitation, although the effectiveness of this method is still in question. Initial testing has shown that some predator odors, such as coyote or bobcat urine, may effectively repel



Figure 6-10. Effective baiting with a bait dispenser requires accurately finding the pocket gopher burrow. Use the probe to detect the main burrow, which is usually on the plug-side of the mound, 8-18 inches away from the plug (USDA, 1994).

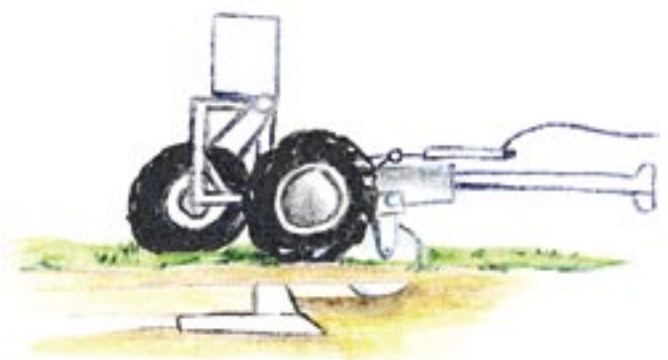

Figure 6-11. A burrow builder mechanically dispenses bait into constructed burrows. Adequate soil moisture is needed to form effective burrows. Adequate soil can be compressed in the hand and rolled gently without crumbling (USDA, 1994).

pocket gophers. Additionally, the mole plant (*Euphorbia lathyris*), also known as the caper spurge or gopher purge, and the castor-oil plant (*Ricinus lathyrus*) have both been promoted as gopher repellents, although there is no scientific evidence to support this claim. Use of these plants is not recommended because they are poisonous to humans and pets, and can grow thickly, obscuring the dam.

### 6.6.7 Pocket Gopher Control Through Shooting (University of Nebraska, 1994)

Shooting pocket gophers is usually not a practical option because they spend most of their time below ground.

## 6.7 North American Badger Management Methods

### 6.7.1 North American Badger Control Through Habitat Modification (University of Nebraska, 1994; Texas Wildlife Damage Management Service, 1998)

Rodent control will alleviate most problems associated with badger damage. Badgers commonly prey on ground squirrels, pocket gophers, and prairie dogs. If this food source is eliminated, then damage from badger predation will be reduced and the badger will often move elsewhere in search of food. Dam owners should refer to sections of this manual pertaining to management of ground squirrels, pocket gophers, and prairie dogs for rodent control guidance.

### 6.7.2 North American Badger Control Through Trapping (University of Nebraska, 1994; Texas Wildlife Damage Management Service, 1998)

Badgers can often be removed from an area through the use of cage traps, leghold traps, or snares placed near the entrance of an active den. Cage traps require bait, such as a dead chicken or large rodent. After a badger is caught alive, it should be euthanized or relocated to an area where it will not cause further damage.

Leghold traps (No. 3 or 4) are most effective if attached to a drag such as a strong limb or fence post. If leghold traps are staked into the ground, it is likely that the badger will dig out the trap and escape.

Snaring involves setting a steel-cable loop in an animal's path to capture it by the neck, body, or leg. Snares are lightweight, compact, easy to set, low-cost, and they offer a high degree of human safety. Ready-made snares and snare com-

ponents may be purchased from trapping suppliers. They must be attached to a solid object so the captured animal cannot escape. Snares should not be set where they could capture pets or livestock.

Dam owners should contact their state wildlife agency regarding trapping regulations.

### 6.7.3 North American Badger Control Through Fumigants (University of Nebraska, 1994)

No fumigants are registered for badger control.

### 6.7.4 North American Badger Control Through Toxicants (University of Nebraska, 1994)

No toxicants are registered for badger control.

### 6.7.5 North American Badger Control Through Frightening (University of Nebraska, 1994)

Badgers may be discouraged from inhabiting an area if high-intensity lights are installed and used at night.

### 6.7.6 North American Badger Control Through Repellents (University of Nebraska, 1994)

No repellents are registered for badger control.

### 6.7.7 North American Badger Control Through Shooting (University of Nebraska, 1994)

Shooting can be an effective method of controlling small populations of badgers. Early morning, late evening, and after dark are the best times for hunting. Where legal, spotlights can be an effective tool for hunting at night. Dam owners should contact their state wildlife agency regarding hunting regulations and restrictions.

## 6.8 Nutria Management Methods

### 6.8.1 Nutria Control Through Habitat Modification (University of Nebraska, 1994; USDA, 1991)

Nutria can be discouraged from inhabiting an area by eliminating brush, trees, thickets, and weeds, which provide food and cover. Cleared vegetation should be burned or removed.

In certain situations, water level manipulation may be another damage control option. Dropping water levels in

the summer and raising water levels in the winter will cause stress to nutria populations and may encourage them to relocate. The viability of this option is dependent upon reservoir useage (e.g., water spray, recreation, etc.) and owner willingness. In addition, lowering the water level has not yet been proven effective by researchers, but it is a tool to consider as part of a comprehensive nutria management strategy.

### 6.8.2 Nutria Control Through Trapping (University of Nebraska, 1994)

Trapping is a very effective method of controlling nutria. Leghold traps are most commonly used. Most trappers prefer double longspring traps (No. 11 or 2), but the No. 1 ½ coilspring, No. 3 double longspring, and soft-catch fox traps are also effective. Traps should be set just under the water where an active nutria trail enters the reservoir. The trap should be staked to the ground just off to the side of the trail and covered with leaves or other debris. To increase effectiveness, traps should be baited with chunks of apples, carrots, sweet potatoes, or watermelon rinds. In deep water, a drowning set should be used. If a nutria is captured alive in shallow water, then it should be disposed of humanely.

Single- or double-door live traps may be used to capture nutria. The cage should be at least 9 x 9 x 32 inches in size. Place the trap along active trails and bait with sweet potatoes or carrots. Captured nutria should be humanely destroyed.

Conibear® traps (No. 220-2, 160-2, and 330-2) are also commonly used to reduce nutria populations. These traps should be set on trails, at den entrances, in culverts, or in narrow waterways. They should not be used in areas frequented by children, domestic pets, or desirable wildlife species.

Snaring is another option for capturing nutria. Snaring involves setting a steel-cable loop in an animal's path to capture it by the neck, body, or leg. Snares constructed with 3/32-inch flexible stainless steel wire or galvanized aircraft cable are suitable for catching nutria. They should be set along trails, travel routes, feeding lanes, or bank slides.

Dam owners should contact their state wildlife agency regarding trapping regulations.

### 6.8.3 Nutria Control Through Fumigants (University of Nebraska, 1994)

No fumigants are registered for nutria control.

### 6.8.4 Nutria Control Through Toxicants (University of Nebraska, 1994)

Zinc phosphide is the only toxicant registered for nutria control. It is a Restricted Use Pesticide that must be purchased and applied by a certified pesticide applicator. The zinc phosphide is mixed with bait, such as apples, carrots, or sweet potatoes, and then the bait is placed in waterways, ponds, and ditches where permanent standing water and recent signs of nutria activity are found. Do not place bait directly in the water, but rather on floating rafts (anchored to the bottom or tied to the shore as depicted on figure 6-4), small islands, floating logs, or exposed tree stumps. Ground baiting is not recommended because humans and nontarget animals may be exposed to the toxicant.

Prebaiting increases the effectiveness of this control method. Apply corn oil to chunks of apples, carrots, or sweet potatoes and place the prebait at the designated baiting station. The station should be prebaited for several nights. Observe the station to ensure that nutria, rather than nontarget animals, are taking the bait. Once the nutria are accustomed to eating the prebait, the zinc-phosphide treated bait can be applied. The toxic bait should be applied until no more bait is being taken. Dead nutria that have been exposed to zinc phosphide should be collected and disposed of by deep burial or burning to prevent zinc phosphide exposure to domestic and wild scavengers.

### 6.8.5 Nutria Control Through Frightening (University of Nebraska, 1994)

Harassment may temporarily deter nutria from inhabiting an area. Loud noises and high-pressure water sprays have worked in some cases. As a long-term control method, however, frightening is not an effective or practical option.

### 6.8.6 Nutria Control Through Repellents (University of Nebraska, 1994)

No repellents are registered for nutria control.

*In certain areas, legal hunting with a shotgun or small caliber rifle has reduced nutria populations by 80%.*

### 6.8.7 Nutria Control Through Shooting (University of Nebraska, 1994)

Shooting is an effective method of controlling nutria. This method is most effective at night with a spotlight, although it should be noted that this technique is not legal in all states. Shooting can be effective when carried out at bait stations, from boats, or from the bank. Dam owners should contact their state wildlife agency for information on hunting regulations and restrictions.

## 6.9 Prairie Dog Management Methods

Because other animals frequently inhabit prairie dog towns, including the Federally protected burrowing owl and black-footed ferret, dam owners need to be particularly cautious when taking action to control prairie dogs. In regions and habitats where burrowing owls and black-footed ferrets are known to live, dam owners should coordinate with their state wildlife agency and the USFWS to determine whether either of these species is present; field surveys by qualified biologists may be required. Burrows that have feathers or white droppings at the mouth probably contain burrowing owls. Black-footed ferrets are secretive animals, and since it can be very difficult to verify their existence in a particular burrow system, it is best to contact the USFWS and the state wildlife agency for guidance on completing a black-footed ferret survey (University of Nebraska, 1994). If either of these species is present, the dam owner must contact the USFWS and their state wildlife agency for management guidance.

It is also important to remember that the Utah prairie dog, one of the four prairie dog species found in the United States, is listed as a Federally threatened species and is therefore subject to the provisions of the Endangered Species Act. As the name implies, the Utah prairie dog is found only in Utah. Dam owners in Utah who suspect that they have a prairie dog problem should contact the USFWS and the

Utah Division of Wildlife Resources for species identification and management guidance.

### 6.9.1 Prairie Dog Control Through Habitat Modification (University of Nebraska, 1994)

Installation of visual barriers may discourage prairie dogs from inhabiting an area. Prairie dogs prefer areas of low vegetation to provide a clear view of their surroundings and to improve their ability to detect predators. Objects such as fences or hay bales that are strategically placed to block prairie dog views may reduce suitability of the habitat.

### 6.9.2 Prairie Dog Control Through Trapping (USDA, 1991)

Trapping may be used to control prairie dogs, but it is quite labor intensive and therefore only practical for removing small populations. Cage traps for live capture, Conibear® traps (No. 110), and leg-hold traps are often used. Cage traps are most effective in early spring. They should be baited with oats flavored with corn or anise oil. Dam owners should consult with their state wildlife agency for guidance on releasing captured prairie dogs. Conibear® and leg-hold traps should be set in burrow entrances. They do not require bait. Dam owners should consult with their state wildlife agency regarding specific trapping regulations.

### 6.9.3 Prairie Dog Control Through Fumigants (University of Nebraska, 1994)

Fumigants can be used to control prairie dogs in some situations, however this method is often costly, time-consuming, and particularly hazardous to other wildlife. Fumigation is most effective as a follow-up to toxic baits. It should not be used in burrows where nontarget species are thought to be present.

*Aluminum phosphide can reduce prairie dog populations by 85% to 95%.*

Aluminum phosphide is a registered fumigant for control of burrowing rodents, including prairie dogs. It is a Restricted Use Pesticide and therefore must be purchased and ap-

plied by a certified pesticide applicator. Aluminum phosphide comes in tablet form. One tablet should be inserted into each burrow and then the burrow entrance should be tightly plugged with soil. When used correctly, aluminum phosphide typically provides an 85% to 95% reduction in prairie dog populations. The legal application of aluminum phosphide may vary from state to state so dam owners should consult with their state wildlife agency or state pesticide registration board before implementing this control method.

Gas cartridges may also be used to control prairie dogs. Gas cartridges are General Use Pesticides that can usually be purchased at local farm supply stores or pesticide dealers. When ignited, a gas cartridge will produce carbon monoxide, carbon dioxide, and other gases that are toxic to the prairie dog. The cartridge should be lit before it is placed in the burrow. Once it has been inserted, the burrow should be immediately plugged with soil. Gas cartridges should be used with caution and in accordance with the directions on the label. When used correctly, gas cartridges can provide a 95% reduction in prairie dog populations.

*Gas cartridges can provide a 95% reduction in prairie dog populations.*

Dam owners should consult with their state wildlife agency for information on state and local regulations regarding gas cartridges and the use of fumigants.

#### 6.9.4 Prairie Dog Control Through Toxicants (University of Nebraska, 1994)

Baiting with a toxicant is generally the most economical and effective method of controlling prairie dogs. Zinc phosphide bait is currently the only registered and legal toxicant available for prairie dog control. It is available in 2% zinc phosphide-treated grain bait and pellet formulations. It is a Restricted Use Pesticide, which means that it is only available for sale to and use by certified pesticide applicators. Zinc phosphide baits can be applied from July 1 through January 31, though it is best to apply the baits in late summer and fall when prairie dogs are most active and there is no green forage available.

*Zinc phosphide can be 75% to 85% successful in controlling prairie dogs when used correctly.*

A prebait must be applied to the burrows before the toxic bait. The prairie dogs will become accustomed to eating the non-toxic grains, which will increase the effectiveness of the toxic bait. The prebait and the toxic bait may be applied by hand or by a mechanical bait dispenser attached to an all-terrain vehicle, motorcycle, or horse.

#### 6.9.5 Prairie Dog Control Through Frightening (University of Nebraska, 1994)

Frightening is not an effective method of control for prairie dogs.

#### 6.9.6 Prairie Dog Control Through Repellents (University of Nebraska, 1994)

No repellents are Federally registered for prairie dog control.

#### 6.9.7 Prairie Dog Control Through Shooting (University of Nebraska, 1994)

Continuous shooting of prairie dogs can remove about 65% of the population annually, but it is generally not a practical or cost-effective method of control. Shooting is most effective in spring because it can disrupt breeding. Dam owners should consult with their state wildlife agency regarding specific hunting regulations and requirements.

### 6.10 Ground Squirrel Management Methods

The northern Idaho ground squirrel, one of 23 ground squirrel species in the United States, is Federally listed as a threatened species and is therefore subject to the provisions of the Endangered Species Act. The northern Idaho ground squirrel is found in limited distribution in the northwest. Dam owners in that region who experience problems with ground squirrels should contact the USFWS and their state wildlife agency for species identification and management guidance.

*The New Mexico and Nebraska Dam Safety Offices have set up roosts in the dam environment to support raptors such as red-tailed hawks to provide predator control of small rodents.*

#### 6.10.1 Ground Squirrel Control Through Habitat Modification (USDA, 1991)

Routine weed control and vegetative management may limit some ground squirrel damage, but the effectiveness of this method is usually limited.

#### 6.10.2 Ground Squirrel Control Through Trapping (University of Nebraska, 1994)

Trapping is a labor-intensive control method, and therefore it is generally only useful for removing small populations of ground squirrels. Jaw traps (No. 1 or No. 0), box or cage traps, and Conibear® traps (No. 110 or No. 110-2) may be used (refer to Figure 6-1). Generally, one trap is needed for every 10 to 15 squirrels present. Traps should be set on trails or near burrow entrances. Box or cage traps require bait, such as fruit, vegetables, peanut butter, or grain; baiting is not necessary with jaw traps or Conibear® traps. Dam owners should contact their state wildlife agency for information on state and local trapping regulations.

#### 6.10.3 Ground Squirrel Control Through Fumigants (University of Nebraska, 1994)

Aluminum phosphide and gas cartridges are both registered fumigants for ground squirrel control. Fumigants work best for light squirrel infestations limited to a few acres. This method is most effective in the spring, when ground squirrels have just emerged from hibernation.

Aluminum phosphide is a Restricted Use Pesticide that comes in tablet form. This fumigant can only be purchased and applied by a certified pesticide applicator. One tablet should be placed in each burrow entrance and then the

burrow should be plugged with soil to form an air-tight seal. The legal application of aluminum phosphide may vary from state to state so dam owners should consult with their state wildlife agency or state pesticide registration board before implementing this control method.

Gas cartridges are General Use Pesticides that can usually be purchased at local farm supply stores or pesticide dealers. When ignited, a gas cartridge will produce carbon monoxide, carbon dioxide, and other gases that are toxic to ground squirrels. The cartridge should be lit before it is placed in the burrow. Once it has been inserted, the burrow should be immediately plugged with soil. Gas cartridges should be used with caution and in accordance with the directions on the label. Dam owners should consult with their state wildlife agency for information on state and local regulations regarding gas cartridges and the use of fumigants.

#### 6.10.4 Ground Squirrel Control Through Toxicants (University of Nebraska, 1994)

Zinc phosphide and two anticoagulants, chlorophacinone and diphacinone, are currently registered for ground squirrel control.

*When used correctly, zinc phosphide can result in an 85% to 95% reduction in ground squirrel population.*

Zinc phosphide is a Restricted Use Pesticide, which means that it can only be purchased and applied by a certified pesticide applicator. It is a single-dose toxicant delivered on oat baits. The ground squirrels should be exposed to an untreated prebait several days before using the toxic grain. Bait can be delivered by hand or mechanically dispensed.

Chlorophacinone and diphacinone are two anticoagulant baits that are registered in some states under various trade names. A continuous supply of bait must be applied for 4 to 9 days for the toxicant to be effective. The bait is usually delivered in a bait box, which can be made of rubber tires or metal, plastic, or wood containers. The commonly used PVC Inverted-T anticoagulant bait station consists of 4-inch sections of plastic irrigation pipe formed into an inverted “T” configuration (Figure 6-12). Dam owners should contact



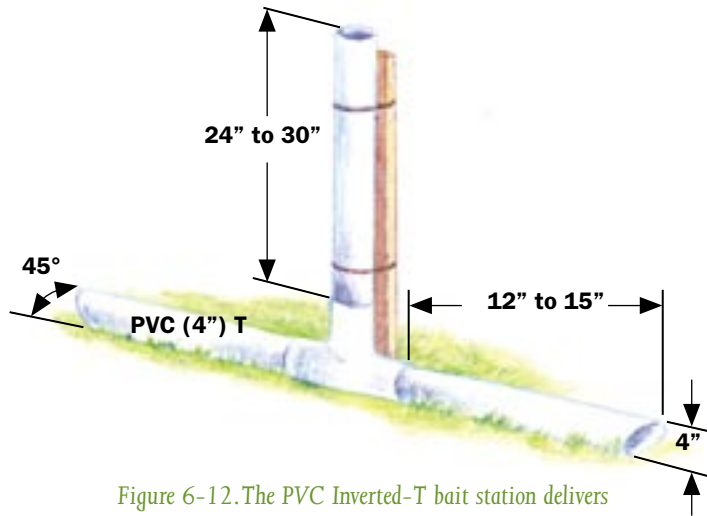

Figure 6-12. The PVC Inverted-T bait station delivers anticoagulant bait to ground squirrels.

## 6.11 Armadillo Management Methods

### 6.11.1 Armadillo Control Through Habitat Modification (University of Nebraska, 1994)

It is possible to discourage armadillos from burrowing in an earthen dam by implementing the following habitat mitigation techniques:

- Remove brush or other cover to reduce the amount of suitable habitat.
- Apply soil insecticides to remove insects and other invertebrates that make up the majority of the armadillo's diet.

### 6.11.2 Armadillo Control Through Trapping (University of Nebraska, 1994)

Trapping can be an effective method of managing armadillos. Live or box traps (10 x 12 x 32-inch), such as the Havahart or Tomahawk, work best. A trap's effectiveness can be enhanced by adding "wings" (1 x 4-inch or 1 x 6-inch boards about 6 feet long) to funnel the animal into the trap (Figure 6-13). The best locations to set traps are along pathways to burrows and along fences or other barriers where armadillos may travel. Conibear® (No. 220) or leghold traps (No. 1 or 2) may also be used (refer to Figure 6-1). These types of traps should be placed at the entrance of a burrow.

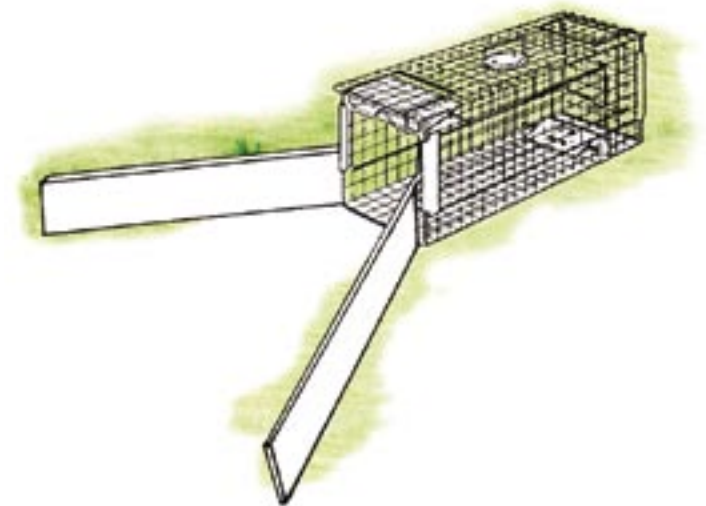

Figure 6-13. The effectiveness of cage traps can be enhanced by adding "wings" to funnel the armadillo into the trap.

their state wildlife agency for information on anticoagulants that may be available for use.

All products should be used as directed. Dam owners should consult with their state wildlife agency regarding legality of toxicant use in their state.

#### 6.10.5 Ground Squirrel Control Through Frightening (University of Nebraska, 1994)

Frightening is not an effective method of control for ground squirrels.

#### 6.10.6 Ground Squirrel Control Through Repellents (University of Nebraska, 1994)

No repellents are registered for ground squirrel control.

#### 6.10.7 Ground Squirrel Control Through Shooting (University of Nebraska, 1994)

Shooting may be used to remove small populations of ground squirrels, although it is an expensive and time-consuming method of control. Dam owners should consult with their state wildlife agency regarding specific hunting regulations and requirements

**6.11.3 Armadillo Control Through Fumigants**  
(University of Nebraska, 1994)

No fumigants are Federally registered for armadillo control. However, there are some fumigants that are effective and that may be legal in certain states. Dam owners should consult their state wildlife agency regarding fumigants that may be legal in their area.

**6.11.4 Armadillo Control Through Toxicants**  
(University of Nebraska, 1994)

No toxicants are registered for armadillo control.

**6.11.5 Armadillo Control Through Frightening**

Frightening is not an effective method of armadillo control.

**6.11.6 Armadillo Control Through Repellents**  
(University of Nebraska, 1994)

No repellents are registered for armadillo control.

**6.11.7 Armadillo Control Through Shooting**  
(University of Nebraska, 1994)

Shooting is an effective method of controlling armadillos. The best time to shoot is during twilight hours or at night when armadillos are most active. Dam owners should consult with their state wildlife agency regarding specific hunting regulations and requirements.

**6.12 Livestock (Cow, Sheep, Horse, Pig, and Wild Pig) Management Methods**

**6.12.1 Livestock Control Through Habitat Modification** (USDA, 1991)

Providing a water source away from the earthen dam may help reduce livestock damage near the dam, since livestock are often at the dam in search of drinking water.

**6.12.2 Livestock Control Through Trapping** (USDA, 1991; University of Nebraska, 1994)

Trapping is quite effective for wild pigs. Stationary corral-type traps and box traps are commonly used (Figure 6-14). They are most effective in summer when acorns and other

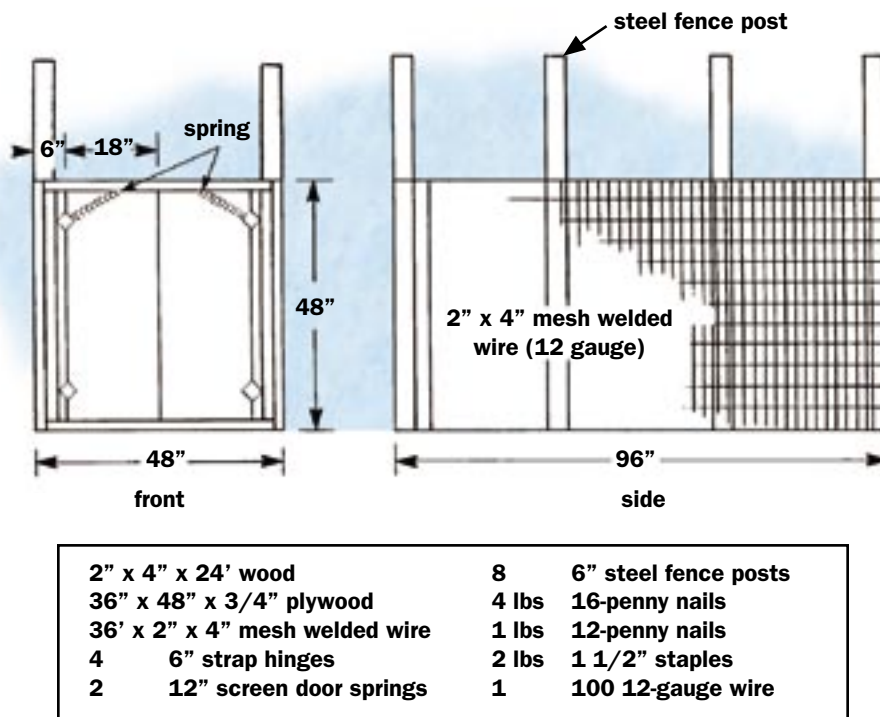

Figure 6-14. Stationary hog trap.

preferred natural foods are not available. Traps should be baited with grains, fruits, or vegetables. The traps may be placed anywhere that wild pigs concentrate.

#### 6.12.3 Livestock Control Through Fumigants (USDA, 1991)

Fumigants are not suitable for livestock control.

#### 6.12.4 Livestock Control Through Toxicants (USDA, 1991)

Toxicants are not suitable for livestock control.

#### 6.12.5 Livestock Control Through Frightening (USDA, 1991)

Frightening devices such as animated scarecrows or fire-crackers may temporarily deter livestock from inhabiting an area, but these techniques generally do not provide a long-term solution to livestock damage.

#### 6.12.6 Livestock Control Through Repellents (USDA, 1991)

Repellents are not suitable for livestock control.

#### 6.12.7 Livestock Control Through Shooting (USDA, 1991)

Shooting may be an effective method of removing a small population of nuisance livestock; however, hunting is generally only permitted for wild animals such as pigs. Dam owners should contact their state wildlife agency regarding hunting regulations and restrictions.

### 6.13 Crayfish Management Methods

#### 6.13.1 Crayfish Control Through Habitat Modification (Virginia Cooperative Extension, 2001a).

Damage may be prevented by stocking the reservoir with natural enemies of crayfish, such as trout, bass, catfish, and large bluegills. These species will eat the crayfish, which will reduce the overall crayfish population and decrease the number of burrows.

#### 6.13.2 Crayfish Control Through Trapping (University of Nebraska, 1994)

Wire cage traps baited with fish or meat can be used to catch crayfish.

#### 6.13.3 Crayfish Control Through Fumigants (University of Nebraska, 1994)

No fumigants are Federally registered for crayfish control.

#### 6.13.4 Crayfish Control Through Toxicants (University of Nebraska, 1994)

No toxicants are Federally registered for crayfish control. Some states, however, have regulations that allow application of certain insecticides for crayfish burrow treatment. Dam owners should consult with their state wildlife agency regarding the legality of toxicants in their state.

#### 6.13.5 Crayfish Control Through Frightening

Frightening is not an effective method of controlling crayfish.

#### 6.13.6 Crayfish Control Through Repellents (University of Nebraska, 1994)

No repellents are registered for crayfish control.

#### 6.13.7 Crayfish Control Through Shooting

Shooting is not a suitable method of controlling crayfish.

### 6.14 Coyote Management Methods

#### 6.14.1 Coyote Control Through Habitat Modification (USDA, 1991)

Proper vegetative management (mowing and brush removal) and rodent control will often discourage coyotes from digging in earthen dams.

#### 6.14.2 Coyote Control Through Trapping (University of Nebraska, 1994)

Steel leg-hold traps (No. 3 and 4) are often used for coyote removal. Effective use of these traps for coyote control generally requires a great deal of experience and training.

Dam owners should contact their state wildlife agency for guidance on trapping nuisance coyotes.

Snaring is another method of removing coyotes. Snaring involves setting a steel-cable loop in an animal's path to capture it by the neck, body, or leg. Snares are light-weight, compact, easy to set, low-cost, and they offer a high degree of human safety. In one study, they were proven to be more effective than leg-hold traps for coyote control. Snares are usually made of a 2.5- to 10-foot long piece of galvanized aircraft cable with a slide lock that forms a loop. Snares should be set along known coyote trails. They must be attached to a solid object so that the captured animal cannot escape. Snares should not be set where they could capture pets or livestock. Snares are not legal in all states so dam owners should consult with their state wildlife agency before choosing this control method. Once caught, coyotes should be humanely destroyed.

#### 6.14.3 Coyote Control Through Fumigants (University of Nebraska, 1994)

Gas cartridges are the only registered fumigant for coyote control. Gas cartridges are General Use Pesticides that can usually be purchased at local farm supply stores or pesticide dealers. When ignited and placed in the den, a gas cartridge will produce carbon monoxide, carbon dioxide, and other gases that are toxic to the coyote. Gas cartridges should be used with caution and in accordance with the directions on the label. Dam owners should consult with their state wildlife agency regarding state and local regulations on gas cartridges and the use of fumigants.

#### 6.14.4 Coyote Control Through Toxicants (University of Nebraska, 1994)

The only toxicant registered for coyote control is sodium cyanide used in an M-44 ejector device. The M-44 is a spring-activated device that expels a sodium cyanide capsule into the animal's mouth. The M-44 device should be set along the sides of trails or paths used by coyotes. This control method is most effective during cooler months. The M-44 sodium cyanide device is classified as a Restricted Use Pesticide and may only be used by USDA Animal Damage Control personnel and, in some states, certified pesticide applicators. The M-44 is not registered for use in all states so dam owners must consult their state wildlife agency before implementing this control measure.

#### 6.14.5 Coyote Control Through Frightening (USDA, 1991)

Several types of frightening devices are available for coyote control, but these devices were designed for livestock protection and are not practical for protection of earthen dams.

#### 6.14.6 Coyote Control Through Repellents (University of Nebraska, 1994)

No repellents have proven effective for coyote control.

#### 6.14.7 Coyote Control Through Shooting (USDA, 1991)

Coyote hunting is often an effective method of control for livestock protection, but it is generally not practical for protecting earthen dams. If a dam owner decides to pursue this method of control, they must contact the state wildlife agency for information on hunting regulations.

### 6.15 Mole and Vole Management Methods

#### 6.15.1 Mole and Vole Control Through Habitat Modification (University of Nebraska, 1994; USDA, 1991)

It is possible to discourage moles from burrowing in an earthen dam by implementing the following habitat modification techniques:

- Compact the soil with a roller to reduce soil moisture. This will reduce the habitat's attractiveness to moles.
- Apply insecticides to reduce food supply. Legal insecticides may vary by state so dam owners should contact their state wildlife agency for specific guidance.

#### 6.15.2 Mole and Vole Control Through Trapping (University of Nebraska, 1994)

Trapping is the most effective method of reducing mole populations. Several traps are specifically designed for moles, including the Victor mole trap, Out O' Sight, and Nash (choker loop) mole trap. If used properly, any of these traps can be effective. Traps should be set in the surface runway where there is evidence of recent mole activity.

Trapping is generally not an effective method of reducing large vole populations because of prohibitive time and

labor costs. Mouse snap traps may be used for control of a few individual voles. Traps should be set perpendicular to a runway with the trigger end in the runway. Voles are easiest to trap in the fall and late winter.

### 6.15.3 Mole and Vole Control Through Fumigants (University of Nebraska, 1994)

Both aluminum phosphide and gas cartridges are Federally registered for mole control. Aluminum phosphide is a Restricted Use Pesticide that comes in tablet form. One tablet should be placed in each burrow entrance and then the burrow should be plugged with soil to form an air-tight seal. The legal application of aluminum phosphide may vary from state to state so dam owners should consult with their state wildlife agency or state pesticide registration board before implementing this control method.

Gas cartridges are General Use Pesticides that can usually be purchased at local farm supply stores or pesticide dealers. When ignited, a gas cartridge will produce carbon monoxide, carbon dioxide, and other toxic gases. The cartridge should be lit before it is placed in the burrow. Once it has been inserted, the burrow should be immediately plugged with soil. Gas cartridges should be used with caution and in accordance with the directions on the label. Dam owners should consult with their state wildlife agency for information on state and local regulations regarding gas cartridges and the use of fumigants.

Fumigants are generally not effective for vole control. The vole burrow system is so complex and shallow that the fumigant easily escapes to the surface.

### 6.15.4 Mole and Vole Control Through Toxicants (University of Nebraska, 1994)

Strychnine alkaloid and chlorophacinone are both Federally registered for mole control. Strychnine alkaloid is a Restricted Use Pesticide that can only be purchased and applied by a certified pesticide applicator. However, since moles do not normally consume grain, strychnine alkaloid grain baits are seldom effective. Chlorophacinone is commercially available in pellet form under the name Orco Mole Bait. Researchers have found that this is a highly effective and easy to apply mole control technique. Dam owners should be aware, though, that two or more successive treatments are often required. If a dam owner chooses either of these methods of control, they should contact the state wildlife agency regarding the legality of toxicant use in their state.

Zinc phosphide is often used for vole control. Zinc phosphide is a single-dose toxicant available in pellet or grain bait formulas. Pellets or grain bait can be delivered to burrows by hand or mechanically dispensed. Zinc phosphide is a Restricted Use Pesticide, which must be purchased and applied by a certified pesticide applicator. Anticoagulant baits can also be used to reduce vole populations. Anticoagulants generally require several feedings and can take anywhere from 5 to 15 days to be effective. Bait can be delivered by hand, mechanically dispensed, or placed in various types of bait containers. Registration for anticoagulants varies by state.

All products should be used as directed. Dam owners should consult with their state wildlife agency regarding legality of toxicant use in their state.

### 6.15.5 Mole and Vole Control Through Frightening (University of Nebraska, 1994)

Frightening is not an effective method of control for moles or voles.

### 6.15.6 Mole and Vole Control Through Repellents (University of Nebraska, 1994)

No repellents are registered for mole control.

Several repellents using thiram or capsaicin as the active ingredient are registered for vole control, but there is no evidence that these repellents are actually effective. Dam owners should contact their state wildlife agency or pesticide regulatory agency for information on available repellents in their state.

### 6.15.7 Mole and Vole Control Through Shooting (University of Nebraska, 1994)

Shooting is not an effective method of control for moles or voles.

## 6.16 River Otter Management Methods

### 6.16.1 River Otter Control Through Habitat Modification (University of Nebraska, 1994)

Habitat modification is generally not an effective method of control for river otters. Otters often share their environment with beavers, whose burrowing activity is detrimental to the earthen dam environment. Otters will often live in

beaver burrows and dens and do not often dig their own dens. Before mitigating for the river otter, evaluate whether the damaging actions are caused by beaver so that the appropriate species is managed and proper preventive actions are implemented (as discussed in Chapters 4.0 and 5.0 of this manual).

#### 6.16.2 River Otter Control Through Trapping (University of Nebraska, 1994)

Both Conibear (No. 220 and 330) and leghold (modified No. 1 ½ soft-catch and No. 11 double coilspring) traps have been successfully used to catch river otters. Traps should be placed underwater along river otter trails or on “pull-outs” where otters leave the water. Leghold traps can also be used out of the water along trails and peninsula crossings. River otter trapping is illegal in many states so dam owners should contact their state wildlife agency before initiating a trapping program.

#### 6.16.3 River Otter Control Through Fumigants (University of Nebraska, 1994)

No fumigants are registered for river otter control.

#### 6.16.4 River Otter Control Through Toxicants (University of Nebraska, 1994)

No toxicants are registered for river otter control.

#### 6.16.5 River Otter Control Through Frightening (University of Nebraska, 1994)

Frightening has not proven to be an effective method of river otter control.

#### 6.16.6 River Otter Control Through Repellents (University of Nebraska, 1994)

No repellents are registered for river otter control.

#### 6.16.7 River Otter Control Through Shooting (University of Nebraska, 1994)

Shooting is generally only effective for removing small populations of river otters. Dam owners should contact their state wildlife agency for information on hunting regulations and requirements.

### 6.17 Gopher Tortoise Management Methods

The gopher tortoise is a Federally listed threatened species and therefore subject to the provisions of the Endangered Species Act. The historic range of the gopher tortoise includes Alabama, Florida, Georgia, Louisiana, Mississippi, and South Carolina. Dam owners in those states who suspect that they have a gopher tortoise problem should contact the USFWS and their state wildlife agency for management guidance.

#### 6.17.1 Gopher Tortoise Control Through Habitat Modification (University of Nebraska, 1994)

Habitat modification is generally not an effective method of gopher tortoise control.

#### 6.17.2 Gopher Tortoise Control Through Trapping

Since the gopher tortoise is Federally listed as a threatened species, dam owners should contact the USFWS or their state wildlife agency for management guidance.

#### 6.17.3 Gopher Tortoise Control Through Fumigants (University of Nebraska, 1994)

No fumigants are registered for gopher tortoise control.

#### 6.17.4 Gopher Tortoise Control Through Toxicants (University of Nebraska, 1994)

No toxicants are registered for gopher tortoise control.

#### 6.17.5 Gopher Tortoise Control Through Frightening

Frightening has not proven to be an effective method of gopher tortoise control and would be prohibited under the Endangered Species Act.

#### 6.17.6 Gopher Tortoise Control Through Repellents (University of Nebraska, 1994)

No repellents are registered for gopher tortoise control.

#### 6.17.7 Gopher Tortoise Control Through Shooting (University of Nebraska, 1994)

Gopher tortoises are protected under the Endangered Species Act and therefore, cannot be shot. Dam owners should

contact the USFWS or their state wildlife agency for management guidance.

## 6.18 Red Fox and Gray Fox Management Methods

### 6.18.1 Red Fox and Gray Fox Control Through Habitat Modification

Proper vegetative management (mowing and brush removal) and rodent control will often discourage foxes from digging in earthen dams by reducing their primary food source.

### 6.18.2 Red Fox and Gray Fox Control Through Trapping (University of Nebraska, 1994)

Trapping is a very effective method of controlling foxes, however it requires a great deal of expertise and training. Steel leg-hold traps (No. 1 ½, 1 ¾, and 2 doublespring coil traps; and No. 2 and 3 double longspring trap) are suitable for both red and gray foxes. Cage traps may be used for juvenile red foxes. Traps set along trails, at entrances to fields, and near bait carcasses are most effective.

Snares may also be used to capture foxes. Snaring involves setting a steel-cable loop in an animal's path to capture it by the neck, body, or leg. Snares should be made from 1/16-inch, 5/64-inch or 3/32-inch cable to capture red or gray foxes. The snare should have a 6-inch loop that is placed 10 to 12 inches off the ground. Snares should be set on trails or in crawl holes that are frequented by foxes.

Traps and snares are not legal in all states. Dam owners should contact their state wildlife agency for specific information on trapping regulations.

### 6.18.3 Red Fox and Gray Fox Control Through Fumigants (University of Nebraska, 1994)

Gas cartridges are the only registered fumigant for red and gray fox control. Gas cartridges are General Use Pesticides that can usually be purchased at local farm supply stores or pesticide dealers. When ignited and placed in the den, a gas cartridge will produce carbon monoxide, carbon dioxide, and other gases that are toxic to the fox. Gas cartridges should be used with caution and in accordance with the directions on the label. Dam owners should consult with their state wildlife agency for information on state and local regulations regarding gas cartridges and the use of fumigants.

### 6.18.4 Red Fox and Gray Fox Control Through Toxicants (University of Nebraska, 1994)

The only toxicant registered for red and gray fox control is sodium cyanide used in an M-44 ejector device. The M-44 is a spring-activated device that expels a sodium cyanide capsule into the animal's mouth. It should be set along trails and at crossings regularly used by foxes. This is a Restricted Use Pesticide and may only be used by USDA Animal Damage Control personnel and, in some states, certified pesticide applicators. The M-44 is not registered in all states so dam owners must consult their state wildlife agency before implementing this control measure.

### 6.18.5 Red Fox and Gray Fox Control Through Frightening (University of Nebraska, 1994)

Noise-making devices such as radios, amplifiers, or propane exploders may temporarily deter foxes from inhabiting an area, but they do not provide a long-term solution.

### 6.18.6 Red Fox and Gray Fox Control Through Repellents (University of Nebraska, 1994)

No repellants are registered for red or gray fox control.

### 6.18.7 Red Fox and Gray Fox Control Through Shooting

Shooting is another method of managing both red and gray foxes. Hunting regulations and seasons vary by state. Dam owners should contact their state wildlife agency for specific information on hunting foxes.

## 6.19 Canada Goose Management Methods

### 6.19.1 Canada Goose Control Through Habitat Modification (Virginia Cooperative Extension, 2001b; University of Nebraska, 1994)

The following habitat modification techniques can be implemented to reduce Canada goose damage:

- Minimize the amount of forage plants that exists near the water body by mowing or hand removal.
- Construct a wire grid of stainless steel spring wire or monofilament line above the surface of the water. This will prevent Canada geese and other waterfowl from using the water and discourage them from nesting in that

area. The individual lines should be staked to the ground about 12 inches above the water's surface.

### 6.19.2 Canada Goose Control Through Trapping (University of Nebraska, 1994; Virginia Cooperative Extension, 2001b)

Live trapping may be effective for small populations of Canada geese. Several types of traps are effective including walk-in funnel traps, rocket or cannon nets, and spring-powered nets. A federal permit is required before trapping may be initiated. In addition, all relevant state and federal agencies must agree on what will happen to the geese after capture. Dam owners should contact the USFWS and their state wildlife agency for guidance.

Walk-in funnel traps are most effective in late June or early July. These types of traps can be constructed using poultry wire, woven wire fencing, steel fence posts, and netting (Figure 6-15). The trap should be set immediately next to the affected waterbody and then the geese should be herded into the trap. The herders must surround the geese on three sides, forcing them into the trap. Once the geese are secured in the trap, they may be transported to a designated location.

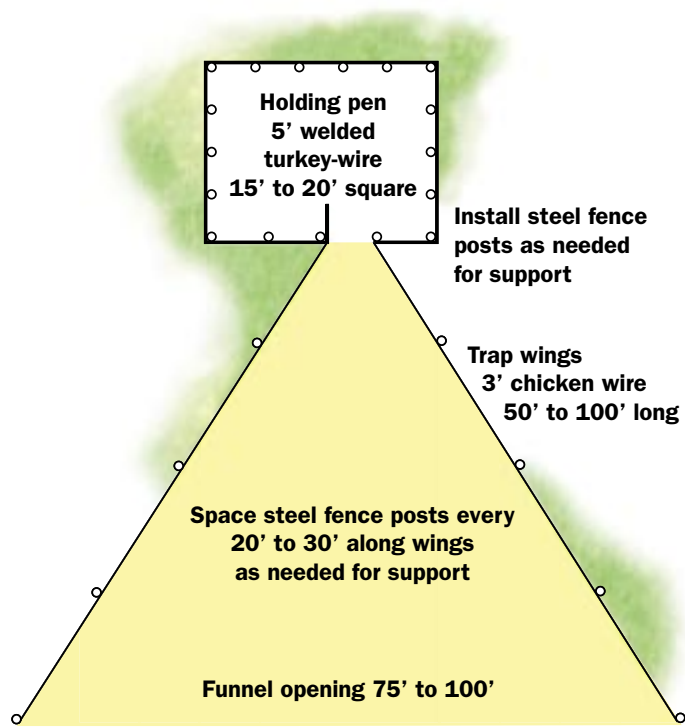

Figure 6-15. Canada goose funnel trap.

Net traps may also be used to capture Canada geese. Rocket or cannon nets with 2- to 2.5-inch mesh work well for large geese. The net should be placed at a location near the water and a second site should be repetitively baited with corn or other suitable bait until the bait is well accepted. Once the geese are trained to feed at the bait site, the area should be re-baited in preparation for capture. When the geese are concentrated at the site, the rocket or cannon net should be fired at the location so the birds are trapped underneath. The Canada geese can then be transported to a designated location. Spring-powered nets work in a similar fashion, though they are smaller than standard rocket or cannon nets. The net is triggered mechanically or electronically, and because it does not create as much noise as the rocket or cannon net, it may be more effective even though it is smaller.

A final method of capturing Canada geese is through the use of an immobilizing agent, Alpha-chloralose. Alpha-chloralose is a non-lethal chemical that is applied to bait and then fed to the geese. Approximately 20 to 90 minutes after ingestion, the geese will be unable to fly or escape and can be captured by hand. Alpha-chloralose may only be used by USDA Animal Damage Control (ADC) staff or biologists of other certified state or federal wildlife management agencies. Dam owners should contact USDA ADC staff, the USFWS, or their state wildlife agency for more information about this option.

### 6.19.3 Canada Goose Control Through Fumigants

Fumigants are not a practical method of control for Canada geese.

### 6.19.4 Canada Goose Control Through Toxicants (University of Nebraska, 1994)

No toxicants are registered for Canada goose control.

### 6.19.5 Canada Goose Control Through Frightening (Virginia Cooperative Extension, 2001b)

Auditory and visual scare devices may be used to deter Canada geese from inhabiting an area. Auditory scare devices make loud noises that will frighten geese away. Commonly used devices include propane cannons, pyrotechnics, and pre-recorded tapes of Canada goose distress calls. Visual scare devices installed on or around an earthen dam are also effective. They are usually inexpensive and easy to install, but they work best in conjunction with another deterrent.



Examples of visual scare devices include strobe lights, scare-crows, owl effigies, mylar reflective tape, flags, and balloons.

Harassment or hazing of Canada geese is generally more effective than visual or auditory deterrents, but it can be labor intensive and expensive. Examples of common hazing programs include use of radio-controlled toys (boats or airplanes), trained dogs, or high-power water spray devices. These deterrent activities must be persistent and repeated to remain effective.

#### 6.19.6 Canada Goose Control Through Repellents (Virginia Cooperative Extension, 2001b)

Methyl anthranilate has been registered as a goose repellent under the name ReJeX-iT. This repellent is non-toxic and does not harm the geese. Re-JeX-iT is applied directly to the grass of an affected area. It may have to be reapplied frequently to remain effective. Repellents should always be used as directed.

#### 6.19.7 Canada Goose Control Through Shooting (University of Nebraska, 1994)

Hunting is another effective method of reducing Canada goose populations. Since Canada geese are listed as migratory birds under the Migratory Bird Treaty Act, a federal permit is required. In many areas, state permits are also required for hunting Canada geese. Dam owners should contact the USFWS and their state wildlife agency for specific hunting regulations and requirements.

#### 6.19.8 Other Methods of Canada Goose Control

It is also possible to reduce resident Canada goose populations by oiling, shaking, or puncturing their eggs. This requires a federal permit; dam owners should contact USFWS and their state wildlife agency for more information.

### 6.20 American Alligator Management Methods

The American Alligator is Federally listed as a threatened species “due to similarity of appearance” to the federally endangered American crocodile. This listing grants the American Alligator protection under the Endangered Species Act. Dam owners who experience problems with nuisance alligators should contact the USFWS and their state wildlife agency for management guidance.

#### 6.20.1 American Alligator Control Through Habitat Modification (University of Nebraska, 1994)

Removal of emergent wetland vegetation may reduce alligator densities by reducing cover. There are strict laws however, regarding human modifications to wetlands so dam owners must consult with appropriate state environmental agencies before disturbing any wetland vegetation.

#### 6.20.2 American Alligator Control Through Trapping (University of Nebraska, 1994)

Trapping is an effective method of eliminating alligators from an area. A baited hook is the simplest and most effective method. This involves rigging a large fish hook (12/0 forged) with bait (e.g., fish, beef, chicken, or nutria) and suspending it via rope from a tree or pole about 2 feet above the water. When the alligator swallows the bait, the hook is lodged in its stomach and the alligator is retrieved using the attached rope. This method almost always kills or injures the alligator.

Trip-snare traps and wire box traps may also be used. They are not quite as effective as the baited hook, but they do not kill or injure the alligator, which then must be relocated. Dam owners must contact the USFWS and their state wildlife agency for information on trapping regulations, the Endangered Species Act, and permit requirements.

#### 6.20.3 American Alligator Control Through Fumigants (University of Nebraska, 1994)

No fumigants are registered for alligator control.

#### 6.20.4 American Alligator Control Through Toxicants (University of Nebraska, 1994)

No toxicants are registered for alligator control.

#### 6.20.5 American Alligator Control Through Frightening (University of Nebraska, 1994)

Under the Endangered Species Act, no actions to harass or frighten a protected species are allowed.

#### 6.20.6 American Alligator Control Through Repellents (University of Nebraska, 1994)

No repellents are registered for alligator control.

### 6.20.7 American Alligator Control Through Shooting (University of Nebraska, 1994)

Shooting is an effective method of eliminating alligators. A sufficiently powerful rifle (.243 caliber or larger) should be used for a humane kill. Dam owners must contact the USFWS and their state wildlife agency for information on hunting regulations, compliance with the Endangered Species Act, and permit requirements.

## 6.21 Ant Management Methods

### 6.21.1 Ant Control Through Habitat Modification (University of Georgia Cooperative Extension Service, 2000)

It may be possible to reduce ant populations by physically destroying visible ant mounds. This can be accomplished by simply knocking down or disturbing mounds with a stick or shovel. Another option is to pour very hot (almost boiling) water directly on each mound.

*Pouring very hot water on each ant mound will eliminate about 60% of mounds.*

### 6.21.2 Ant Control Through Trapping

Ant traps are commercially available, but they are not effective for large, outdoor ant infestations.

### 6.21.3 Ant Control Through Fumigants (University of Georgia, 1993; University of Georgia Cooperative Extension Service, 2000)

Fumigants may help control some type of ant species. Earthfire® (vaporized resmethrin) and Brom-O-Gas (methyl bromide) are two examples of fumigants that have proven effective against fire ants. Both are Restricted Use Pesticides that must be purchased and applied by a certified pesticide applicator. These fumigants may not necessarily be effective for all ant species. Dam owners should contact a professional pest removal company for information on fumigants that may be effective for their particular ant infestation.

### 6.21.4 Ant Control Through Toxicants (University of Florida Cooperative Extension Service, 2002)

Ants can usually be controlled with baits or chemical treatments. Many of these products are available commercially at hardware stores, home and garden suppliers, and other retail outlets. These treatments come in various forms, including granules, liquids, gels, and ready-to-use tamper resistant containers. Treatment should be tailored to the type of ant species present and the extent of infestation. Dam owners should contact their local cooperative extension agency or a professional pest control company for assistance. Professional pest control companies may also be able to provide stronger treatment options if damage is significant and the use of commercially available products is not effective.

*Insecticides can contaminate both ground and surface waters so dam owners need to be particularly cautious when applying baits or chemical treatments near a reservoir. Insecticide use must occur in accordance with Federal law (FIFRA of 1996).*

### 6.21.5 Ant Control Through Frightening

Frightening is not an effective or practical method of ant control.

### 6.21.6 Ant Control Through Repellents

Large, outdoor ant infestations cannot be effectively controlled through the use of repellents.

### 6.21.7 Ant Control Through Shooting

Shooting is not a practical method of ant control.

# 7.0 Fiscal Considerations for Managing Animal Damage on Earthen Dams

*“There is no free lunch. Either we make the investments required to keep our nation’s dams safe, or we will pay the price in dam failures.”*

*Martin McCann, consulting professor of civil and environmental engineering at Stanford University and director of the National Performance of Dams Program (NPDP).*

Almost everyone in the dam community agrees that the funds spent preserving a dam’s integrity and safe operation will almost always be less than those spent repairing an unsafe dam or worse, recovering from a dam failure. The economics behind this understanding are self-explanatory and probably need no quantitative explanation; yet across the nation, dams deteriorate from animal intrusion damages and dam owners struggle with the financial responsibility of repairing their unsafe dams, or removing them altogether when the repair costs become too great. Clearly then, the economic considerations related to appropriate dam management go beyond the economic efficiency and long-term benefit of such repairs; the considerations involve acknowledgement of animal damages as a problem, human motivation factors, and the availability of funding mechanisms at the federal and state level.

## 7.1 Fiscal Considerations for the Reluctant Dam Owner

As indicated in the FEMA/ASDSO workshops, inspectors, engineers, and regulators can find it difficult to convince dam owners that animal burrows and erosion can have serious detrimental effects on their dams. Even though dam

failures are becoming all too common—partially a product of America’s aging dams—some dam owners put too much confidence in the integrity of their dams, even when visible evidence of animal burrows and inappropriate vegetation are present on their dams. For these dam owners, animal damage management is not likely to become a budget line item until an understanding is developed of how adverse animal intrusion effects can cascade, resulting in extensive repair/replacement costs, as well as the associated liabilities, that follow a dam failure.

## 7.2 Fiscal Considerations of the Willing Dam Owner

Other dam owners are aware of the dangers inherent to animal damages at an earthen dam, but overlook routine owner actions that are relatively affordable and can save hundreds of thousands of dollars in the long-term, not to mention reduce the public safety hazard for those located downstream of the dam. Inspections and repair actions are indeed overlooked, as documented by the states in the 2003 surveys and in the 2002 workshop where “financial limitations by owners” is listed as the most common impediment to timely and adequate dam upkeep. Considering that over 50% of the dams in this country are privately owned (AS-

DSO, 2003), financial limitations to upkeep pose a daunting threat to public safety.

Still other dam owners know the inherent problems of animal damage, and vigilantly conduct inspections, mow twice annually, and fill burrows in a timely manner. However, some dams because of their size, location, and biological attractiveness continue to have animal damage problems despite owner vigilance. In these cases, the dam owner pays continuously to correct animal damages and routine owner actions become an expensive proposition in terms of both time and money.

### 7.3 Overcoming the Economic Hurdles

The current and persisting economic issues with regard to animal damage management at earthen dams is twofold: first, reluctant owners need to be educated on the dangers of animal damages and motivated by economic examples; and second, funding sources for all owners need to be identified to assist funding of needed repairs. To begin to address the first consideration, a simple estimate of routine dam maintenance as it relates to vegetation and animal management (one influences the other) is given below:

Table 7.1

Vegetation Management (mowing twice per year)	\$500 to \$1000 annually*
Owner Inspection (one to two times per year)	No cost for dam owner inspection; inspection once every 2 to 5 years by a Professional Engineer can cost between \$3,500 and \$7,500
Filling animal burrows (per burrow)	\$100 to \$300 depending upon burrow size and repair method (grout or excavate and replace)

\*for most dams, as indicated in FEMA, 2002.

This estimate assumes the dam is in good condition and that the owner is providing upkeep of an already stable operation

As the table indicates, the cost of routinely maintaining a dam is estimated at greater than \$500.00 dollars per year. For many private dam owners, such as businesses and citizens, the outlay of these funds, though relatively low, is prohibitive. Even those dam owners with substantial financial resources are often overwhelmed by the costs of dam maintenance and repairs (WaterWebster, 2003). In these cases, it is important for dam owners to consider that neglect will eventually lead to greater costs on many levels; in short, dam owners can't afford to save money when it

comes to the upkeep of their dams. Economic impacts of a failed dam can include:

**Liability Costs of Loss of Life and Property Damage.** Liability may be imposed on a dam owner if maintenance, repair, or operations were conducted in an unsafe or improper manner. Liability could apply to the dam owner as well as the company who possesses the dam and the individual who or company which operates and maintains the dam. The dam owner must take actions to ensure the dam functions properly so that injuries to people or property are avoided. This applies to foreseeable conditions or circumstances that can be predicted with reasonable certainty. If an inspection identifies problems at the dam, then an owner should correct them (Pennsylvania DEP, 1995).

**Clean-up Costs.** The costs associated with clean-up from a dam failure can be tremendous, depending on the size of the reservoir and the amount of downstream development. Debris removal, sediment clean-up, and reconstruction of damaged infrastructure could be required.

**Loss of Dam Infrastructure and Its Revenue.** Over 30% of the dams in the United States are used primarily for recreation (ASDSO, 2003). The benefit of dams to recreational income to the community can be in the millions of dollars each year, depending on the reservoir size and recreational opportunities available.

**Environmental Losses.** Many reservoirs provide wildlife habitat and associated ecotourism revenue, which generates \$59 billion annually in the United States. Communities often benefit from the "wilderness" which dams and their reservoirs provide.

**Economic Effect on Community.** A community that depends on the dam for several uses (e.g., flood control, irrigation, water supply) will have to locate other facilities to serve these purposes should the dam fail or be removed. Alternative sources could be costly or may not be available as quickly as needed, resulting in an adverse social and economic impact on the community.

In essence, a neglected dam can cause a cascade of adverse effects at the community level as well as result in liability issues for the dam owner. Attaching a reasonable dollar figure to each of the considerations above would illustrate that this considerable investment per year in maintenance is like paying an insurance premium that covers the dam owner and their community.

#### Lessons Learned:

- Maintenance of animal burrows is critical. Burrows should be backfilled and animals removed as soon as possible.
- Owners should inspect their dams in a regular and thorough manner.
- Pond levels should be monitored and safety precautions such as spillways and freeboard should be factored into design.

The second consideration presents the most current and widespread dilemma facing the entire dam community. Many dam owners conduct inspections and typical maintenance as required, but preventive measures and wildlife mitigation actions may also be required. It would seem that vigilant dam owners would ensure the required actions were forthcoming; however, this is not always the case. According to the workshop (FEMA, 2001) and the state surveys (FEMA, 2003), and as echoed in the document *The Cost of Rehabilitating Our Nation's Dams* (ASDSO, 2003), owners of dams in need of repair are often not able to finance the required actions due largely to a lack of funding mechanisms at the state and federal levels; dams become neglected and deteriorate to the point of being hazardous. Currently, there are only a handful of states that provide financial assistance in the form of loans or grants to repair unsafe dams, as presented in Table 7-2.

#### Animal Burrows Contribute to \$5 Million Dam Breach

Wallula, Iowa

The Iowa Beef Processor's (IBP) Waste Pond was constructed in 1971 to store wastewater from the IBP Plant. When full, the pond had a surface area of 37 acres and a maximum storage capacity of 270 acre-feet. The pond was located on a natural drainage course and was impounded behind a 15-foot-high, 1000-foot-long earthen dam. State inspections in 1981 and 1985 discovered that the embankment was riddled with animal burrows. It was recommended that the burrows be filled and the animals removed from the site. Repairs were not made quickly enough, and the rapid melting of record snow pack coupled with higher than normal pond levels filled the waste pond and overtopped a portion of the west end of the dam (the dam had no emergency spillway). High pond levels allowed water to exit through animal burrows that were normally above the pond elevation. Uncontrolled leakage and seepage through the animal borrows exiting on the downstream face likely resulted in erosion that backcut rapidly toward the upstream face, eventually breaching the dam.

The estimated cost of the failure was \$5 million, which included the cost of the five locomotives that were derailed downstream, environmental cleanup, and repair to the rail line. The cost to construct a new facility was several million more dollars.

Table 7-2 Summary of State Dam Funding Programs

State	Program Name and Type	Eligibility	Loan/Grant Amount
Arizona	Dam Repair (loan or grant)	State engineer determines dam to be dangerous to life, non-emergency	Loan – Cost of project
Maryland	Maryland Environmental Service (loan and planning assistance)	Counties, utilities, and private groups; must have established service district for water supply, resource reclamation, dredging or stormwater	
Massachusetts	No name given (grants)	Local communities for repair or removal	75% of the project; local share can be in-kind contributions
New Jersey	Dam Restoration and Clean Water Trust Fund (revolving loan fund; new grant fund for municipally-owned dams)	Local units of governments; private owners can be co-applicants	Loan – Cost of project Grants – Up to 100%
New York	Clean Water/Clean Air Bond Act (grants)	Municipalities for dam safety projects	75% of eligible project with 25% local match; \$300,000 cap per project
Ohio	Ohio Water Development Authority (revolving loan fund)	Owner must be under mandate from ODNR <b>Dam Safety Loan Program</b> – Local units of government, state, districts <b>Dam Safety Linked Deposit Program</b> – private owners/organizations	Cost of project
Pennsylvania	Pennvest (revolving loan fund)	Projects associated with wastewater, water supply, or stormwater	Up to cost of project
Utah	Utah Board of Water Resources (loans or grants)	High hazard dam owners; mandated repairs	80-95% grant for irrigation or water supply dams; loans or grants for other owners
Wisconsin	DNR Municipal Dam Grant Program (grants)	Local units of government and lake districts	50-50 grants; \$200,000 maximum

Similarly, the federal government extends dam rehabilitation assistance through only a few programs. The combination of existing state and federal assistance does not approach the estimated \$36.2 billion needed nationwide to support needed dam repair and rehabilitation related to wildlife damages and other structural integrity issues.

Table 7-3. Summary of Potential Federal Programs for Dam Management

Agency	Program	Description
Natural Resources Conservation Service, Department of Agriculture	10.916 Watershed Rehabilitation Program	Provides grants to rehabilitate dams originally built with assistance from USDA Watershed Programs. Rehabilitation must extend the life of the dam and meet applicable performance and safety requirements. Priority is given to high hazard dams.
Natural Resources Conservation Service, Department of Agriculture	10.904 Watershed Protection and Flood Prevention	Provides grants and technical assistance to carry out watershed improvement projects that protect, develop, and utilize the land and water resources in small watersheds.
Bureau of Indian Affairs, Department of the Interior	15.065 Safety of Dams on Indian Lands	Provides direct payments to federally recognized Indian tribal governments and Native American organization to improve the structural integrity of dams on Indian lands.
Federal Emergency Management Agency, Department of Homeland Security	97.047 Pre-Disaster Mitigation (PDM)	Provides grants to states and communities for cost-effective hazard mitigation activities that are part of a comprehensive mitigation program, and that reduce injuries, loss of life, and damage and destruction of property. Dam repair and rehabilitation projects may be eligible for PDM funding if: <ul style="list-style-type: none"> <li>• The project has a high benefit-cost ratio;</li> <li>• There is a high risk of dam failure or dam failure would result in significant damages; and</li> <li>• The project is consistent with State funding priorities.</li> </ul>
Federal Emergency Management Agency, Department of Homeland Security	PL. 107-310 National Dam Safety and Security Act of 2002	Funds are granted each year to state dam safety programs.
Federal Insurance and Mitigation Administration, Federal Emergency Management Agency	83.550 National Dam Safety Program (Dam Safety State Assistance Program)	Funds are distributed each year (in the form of project grants) to state dam safety programs.

In conclusion, the dam community is composed of owners in need of education and economic understanding of the consequences associated with neglected dams, as well as those owners who are diligent in dam upkeep, but perhaps unable to fund the necessary repair and preventive actions. Even if federal, state, and local agencies can educate the reluctant dam owners such that they become vigilant in the upkeep of their dams, our nation's dams will likely continue to degrade without adequate funding to implement the sometimes perpetual animal damage repair and management needed.

# 8.0 References

- Association of State Dam Safety Officials. 2001. ASDSO West Region Technical Seminar. Plant and Animal Penetrations of Earthen Dams. Dr. B. Dan Marks, P.E.; Dr. Bruce Tschantz, P.E., and Mr. David K. Woodward, M.S., editors.
- Association of State Dam Safety Officials. 2002. A Technical Manual on the Effects of Tree and Woody Vegetation Root Penetrations on the Safety of Earthen Dams.
- Association of State Dam Safety Officials. 2003. The Cost of Rehabilitating our Nation's Dams: A Methodology, Estimate & Proposed Funding Mechanisms..
- Barnes, Thomas G. 1991. Managing Beaver Problems in Kentucky. University of Kentucky College of Agriculture. <http://www.ca.uky.edu/agc/pubs/for/for50/for50.htm>. Site accessed December 8, 2003.
- Benyus, Janine M. 1989. The Field Guide to Wildlife Habitats of the Eastern United States. Simon & Schuster Inc.: New York, New York.
- Colorado State University Cooperative Extension. 2003. Managing Pocket Gophers. [www.ext.colostate.edu/pubs/natres/06515.html](http://www.ext.colostate.edu/pubs/natres/06515.html). Site accessed December 3, 2003.
- Connecticut Department of Environmental Protection. 1999. Muskrat. <http://dep.state.ct.us/burnatr/wildlife/factsheets/muskrat.htm> Site accessed December 12, 2003.
- Enchanted Forest Nature Sanctuary. 2003. Gopher Tortoises. <http://nbbd.com/godo/ef/gtortoise/> Site accessed October 31, 2003.
- Federal Emergency Management Agency. 2000. Report on Specialty Workshop #1. Plant and Animal Impacts on Earthen Dams. Prepared by the Association of State Dam Safety Officials; Lexington, Kentucky.
- Federal Emergency Management Agency. 2003. Dam Owner's Guide to Plant Intrusion of Earthen Dams. Prepared by URS Group, Inc.



- Gopher Tortoise Council. 2001. The Gopher Tortoise: A Species in Decline. <http://www.gophertortoisecouncil.org/tortoise.htm>. Site visited October 31, 2003; and November 4, 2004.
- Indiana Department of Natural Resources. 2003. Dam Safety: Rodent Control. Fact Sheet 03-14.
- Indiana Department of Natural Resources. 2003. Division of Water. Indiana Dam Safety Inspection Manual.
- Michigan State University Extension. 1998. Aquatic Pest Management: A Training Manual for Commercial Pesticide Applicators (Category 5). <http://www.msue.msu.edu/msue/imp/modet/morefile/e-2437.pdf>. Site accessed December 12, 2003.
- New York State Department of Environmental Conservation (DEC). 2002. Handout #5 Modifying Sites to Discourage Beaver Occupation. <http://www.dec.state.ny.us/website/dfwmr/wildlife/beaver/handout5.htm>. Site accessed December 8, 2003.
- Niering, William A. 1985. Wetlands. Chanticleer Press, Inc. New York.
- North Carolina State University. 1994. Beavers. <http://www.ces.ncsu.edu/nreos/wild/wildlife/wdc/beavers.html>. Site accessed December 8, 2003.
- \_\_\_2003. Wildlife. <http://h2osparc.wq.ncsu.edu/wetland/aqlife/wildlife.html>. Site accessed October 31, 2003.
- Ohio Department of Natural Resources (DNR). 1999. Dam Safety: Rodent Control. [http://www.dnr.state.oh.us/water/pubs/fs\\_div/ftsht27.htm](http://www.dnr.state.oh.us/water/pubs/fs_div/ftsht27.htm). Site accessed November 11, 2003.
- Peckarsky, Barbara L., Pierre R. Fraissinet, Marjory A. Penton, and Don J. Conklin Jr. 1990. Freshwater Macroinvertebrates of Northeastern North America. Cornell University Press: Ithaca, New York.
- Pehling, Dave. 2003. Principles of Vertebrate Pest Management. <http://snohomish.wsu.edu/vertchap.htm>. Site accessed December 10, 2003.
- Pennsylvania Department of Environmental Protection (DEP). 1995. Liability and Responsibility of Dam Owners. 3200-FS-DEP-1954. <http://www.dep.state.pa.us/dep/deputate/watermgt/WE/FactSheets/Dam/fs1954.htm>. Site accessed December 8, 2003.
- Porter, Mike. 2003. Beaver Damage Preventable With Appropriate Techniques. Noble Foundation. <http://www.noble.org/Ag/Wildlife/BeaverDamagePreventable/> Site accessed December 8, 2003.
- Salisbury, David. 1998. \$20 Billion Needed to Ensure Safety of Nation's Dams, Engineer Estimates. Stanford Online Report. <http://news-service.stanford.edu/news/march11/damsafety.html>. Site accessed November 11, 2003.
- Smith, Diana. 2003. University of Nebraska. Personal Communication with E. Zamensky. URS Corporation. October 21.
- \_\_\_2004. University of Nebraska. Personal Communication with E. Zamensky. URS Corporation. November 22.
- South Carolina Department of Natural Resources. 2003. The Muskrat in South Carolina: Biology, Management & Control. [www.dnr.state.sc.us/wild/img/muskrat.pdf](http://www.dnr.state.sc.us/wild/img/muskrat.pdf). Site accessed November 21, 2003.
- Texas Wildlife Management Damage Service. 1998. Controlling Badger Damage. Publication L-1923.
- U.S. Department of Agriculture. 1991. Prevention and Control of Animal Damage to Hydraulic Structures.
- U.S. Fish and Wildlife Service. 2002a. ESA Basics. <http://endangered.fws.gov/pubs/esa%20basics.pdf>. Site accessed November 3, 2003.
- \_\_\_2002b. Migratory Bird Permits. <http://birds.fws.gov/Permits-Fact-Sheet.pdf>. Site accessed November 3, 2003.
- U.S. Forest Service. 1994. Animal Damage Management Handbook. Pacific Northwest Research Station.
- University of Arizona. 1997. Ant Information. <http://insect-ed.arizona.edu/antinfo.htm>. Site accessed November 25, 2003.

- University of Florida Cooperative Extension Service. 2002. Ants. [http://edis.ifas.ufl.edu/BODY\\_IG080](http://edis.ifas.ufl.edu/BODY_IG080). Site accessed November 25, 2003.
- University of Georgia Cooperative Extension Service. 1993. Controlling Fire Ants in Urban Areas. Bulletin 1068. <http://www.ces.uga.edu/pubcd/b1068-w.html>. Site accessed December 4, 2003.
- University of Georgia. 2000. Managing Imported Fire Ants in Urban Areas. Bulletin 1191. <http://www.ces.uga.edu/pubcd/B1191.htm>. Site accessed December 4, 2003.
- University of Michigan Museum of Zoology. 2002. Branta Canadensis. [http://animaldiversity.ummz.umich.edu/accounts/branta/b.\\_canadensis\\$narrative.html](http://animaldiversity.ummz.umich.edu/accounts/branta/b._canadensis$narrative.html) Site accessed November 25, 2003.
- University of Missouri Extension. 1999. Controlling Nuisance: Muskrats. Agricultural publication MX0136. <http://muextension.missouri.edu/explore/miscpubs/mx0136.htm>. Site accessed June 2, 2003.
- University of Nebraska. 1994a. Prevention and Control of Wildlife Damage.
- \_\_\_1994b. Animal Damage Management Handbook. General Technical Report PNW-GTR-332.
- \_\_\_2003. Fact Sheet: Managing Canada Goose Damage.
- University of New Hampshire Cooperative Extension. 1997. Beavers and Their Control. <http://ceinfo.unh.edu/Forestry/Documents/beavers.pdf>. Site accessed December 12, 2003.
- Virginia Cooperative Extension. 2000. Managing Wildlife Damage: Beavers (Castor Canadensis). Publication Number 420-202. <http://www.ext.vt.edu/pubs/wildlife/420-202/420-202.html>. Site accessed December 8, 2003.
- Virginia Dam Safety Program. 2003. [www.dcr.state.va.us/sw/damrdnts.htm](http://www.dcr.state.va.us/sw/damrdnts.htm). Site accessed June 2, 2003.
- Virginia Tech. 2001a. The Control of Burrowing Crayfish in Ponds. Publication Number 420-253. <http://www.ext.vt.edu/pubs/fisheries/420-253/420-253.html>. Site accessed November 17, 2003.
- \_\_\_2001b. Managing Wildlife Damage: Canada Goose (Branta canadensis). Publication Number 420-203. <http://www.ext.vt.edu/pubs/wildlife/420-203/420-203.html>. Site accessed November 25, 2003.
- Washington State Department of Ecology. 2003. Iowa Beef Processors Waste Pond. <http://www.ecy.wa.gov/programs/wr/dams/iowa.html>. Site accessed November 13, 2003.
- Water Webster. 2003. America's Crumbling Infrastructure: \$36 billion needed to fix nation's dams; \$10.1 billion for 'most critical' structures. <http://www.waterwebster.com/Assn.ofStateDamSafetyOfficialsNov.102003.htm>. Site accessed December 8, 2003.
- Wilson, Judy M. 2001. Beavers in Connecticut: Their Natural History and Management. Connecticut Department of Environmental Protection.
- Witmer, Gary W., Rodney D. Saylor, and Michael J. Pipas. 1995. Repellant Trial to Reduce Reforestation Damage by Pocket Gophers, Deer, and Elk. In: Proceedings of the Second DWRC Special Symposium: pp. 321-332.

# Appendix A

## State Wildlife Agency Contacts

Alabama Department of Conservation and Natural Resources  
Division of Wildlife and Freshwater Fisheries  
64 N. Union Street  
Montgomery, Alabama 36130  
(334) 242-3469

Alaska Department of Fish and Game  
PO Box 25526  
Juneau, Alaska 99802-5526  
(907) 465-4100

Arizona Game and Fish Department  
2221 W. Greenway Road  
Phoenix, Arizona 85023-4399  
(602) 942-3000

Arkansas Game and Fish Commission  
Natural Resources Drive  
Little Rock, Arkansas 72205  
(501) 223-6359

California Department of Fish and Game  
1416 Ninth Street  
Sacramento, California 95814  
(916) 445-0411

Colorado Department of Natural Resources  
Division of Wildlife  
6060 Broadway  
Denver, Colorado 80216  
(303) 297-1192

Connecticut Department of Environmental Protection  
Bureau of Natural Resources, Wildlife Division  
79 Elm Street  
Hartford, Connecticut 06106-5127  
(860) 424-3011

Delaware Department of Natural Resources and  
Environmental Control  
Division of Fish and Wildlife  
89 Kings Highway  
Dover, Delaware 19901  
(302) 739-5297

Florida Fish and Wildlife Conservation Commission  
620 South Meridian Street  
Tallahassee, Florida 32399-1600  
(850) 921-5990

Georgia Department of Natural Resources  
Wildlife Resources Division  
2070 U.S. Highway 278, S.E.  
Social Circle, Georgia 30025  
(770) 918-6400

Hawaii Department of Land and Natural Resources  
Division of Forestry and Wildlife  
1151 Punchbowl Street, Room 325  
Honolulu, Hawaii 96813  
(808) 587-0166

Idaho Department of Fish and Game  
600 S. Walnut, PO Box 25  
Boise, Idaho 83707  
(208) 334-3700

Illinois Department of Natural Resources  
1 Natural Resources Way  
Springfield, Illinois 62702-1271  
(217) 782-6302

Indiana Department of Natural Resources  
Division of Fish and Wildlife  
402 W. Washington Street, Room W273  
Indianapolis, Indiana 46204  
(317) 232-4080

Iowa Department of Natural Resources  
Wildlife Bureau  
Henry A. Wallace Building  
502 E. 9th Street  
Des Moines, Iowa 50319-0034  
(515) 281-5918

Kansas Department of Wildlife and Parks  
14639 W. 95th  
Lenexa, Kansas 66215  
(913) 894-9113

Kentucky Department of Fish and Wildlife  
1 Game Farm Road  
Frankfort, Kentucky 40601  
(800) 858-1549

Louisiana Department of Wildlife and Fisheries  
2000 Quail Drive  
Baton Rouge, Louisiana.70808  
(225) 763-3557

Maine Department of Inland Fisheries and Wildlife  
284 State Street  
41 State House Station  
Augusta, Maine 04333-0041  
(207) 287-8000

Maryland Department of Natural Resources  
Wildlife and Heritage Service  
Tawes State Office Building, E-1  
580 Taylor Avenue  
Annapolis, Maryland 21401  
(410) 260-8540

Massachusetts Department of Fisheries, Wildlife and  
Environmental Law Enforcement  
Division of Fisheries & Wildlife  
251 Causeway Street, Suite 400  
Boston, Massachusetts 02114-2152  
(617) 626-1590

Michigan Department of Natural Resources  
Wildlife Division  
Mason Building, Fourth Floor  
PO Box 30444  
Lansing, Michigan 48909-7944  
(517) 373-1263

Minnesota Department of Natural Resources  
500 Lafayette Road  
St. Paul, Minnesota 55155-4040  
(651) 296-6157

Mississippi Department of Wildlife, Fisheries and Parks  
1505 Eastover Drive  
Jackson, Mississippi 39211-6374  
(601) 432-2400

Missouri Department of Conservation  
2901 W. Truman Boulevard  
Jefferson City, Missouri 65109  
(573) 751-4115

Montana Fish, Wildlife & Parks  
1420 East Sixth Avenue  
Helena, Montana 59620-0701  
(406) 444-2535

Nebraska Game and Parks Commission  
2200 North 33rd Street  
Lincoln, Nebraska 68503  
(402) 471-0641

Nevada Department of Wildlife  
1100 Valley Road  
Reno, Nevada 89512  
(775) 688-1500

New Hampshire Fish and Game Department  
Wildlife Division  
11 Hazen Drive  
Concord, New Hampshire 03301  
(603) 271-2461

New Jersey Department of Environmental Protection  
Division of Fish and Wildlife  
PO Box 400  
Trenton, New Jersey 08625-0400  
(609) 292-2965

New Mexico Department of Game and Fish  
PO Box 25112  
Santa Fe, New Mexico 87507  
(800) 862-9310

New York State Department of Environmental Conservation  
Division of Fish, Wildlife and Marine Resources  
625 Broadway  
Albany, New York 12233-4750  
(518) 402-8919

North Carolina Wildlife Resources Commission  
Archdale Building  
512 N. Salisbury Street  
Raleigh, North Carolina 27604-1188  
(919) 733-7191

North Dakota Game and Fish Department  
100 N. Bismarck Expressway  
Bismarck, North Dakota 58501-5095  
(701) 328-6300

Ohio Department of Natural Resources  
Division of Wildlife  
1840 Belcher Drive  
Columbus, Ohio 43224-1300  
(800) 945-3543

Oklahoma Department of Wildlife Conservation  
1801 N. Lincoln  
Oklahoma City, Oklahoma 73105  
(405) 521-3851

Oregon Department of Fish and Wildlife  
3406 Cherry Avenue N.E.  
Salem, Oregon 97303-4924  
(503) 947-6000

Pennsylvania Game Commission  
2001 Elmerton Avenue  
Harrisburg, Pennsylvania 17110-9797  
(717) 787-4250

Rhode Island Department of Environmental Management  
Division of Fish and Wildlife  
4808 Tower Hill Road  
Wakefield, Rhode Island 02879  
(401) 789-3094

South Carolina Department of Natural Resources  
Wildlife and Freshwater Fisheries Division  
PO Box 167  
Columbia, South Carolina 29202  
(803) 734-3886

South Dakota Department of Game, Fish, and Parks  
Wildlife Division  
523 East Capitol Avenue  
Pierre, South Dakota 57501-3182  
(605) 773-3381

Tennessee Wildlife Resources Agency  
Wildlife Division  
Ellington Agricultural Center  
PO Box 40747  
Nashville, Tennessee 37204  
(615) 781-6610

Texas Parks and Wildlife Department  
4200 Smith School Road  
Austin, Texas 78744  
(800) 792-1112

Utah Department of Natural Resources  
Division of Wildlife Resources  
1594 W. North Temple  
Salt Lake City, Utah 84114  
(801) 538-4700

Vermont Agency of Natural Resources  
Fish and Wildlife Department  
103 South Main Street  
Waterbury, Vermont 05671-0501  
(802) 241-3700

Virginia Department of Game and Inland Fisheries  
4010 West Broad Street  
Richmond, Virginia 23230  
(804) 367-1000

Washington Department of Fish and Wildlife  
Natural Resources Building  
1111 Washington Street, SE  
Olympia, Washington 98501  
(360) 902-2200

West Virginia Division of Natural Resources  
Wildlife Resources  
State Capitol Building 3, Room 812  
Charleston, West Virginia 25305  
(304) 558-2771  
Wisconsin Department of Natural Resources  
101 South Webster Street  
Madison, Wisconsin 53703  
(608) 266-2621

Wyoming Game and Fish Department  
5400 Bishop Boulevard  
Cheyenne, Wyoming 82006-0001  
(307) 777-4600

# Appendix B

## Association of State Dam Safety Officials Contact Information

Association of State Dam Safety Officials  
450 Old Vine Street, 2<sup>nd</sup> Floor  
Lexington, KY 40507-1544  
Phone: 859-257-5140  
Fax: 859-323-1958  
E-Mail: [info@damsafety.org](mailto:info@damsafety.org)  
Web: [www.damsafety.org](http://www.damsafety.org)

Lori Spragens, Executive Director [lspragens@damsafety.org](mailto:lspragens@damsafety.org)

Susan Sorrell, Meetings & Membership Director  
[sasorrell@damsafety.org](mailto:sasorrell@damsafety.org)

Sarah Mayfield, Information Specialist [smayfield@damsafety.org](mailto:smayfield@damsafety.org)

Maureen Hogle, Administrative Database Specialist  
[mhogle@damsafety.org](mailto:mhogle@damsafety.org)







