

CECW-ED-D Engineer Manual 1110-2-1603	Department of the Army U.S. Army Corps of Engineers Washington, DC 20314-1000	EM 1110-2-1603 16 January 1990 (original) 31 August 1992 (errata #1)
	Engineering and Design HYDRAULIC DESIGN OF SPILLWAYS	
	Distribution Restriction Statement Approved for public release; distribution is unlimited.	

Errata Sheet

No. 1

ENGINEERING AND DESIGN

Hydraulic Design of Spillways

EM 1110-2-1603

16 January 1990

Page 2-12: Replace page 2-12 with the enclosed page correcting equations 2-32, 2-33, and 2-35, and the definition for P_s .



US Army Corps
of Engineers

EM 1110-2-1603
16 Jan 1990

ENGINEERING AND DESIGN

Hydraulic Design of Spillways

ENGINEER MANUAL

CECW-EH-D

DEPARTMENT OF THE ARMY
U.S. ARMY CORPS of ENGINEERS
Washington, D.C. 20314-1000

EM 1110-2-1603

Engineer Manual
No. 1110-2-1603

16 January 1990

Engineering and Design

HYDRAULIC DESIGN OF SPILWAYS

1. Purpose. This manual provides guidance for the hydraulic design of spillways for flood control or multipurpose dams.

2. Applicability. This manual applies to all Headquarter US Army Corps of **Engineers (HQUSACE)** elements and all field operating activities (FDA) having responsibility for the design of Civil Work projects.

3. General. Procedures recommended herein are considered appropriate for design of features which are usable under most field conditions encountered in Corps of Engineers projects. Basic theory is present & as required to clarify presentation and where the state of the art, as found in standard textbooks, is limited. In the design guidance, where possible, both laboratory and prototype experimental test results have been correlated with current theory.

FOR THE COMMANDER:

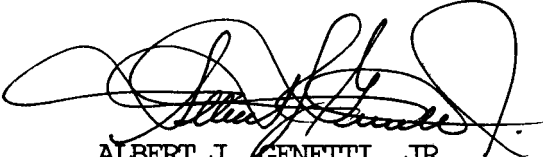

ALBERT J. GENETTI, JR.
Colonel, Corps of Engineers
Chief of Staff

This manual supersedes EM 1110-2-1603, 31 March 1965

Engineer Manual
 No. 1110-2-1603

16 January 1990

Engineering and Design
 HYDRAULIC DESIGN OF SPILLWAYS

Table of Contents

Subject	<u>Paragraph</u>	<u>Page</u>
CHAPTER 1.	INTRODUCTION	
Section I.	General	
	Purpose-----	1-1
	Applicability-----	1-2
	References-----	1-3
	Bibliography-----	1-4
	Symbols-----	1-5
	Other Guidance and Design Aids-----	1-6
	WES Capabilities and Services-----	1-7
	Design Memorandum Presentation-----	1-8
Section II.	Spillway Function, Classification, and Related Studies	
	General-----	1-9
	Spillway Function-----	1-10
	Spillway Classification-----	1-11
	Related Studies-----	1-12
CHAPTER 2.	HYDRAULIC THEORY	
Section I.	Introduction	
	General-----	2-1
	Basic Considerations-----	2-2
Section II.	Spillway Discharge	
	General-----	2-3
	Abutment and Piers-----	2-4
	Effect of Approach Flow-----	2-5
Section III.	Gradients	
	General-----	2-6
	Hydraulic and Energy Grade Lines-----	2-7
	Mean Spillway Pressure Computation-----	2-8
Section IV.	Spillway Energy Loss	
	General-----	2-9
	Energy Loss for Fully Developed Turbulent Boundary Layer Flow-----	2-10
	Turbulent Boundary Layer Development Energy Loss-----	2-11
Section V.	Hydraulic Jump Energy Dissipator	
	General-----	2-12
	Hydraulic Jump Type Energy Dissipator---	2-13
	Sidewall Dynamic Load-----	2-14

	<u>Subject</u>	<u>Paragraph</u>	<u>Page</u>
Section VI.	Cavitation		
	General-----	2-15	2-14
	Cavitation Damage-----	2-16	2-15
	Cavitation Damage Prevention-----	2-17	2-16
CHAPTER 3.	SPILLWAY CREST		
Section I.	Introduction		
	General-----	3-1	3-1
Section II.	Crest Characteristics		
	General-----	3-2	3-1
	Crest Shape-----	3-3	3-2
	Crest Discharge Coefficient-----	3-4	3-3
Section III.	Spillway Piers, Abutments, and Approach		
	General-----	3-5	3-4
	Contraction Coefficients-----	3-6	3-4
	Spillway Bay Surge-----	3-7	3-5
	Spillway Approach-----	3-8	3-6
Section IV.	Spillway Crest Pressures		
	General-----	3-9	3-7
	Controlled and Uncontrolled Crests-----	3-10	3-7
Section V.	Upper Nappe Profile		
	General-----	3-11	3-8
	Nappe Profile-----	3-12	3-8
CHAPTER 4.	SPILLWAY CHUTE		
Section I.	Basic Considerations		
	General-----	4-1	4-1
	Sidewalls-----	4-2	4-1
	Convergent and Divergent Chutes-----	4-3	4-3
Section II.	Chute Spillways		
	General-----	4-4	4-4
	Invert and Water Surface Profile-----	4-5	4-4
	Invert Pressure-----	4-6	4-4
CHAPTER 5.	SPECIALIZED SPILLWAYS		
Section I.	Side Channel Spillways		
	General-----	5-1	5-1
	Crest Design-----	5-2	5-1
	Channel Design-----	5-3	5-1
Section II.	Limited Service Spillways		
	General-----	5-4	5-2
	Discharge-----	5-5	5-2
	Erosion-----	5-6	5-3
	Control Section-----	5-7	5-3
Section III.	Shaft Spillways		
	General-----	5-8	5-4

<u>Subject</u>		<u>Paragraph</u>	<u>Page</u>
	Morning-Glory Outlet-----	5-9	5-4
Section IV.	Labyrinth Spillway General-----	5-10	5-5
Section V.	Box Inlet Drop Spillways General-----	5-11	5-5
CHAPTER 6.	CREST GATES		
	General-----	6-1	6-1
	Tainter Gates-----	6-2	6-1
	Vertical Lift Gates-----	6-3	6-5
	Ice and Wave Forces on Gates-----	6-4	6-6
CHAPTER 7.	ENERGY DISSIPATORS		
Section I.	Basic Considerations General-----	7-1	7-1
	Design Discharge-----	7-2	7-1
	Operation-----	7-3	7-1
Section II.	Stilling Basins General-----	7-4	7-2
	Horizontal Apron Basin-----	7-5	7-2
	Sloping Aprons-----	7-6	7-3
	Baffles-----	7-7	7-3
	End Sills-----	7-8	7-4
	Sidewalls-----	7-9	7-5
	Wing Walls-----	7-10	7-5
	Exit Channel-----	7-11	7-5
	Abrasion and Cavitation-----	7-12	7-6
Section III.	Roller Buckets General-----	7-13	7-7
	Bucket Depth and Radius-----	7-14	7-8
	Slotted Buckets-----	7-15	7-9
	Exit Channel-----	7-16	7-9
Section IV.	Flip Buckets General-----	7-17	7-9
	Bucket Geometry-----	7-18	7-10
	Discharge Considerations-----	7-19	7-12
	Trajectory Distance-----	7-20	7-12
	Bucket Pressures-----	7-21	7-13
	Exit Channel-----	7-22	7-13
	Miscellaneous-----	7-23	7-14
Section V.	Specialized Energy Dissipators Impact Basin-----	7-24	7-14
	Baffled Chute-----	7-25	7-14
APPENDIX A.	BIBLIOGRAPHY		
APPENDIX B.	NOTATION		

EM 1110-2-1603
16 Jan 90

	<u>Subject</u>	<u>Paragraph</u>	<u>Page</u>
APPENDIX C.	PLATES		
APPENDIX D.	COMPUTATIONS FOR DESIGN OF SPILLWAY		
APPENDIX E.	COMPUTATIONS FOR THE DESIGN OF A STILLING BASIN		
APPENDIX F.	COMPUTATION FOR DESIGN OF FLIP BUCKET AND ROLLER BUCKET		

CHAPTER 1

INTRODUCTION

Section I. General

1-1. Purpose. This manual presents guidance for the hydraulic design of spillways for flood control or multipurpose dams. Procedures recommended are considered appropriate for structures suitable to most of the field conditions encountered in Corps of Engineer projects. Basic theory is presented as required to clarify presentation and where the state of the art is limited in textbooks. Both laboratory and prototype experimental test results have been correlated with current theory in the design guidance where possible.

1-2. Applicability. This manual applies to all Headquarters, US Army Corps of Engineers (HQUSACE) elements and all field operating activities having responsibilities for the design of Civil Works projects.

1-3. References.

a. National Environmental Policy Act (NEPA), PL 9-190, Section 102(2)(c), 1 Jan 1970, 83 Stat 853.

b. ER 1110-1-8100, Laboratory Investigations and Materials Testing.

c. ER 1110-2-1402, Hydrologic Investigation Requirements for Water Quality Control.

d. ER 1110-2-2901, Construction of Cofferdams.

e. EM 1110-2-1405, Flood Hydrograph Analyses and Computations.

f. EM 1110-2-1601, Hydraulic Design of Flood Control Channels.

g. EM 1110-2-1602, Hydraulic Design of Reservoir Outlet Works.

h. EM 1110-2-1605, Hydraulic Design of Navigation Dams.

i. EM 1110-2-1612, Ice Engineering.

j. EM 1110-2-2400, Structural Design of Spillways and Outlet Works.

k. EM 1110-2-3600, Management of Water Control Systems.

l. Hydraulic Design Criteria (HDC) sheets and charts. Available from Technical Information Division, US Army Engineer Waterways Experiment Station (WES), PO Box 631, Vicksburg, MS 39181-0631.

m. Conversationally Oriented Real-Time Program-Generating system (CORPS) computer programs. Available from: WES Information Technology

EM 1110-2-1603
16 Jan 90

Laboratory Computer Program Library (WESLIB), US Army Engineer Waterways Experiment Station, PO Box 631, Vicksburg, MS 39181-0631, and from several US Army Corps of Engineers (CE) computer systems.

Where the above-listed references and this manual do not agree, the provisions of this manual shall govern insofar as spillways and energy dissipators for spillways are concerned.

1-4. Bibliography. Bibliographic items are indicated throughout the manual by numbers (items 1, 2, etc.) that correspond to similarly numbered references in Appendix A. These references are available for loan by request to the Technical Information Division Library, US Army Engineer Waterways Experiment Station, PO Box 631, Vicksburg, MS 39181-0631.

1-5. Symbols. A list of symbols is included as Appendix B, and as far as practical, agrees with the American Standard Letter Symbols for Hydraulics (item 4).

1-6. Other Guidance and Design Aids. Extensive use has been made of the HDC, prepared by WES and USACE. Data and information from Engineer Technical Letters and special reports have also been used. References to the HDC are by HDC chart number. Since HDC charts are continuously being revised, the user should verify that the information used is the most up-to-date guidance. Applicable HDC charts and other illustrations are included in Appendix C to aid the designer. References to specific project designs and model studies have been used to illustrate the structure type; however, the dimensions are not necessarily the recommended dimensions for new projects. WESLIB provides time-sharing computer services to CE Divisions and Districts. One such service is the Conversationally Oriented Real-Time Program-Generating System (CORPS) that provides the noncomputer-oriented or noncomputer-expert engineer a set of proven engineering applications programs, which can be accessed on several different computer systems with little or no training. See item 45 for instructions on use of the system and a partial list of available programs. Updated lists of programs can be obtained through the CORPS system. References to available programs that are applicable to the design of spillways are noted in this manual by the CORPS program numbers.

1-7. WES Capabilities and Services. WES has capabilities and furnishes services in the fields of hydraulic modeling, analysis, design, and prototype testing. Expertise also exists at WES in the areas of water quality studies, mathematical modeling, and computer programming. Procedures necessary to arrange for WES participation in hydraulic studies of all types are covered in ER 1110-1-8100. WES has the responsibility for coordinating the CE hydraulic prototype test program. Assistance during planning and making the tests is included in this program.

1-8. Design Memorandum Presentation. General and feature design memoranda should contain sufficient information to assure that the reviewer is able to reach an independent conclusion as to the design adequacy. For convenience, the hydraulic information, factors, studies, and logic used to establish such basic spillway features as type, location, alignment, elevation, size, and

discharge should be summarized at the beginning of the hydraulic design section. Basic assumptions, equations, coefficients, and alternative designs, etc., should be complete and given in appropriate places in the hydraulic presentation. Operating characteristics and restrictions over the full range of potential discharge should be presented for all release facilities provided.

Section II. Spillway Function, Classification, and Related Studies

1-9. General. Project functions and their overall social, environmental, and economic effects may influence the hydraulic design of the spillway. Optimization of the hydraulic design and operation requires an awareness by the designer of the reliability, accuracy, sensitivity, and possible variances of the data used. The ever-increasing importance of environmental considerations requires that the designer maintain close liaison with other disciplines to assure environmental and other objectives are satisfied in the design. General spillway functions, type of spillways, and related design considerations are briefly discussed in the following paragraphs.

1-10. Spillway Function. The basic purpose of the spillway is to provide a means of controlling the flow and providing conveyance from reservoir to tailwater for all flood discharges up to the spillway design flood (SDF). The spillway can be used to provide flood-control regulation for floods either in combination with flood-control sluices or outlet works, or in some cases, as the only flood-control facility. A powerhouse should not be considered as a reliable discharge facility when considering the safe conveyance of the spillway design flood past the dam. A terminal structure to provide energy dissipation is usually provided at the downstream end of the spillway. The degree of energy dissipation provided is dependent upon the anticipated use of the spillway and the extent of damage that will occur if the terminal structure capacity is exceeded. The standard project flood is a minimum value used for terminal structure design discharge. The designer must keep in mind that damage to the dam structure that compromises the structural integrity of the dam is not acceptable. Acceptance of other damages should be based on an economic evaluation of the extent of damage considering the extremely infrequent flood causing the damage.

1-11. Spillway Classification. Spillways are classified into four separate categories, each of which will serve satisfactorily for specific site conditions when designed for the anticipated function and discharge.

a. Overflow Spillway. This type of spillway is normally used in conjunction with a concrete gravity dam. The overflow spillway is either gated or ungated and is an integral part of the concrete dam structure. See Figure 1-1.

b. Chute Spillway. This type of spillway is usually used in conjunction with an earth- or rock-filled dam; however, concrete gravity dams also employ chute spillways. In these cases the dam is usually located in a narrow canyon with insufficient room for an overflow spillway. The chute spillway is generally located through the abutment adjacent to the dam; however, it could

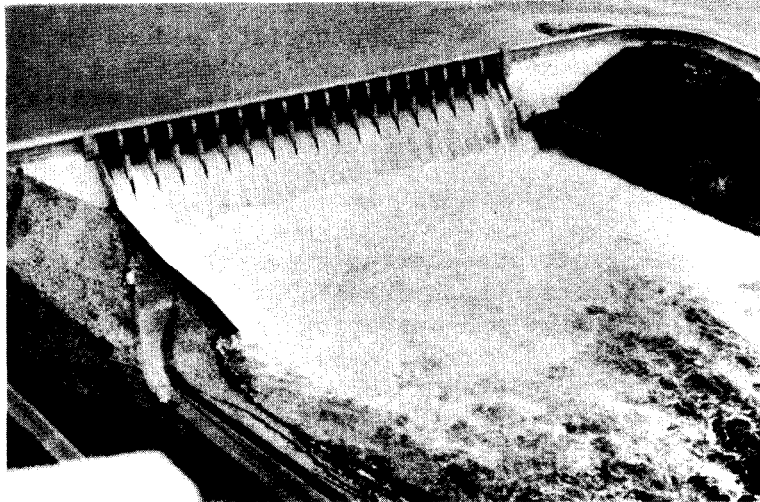
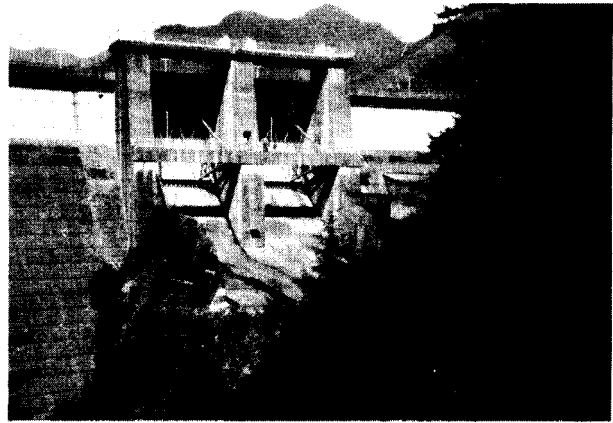

Figure 1-1. Chief Joseph Dam overflow spillway

be located in a saddle away from the dam structure. Examples of chute spillways are shown in Figure 1-2.



Mud Mountain Dam



Wynoochee Dam

Figure 1-2. Chute spillways

c. Side Channel Spillway. This type of spillway is used in circumstances similar to those of the chute spillway. Due to its unique shape, a side channel spillway can be sited on a narrow dam abutment. Side channel spillways generally are ungated; however, there is no reason that gates cannot be employed. Figure 1-3 shows a side channel spillway.

d. Limited Service Spillway. The limited service spillway is designed with the knowledge that spillway operation will be extremely infrequent, and when operation occurs, damage may well result. Damage cannot be to the extent that it would cause a catastrophic release of reservoir water.

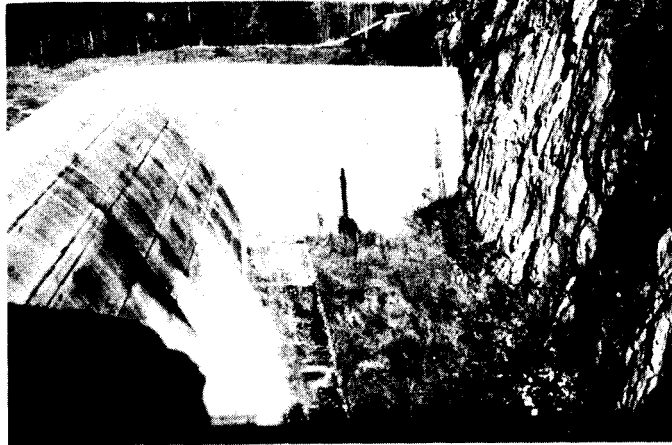

Figure 1-3. Townshend Dam side channel spillway

1-12. Related Studies.

a. Environmental. The general philosophy and guidance for preservation, mitigation, and/or enhancement of the natural environment have been set forth. Many scientific and engineering disciplines are involved in the environmental aspects of hydraulic structures. Some studies influencing the spillway design are briefly discussed below. Pertinent data from these studies should be presented in the design memorandum. The designer is expected to have a working knowledge of these data and their limitations.

(1) Fish and Wildlife. Spillway design and operation may result in damage to downstream fish and wildlife. Flow releases not compatible with naturally seasonable stream quantity and quality can drastically change aquatic life. These changes can result from adverse temperatures and/or nitrogen supersaturation (item 36). The water quality presentation should include information on the expected water quality resulting from spillway use.

(2) Recreation. Recreation needs include fishing, camping, boating, and swimming facilities, scenic outlooks, etc.; and should be considered in the design of spillways, terminal structures, and exit channels. These requirements are usually formulated by the planning discipline in cooperation with local interests. Special consideration should be given to facilities for the handicapped, such as wheelchair ramps to fishing sites below stilling basins. Safety fences are important for the protection of facilities and the public. Appreciable damage to stilling basins has resulted from rocks thrown into the basin by the public. The hydraulic engineer should consider the need for handrails and nonskid walkways, landscaping, and erosion prevention. Rock used for erosion prevention and landscaping should be of a size considerably larger than can be moved by hand.

b. Foundations. The hydraulic design of the spillway and terminal structure can be appreciably affected by the foundation conditions. The spillway and terminal structure type, location, and configuration are usually

fixed primarily by foundation and topographic constraints with due consideration within these constraints given to the hydraulic and structural requirements. Foundation information of interest to the hydraulic designer includes composition and depth of overburden, quality of underlying rock, and quality of exposed rock. In addition, side slope stability is of considerable importance in the design of riprap protection. Outflow stage change rates are required for bank stability design. Sufficient foundation data and/or reference to its source should be included or referred to in the hydraulic presentation to substantiate the terminal structure and exit channel design.

c. Environmental Impact Statements. Section 102(2)(c) of the National Environmental Policy Act requires detailed documentation in the project design memoranda on the impact of the planned project on the environment. The hydraulic engineer is expected to have an active part in the preparation of impact statements. An analysis of 234 CE environmental impact statements on various projects is given in item 52. This report can be used as a guide to the type of material needed and format to be used in developing the statements. Basic to the environmental statements are studies to define the pre-project and project functions and their effects on the environment. In most cases the effect of each project function must be set forth in detail. A recent publication by Ortolano (item 37) summarizes the concepts involved and presents examples relative to water resources impact assessments. Presentation of the hydraulic design in design memoranda must identify environmental requirements and demonstrate how these are satisfied by the hydraulic facility.

d. Downstream Channel Aggradation and Degradation. Tailwater level changes resulting from either aggradation or degradation can adversely affect the terminal structure performance. The effects of tailwater level changes should be thoroughly investigated to demonstrate that the proposed design will function as intended throughout the project life. The determination of the dominant factors causing riverbed degradation and aggradation is difficult. Changes in the hydrologic characteristics caused by a dam may result in undesirable changes in the elevation of the riverbed. Degradation, or lowering of the riverbed, immediately downstream of a dam may threaten the integrity of the structure. Removal of all or part of the sediment by deposition in the reservoir may induce active bank erosion downstream. Similarly, although the total annual sediment transport capacity of the river will drop significantly, the sediment supplied by downstream tributaries will be unaltered and there may be a tendency for the riverbed to rise. This channel aggradation can increase the flood stages.

CHAPTER 2

HYDRAULIC THEORY

Section I. Introduction

2-1. General. This section presents hydraulic design theory, available experimental data and coefficients, and discussions of analysis and problems related to spillway design. Generally, the presentations assume that the design engineer is acquainted with the hydraulic theories involved in uniform flow, gradually and rapidly varied flow, steady and unsteady flow, energy and momentum principles, and other aspects such as energy losses, cavitation, etc., related to hydraulic design. These matters are normally covered in hydraulic handbooks and texts such as those by King and Brater (item 24), Rouse (items 49 and 50), and Chow (item 10). This manual is presented as guidance in the application of textbook material and as additional information not readily available in general reference material. The application of the theory of flow through spillways is based largely upon empirical coefficients, so the designer should deal with maximum and minimum values as well as averages, depending upon the design objective. To be conservative, the designer should generally use maximum loss factors in computing discharge capacity, and minimum loss factors in computing velocities for the design of energy dissipators. As more model and prototype data become available, the range between maximum and minimum coefficients used in design should be narrowed. An example in which the hydraulic design procedures and guidance discussed in this manual are applied to the computation required to design a typical reservoir spillway is shown in Appendix D.

2-2. Basic Considerations. A spillway is sized to provide the required capacity, usually the entire spillway design flood, at a specific reservoir elevation. This elevation is normally at the maximum operating level or at a surcharge elevation greater than the maximum operating level. Hydraulic analysis of a spillway usually involves four conditions of flow:

- a. Subcritical flow in the spillway approach, initially at a low velocity, accelerating, however, as it approaches the crest.
- b. Critical flow as the water passes over the spillway crest.
- c. Supercritical flow in the chute below the crest.
- d. Transitional flow at or near the terminus of the chute where the flow must transition back to subcritical.

When a relatively large storage capacity can be obtained above the normal maximum reservoir elevation by increasing the dam height, a portion of the flood volume can be stored in this reservoir surcharge space and the size of the spillway can be reduced. The use of a surcharge pool for passing the spillway design flood involves an economic analysis that considers the added cost of a dam height compared to the cost of a wider and/or deeper spillway. When a gated spillway is considered, the added cost of higher and/or additional gates and piers must be compared to the cost of additional dam height.

16 Jan 90

When an ungated spillway is considered, the cost of reduced flood-control benefits due to a reduction in reservoir storage must be compared to the cost of additional dam height. The transition of flow from supercritical on the chute to subcritical usually involves considerable energy dissipation. Dissipation of hydraulic energy is accomplished by various methods such as the hydraulic jump, impact, dispersion, etc. The type of energy dissipator used is dependent upon factors that include site geology, the type of dam structure, and the magnitude of the energy to be dissipated. The design discharge for effective energy dissipation is frequently set at the standard project flood rate; however, each facility must be evaluated, and the design discharge used should be dependent upon the damage consequences when the design discharge is exceeded.

Section II. Spillway Discharge

2-3. General.

a. The ogee crest spillway is basically a sharp-crested weir with the space below the lower nappe filled with concrete. The discharge over a spillway crest is limited by the same parameters as the weir, and determined by the following:

$$Q = CL_e H_e^{1.5} \quad (2-1)$$

where

- Q = rate of discharge, cubic feet per second (ft³/sec)
- C = coefficient of discharge
- L = effective length of the crest, feet
- H_e^e = total specific energy above the crest, feet

Extensive investigations of spillway crest shapes, pressures, and coefficients have provided empirical data that will allow the designer to develop a spillway that minimizes the structural size required for the design discharge. Minimization of the structure size is achieved by underdesigning the spillway crest within limits discussed in Chapter 3.

b. An underdesigned crest is defined when the following relationship is true:

$$\frac{H_e}{H_d} > 1$$

where H_d is the crest design head, feet. The design head is a major parameter of the ogee crest shape equation and is discussed in Section II of Chapter 3. Underdesigning the crest results in increasing the discharge coefficient significantly above that of the sharp-crested weir; however, the underdesigned crest results in a reduction of the hydrodynamic pressures on the crest surface. Depending on the degree of underdesigning, the crest pressures can be significantly less than atmospheric.

2-4. Abutment and Piers. All spillways include abutments of some type, and many include intermediate piers. The effect that the abutments and piers have on the discharge must be accounted for; this is accomplished by modifying the crest length using the following equation to determine the effective crest length L_e :

$$L_e = L - 2(nK_p + K_a)H_e \quad (2-2)$$

where

L = net length of crest
 n = number of piers
 K = pier contraction coefficient
 K_p = abutment contraction coefficient
 K_a

2-5. Effect of Approach Flow. Another factor influencing the discharge coefficient of a spillway crest is the depth in the approach channel relative to the design head defined as the ratio P/H_a , where P equals the crest elevation minus the approach channel invert elevation. As the depth of the approach channel P decreases relative to the design head, the effect of approach velocity becomes more significant; and at $P/H_a \leq 1.0$, this effect should not be neglected. The slope of the upstream spillway face also influences the coefficient of discharge. As an example, for $P/H_a > 1$, the flatter upstream face slopes tend to produce an increase in the discharge coefficient. Several investigators have provided data on approach depth and spillway face slope effects. The most recent work has been done by WES (item 28). Data from this work have been used extensively in this manual. The planform of the approach channel can significantly influence the spillway discharge characteristics. The influence of the planform can be evaluated thoroughly only by the use of a site-specific physical model. In some cases a two-dimensional numerical model will be entirely adequate. In the case of a simple spillway approach, analysis of the water surface profile by a standard step method would be sufficient. Spillway approach channels and slope of the upstream spillway face are further discussed in Chapter 3.

Section III. Gradients

2-6. General. The basic principle used to analyze steady incompressible flow through a spillway is the law of conservation of energy expressed by the Bernoulli (energy) equation. The energy equation, generalized to apply to the entire cross section of flow, expresses the energy at any point on the cross section in feet of water by equation 2-3:

$$H = Z + \frac{p}{\gamma} + \alpha \frac{V^2}{2g} \quad (2-3)$$

where

H = total energy head in feet of water above the datum plane
 Z = height above a datum plane, feet
 p = pressure at the point, pounds per square foot (lb/ft^2)

16 Jan 90

- γ = specific weight of water, pounds per cubic foot (lb/ft³)
 α = energy correction coefficient
 V = average flow velocity, feet per second (ft/sec)
 g = acceleration due to gravity, ft/sec²

For most practical problems involving regular-shaped channels, the energy correction coefficient may be taken as unity without serious error.

2-7. Hydraulic and Energy Grade Lines. The hydraulic grade line, also referred to as the mean pressure gradient, may be above, below, or at the free water surface. Defining Z as the invert elevation of a point on the chute, then $Z + p/\gamma$ defines the elevation of the hydraulic grade line at that point. The locus of values of $Z + p/\gamma$ along the spillway describes the mean pressure gradient. The mean pressure gradient at any point along the spillway is always lower than the energy grade line by the value of the mean velocity head at that point. The mean pressure gradient is useful in determining pressures acting on the spillway surface and in determining cavitation potential. For most open channel flow the p/γ term can be replaced by $Y_1 \cos \theta$ where Y_1 is the flow depth normal to the channel bottom and θ is the slope of the channel bottom. Therefore, the sum $Z + Y_1 \cos \theta$ will be equal to the elevation of the water surface at the point and the free surface is the hydraulic grade line for all points on the cross section. For this substitution to be valid, the assumption must be made that the pressure distribution at the point must be hydrostatic, a condition that will occur if conditions are such that vertical acceleration of the flow is negligible and the bed slope is mild.² A nonhydrostatic pressure distribution will occur whenever the value of $\cos^2 \theta$ departs materially from unity, such as with steep spillway chutes. The departure of the pressure distribution from hydrostatic due to a steep bed slope does not mean the energy equation cannot be used on steep spillway chutes as a design tool. It means that the designer must recognize that the values derived become increasingly inaccurate as the $\cos^2 \theta$ value departs further from unity. This condition describes one of the basic reasons that physical model studies may be required when designing a spillway.

2-8. Mean Spillway Pressure Computation. The mean pressure at any location along a chute is determined using the principle of conservation of energy as expressed by the energy equation. Conservation of energy requires that the energy at one location on the spillway be equal to the energy at any downstream location plus all intervening energy losses. Expressed in equation form and in units of feet of water

$$Z_1 + \frac{p_1}{\gamma} + \alpha_1 \frac{V_1^2}{2g} = Z_2 + \frac{p_2}{\gamma} + \alpha_2 \frac{V_2^2}{2g} + H_L \quad (2 - 4a)$$

or for the hydraulic assumption

$$Z_1 + Y_1 \cos \theta + \alpha_1 \frac{V_1^2}{2g} = Z_2 + Y_2 \cos \theta + \alpha_2 \frac{V_2^2}{2g} + H_L \quad (2 - 4b)$$

Information on the determination of energy losses, H_f , associated with flow over spillways is given in appropriate sections of this engineering manual.

Section IV. Spillway Energy Loss

2-9. General. The determination of hydraulic energy loss associated with flow through a spillway system is important to the design of the training walls, piers, and terminal structure. Energy loss is the direct result of three conditions: boundary roughness (friction), turbulence resulting from boundary alignment changes (form loss), and boundary layer development. Sufficient data and procedures are available to make a reasonably accurate determination of the energy loss during development of the turbulent boundary layer and for fully turbulent flow. Form losses are usually minimal for most spillways; however, when the configuration of a spillway is such that form losses outside the range of experience are encountered, model studies are required. Methods and data necessary for spillway energy loss computations are provided in the following paragraphs.

2-10. Energy Loss for Fully Developed Turbulent Boundary Layer Flow.

a. General. Methods for determining the energy loss related to boundary roughness (friction) have been developed by various investigators. The most notable and widely used methods are the Darcy-Weisbach equation, the Chezy equation, and the Manning equation. The Darcy-Weisbach equation involves the direct use of a known effective roughness value, k , from which a boundary resistance (friction) coefficient, f , can be derived for use in the energy loss computation. The Darcy-Weisbach equation is applicable to all fully turbulent flow conditions. The Chezy equation is essentially similar to the Darcy-Weisbach equation in that it involves the direct use of a known effective roughness value and is applicable to all flow conditions. The Manning equation, probably the most commonly used, involves use of an empirically derived resistance coefficient, n , and is considered only applicable to fully turbulent flow. Some investigators such as Strickler have attempted to correlate the Manning's n value to a measured effective roughness value; others have equated the Manning equation to the Darcy-Weisbach equation and to the Chezy equation in order to take advantage of the effective roughness parameter used in those equations. These modifications to the Manning equation have all been accomplished in order to establish some degree of confidence for an otherwise empirically derived roughness coefficient.

b. Darcy-Weisbach Equation. The Darcy-Weisbach equation expresses the energy loss due to boundary roughness in terms of a resistance coefficient, f , as:

$$h_f = \frac{fL}{4R} \left(\frac{V^2}{2g} \right) \quad (2-5)$$

where h_f is the energy loss due to friction through a length of channel L having an average hydraulic radius R and an average velocity V . The energy loss has a length dimension (ft-lb/lb) and is usually expressed in feet of water. The resistance coefficient, f , is a dimensionless parameter which

can be determined for fully turbulent flow conditions by a form of the Colebrook-White equation

$$f = \left[\frac{1}{2 \log \left(\frac{13.8R}{k} \right)} \right]^2 \quad (2-6)$$

or by the Strickler-Manning equation

$$f = 0.113 \left(\frac{k}{R} \right)^{1/3} \quad (2-7)$$

which may more accurately derive the resistance coefficient for $R/k > 100$. In both equations 2-6 and 2-7, k is the effective roughness value and R is the hydraulic radius. Both equations 2-6 and 2-7 are valid only for fully turbulent flow defined by the relationship:

$$R_e > \frac{200}{f^{1/2}} \left(\frac{4R}{k} \right) \quad (2-8)$$

where R_e is the Reynolds number. The actual Reynolds number of the flow condition is defined as:

$$R_e = \frac{4RV}{\nu} \quad (2-9)$$

where ν is the kinematic viscosity of the water. Resistance coefficients throughout the entire range of flow conditions can be obtained through the use of Plate 2-1.

C. Chezy Equation. The Chezy equation defines velocity in terms of the hydraulic radius, the slope S , and the Chezy resistance coefficient C in the form of

$$v = C(RS)^{1/2} \quad (2-10)$$

By equating S to h_f/L and rearranging terms in equation 2-10, the Chezy equation expresses the energy loss due to boundary roughness as

$$h_f = \frac{L}{R} \frac{v^2}{C^2} \quad (2-11)$$

The resistance coefficient, C , is dependent upon the Reynolds number and the effective roughness value. The C value can be determined through the use of Plate 2-1 or by equation 2-12:

$$C = 32.6 \log \left(\frac{12.2R}{k} \right) \quad (2-12)$$

for fully turbulent flow conditions as defined by the relationship:

$$R > \frac{50 CR}{e k} \quad (2-13)$$

Chezy's C can also be determined through the use of the Darcy-Weisbach resistance coefficient, f , by equation 2-14:

$$C = \left(\frac{8g}{f} \right)^{1/2} \quad (2-14)$$

The characteristics of f in circular pipe flow have been thoroughly investigated by Nikuradse and Colebrook and White; however, a similar complete investigation of the characteristics of C in open channel flow have not been made due to the extra variables and wide range of surface roughness involved. However, reasonably accurate results should be obtained through the use of the Chezy equation.

d. Manning Equation. The Manning equation 2-15 defines velocity in terms of the hydraulic radius and slope, in a similar manner to the Chezy equation; however, the resistance coefficient is defined by the Manning's n value.

$$v = \frac{1.486 R^{2/3} S^{1/2}}{n} \quad (2-15)$$

The constant 1.486 converts the metric equation to foot-second units. By equating $S = h_f/L$ and rearranging terms in equation 2-15, the Manning equation expresses the energy loss due to boundary roughness as

$$h_f = \frac{V^2 n^2 L}{2.21 R^{4/3}} \quad (2-16)$$

The Manning's resistance coefficient n , reported in numerous hydraulic publications, is founded on empiricism. It does not address the degree of turbulence or the interaction between the flow and boundary. The empiricism of this coefficient limits its accuracy when applied to conditions somewhat different from those from which it is derived. However, Manning's method is widely used due mainly to the large volume of reference data available to correlate resistance coefficients with boundary conditions and the ease in which the method can be used. When the design involves a significant amount of surface roughness energy loss resulting from fully turbulent flow, such as with a long spillway chute, the Manning's resistance coefficient may be calculated to account for the relative roughness effect by the use of

$$n = \frac{f^{1/2} R^{1/6}}{10.8} \quad (2-17)$$

or

$$n = 1.486 \frac{R^{1/6}}{C} \quad (2-18)$$

and the procedures described for equation 2-6 or 2-7. A review of energy loss computation using the Manning equation 2-16 modified to account for relative roughness by equations 2-6 or 2-7 and 2-17 or 2-18 will show that, if the effect of relative roughness is required, the Darcy-Weisbach or the Chezy method provides a more direct and simpler procedure.

e. Roughness Values. Values of effective roughness k normally are based on prototype measurements of flow over various boundary materials rather than physically measured values. Essentially all hydraulic textbooks provide extensive data of Chezy's C and Manning's n values; however, data are somewhat limited on effective roughness values k . Some suggested roughness values for various spillway surfaces are provided in the following tabulation:

Surface	Effective Roughness k , feet
Concrete	
For discharge design	0.007
For velocity design	0.002
Excavated rock	
Smooth and uniform	0.025-0.25
Jagged and irregular	0.15 -0.55
Natural vegetation	
Short grass	0.025-0.15
Long grass	0.10 -0.55
Scattered brush and weeds	0.15 -1.0

Due to the inability to predict the roughness that will be constructed, the designer should use maximum values in computing flow profiles and minimum values in computing energy losses required for terminal structure design.

2-11. Turbulent Boundary Layer Development Energy Loss. The surface roughness energy loss associated with free flow (ungated) on an overflow crest spillway with a P/H_d ratio greater than one is dependent upon the development of the turbulent boundary layer thickness. Boundary layer development is important to the designer because the principles of energy loss based upon the methods appropriate for fully turbulent flow are not valid until the boundary layer is fully developed. However, the use of the following procedure is dependent upon the spillway flow approach conditions conforming to the following assumptions:

a. The flow approaching the spillway must have potential flow velocity distribution (constant velocity throughout the flow depth).

b. The flow depth is large so that the depth of approach flow can be considered constant.

C. No restrictions exist at the spillway entrance that would cause an abrupt disturbance of the water and velocity distribution.

The turbulent boundary layer thickness δ (all values in feet) is a function of the length, L , along the spillway from the start of the crest curve and the effective roughness, k , described as

$$\frac{\delta}{L} = 0.08 \left(\frac{L}{k} \right)^{-0.233} \quad (2.19)$$

The decrease in energy flux in the turbulent boundary layer caused by friction is by definition the energy thickness δ_3 . The decrease in the volume of flow in the boundary layer caused by friction is by definition the displacement thickness δ_1 . Based on experimental data the relationship between the displacement thickness δ_1 , the energy thickness δ_3 , and the turbulent boundary layer thickness is:

$$\delta_1 = 0.18\delta \quad (2-20)$$

$$\delta_3 = 0.22\delta \quad (2-21)$$

The potential flow velocity at any location T investigated on the spillway is determined from equation 2-22, using a trial procedure

$$h_T = d_p \cos \theta + \frac{u^2}{2g} \quad (2-22)$$

where

h_T = reservoir elevation minus spillway elevation at location T , feet
 d_p = potential flow depth at location T , feet
 θ = interior angle between spillway face at location T and horizontal, degrees
 u = potential flow velocity, ft/sec

The spillway energy loss, H_L , in terms of feet of head, is defined by the following equation:

$$H_L = \frac{\delta_3 u^3}{2gq} \quad (2-23)$$

where q is the unit discharge in cubic feet per second per foot ($\text{ft}^3/\text{sec}/\text{ft}$). The actual depth of flow, d , at the location under investigation is equal to the potential flow depth determined from equation 2-23 plus the displacement thickness from equation 2-20.

$$d = d_p + \delta_1 \quad (2-24)$$

The critical point is defined as the location where the turbulent boundary layer intersects the free surface flow, which is the location where the

turbulent boundary layer thickness becomes equal to the actual flow depth. Downstream from the critical point, energy loss computations are based on fully turbulent flow, as discussed in paragraph 2-10, are appropriate. Reference is made to HDC Sheets and Charts 111-18 to 111-18/5 for additional information on procedures involved in determination of boundary layer development energy loss.

Section V. Hydraulic Jump Energy Dissipator

2-12. General.

a. Types of Energy Dissipators. Spillway energy dissipators are required to operate safely and effectively throughout a wide range of discharges, for extended periods of time, without having to shut down for emergency repairs. Energy dissipators normally used at CE dams are the hydraulic jump stilling basin, the roller bucket, and the flip bucket. Discussion on the selection and merits of each of these dissipators is presented in Chapter 7.

b. Unit Horsepower. When designing an energy dissipator, the horsepower per foot of width entering the dissipator should be determined. Unit horsepower, which provides an index of the severity of the entering energy conditions, can be expressed as

$$h_p = \frac{q\gamma(d_1 + h_e)}{550} \quad (2-25)$$

where

- q = discharge per unit width of spillway, ft³/sec/ft
- γ = unit weight of water, lb/ft³
- d₁ = depth of flow at entrance to dissipator, feet
- h_e = velocity head = V₁²/2g where V₁ = mean velocity of flow at entrance to dissipator, ft/sec

Plate 2-2 depicts the unit horsepower for a number of existing large spillways. This plate is presented to permit the designer to investigate operating experience with energy dissipators subjected to unit horsepower of a magnitude comparable to the projected design.

2-13. Hydraulic Jump Type Energy Dissipator. The hydraulic jump energy dissipator, defined as a stilling basin, is used to dissipate kinetic energy by the formation of a hydraulic jump. The hydraulic jump involves the principle of conservation of momentum. This principle states that the pressure plus momentum of the entering flow must equal the pressure plus momentum of the exiting flow plus the sum of the applied external forces in the basin. The hydraulic jump will form when the entering Froude number F₁, the entering flow depth d₁, and the sequent flow depth d₂ satisfy the following equation:

$$\frac{d_2}{d_1} = 0.5 \left[\left(1 + 8F_1^2 \right)^{1/2} - 1 \right] \quad (2-26)$$

where

$$F_1 = \frac{v_1}{(gd_1)^{1/2}} \quad (2-27)$$

The energy losses within the basin and the forms of a hydraulic jump are dependent upon the entering Froude number. With Froude numbers F_1 less than 4.0, the jump is somewhat inefficient in energy dissipation and is hydraulically unstable. The entering flow oscillates between the bottom of the basin and the water surface, resulting in irregular period waves which will propagate downstream. EM 1110-2-1605 presents a discussion on the design of hydraulic jump stilling basins with entering Froude numbers less than 4.0. A well-stabilized and efficient jump will occur with Froude numbers F between 4.5 and 9.0. Jumps with Froude numbers F_1 greater than 9.0 are highly efficient in energy dissipation; however, a rough surface will exist that will propagate waves downstream. The energy loss **ΔE resulting in a hydraulic jump** is equal to the difference in specific energies before, E_1 , and after, E_2 , the jump which can be estimated by the following equation:

$$\Delta E = E_1 - E_2 = \frac{(d_2 - d_1)^3}{4d_1 d_2} \quad (2-28)$$

The length L_j of a hydraulic jump on a flat floor without baffles, end sill, or runout slope (not necessarily the stilling basin length) can be estimated by the following equations:

$$L_j = 8.0d_1F_1 \quad \text{for } F_1 > 5 \quad (2-29a)$$

$$L_j = 3.5d_1F_1^{1.5} \quad \text{for } 2 < F_1 < 5 \quad (2-29b)$$

The presence of baffles and/or end sills in the basin will shorten the jump length and reduce the d_2 depth required to produce the jump. The analysis of a hydraulic jump can be accomplished using the principle of conservation of momentum which requires that the rate of change of momentum entering and leaving the jump be equal to the summation of forces acting upon the fluid. The forces include the hydrostatic pressure force at each end of the jump which is expressed as

$$P_1 = \frac{\gamma d_1^2}{2} \quad (2-30)$$

$$P_3 = \frac{\gamma d_3^2}{2} \quad (2-31)$$

the force exerted by the baffles, expressed as

$$P_B = C_D \rho \left(\frac{V_B^2 h}{2} \right) \quad (2-32)$$

and the force exerted by the face of the end sill which is expressed as:

$$P_S = \gamma h_s \left(d_3 + \frac{h_s}{2} \right) \quad (2-33)$$

where

- p_1 = hydrostatic pressure of the entering flow, lb/ft
- p_3 = hydrostatic pressure of the exiting flow, lb/ft
- d_3 = depth of flow above the end sill, feet
- p_B = force exerted by the baffles, lb/ft
- C_D = baffle drag coefficient
- ρ = mass density of water pounds-seconds squared per feet to the fourth power (lb-sec²/ft⁴)
- V_B = average velocity at face of the baffle, ft/sec
- h = height of the baffle, feet
- p_S = force exerted by the end sill, lb/ft
- h_s = height of end sill, feet

Equation 2-33 assumes hydrostatic pressure distribution on the end sill. This assumption is considered valid unless the baffle piers are located too near the sill, resulting in a reduced pressure on the face of the end sill. The pressure reduction would require a theoretical increase in the downstream depth to provide the necessary force for jump stabilization. A friction force also exists along the basin wetted perimeter but is small enough to be neglected. Therefore, assuming two-dimensional flow, the momentum equation for a hydraulic jump which includes baffle piers and an end sill can be expressed as

$$\rho q V_1 - \rho q V_3 = P_3 - P_1 + P_B + P_S \quad (2-34)$$

where V_3 is the mean velocity at exit of dissipator or restated as

$$\gamma \left(\frac{q^2}{g d_1} - \frac{q^2}{g d_3} \right) = \gamma \left(\frac{d_3^2}{2} - \frac{d_1^2}{2} \right) + C_D \rho \left(\frac{V_B^2 h}{2} \right) + \gamma h_s \left(d_3 + \frac{h_s}{2} \right) \quad (2-35)$$

Solution of this equation for the required depth d_3 can be accomplished by successive trials for any specific baffle pier and end sill arrangement provided information is available to evaluate the baffle force. The baffle force is dependent upon the drag coefficient corresponding to the type of baffle

used and the velocity in the vicinity of the baffle. The appropriate velocity can be estimated from Plate 2-3, which shows the distribution of velocity in a hydraulic jump. The baffle drag coefficient is a function of baffle shape and spacing. Limited information available on baffle drag coefficients indicates that the following values should be reasonable: 0.6 for a single row of baffles and 0.4 for a double row. Further discussion on baffles and end sills is found in Chapter 7.

2-14. Sidewall Dynamic Load. The turbulence created by the hydraulic jump imposes forces on the stilling basin sidewalls. The magnitude of the dynamic load is important in the structural design of the walls. Tests to determine sidewall forces were conducted at WES with an instrumented sidewall in a stilling basin that did not contain baffles or an end sill (item 19). These tests were conducted with Froude numbers F_1 that varied between 2.7 and 8.7, and resulted in the development of the following empirical equation:

$$R_m = 3.75H_s^{-1.05} \rho V_1 q F_1^{-1.42} \quad (2.36)$$

where

R_m = average minimum static plus dynamic unit force at the toe of the hydraulic jump, lb/ft
 H_s = spillway height, crest elevation minus stilling basin apron elevation, feet

The magnitude of the unit force on the sidewall varies along the length of the stilling basin. Plate 2-4 defines the variation in unit force by use of the normalizing functions, described by equations 2-37 through 2-39, versus the distance ratio x/L_b .

$$\frac{R - R_m}{R_s - R_m} = C \quad (2-37)$$

$$\frac{(R_+) - R_m}{R_s - R_m} = C_+ \quad (2-38)$$

$$\frac{(R_-) - R_m}{R_s - R_m} = C_- \quad (2-39)$$

where

x = distance measured from the point of intersection of the spillway slope and the basin apron to the center line of the wall unit being analyzed
 L_b = length of the stilling basin, feet
 R, R_+, R_- = average unit resultant force, maximum instantaneous unit resultant force, and minimum instantaneous unit resultant force, respectively, acting on the sidewall when the actual

16 Jan 90

depth of tailwater d_{TW} is less than or equal to d_2 or the basin wall height, lb/ft

R_s = static unit force on the sidewall unit due to the theoretical sequent depth for a hydraulic jump, lb/ft

When $d_{TW} > d_2$, R , R_+ , and R_- must be adjusted as shown by equation 2-40 through 2-42 to account for the increased force resulting from the difference between d_{TW} and d_2 :

$$R_a = R + \frac{\gamma}{2} (d_{TW}^2 - d_2^2) \quad (2-40)$$

$$R_{a+} = R_+ + \frac{\gamma}{2} (d_{TW}^2 - d_2^2) \quad (2-41)$$

$$R_{a-} = R_- + \frac{\gamma}{2} (d_{TW}^2 - d_2^2) \quad (2-42)$$

where R_a , R_{a+} , and R_{a-} are the adjusted average unit resultant force, the adjusted maximum instantaneous unit resultant force, and the adjusted minimum unit resultant force, respectively. The distance above the stilling basin apron, Y , to the resultant of the unit force acting on the basin wall is determined by the use of Plate 2-5, which defines the relationship between Y/d_{TW} and X/L_b . Appendix E includes an example problem illustrating the recommended application for estimating the magnitude and locations of the resultant dynamic forces acting on a stilling basin sidewall.

Section VI. Cavitation

2-15. General. Cavitation is defined as the formation of a gas and water vapor phase within a liquid resulting from excessively low localized pressures. When associated with the design of spillways, cavitation is important because the vaporization occurs on or near the nonfluid boundary (spillway surface) resulting from localized boundary shape conditions. Cavitation damage results when the gas and water vapor-filled void is swept from the low-pressure zone into an adjacent higher pressure zone which will not support cavitation, causing the void to collapse. The collapse of the void results in extremely high pressures, and when they occur at or near the nonfluid boundary, will form a small pit. When given sufficient time, numerous void collapses result in numerous small pits which eventually overlap, leading to larger holes. This damage, in turn, aggravates the localized low-pressure zone, thereby creating a self-breeding continuation of the damage. The existence and extent of cavitation damage are dependent upon the boundary shape, the damage resistance characteristics of the boundary, the flow velocity, the flow depth, the elevation of the structure above sea level, and the length of time the cavitation occurs. Cavitation damage can be detected at one or more locations in essentially all high-velocity flow structures; however, and fortunately, most damage is minor and results from cavitation conditions at or very near the incipient damage level. When incipient levels are exceeded,

serious damage will occur. At Libby Dam, a construction-related misalignment of the parabolic-shaped invert of the open channel flow sluices resulted in cavitation damage that removed concrete and reinforcing steel throughout an area 54 feet in length, up to 7 feet wide, and up to 2.5 feet deep on both the floor and the right wall (item 47). At Hoover, Yellowtail, and Glen Canyon Dams, severe cavitation damage occurred in tunnel spillways near the tangent point of the vertical curve which decreases the slope of the spillway. The spillways at these dams are tunnel-type structures which were operating at open channel flow conditions with average flow velocities in excess of 100 ft/sec when the damage occurred. Similar flow conditions can exist on a spillway chute. Damage to concrete surfaces can occur at velocities significantly less than 100 ft/sec provided the correct combination of cavitation parameters exists. As a rule of thumb, cavitation should be investigated whenever flow velocities are in excess of 35 ft/sec.

2-16. Cavitation Damage. The damage potential resulting from cavitation is dependent upon the boundary shape, the damage resistance characteristics of the boundary, the flow velocity and depth, the elevation of the structure above mean sea level, and the length of time cavitation occurs. The boundary shape, velocity, and elevation are related by the cavitation index, σ , which is derived from the energy equation:

$$\frac{v_0^2}{2g} + \frac{P_0}{\gamma} + z_0 = \frac{v_1^2}{2g} + \frac{P_1}{\gamma} + z_1 \quad (2-43)$$

where P is the absolute pressure, lb/ft². With $H = P/\gamma$ the comparable equation is

$$\frac{H_1 - H_0}{\frac{v_0^2}{2g}} = 1 - \left(\frac{v_1}{v_0}\right)^2 + \frac{z_0 - z_1}{\frac{v_0^2}{2g}} \quad (2-44)$$

For high velocities the elevation term in equation 2-44 can be ignored. The dimensionless parameter on the left side of the equation is known as the pressure parameter. Replacing H_1 with the absolute head required for vaporization of water at the elevation of the structure above sea level and rearranging terms in order that σ will be positive, the flow cavitation index is

$$\sigma = \frac{H_0 - H_v}{\frac{v_0^2}{2g}} \quad (2-45)$$

where

H_0 = reference head, feet
 H_v = vapor head of water, feet

Various investigators have experimentally determined the σ -incipient

cavitation relationship for a number of specific boundary shapes. These experimentally derived data have been reduced to curves describing the incipient cavitation level for specific boundary shapes (Plates 2-6 through 2-9). Cavitation damage can be expected if a specific u-boundary shape relationship can be plotted on or to the right side of the curve. When this condition is evident, **a design change must be made that either increases the σ value, smoothes the boundary shape, or both. As σ decreases below the incipient cavitation level, the cavitation damage potential increases very rapidly.** Investigations (item 14) have found that the cavitation energy absorbed by the nonfluid boundary increases by the eleventh power of the velocity.

2-17. Cavitation Damage Prevention. Cavitation-induced damage can be prevented by a number of methods. As shown in paragraph 2-16, damage can be prevented by increasing the cavitation index and/or by providing a smoother boundary shape. However, changes of this type are usually impractical or at best difficult to accomplish due to the physical limitations imposed by the required design and construction practices. Changing the damage resistance characteristics of the boundary will inhibit the damage produced over a finite period of time. As an example, structural concrete exposed to cavitation resulting from a flow velocity of 98 ft/sec for 3 hours resulted in a hole 0.5 inch deep. Under the same conditions with polymerized concrete, the same size hole resulted after 6,000 hours. The use of hardened boundaries also has physical limitations, and results only in resisting the cavitation forces for a given period of time. A relatively new and very effective method of preventing cavitation-induced damage is to disperse a quantity of air along the flow boundary. This is achieved by passing the water over an aeration slot specially designed to entrain air along the boundary. This method has been used to prevent cavitation damage at various high-velocity flow facilities including Libby Dam sluices (item 46). Prototype tests of boundary pressures were obtained at identical locations and hydraulic conditions for pre- and post-boundary aeration. These tests showed that aeration of the boundary resulted in raising instantaneous pressures that were very close to absolute zero to pressures near atmospheric. Data collected from these tests were used to derive the cavitation index. The post-boundary aeration cavitation index showed an average increase of about 50 percent above the preaeration condition. The aeration slot geometry and location must be designed for the specific application. Some design guidance has been developed (item 13) to assist in aeration slot design and should be used to develop an initial design. Until significantly more experience, data, and design guidance are developed, model studies of aeration slot design are recommended.

CHAPTER 3

SPILLWAY CREST

Section I. Introduction

3-1. General.

a. All spillways discussed in this manual require a spillway crest design. The crest and/or gates located near the crest provide the flow control through the spillway system. The capacity of the spillway is dependent upon the crest shape, crest length, and the hydraulic head. The hydraulic head is modified by approach conditions, pier and/or abutment effects, and submergence. The basic purpose of a spillway is to convey large floods through a project without incurring unacceptable damage either upstream or downstream from the spillway. The spillway design is accomplished in a manner that will minimize cost subject to providing:

- (1) Sufficient crest length to convey the design discharge.
- (2) Acceptable minimum pressures acting on the crest boundary.
- (3) Acceptable maximum energy head on the spillway crest.
- (4) Acceptable velocities and flow characteristics through the spillway system.
- (5) Acceptable environmental and aesthetic conditions.

b. Engineering-economic investigations will usually show that a narrow spillway with high unit discharge is more economical than a wide spillway with moderate unit discharge. Thus, the most economic design will produce a spillway that includes a large energy head on the crest, a moderate design head, and a large unit discharge. Higher head spillways can create excessive abutment and pier contractions, cause energy dissipation problems, increase the possibilities of cavitation or pulsating nappe on the spillway crest, and create poor flow characteristics through the spillway system. The demand placed on the designer for economical designs requires the use of high head, high-efficiency spillways which, in turn, requires a sound design methodology. The objective of this chapter is to assist in providing this methodology.

Section II. Crest Characteristics

3-2. General. To provide a high-efficiency spillway and yet produce a safe, low-maintenance structure, the crest shape must provide a high discharge coefficient and fairly uniform and predictable pressures on the crest boundary. These constraints can best be met if the shape of the overflow spillway closely approximates that of a fully ventilated nappe of water flowing over a sharp-crested weir. The shape of the nappe is affected by the relative head on the weir, the approach depth and velocity, and the upstream slope of the weir. Experimental data gathered throughout a suitable range of these variables have led to the development of a spillway design methodology. The

earliest attempts at fitting equations to lower nappe surfaces utilized the data of Bazin (item 6). Data developed by the US Bureau of Reclamation (USBR) (item 76) have served as a basis for most CE crest design procedures. Recent spillway investigations at WES (items 28, 32, and 33) have added considerably to the USBR data.

3-3. Crest Shape.

a. The complete shape of the lower nappe, which is also the spillway crest surface, is described by separating it into two quadrants upstream and downstream from the high point (apex) of the lower nappe. The apex is normally defined as the crest axis. The spillway crest shape is proportionally based on the design head H_d (see Chapter 2, Section II, for detailed definition of symbols used. The energy head H can be greater than, equal to, or less than H_d . The equation for the downstream quadrant of the crest for all spillways can be expressed as

$$X^n = KH_d^{n-1} Y \quad (3-1)$$

where

- x = horizontal coordinate positive to the right, feet
- n = variable, however usually set equal to 1.85
- K = variable dependent upon P/H_d
- Y - vertical coordinate positive downward, feet

Equation 3-1 can be used to define the downstream crest shape for any P/H_d ratio by a systematic variation of K from 2.0 for a deep approach to 2.2 for a very shallow approach. See Plates 3-1 and 3-2.

b. Difficulties existed when a single equation was fit to the upstream quadrant. The efficiency of the spillway is highly dependent on the curvature of the crest immediately upstream of the crest axis (items 32 and 51). A sudden change in curvature or a discontinuity not only disrupts the boundary layer but can also lead to flow separation and cavitation. Murphy (item 33) reported a three percent increase in the discharge coefficient when a small discontinuity between the upstream face and upstream quadrant was removed.

c. A general design procedure was advanced by Murphy (item 33) by which a sloping face spillway and a vertical face spillway can be designed in the same manner. For the upstream quadrant Murphy found that, by systematically varying the axes of an ellipse with depth of approach, he could closely approximate the lower nappe surfaces generated by USBR. Furthermore, any sloping upstream face could be used with little loss of accuracy if the slope became tangent to the ellipse calculated for a vertical upstream face.

d. The equation of the upstream elliptical shape is expressed as

$$\frac{X^2}{A^2} + \frac{(B - Y)^2}{B^2} = 1 \quad (3-2)$$

where

x = horizontal coordinate origin at crest axis positive to the right
 A = one-half horizontal axis of ellipse, feet
 B = one-half vertical axis of ellipse, feet
 Y = vertical coordinate origin at the crest axis positive downward

These three parameters (A, B, and K) then fully define the crest shape. Their variation with relative approach depth is given in Plate 3-2. This plate also includes a definition sketch.

3-4. Crest Discharge Coefficient. Discharge over a spillway crest is classified as either free flow or submerged flow. Free flow implies that the value of the discharge coefficient is not influenced by conditions downstream from the crest. Submerged flow occurs either when the tailwater is sufficiently high that a reduction in the discharge coefficient occurs, or when there is a change in the crest profile so close to the crest axis that the full benefits of the crest shape cannot be obtained. Flow over a spillway is governed by the relationship

$$Q = CL_e H_e^{1.5} \quad (3-3)$$

where Q is the rate of discharge and C is the discharge coefficient which is a measure of the efficiency of the spillway system. The discharge coefficient is a variable dependent upon generalized and site-specific factors. The factors which have been accounted for in generalized laboratory studies are the effect of relative approach depth P/H_d , the slope of the upstream face, the relative head on the crest H_e/H_d , crest submergence, and selected crest and abutment shapes. Site-specific factors such as flow angularity resulting from complex approach flow geometry or unusually shaped piers, for example, can be significant and must be investigated by a site-specific model study.

a. Free Discharge. Laboratory studies accomplished at WES (items 28 and 33) have defined spillway coefficients for free flow over a wide range of the following generalized factors: upstream slope, P/H_d , and H_e/H_d . **Discharge coefficients reflecting these factors are given in Plates 3-3 and 3-4.** Due to possible scale effects, discharges were not measured below $H_e/H_d = 0.4$. However, prototype experience has shown that spillway crests at very low heads exhibit the same discharge characteristics as a broad-crested weir. Therefore, for extrapolation purposes, the discharge coefficient should be equal to 3.08 as H_e/H_d approaches zero. As the P/H_d values decrease, and particularly for higher values of H_e/H_d , control of the flow begins to shift upstream, efficiency is lost, the discharge coefficient decreases, and the value of C again approaches that of a broad-crested weir (in this case a free overfall). Also to be noted is the characteristic increase in discharge coefficient for heads greater than design head. This is the concept of underdesigning the spillway crest to obtain greater efficiency. Underdesigning does not result in increased discharge coefficients with $P/H_d < 0.5$. The limitations of underdesigning the crest are dependent on the extent of negative pressure developed on the spillway crest. See Section IV, Crest Pressures, of this chapter.

b. Submerged Discharge. Submerged flow resulting from either excessive tailwater or changes in the crest profile will effectively reduce the free crest discharge coefficient. The reduction in the coefficient is dependent upon the degree of submergence. Due to the variance in the discharge coefficient, the effect of submergence cannot be described by a single relationship over the full range of the dependent variable. HDC 111-4 provides a discussion on tailwater submergency and provides a chart which defines a percent decrease in the unsubmerged crest coefficient for a full range of submergence. This chart is reproduced as Plate 3-5 for convenience. The curves shown on Plate 3-5 were based on three different test conditions: the approach and apron floors at the same constant elevation; both floors at the same elevation but varied with respect to the crest elevation; and the approach floor elevation held constant and the apron elevation varied. The percent decrease in the discharge coefficient was based on the unsubmerged discharge coefficient for each condition tested. EM 1110-2-1605 provides additional information on the effect of tailwater submergence on broad-crested spillways that are often used in conjunction with navigation dams. The reduction in the discharge coefficient resulting from crest geometry submergence is not as well defined as that for tailwater submergence. Abecasis (item 1) has accomplished some experiments that show when the chute tangent intersects the crest curve close to crest, a reduction in the discharge coefficient of two to eight percent will occur. The amount of reduction is dependent upon the location of the point of tangent intersection and the crest. When designs of this type are used and the discharge coefficient is critical, model studies will be necessary to verify the design.

Section III. Spillway Piers, Abutments, and Approach

3-5. General. Crest piers, abutments, and approach configurations of a variety of shapes and sizes have been used in conjunction with spillways. All of the variations in design were apparently used for good reasons. Not all of the designs have produced the intended results. Improper designs have led to cavitation damage, drastic reduction in the discharge capacity, unacceptable waves in the spillway chute, and harmonic surges in the spillway bays upstream from the gates. Maintaining the high efficiency of a spillway requires careful design of the spillway crest, the approach configuration, and the piers and abutments. For this reason, when design considerations require departure from established design data, model studies of the spillway system should be accomplished.

3-6. Contraction Coefficients. Crest piers and abutments effectively reduce the rate of discharge over the crest. The reduction in discharge is determined by the use of a contraction coefficient which, when applied in equation 2-2, defines the effective length of spillway crest. Conversely, additional crest length must be provided to offset the crest length reduction resulting from piers and abutments. Pier contraction coefficients have been determined from generalized model studies. Plate 3-6 shows plots of these contraction coefficients for five different pier nose shapes having the pier nose located in the same vertical plane as the spillway face and with $P/H_p > 1$. Plate 3-7 shows a plot of the contraction coefficient for a truncated elliptical pier nose that includes a bulkhead slot. This pier nose shape has been used on a number of the Columbia and Snake River projects. The

contraction coefficients for the type 2 pier nose with piers extending upstream from the spillway face and $P/H_d > 1$ are shown in Plate 3-8. The contraction coefficients for $P/H_d < 1$ for the type 2 pier nose are shown in Plate 3-9. The contraction coefficients for the type 3 pier with an elliptical-shaped upstream crest with vertical or 1:1 upstream spillway slope and various P/H_d ratios are shown in Plate 3-10. The contraction coefficients for the variety of shapes and conditions show significant variation throughout a range of -0.075 to 0.10, thus the reason for careful consideration of the pier shape. Although some of these pier contraction coefficients show an increase in the efficiency of the spillway, it may be at the expense of lower pressures on the crest or undesirable flow conditions in the chute. As an example, the type 4 pier shown in Plate 3-6 provides increased efficiency throughout a wide range of H_e/H_d ; however, the flow conditions in the chute may be undesirable. Abutment contraction coefficients are not as available, as abutments are somewhat more site-specific. Plates 3-11 and 3-12 provide some basic information pertinent to abutments with adjacent concrete or embankment sections. (See paragraph 3-8 for additional information on abutment effects.)

3-7. Spillway Bay Surge. Surging of the water surface upstream from tainter gates has been observed during model studies of gated spillway crests on both high and low spillway crest. Model measurements indicate that water surface fluctuations as great as 10 feet with periods less than 10 seconds would occur in alternate bays of the prototype for certain combinations of gate bay width, w_b ; gate opening, G_o ; pier length, P_L defined as the distance from the upstream-most point of the gate face to the pier nose; and head on the crest, n_e . Model studies have shown that decreasing P_L , increasing w_b , or both, will effectively eliminate periodic surge. Excessive surging can be prevented by applying the following guidelines on spillway pier and gate bay design:

- a. Low head spillways, $P/H_d < 1$

$$w_b \geq 1.1H_c \quad \text{for } P_L < 0.3w_b$$

or

$$w_b \geq 1.25H_c \quad \text{for } 0.3w_b < P_L < 0.4w_b$$

- b. High head spillways, $P/H_d > 1$

$$w_b \geq 0.8H_c \quad \text{for } P_L < 0.3w_b$$

or

$$w_b \geq 1.2H_c \quad \text{for } 0.3 < P_L < 0.4w_b$$

where H_c is the maximum head on the crest where the gate controls the discharge. The maximum gate opening for which tainter gates will control the discharge should be taken as 0.625 times the head on the weir crest. By utilizing the spillway discharge curves for various gate openings, the maximum head on the weir crest for which the gates will control the discharge can be

16 Jan 90

determined. These guidelines apply to all gated spillways regardless of the gate size. Due to the limited model tests used to develop the guidelines, model tests should be considered on those spillways which would operate with $G_o > 20$ feet and $H_e > 40$ feet. Conditions may dictate a design that is within the above limits, such as the increase in dam height which occurred at Chief Joseph Dam. At this project the model studies showed approximately five feet of surge alternating across the 19-bay spillway. Changing the dimensions of W_b or P_L was constrained by the existing structure so model studies were undertaken to evaluate surge suppressor designs. A simple design of two triangular concrete protrusions on the side of the pier upstream from the gate reduced the surge to well within acceptable limits without reducing the discharge characteristics of the spillway. See item 56 for detailed information.

3-8. Spillway Approach. Spillway approach configuration will influence the abutment contraction coefficient, the nappe profile, and possibly the flow characteristics throughout the spillway chute and stilling basin. There are three general configurations for the spillway approach, each of which requires a different treatment at the abutments in order to provide acceptable spillway characteristics.

a. Deep Approach. First, there is the high spillway where approach velocities are negligible. This condition usually exists at a spillway in the main river channel flanked by concrete nonoverflow sections. The P/H_d ratio for a deep approach spillway is defined as being greater than 1.0. The shape of the abutment adjoining concrete sections of a high head dam is a major factor influencing the abutment contraction coefficient. For this type of structure, the extension of the abutment upstream from the dam face to develop a larger abutment radius has provided improved flow characteristics in the end bays of the spillway (item 41). The abutment contraction coefficient curve shown in Plate 3-11 is applicable to this type of approach condition.

b. Shallow Approach. Second, there is the broad but relatively shallow approach that results in strong lateral currents at the abutments. This condition frequently is found at spillways in the river valley flanked by embankment sections. The P/H_d ratio for the shallow approach spillway is defined as being equal to or less than 1.0. When a spillway includes adjacent embankment sections, and particularly where approach velocities are appreciable, the configuration of the abutments and adjoining topography, the depth of approach flow, and the angularity of approach flow have significant influence on abutment contraction coefficients and flow characteristics. The embankment should not be carried at full height to the spillway training walls. Embankment wraparounds with concrete nonoverflow sections joining the top of the embankment to the spillway training walls should be considered. Abutment pier noses should not extend upstream of the face of the nonoverflow sections as this configuration has been noted to cause surging at the abutments. Rock dikes extending into the reservoir have been used to improve flow conditions at the abutments (item 66); however, optimum configurations are essential and can be developed only in a model study. An abutment contraction coefficient curve recommended for approach depths that are at least one-half of the design head and approach flow relatively perpendicular to the spillway are provided in Plate 3-12. Abutment contraction coefficients as large as 0.75 have been

measured in model studies with very shallow approach ($P/H_d < 0.2$) and a curved approach channel (item 69).

c. Confined Approach. The third configuration results when the spillway is remote from the main dam and an excavated approach channel is required. In this type of approach, velocities may be high and flow distribution may be unequal but there will not be strong lateral currents at the abutments. When conditions require an excavated approach channel to the spillway, friction losses in the channel should be considered in determination of spillway capacity. Guidance for computing friction losses is given in Chapter 2. For confined channels the abutment contraction coefficient curve shown in Plate 3-11 may be used to account for abutment effects.

Section IV. Spillway Crest Pressures

3-9. General. Free discharge over a spillway crest designed to the shape discussed in paragraph 3-3 will develop pressures on the concrete boundary somewhat inversely proportional to the H_e/H_d ratio. When H_e/H_d is nearly one, the pressures on the crest are essentially atmospheric. As H/H_d increases, crest pressures drop below atmospheric. These negative pressures are the reason for the increase in the discharge coefficient over that of a ventilated sharp-crested weir. A reasonable approximation of the crest pressures will provide the data necessary for structural stability analysis for certain design cases. Crest pressure calculations will also provide the hydraulic design guidance on the limiting pressures that crest underdesigning yields prior to reaching pressures where cavitation damage occurs. Previous recommendations (item 77) have stated that H/H_d should not exceed 1.33 when underdesigning a spillway crest. Bauer and Beck^d (item 5) and Abecasis (item 2) have shown that the actual minimum pressure fluctuation level in relation to local atmospheric pressure is what leads to cavitation. Vacuum tank observations by Abecasis (item 1) indicated that cavitation on the crest would be incipient at an average pressure of about -25 feet. Fluctuations and duration of actual pressures at or near absolute, not the average pressure on the crest boundary, are the cause of cavitation damage. A spillway crest should be designed so that the maximum expected head will result in average pressures on the crest no lower than -15 feet of water at sea level and 40-degree Fahrenheit temperature. The -15 feet of water must be adjusted to account for elevation and water temperature at the spillway crest site. HDC 000-2 and 001-2 will provide data to assist in this adjustment. For spillways with and without piers, Plates 3-13 and 3-14, respectively, show a relationship between H_e and H_d defining the maximum limit of underdesign allowed based on the recommended^d minimum crest pressure of -15 feet of water. The curves for -25 feet and -20 feet of water are also shown on these plates for comparison.

3-10. Controlled and Uncontrolled Crests. A controlled crest is one that includes gates which are used to control the flow; the uncontrolled crest is one unencumbered by gates. Pressures on controlled and uncontrolled crests with vertical 1:1 upstream sloped faces with P/H_d values of 0.25, 0.5, and 1.0 were investigated at WES (item 28). At $P/H_d = 0.25$, pressures were measured for $H_e/H_d = 0.5$ and 1.0 only. Use of an underdesigned crest with a

16 Jan 90

P/H_d value as low as 0.25 does not result in a significant increase in the discharge coefficient above $H_e/H_d = 1.0$. WES investigations included two piers placed on a model crest. The pier nose used for all crests was the type 3 shown on Plate 3-6. The pier nose was located in the same plane as the upstream face for the vertical spillway. For the 1V:1H upstream slope, the pier nose location was determined by maintaining the same distance from pier nose to crest axis as used in the vertical upstream faced crest. See item 28 for detailed information on crest pressure distribution for various P/H_d ratio spillways, with and without a sloping upstream face, and various H_e/H_d ratios. For spillways that include piers, the minimum pressure along the pier limits the amount of underdesigning permissible. When a crest with piers is designed for negative pressures, the piers must be extended downstream beyond the negative pressure zone in order to prevent aeration of the nappe, nappe separation or undulation, and loss of the underdesign efficiency advantage. For preliminary design purposes, the approximate range of the dimensionless horizontal distance from the crest axis (X/H_d) where pressures were found to return to positive, are as follows:

H_e/H_d	X/H_d
1.17	0.1-0.4
1.33	0.7-0.9
1.5	1.1-1.5

Section V. Upper Nappe Profile

3-11. General. The upper nappe profile or the water surface profile for free flow over a spillway crest with or without piers is of acute interest in the design of sidewalls adjacent to the spillway crest, equipment bridges over the spillway crest, and spillway gate trunnion location. The nappe profile unencumbered by crest piers is somewhat different from one with piers. The upper nappe profile will also be modified by the direction of the approach flow with respect to the crest axis. Procedures to determine nappe profiles have been derived from experimental work based on specific conditions involving P/H_d and H_e/H_d ratios, spillways with and without piers, and approach flow perpendicular to the crest axis. These procedures provide a sound basis for design of nappe profile-related features. When hydraulic conditions vary somewhat from the experimental conditions, or the upper nappe profile is critical to the design, model studies to accurately determine the profile are recommended.

3-12. Nappe Profile. The design procedure used to determine the upper nappe profile is based on generalized experimental data. Upper nappe profile data for two spillway conditions are presented. The first is for high spillways with negligible approach velocities as discussed in paragraph 3-8a. The second condition is for low spillways with appreciable approach velocities as discussed in paragraphs 3-8b and c.

a. High Spillways. Plate 3-15 shows generalized data in the form of dimensionless coordinates of the upper nappe profile in terms of the design head for H_e/H_d ratios of 0.50, 1.00 and 1.33 without the influence of crest

piers. Plates 3-16 and 3-17 show the dimensionless coordinates for the same conditions with the influence of crest piers.

b. Low Spillways. Plates 3-18 through 3-20 show generalized data in the form of dimensionless coordinates of the upper nappe profile along the center line and along the edge of a crest pier in terms of the design head. These data are presented for H_e/H_d ratios of 0.05, 1.0, and 1.5 for P/H_d ratios of 1.0, 0.50, and 0.25.

CHAPTER 4

SPILLWAY CHUTE

Section I. Basic Considerations

4-1. General.

a. The chute is that portion of the spillway which connects the crest curve to the terminal structure. The term chute when used in conjunction with a spillway implies that the velocity is supercritical; thus the Froude number is greater than one. When the spillway is an integral part of a concrete gravity monolith, the chute is usually very steep. Chutes as steep as 1.0 vertical on 0.7 horizontal are not uncommon. The steepness thus minimizes the chute length. Chutes used in conjunction with embankment dams often must be long with a slope slightly steeper than the critical slope. This long, prominent structure is termed a chute spillway. The designs for long spillway chutes and steep chutes on concrete dam monoliths involve many of the same geometric and hydraulic considerations. Due to the extreme slope and short length of a steep chute, many of the hydraulic characteristics that become prominent in spillway chutes have insufficient time to develop prior to reaching the terminal structure.

b. Hydraulic characteristics that must be considered in the design of a chute are the velocity and depth of flow, air entrainment of the flow, pier and abutment waves, floor and wall pressures, cavitation indices, superelevation of the flow surface at curves, and standing waves due to the geometry of the chute. Obtaining acceptable hydraulic characteristics is dependent upon developing proper geometric conditions that include chute floor slope changes, horizontal alignment changes (curves), and sidewall convergence. This chapter presents data to assist the designer in obtaining an acceptable chute design. A model study is recommended to confirm any design that involves complex geometric considerations and/or large discharges and velocities.

4-2. Sidewalls. The height of a chute sidewall should be designed to contain the flow of the spillway design flood. The flow profile of the spillway design flood can be computed using the methods discussed in Chapters 2 and 3. The computed profile may require adjustment to account for the effects of pier end waves, slug flow or roll waves, and air entrainment. Sidewall freeboard is added above the adjusted profile; as a minimum, two feet of freeboard is recommended. A conservative, empirical freeboard criterion recommended by USBR (item 77) is as follows:

$$\text{Freeboard} = 2.0 + 0.025Vd^{1/3} \quad (4-1)$$

where V and d are the mean velocity and mean depth in feet, respectively, in the chute reach under consideration.

a. Pier End Waves. Supercritical flow expands after flowing past the downstream end of a spillway pier. The expanding flow from each side of a pier will intersect and form a disturbance which is termed a pier end wave. These waves travel laterally as they move downstream. Multiple piers will

cause the formation of a diamond pattern of waves within the chute. The impact at the intersection of the flow can be so severe that a rooster tail-like plume of water will form. A large plume was noted during the Libby Dam model studies (item 58) and was of sufficient concern to require the design of a streamlined pier end to eliminate it. Referring to Figure 4-1, the location on the sidewall where the wave from the first pier intersects the wall can be estimated by the equation:

$$z = \frac{x}{\tan \left[\sin^{-1} \frac{(gy)^{1/2}}{v_s} \right]} \quad (4-2)$$

where

- z = distance from downstream end of pier to wave and wall intersection, feet
- x = distance from first pier to the wall
- y = depth of flow
- v_s = surface velocity of flow, ft/sec

Equation 4-2 is qualified by the following conditions: The wave height at the end of the pier should be relatively small compared to the depth of flow and the velocity should be taken as the surface velocity which can be approximated by twice the average velocity. Flow disturbances from pier ends should be contained within the chute. The magnitude of the pier end wave height is difficult to determine without a model study. For a design without the benefit of a model study, an additional 25 percent of the depth of flow should be included in the sidewall height to account for pier end waves.

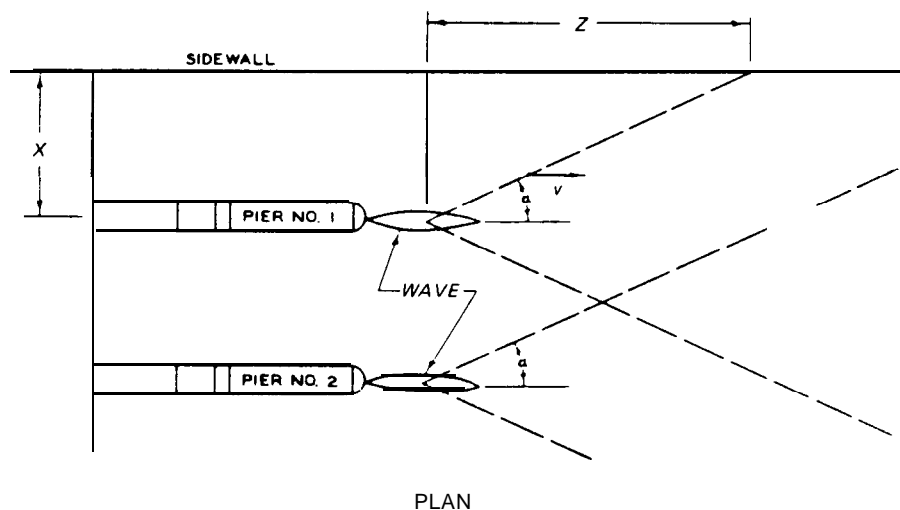

Figure 4-1. Pier end waves downstream of spillway piers

b. Slug Flow. Slug flow or roll waves may form in long chutes and should be considered in sidewall height determinations. Observations of

existing chutes indicate that these waves can reach a maximum height of approximately five percent above the mean depth. Knowledge of this type of instability is limited; therefore, further study of the phenomenon in the prototype is suggested when the condition is known to exist.

c. Air Entrainment. When air is entrained in supercritical flow, there is an increase in volume, sometimes called bulking, which will result in a greater depth of flow. This effect is noticeable in flow with Froude numbers greater than 1.5. Air entrainment must be considered in the design of chute sidewalls, bridges, or other features dependent upon the water surface profile. EM 1110-2-1601, provides the designer with a basis for increasing the flow depth due to bulking. Plate 4-1, reprinted from EM 1110-2-1601, defines the ratio of flow depth with and without air to the Froude number.

4-3. Convergent and Divergent Chutes.

a. Convergent Chute. Laboratory and field evaluation by Cox (item 11) has resulted in design criteria and guidance applicable to spillway chutes having convergence affected by horizontal curves of long radii. Optimum chute flow conditions prevail when the following criteria are satisfied, and a design that meets these criteria should perform adequately. The design flow Froude number should gradually increase continuously throughout the convergence. Optimum flow conditions occur with a crest formed by the break in invert grade or by a low sill formed as an integral part of the chute slope. However, for structural or economic reasons, the use of a spillway crest with a toe curve may be required, and less favorable flow conditions in the chute will result. Curving the chute crest in the form of a horizontal arc is noted not to appreciably affect flow conditions in the converging chute. Straight-lined converging walls in the vicinity of the crest are desirable to effect the initial convergence of the flow. Parallel walls in this vicinity should be avoided. The straight-lined walls should extend upstream beyond the crest into the subcritical flow area. These straight-lined walls should not extend downstream beyond the point where the Froude number exceeds 1.5. **Straight-lined walls should have a convergence factor of $\Delta L/\Delta W \geq 5.0$, where ΔL is the change in center-line length and ΔW is the change in width for center-line length increment ΔL .** Chute walls curved horizontally with long radii should be used when the local Froude number exceeds 1.5. These curved walls should be designed so that the convergence factor down the chute complies with the relationship:

$$\frac{\Sigma \Delta L}{\Sigma \Delta W} \geq \frac{1}{0.382 - 0.116F} \quad (4-3)$$

where

$\Sigma \Delta L$ = center-line station distance from the intersection of the crest axis and sidewall

$\Sigma \Delta W$ = accumulated sidewall convergence beginning at the intersection of the sidewall with the spillway crest

F = local design flow Froude number at the station $\Sigma \Delta L$ for the design flow

16 Jan 90

The minimum recommended design value of $\Sigma\Delta L/\Sigma\Delta W$ is 5.0. When the Froude number exceeds approximately 3.25, parallel walls are considered necessary. Vertical chute walls in the converging section are preferable to sloping walls due to the adverse effects sloping walls have on the local Froude number. When sloping walls are used, these walls should be sloped normal to the chute invert slope rather than normal to the horizontal. Hydraulic model studies are usually conducted to verify the design of a convergent chute spillway.

b. Divergent Chute. When site or economic conditions indicate that a short crest length and a widened terminal structure are desirable, diverging chute walls will be required. Model studies conducted by USBR (item 77) provide examples of designs required for chute type of spillways. USBR uses a **straight crest and recommends a maximum sidewall flare angle, α , of**

$$\tan \alpha = \frac{1}{3F_1} \quad (4-4)$$

where F_1 is the average Froude number of the flow at the location in the reach where the flare originates.

Section II. Chute Spillways

4-4. General. Chute spillways are normally designed to minimize excavation. This is accomplished by setting the invert profile to approximate the profile of the natural ground. Profile changes in both the vertical and horizontal alignment may be involved when obtaining a minimum excavation design. The chute spillway is essentially a high-velocity channel, the design of which is discussed in detail in EM 1110-2-1601. The primary concerns for the design of the chute spillway are to provide an invert slope that will ensure supercritical flow throughout the chute for all discharges, and to provide a design of piers, abutments, and sidewall transitions and bends that will minimize wave disturbances.

4-5. Invert and Water Surface Profile. Flow characteristics near critical depth are unstable, and excessive wave action or undulations of the water surface can occur. To avoid these instabilities, supercritical flow depth less than 0.9 of the critical depth or a Froude number greater than 1.13 is necessary. Computations of depth, velocity, and Froude number should consider the boundary layer development over the crest and downstream to the critical point where fully turbulent flow is developed. The remainder of the chute should be analyzed by an open channel flow method for determining energy loss for fully turbulent flow. A relatively large roughness value should be used for the determination of flow stability and water surface profiles. To assess flow stability for all operating conditions, velocity and depth computations for the full range of discharge are suggested. A second analysis of velocity and depth throughout the chute should be undertaken with a relatively small roughness value. The data derived from the second set of analyses are for consideration in the design of the sidewall alignment, sidewall height, and terminal structure design.

4-6. Invert Pressure. Details of the chute floor slabs deserve careful attention in the interest of structural safety and economy. Structural

aspects are discussed in EM 1110-2-2400. In addition to the static uplift pressures from reservoir or tailwater seepage, there are two conditions of hydrodynamic uplift that must be considered. The first consideration is at vertical curves from a steep slope to a flatter slope. Transmission of high boundary pressure through construction joints is possible and should be analyzed in determining uplift on chute slabs. Construction joints should be excluded from locations that include vertical curves from a steep to flatter slope. Theoretical studies and model and prototype data indicate that the pressures resulting from the change in direction of the flow are changing continuously throughout the curve and are influenced by the curve radius, flow velocity, and discharge. Pressures immediately upstream and downstream of the curve are influenced by the invert curvature but reduce rapidly to hydrostatic pressures a short distance away from the curve. These pressures can best be evaluated by means of a flow net or model study. An estimate of the pressures can be obtained by extrapolating the pressure pattern of the curve. Flip bucket pressures discussed in paragraph 7-21 are applicable in this analysis. The second consideration is at vertical curves from a flatter slope to a steeper slope. Negative pressures can occur unless the vertical curve is properly designed. The design of this type of vertical curve is similar to a parabolic drop from a tunnel exit portal to a stilling basin floor. The floor profile should be based on the theoretical equation for a free trajectory:

$$y = -x \tan \phi - \frac{gx^2}{2(1.25V)^2 \cos^2 \phi} \quad (4-5)$$

where

x and y = horizontal and vertical coordinates measured from the beginning of the curve, feet

ϕ = angle between the horizontal and the floor at the beginning of the trajectory, degrees

To prevent flow separation from the floor, the average velocity used should be derived from flow computations using a relatively small roughness value. As a conservative measure this velocity as used in equation 4-5 has been increased by 25 percent. If site conditions require a design whose trajectory is steeper than that described by equation 4-5, model studies are recommended; and special construction practices must be specified to obtain surface tolerances and other provisions such as boundary aeration, so that the chute floor surface is compatible with low boundary pressure design.

CHAPTER 5

SPECIALIZED SPILLWAYS

Section I. Side Channel Spillways

5-1. General. The side channel spillway has certain advantages which make it adaptable to topography where the overflow is most economically returned to the original streambed by a deep, narrow channel or by open channel flow through a tunnel. The conventional side channel spillway consists of an overflow weir discharging into a narrow channel in which the direction of flow is approximately parallel to the weir crest. A typical side channel spillway configuration is shown in Plate 5-1a. A modification to the conventional side channel spillway crest includes the addition of a short crest length perpendicular to the channel at the upstream end resulting in an L-shaped crest as illustrated in Plate 5-1b. Preliminary design of side channel spillways can be accomplished using the following procedures. In view of the complex nature of the flow, hydraulic model studies are normally required to ensure adequate and economical details for the final design.

5-2. Crest Design. Crest shape design and discharge determination for side channel spillways are accomplished using the procedures discussed in Chapters 2 and 3. Two crest sections have been connected with a circular arc of radius equal to $0.4H_d$ to form the L-shaped crest (item 65). The crest length in the discharge equation 2-1 must be corrected for the loss in effective crest length caused by angularity of flow at the junction of the crest sections. Plate 5-2 gives the loss of effective length as a function of head on the crest and design head. These data are considered suitable for preliminary designs even though some variation would occur with various approach depths and junction configurations.

5-3. Channel Design. The theory of flow in the channel of a conventional side channel spillway was developed by Hinds (item 22) and is based on the law of conservation of linear momentum. The assumption is made that the energy of flow over the crest is dissipated by turbulence as it turns and mixes with the side channel flow and that the only force producing longitudinal motion in the side channel results from gravitation. This theory also assumes that the frictional resistance of the channel is sufficiently small enough to be neglected without seriously affecting the accuracy of the computations. The soundness of this theory has been demonstrated by model investigations and prototype experience. Application of the theory to practical design of such a structure was illustrated by McCormmach (item 30). Hydraulic model studies have demonstrated that the energy of flow over the end section of an L-shaped crest helps in moving water down the side channel. Farney and Markus (item 16) developed a generalization of the Hinds theory to permit consideration of nonuniform velocity distribution and corresponding changes in momentum in the channel caused by flow over the L-shaped crest end section. Design of the channel (chute) downstream from the crest sections should follow procedures outlined in Chapter 4.

Section II. Limited Service Spillways

5-4. General.

a. A limited service spillway is designed to operate very infrequently, and with the knowledge that some degree of damage or erosion will occur during operation. The decision to include a limited service spillway must be based on the premise that the risk of future repair and/or reconstruction is acceptable; however, the risk of sudden, uncontrolled, catastrophic release of water is unacceptable. Limited service spillways include structures classified as emergency and/or auxiliary spillways. Normally, limited service spillways are designed to take every possible advantage of local topography. There is no restriction on alignment and consideration should be given to designing unpaved spillways to blend in with the natural environment; however, topography, geology, and hydrology must be carefully evaluated in order to assure that when the facility does operate, the following conditions will be attained.

(1) The spillway flow and/or resulting erosion will not endanger the dam or dam foundation.

(2) The control of the discharge will remain at the predetermined control section and will not be lost due to erosion.

(3) There will be sufficient time available after a spillway use event to evaluate the resultant conditions and perform repairs or reconstruction prior to the next event.

b. Gates are not normally included with a limited service spillway. Topographical and geological conditions must be extremely favorable if this type of design is to be used, because gates permit greater spillway capacity with a smaller structure, thus increasing the unit discharge and consequently the erodibility of the spillway channel.

5-5. Discharge. Infrequent, short-duration operation of a limited service spillway is highly desirable. Projects on watersheds with relatively short duration floods are the best candidates for this type of spillway; however, projects with a large flood control storage volume to runoff ratio and those with outlet works that have capacity to control floods up to the standard project flood should also be considered. The limited service spillway should not be considered for long-duration use, defined as many days or weeks, unless extreme confidence can be placed in the damage and/or erosion resistance of the facility. The determination of discharge through the limited service spillway will involve the hydraulic theory of open channel flow. When low ogee crest discharge characteristics are involved, the procedures discussed in Chapters 2 and 3 are applicable. When backwater or drawdown computations are performed to analyze the discharge capacity and flow profiles, section-to-section velocity changes should be limited to no more than 10 percent of the velocity near the control section and no more than 20 percent at remaining sections. Two sets of discharge computations are suggested. The first set of computations is to assure that the spillway will have an adequate capacity for passage of the design flood; for this set, the maximum probable energy

losses should be assumed. The second set, involving minimum probable energy losses, is used for determination of depths and velocities for the evaluation of erosion and the design of erosion protection.

5-6. Erosion. Evaluation of expected erosion will be the most difficult and critical problem encountered in the design of limited service spillways. The designer must not only decide whether the channel materials will be eroded but also make reasonable estimates pertaining to the rate at which erosion will progress. Extensive exploration, testing of encountered materials, and geological profiles to a depth in excess of any anticipated scour are required to assist in the erosion estimates. Guidance on erosion progression is limited. Suggested permissible velocities for nonscouring channels are given in EM 1110-2-1601. The flow depth and turbulence are other important factors of incipient movement and rate of movement of channel materials; these factors should not be overlooked. Study of the history of erosion in the project area and research of erosion experiences at projects with similar facilities should be undertaken as part of the evaluation of expected erosion. Some additional information on erosion downstream from emergency spillways is given in item 21. WES has investigated scour downstream from emergency spillways and has produced a video report on this subject (item 18).

5-7. Control Section. A positive discharge control section is required for the limited service spillway. This section should be permanently fixed either in a rock cut or by construction of a concrete structure. The simplest type of control structure is a flat concrete slab with sidewalls, placed at a break in grade that will result in critical depth on the slab. A low ogee spillway crest will provide a more positive relation between reservoir elevation and discharge, a reduction in approach channel velocities, and an increase in the efficiency of the spillway. Normally a concrete apron is included downstream from the ogee crest in order to protect the toe of the crest and to align the flow with the erodible exit channel. The location of the control section is usually near the edge of the reservoir and well away from the dam structure. At sites where the channel is located in erodible material, three solutions exist:

a. The control section may be located to provide a long spillway channel with a large portion of the channel at a subcritical slope. This is done in order to ensure that the erosion, or head cutting, will start downstream from the subcritical slope and that the channel length is maximized, in order to maximize the material to be eroded and the time that will be required for the erosion to reach the control section.

b. The control section may be located at the downstream end of a cut or draw in order to maintain subcritical velocities through most of the spillway system. This configuration requires that side slopes of the cut or draw be sufficiently high to contain the design flow at the maximum reservoir elevation, and that the remaining in situ material be sufficiently competent to act as dam structure.

c. The control section located near the center of the channel length is sometimes preferred. At this position the control section is less likely to be lost due to scour than one at the downstream end. When the spillway is

16 Jan 90

sited in a bedrock structure, the most economical configuration may result by placing the control section at the upstream end of the channel and allowing supercritical velocities through most of the channel.

Section III. Shaft Spillways

5-8. General. Shaft spillways include various configurations of crest designs, with or without gates, all of which transition into a closed conduit (tunnel) system immediately downstream from the crest. The closed conduit system on a shaft spillway is in lieu of the open channel chute used on conventional spillways. All configurations of shaft spillways have many of the same disadvantages. This section will present the disadvantages and the design problems involved in designing shaft spillways, one of which is the morning-glory spillway. This spillway may be designed to operate with crest control for a range of reservoir elevations immediately above the crest apex elevation and then conduit control as the reservoir elevation continues to increase. A shaft spillway should be designed in a manner that will prevent flow control shift from the crest to the conduit or outlet when the discharge is greater than 50 percent of the design flow. This recommendation is based on preventing the following hydraulic conditions from occurring when the reservoir is at or near full pool:

a. Unstable flow characteristics during the transition from crest to conduit control, which would occur over an extended period of time, resulting in unacceptable noise, rapid pressure fluctuations, and vibrations.

b. The undesirable change in reservoir elevation-to-discharge relationship associated with conduit or outlet control, wherein the reservoir elevation increases rapidly with comparatively small increases in discharge. This condition could lead to a rapid and unpreventable overtopping of the dam during the peak of a large flood.

Ideally, a shaft spillway should be designed to operate with crest control throughout the entire expected range of discharge. However, the range of expected discharge is based on the current hydrologic data. Spillway design flood flow rates may change due to updated probable maximum precipitation quantities; changes in the basin runoff characteristics could vary significantly with time; and the project operation may be revised at a future date which may result in an increase to the spillway design flood. Any of these factors, separately or in combination, could be sufficient to cause a spillway designed for crest control to shift to conduit control in the upper range of expected discharge. Another condition that could cause the control shift at essentially any discharge is partial plugging of the conduit. Plugging could occur either by external debris (logs and ice) or an internal problem resulting from cavitation damage. Projects incorporating a shaft spillway should consider this feature an outlet works, to be used in conjunction with another form of open channel auxiliary spillway.

5-9. Morning-Glory Outlet. The morning-glory outlet utilizes a crest circular in plan, with outflow conveyed by a vertical or sloping shaft, usually to a horizontal tunnel at approximately streambed elevation. This type structure is especially adaptable to damsites where a portion of the diversion

tunnel can be used as the horizontal tunnel. Plate 5-3 shows typical layouts of vertical and sloping shaft designs. Hydraulic design data for the morning-glory outlet are presented in HDC 140-1 to 140-1/2. Problems frequently encountered in this type of structure involve vortex action, unstable flow, and cavitation. Local topography may initiate vortex trends in the approach flow to the spillway, resulting in reduced capacity, flow instability, and surges in the spillway shaft and tunnel, as revealed by the USBR studies (items 7, 29, and 75). Posey and Hsu (item 42) performed laboratory studies that indicated the vortex over a submerged circular orifice can reduce the discharge by as much as 75 percent. Piers, fins, vanes, and curtain walls have been used to suppress vortex action. However, model studies are imperative to verify the effectiveness of this type of feature. When the flow control shifts from the crest to the conduit and vice versa, violent surging, originating in the shaft, can cause severe pressure and flow pulsations throughout the structure. Deflectors and vents in the shaft have been used to prevent these surges and pulsations (items 29 and 39). The need for deflectors and vents and verification of their design must be established by a hydraulic model study. The likelihood of cavitation near the point of tangency of the curve connecting the shaft to the horizontal tunnel should be considered.

Section IV. Labyrinth Spillway

5-10. General. The labyrinth spillway is characterized by a broken axis in plan in order to create a greater length of crest compared to a conventional spillway crest occupying the same lateral space. The broken axis forms a series of interconnected V-shaped weirs (see Plate 5-4). Each of the V-shapes is termed a cycle. The spillway shown in Plate 5-4 is a lo-cycle labyrinth spillway. The labyrinth spillway is particularly well-suited for rehabilitation of existing spillways and for providing a large-capacity spillway in a site with restricted width. This is due to significant increase in crest length for a given width. The free-overflow labyrinth spillway can be designed to allow reservoir storage capacity equal to that provided when using a gated spillway, but without increasing the maximum reservoir elevation. This is achieved by the extremely large increase in discharge with a relatively small increase in reservoir stage. The labyrinth spillway hydraulic characteristics are extremely sensitive to approach flow conditions. This requires siting the crest configuration as far upstream into the reservoir as possible in order to achieve approach flow nearly perpendicular to the axis. For additional information on labyrinth spillways, see items 12, 20, and 26. Serious consideration of this type of spillway will require verification of the design by a physical model study.

Section V. Box Inlet Drop Spillways

5-11. General.

a. For small dams, where topographic and foundation conditions permit, the box inlet drop spillway provides an economical means of passing large flows through the dam with relatively small head increases. The concept is similar to that of a labyrinth spillway (Chapter 5, Section IV), in that a

16 Jan 90

folded crest is used to increase crest length within a relatively confined space.

b. Many configurations of box drop inlet spillways have been studied by the USDA (item 9). Two particularly useful types, which are not covered in item 9 are the flush-approach box drop developed by WES for the Tennessee-Tombigbee Waterway (Plate 5-5 and item 3), and the elevated box drop studied by the Agricultural Research Service (ARS) (Plate 5-6 and item 44).

(1) Design Guidance for the Flush-Approach Box Drop Spillway.

Although a straight-on flow approach to the box drop (parallel to the stream and at right angles to the dam) is a more common configuration (see item 9), the Tenn-Tom flush-approach box drop is useful in situations where flow approaches the drop laterally rather than straight on. The dimensions of the box inlet drop spillway upstream of a steep chute can be determined from a known discharge and allowable head H or width of chute W , using the calibration data in Plate 5-7. For this data set, with drop length B to chute width ratios B/W range 1 to 4, and drop depth D to chute width ratios D/W range 0 to 1, the abutment radius is equal to three times the width of the chute. If it becomes necessary to increase the radius of the abutments to allow more space for water to approach the box drop from the sides, as will be the case for smaller chutes, the curve in Plate 5-7 labelled " $D = 0$ " should be used for design. This design without a drop will provide a conservative estimate of the discharge rating curve, and the change in the radius of abutments will have little effect on the discharge. A variation on this design, developed by the Nashville District, allows direct determination of chute width for a known discharge and head (see Plate 5-8) when $D/W = 0.6$ and $D/W = 3.0$. This guidance applies to box drop inlet spillways upstream from steep chutes. The slope of the chute will have little effect on the drop structure discharge capacity as long as supercritical flow occurs within the chute; however, the horizontal channel shown in Plate 5-5 could be long enough to cause a back-water effect on the head on the structure during high discharges. Note that the Tenn-Tom box drops were used as drainage structures and not spillways.

(2) Design Guidance for the Elevated Box Drop Spillway. In this spillway type, the drop box protrudes above the surrounding approach elevation. Controlled storage can thus be maintained up to the lip of the box, and a simple gated outlet can be placed through the wall of the box at the stream invert. A generalized elevated drop box spillway is shown in Plate 5-6. Item 44 contains a model study by the ARS of three different drop box configurations.

CHAPTER 6
CREST GATES

6-1. General.

a. The value of an uncontrolled fixed crest spillway in providing an extremely reliable operation and a very low cost maintenance facility is undeniable. Topographical, geological, economical, and political considerations at many damsites may restrict the use of an uncontrolled fixed crest spillway. The solution to these problems is usually the inclusion of crest gates; however, the uncontrolled fixed crest spillway should be used regardless of these considerations when the time of concentration of the basin runoff into the reservoir is less than 12 hours. When the time of concentration is between 12 and 24 hours, an uncontrolled fixed crest spillway should be given preference over a gated spillway. Basically, the inclusion of crest gates allows the spillway crest to be placed significantly below the maximum operating reservoir level, in turn permitting the entire reservoir to be used for normal operating purposes; and results in a much narrower spillway facility, avoiding the problems associated with high unit discharge/high-velocity flow and increased operation and maintenance costs. A gated spillway must include, as a minimum, two or preferably three spillway gates in order to satisfy safety concerns. Two common types of crest gates used extensively by the CE are the tainter (radial) gate and the vertical lift gate. These and other types of crest gates have been used throughout the world. This manual discusses only the tainter and vertical lift gates. A good discussion of all types of gates can be found in item 27.

b. The hydraulic design of crest gates involves the determination of the hydrostatic and hydrodynamic forces acting on the gate and crest in the immediate vicinity of the gate; the design and evaluation of gate seals, seats, and slots with respect to flow-induced vibrations and cavitation-related problems; the determination of the rate of flow from partially open gates; and the evaluation of gate seat locations, the trunnion elevation, and other hydraulics-related structural features.

6-2. Tainter Gates. Recent controlled crest spillway designs tend to favor use of the tainter gate almost exclusively over any other type of crest gate. This is due to the relatively inexpensive first cost and the ease and low cost of operation and maintenance. The conventional tainter gate consists of a skin plate and a framework of horizontal and vertical members all of which are formed to a segment of a cylinder. This cylindrical segment is held in place by radial struts that converge downstream to a central location called the trunnion. The cylindrical skin plate structure is concentric to the trunnion which causes the resultant of the hydrostatic force to pass through the trunnion; thus, there is no moment resulting from this force to be overcome by the gate hoist. The gate lip is essentially sharp-edged, which results in minimizing downpull forces as well as vibration-inducing forces. The main load that the hoist must accommodate is a portion of the gate weight, side seal friction, and trunnion friction. The tainter gate does not require slots in the pier. This type of gate is noted for good discharge characteristics.

a. Gate Size and Trunnion Location. The tainter gate height is dependent upon the required damming height between the gate seat elevation and the maximum operating elevation. The gate width is related to the spillway monolith width because spillway piers are normally located in the center of the monolith with the gate spanning the space between the piers and the monolith joint. The gate trunnion is located above the water surface of the maximum uncontrolled discharge (see Chapters 2 and 3 for water surface profile determination). Usually the water surface location and gate geometry are such that the trunnion can be located at the optimum structural location of one-third the vertical distance above the lip of the gate. The horizontal location of the trunnion is dependent upon the gate seat location and the gate radius. Table 6-1 shows the major dimensions of some of the large tainter gates used on the Columbia River Basin Projects. There appears to be no reason that gates significantly larger than those listed in Table 6-1 could not be used. The only constraints on gate size are economics and safety. Safety considerations require that at a minimum two spillway gates should be provided. Three gates are preferred to satisfy safety concerns.

TABLE 6-1

Major Tainter Gate Dimensions, Feet

<u>Project</u>	<u>Height</u>	<u>Width</u>	<u>Gate Radius</u>	<u>Horizontal Distance Seat To Crest</u>	<u>Vertical Distance Trunnion To Seat</u>
Lower Monumental	60.6	50.0	60.0	11.2	18.6
John Day	60.0	50.0	60.0	10.2	20.0
Libby	56.0	48.0	55.0	15.6	18.1
Chief Joseph	58.2	36.0	55.0	10.7	20.2
Dworshak	56.7	50.0	55.0	7.0	18.0

b. Gate Seat Location. The location of the gate seat affects the height of the gate, the local crest pressures, and the discharge coefficients at partial gate openings. The coefficient effect is relatively unimportant from a design standpoint, as the gate opening can be adjusted to obtain the desired discharge. The gate seat should not be located upstream of the crest axis, as the jet issuing under the gate would tend to spring away from the crest boundary, resulting in negative pressures and possible cavitation damage on the crest. The gate seat can be located either on or downstream from the crest apex. The location of the gate seat is usually dictated by structural requirements such as the spillway bridge, hoist equipment location, etc. The gate seat location influences the trunnion location and the height that the gate must be raised to clear the water surface at the maximum uncontrolled discharge. Gate and trunnion clearance above the maximum uncontrolled discharge profile should include considerations for floating debris and ice and inaccuracies in the flow profile. Impact to the gate and trunnion by debris, ice, or high-velocity flow should be avoided.

c. Discharge Coefficient. The development of the rating curve for a partly open unsubmerged tainter gate, mounted on a spillway crest, is based on the following high head orifice equation:

$$Q = CW_b G_o (2gH)^{1/2} \quad (6-1)$$

where

W_b = gate width, feet

G_o = gate opening, minimum distance from gate lip to crest boundary, feet

H = distance from reservoir surface to center of G_o , feet

Plate 6-1 shows suggested design discharge coefficient curves for various gate seat locations. The data points were computed from model and prototype data for several crest shapes and tainter gate designs with nonsubmerged flow. Data shown are based principally on tests with three or more bays in operation. Discharge coefficients for a single bay would tend to be lower because of side contractions. The discharge coefficient C shown in Plate 6-1 is plotted as a function of the angle β **formed by the tangent to the gate lip and the tangent to the crest curve location intersected by the minimum distance line from the gate lip to the crest** (see sketch in Plate 6-1). The computation of discharge under a partially open spillway crest tainter gate is complicated by the geometry involved in determining the gate opening, G_o , **and the β angle the gate lip makes with the crest.** HDC 311-1 through 311-5 describe a method for the numerical solution of G_o and β . The CORPS program H3106 will perform the numerical solution for the gate opening and the discharge.

d. Crest Pressure. Flow characteristics at a control section gate are conducive to low pressures. Depending upon the situation, the pressure may be low enough to result in cavitation. Upstream from a gated spillway crest the flow velocity and resulting turbulence along the crest boundary are of a very low magnitude. At the control section a very rapid acceleration of the flow occurs without extensive turbulent boundary layer development. Thus, the velocity immediately adjacent to the crest boundary is essentially the potential velocity. As the turbulent boundary develops, the velocity immediately against the crest boundary becomes less than the average velocity. Because of the lack of a turbulent boundary layer near the control section, cavitation is much more likely to be tripped by surface irregularities here than further downstream. The pressure regime on the spillway crest boundary resulting from flow under a partially open tainter gate is a function of gate opening, gate radius, trunnion location, and hydraulic head on the gate. Lemos' results (item 25) indicate that the effects of radius and trunnion location are small and can be neglected. Dimensionless crest pressure profiles for small, medium, and large gate openings for the design head and for 1.33 times the design head are given in Plates 6-2 and 6-3, respectively. These data indicate that with the gate seat on the crest axis, a minimum pressure of about $-0.2H_d$ can be expected on the spillway crest with a gate partially open and with the reservoir pool at $1.33H_d$. The data also show that the pressures are somewhat higher with the gate seat located downstream from the crest axis.

As an example, for a spillway with gates operating under a 53-foot head on a crest designed for a 40-foot head, a minimum pressure on the crest surface of -8 feet can be expected and a potential velocity of about 58 ft/sec. A pressure-velocity combination of the magnitude in the example has the same potential for cavitation at surface irregularities as a pressure of zero and velocity of 73 ft/sec. Where cavitation damage has occurred at control sections in the field, with pressures at about zero, velocities have been in excess of 100 ft/sec. The magnitude of surface irregularities (tolerances) that can be allowed in the vicinity of the tainter gate should be developed using the potential velocity and the procedures discussed in Section VI of Chapter 2. Pressure fluctuations on the spillway crest boundary have been investigated at both Chief Joseph Dam and Table Rock Dam (items 64 and 68). These investigations have shown that pressures as low as -3.2 feet of water occurred at Chief Joseph Dam at a large gate opening. The pressure fluctuations recorded were random and are considered to be caused by the development of the turbulent boundary layer.

e. Gate Seals. Tainter gates included on spillways for multipurpose reservoir projects normally include rubber seals on both the sides and bottom of the gate. The design and construction of the sealing system must be precise for the seal to function as planned. The design of the bottom seal is critical because an incorrectly designed bottom seal can become the cause of flow-induced vibrations that could damage the gate. Figure 6-1 shows a typical detail for both the side and the bottom seal. EM 1110-2-1605 is referenced as a source of additional information on tainter gate seals.

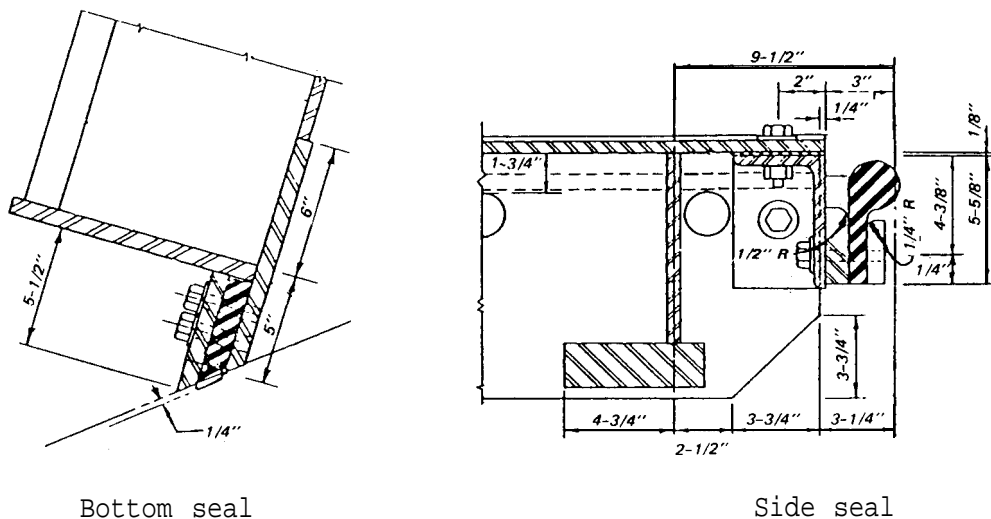

Bottom seal

Side seal

Figure 6-1. Typical details for tainter gate seals

In the northern latitudes where freezing temperatures can occur, seal heaters are usually provided. The most common type of heater is a system that circulates heated fluid through tubes attached to the concrete side of the seal plates. Studies should be made to determine if heating the seals of every

gate is required. Studies showed that at Chief Joseph Dam side seal heaters were required for only 9 of the 19 gates.

6-3. Vertical Lift Gates. The vertical lift gate is rectangular in shape and consists of a structural frame to which a flat skin plate is attached, normally on the upstream face. The hydrostatic load on the gate is transferred to the concrete structure through surfaces located in slots formed into the sides of the piers. The gate moves vertically within these slots in its own plane on a type of sliding bearing which characterizes the gate as a slide gate, wheel gate, tractor gate, etc. The hoisting system frequently consists of a track-mounted gantry crane which can be moved from gate to gate for opening and closing operations. This procedure leads to an expensive operation due to its labor intensiveness. For this reason, some projects have been designed or modified to include individual hoists for each gate. The principal hydraulic design aspects of the vertical lift gate are the shape of the bottom lip, the shape of the gate slots, and the determination of the hydraulic capacity.

a. Gate Bottom Shape. High-velocity flow under the vertical lift gate has a substantial influence on the hydraulic downpull (increased hoist load) or upthrust. The hydrodynamics of the flow under a gate may cause vertical oscillations (vibrations). Both of these conditions are dependent upon shape of the geometry of the gate bottom. Discussion, data, and references that would be useful for hydrodynamic load analysis on vertical lift gates can be found in HDC 320-2 to 320-2/3. Vibrations of the vertical lift spillway gates at Bonneville Dam were eliminated by a change in the gate bottom geometry (item 15).

b. Gate Slots. Flow past a discontinuity such as a gate slot will result in lowering the localized pressure immediately downstream from the discontinuity. Model and prototype data have shown that low pressures exist in and downstream from gate slots formed into the sides of spillway piers, and that with specific slot geometry and flow conditions, these pressures can be low enough to result in cavitation-induced damage. This is especially significant with projects that operate at heads greater than 40 feet with small gate openings. Proper geometric proportions of the slot will assist in maintaining higher boundary pressures in the vicinity of the slot. Details of various slot geometry and resulting pressure regimes are described in HDC 212-1 through 212-1/2. Spillways for hydroelectric projects usually provide for use of spillway bay bulkheads upstream from the spillway service gate. Normally these bulkheads are vertical lift type which require slots in the pier to hold the bulkhead. These slots are usually located at or upstream from the crest and sometimes extend into the pier nose geometry. Model studies for John Day Dam (item 38) included detailed studies of various bulkhead slot locations and shape. These studies led to the present use of the 90-degree upstream edge on the slot. Model studies for Chief Joseph Dam (item 57) included the John Day Dam type slot and investigated the shape of the downstream return to the pier face. The results of these studies can be applied to vertical lift gate slot design equally as well.

c. Discharge Coefficients. The discharge under a vertical lift gate can be derived using the basic orifice equation described in equation 6-1.

EM 1110-2-1603
16 Jan 90

The coefficient of discharge used must be based on vertical lift gates on spillway crests. WES (item 70) has developed a concept of relating vertical lift gate controlled discharge to free discharge. This procedure requires the determination of the head-discharge relationship for free flow. See Chapters 2 and 3 and the determination of gate opening to head on the crest ratio as described in Plate 6-4. See HDC 312 for additional information on vertical lift gate discharge coefficients.

6-4. Ice and Wave Forces on Gates. Horizontal forces acting on gates can be caused by both wind waves and ice or a combination of both. The periodic force of waves on the gate should be considered when there is sufficient reservoir fetch to generate substantial waves. There is adequate theory presented in various texts including the CE "Shore Protection Manual" (item 74) to develop these wave forces. Forces against a gate can be caused by ice in various forms. Expanding sheet ice has been the subject of considerable study. A large force can also be induced by either current- or wind-driven floe ice. The possibility also exists for local impact forces to occur from blocks of ice impelled by breaking waves. Design of spillway gates in the northern latitudes and/or at high elevations should include studies to determine ice loads. EM 1110-2-1612 should be consulted for additional information on ice forces.

CHAPTER 7

ENERGY DISSIPATORS

Section I. Basic Considerations

7-1. General. The design of the energy dissipator probably includes more options than any other phase of spillway design. The selection of the type and design details of the dissipator is largely dependent upon the pertinent characteristics of the site, the magnitude of energy to be dissipated, and to a lesser extent upon the duration and frequency of spillway use. Good judgment is imperative to assure that all requirements of the particular project are met. Regardless of the type of dissipator selected, any spillway energy dissipator must operate safely at high discharges for extended periods of time without having to be shut down for emergency repairs. An emergency shutdown of the spillway facility during a large flood could cause overtopping of the dam and/or create unacceptable upstream flooding. The three most common types of energy dissipator used at CE projects are as follows:

a. The stilling basin which employs the hydraulic jump for energy dissipation.

b. The roller bucket which achieves energy dissipation in surface rollers over the bucket and ground rollers downstream of the bucket.

c. The flip bucket which deflects the flow downstream, thereby transferring the energy to a position where impact, turbulence, and resulting erosion will not jeopardize safety of the dam or appurtenant structures.

7-2. Design Discharge. The design discharge for a given spillway energy dissipator must be uniquely determined for each facility and should be dependent upon the damage consequences when the design discharge is exceeded. As a general rule, a spillway energy dissipator should be designed to operate at maximum efficiency and essentially damage-free with discharges at least equal to the magnitude of the standard project flood. The Chief Joseph Dam stilling basin is designed to contain the full spillway design flood (SDF) because failure to do so would compromise the integrity of the project's powerhouse which is located downstream of the basin. The dissipator need not be designed for the spillway design flood if operation with the spillway design flood does not create conditions endangering the dam or causing unacceptable economic damages. Libby Dam is an example where the stilling basin is designed to fully contain the standard project flood while the jump is allowed to entirely sweep out of the basin with a discharge equal to 70 percent of the spillway design flood. A flood that will cause sweepout of this basin would be an extremely remote possibility and would result in damage to the tailrace channel, tailrace channel bridge, and a power transmission tower. However, an economic analysis showed that the cost to dissipate the SDF energy within the stilling basin significantly exceeded the cost to repair and/or replace the damaged features.

7-3. Operation. Optimum energy dissipation will occur when the flow enters the dissipator uniformly. The hydraulic designer is responsible to ensure

that project operating schedules are developed to maintain balanced flow operation of a gated, multiple-bay spillway at equal gate openings. The designer must realize, however, that conditions may occur that require unbalanced operation, e.g., development of fish attraction flows, operator error, or emergencies. Such conditions should be considered during evaluation of energy dissipation and stilling basin performance under conditions of nonuniform flow distribution.

Section II. Stilling Basins

7-4. General. The stilling basin employs the hydraulic jump for energy dissipation and is the most effective method of dissipating energy in flow over spillways. The theory of the hydraulic jump is discussed in paragraph 2-13 of this manual. The two basic parameters to be determined for design of a stilling basin are the apron elevation and length. Effective energy dissipation can be attained with a stilling basin having either a horizontal or sloping apron. The use of a sloping or horizontal apron is based solely upon economics in order to provide the least costly basin.

7-5. Horizontal Apron Basin.

a. Apron Length. The optimum stilling basin design would have an apron of sufficient length to confine the entire hydraulic jump. The jump length is a function of entering Froude number F_1 , and entering depth, d_1 . The approximate length of a hydraulic jump on a flat floor is $3.5d_1F_1^{1.5}$ for F_1 less than five and $8.0d_1F_1$ for F_1 greater than five (item 40). However, a basin of such length is normally not cost-effective. Appurtenances such as baffle blocks and end sills on the apron can be used to decrease the length of the jump without compromising the efficiency of energy dissipation. A limited review of stilling basins for high and low head spillway structures has shown that a stilling basin length can be reasonably defined by the equation:

$$L_b = Kd_1F_1^{1.5} \quad (7-1)$$

where K is the stilling basin length coefficient from Table 7-1. Equation 7-1 is considered applicable in the range of Froude numbers, F_1 , between 2 and 20, and will provide a basin length that is adequate for feasibility level designs and the basic basin length necessary to proceed into model verification. The coefficient K in equation 7-1 has been found to vary between 1.4 and 2.0 dependent upon the use of baffles and end sill. This coefficient is also dependent on the basin use, such as single gate or other unbalanced spillway flow conditions commonly found with low head navigation structures. Table 7-1 gives values for various conditions.

b. Apron Elevation. The optimum design for a stilling basin without baffles would have an apron elevation such that the jump curve defining the required d_2 depth would superimpose on the tailwater curve for the full range of discharge. However, only in extremely rare circumstances will site and hydraulic conditions coexist that result in the jump curve superimposing

TABLE 7-1

Values of K for Various Types of Stilling Basins

<u>Type of Stilling Basin</u>	<u>K</u>	<u>Remarks</u>
Stilling basin with a vertical, stepped, or sloping end sill and one or two rows of baffles	1.4	Items 41, 53, 54, 67, and 72 Suggested upper limit of F_1 is approximately eight
Stilling basin with a vertical, stepped, or sloping end sill only	1.7	Items 38, 58, 60, and 62
Stilling basin for low head broad-crested weir navigation dam spillways with one or two rows of baffles and a sloping end sill	2.0	See EM 1110-2-1605

on the tailwater curve. Experience indicates that if less than optimum energy dissipation can be tolerated, satisfactory performance can be maintained with a stilling basin that includes baffles and end sill when the apron elevation is set at full d_2 depth at the stilling basin design discharge and not less than $0.85d_2$ depth at the spillway design flood. If optimum energy dissipation is required, the basin apron should be set to provide for full d_2 depth with the spillway design flood. Excessive tailwater tends to hold the spillway jet against the apron resulting in high velocity flow exiting over the end sill which may cause damage in the exit channel. Baffles located on the apron will deflect the jet upward through the tailwater to assist in energy dissipation even when tailwater depth is excessive. When determining the apron elevation, the hydraulic designer must evaluate the potential for tailwater changes resulting from downstream channel aggradation or degradation during the life of the project and design the basin accordingly.

7-6. Sloping Aprons. Depending on site foundation conditions, some degree of economy may be realized if the stilling basin is designed with a downstream sloping apron rather than horizontal apron. The hydraulic jump is allowed to form on a portion, or all, of the sloping apron. Plates 7-1 and 7-2, which were developed from tests by USBR (item 40), can be used to determine the jump length and tailwater depth required to evaluate the hydraulic jump on aprons of various slopes. In design of a basin, either with a continuous or a noncontinuous slope, baffles and an end sill should be considered. The basin apron can be considered horizontal when the slope is flatter than 1V:6H.

16 Jan 90

7-7. Baffles.

a. General. Baffles are frequently used to aid in formation of the hydraulic jump. Their use can significantly reduce the length of the jump, decrease the required d_2 depth for a given discharge condition, and provide stability to the jump. Baffle location, shape, size, and spacing are the important parameters to be considered in design of a baffle-aided stilling basin. Cavitation damage on baffles and surrounding surfaces will occur when baffles are used in conjunction with high Froude number flow. The stilling basin design discharge, Froude number and the expected frequency and duration of use are major factors that must be included in the decision to include baffle blocks on a stilling basin apron. The USBR (item 40) recommends the upper Froude number be limited to about 5.8 for a baffled basin when the basin is to be used frequently for such structures as canals, outlet works, and small spillways. Baffles have been used in the Chief Joseph Dam stilling basin (item 53) which has a design discharge Froude number of about five and is designed for frequent use over long-duration flood events. The baffles at Chief Joseph Dam have experienced significant cavitation damage. Green Peter Dam (item 54) has two rows of baffles with a relatively high design discharge Froude number of 8.5. The spillway of Green Peter Dam is expected to be used quite infrequently and for relatively short duration events; however, this stilling basin also provides energy dissipation for flow through the sluices which operate frequently for relatively short periods of time.

b. Shape. The standard CE baffle (Plate 7-3) with a rectangular upstream face and sloping downstream face is the preferred shape. Although a 6-inch bevel on all edges is acceptable, streamlined baffles are not recommended. Streamlining the baffles does not provide as effective energy dissipation as the standard baffle, and contrary to belief, is more likely to cause cavitation damage to the stilling basin floor and to the baffle.

c. Location. The first (upstream) row of baffles plays a dominant role in establishing the type of hydraulic action that the stilling basin will display. Baffles located too far downstream reduce the basin's effective length, while baffles located too far upstream will result in spray originating from the baffle faces. Tests accomplished at WES (item 35) indicate that the optimum location of the baffles is a function of entering Froude number. Data in Plate 7-4a define the location of the upstream face of the first row of baffles. Model studies for which qualitative scour tests were conducted indicate that the second row of baffles assists in decreasing scour downstream from the stilling basin. A second row of baffles should be considered where downstream channel scour is expected to be a problem. When a second row of baffles is used, the upstream face of this row should be located about two and one-half baffle heights downstream from the upstream face of the first row and staggered with respect to baffles in the first row. Minimum spacing between the basin sidewall and a baffle is that required for forming purposes, with the maximum spacing being about one-half baffle width.

d. Size. The baffle height is a function of the entering Froude number as shown in Plate 7-4b. With Froude numbers less than 4.6, the baffle height should be $d_2/6$. The baffle width is essentially equal to the height although any reasonable width less than the height is satisfactory.

7-8. End Sills. An end sill is commonly used as the terminal wall of a stilling basin and forms a step or rise to channel bed elevation. The end sill deflects the higher velocity filaments which exist near the basin apron away from the channel bed. Results of qualitative scour tests with stilling basins containing baffles indicate that minimum exit channel scour results when the end sill has a height of $d_1/2$ or $d_2/12$, whichever is lower.

Higher end sills result in deeper scour near the end sill while low sills result in longer and deeper scour holes. The shape of the end sill does not affect its performance. A 1V on 1H sloping face end sill has the advantage of minimizing the potential for debris to be trapped in the stilling basin.

7-9. Sidewalls. Vertical stilling basin walls are preferred over battered walls because of unacceptable eddy conditions which occur with battered walls. When battered walls are required, the width at midheight of the stilling basin should equal the spillway width to minimize expansion and contraction of flow at the design discharge. Sidewalls should extend at least to maximum tail-water elevation, since return flow over stilling basin walls may create unsatisfactory basin performance, such as drowning of the jump, excessive turbulence, and localized scour downstream from the basin. Model studies are recommended when stilling basin design includes battered or low sidewalls. Computation of hydrodynamic forces acting on stilling basin sidewalls is discussed in paragraph 2-13.

7-10. Wing Walls. A design with free-standing sidewalls is preferable to one incorporating wing walls. Wing walls tend to reflect waves, resulting in a more severe attack on the exit channel side slope than that resulting when the basin sidewalls are terminated at the end sill. When wing walls are required for structural reasons, a wall rotated 90 degrees from the sidewall is preferable to other alignments.

7-11. Exit Channel.

a. General. Except in some unusual conditions, an exit channel is required to transition between the stilling basin and the main channel of the river. Since dissipation of the entire spillway discharge energy within the stilling basin is not normally accomplished, enlarging the channel width immediately downstream from the basin will assist in dissipating the residual energy. Due to the erosive nature of the highly turbulent flow exiting from a stilling basin, protection of the exit channel bed and side slopes is usually required to prevent channel scour and potential undermining of the stilling basin.

b. Size and Shape. The toe of the exit channel should be offset away from the sidewall a distance of $0.15d_2$, or at least five feet. The invert elevation of the exit channel immediately downstream of the end sill should be set 0.25-0.5 times the 100 percent diameter of stone, d_{100} , used for channel protection below the top of the end sill. The setting of the channel invert lower than the end sill is beneficial in reducing the hydrodynamic lift and drag on the stones. Mild invert slopes are recommended to transition the exit channel to the river bottom. At Libby Dam, the originally designed 1V on 6H sloping runout proved to be unstable during prototype operation and was

16 Jan 90

subsequently modified to 1V on 10H. In some instances, sloping depressions or level areas immediately downstream from the end sill have been used to minimize potential for material to migrate down the runout slope and enter the stilling basin. Exit channel designs which abruptly contract the flow downstream from the basin tend to induce lateral eddies and should be avoided.

c. Protection. Unless sited in high-quality rock, the exit channel will require protection to prevent scour and potential damage to the stilling basin. Flow leaving a stilling basin is highly turbulent and as such has a larger erosive force than that due to similar velocities in a low turbulence area. Guidance for design of rock protection adjacent to stilling basins is given in HDC 712-1. Protection based upon this guidance should extend a distance of $10d_2$ downstream from the stilling basin end sill and transition to the natural channel using gradually varying gradations as necessary to prevent major changes in adjacent rock sizes. The designer should be aware that inadequately sized rock or spalls could potentially be transported back into the stilling basin and cause significant damage. Model studies may be necessary to confirm design of the exit channel protection measures.

7-12. Abrasion and Cavitation. Stilling basin damage can occur as a result of abrasion, cavitation, or a combination of both. As discussed in Chapter 2, cavitation is possible wherever boundary irregularities cause a separation of flow with resultant localized pressure drops. In stilling basins, locations where irregularities may exist are at and around baffles, misaligned joints, and at other irregularities. Cavitation damage is distinguished by its ragged, angular appearance. Abrasion damage, on the other hand, has a smooth and rounded appearance and can be attributed to rock and debris moving through or being trapped in the basin. Depressions which are initially caused by abrasion can form boundary irregularities sufficient to initiate cavitation damage. Rock, gravel, scrap metal, and other hard material may find their way into the energy dissipator by various means. Rock may be carried into a stilling basin by diversion configurations and project operation during the project's construction or by eddies transporting debris in from the downstream channel. In some cases, contractors may fail to clean out all hard material after construction, or rocks may be thrown into a basin by the public. Unbalanced gate operation in a multibay, gated spillway can create strong eddy conditions which draw material from the downstream channel into the basin. Major stilling basin damage requiring dewatering and costly repairs occurred at Libby and Dworshak Dams (item 47) as a result of abrasion following three years of operation (Figure 7-1). Practical measures which can be taken during design, construction, and operation of a project to reduce the possibility of damage to stilling basins are as follows:

- a. Use wider exit channels with mild upward sloping runouts to transition from the basin apron to the river channel.
- b. Specify close tolerances at construction joints and ensure that construction inspection enforces those tolerances.
- c. Avoid baffles in high Froude number basins and never join baffles to basin sidewalls.



Figure 7-1. Damage to Dworshak Dam stilling basin

d. Require that all channel excavations and erosion protection measures downstream and adjacent to basins be complete prior to operation of the basin.

e. Provide barriers around and above basins to prevent construction material from falling into the basin.

f. Plan diversions to reduce potential for depositing material adjacent to basins.

g. Require inspections and cleanup of basins at end of construction.

h. Require basins to be operated with balanced flow conditions.

i. Require regular monitoring of basins.

j. When material is known to be in the basin, immediately remove the material either by flushing with a uniform distribution of water, if possible, or by shutdown and removal by other means.

Hydraulic models may be used to plan and design diversions and operation during construction, to determine flow conditions substantial enough to flush material out of a basin, and to evaluate the effect of nonuniform flow distribution on eddy conditions in basins.

Section III. Roller Buckets

7-13. General. A roller bucket energy dissipator consists of a circular arc bucket tangent to the spillway face terminating with an upward slope. This geometry when located at an appropriate depth below tailwater will produce hydraulic conditions consisting of a back roller having a horizontal axis above the bucket and a surge immediately downstream from the bucket. Solid and slotted buckets have been used successfully. The boundary geometry of a solid roller bucket is similar to that for a flip bucket except that the roller bucket is located well below the tailwater elevation. The geometry of

16 Jan 90

a slotted bucket is variable; however, it is similar to the solid bucket except for the addition of dentates on the downstream quadrant and a downstream apron. A roller bucket can be used where excessive tailwater depths exist either from hydraulic characteristics of the river channel or foundation conditions that require siting an energy dissipator well below the depth necessary for adequate hydraulic jump energy dissipation. For adequate energy dissipation to occur with a roller bucket, the tailwater depth must be within defined limits. These limits are dependent upon the inflow energy and the bucket radius. Insufficient tailwater depth will result in the flow sweeping out of the bucket and forming a jet, typical of a flip bucket. A more undesirable condition can occur just prior to sweepout when an instability develops which could result in excessive erosion and undesirable wave conditions in the tailrace and downstream channel. Excessive tailwater depth will cause the flow to dive from the bucket lip resulting in the development of a roller and surging downstream from the bucket. This action will cause erosion and movement of large volumes of bed material resulting in hydraulic instabilities, inadequate energy dissipation, and bucket erosion. Because the bucket is located immediately adjacent to the toe of the spillway, the roller bucket should be designed to efficiently dissipate the energy of the spillway design discharge to ensure against compromising the integrity of the dam structure proper. Appendix F contains an example problem for the design of a roller bucket.

7-14. Bucket Depth and Radius. The hydraulic design of the roller bucket is derived strictly from empirical data, the majority of which is from model studies (item 35). The minimum radius for a roller bucket, r_{\min} , is defined as

$$r_{\min} = \frac{5.19 \left(d_1 + \frac{V_1^2}{2g} \right)}{F_1^{1.64}} \quad (7-2)$$

where

d_1 = depth of flow entering the bucket, feet
 V_1 = velocity of flow entering the bucket, ft/sec
 F_1 = Froude number of the entering flow

The bucket invert elevation limits, maximum tailwater depth $h_{2\max}$, and minimum tailwater depth $h_{2\min}$, are related to the bucket radius r , F_1 , d_1 , and the specific energy of the entering flow $d_1 + V_1^2/2g$. These relationships are provided in Plates 7-5 and 7-6. The roller height h_b and the surge height h_s are related to the difference in reservoir and bucket invert elevations h_1 , the tailwater height h_2 , and the parameter

$(q \times 10^3)/(g^{1/2} \cdot h^{3/2})$ as shown in Plates 7-7 and 7-8. The important characteristics which must be evaluated in design of the roller bucket include the minimum tailwater depth which does not result in bucket sweepout, the maximum tailwater depth at which diving of the jet does not occur, and the maximum

surge height downstream of the bucket and the height of the back roller above the bucket. Hydraulic model tests to verify the design of roller buckets are recommended under the following conditions:

- a. Sustained operation near the limiting conditions is expected.
- b. Discharges exceed $500 \text{ ft}^3/\text{sec}$ per foot of width.
- c. Velocities entering the bucket exceed $75 \text{ ft}/\text{sec}$.
- d. Eddies appear possible.
- e. Waves in the channel downstream from the structure would be a problem.

7-15. Slotted Buckets. A disadvantage of the solid roller bucket is that the downstream surge can move loose material from the channel bed back into the bucket where the action of the back roller can result in serious abrasion damage to the bucket surfaces. For this reason, USBR (item 40) developed a slotted bucket design which reduces the possibility of extraneous material being drawn back into the back roller. The slotted bucket also exhibits better self-cleaning properties. The slotted bucket disperses and distributes flow into the downstream surge over a greater depth resulting in less violent flow concentrations than does the solid bucket (item 34). The slotted bucket developed by USBR consists of upward rounded teeth with vertical sides and a rounded top. This slotted bucket configuration also includes a 16-degree upward-sloping, 20-foot-long apron downstream from the teeth. Model studies of the Little Goose Dam spillway (item 23) were made to develop a design having more easily constructed, plane surface teeth rather than the curved surface design developed by USBR. The Little Goose Dam studies resulted in a design (Plate 7-9) which consisted of teeth trapezoidal-shaped in cross section with an apron configuration downstream from the teeth identical to that of the USBR design. In addition to the less complicated geometrical shape, the Little Goose bucket teeth exhibited more acceptable pressures than the curved-shaped design.

7-16. Exit Channel. Because of the roller bucket's tendency to move loose material from the downstream channel into the bucket itself, design of the exit channel is relatively critical to acceptable performance of the structure. As previously discussed for the hydraulic jump stilling basin, gently sloped well-protected runout slopes should be used to transition from the roller bucket to the river channel. Roller bucket surging will result in the propagation of waves throughout the tailrace and in the downstream channel. The effect of these conditions on the river banks and other structures must be considered. Hydraulic models are necessary to evaluate, at least qualitatively, the performance of the exit channel.

Section IV. Flip Buckets

7-17. General. The flip bucket itself is not an energy dissipator; however, it is an integral part of an energy dissipation system. The purpose of the flip bucket is to direct high-velocity flow (the jet) well away from the dam,

16 Jan 90

powerhouse, spillway, and/or other appurtenances. A small amount of energy is dissipated by friction through the bucket. During the jet's trajectory to its impact location, extremely turbulent flow exists and the jet spreads and frays. The extreme turbulence of the jet entrains a large volume of air. A portion of the jet's energy is dissipated by the interaction of the water and the air boundary resulting in considerable spray. The effect of heavy spray on adjacent structures, especially in cold regions, should be considered. The impact of the jet and the interaction of the turbulent flow and the boundary at the impact area account for the major portion of energy dissipation. The impact will almost certainly cause adjustment to the riverbed even if the bed material is rock. For this reason, use of a flip bucket should be considered only where bed scour caused by the impact of the water jet cannot endanger the dam, power plant, or other structures (including the flip bucket itself) or cause unacceptable environmental damage. Where the flip bucket can be appropriately used, it offers an attractive economical alternative to a stilling basin or roller bucket structure; however, the flip bucket includes more uncertainties as to adequacy than do stilling basins or roller buckets. The parameters of prime importance to the hydraulic designer are the bucket geometry, pressures acting on the bucket boundaries, and the jet trajectory characteristics. Flip bucket design is based on empiricism essentially derived from model studies. For this reason, any deviations from the flip bucket design parameters and guidelines discussed in this manual should be verified by hydraulic model studies. Appendix F contains an example problem for the design of a flip bucket.

7-18. Bucket Geometry.

a. General. The geometric parameters required for design of a flip bucket include the bucket radius, r , the minimum height of the bucket lip, h_{\min} , the trajectory angle at the end of the bucket, θ , the bucket invert elevation, and the planimetric alignment of the bucket. The parameters r , h_{\min} and θ are closely related and may require trial-and-error adjustment in order to obtain a satisfactory design. The planimetric alignment can be developed to direct the location of the jet impact area. Figure 7-2 depicts the various terms used for the flip bucket design process.

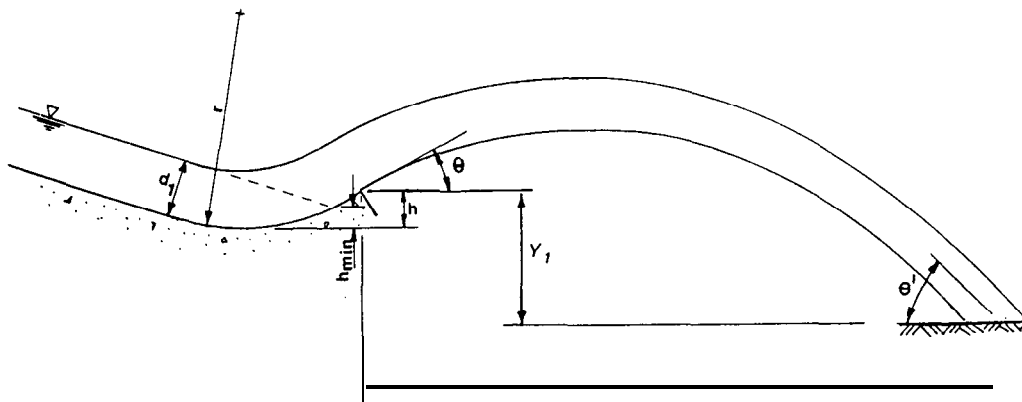

Figure 7-2. Parameters used in the design of a flip bucket

b. Radius. The minimum radius, r_{\min} , is a function of the allowable theoretical unit load on the bucket invert P_T , the velocity of flow, V_1 , and the depth of flow, d_1 , entering the bucket defined as

$$r_{\min} = \frac{\rho V_1^2 d_1}{P_T - \gamma d_1} \quad (7-3)$$

As a general design guide, previous experience suggests that a bucket radius at least equal to four times the maximum flow depth will turn most of the water before it leaves the bucket.

c. Minimum Height. The height of the bucket lip must be sufficient to prevent the water from merely overriding the bucket lip in lieu of being turned and flipped out of the bucket. To effectively turn the flow, the bucket height must be at least high enough to intersect the forward-projected slope of the water surface at the point of curvature of the spillway and the bucket curve. The minimum bucket height described by equation 7-4 will ensure that the flow will follow the bucket curve and not override the downstream lip.

$$h_{\min} = r - r \cos (\phi - \tan^{-1} S) \quad (7-4)$$

where

$$\phi = \tan^{-1} \left\{ \frac{[d_1 (2r - d_1)]^{1/2}}{r - d_1} \right\}$$

describes the minimum deflection angle and S is the slope of the spillway chute adjacent to the bucket.

When $\phi > \tan^{-1} S$, the minimum height of the bucket becomes zero. The height of the bucket is then defined by the required trajectory angle θ . A trial-and-error adjustment of the bucket radius and/or bucket flip angle may be necessary to meet or exceed the minimum bucket height as defined in equation 7-4.

d. Trajectory Angle. The trajectory angle is the angle the bucket lip makes with respect to the horizontal. The trajectory angle is a factor in determining the length of the jet trajectory distance and the general hydraulic characteristics in the impact area. Steeper angles increase the trajectory length and provide better dissipation than flatter angles as they cause the jet to impact in a more vertical direction with less violent side eddies. A 45-degree flip angle will result in the maximum trajectory distance. The required height of the bucket lip, h , above the bucket invert necessary to satisfy the desired trajectory angle θ can be determined by the following equation:

$$h = r - r \cos \theta \quad (7-5)$$

e. Bucket Elevation. For optimum performance, the flip bucket cannot operate under submerged conditions. Depending on the shape of the tailwater curve, raising of the bucket invert elevation or the lip of the bucket may be required. In evaluating tailwater conditions, the designer should consider that the ejector action of the jet as it exits the bucket may tend to cause a drawdown in the tailwater elevation depending on downstream channel geometry. Such drawdown may adversely impact the operation of adjacent structures such as powerhouses, etc. The amount of drawdown which may occur with any given design can best be determined from hydraulic models. For preliminary design purposes, a method of estimating drawdown can be found in item 40.

f. Bucket Termination. The bucket should terminate with a 90-degree cut from the bucket lip, and the sidewalls should terminate at the lip to allow sufficient air to be drawn below the point of the trajectory separation from the bucket lip. Failure to allow sufficient air to the underside of the jet will cause jet flutter with resultant pressure fluctuations and possible cavitation damage. The original design of the flip buckets on the Wynoochee Dam outlets (item 55) terminated in a 20-degree cut which resulted in cavitation damage to the concrete surfaces downstream from the lip. Extending the bucket length to allow a 90-degree termination cut has eliminated this damage.

g. Alignment. The flip bucket can be aligned to direct the trajectory impact to a preselected location by curving or adding appurtenances to the bucket. An example of such a directional design is the spillway for the East Branch Reservoir spillway (item 63). Model studies are required to confirm the final design of a directional flip bucket. A bucket alignment which spreads the flow at the impact area across as much of the river channel as possible minimizes riverbed adjustment and return flow from the downstream tailwater.

7-19. Discharge Considerations. Flip buckets perform best when the entering flow is at high velocity and low unit discharge as such conditions result in considerable fraying of the jet by air resistance. Moderately high unit discharges, however, should not be a problem if downstream channel adjustment is not of prime consideration. The flip buckets at Wynoochee Dam (item 55) have operated satisfactorily for extended periods with unit discharges of **approximately 350 ft³/sec/ft.** The Applegate Dam spillway flip bucket was developed through model studies (item 61) and is designed for a unit discharge of 850 ft³/sec/ft. Flip buckets exist where design unit discharges are well in excess of 1,000 ft³/sec/ft; these designs are extremely critical with respect to cavitation damage due to the extremely high velocities, deep flow depths, and subatmospheric pressures which exist. Model studies are recommended for flip buckets designed with unit discharges in excess of 250 ft³/sec/ft.

7-20. Trajectory Distance. The jet trajectory distance is dependent upon the velocity of flow entering the flip bucket, the trajectory angle, and the vertical distance from the bucket lip to the impact area. The trajectory distance, X_H , which is the horizontal distance from the bucket lip to the impact location, is determined by the equation:

$$X_H = h_e \sin 2\theta + 2 \cos \theta \left[h_e (h_e \sin^2 \theta + Y_1) \right]^{1/2} \quad (7-6)$$

where

h = velocity head at the bucket lip, feet
 Y_1^e = vertical distance below the bucket lip to the impact area, feet

When the Y_1 value is equal to zero, then equation 7-6 reduces to:

$$X_H = \frac{V^2}{2g} \sin 2\theta \quad (7-7)$$

The angle at which the jet strikes the impact location, θ' , is described by the following equation:

$$\theta' = \tan^{-1} \left[\sec \theta \left(\sin^2 \theta + \frac{Y_1}{h_e} \right)^{1/2} \right] \quad (7-8)$$

Equation 7-8 reduces to $\theta' = \theta$ when Y_1 is equal to zero. Trajectory lengths based on equations 7-6 and 7-7 have been simulated reasonably well in hydraulic models. Prototype trajectories are somewhat shorter and have steeper impact angles than the model or theoretical jet due to the greater air resistance encountered in the prototype.

7-21. Bucket Pressures. Pressures on the invert of the bucket vary throughout the curve and are influenced by the curve radius, the total head on the invert, and the unit discharge. A WES study (item 71) indicated that, for relatively high dams, bucket pressures could be expressed as:

$$h_p = f \left(\frac{q}{r(2gH_T)^{1/2}}, \frac{\alpha}{\alpha_T} \right) \quad (7-9)$$

where

h_p = pressure head against boundary, feet
 H_T = total head (point to energy gradient), feet
 α = angle of rotation from beginning of curve, degrees
 α_T = total deflection angle, degrees

The term α/α_T defines the relative position along the curve. The pressure distribution throughout the length of the flip bucket can be estimated using the data provided in Plate 7-10. This curve has been developed from model data although some prototype data at a small discharge has been included. This curve is essentially the same as HDC Chart 112-7 plotted in a different form. The term $q/[r(2gH_T)^{1/2}]$ has been replaced by $d_1^{1/2}/r$ for the usual case where d_1 is small when compared to $V^2/2g$. See HDC Chart 112-7 for a more detailed discussion on the data used for Plate 7-10.

7-22. Exit Channel. Optimum performance will occur when the jet trajectory at impact spreads approximately across the entire width of the river channel. Unless the jet impact area is located in extremely durable rock, a scour hole can be expected to occur at the impact point. The material scoured in development of the hole will be deposited downstream where it may adversely impact satisfactory operation of the flip bucket. A preformed scour hole at the impact area can be used to minimize deposition in the downstream channel. Violent wave action can be expected in the impact area, and wave and high-velocity turbulence will likely extend laterally and downstream from the impact. These conditions can lead to streambank damage unless the banks are adequately protected. A model study is recommended to qualitatively evaluate the extent of bed scour and hydraulic conditions existing with operation of a flip bucket.

7-23. Miscellaneous.

a. Drainage. The bucket must be adequately drained to prevent water impoundment in the bucket. Due to potential for cavitation damage, floor drains should be avoided and the bucket should be drained laterally through the sidewalls.

b. Low Flow Operation. At low flows, water may pond in the bucket and spill over the lip. Erosion may be caused by these low flows which do not flip and should be considered in the design. A concrete slab, cutoff wall, or large stone may be needed at the toe of the structure to protect the structure from undermining. A double-flip bucket design was developed for the Applegate Dam spillway (item 61) to prevent damage which would result with operation of low, nonflipping discharges.

Section V. Specialized Energy Dissipators

7-24. Impact Basin. An impact hydraulic jump-type energy dissipator was developed by Blaisdell (item 9) for small drainage structures. The USBR uses a similar dissipator which they designate as a Type III Basin (item 40). Tests at WES on the Rend Lake (item 17) and Oakley (items 31 and 73) projects showed this type basin to be very effective in the Froude number range of 2.5 to 4.5. Preferred dimensions of the basin and its elements for use in this range of Froude numbers are given in Plate 7-11. This type dissipator is not recommended where velocity entering the basin exceeds 60 ft/sec as the chute blocks would be subject to damage by cavitation. An apron length equal to at least $3d_2$ for flows up to the standard project flood, and $2d_2$ for the spillway design flood is considered adequate. The basin elevation should provide a depth on the apron of d_2 for the standard project flood and at least $0.85d_2$ for the spillway design flood.

7-25. Baffled Chute. The baffled chute spillway relies upon multiple rows of baffles to aid in dissemination of energy flowing down a spillway chute. The USBR (item 40) has developed a set of design guidance which can be used in preliminary design of such a structure. Large baffled chute spillways have been used on the Tennessee-Tombigbee Waterway divide cut to convey the flow of streams intercepted by the canal down the cut slope into the canal (item 3). Model studies are recommended for design verification when the design

16 Jan 90

discharge exceeds $50 \text{ ft}^3/\text{sec}$ and/or the slope is steeper than 1V on 2H. A baffled chute design was developed via model study (item 59) for the proposed Libby Reregulating Dam which was effective not only in energy dissipation, but also in aerating the flow and reducing nitrogen supersaturation. The specially designed baffle (Plate 7-12) for this structure exhibited good aeration characteristics for discharges up to $180 \text{ ft}^3/\text{sec}/\text{ft}$ and adequate energy dissipation for discharges as high as $900 \text{ ft}^3/\text{sec}/\text{ft}$.

APPENDIX A

BIBLIOGRAPHY

1. Abecasis, F. M. 1961. "Spillways - Some Special Problems," Memorandum No. 175, National Laboratory of Civil Engineering, Lisbon, Portugal.
2. Abecasis, F. M. 1970 (Dec). 'Designing Spillway Crests for High-Head Operation," Journal, Hydraulics Division, American Society of Civil Engineers, Vol 96, No. HY12, pp 2655-2658.
3. Ables, Jackson H., Jr. 1976 (Oct). "Divide Cut Drainage Structures, Tennessee-Tombigbee Waterway, Mississippi and Alabama; Hydraulic Model Investigation," TR H-76-18, US Army Engineer Waterways Experiment Station, Vicksburg, Miss.
4. American Society of Mechanical Engineers. 1958. "American Standard Letter Symbols for Hydraulics,' ASA Y10-1958, New York.
5. Bauer, W. J., and Beck, E. J. 1969. 'Spillways and Stream-Bed Protection Works," Section 20, Handbook of Applied Hydraulics, 3d ed., C. V. Davis and K. E. Sorensen, eds., McGraw-Hill, New York.
6. Bazin, H. E. 1888 (Oct), 1890 (Jan). "Recent Experiments on the Flow of Water over Weirs," Annales des Ponts et Chaussees, translated by Al Marichal and J. C. Trautwine, Jr., Engineers' Club of Philadelphia, Proceedings, Vol 7, No. 5, 1890, pp 259-310; Vol 9, No. 3, 1892, pp 231-244; Vol 10, No. 2, 1893, pp 121-164.
7. Beichley, G. L. 1954 (23 Apr). 'Hydraulic Model Studies of the Morning-Glory Spillway for Hungry Horse Dam, Hungry Horse Dam Project,' Hydraulic Laboratory Report HYD-355, US Bureau of Reclamation.
8. Blaisdell, F. W. 1954. "The SAF Stilling Basin,' Soil Conservation Service and St. Anthony Falls Hydraulic Laboratory, University of Minnesota, Minneapolis, Minn.
9. Blaisdell, Fred W., and Donnelly, Charles A. 1966 (Apr). "Hydraulic Design of the Box-Inlet Drop Spillway,' Agricultural Handbook No. 301, Agricultural Research Service, US Department of Agriculture in cooperation with the Minnesota Agriculture Experiment Station and the St. Anthony Falls Hydraulic Laboratory of the University of Minnesota, Minneapolis, Minn.
10. Chow, V. T. 1959. Open Channel Hydraulics, McGraw-Hill, New York.
11. Cox, R. G. 1972 (Sep). 'Hydraulic Design of Spillway Chutes with Converging Sections," ETL 1110-2-158, Office, Chief of Engineers, US Army, Washington, D. C.

16 Jan 90

12. Darvas, L. A. 1971 (Aug). "Performance and Design of Labyrinth Weirs - Discussion," Journal, Hydraulics Division, American Society of Civil Engineers, pp 1246-1251.
13. DeFazio, F. G., and Wei, C. Y. 1983. "Design of Aeration Devices on Hydraulic Structures," American Society of Civil Engineers 1983 Hydraulics Division Conference.
14. Destenay, J., and Bernard, J. 1968. "Quelques Exemples de Degradation des Betons par Cavitations dans es Ouvrages Hydroelectriques," La Houille Blanche, No. 2-3, pp 167-176.
15. Edmister, T. D., and Smith, P. M. 1975 (May). "Spillway Gate Modification, Bonneville Dam, Columbia River, Oregon and Washington," TR No. 136-1, US Army Engineer Division, North Pacific, Bonneville Hydraulic Laboratory, Bonneville, Oreg.
16. Farney, H. S., and Markus, A. 1962 (May). "Side Channel Spillway Design," Journal, Hydraulics Division, American Society of Civil Engineers, pp 131-154; Discussion, Journal, Hydraulics Division, American Society of Civil Engineers, Nov 1963, pp. 223-228.
17. Fletcher, B. P., and Grace, J. L., Jr. 1969 (May). "Spillway for Rend Lake Reservoir, Big Muddy River, Illinois; Hydraulic Model Investigation," TR H-69-7, US Army Engineer Waterways Experiment Station, Vicksburg, Miss.
18. Fletcher, Bobby P., and Kirkpatrick, Tommy L., Jr. 1987 (Nov). "Excessive Scour Downstream of High-Level Emergency Spillways," Video Report REMR-HY-1, US Army Engineer Waterways Experiment Station, Vicksburg, Miss.
19. Fletcher, Bobby P., and Saunders, Peter E. 1988 (May). "Dynamic Loading on Sidewall Monoliths of a Spillway Stilling Basin; Hydraulic Model Investigation," TR HL-88-10, US Army Engineer Waterways Experiment Station, Vicksburg, Miss.
20. Hay, Nessim, and Taylor, Geoffrey. 1970 (Nov). "Performance and Design of Labyrinth Weirs," Journal, Hydraulics Division, American Society of Civil Engineers, Vol 96, No. HY11, pp 2337-2357.
21. Headquarters, US Army Corps of Engineers. 1985 (Sep). "Causes of Excessive Scour Downstream from High-Level Emergency Spillways," The REMR Notebook, Technical Note HY-FC-1.1, Washington, D. C.
22. Hinds, Julian. 1926. "Side Channel Spillways: Hydraulic Theory, Economic Factors, and Experimental Determination of Losses," Transactions, American Society of Civil Engineers, Vol 89, pp. 881-939.
23. Johnson, R. L., and Perkins, L. Z. 1975. "Spillway for Little Goose Dam, Snake River, Washington," TR No. 114-1, US Army Engineer Division, North Pacific, Bonneville Hydraulic Laboratory, Bonneville, Oreg.

24. King, H. W., and Brater, E. F. 1963. Handbook of Hydraulics for the Solution of Hydrostatic and Fluid-Flow Problems, 5th ed., McGraw-Hill, New York.
25. Lemos, F. O. 1965. "Instability of the Boundary Layer, Its Effects Upon the Concept of Spillways of Dam," Proceedings 62/43, National Laboratory of Civil Engineering, Department of Hydraulics, Ministry of Public Works, Lisbon, Portugal; US Army Engineer Waterways Experiment Station Translation No. 71-3, Jan C. Van Tienhoven, Translator, Aug 1971, Vicksburg, Miss.
26. Lux, Frederick, III. 1984. "Discharge Characteristics of Labyrinth Weirs," Water for Resource Development, American Society of Civil Engineers 1984 Hydraulics Division Conference.
27. Mayer, P. R., and Bowman, J. R. 1969. "Spillway Crest Gates," Section 21, Handbook of Applied Hydraulics, 3d ed., C. V. Davis and K. E. Sorenson, eds., McGraw-Hill, New York.
28. Maynard, S. T. 1985 (Mar). "General Spillway Investigation; Hydraulic Model Investigation," TR HL-85-1, US Army Engineer Waterways Experiment Station, Vicksburg, Miss.
29. McBirney, W. B. 1960 (22 Apr). "Hydraulic Model Studies of the Trinity Dam Morning-Glory Spillway, Trinity River Diversion, Central Valley Project, California," Hydraulic Laboratory Report HYD-447, US Bureau of Reclamation.
30. McCormmach, A. L. 1954. "Hydraulic Design of Side Channel Spillways" (unpublished memorandum), US Army Engineer District, Walla Walla, Walla Walla, Wash.
31. Melsheimer, E. S. 1970 (Nov). "Spillway for Oakley Dam, Sangamon River, Illinois; Hydraulic Model Investigation," TR H-70-13, US Army Engineer Waterways Experiment Station, Vicksburg, Miss.
32. Melsheimer, E. S., and Murphy, T. E. 1970 (Jan). "Investigations of Various Shapes of the Upstream Quadrant of the Crest of a High Spillway," RR H-70-1, US Army Engineer Waterways Experiment Station, Vicksburg, Miss.
33. Murphy, T. E. 1973 (Dec). "Spillway Crest Design," MP H-73-5, US Army Engineer Waterways Experiment Station, Vicksburg, Miss.
34. Murphy, T. E., and Cummins, R. S., Jr. 1965 (Jan). "Spillway Modifications, Miraflores Dam, Panama Canal Zone; Hydraulic Model Investigation," TR No. 2-778, US Army Engineer Waterways Experiment Station, Vicksburg, Miss.
35. Murphy, Thomas E. 1974 (25 Jun). "Memorandum For Record: Spillway Stilling Basin, Hydraulic Jump Type," US Army Engineer Waterways Experiment Station, Vicksburg, Miss.

EM 1110-2-1603

16 Jan 90

36. Office, Chief of Engineers. 1978 (15 Sep). "Nitrogen Supersaturation," ETL 1110-2-239, Washington, D. C.
37. Ortolano, L. 1974 (Jan). "Issues in Water Resources Impact Assessments," Journal, Hydraulics Division, American Society of Civil Engineers, pp 173-187.
38. Perkins, L. Z. 1974 (Nov). "Spillway and Stilling Basin, John Day Dam, Columbia River, Oregon and Washington," TR No. 97-1, US Army Engineer Division, North Pacific, Bonneville Hydraulic Laboratory, Bonneville, Oreg.
39. Peterka, A. J. 1956. "Morning-Glory Shaft Spillways (Symposium): Performance Tests on Prototype and Model," Transactions, American Society of Civil Engineers, Vol 121, pp 385-409.
40. Peterka, A. J. 1974. "Hydraulic Design of Stilling Basins and Energy Dissipators," Engineering Monograph No. 25, US Bureau of Reclamation, Denver, Colo.
41. Pickering, G. A. 1968 (Jan). "Spillway for Kaysinger Bluff Dam, Osage River, Missouri; Hydraulic Model Investigation," TR No. 2-809, US Army Engineer Waterways Experiment Station, Vicksburg, Miss.
42. Posey, C. J., and Hsu, Hsieh Ching. 1985 (9 Mar). "How the Vortex Affects Orifice Discharge," Engineering News-Record, Vol 144, No. 10, p 30.
43. Rand, W. 1955 (Sep). "Flow Geometry at Straight Drop Spillways," Proceedings, American Society of Civil Engineers, Vol 81, No. 791.
44. Ree, W. O. 1976 (Jul). "Comparison of Chute and Stilling Basin Performance for Three Different Drop Box Inlets," ARS-S-126, Agricultural Research Service, US Department of Agriculture, Washington, D. C.
45. Reese, A. J., and Ingram, J. J. 1985. "Computer Aided Design Using 'CORPS' ," Computer Applications for Water Resources, Proceedings, American Society of Civil Engineers, Hydraulics Division Conference.
46. Regan, R. P. 1984. "Aeration is the Solution for Sluice Cavitation Damage at Libby Dam, Montana," Water for Resource Development, Proceedings, American Society of Civil Engineers, Hydraulics Division Conference.
47. Regan, R. P., Munch, A. V., Schroder, E. K. 1979. "Cavitation and Erosion Damages of Sluices and Stilling Basins at Two High-Head Dams," Transactions, ICOLD Thirteenth Congress on Large Dams, Question 50, Response 11, New Delhi, India.
48. Rouse, H. 1938. Fluid Mechanics for Hydraulic Engineers, 1st ed., McGraw-Hill, New York.
49. Rouse, H. 1946. Elementary Mechanics of Fluids, Wiley, -New York.

50. Rouse, H. 1950. Engineering Hydraulics, Wiley, New York.
51. Rouse, H., and Reid, L. 1935 (Jan). "Model Research on Spillway Crests," Civil Engineering, Vol 5, No. 1, pp 11-16.
52. US Army Engineer Institute for Water Resources. 1972 (Jun). "An Analysis of Environmental Statements for Corps of Engineers Water Projects," IWR Report 72-3, Fort Belvoir, Va.
53. US Army Engineer District, Portland. 1956 (Aug). "Spillway and Stilling Basin for Chief Joseph Dam, Columbia River, Washington," Report No. 34-1, Bonneville Hydraulic Laboratory, Bonneville, Oreg.
54. US Army Engineer Division, North Pacific. 1968 (Aug). "Spillway and Fish Passage Facilities, Green Peter Reservoir, Middle Santiam River, Oregon," TR No. 107-1, Bonneville Hydraulic Laboratory, Bonneville, Oreg.
55. US Army Engineer Division, North Pacific. 1971 (Feb). "Spillway Chute and Sluice Outlets, Wynoochee Dam and Reservoir, Wynoochee River, Washington," TR No. 134-1, Bonneville Hydraulic Laboratory, Bonneville, Oreg.
56. US Army Engineer Division, North Pacific. 1979 (May). "Spillway Modifications for Chief Joseph Dam, Columbia River, Washington," TR No. 156-1, Bonneville Hydraulic Laboratory, Bonneville, Oreg.
57. US Army Engineer Division, North Pacific. 1983 (Jan). "Spillway Pier Shape at Stoplog Slot for Chief Joseph Dam, Columbia River, Washington," TR No. 183-1, Bonneville Hydraulic Laboratory, Bonneville, Oreg.
58. US Army Engineer Division, North Pacific. 1983 (Jun). "Libby Dam, Kootenai River, Montana," TR No. 125-1, Bonneville Hydraulic Laboratory, Bonneville, Oreg.
59. US Army Engineer Division, North Pacific. 1983 (Jul). "Libby Reregulating Dam, Kootenai River, Montana," TR No. 160-1, Bonneville Hydraulic Laboratory, Bonneville, Oreg.
60. US Army Engineer Division, North Pacific. 1984 (Aug). "Lower Granite Dam, Snake River, Washington," TR No. 121-1, Bonneville Hydraulic Laboratory, Bonneville, Oreg.
61. US Army Engineer Division, North Pacific. 1984 (Sep). "Applegate Dam Spillway and Outlet Works, Applegate River, Oregon," TR No. 171-1, Bonneville Hydraulic Laboratory, Bonneville, Oreg.
62. US Army Engineer Division, North Pacific. 1984 (Sep). "Dworshak Dam, North Fork, Clearwater River, Idaho," TR No. 116-1, Bonneville Hydraulic Laboratory, Bonneville, Oreg.

EM 1110-2-1603

16 Jan 90

63. US Army Engineer Waterways Experiment Station. 1951 (Jul). "Spillway and Outlet Works, East Branch Reservoir, Clarion River, Pennsylvania; Hydraulic Model Investigation," TM No. 2-325, Vicksburg, Miss.
64. US Army Engineer Waterways Experiment Station. 1958 (Apr). "Prototype Spillway Crest Pressures, Chief Joseph Dam, Columbia River, Washington," MP No. 2-266, Vicksburg, Miss.
65. US Army Engineer Waterways Experiment Station. 1959 (Apr). "Spillway and Outlet Works, Townshend Dam and Reservoir, West River, Vermont; Hydraulic Model Investigation," TR No. 2-498, Vicksburg, Miss.
66. US Army Engineer Waterways Experiment Station. 1961 (Jun). "Carlyle Dam, Kaskaskia River, Illinois; Hydraulic Model Investigation," TR No. 2-568, Vicksburg, Miss.
67. US Army Engineer Waterways Experiment Station. 1961 (Jul). "Eufaula Dam Spillway, Canadian River, Oklahoma; Hydraulic Model Investigation," TR No. 2-575, Vicksburg, Miss.
68. US Army Engineer Waterways Experiment Station. 1961 (Jul). "Prototype Tests of Spillway Crest, Table Rock Dam" (unpublished data), Vicksburg, Miss.
69. US Army Engineer Waterways Experiment Station. 1962 (Nov). "Spillway for John Redmond Dam, Grand (Neosho) River, Kansas; Hydraulic Model Investigation," TR No. 2-611, Vicksburg, Miss.
70. US Army Engineer Waterways Experiment Station. 1963 (Oct). "Discharge Rating Curves for Vertical Lift Gates on Spillway Crests," MP No. 2-606, Vicksburg, Miss.
71. US Army Engineer Waterways Experiment Station. 1964 (Feb). "An Investigation of Spillway Bucket and Toe Curve Pressures," MP No. 2-625, Vicksburg, Miss.
72. US Army Engineer Waterways Experiment Station. 1970 (Dec). "Spillway for Kaw Dam, Arkansas River, Oklahoma; Hydraulic Model Investigation," TR H-70-14, Vicksburg, Miss.
73. US Army Engineer Waterways Experiment Station. 1972 (Dec). "Spillway for Oakley Dam, Sanzamon River, Illinois; Appendix A: Type 2 (Revised) Spillway; Hydraulic Model Investigation," TR H-70-13, Vicksburg, Miss.
74. US Army Engineer Waterways Experiment Station. 1984. Shore Protection Manual (in 2 vols), Coastal Engineering Research Center, Vicksburg, Miss.
75. US Bureau of Reclamation. 1938. "Model Studies of Spillways; Boulder Canyon Project," Final Reports, Part VI, Bulletin 1, Denver, Colo.

76. US Bureau of Reclamation. 1948. "Studies of Crests for Overfall Dams; Boulder Canyon Project," Final Reports, Part VI, Bulletin 3, Denver, Cola.
77. US Bureau of Reclamation. 1977. "Design of Small Dams," 2nd Ed., US Government Printing Office, Washington, D. C.

APPENDIX B

NOTATION

Symbol	Term	Units
A	One-half the horizontal axis of an ellipse Area	$\frac{ft^2}{ft}$
B	One-half the vertical axis of an ellipse	ft
C	Discharge coefficient Chezy's resistance coefficient	-- --
C_D	Baffle drag coefficient	--
d	Depth of flow	ft
d_1	Depth of flow at entrance to energy dissipator	ft
d_2	Hydraulic jump sequent flow depth	ft
d_3	Depth of flow above top of stilling basin end sill	ft
d_{TW}	Depth of tailwater	ft
d_P	Potential flow depth	ft
D	Conduit diameter	ft
E	Specific energy	ft
f	Darcy-Weisbach's resistance coefficient	--
F	Froude number	--
F_1	Froude number of entering flow	--
g	Acceleration due to gravity	ft/sec ²
G_o	Gate opening	ft
h	Height of stilling basin baffle Height of flip bucket lip	ft ft
h_b	Roller height	ft
h_e	Velocity head at flip bucket lip	ft
u_f	Energy loss due to friction	ft-lb/lb

Symbol	Term	Units
h_p	Horsepower Pressure head against the boundary of a flip bucket	ft-lb/set ft
h_s	Height of stilling basin end sill	ft
h_T	Height of reservoir surface above a location on the spillway surface	ft
h_1	Difference in reservoir and bucket invert elevations	ft
h_2	Tailwater height	ft
h_{min}	Minimum height of flip bucket lip	ft
H	Total energy head Distance from reservoir surface to center of gate opening height	ft ft
H_c	Head relative to the energy grade line at the exit portal of two-way drop inlet spillway Maximum head on the spillway weir crest for which the gate controls discharge	ft ft
H_d	Spillway crest design head	ft
H_e	Total specific energy above spillway crest Velocity head	ft ft
H_L	Spillway energy loss	ft
H_O	Reference head	ft
H_s	Spillway height, crest elevation minus stilling basin apron elevation	ft
H_T	Total head	ft
H_V	Vapor head of water	ft
k and k_s	Effective roughness height	ft
K	Spillway crest shape coefficient Stilling basin length coefficient	-- a-
K_a	Spillway abutment contraction coefficient	--
K_c	Conduit friction loss coefficient for two-way drop inlet spillway	--

Symbol	Term	Units
K_e	Entrance loss coefficient for two-way drop inlet spillway	--
K_o	Outlet velocity head loss coefficient for two-way drop inlet spillway	--
K_p	Spillway pier contraction coefficient	--
K_T	Total loss coefficient for two-way drop inlet spillway	--
L	Net length of spillway crest	ft
	Length along spillway from start of the crest curve	ft
	Crest length for two-way drop inlet spillway	ft
L_b	Length of stilling basin	ft
L_e	Effective length of spillway crest	ft
L_j	Length of hydraulic jump	ft
L_T	Length of tangent from the spillway tangent point to the spillway toe	ft
M	Maximum unit moment	--
n	Number of spillway piers	--
	Manning's resistance coefficient	$\text{sec/ft}^{1/3}$
	Spillway crest shape coefficient	--
p	Pressure	lb/ft^2
P	Absolute pressure	lb/ft^2
	Depth of spillway approach channel below the spillway crest	ft
P_B	Hydrostatic pressure exerted on stilling basin baffle unit width	lb/ft
P_L	Minimum distance from gate face to pier nose	ft
P_S	Hydrostatic pressure exerted on stilling basin end sill unit width	ft
P_T	Theoretical unit load on flip bucket surface	lb/ft^2
P_1	Hydrostatic pressure exerted by a unit width of flow entering a stilling basin	lb/ft

<u>Symbol</u>	<u>Term</u>	<u>Units</u>
P_3	Hydrostatic pressure exerted by a unit width of flow exiting a stilling basin	lb/ft
q	Unit width rate of discharge	ft ³ /sec/ft
Q	Rate of discharge	ft ³ /sec
r	Flip bucket radius	ft
r_{min}	Roller bucket minimum radius	ft
R	Hydraulic radius Average unit resultant force acting on stilling basin sidewall	ft lb
R_a	Adjusted average resultant unit force acting on stilling basin sidewall	lb/ft
R_e	Reynolds number	
R_m	Average minimum static plus dynamic unit force at toe of hydraulic jump	lbf/ft
R_s	Static unit force on stilling basin sidewall resulting from the sequent depth of the hydraulic jump	lb/ft
R_{a+}	Adjusted maximum resultant instantaneous unit force acting on stilling basin sidewall	lb/ft
R_{a-}	Adjusted minimum resultant unit force acting on stilling basin sidewall	lb/ft
R_+	Maximum instantaneous resultant unit force acting on stilling basin sidewall	lb/ft
R	Minimum instantaneous resultant unit force acting on stilling basin sidewall	lb/ft
s	Slope Slope of energy gradient	ft/ft ft/ft
S	Slope of the spillway chute adjacent to the bucket	ft/ft
u	Potential flow velocity	ft/sec
v	Mean velocity	ft/sec

Symbol	Term	Units
V_B	Mean velocity at face of a stilling basin baffle	ft/sec
V_S	Velocity of surface flow	ft/sec
V_1	Mean velocity at entrance to energy dissipation	ft/sec
W_b	Width of spillway gatebay	ft
W_B	Width of stilling basin baffle	ft
X	Distance parallel to the horizontal coordinate	ft
X_H	Horizontal distance from flip bucket lip to jet impact location	ft
Y	Distance parallel to the vertical coordinate	ft
	Distance from stilling basin apron to resultant of unit force acting on basin wall	ft
Y_1	Flow depth normal to channel bottom	ft
	Vertical distance from flip bucket lip to jet impact location	ft
z	Distance from downstream end of pier to wave and spillway wall intersection	ft
Z	Height above a datum plane	ft
α	Energy correction coefficient	--
	Angle of pier end wave	degrees
	Flare angle	degrees
	Angle of rotation from start of flip bucket curve	degrees
α_T	Total deflection angle from start of flip bucket to the lip	degrees
β	Tainter gate opening angle (see Plate 6-1)	degrees
γ	Specific weight of water	lb/ft ³
δ	Turbulent boundary layer thickness	ft
δ_1	Displacement thickness	ft
δ_3	Energy thickness	ft
ΔE	Energy loss resulting from a hydraulic jump	ft
ΔL	Change in spillway chute length	ft

<u>Symbol</u>	<u>Term</u>	<u>Units</u>
ΔW	Change in spillway chute width	ft
θ	Slope of channel invert	ft/ft
	Interior angle between spillway face at a location and the horizontal	degrees
	Jet trajectory angle at the lip of a flip bucket	degrees
θ'	Jet trajectory impact angle	degrees
ν	Kinematic viscosity of water	ft ² /sec
ρ	Mass density of water	lb-sec ² /ft ⁴
σ	Cavitation index	--
ϕ	Angle between horizontal and flip bucket lip	degrees
	Angle between the horizontal and the floor at the beginning of the trajectory	degrees

APPENDIX C

PLATES

<u>Plate No.</u>	<u>Title</u>	<u>Paragraphs in Which Plate is Mentioned</u>
2-1	Open Channel Flow Resistance Coefficients	2-10b
2-2	Unit Horsepower in Stilling Basins	2-12b
2-3	Hydraulic Jump Velocity Distribution	2-13
2-4	Force Acting on Stilling Basin Sidewall	2-14
2-5	Stilling Basin Force Moment Arm	2-14
2-6	Cavitation Characteristics Square Edge Offset into Flow	2-16
2-7	Cavitation Characteristics Offsets Away from Flow	2-16
2-8	Cavitation Characteristics Rounded Corners into Flow	2-16
2-9	Cavitation Characteristics Into Flow Chamfers	2-16
3-1	Weir Profiles Downstream from Crest Line	3-3a
3-2	Elliptical Crest Spillway Coordinates Coordinate Coefficients	3-3a,d
3-3	Elliptical Crest Spillway Discharge Coefficients 1:1 Upstream Face	3-4a
3-4	Elliptical Crest Spillway Discharge Coefficients Vertical Upstream Face	3-4a
3-5	Submerged Crest Coefficients Overflow Crests	3-4b
3-6	High Gated Overflow Crests Pier Contraction Coefficients I	3-6, 3-10
3-7	High Gated Overflow Crests Pier Contraction Coefficients II	3-6

16 Jan 90

<u>Plate No.</u>	<u>Title</u>	<u>Paragraphs in Which Plate is Mentioned</u>
3-8	High Gated Overflow Crests Pier Contraction Coefficients III	3-6
3-9	Low Gated Ogee Crests Pier Contraction Coefficients	3-6
3-10	Elliptical Crest Spillway Pier Contraction Coefficients Type 3-Pier	3-6
3-11	Overflow Spillway Crest with Adjacent Concrete Sections Abutment Contraction Coefficient	3-6, 3-8a, 3-8c
3-12	Overflow Spillway Crest with Adjacent Embankment Sections Abutment Contraction Coefficient	3-6, 3-8b
3-13	Elliptical Crest Spillway Cavitation Safety Curves With Piers	3-9
3-14	Elliptical Crest Spillway Cavitation Safety Curves No Piers	3-9
3-15	Overflow Spillway Crest Upper Nappe Profiles Without Piers	3-12a
3-16	Overflow Spillway Crest Upper Nappe Profiles Center Line of Pier Bay	3-12a
3-17	Overflow Spillway Crest Upper Nappe Profiles Along Piers	3-12a
3-18	Water Surface Profiles Controlled Crest $P/H_d = 1.0$	3-12b
3-19	Water Surface Profiles Controlled Crest $P/H_d = 0.50$	3-12b
3-20	Water Surface Profiles Controlled Crest $P/H_d = 0.25$	3-12b

<u>Plate No.</u>	<u>Title</u>	<u>Paragraphs in Which Plate is Mentioned</u>
4-1	Air Entrainment	4-2c
5-1	Side Channel Spillways	5-1
5-2	Side Channel Spillways L-Shaped Crests Effective Length	5-2
5-3	Morning-Glory Spillways	5-9
5-4	Labyrinth Weir Spillway	5-10
5-5	Box Inlet Drop Spillway	5-11a
5-6	Elevated Box Drop Spillway	5-11b
5-7	Box Inlet Drop Spillway Calibration Curves	5-11b
5-8	Box Inlet Drop Spillway Chute Width vs Discharge	5-11b
6-1	Tainter Gates on Spillway Crests Discharge Coefficients	6-2c
6-2	Tainter Gates on Spillway Crests Effect of Gate Seat Location on Crest Pressures for $H_e = 1.00H_d$	6-2d
6-3	Tainter Gates on Spillway Crests Effect of Gate Seat Location on Crest Pressures for $H_e = 1.3H$	6-2d
6-4	Vertical Lift Gates on Spillways Discharge Coefficients	6-3c
7-1	Sloping Floor Stilling Basins Continuous Slope Length of Hydraulic Jump	7-6
7-2	Sloping Floor Stilling Basins Noncontinuous Slope Jump Length on Slope	7-6
7-3	Standard-Shape Baffle	7-7b
7-4	Baffle Height and Location	7-7c, 7-7d

EM 1110-2-1603
16 Jan 90

<u>Plate No.</u>	<u>Title</u>	<u>Paragraphs in Which Plate is Mentioned</u>
7-5	Roller Bucket Maximum Tailwater Depth	7-14
7-6	Roller Bucket Minimum Tailwater Depth	7-14
7-7	High Overflow Dams Bucket-Type Energy Dissipator Roller Depth	7-14
7-8	High Overflow Dams Bucket-Type Energy Dissipator Surge Height	7-14
7-9	Little Goose Dam Slotted Bucket	7-15
7-10	Flip Bucket Pressure	7-21
7-11	Impact Basin	7-24
7-12	(Proposed) Libby Reregulating Dam Baffled Chute Spillway	7-25

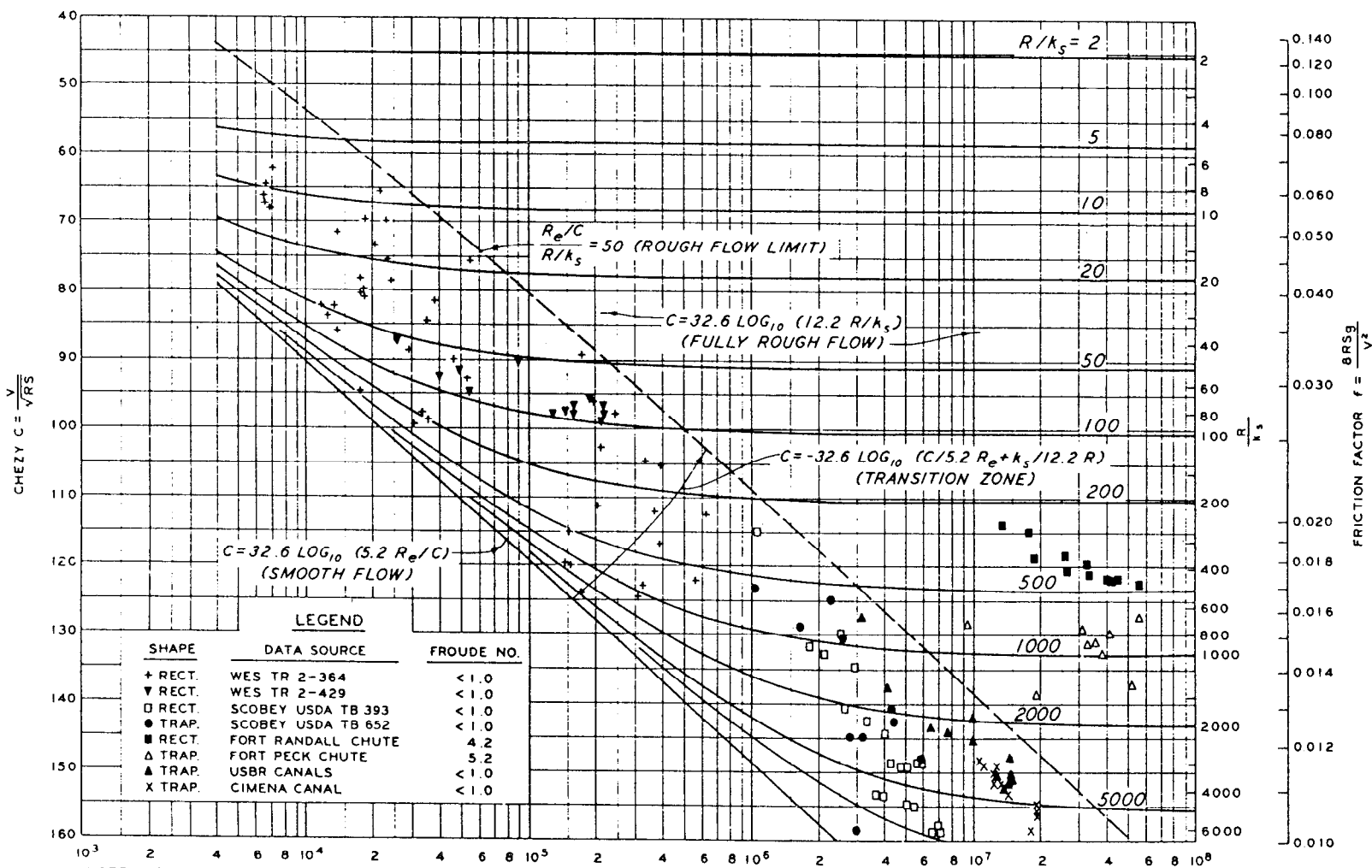

NOTE: R = HYDRAULIC RADIUS, FT
 g = ACCELERATION OF GRAVITY, FT/SEC²
 ν = KINEMATIC VISCOSITY, FT²/SEC
 k_s = EFFECTIVE ROUGHNESS HEIGHT, FT
 V = VELOCITY, FT/SEC
 S = ENERGY GRADIENT SLOPE
 Re = REYNOLDS NUMBER

OPEN CHANNEL FLOW
 RESISTANCE COEFFICIENTS
 FROM HDC 631

PLATE 2-1

EM 1110-2-1603
 16 Jan 90

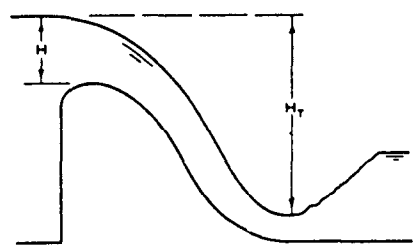
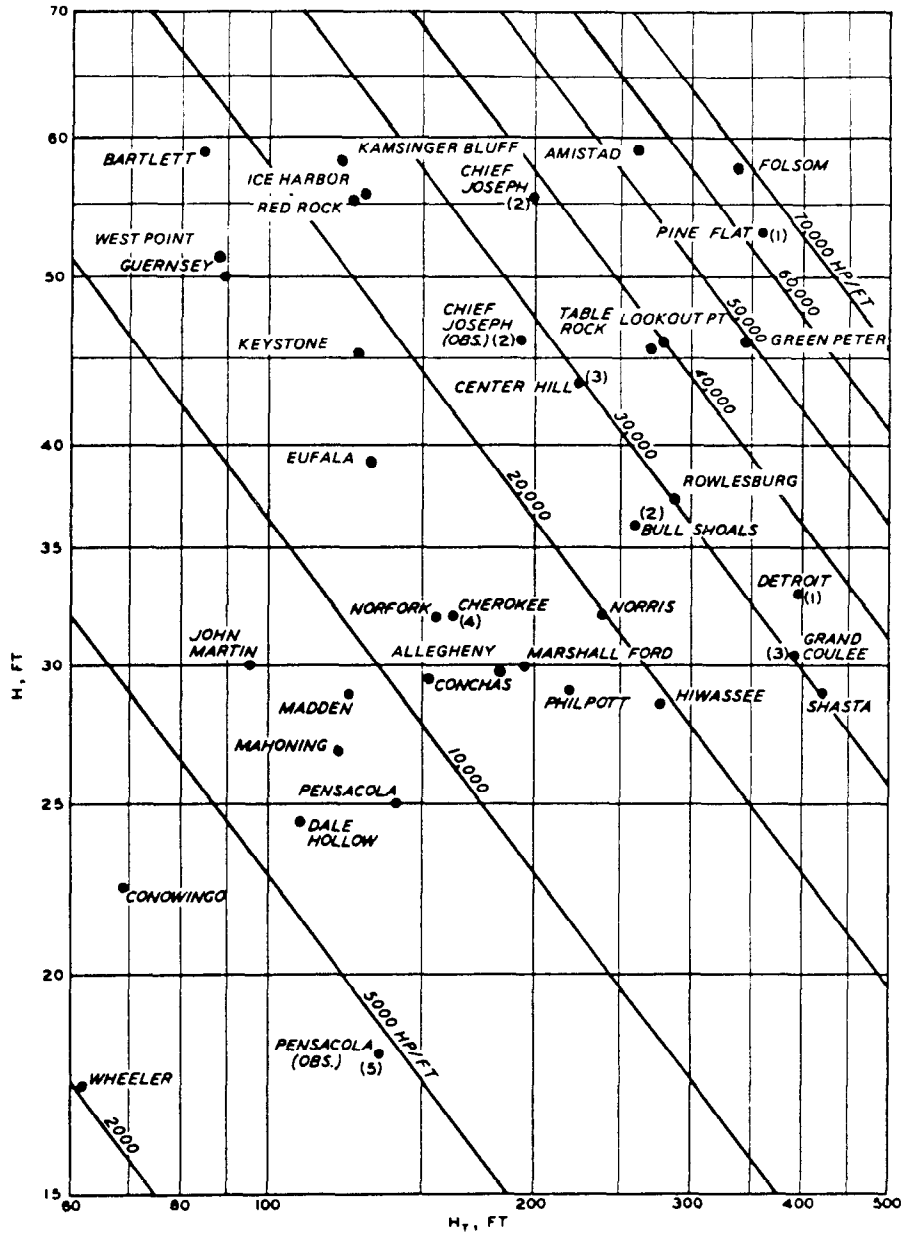

DEFINITION SKETCH

- (1) NO HEAVY FLOWS OBSERVED
- (2) SEVERE BASIN DAMAGE (REF 31 & 32)
- (3) SEVERE BUCKET DAMAGE (REF 30 & 32)
- (4) BASIN DAMAGE
- (5) SEVERE EROSION DOWNSTREAM FROM APRON

$$\frac{HP}{FT} = \frac{8.9 H_T}{550} = \frac{CH^2 H_T}{6.6}$$

UNIT HORSEPOWER IN STILLING BASINS

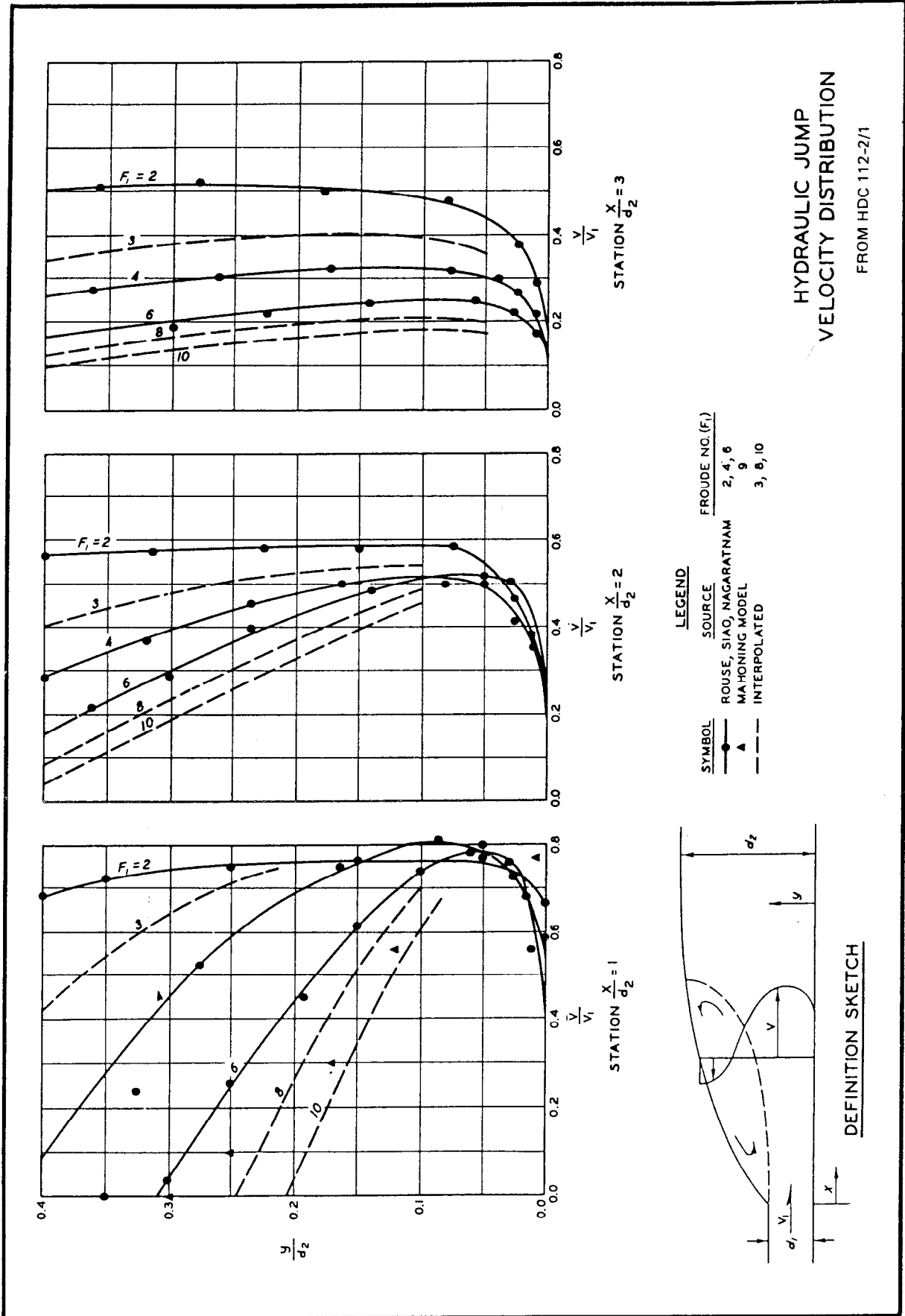

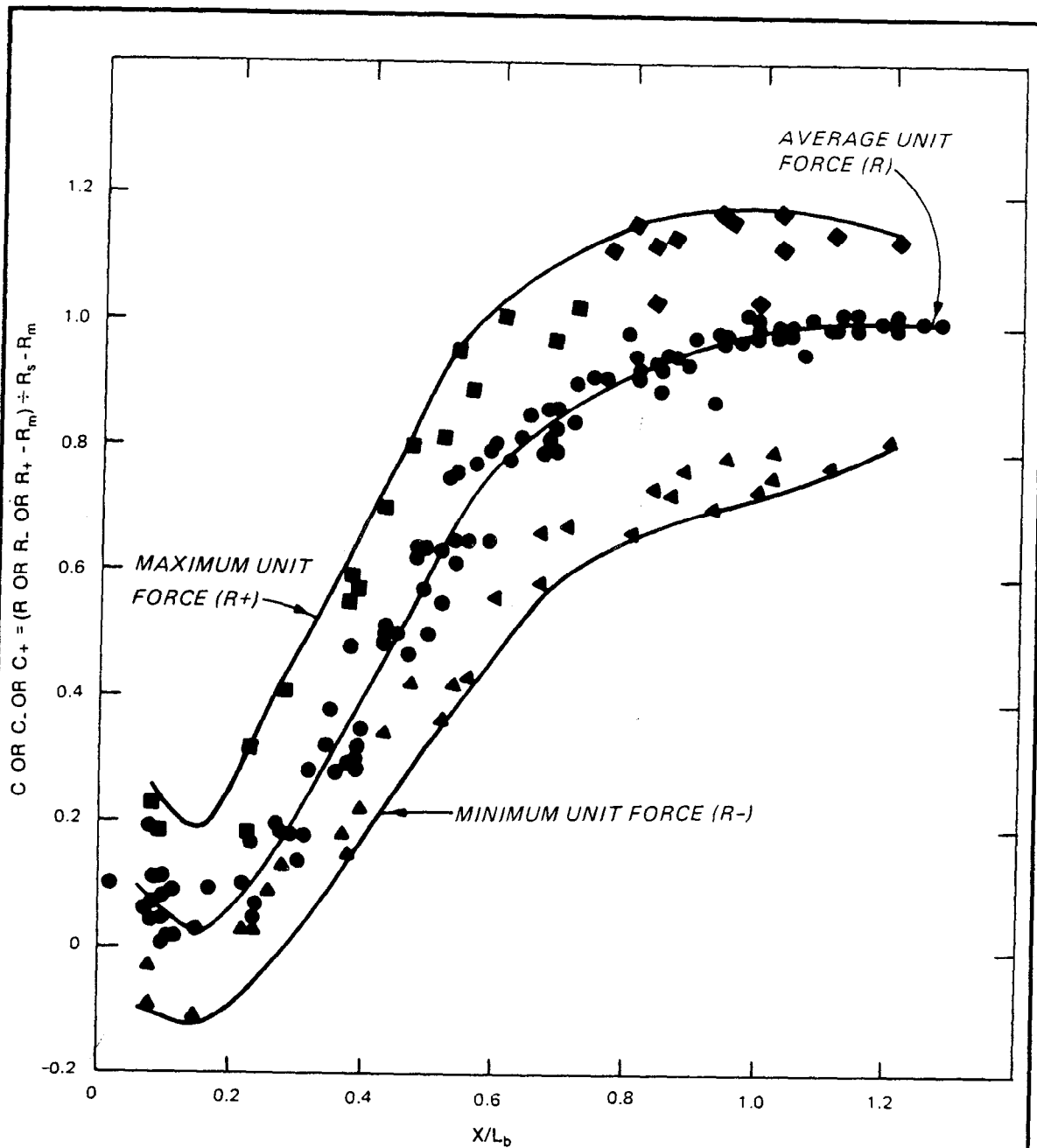

VARIATION IN UNIT RESULTANT FORCE WITH DISTANCE FROM PI WHEN TAILWATER DEPTH IS EQUAL TO OR LESS THAN THE THEORETICAL SEQUENT DEPTH AND WALL HEIGHT'

FORCE ACTING ON STILLING BASIN SIDEWALL

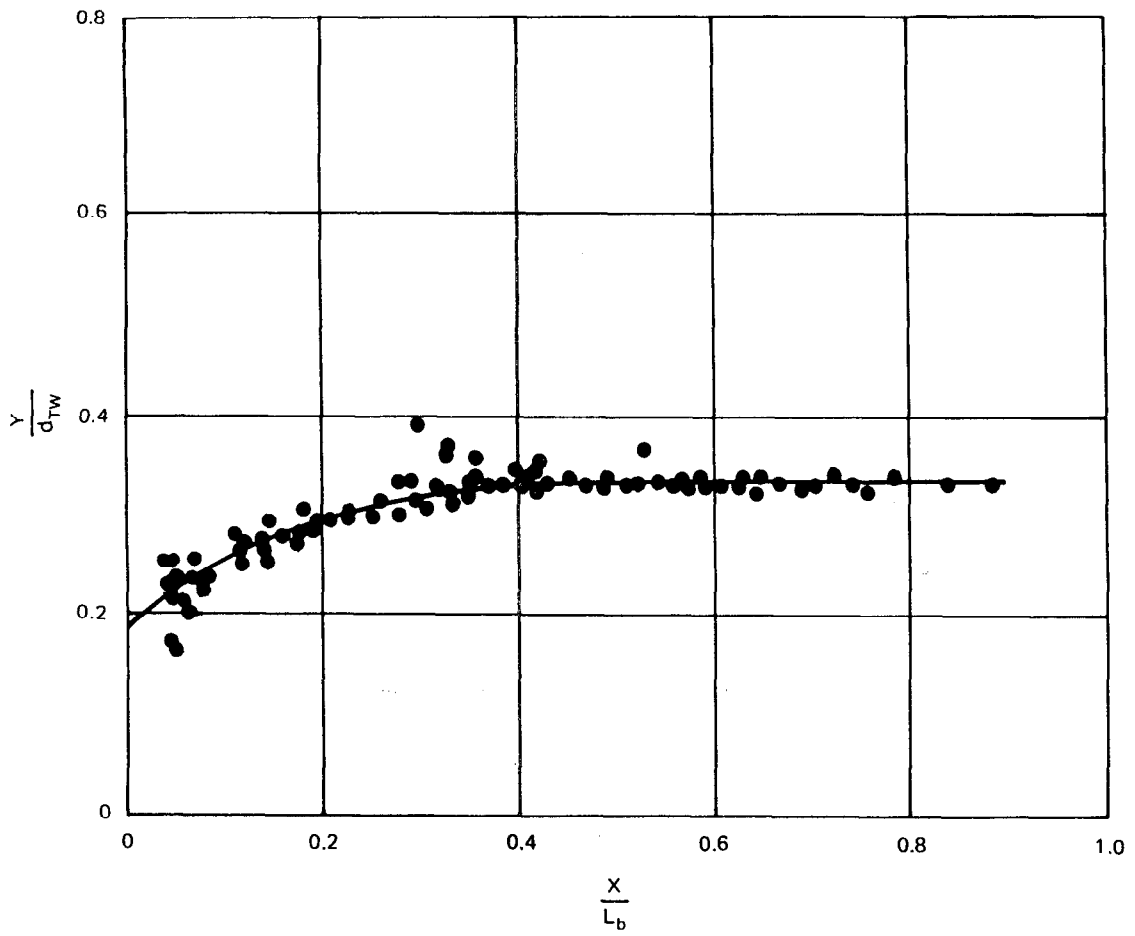

MOMENT ARM VS DISTANCE FROM PI
 STILLING BASIN FORCE
 MOMENT ARM

PLATE 2-5

EM 1110-2-1603
 16 Jan 90

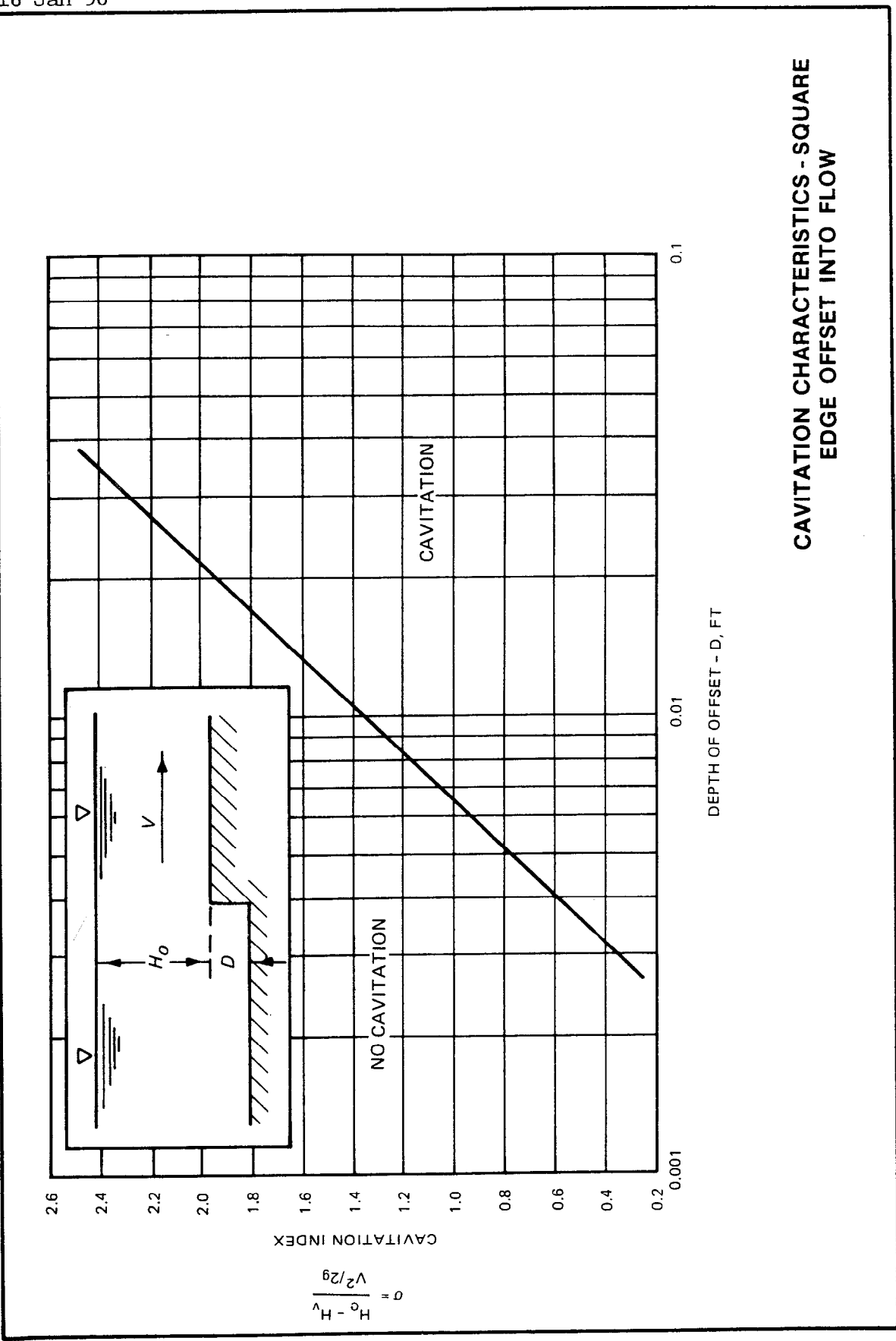

CAVITATION CHARACTERISTICS - SQUARE
 EDGE OFFSET INTO FLOW

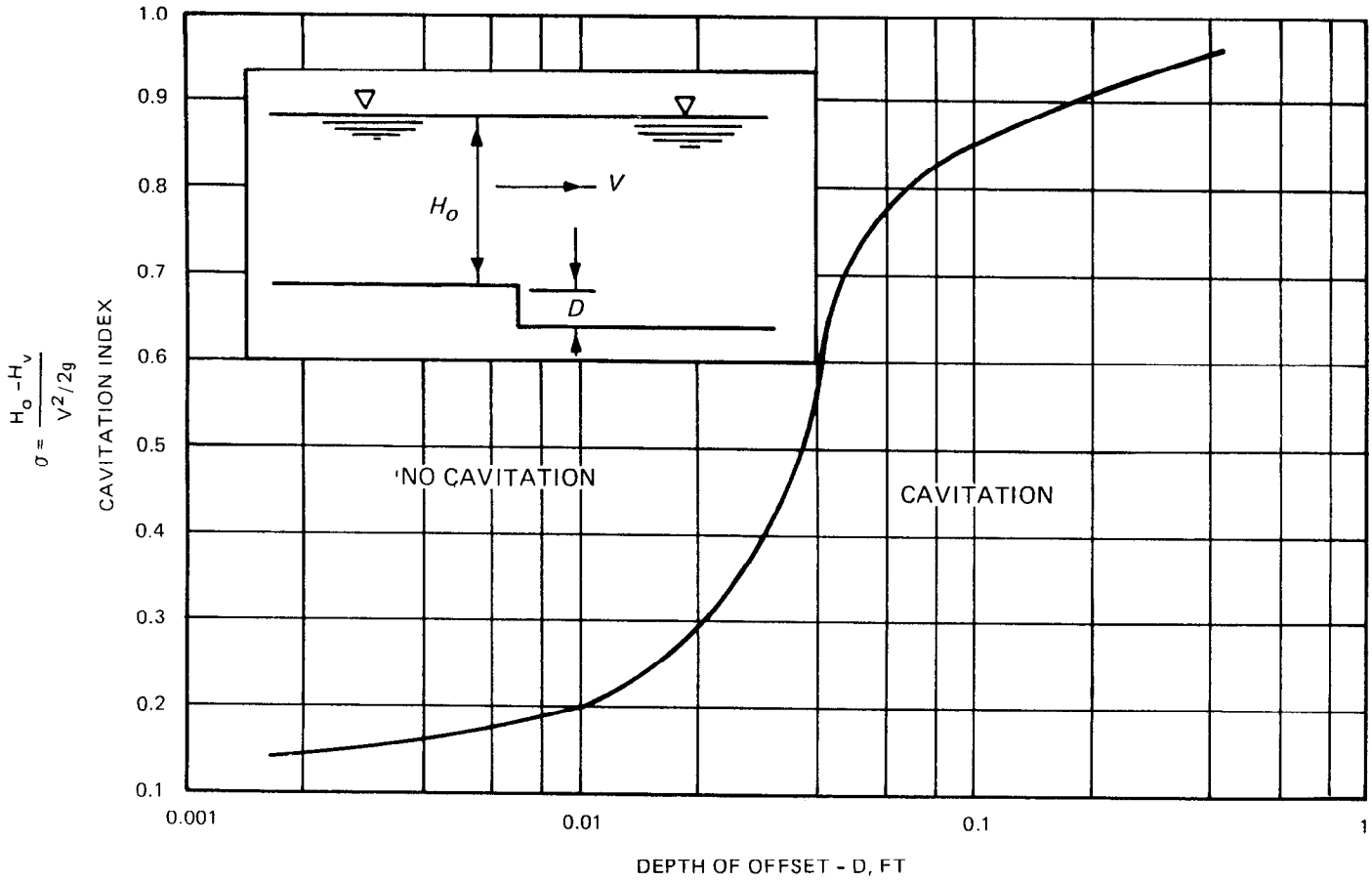

CAVITATION CHARACTERISTICS - OFFSETS AWAY FROM FLOW

PLATE 2-7

EM 1110-2-1603
16 Jan 90

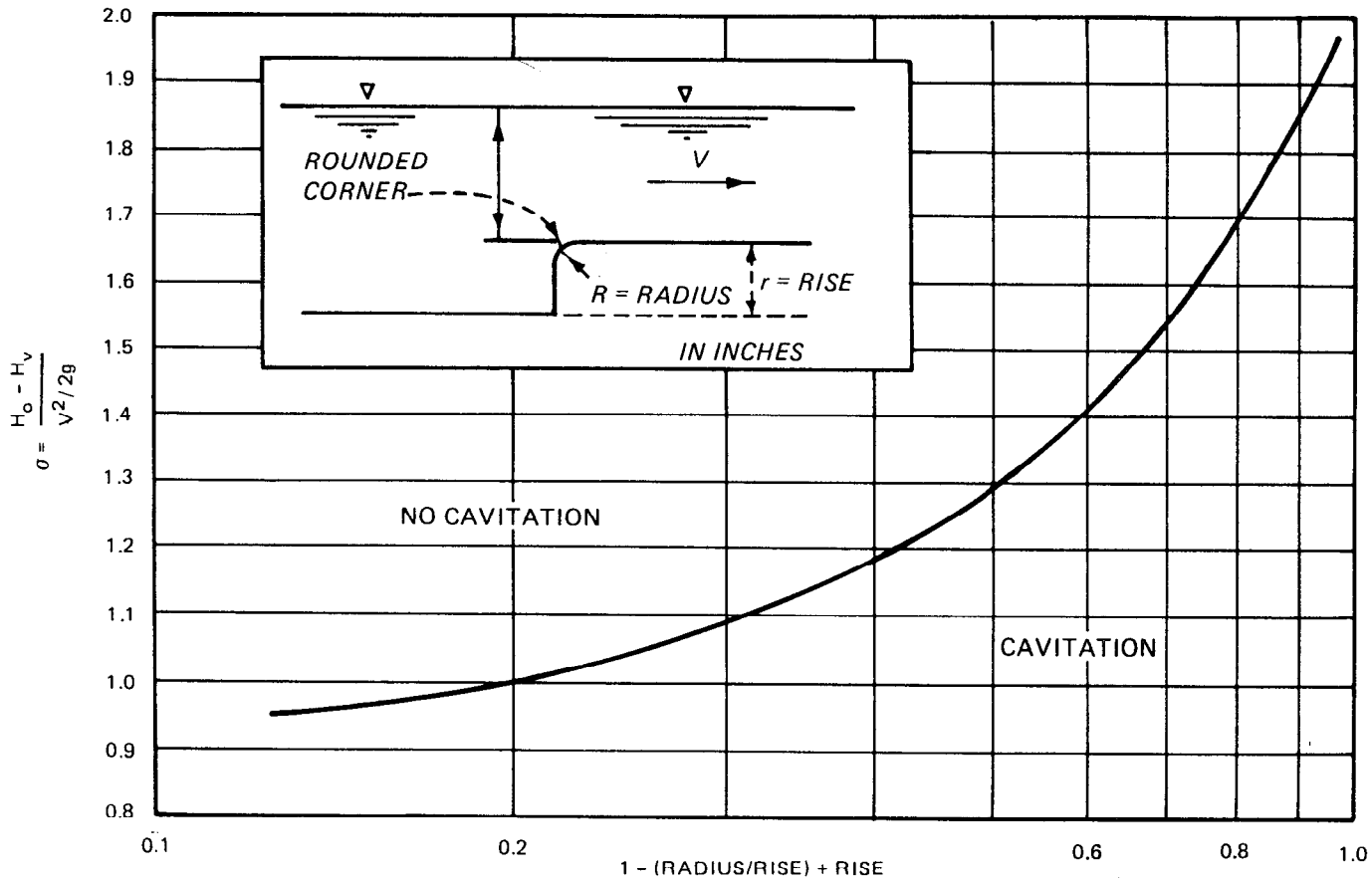

CAVITATION CHARACTERISTICS - ROUNDED CORNERS INTO FLOW

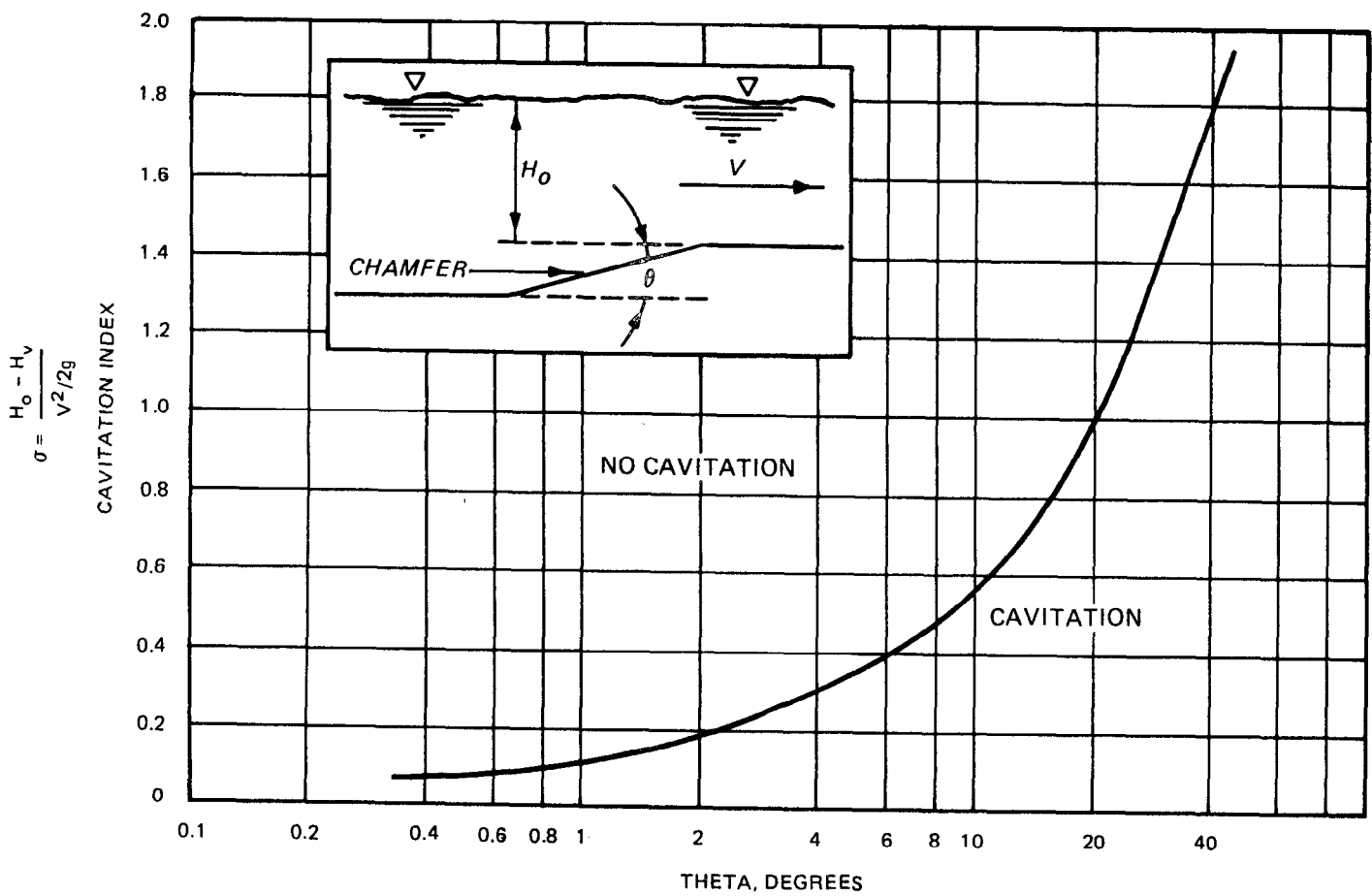

CAVITATION CHARACTERISTICS - INTO FLOW CHAMFERS

PLATE 2-9

EM 1110-2-1603
16 Jan 90

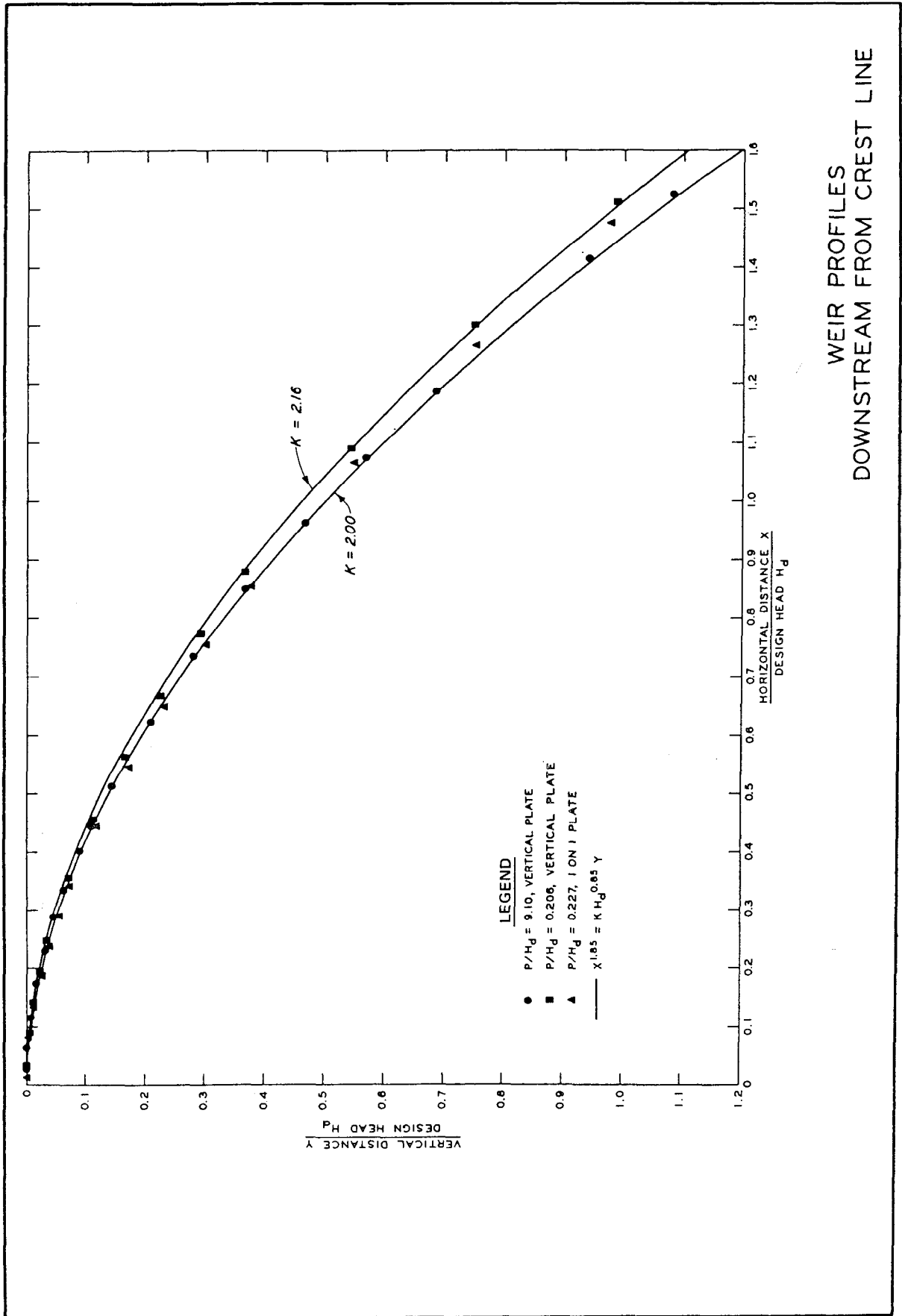

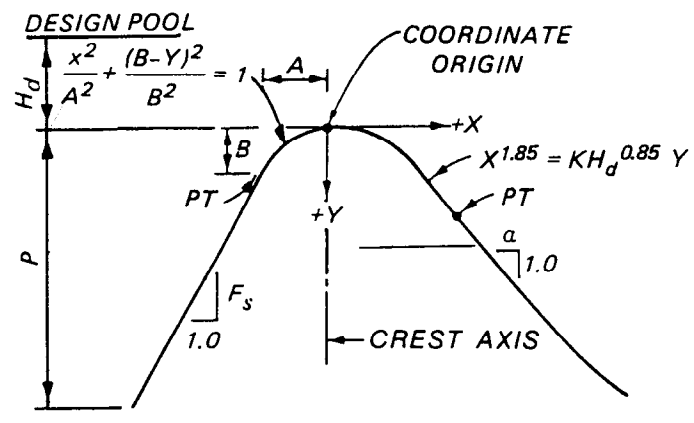
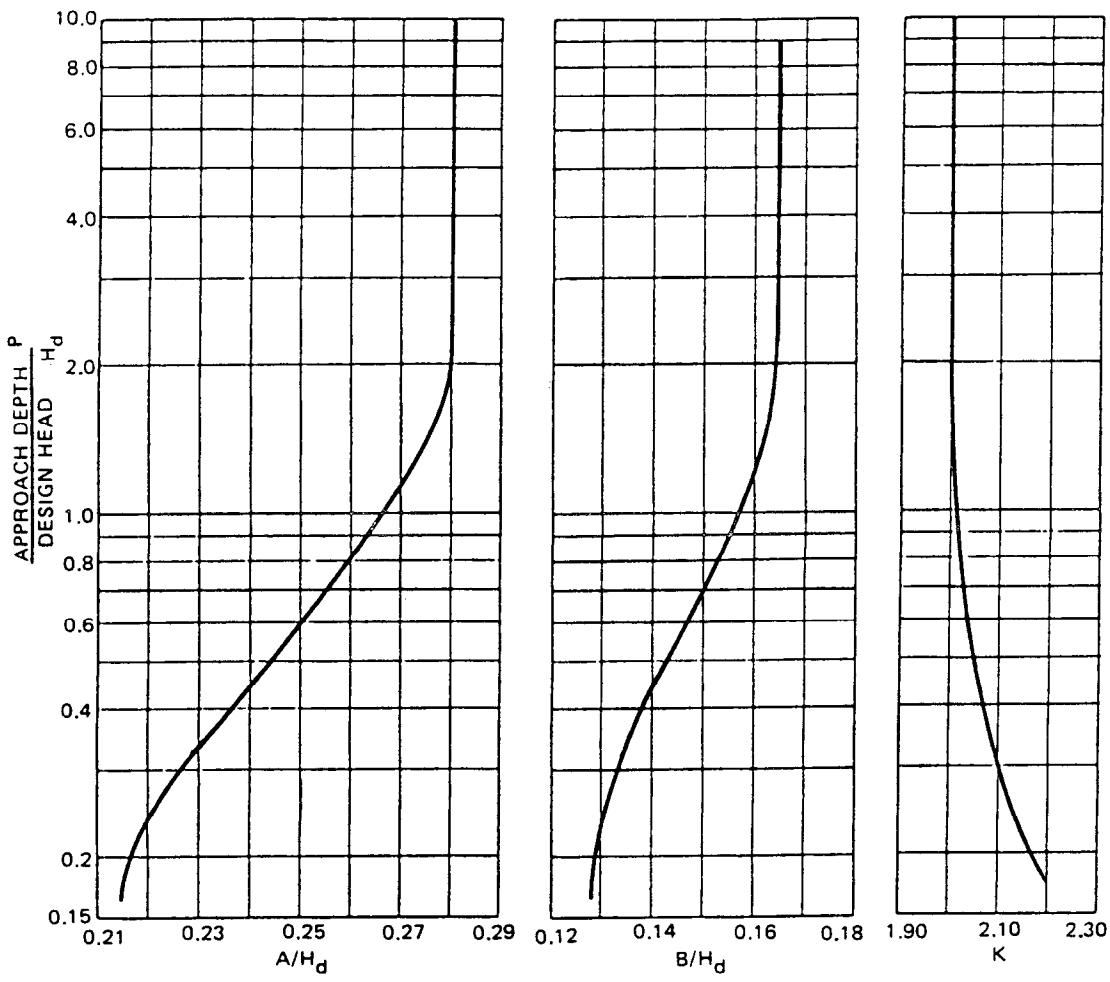

DEFINITION SKETCH

ELLIPTICAL CREST SPILLWAY
 COORDINATES
 COORDINATE COEFFICIENTS
 FROM HDC 111-20

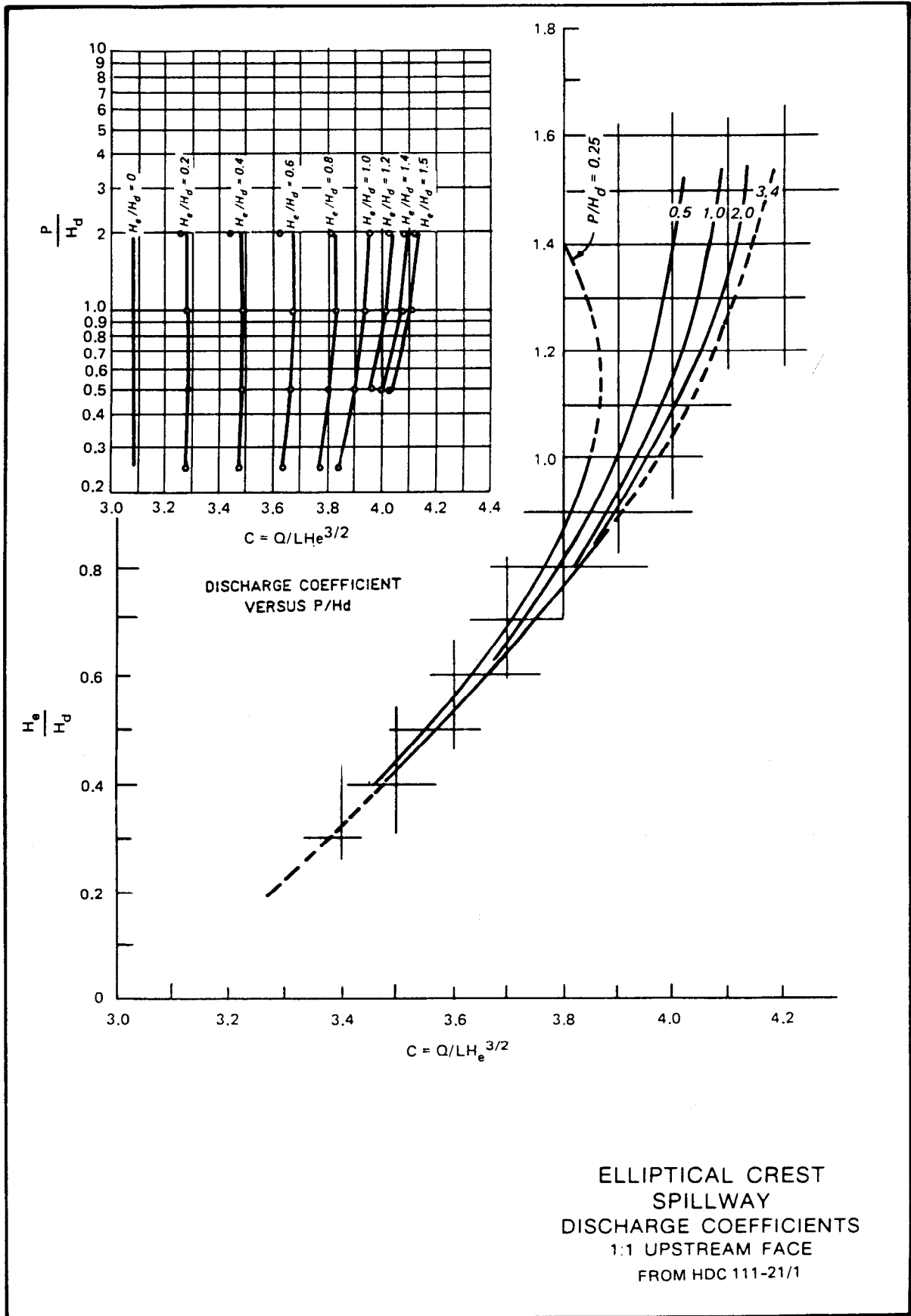

ELLIPTICAL CREST
SPILLWAY
DISCHARGE COEFFICIENTS
1:1 UPSTREAM FACE
FROM HDC 111-21/1

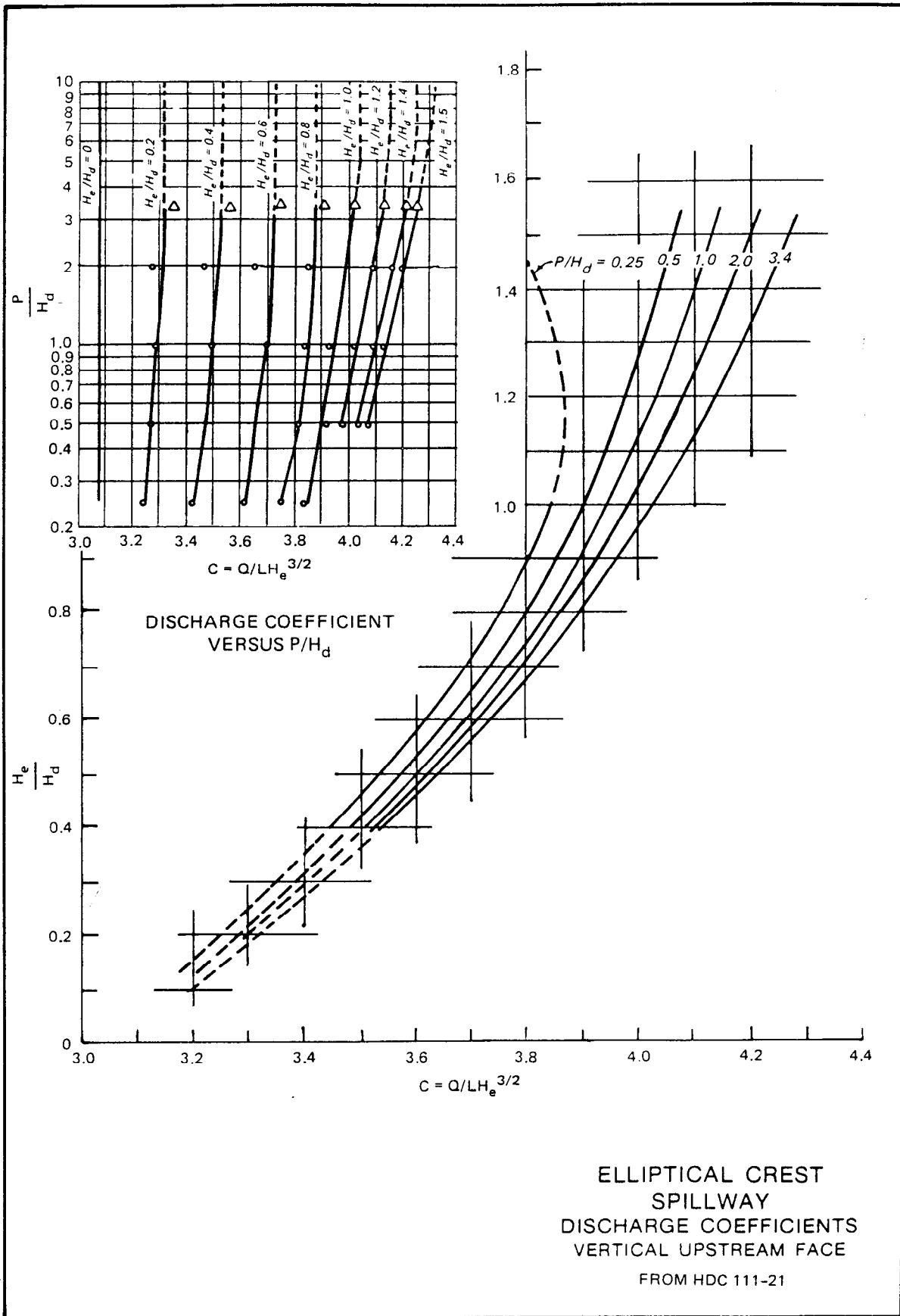

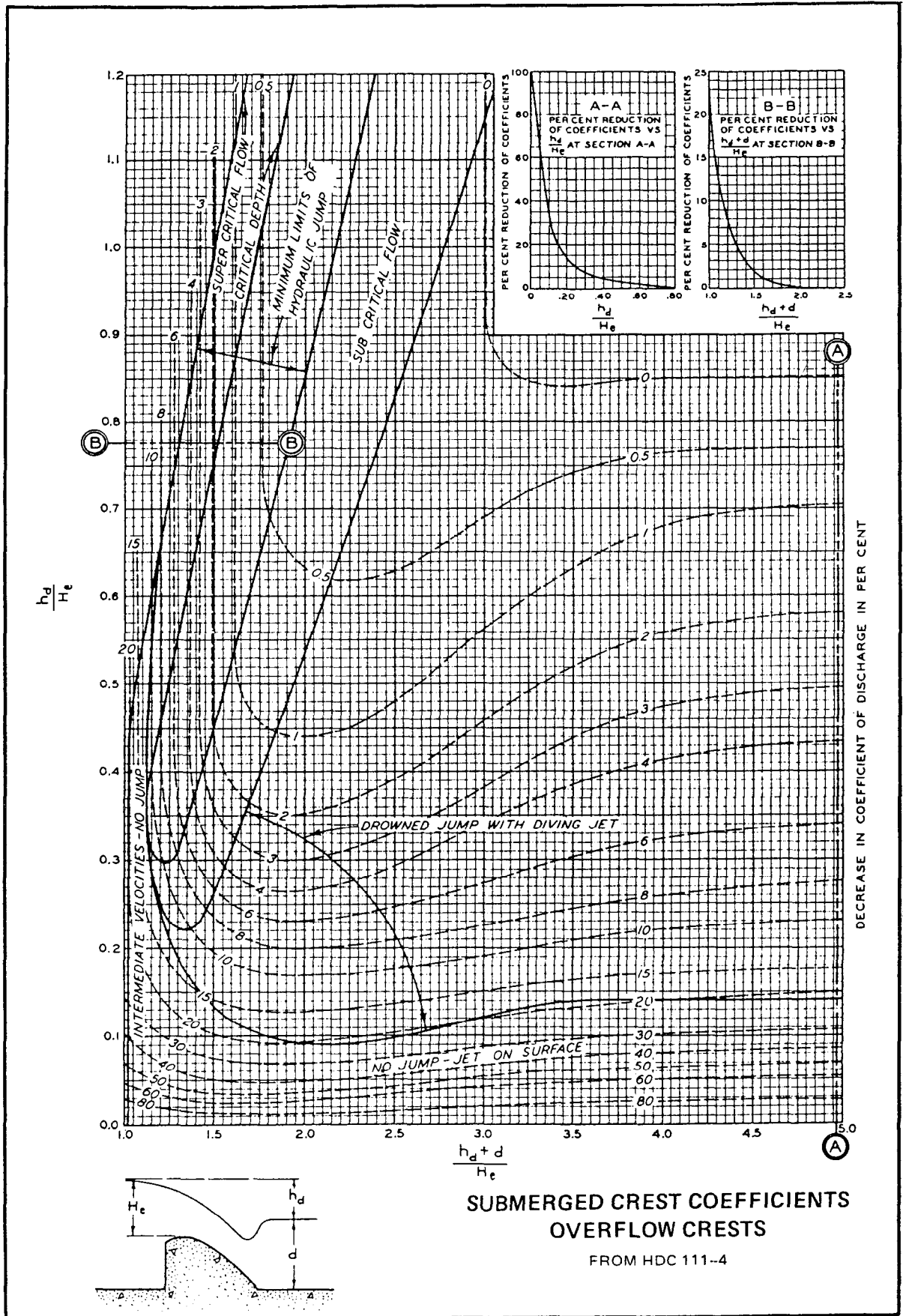

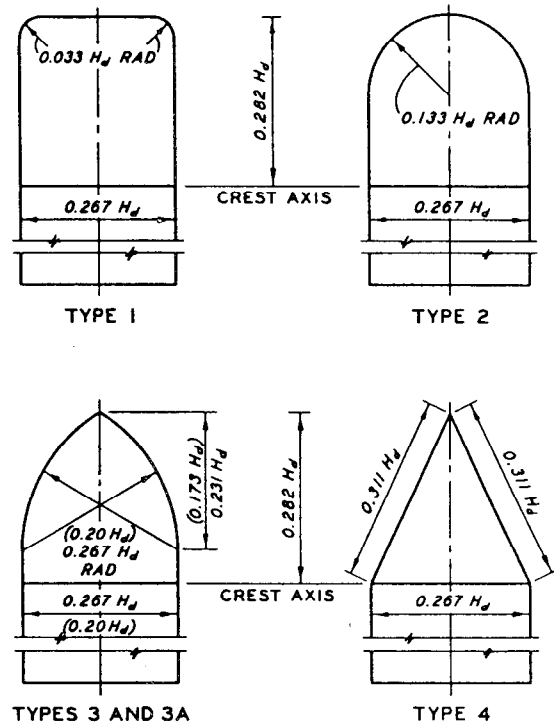
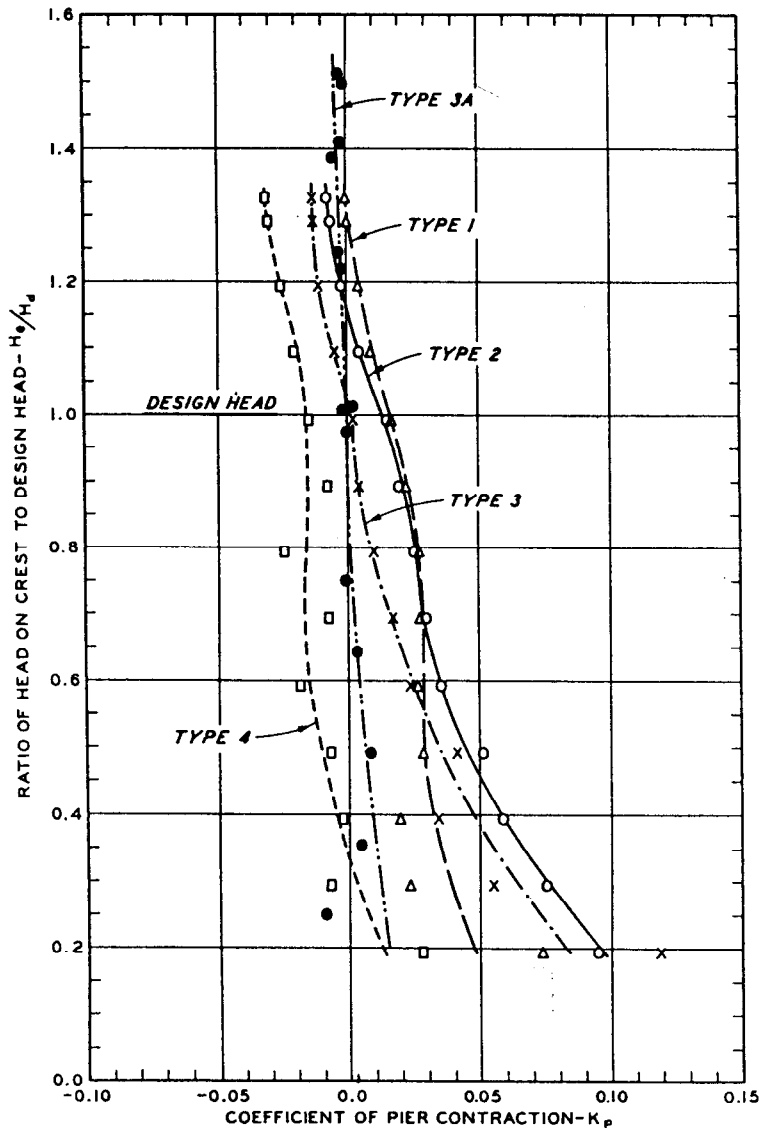

PIER NOSE SHAPES

NOTE: PIER NOSE LOCATED IN SAME PLANE AS UPSTREAM FACE OF SPILLWAY. DIMENSIONS IN PARENTHESES ARE FOR TYPE 3A.

**HIGH GATED OVERFLOW CRESTS
PIER CONTRACTION COEFFICIENTS I**

FROM HDC 111-5

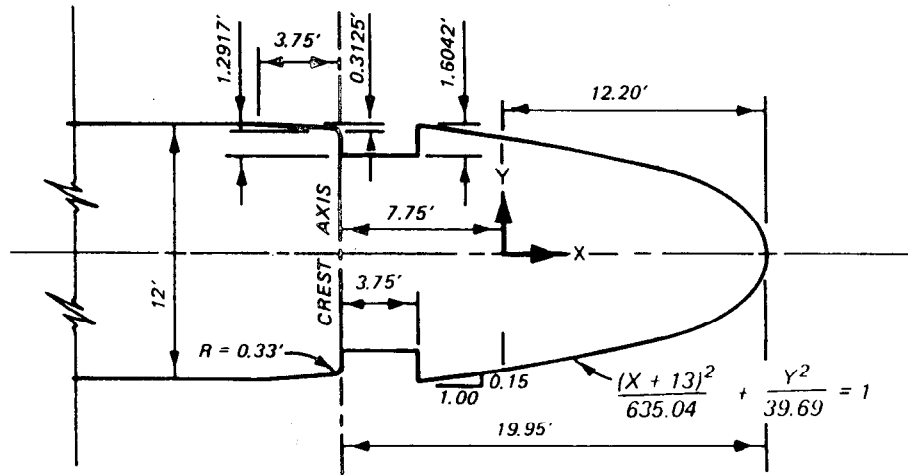
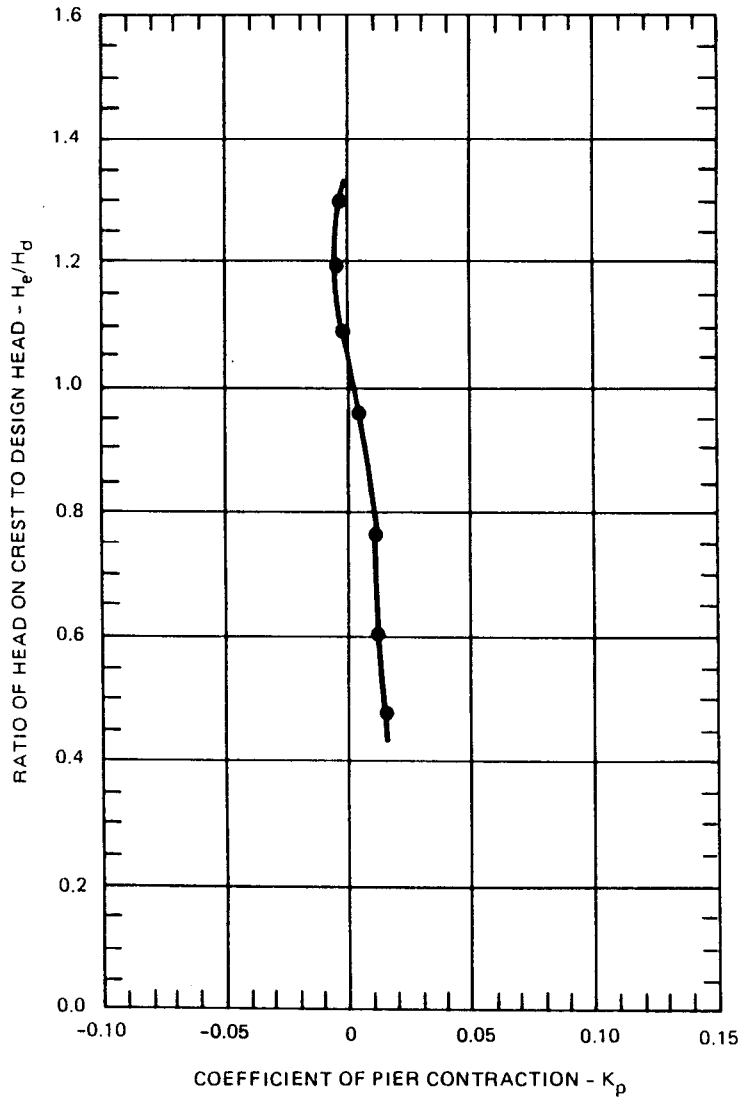

PIER NOSE SHAPES

NOTE: PIER NOSE LOCATED IN SAME PLANE AS UPSTREAM FACE OF SPILLWAY.

REFERENCE JOHN DAY DAM (ITEM 33)
HIGH GATED OVERFLOW CRESTS
PIER CONTRACTION COEFFICIENTS II

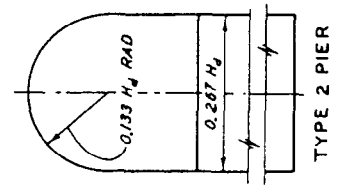
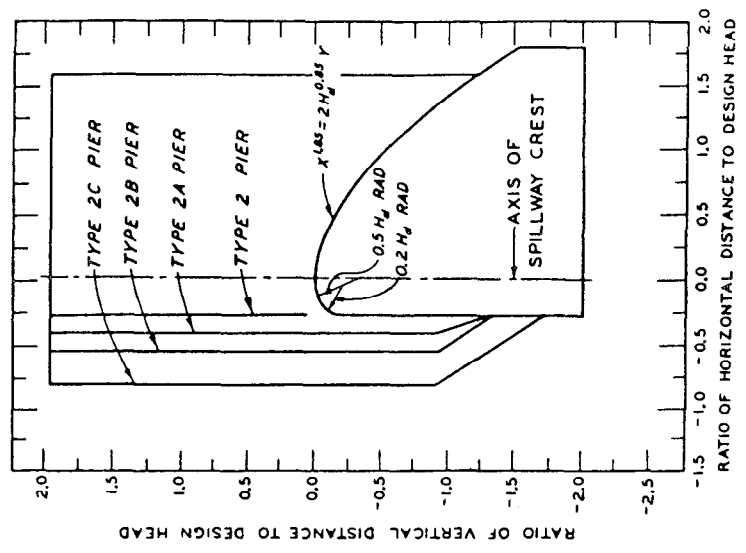
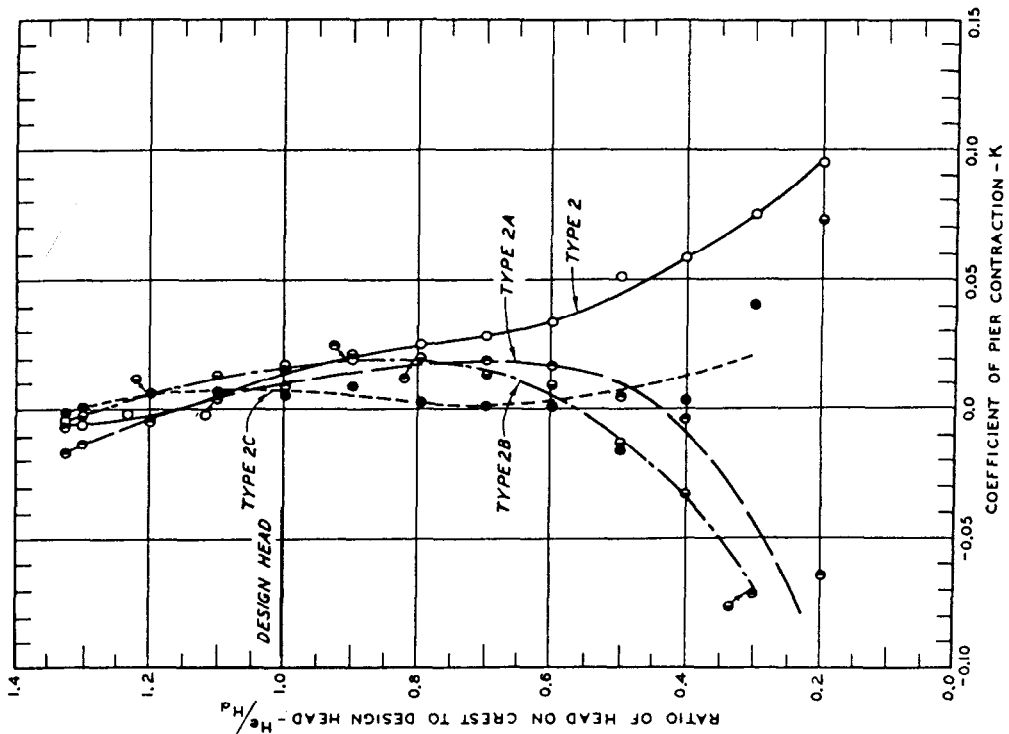

HIGH GATED OVERFLOW CRESTS
PIER CONTRACTION COEFFICIENTS III

FROM HDC 111-6

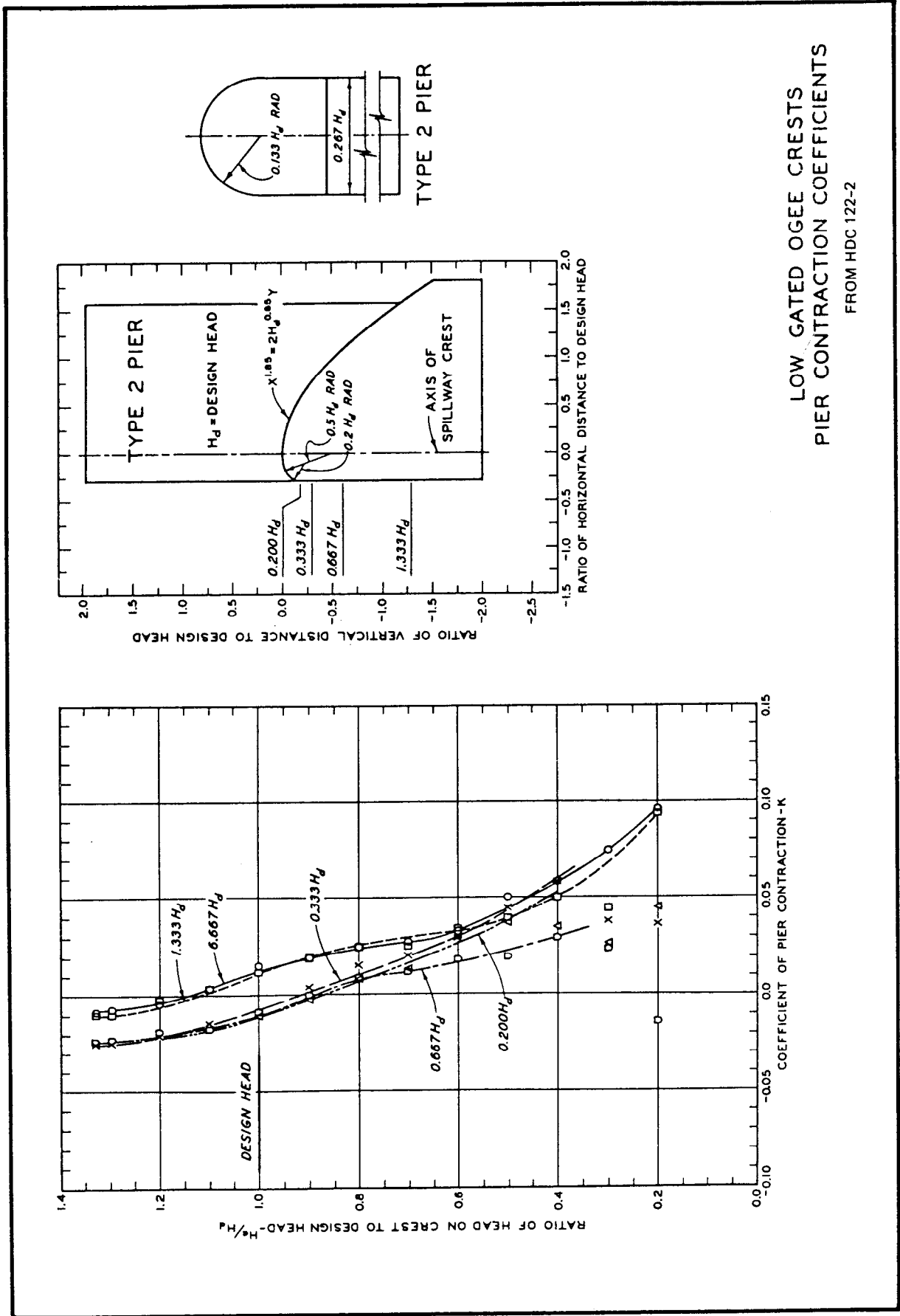

LOW GATED Ogee Crests
PIER CONTRACTION COEFFICIENTS

FROM HDC 122-2

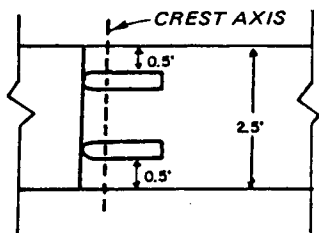
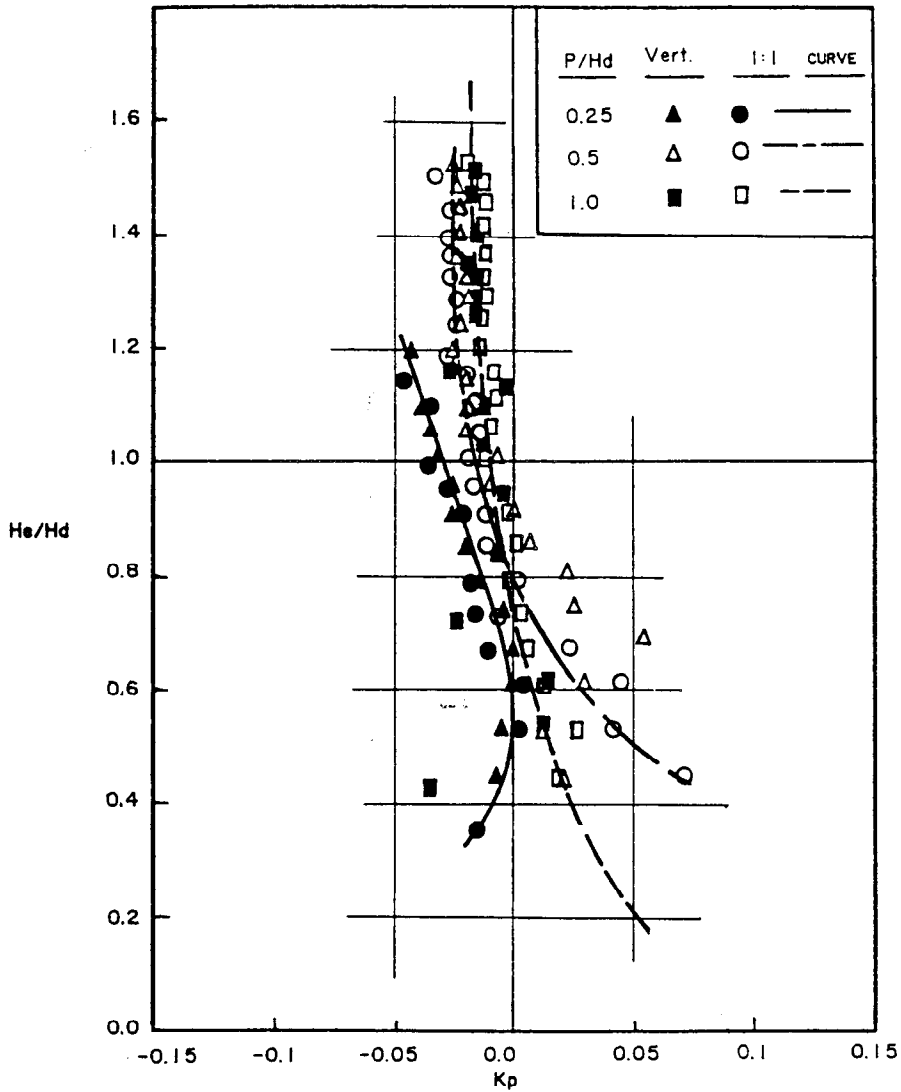

DEFINITION SKETCH
 TYPE 3 PIERS
 SEE PLATE 3-6

**ELLIPTICAL CREST
 SPILLWAY**
 PIER CONTRACTION COEFFICIENTS
 TYPE 3 PIER
 FROM HDC 111-22

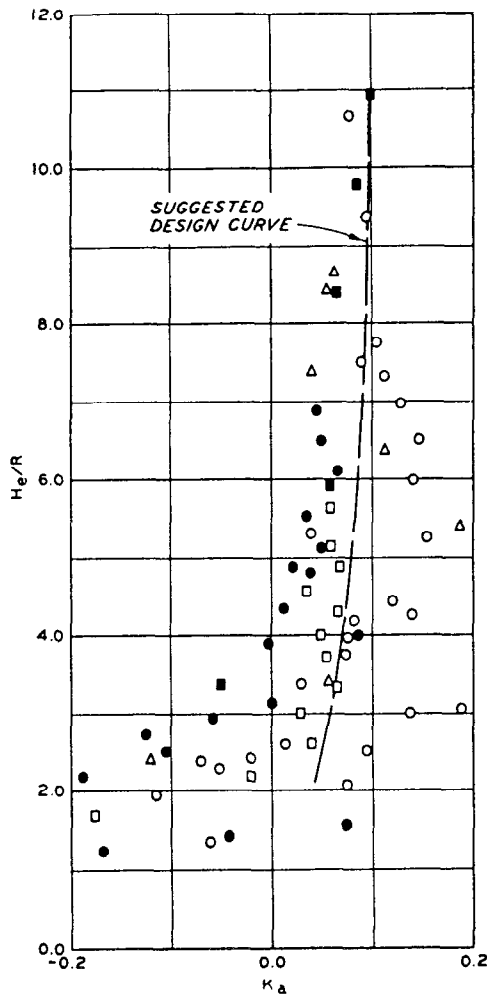

BASIC EQUATION

$$Q = C[L' - 2(NK_p + K_a)H_e]H_e^{3/2}$$

WHERE:

- Q = DISCHARGE, CFS.
- C = DISCHARGE COEFFICIENT.
- L' = NET LENGTH OF CREST, FT.
- N = NUMBER OF PIERS.
- K_p = PIER CONTRACTION COEFFICIENT.
- K_a = ABUTMENT CONTRACTION COEFFICIENT.
- H_e = TOTAL HEAD ON CREST, FT.

LEGEND

SYMBOL	PROJECT	R	W/L	W/H
○	CW 801	4	1.55	0.96
●	FOLSOM	8	2.10	3.77
□	PHILPOTT	5	2.67	1.42
■	PINE FLAT*	4	2.12	1.77
△	CENTER HILL*	5	3.83	9.48

*GATED SPILLWAY WITH PIERS

NOTE: R = RADIUS OF ABUTMENT, FT.
 W = WIDTH OF APPROACH REPRODUCED IN MODEL, FT.
 L = GROSS WIDTH OF SPILLWAY, FT.
 H = DEPTH OF APPROACH IN MODEL, FT.

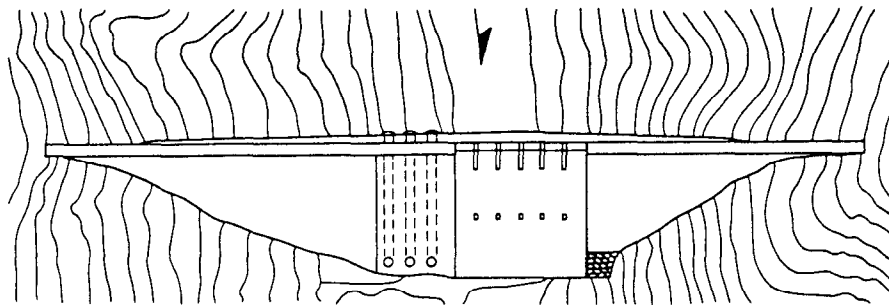

OVERFLOW SPILLWAY CREST WITH ADJACENT CONCRETE SECTIONS

ABUTMENT CONTRACTION COEFFICIENT

FROM HDC 111-3/1

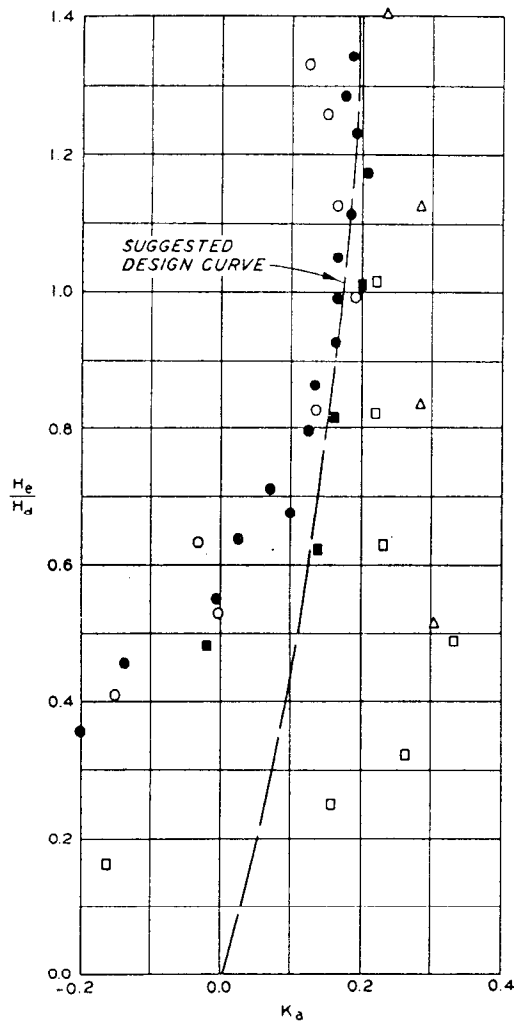

BASIC EQUATION

$$Q = C[L' - 2(NK_p + K_a)H_e]H_e^{3/2}$$

WHERE:

- Q = DISCHARGE, CFS
- C = DISCHARGE COEFFICIENT
- L' = NET LENGTH OF CREST, FT
- N = NUMBER OF PIERS
- K_p = PIER CONTRACTION COEFFICIENT
- K_a = ABUTMENT CONTRACTION COEFFICIENT
- H_e = ENERGY HEAD ON CREST, FT

LEGEND

SYMBOL	PROJECT	R	W/L	W/H
□	DORENA	2	5.60	10.7
■	DORENA	4	5.60	10.7
○	RED ROCK *	7.8	3.42	16.5
●	CARLYLE *	9	8.44	75.5
△	WALTER F. GEORGE *	4	5.44	55.3

*GATED SPILLWAY WITH PIERS

NOTE: R = RADIUS OF ABUTMENT, FT
W = WIDTH OF APPROACH REPRODUCED IN MODEL, FT
L = GROSS WIDTH OF SPILLWAY, FT
H = DEPTH OF APPROACH IN MODEL, FT
H_d = DESIGN HEAD ON CREST, FT

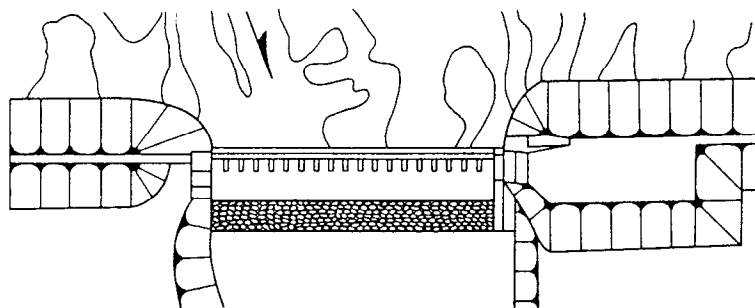

**OVERFLOW SPILLWAY CREST WITH
ADJACENT EMBANKMENT SECTIONS
ABUTMENT CONTRACTION COEFFICIENT**

FROM HDC 111-3/2

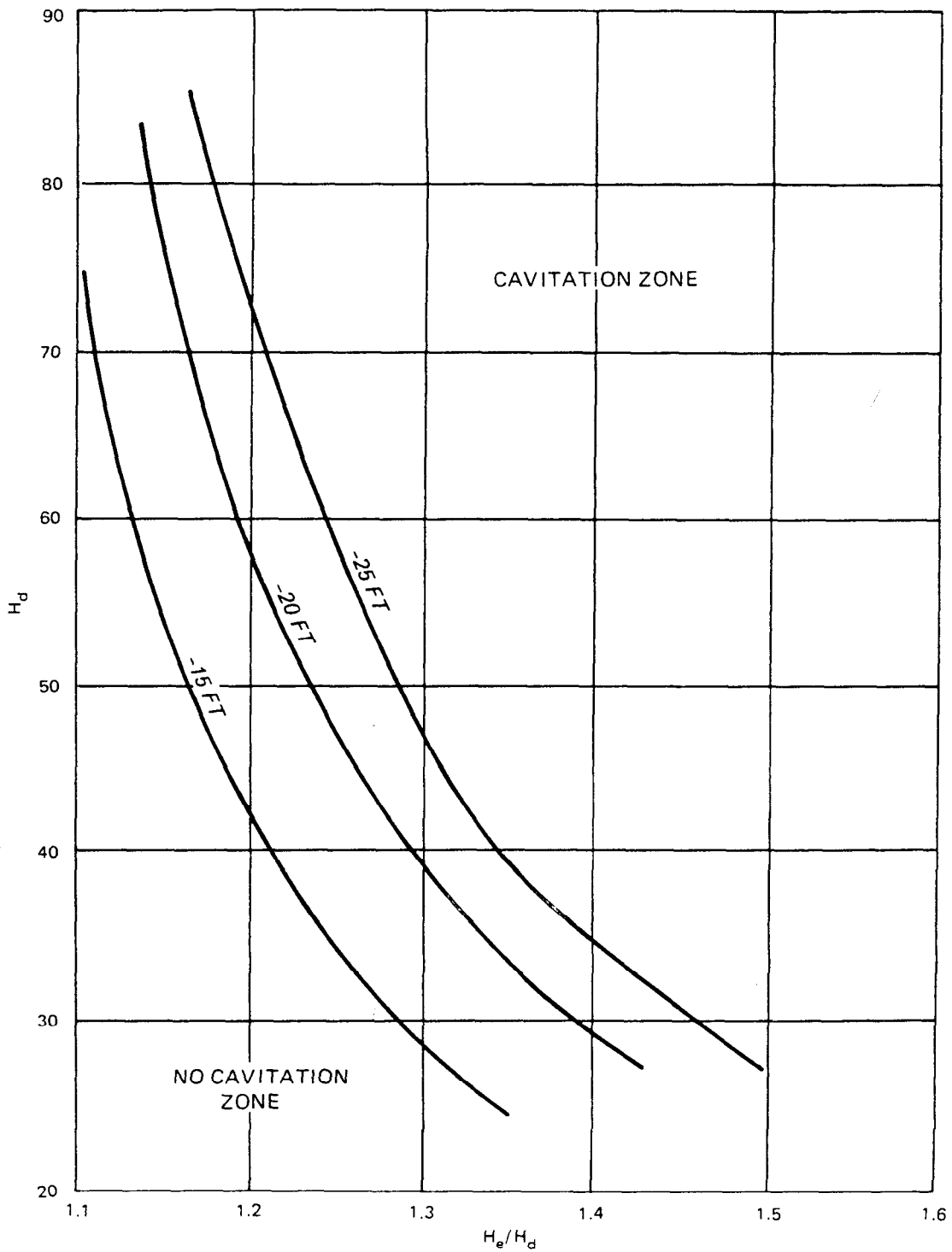

NOTE: H_d = DESIGN TOTAL HEAD, FT
 H_e = ACTUAL TOTAL HEAD, FT

ELLIPTICAL CREST SPILLWAY
CAVITATION SAFETY CURVES
WITH PIERS
FROM HDC 111-25/1

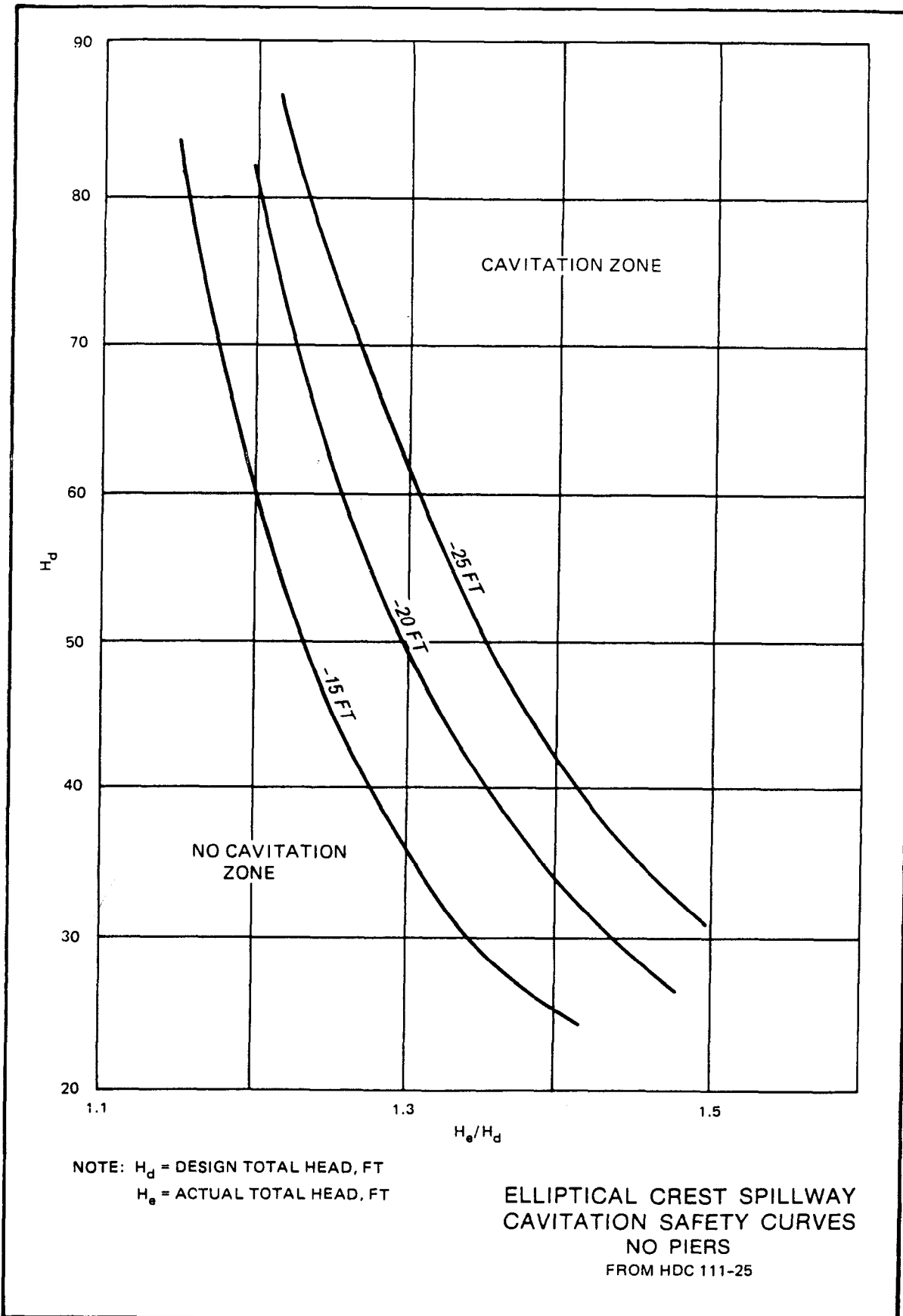

NOTE: H_d = DESIGN TOTAL HEAD, FT
 H_a = ACTUAL TOTAL HEAD, FT

ELLIPTICAL CREST SPILLWAY
CAVITATION SAFETY CURVES
NO PIERS
FROM HDC 111-25

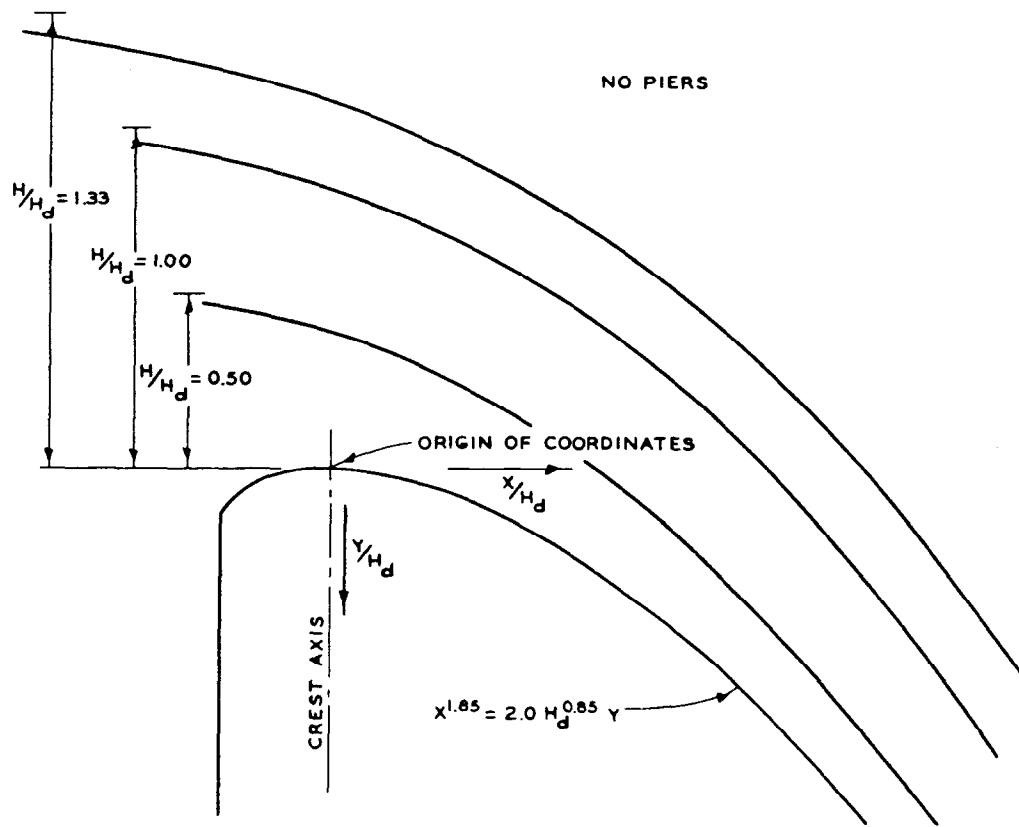

COORDINATES FOR UPPER NAPPE WITH NO PIERS*

$H/H_d = 0.50$		$H/H_d = 1.00$		$H/H_d = 1.33$	
X/H_d	Y/H_d	X/H_d	Y/H_d	X/H_d	Y/H_d
-1.0	-0.490	-1.0	-0.933	-1.0	-1.210
-0.8	-0.484	-0.8	-0.915	-0.8	-1.185
-0.6	-0.475	-0.6	-0.893	-0.6	-1.151
-0.4	-0.460	-0.4	-0.865	-0.4	-1.110
-0.2	-0.425	-0.2	-0.821	-0.2	-1.060
0.0	-0.371	0.0	-0.755	0.0	-1.000
0.2	-0.300	0.2	-0.681	0.2	-0.919
0.4	-0.200	0.4	-0.586	0.4	-0.821
0.6	-0.075	0.6	-0.465	0.6	-0.705
0.8	0.075	0.8	-0.320	0.8	-0.569
1.0	0.258	1.0	-0.145	1.0	-0.411
1.2	0.470	1.2	0.055	1.2	-0.220
1.4	0.705	1.4	0.294	1.4	-0.002
1.6	0.972	1.6	0.563	1.6	0.243
1.8	1.269	1.8	0.857	1.8	0.531

NOTE: $H = H_e$

OVERFLOW SPILLWAY CREST
UPPER NAPPE PROFILES
WITHOUT PIERS

FROM HDC 111-11

*BASED ON ES 801 TESTS FOR
NEGLECTIBLE VELOCITY OF APPROACH

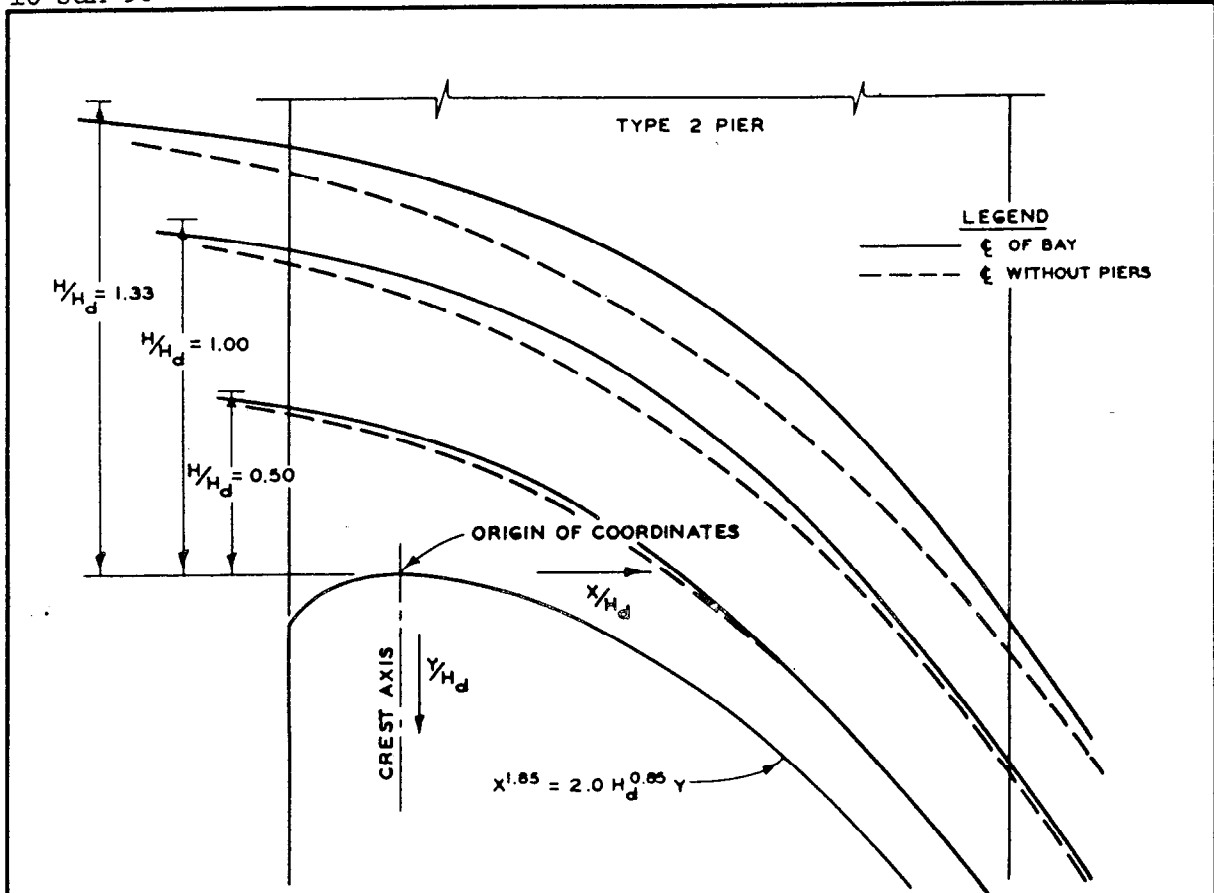

COORDINATES FOR UPPER NAPPE AT ζ OF BAY WITH TYPE 2 PIERS*

$H/H_d = 0.50$		$H/H_d = 1.00$		$H/H_d = 1.33$	
X/H_d	Y/H_d	X/H_d	Y/H_d	X/H_d	Y/H_d
-1.0	-0.482	-1.0	-0.941	-1.0	-1.230
-0.8	-0.480	-0.8	-0.932	-0.8	-1.215
-0.6	-0.472	-0.6	-0.913	-0.6	-1.194
-0.4	-0.457	-0.4	-0.890	-0.4	-1.165
-0.2	-0.431	-0.2	-0.855	-0.2	-1.122
0.0	-0.384	0.0	-0.805	0.0	-1.071
0.2	-0.313	0.2	-0.735	0.2	-1.015
0.4	-0.220	0.4	-0.647	0.4	-0.944
0.6	-0.088	0.6	-0.539	0.6	-0.847
0.8	0.075	0.8	-0.389	0.8	-0.725
1.0	0.257	1.0	-0.202	1.0	-0.564
1.2	0.462	1.2	0.015	1.2	-0.356
1.4	0.705	1.4	0.266	1.4	-0.102
1.6	0.977	1.6	0.521	1.6	0.172
1.8	1.278	1.8	0.860	1.8	0.465

NOTE: $H = H_e$

OVERFLOW SPILLWAY CREST
UPPER NAPPE PROFILES
CENTER LINE OF PIER BAY

*BASED ON CW 801 TESTS FOR
NEGLECTIBLE VELOCITY OF APPROACH

FROM HDC 111-12

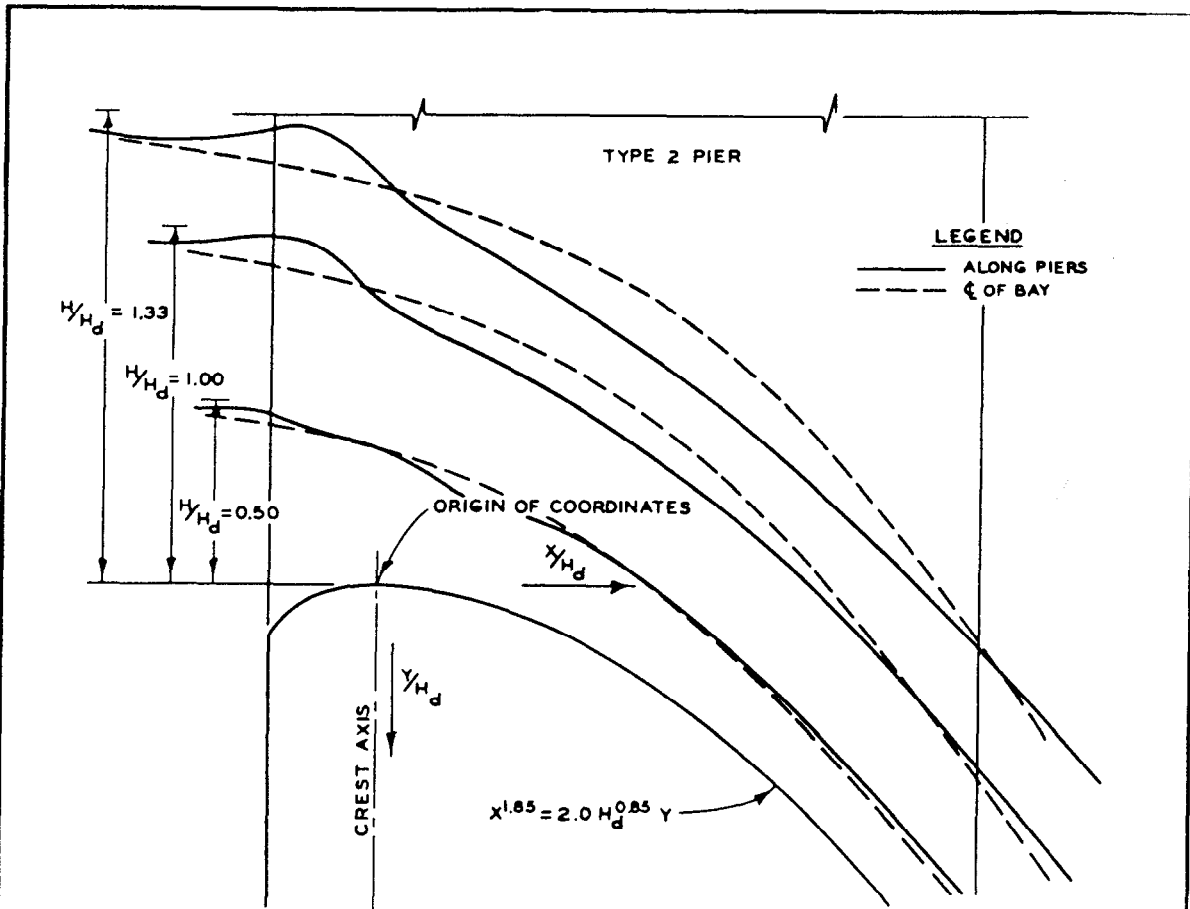

COORDINATES FOR UPPER NAPPE ALONG PIERS*

$H/H_d = 0.50$		$H/H_d = 1.00$		$H/H_d = 1.33$	
X/H_d	Y/H_d	X/H_d	Y/H_d	X/H_d	Y/H_d
-1.0	-0.495	-1.0	-0.950	-1.0	-1.235
-0.8	-0.492	-0.8	-0.940	-0.8	-1.221
-0.6	-0.490	-0.6	-0.929	-0.6	-1.209
-0.4	-0.482	-0.4	-0.930	-0.4	-1.218
-0.2	-0.440	-0.2	-0.925	-0.2	-1.244
0.0	-0.383	0.0	-0.779	0.0	-1.103
0.2	-0.265	0.2	-0.651	0.2	-0.950
0.4	-0.185	0.4	-0.545	0.4	-0.821
0.6	-0.076	0.6	-0.425	0.6	-0.689
0.8	0.060	0.8	-0.285	0.8	-0.549
1.0	0.240	1.0	-0.121	1.0	-0.389
1.2	0.445	1.2	0.067	1.2	-0.215
1.4	0.675	1.4	0.286	1.4	0.011
1.6	0.925	1.6	0.521	1.6	0.208
1.8	1.177	1.8	0.779	1.8	0.438

NOTE: $H = H_e$

OVERFLOW SPILLWAY CREST
UPPER NAPPE PROFILES
ALONG PIERS

FROM HDC 111-12/1

*BASED ON ES 801 TESTS FOR
NEGLECTIBLE VELOCITY OF APPROACH

CENTER LINE OF GATE BAY				ALONG PIERS			
$\frac{H_e}{H_d}$	0.50	1.0	1.5	$\frac{H_e}{H_d}$	0.50	1.0	1.5
$\frac{X}{H_d}$	$\frac{Y}{H_d}$			$\frac{X}{H_d}$	$\frac{Y}{H_d}$		
-1.0	-0.494	-0.939	-1.311	-1.0	-0.489	-0.933	-1.311
-0.8	-0.488	-0.925	-1.300	-0.8	-0.483	-0.925	-1.300
-0.6	-0.483	-0.913	-1.275	-0.6	-0.475	-0.918	-1.280
-0.4	-0.476	-0.888	-1.248	-0.4	-0.488	-0.931	-1.313
-0.2	-0.445	-0.855	-1.210	-0.2	-0.463	-0.935	-1.375
0.0	-0.403	-0.808	-1.162	-0.15	-0.438	-0.915	-1.383
0.2	-0.335	-0.743	-1.102	0.0	-0.369	-0.829	-1.315
0.4	-0.240	-0.666	-1.029	0.2	-0.264	-0.695	-1.171
0.6	-0.116	-0.573	-0.938	0.4	-0.170	-0.571	-1.023
0.8	+0.029	-0.454	-0.833	0.6	-0.063	-0.441	-0.882
1.0	0.201	-0.291	-0.707	0.8	0.069	-0.298	-0.730
1.2	0.403	-0.086	-0.562	1.0	0.234	-0.128	-0.555
1.4	0.626	+0.150	-0.395	1.2	0.431	0.065	-0.362
				1.4	0.651	0.278	-0.140

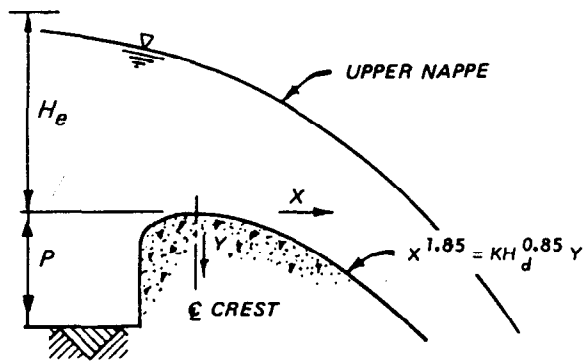

DEFINITION SKETCH

WATER SURFACE PROFILES

CONTROLLED CREST

$P/H_d = 1.0$

CENTER LINE OF GATE BAY

$\frac{H_e}{H_d}$	0.50	1.0	1.5
$\frac{X}{H_d}$	$\frac{Y}{H_d}$		
-1.0	-0.483	-0.894	-1.254
-0.8	-0.479	-0.886	-1.244
-0.6	-0.471	-0.871	-1.229
-0.4	-0.454	-0.851	-1.208
-0.2	-0.429	-0.824	-1.183
0.0	-0.388	-0.783	-1.149
0.2	-0.329	-0.728	-1.099
0.4	-0.241	-0.655	-1.034
0.6	-0.123	-0.570	-0.951
0.8	+0.019	-0.458	-0.856
1.0	+0.198	-0.300	-0.753
1.2	+0.394	-0.104	-0.631
1.4	+0.613	+0.119	-0.426

ALONG PIERS

$\frac{H_e}{H_d}$	0.50	1.0	1.5
$\frac{X}{H_d}$	$\frac{Y}{H_d}$		
-1.0	-0.483	-0.889	-1.257
-0.8	-0.481	-0.880	-1.248
-0.6	-0.477	-0.869	-1.233
-0.4	-0.480	-0.880	-1.243
-0.2	-0.467	-0.917	-1.338
-0.15	-0.450	-0.910	-1.373
0.0	-0.356	-0.825	-1.324
0.2	-0.252	-0.677	-1.176
0.4	-0.159	-0.541	-1.029
0.6	-0.055	-0.414	-0.885
0.8	0.081	-0.258	-0.735
1.0	0.256	-0.089	-0.566
1.2	0.477	0.105	-0.383
1.4	0.672	0.319	-0.188

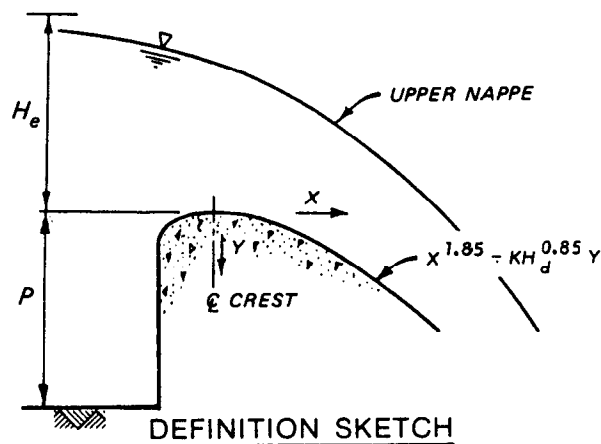

WATER SURFACE PROFILES

CONTROLLED CREST
 $P/H_d = 0.50$

CENTER LINE OF GATE BAY

$\frac{H_e}{H_d}$	0.50	1.0
$\frac{X}{H_d}$	$\frac{Y}{H_d}$	
-1.0	-0.469	-0.850
-0.8	-0.469	-0.848
-0.6	-0.464	-0.839
-0.4	-0.454	-0.823
-0.2	-0.438	-0.796
0.0	-0.405	-0.758
0.2	-0.358	-0.715
0.4	-0.260	-0.640
0.6	-0.151	-0.553
0.8	-0.018	-0.448
1.0	0.135	-0.303
1.2	0.315	-0.135
1.4	0.528	+0.045

ALONG PIERS

$\frac{H_e}{H_d}$	0.50	1.0
$\frac{X}{H_d}$	$\frac{Y}{H_d}$	
-1.0	-0.469	-0.838
-0.8	-0.469	-0.835
-0.6	-0.466	-0.833
-0.4	-0.469	-0.835
-0.2	-0.488	-0.894
0.0	-0.414	-0.900
0.2	-0.286	-0.756
0.4	-0.175	-0.615
0.6	-0.066	-0.471
0.8	+0.061	-0.311
1.0	+0.209	-0.139
1.2	+0.378	+0.044
1.4	+0.577	+0.250

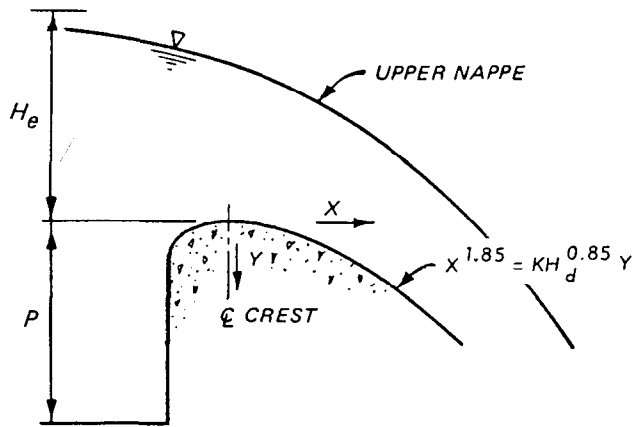

DEFINITION SKETCH

WATER SURFACE PROFILES

CONTROLLED CREST

$P/H_d = 0.25$

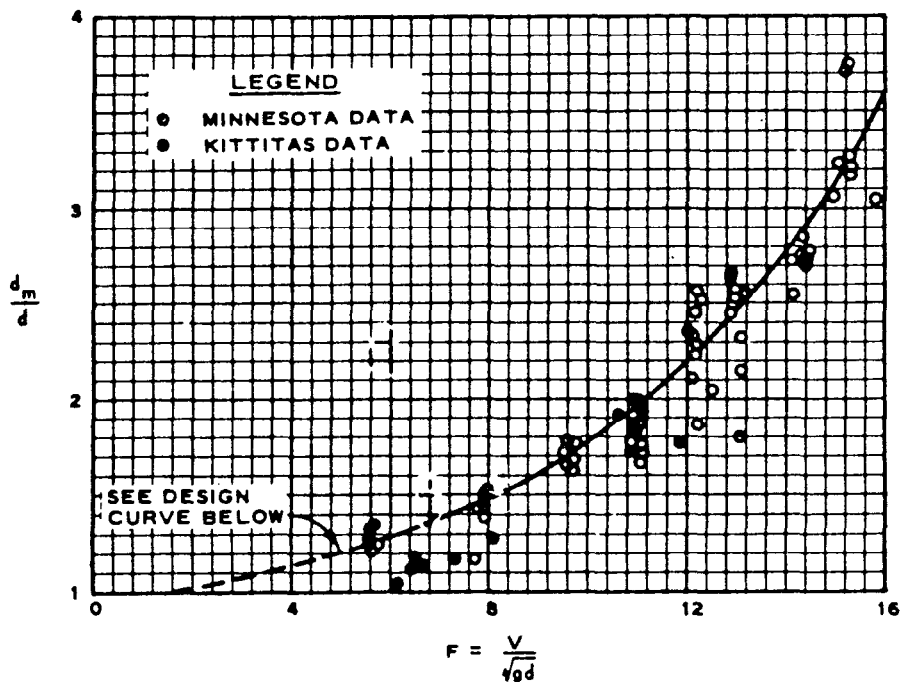

a. EXPERIMENTAL DATA

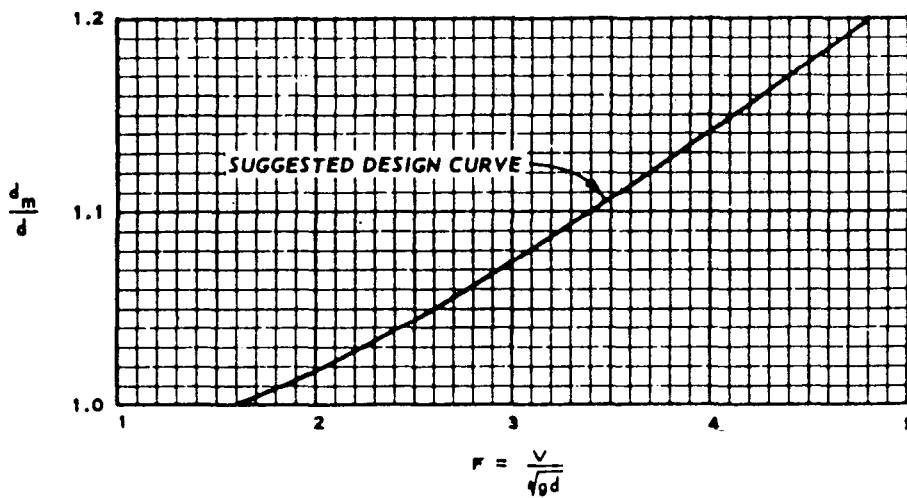

b. DESIGN CURVE

NOTE: d_m = DEPTH OF WATER AND AIR MIXTURE
 d = COMPUTED DEPTH FOR NON-AERATED FLOW
 V = COMPUTED VELOCITY FOR NON-AERATED FLOW
 g = GRAVITATIONAL ACCELERATION
 F = FROUDE NUMBER FOR NONAERATED FLOW

AIR ENTRAINMENT

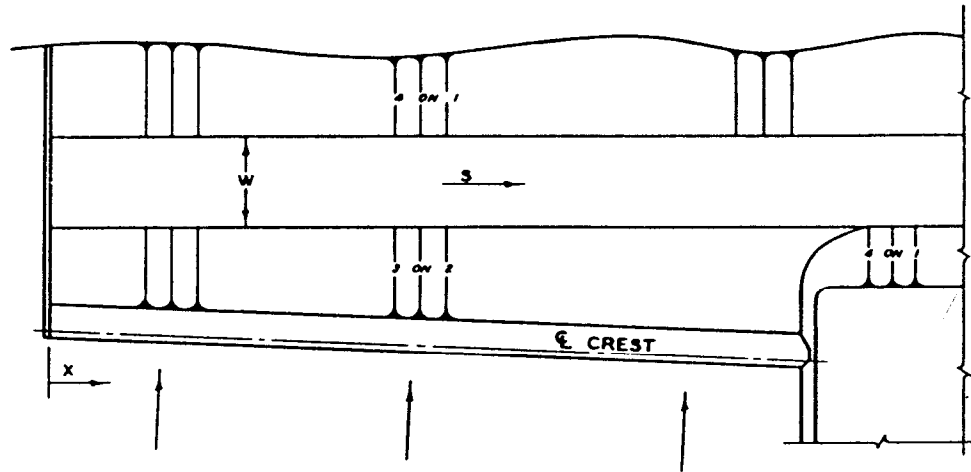

a. CONVENTIONAL SIDE CHANNEL SPILLWAY

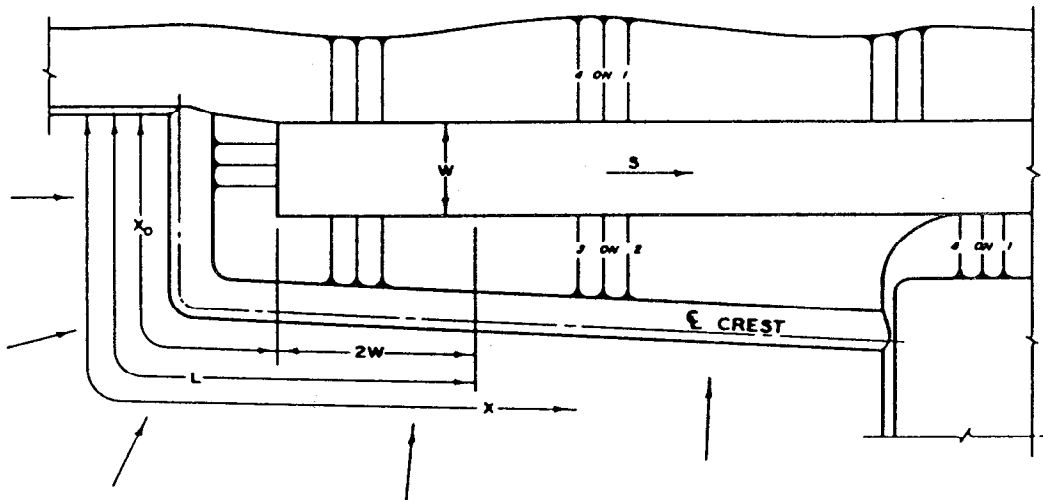

b. L-SHAPED SIDE CHANNEL SPILLWAY

SIDE CHANNEL SPILLWAYS

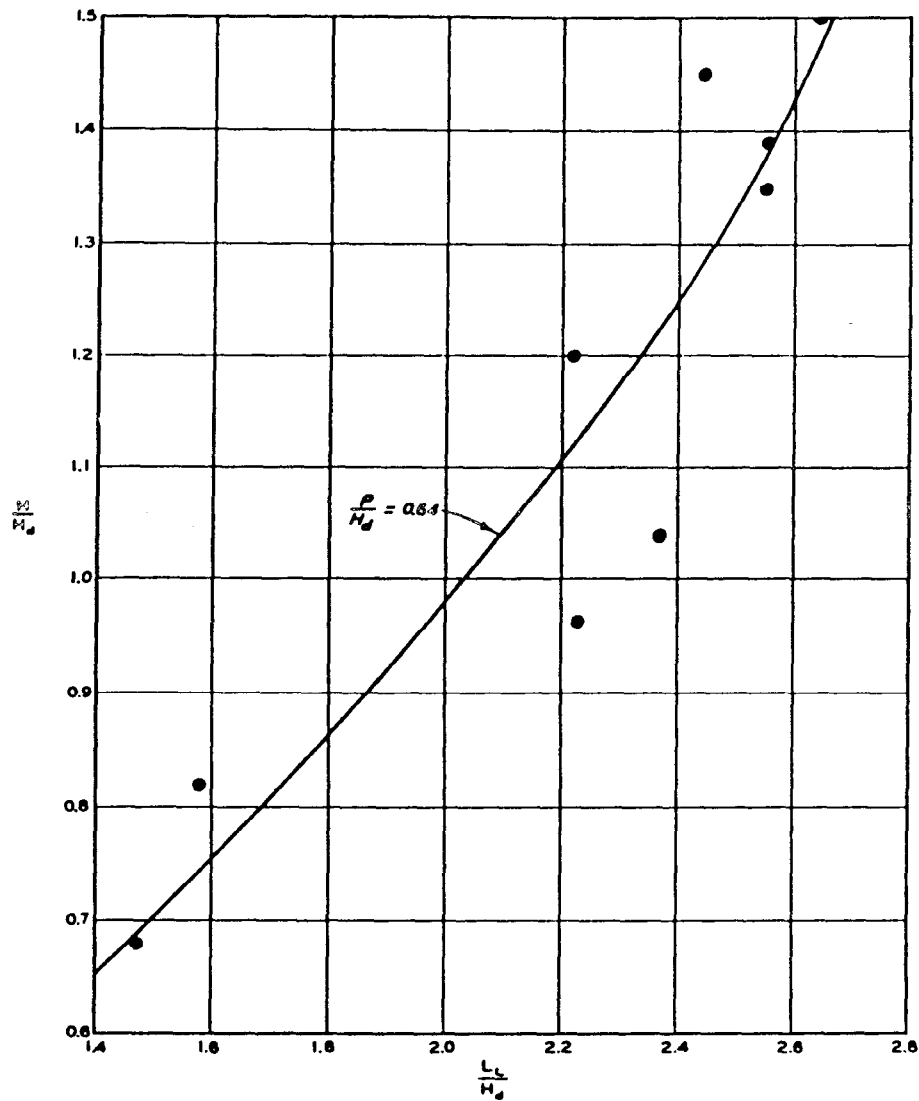

NOTE: H = HEAD ON CREST.
H_d = DESIGN HEAD.
L_c = LOSS OF EFFECTIVE CREST LENGTH.
P = APPROACH DEPTH.

SIDE CHANNEL SPILLWAYS
L-SHAPED CRESTS
EFFECTIVE LENGTH

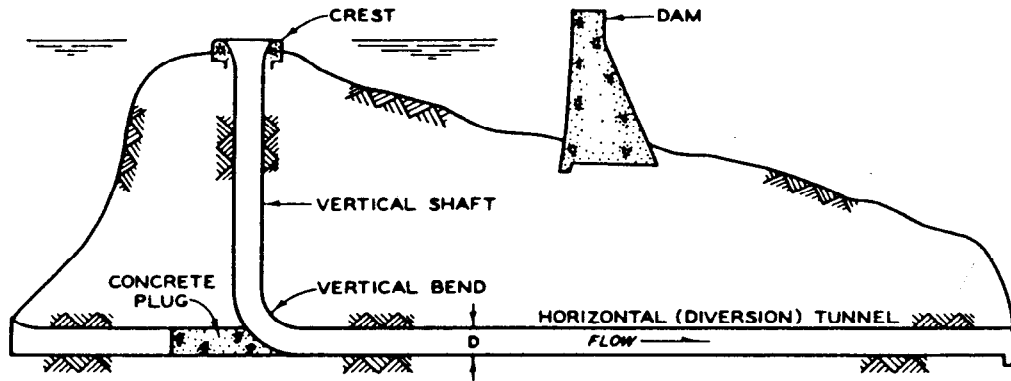

VERTICAL SHAFT SPILLWAY

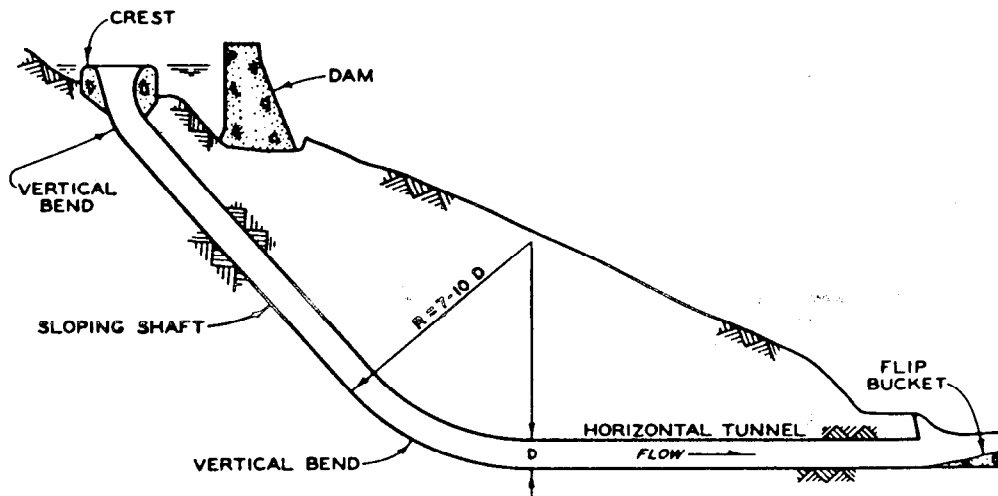

SLOPING SHAFT SPILLWAY

MORNING GLORY SPILLWAYS

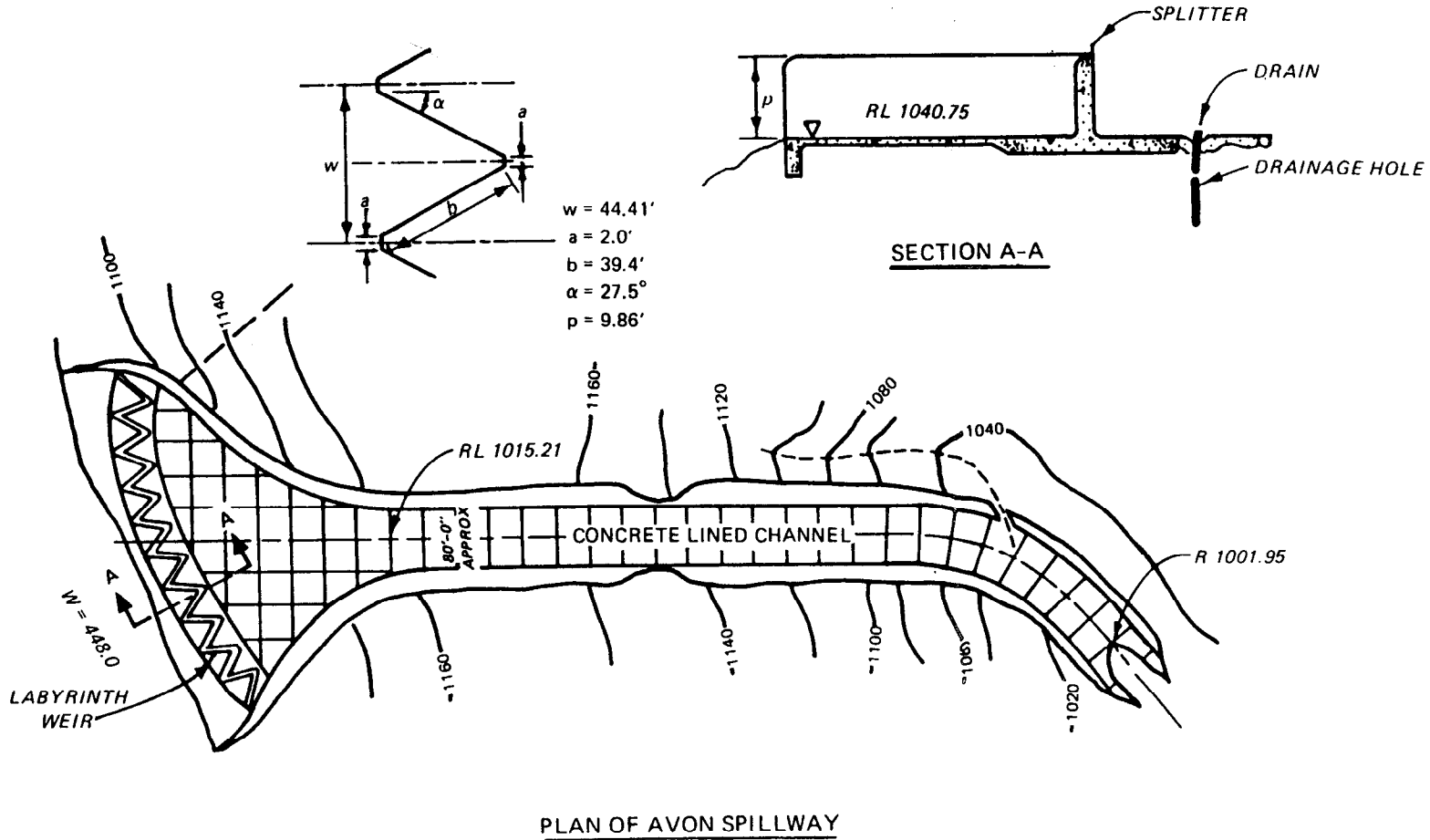

LABYRINTH WEIR
SPILLWAY

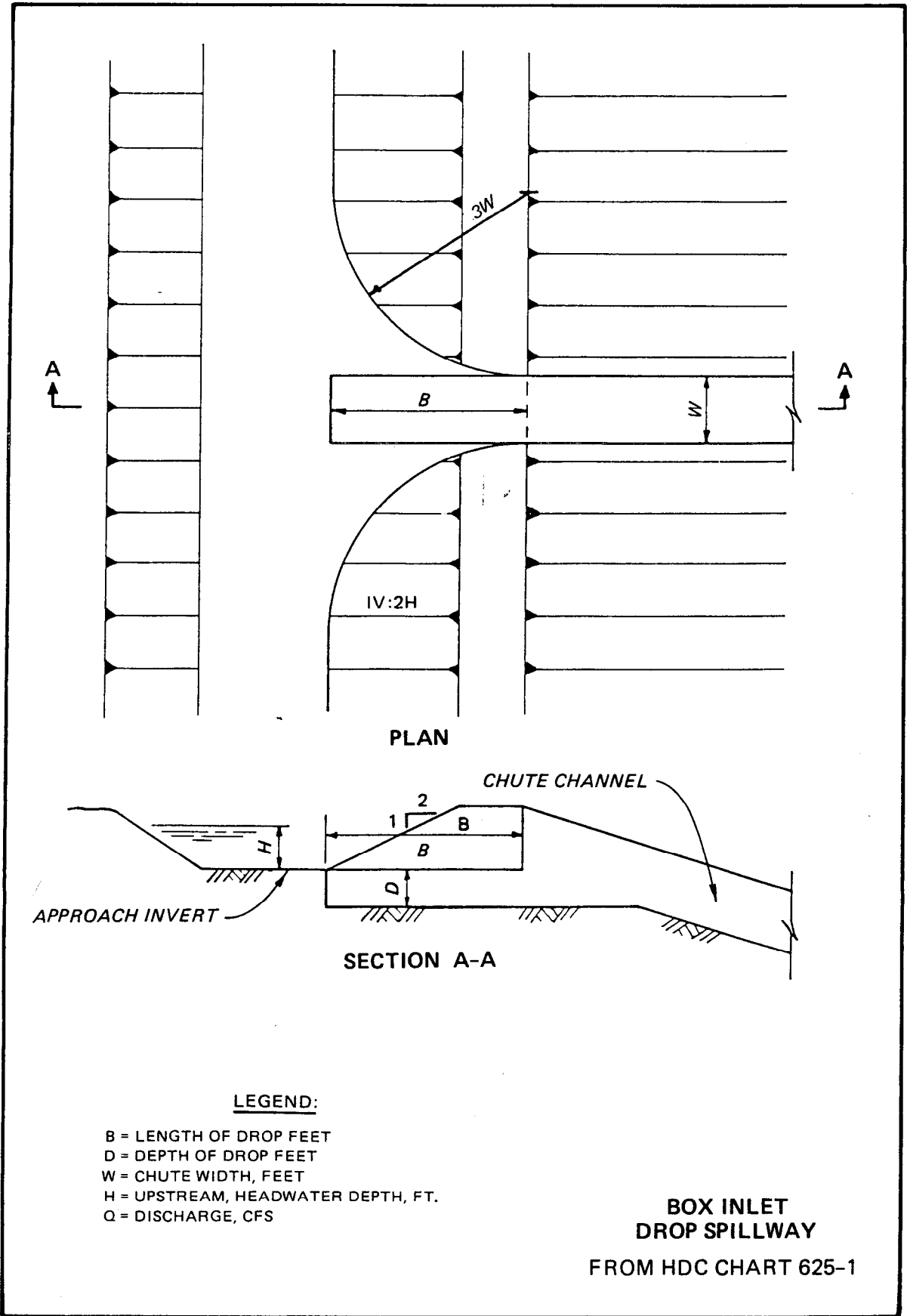

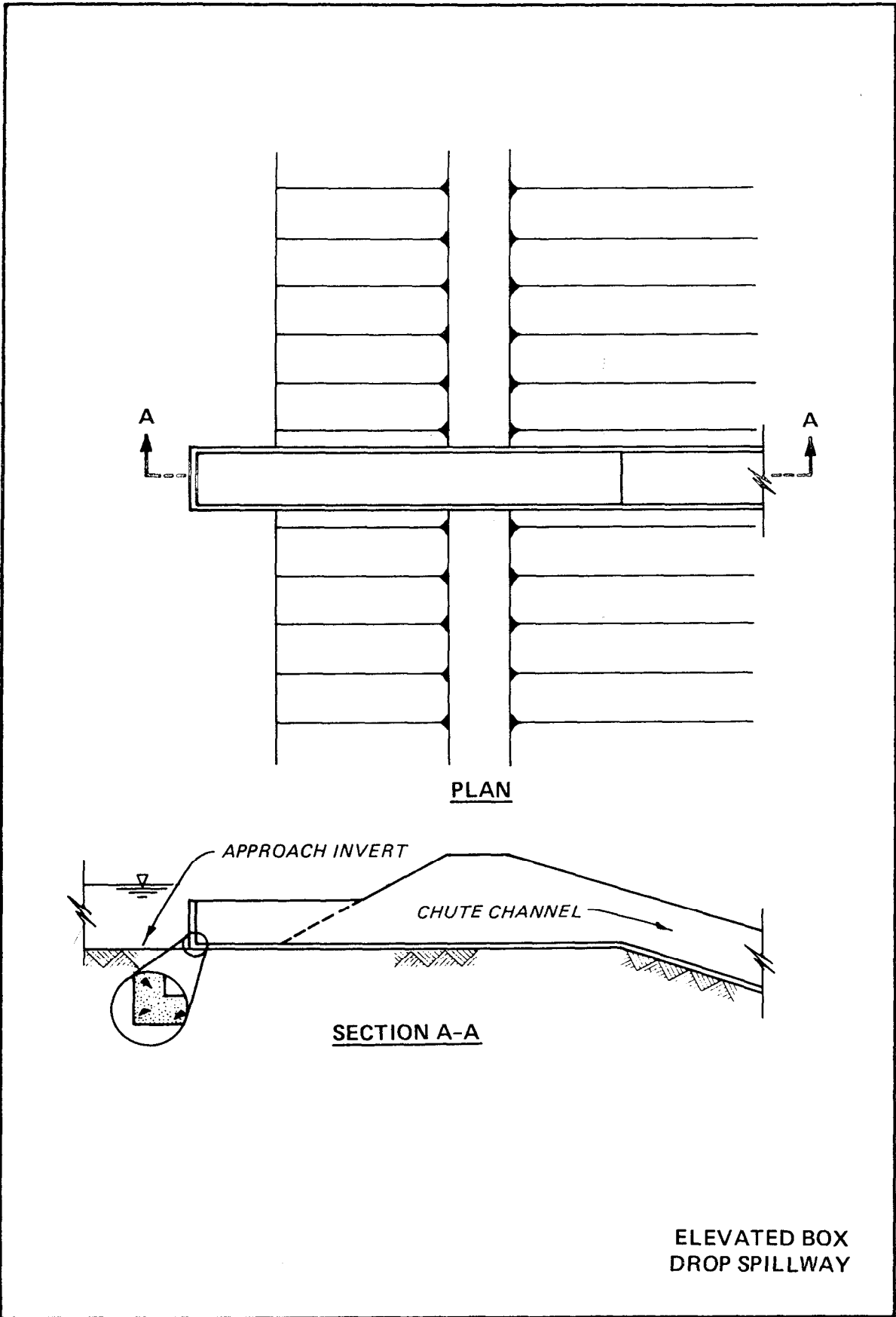

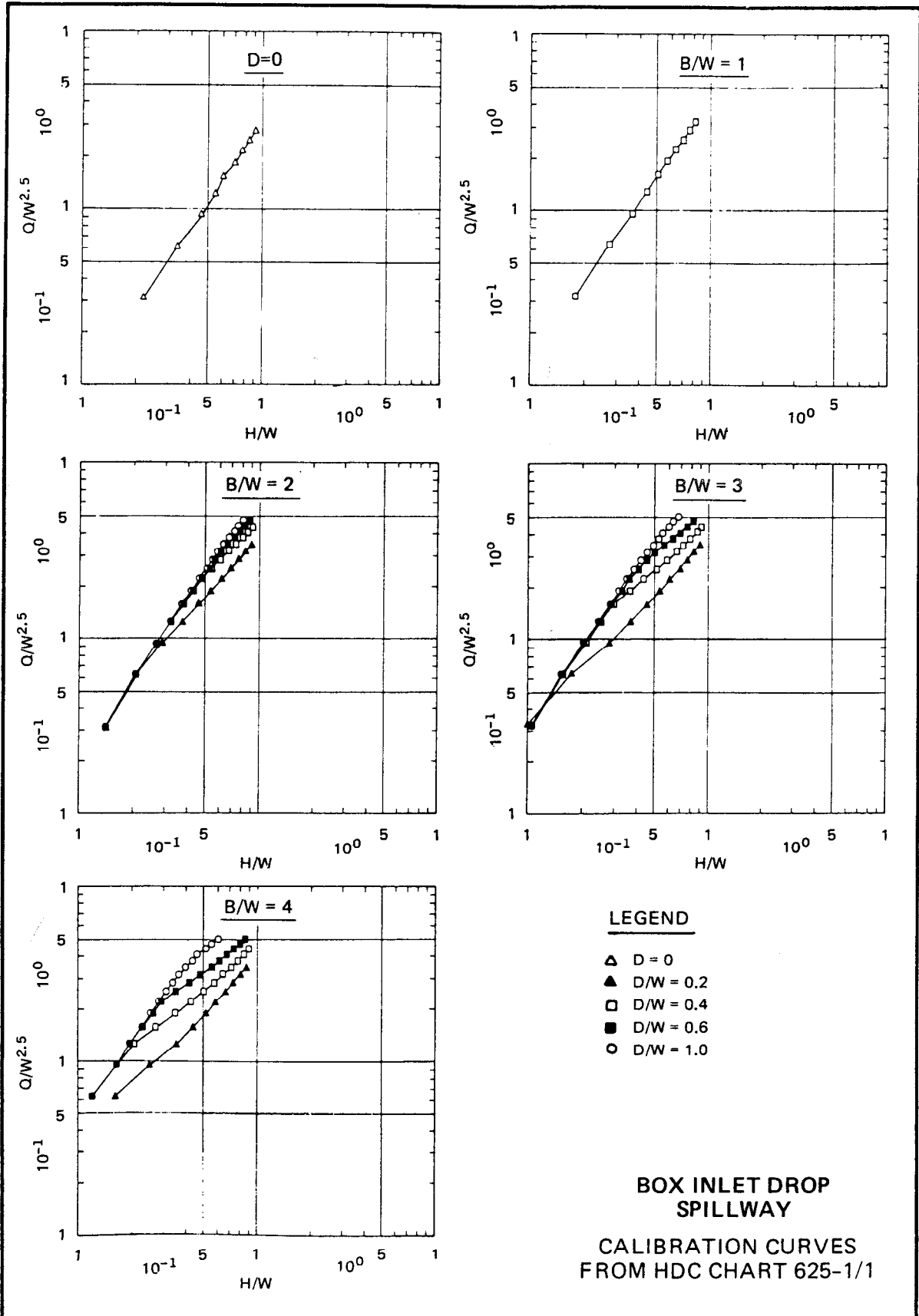

**BOX INLET DROP
SPILLWAY**
CALIBRATION CURVES
FROM HDC CHART 625-1/1

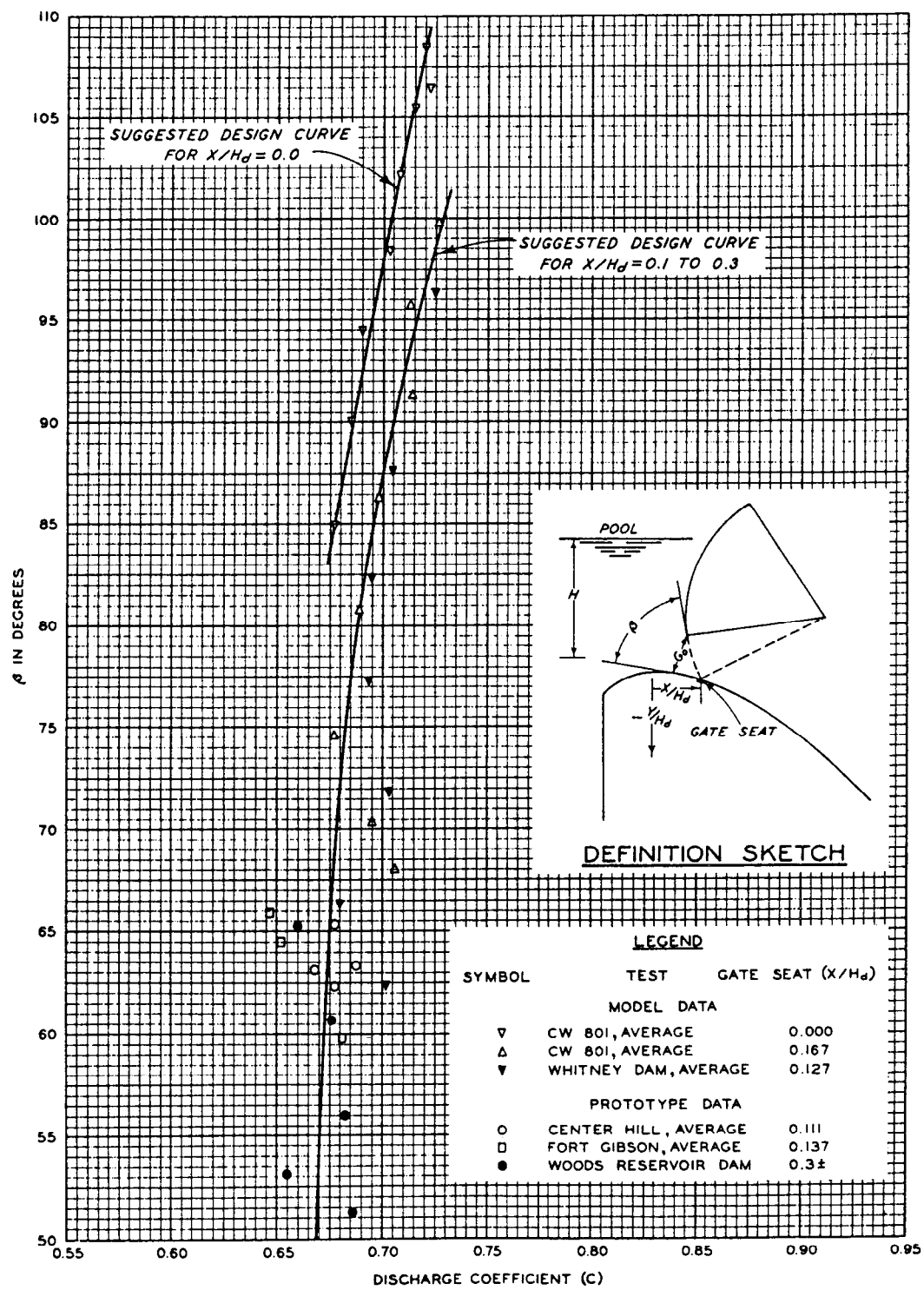

FORMULA

$$Q = C G_o B \sqrt{2gH}$$

WHERE:

- G_o = NET GATE OPENING
- B = GATE WIDTH
- H = HEAD TO CENTER OF GATE OPENING

**TANTER GATES ON
SPILLWAY CRESTS**
DISCHARGE COEFFICIENTS
FROM HDC 311-1

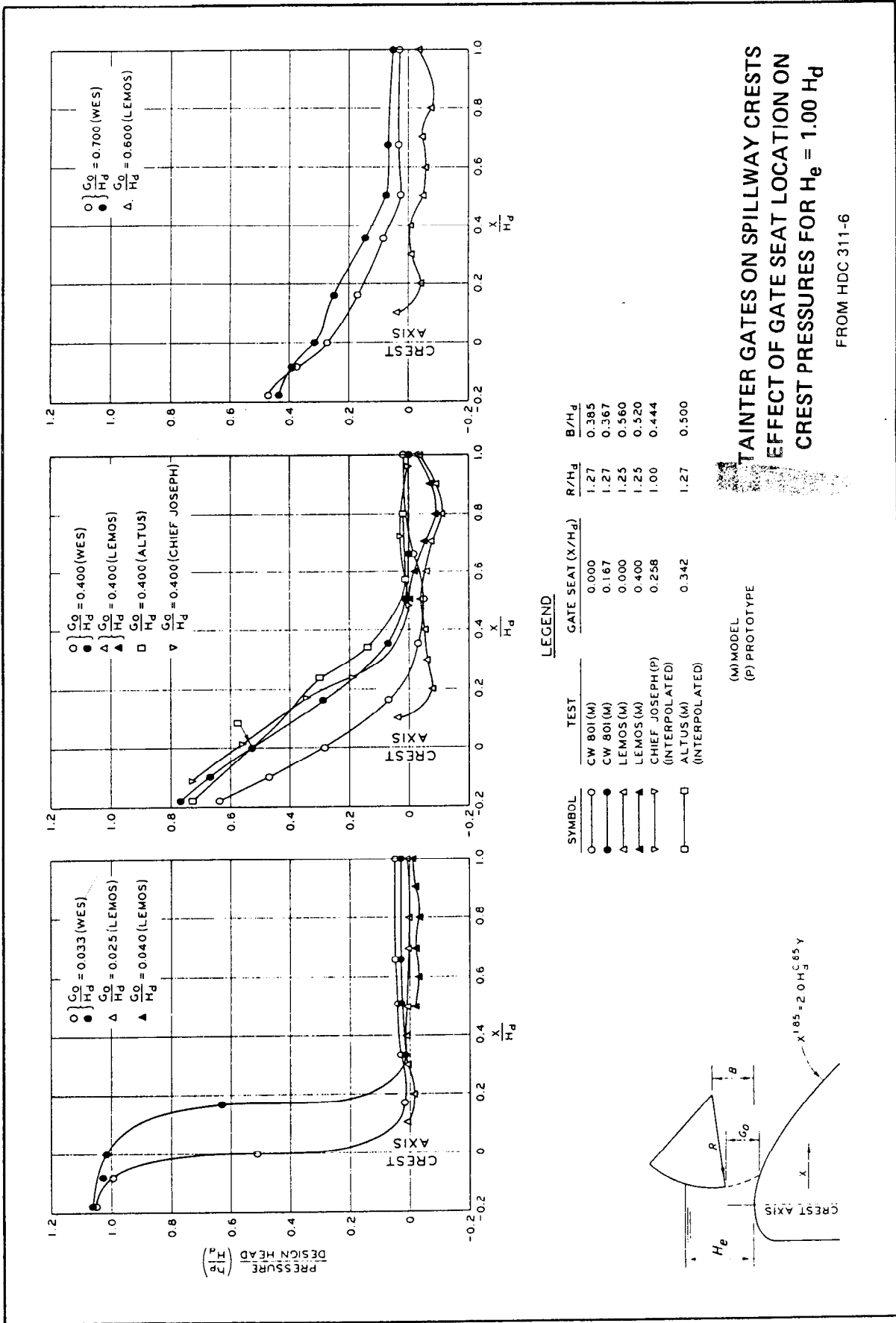

**TANTNER GATES ON SPILLWAY CRESTS
EFFECT OF GATE SEAT LOCATION ON
CREST PRESSURES FOR He = 1.00 Hd**

FROM HDC 311-6

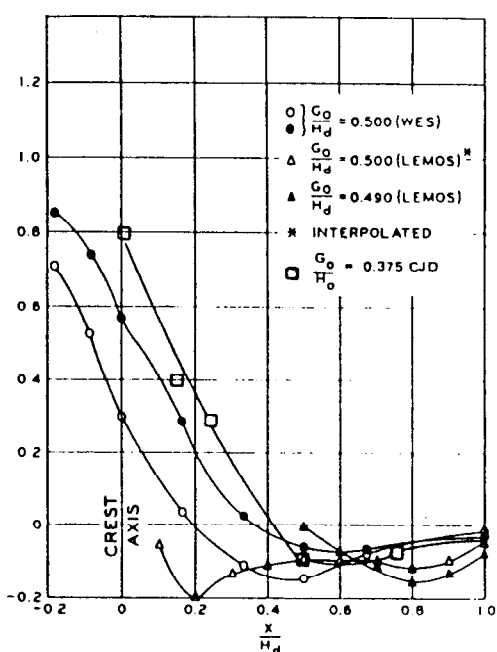
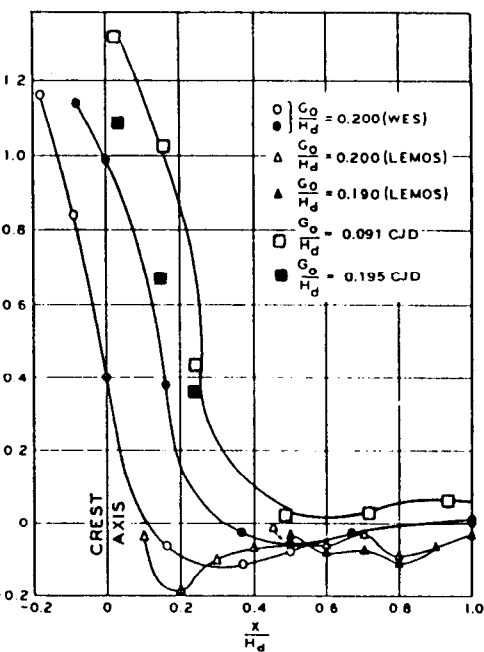
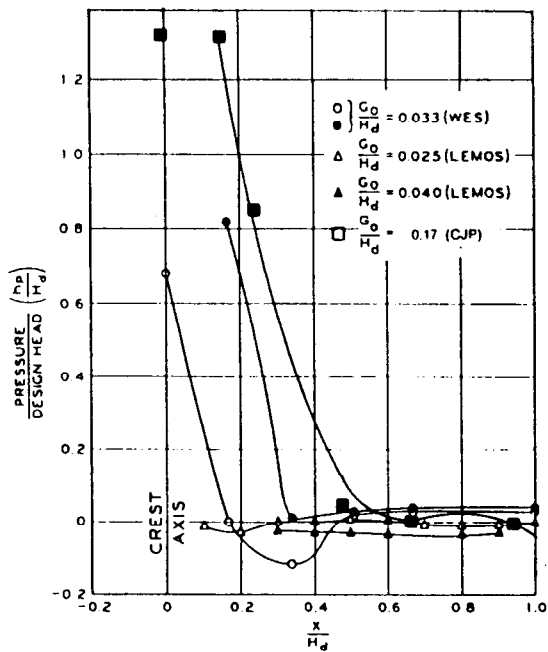

LEGEND

SYMBOL	TEST	GATE SEAT (X/H_d)	R/H_d	B/H_d	H/H_d
○	CW 801(M)	0.000	1.27	0.385	1.33
●	CW 801(M)	0.167	1.27	0.367	1.33
△	LEMOS (M)	0.000	1.25	0.560	1.25
▲	LEMOS (M)	0.400	1.25	0.520	1.25
□	CH JOSEPH DAM	0.258	1.00	0.444	1.33
*	CJD				

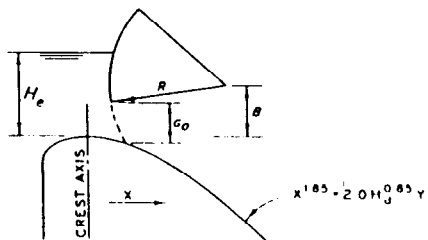

TAINTER GATES ON SPILLWAY CRESTS
EFFECT OF GATE SEAT LOCATION ON
CREST PRESSURES FOR $H_e = 1.3H$
FROM HDC 311-6/1

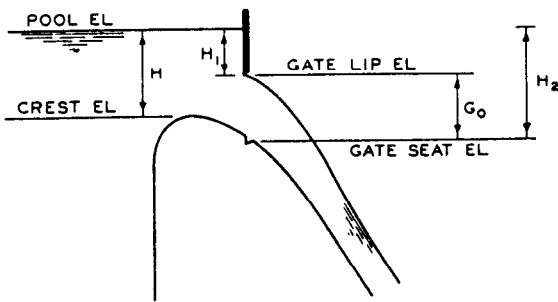
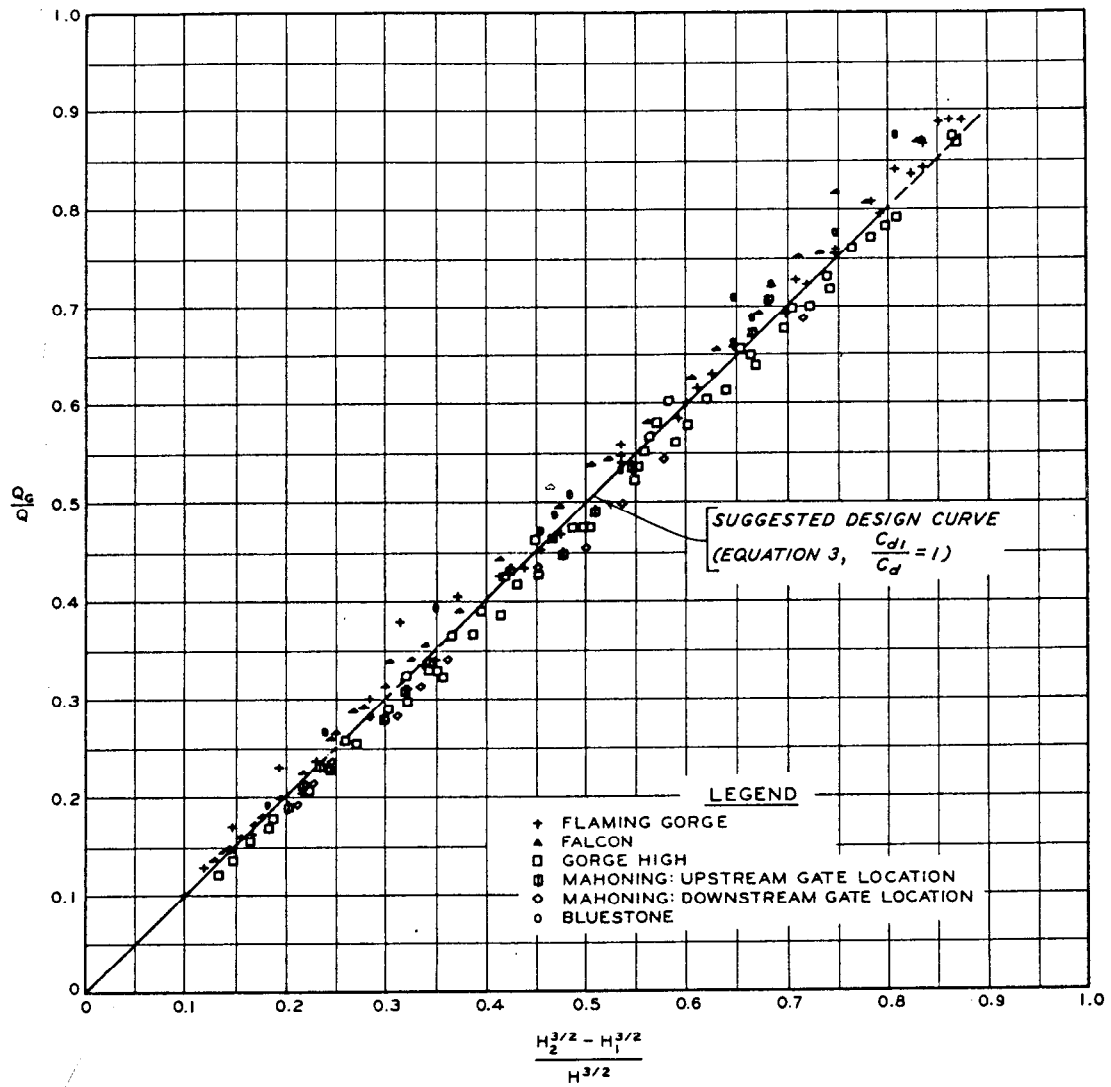

DEFINITION SKETCH

NOTE: Q = FREE-FLOW DISCHARGE AT HEAD H
 H = HEAD
 Q₀ = DISCHARGE AT HEAD H AND GATE OPENING G₀
 H₁ = H₂ - G₀

**VERTICAL LIFT GATES
ON SPILLWAYS**
DISCHARGE COEFFICIENTS
FROM HDC 312

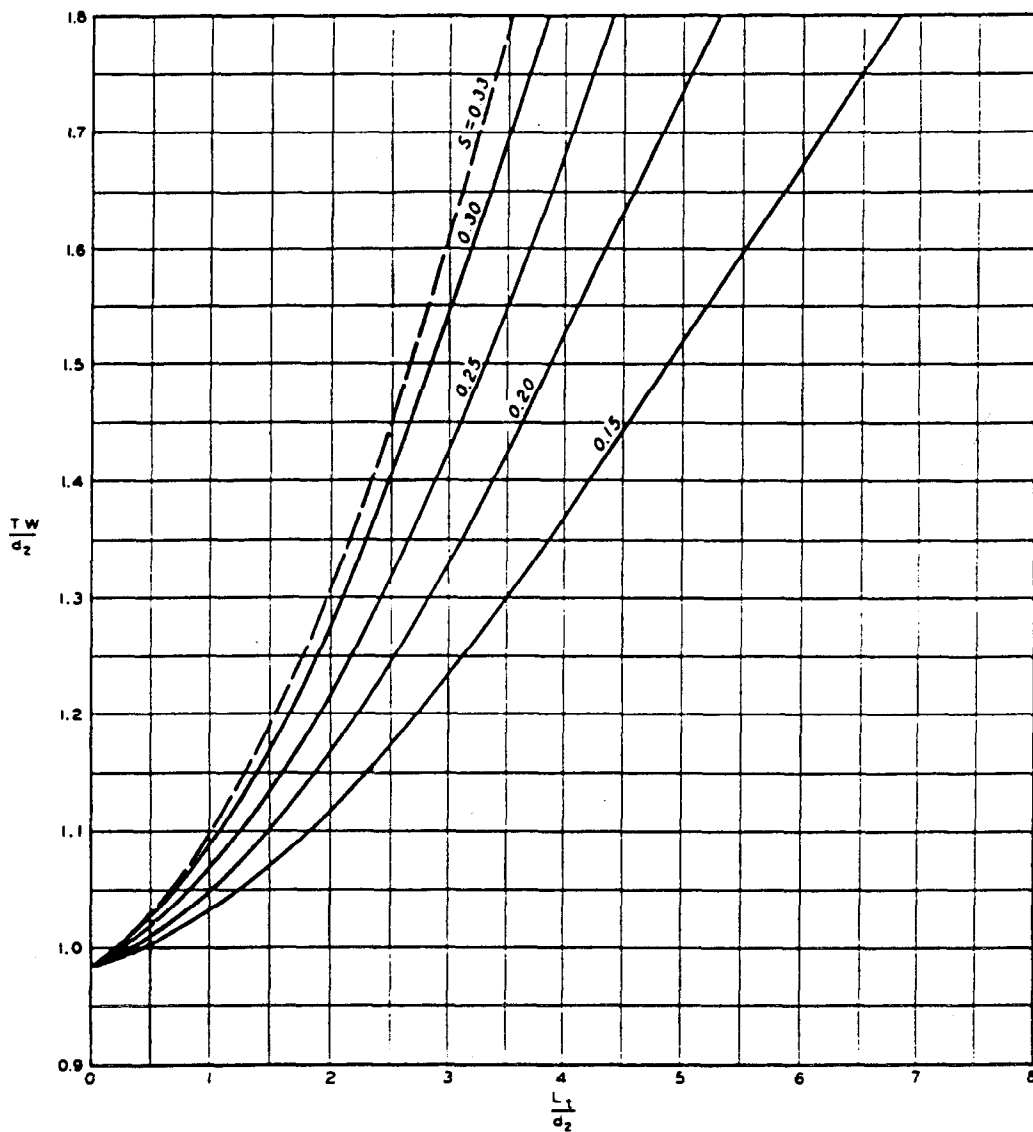

$$\frac{d_2}{d_1} = \frac{1}{2} (\sqrt{1 + 8F_1^2} - 1)$$

$$F_1 = \frac{v_1}{\sqrt{g d_1}}$$

NOTE: CURVES DEVELOPED BY BRADLEY AND PETERKA FROM EXPERIMENTAL DATA.

CURVE FOR S=0.33 EXTRAPOLATED

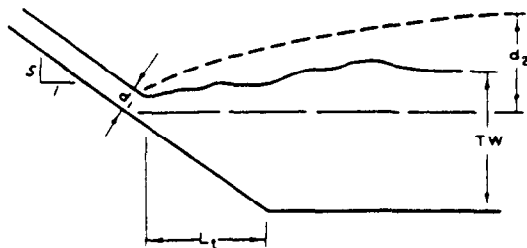

DEFINITION SKETCH

**SLOPING FLOOR
STILLING BASINS
NONCONTINUOUS SLOPE
JUMP LENGTH ON SLOPE
FROM HDC 124-1/1**

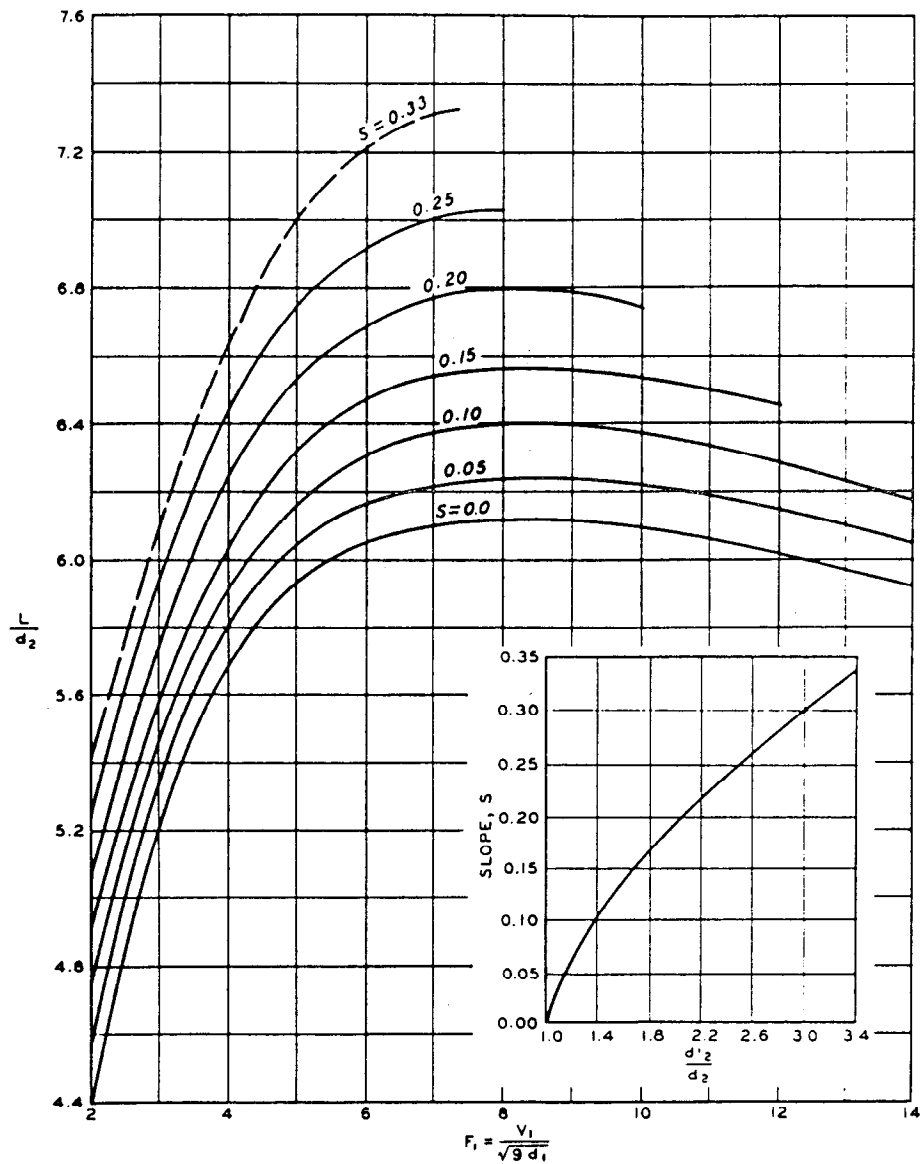

$$\frac{d_2}{d_1} = \frac{1}{2} (\sqrt{1 + 8F_1^2} - 1)$$

NOTE: CURVES DEVELOPED BY BRADLEY AND PETERKA FROM EXPERIMENTAL DATA. DATA POINTS OMITTED TO SIMPLIFY CHART.
CURVE FOR S=0.33 EXTRAPOLATED

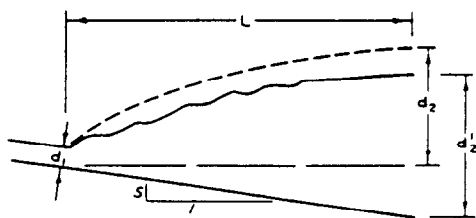

DEFINITION SKETCH

**SLOPING FLOOR
STILLING BASINS
CONTINUOUS SLOPE
LENGTH OF HYDRAULIC JUMP**
FROM HDC 124-1

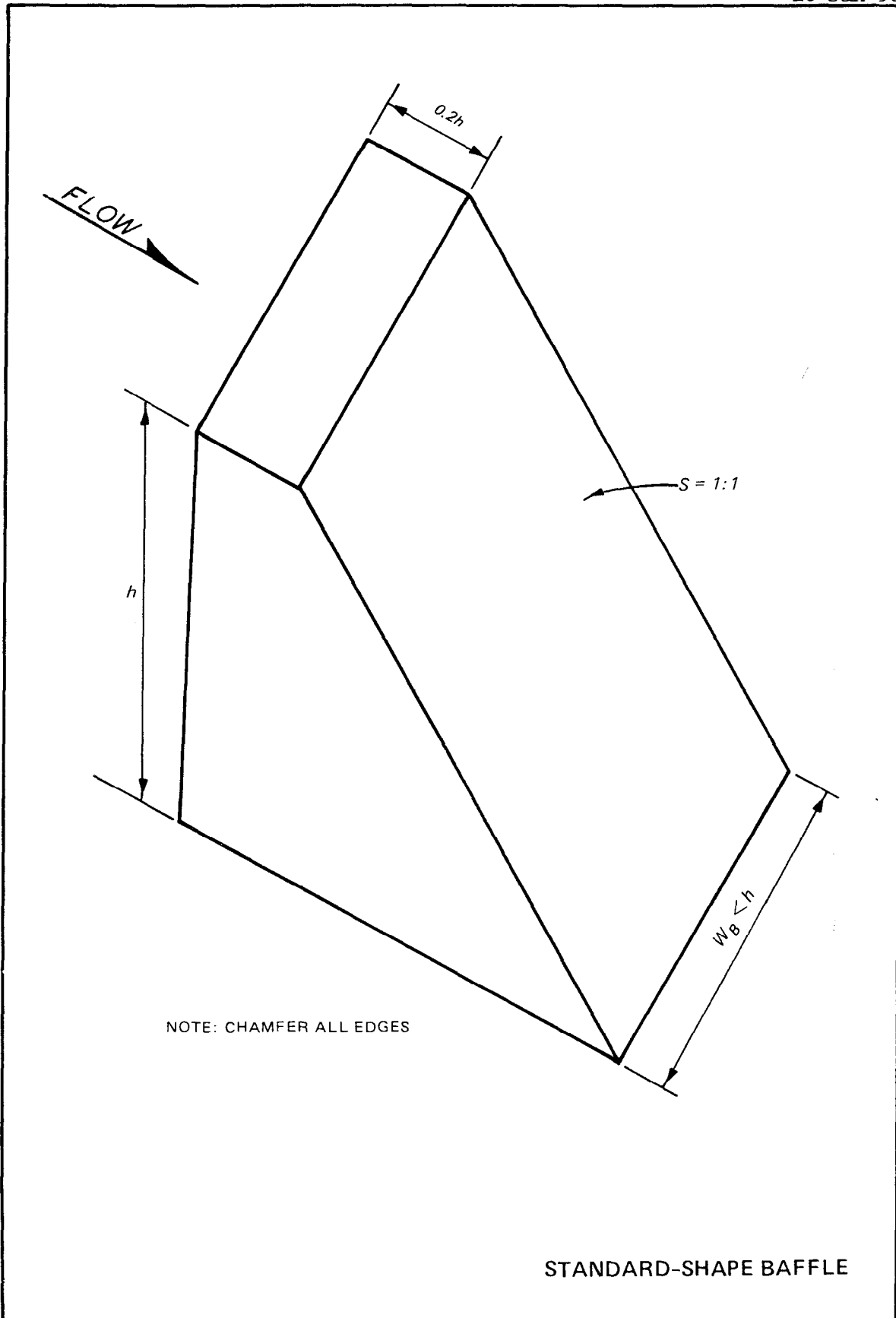

STANDARD-SHAPE BAFFLE

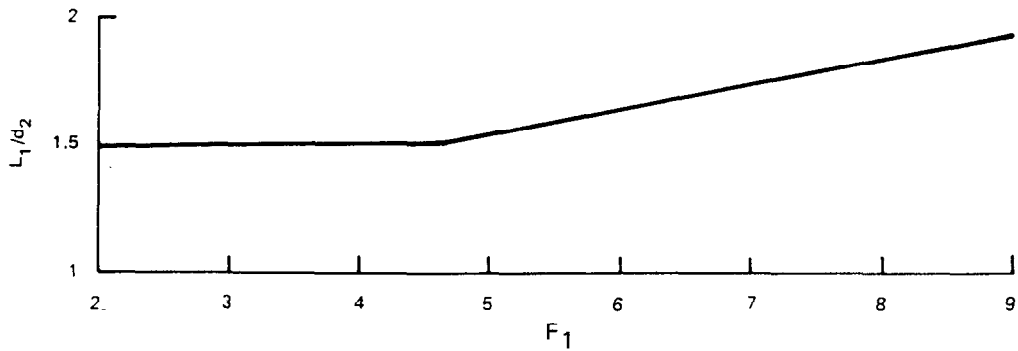

BAFFLE LOCATION

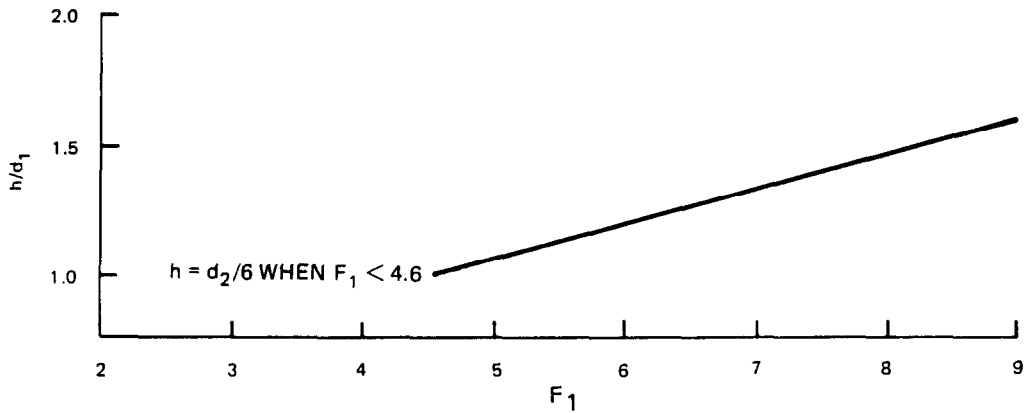

BAFFLE HEIGHT

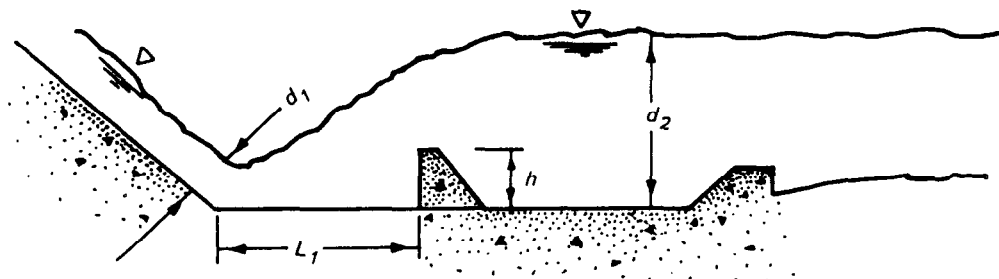

DEFINITION SKETCH

BAFFLE HEIGHT
 AND
 LOCATION

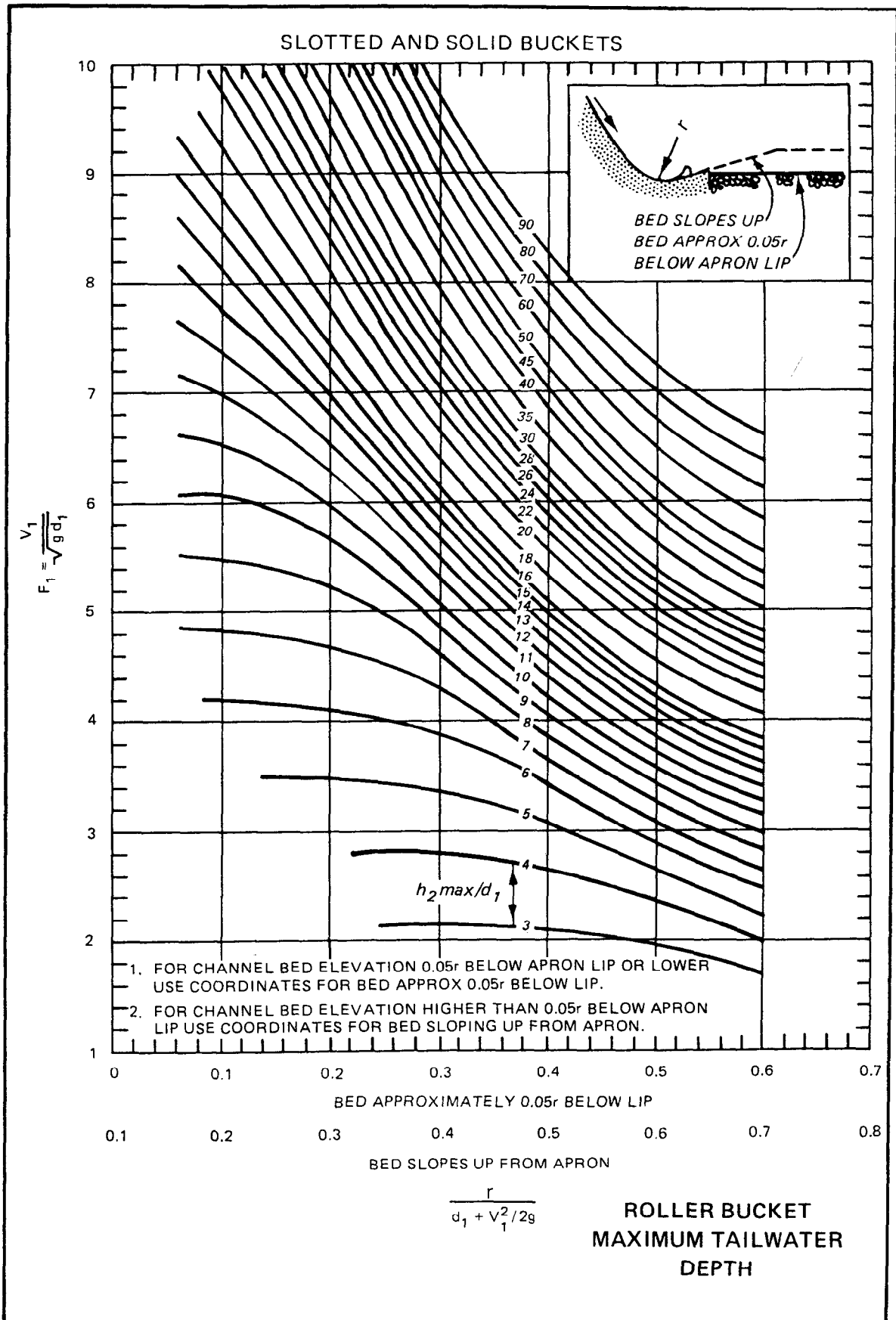

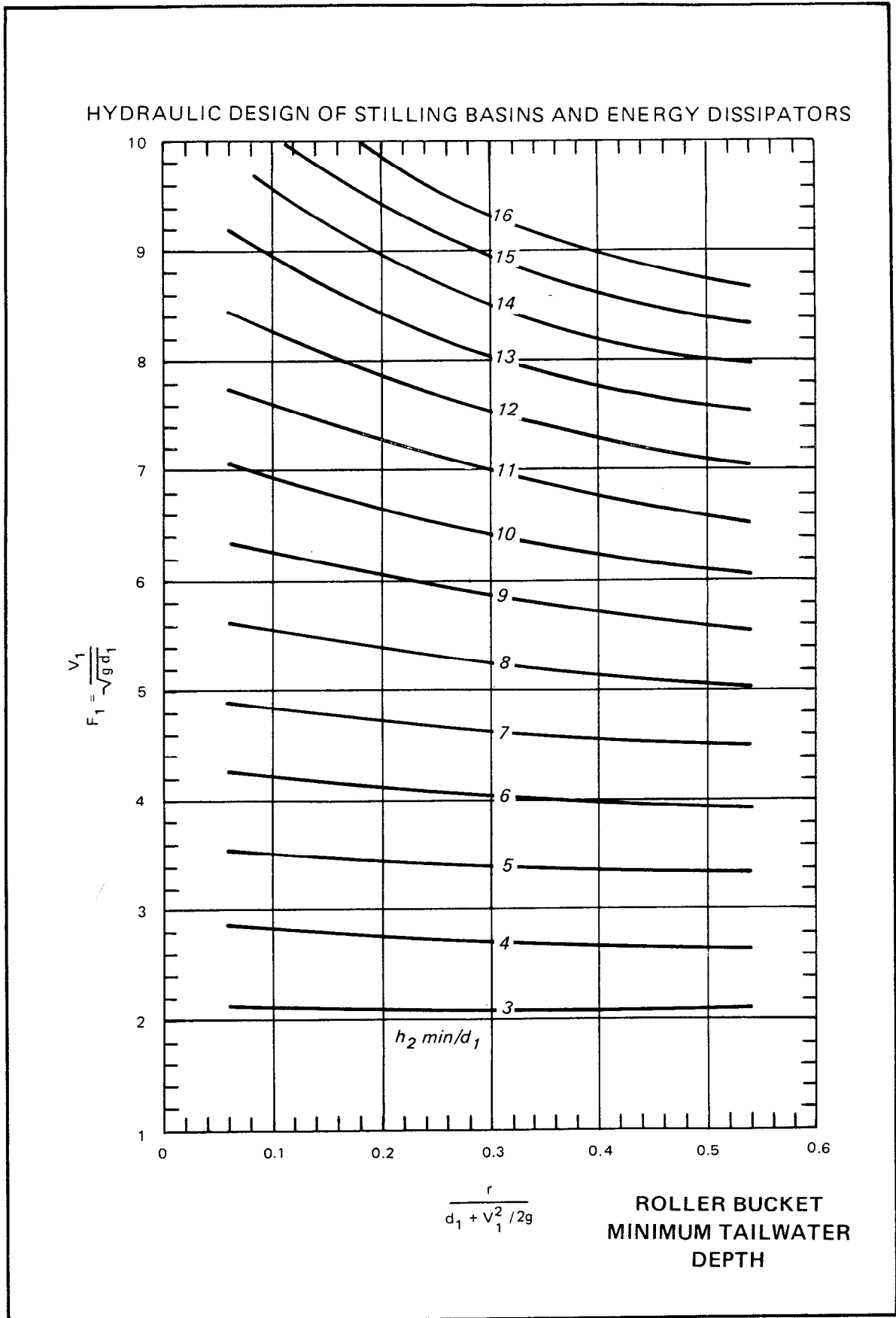

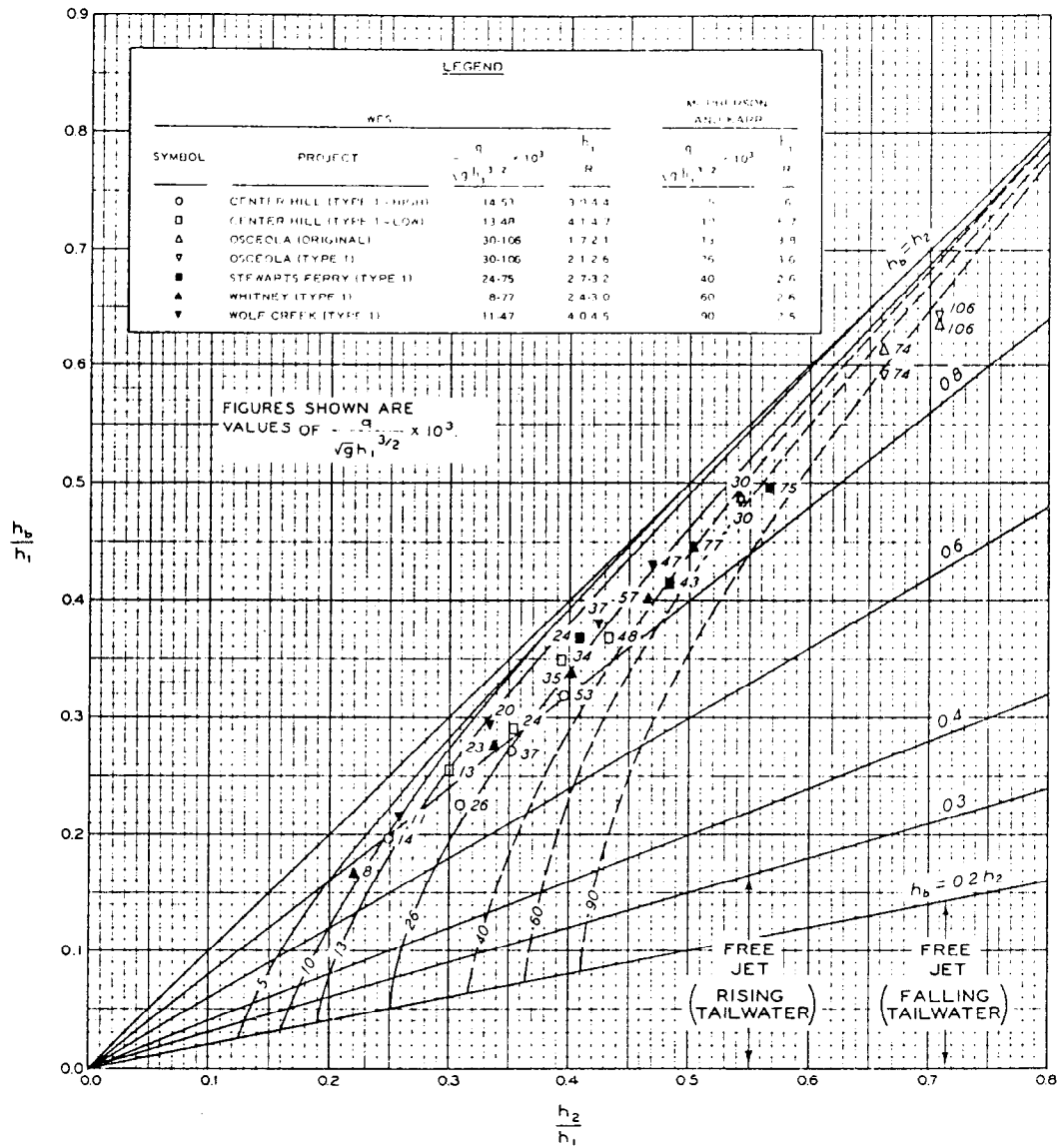

NOTE DESIGN CURVES SHOWN DEVELOPED BY McPHERSON AND KARR FROM EXPERIMENTAL DATA. THESE DATA OMITTED TO SIMPLIFY CHART.

RANGES OF VARIABLES

	WES	McPHERSON AND KARR
SPILLWAY SLOPE	141-167.1	1:1
LIP ANGLE	45°	45°
H/h_1	0.68-0.93	>0.75
h_1/R	SEE LEGEND	SEE LEGEND
$q/\sqrt{g}h_1^{3/2} \times 10^3$	SEE LEGEND	SEE LEGEND

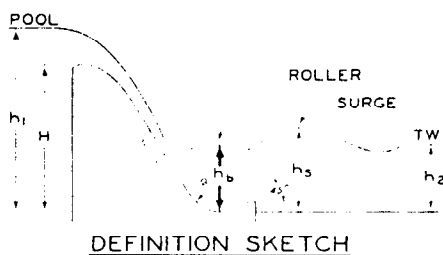

HIGH OVERFLOW DAMS
BUCKET-TYPE ENERGY DISSIPATOR
ROLLER DEPTH
FROM HDC 112-6

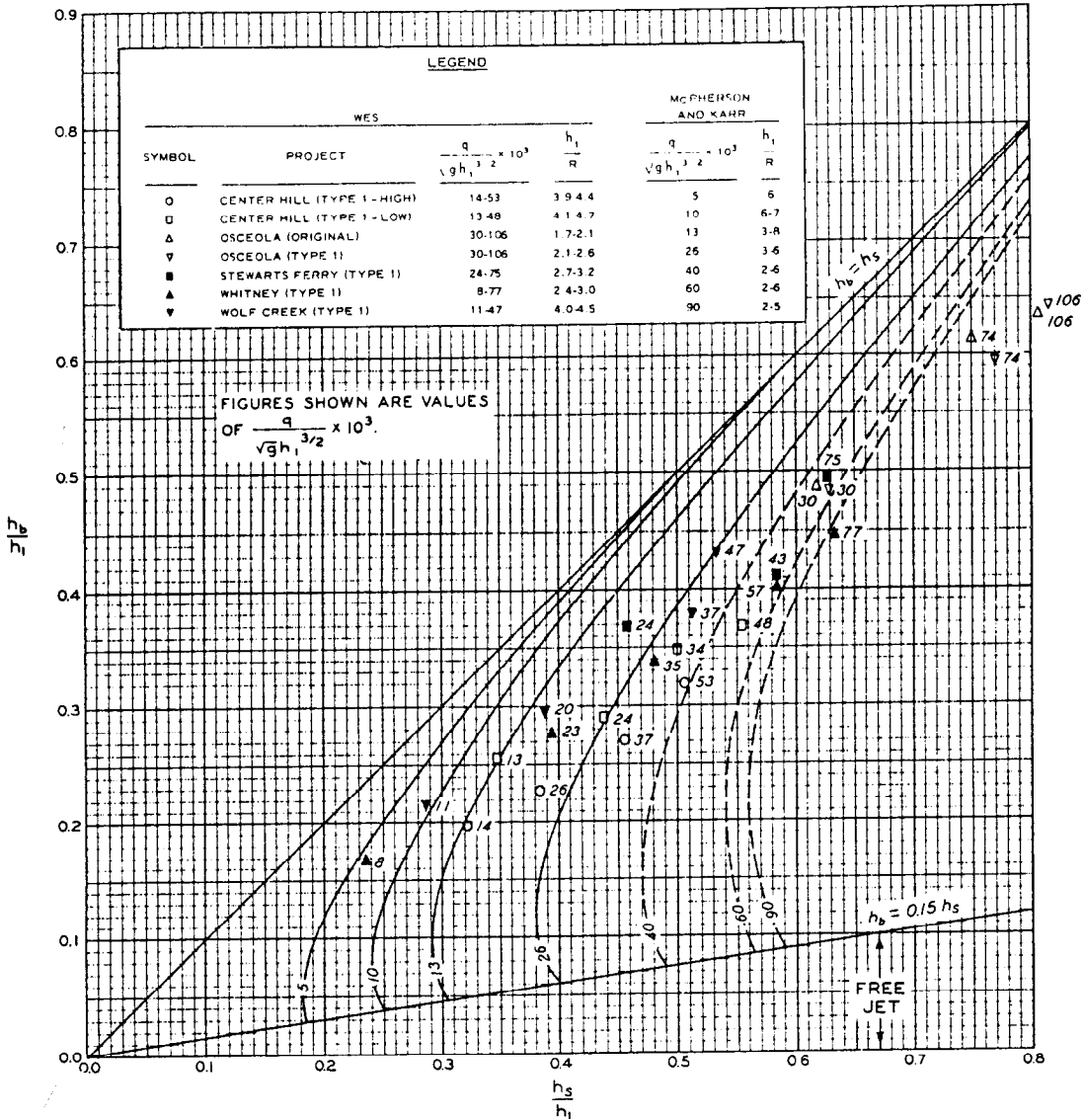

NOTE: DESIGN CURVES SHOWN DEVELOPED BY MCPHERSON AND KARR FROM EXPERIMENTAL DATA THESE DATA OMITTED TO SIMPLIFY CHART

RANGES OF VARIABLES

	WES	McPHERSON AND KARR
SPILLWAY SLOPE	1.41-1.67:1	1:1
LIP ANGLE	45°	45°
H/h ₁	0.68-0.93	>0.75
h ₁ /R	SEE LEGEND	SEE LEGEND
$q/\sqrt{g h_1^{3/2}} \times 10^3$	SEE LEGEND	SEE LEGEND

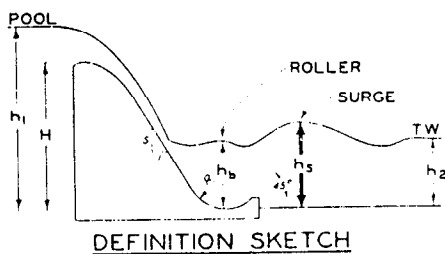

DEFINITION SKETCH

HIGH OVERFLOW DAMS
BUCKET-TYPE ENERGY DISSIPATOR
SURGE HEIGHT
FROM HDC 112-6/1

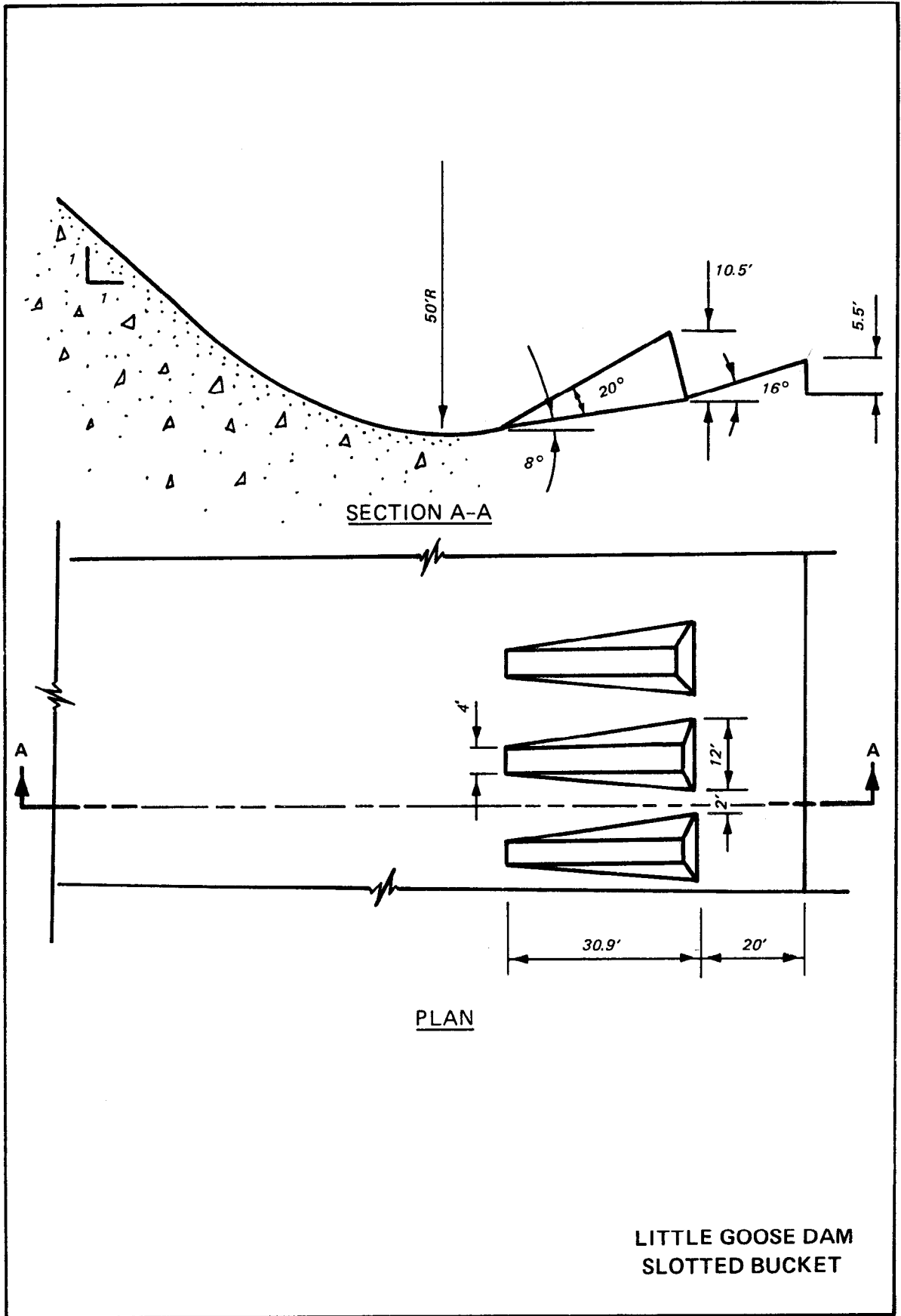

LITTLE GOOSE DAM
SLOTTED BUCKET

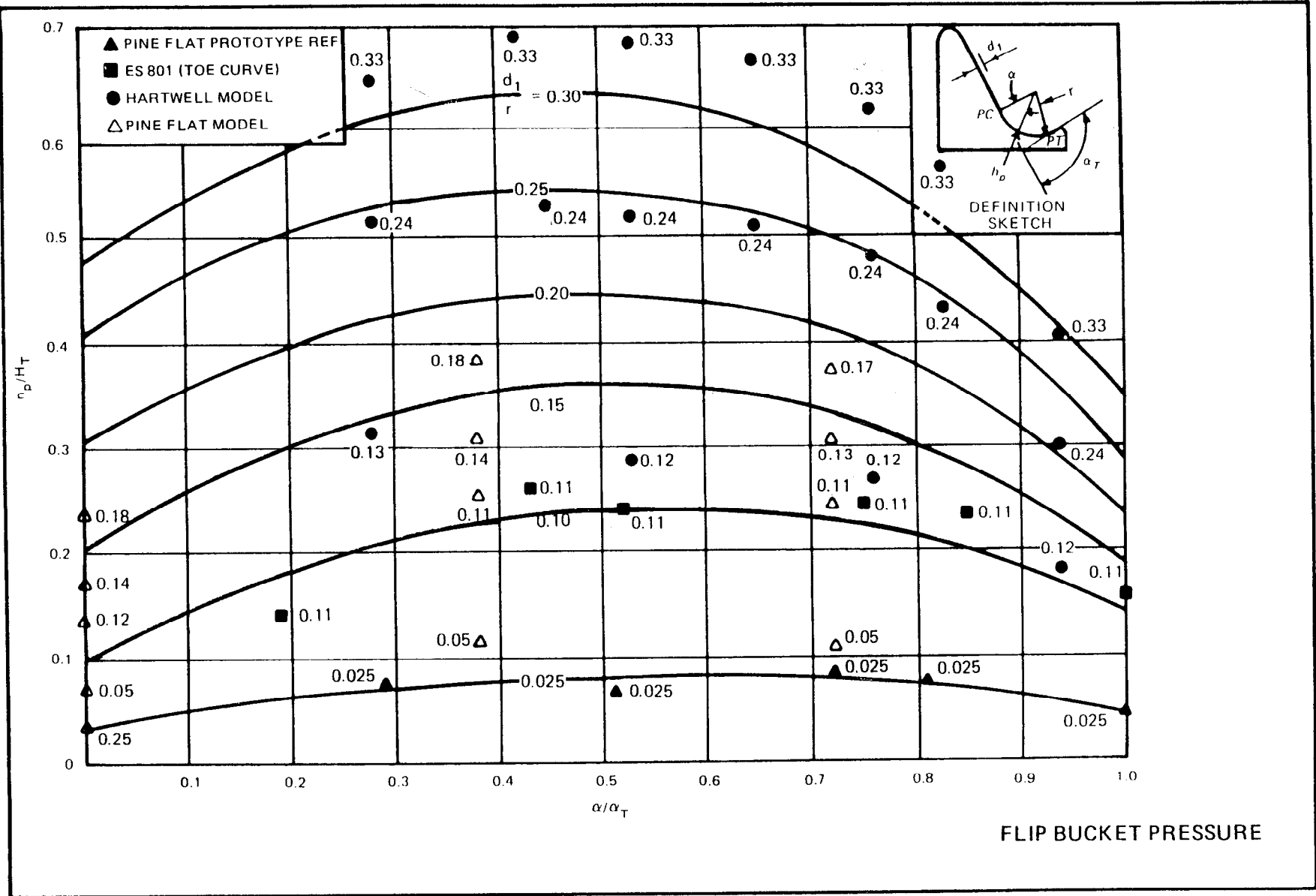

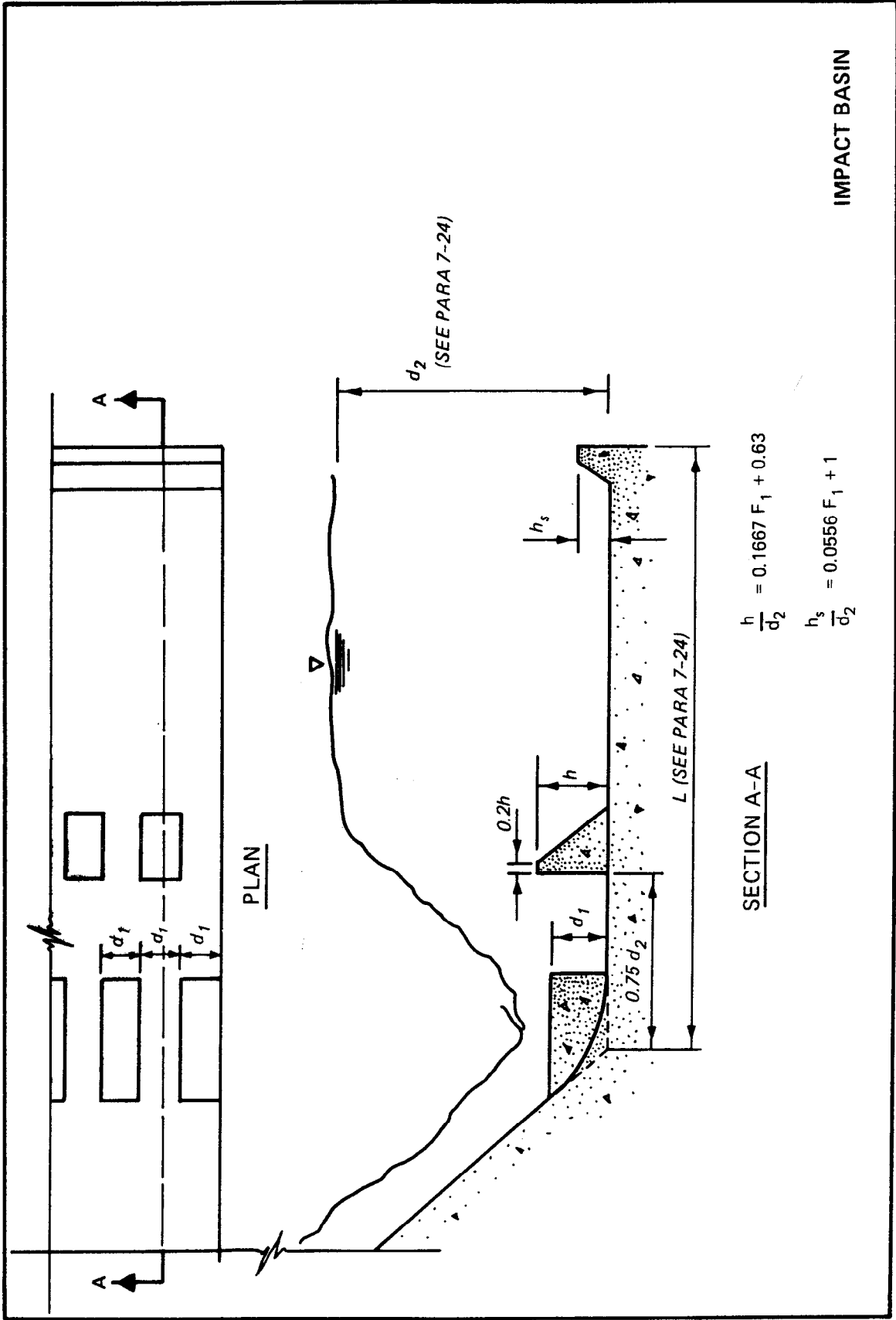

$$\frac{h}{d_2} = 0.1667 F_1 + 0.63$$

$$\frac{h_s}{d_2} = 0.0556 F_1 + 1$$

SECTION A-A

IMPACT BASIN

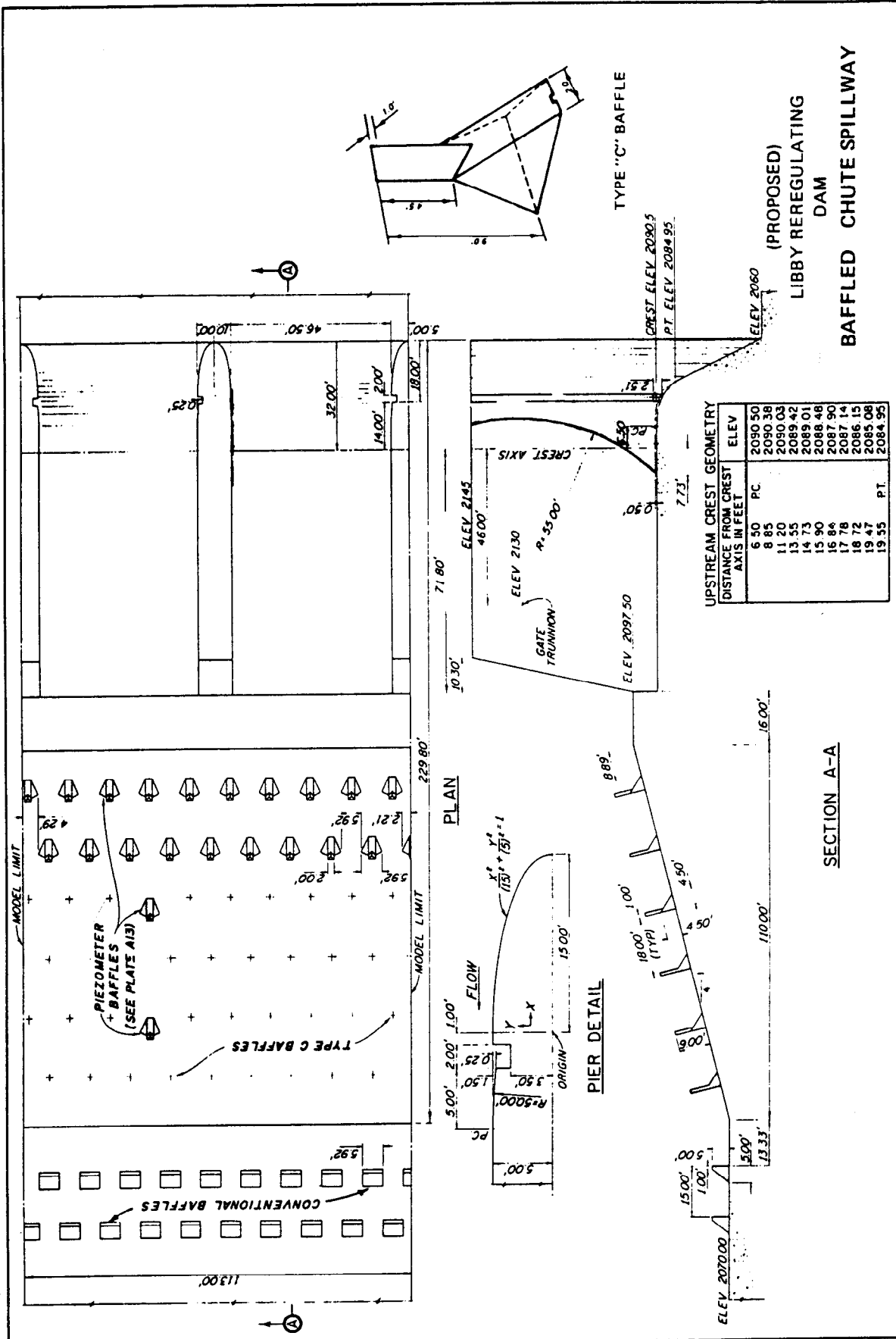

APPENDIX D

COMPUTATIONS FOR DESIGN OF SPILLWAY

D-1. Introduction. The following example will illustrate some of the procedures and guidance provided in this manual for the design of a gated elliptical crest spillway. This example will show the following:

- a. The development of the spillway and gage sizes.
- b. The computation of the spillway discharge rating curve.
- c. The development of the spillway crest equations and upper nappe profile.
- d. The determination of the gate trunnion location.
- e. The determination of hydrostatic pressures that can be expected on the spillway crest surface.

D-2. Computer Programs. The following CORPS system computer programs were used for this example:

- a. H1107, Stage-discharge relation for an elliptical crest spillway
- b. H1108, Crest and upper nappe profiles for elliptical crest spillway
- c. H1109, Pressure distribution for an elliptical crest spillway

The design engineer should periodically check the list of available CORPS programs to determine if additional programs have been added to the system.

D-3. Design Conditions. The following information describes the design criteria and assumptions for this example:

Maximum reservoir elevation	1,500 feet*
Spillway design flood (SDF)	66,200 ft ³ /sec
Spillway piers, type 3	12 feet thick
Spillway upstream face slope	1H:1V
Spillway crest tangent to chute at	1H:1V
Spillway crest elevation	1,458 feet
Tainter gate radius	45 feet

Overflow crest to conform to elliptical upstream crest shape with an H_e/H_c ratio of 1.33 and a P/H_d ratio of 0.5.

* All elevations cited herein are in feet referred to the National Geodetic Vertical Datum (NGVD).

D-4. Computations.

a. The initial step is to determine the size of the spillway bays and the tainter gates.

(1) Spillway bay width

$$Q = CL_e (H_e)^{1.5}$$

$$L_e = L - 2(nK_p + K_a)H_e$$

Pier loss coefficient $K_p = -0.025$ from Plate 3-10

Abutment loss coefficient $K_a = 0.2$ from Plate 3-12

H_e = max pool elevation - crest elevation

$$H_e = 1,500 - 1,458 = 42 \text{ feet}$$

$$H_d = 42(1.33) = 31.57 \text{ feet}$$

$$P = 31.57(0.5) = 15.78 \text{ feet}$$

$$L = L - 2 [1(-0.025) + 0.2] 42$$

$$L_e = L - 14.8$$

Spillway discharge coefficient $C = 3.98$ from Plate 3-3

$$66,200 = 3.98(L - 14.8)(42)^{1.5}$$

$$L = 75.9 \text{ feet, use } 76.0 \text{ feet.}$$

Two spillway bays should be used.

$$\text{Spillway bay width } W_b = L/2 = 76/2 \\ = 38 \text{ feet}$$

(2) Approximate height of spillway tainter gate

$$H_e (\text{max}) = 42 \text{ feet}$$

$$\text{Freeboard} = 2 \text{ feet}$$

Gate seat location, vertical distance below crest apex
= 0.5 feet approximately.

$$\text{Height of gate} = H_e + \text{freeboard} + 0.5$$

$$= 42 + 2 + 0.5 = 44.5 \text{ feet}$$

Gate height to width ratio is approximately 1.2, which conforms to the height to width ratios of the gates described in Table 6-1.

b. Computation of the spillway discharge rating curve for uncontrolled flow over an elliptical-shaped spillway crest will be accomplished using CORPS computer program H1107. This computer program utilizes equations 2-1 and 2-2 and data from the following plates and design assumptions:

(1) Plate 3-3 or 3-4 for spillway discharge coefficients

(2) Plate 3-6 for pier contraction coefficients, and

(3) Plate 3-11 or 3-12 for abutment contraction coefficients

$$(4) H_d = 31.57$$

$$(5) P = 15.78$$

Input and output for H1107 is found at the end of this appendix.

c. The equations that define the shape of the spillway crest curves and the water surface profile over the crest are developed by use of the data provided by CORPS program H1108. Input and output for H1108 is found at the end of this appendix.

(1) The downstream curve equation

$$X^n = KH_d^{n-1} Y \quad (\text{Equation 3-1})$$

$$n = 1.85$$

$$K = 2.05 \text{ from H1108}$$

$$H_d = 31.57$$

$$X^{1.85} = 2.05(31.57)^{0.85} Y$$

$$Y = X^{1.85} / 35.56$$

(2) The upstream curve equation

$$\frac{X^2}{A^2} + \frac{(Y - B)^2}{B^2} = 1 \quad (\text{Equation 3-2})$$

$$A = 7.692, \quad B = 4.514 \text{ from H1108}$$

$$\frac{X^2}{7.692^2} + \frac{(Y - 4.51)^2}{4.514^2} = 1$$

$$X = (-2.9Y^2 + 26.219Y)^{1/2}$$

d. The gate trunnion is now located using the computed crest coordinate and upper nappe surface data. The trunnion is located to clear the water surface of the maximum uncontrolled discharge (paragraph 6-2a) and to prevent surging of the water surface upstream from the gates with gate-controlled conditions (paragraph 3-7).

(1) Use gate radius $r = 45$ feet

(2) Gate radius to gate height ratio = 1.01, which conforms to data presented in Table 6-1.

(3) Determine gate seat location from downstream curve equation:

16 Jan 90

$$Y = X^{1.85}/35.56$$

$$Y = 0.5 \text{ foot (assumed, paragraph D-4a(2))}$$

$$X = 4.95 \text{ feet}$$

(4) Determine trunnion location:

(a) Vertical location: Optimum location for structural purposes is one-third vertical damming height above gate seat.

$$\text{Maximum damming height} = 1,500 - 1,457.5 = 42.5 \text{ feet}$$

$$\text{Optimum trunnion elevation} = 1,457.5 + 42.5/3 = 1,471.7 \text{ feet}$$

$$\text{Set trunnion elevation} = 1,472 \text{ feet}$$

(b) Horizontal location: The trunnion is located at the center of a circle having a radius r of 45 feet. Therefore, the locus of points describing the circle (gate face) can be described by:

$$(X - h)^2 + (Y - v)^2 = r^2$$

with the origin of coordinates located at the crest axis where

X and Y = points on the gate face

h = horizontal distance from the crest axis to the trunnion

v = vertical distance of the trunnion above the crest

Therefore:

$$X = \text{horizontal distance from axis to gate seat} = 4.95 \text{ feet}$$

$$Y = \text{vertical distance from crest to gate seat} = -0.5 \text{ foot}$$

$$V = \text{trunnion elevation} - \text{crest elevation} = 1,472 - 1,458 = 14 \text{ feet}$$

$$(4.95 - h)^2 + (-0.5 - 14)^2 = 45$$

$$h^2 - 9.9h - 1,790.25 = 0$$

$$h = 47.55 \text{ feet downstream from crest axis}$$

(c) Check upper nappe profile from CORPS program H1108 to determine if the trunnion is located above the flow profile.

The profile data for the upper nappe alongside the pier (output H1108) shows that the water surface will be 7.6 feet above the spillway crest (water surface elevation = $1,458 + 7.6 = 1,465.6$) at a horizontal distance downstream from the crest axis of 44.2 feet.

Since the trunnion is located at elevation 1,472 at a horizontal distance of 47.55 feet downstream from the crest axis, it is obvious that the trunnion is located well above the flow profile.

16 Jan 90

(d) Check pool surging criteria (paragraph 3-7). Pier nose to be located at the point where the upstream crest becomes tangent with the dam face.

P_L = distance from upstreammost face of tainter gate to pier nose

P_L = Crest axis to trunnion center-line distance + crest axis to upstream crest tangent point distance (from CORPS Program H1108) - gate radius

$$P_L = 47.55 + 6.63 - 45.0 = 9.18 \text{ feet}$$

H_c = Maximum head on crest where the gate controls the discharge

$$H_c = 0.625(1,500 - 1,458) = 26.25 \text{ feet}$$

Use guideline (a), paragraph 3-7, because $P/H_d < 1$

$$P_L/W_b = 9.18/38 = 0.24$$

Therefore, $W_b \geq 1.1H_c$ is required to control surging

$$W_b/H_c = 38/26.25 = 1.45 > 1.1$$

Pool surging should not occur.

e. The spillway crest shape developed for this example is now checked to determine the pressure regime that would exist on the crest surface during the design flood. The CORPS program H1109 is used for this purpose. The input and output for H1109 is found at the end of this appendix. A review of the output from H1109 shows that for an H_e/H_d ratio of 1.33, minimum crest pressure is -10.7 feet of water, which should be sufficient to preclude cavitation damage.

EM 1110-2-1603
16 Jan 90

* CORPS PROGRAM # H1107 *
* MICRO VERSION # 84/10/23 *

***** CORPS PROGRAM H1107 *****
H1107 WILL PRODUCE A RATING CURVE FOR AN ELLIPTICAL
SPILLWAY CREST DESIGN.
INPUTS ARE:FACE SLOPE CODE,APPROACH DEPTH,DESIGN HEAD,
CREST ELEVATION,ABUTMENT CONTRACTION COEF.,NUMBER AND CONT.
COEF. OF PIERS, AND NUMBER AND ELEVATIONS TO BE USED FOR
CALCULATING THE CURVE.

H1107 GRAPHICS WILL FIT A SPLINE TO THE POINT INPUT.
TO INSURE AN ACCURATE REPRESENTATION OF THE RATING CURVE
MAKE SURE POINTS ARE EVENLY SPACED OVER THE RANGE NEEDED.

DO YOU WANT GRAPHICS? (Y OR N)

N

INPUT H1107

AA-ENTER UPSTREAM FACE SLOPE CODE:

1=1V:1H OR FLATTER, 2=ALL OTHERS

1

AB-ENTER THE APPROACH CHANNEL ELEVATION (FT-NGVD) (PELE)

1442.22

AC-ENTER THE DESIGN HEAD IN FT. ABOVE CREST AXIS(HD)

31.57

AD-ENTER THE NET SPILLWAY LENGTH IN FT.(TW)

(GROSS LENGTH-SUM OF PIER WIDTHS)

76

AE-ENTER THE SPILLWAY CREST ELEVATION IN FT,NGVD.(ELEV)

1458.

AF-ENTER ABUTMENT CONTRACTION COEFFICIENT

SUGGEST: 0.1-CONCRETE OR 0.2-EARTH EMBANKMENT,BOTH WITH SYMMETRIC FLOW
INCREASE FOR FLOW ANGULARITY. SEE HDC 111-3/1 AND 111-3/2.(ABUT)

0.2

AC&ENTER THE NUMBER OF PIERS.(PIERNO)

AH-ENTER THE PIER CONTRACTION COEFFICIENT

SEE HDC CHARTS 111-5,111-6, AND 111-22 FOR GUIDANCE

-.020

AI-ENTER THE NUMBER OF HEAD ELEVS TO BE USED. NOT TO EXCEED 100. (NOHE)

8

AJ-ENTER THE DESIRED HEAD ELEVS IN FT,NGVD, SEPARATED BY COMMAS.(HE)
NOT TO EXCEED THE ABOVE NUMBER.

INSURE HEAD ON CREST IS LESS THAN TWICE DESIGN HEAD FOR
ALL VALUES CHOSEN. (DUE TO EXTRAPOLATION LIMITS.)

1500,1495,1490,1485,1480,1475,1470,1466

AK-INPUT PROJECT NAME

EXAMPLE 1

HARDCOPY IF DESIRED - THEN RETURN

OUTPUT FOR:EXAMPLE 1

SPILLWAY CREST ELEV = 1458.00 FT.
SPILLWAY DESIGN HEAD = 31.57 FT.
SPILLWAY UPSTREAM FACE SLOPE = 1
SPILLWAY APPROACH DEPTH = 15.8 FT.
ABUTMENT CONTRACTION COEFFICIENT = .200
NET SPILLWAY LENGTH = 76.00 FT.
NUMBER OF CREST PIERS = 1
PIER CONTRACTION COEFFICIENT = -.020
SPILLWAY BAY WIDTH = 38.00 FT.
NUMBER HEAD ELEVS SELECTED = 8.
HEAD ELEVS SELECTED (SEE BELOW).

HEAD (FT,NGVD)	HEAD (FT)	DISCHARGE PER BAY(CFS)	DISCHARGE TOTAL(CFS)
1500.00	42.00	33093.	66186.
1495.00	37.00	27912.	55825.
1490.00	32.00	22764.	45529 .
1485.00	27.00	17780.	35560.
1480.00	22.00	13094.	26188.
1475.00	17.00	8845.	17689.
1470.00.	12.00	5178.	10355.
1465.00	7.00	2259.	4517.

EM 1110-2-1603
16 Jan 90

* CORPS PROGRAM # H1108 *
* MICRO VERSION # 84/10/14 *

H1108 WILL DESIGN AN ELLIPTICAL UPSTREAM QUADRANT SPILLWAY AND PROVIDE BOTH UP- AND DOWNSTREAM CREST COORDINATES. THE REQUIRED INPUT IS: AVG. APPROACH DEPTH (AB), DESIGN HEAD (AC) UP- AND DOWNSTREAM FACE SLOPES (AD AND AE), X INCREMENT (AF), WHETHER OR NOT PIERS ARE PRESENT (AG), AND THE ACTUAL HEAD ON THE CREST (AH).

H1108 WILL ALSO PROVIDE COORDINATES FOR THE UPPER NAPPE SURFACE OF SPILLWAYS DESIGNED USING THE ELLIPTICAL UPSTREAM QUADRANT DESIGN PROCEDURE.
EXPERIMENTAL VALUES WERE DETERMINED AT P/HD=0.26,0.5, AND 1.0 AND H/HD VALUES OF 0.5,1.0 AND 1.5. NO 1.5 VALUE IS AVAILABLE FOR P/HD LESS THAN 0.6,

H1108 WILL INTERPOLATE AND EXTRAPOLATE LINEARLY FOR OTHER VALUES OF P/HD AND HE/HD

LIMITS ARE: $0.2 < P/HD$ AND $0.25 < HE/HD < 2.0$
EXCEPT WHEN $P/HD < 0.5$ HE/HD MUST BE LESS THAN 1.34
AND WHEN $HE/HD > 1.0$ P/HD MUST BE GREATER THAN 0.33

DO YOU WANT GRAPHICS? (Y OR N)

N

WANT GRID OR TIC AXES? (G OR T)

T

AA-INPUT THE NAME OF THE SPILLWAY DESIGN

EXAMPLE

AB-INPUT AVG. CHANNEL APPROACH DEPTH-P (FT)

(DIFFERENCE BETWEEN CREST ELEV. AND APPROACH CHANNEL ELEV.)

15.78

AC-INPUT DESIGN HEAD-HD (FT)

31.57

AD-INPUT THE UPSTREAM FACE SLOPE (V,H) (1,0=VERT)

1,1

AE-INPUT THE DOWNSTREAM FACE SLOPE (V,H)

1,1

AF-INPUT THE X (HORIZONTAL) INCREMENT-XINC (FT)

2

AG-DOES THE SPILLWAY HAVE PIERS? (Y OR N)

Y

AH-ACTUAL HEAD ON CREST-HE(FT)

42

HARDCOPY IF DESIRED-THEN RETURN

OUTPUT FOR:EXAMPLE

FOR CREST COORDINATES: +X TO THE RIGHT AND +Y DOWNWARD

APPROACH DEPTH (FT)= 15.78
DESIGN HEAD (FT)= 31.57
UPSTREAM FACE SLOPE= 1.00V: 1.00H
DOWNSTREAM FACE SLOPE= 1.00V: 1.00H
A AND B IN ELLIPSE EQUATION= 7.692 4.514
K IN D.S. EQN= 2.060

COORDINATES OF UPSTREAM TANGENT POINT (X,Y)= -6.63, 2.23

COORDINATES FOR DOWNSTREAM TANGENT POINT (X,Y)= 35.61, 19.25

UPSTREAM COORDINATES

X	Y
.000	.000
-2.000	155
-4.000	:658
-6.000	1.689
-6.636	2.229
-8.000	3.595
-10.000	5.595
-12.000	7.596
-14.000	9.595
-16.000	11.595
-18.000	13.595
-20.000	15.595
-20.186	15.780

DOWNSTREAM COORDINATBS

X	Y
.000	.000
2.000	.094
4.000	.337
6.000	.714
8.000	1.215
10.000	1.836
12.000	2.573
14.000	3.422
16.000	4.381
18.000	5.447
20.000	6.620
22.000	7.896
24.000	9.275
26.000	10.756
28.000	12.336
30.000	14.016
32.000	15.793
34.000	17.668
35.615	19.251

EM 1110-2-1603

16 Jan 90

UPPER NAPPE OUTPUT

DESIGN HEAD (FT)= 31.570
ACTUAL HEAD (FT)= 42.000
APPROACH DEPTH (FT)= 15.780
P/HD= .4998
HE/HI)= 1.330

THE ORIGIN OF THE WATER-SURFACE ELEVATION COORDINATES IS LOCATED
AT THE CREST WITH +X TO THE RIGHT AND +Y UPWARD.

UPPER NAPPE ELEVATIONS WITH PIERS(FT)

	BAY C.L.		ALONG PIERS
X	Y		Y
-31.57	33.478		35.732
-25.26	33.214		35.437
-18.94	32.604		34.964
-12.63	31.761		34.312
-6.31	30.564		33.501
.00	28.840		32.353
6.31	26.808		30.721
12.63	24.030		28.583
18.94	20.871		25.942
25.26	16.659		22.761
31.57	11.533		18.920
37.88	5.627		14.275
44.20	-.890		7.612

ENTER END OR RERUN

END

stop - Program terminated.

* CORPS PROGRAM # H1109 *
* MICRO VERSION # 84/10/23 *

***** CORPS H1109 *****

H1109 WILL CALCULATE PRESSURES ON CRESTS DESIGNED USING THE ELLIPTICAL CREST SPILLWAY DESIGN PROCEDURE. PRESSURE DISTRIBUTIONS WERE MEASURED OVER A RANGE OF X/HD FROM -0.22 TO 1.0, P/HD FROM 0.25 TO 3.4, HE/HD FROM 0.5 TO 1.5, AND FOR VERTICAL AND 1:1 UPSTREAM FACE SLOPES. NO 1:1 VALUES ARE AVAILABLE FOR P/HD OF 3.4.

DUE TO THE IRREGULAR NATURE OF PRESSURE VARIATION WITH P/HD AND HE/HD H1109 WILL NOT INTERPOLATE FOR INTERMEDIATE VALUES. INTERMEDIATE VALUES CAN BE ESTIMATED BY RUNNING H1109 SEVERAL TIMES FOR THE VALUES DESIRED AND THEN EITHER VISUALLY OR MATHEMATICALLY INTERPOLATING.

DO YOU WANT GRAPHICS? (Y OR N)
N

INPUT H1109
AA-ENTER DESIGN HEAD,FT.
31.57
AB-P/HD RATIO:0.25,0.5,1.0,OR 3.4
0.5
AC-DOES THE SPILLWAY HAVE PIERS? (Y OR N)
Y
AD-WANT VERTICAL OR 1:1 UPSTREAM FACE SLOPE (1=VERT,2=1:1)?
2
AF-ENTER NAME OF DESIGN PROBLEM
EXAMPLE

HARDCOPY IF **DESIRED** - THEN RETURN

EM 1110-2-1603
 16 Jan 90

OUTPUT FOR: EXAMPLE

DESIGN HEAD (FT)= 31.570
 APPROACH DEPTH (FT)= 15.785
 P/HD= .5000

***** 1:1 UPSTREAM FACE *****

THE ORIGIN OF THE CREST PRESSURE COORDINATES IS LOCATED
 AT THE CREST WITH +X TO THE RIGHT AND +Y UPWARD.

CREST PRESSURES-CENTER LINE-(FT)						
X	H/HD=0.50	H/HD=1.00	H/HD=1.17	H/HD=1.33	H/HD=1.50	
-6.95	15.78	18.31	15.78	20.84	20.84	
-6.31	14.62	16.73	14.52	18.94	15.78	
-5.68	13.89	15.78	13.89	17.99	11.68	
-4.74	11.05	12.63	9.79	7.58	3.16	
-3.16	9.16	8.52	6.31	3.16	2.21	
-1.58	8.84	5.68	3.16	-.32	-6.00	
.00	8.52	7.89	4.74	.32	-4.74	
3.16	7.58	6.31	3.16	000	-5.37	
6.31	6.63	5.37	2.21	-.63	-6.31	
9.47	6.31	5.37	2.53	.00	-6.31	
15.78	5.05	4.10	2.53	-.32	-4.74	
22.10	3.79	2.84	1.26	-1.26	-5.05	
31.57	3.47	2.84	1.58	-.32	-3.16	

CREST PRESSURES-ALONG PIER-(FT)						
X	H/HD=0.50	H/HD=1.00	H/HD=1.17	H/HD=1.33	H/HD=1.50	
-6.95	17.05	28.41	25.26	24.31	23.68	
-6.31	16.10	24.94	22.10	20.84	22.10	
-5.68	14.84	22.10	18.94	17.36	18.94	
-4.74	12.63	16.42	15.78	12.63	12.63	
-3.16	9.47	6.63	3.16	-.95	-6.31	
-1.58	6.95	.95	-5.05	-10.73	-19.89	
.00	6.31	.95	-3.47	-9.47	-17.99	
3.16	6.00	2.84	-1.26	-6.31	-13.26	
6.31	5.37	3.47	.32	-4.42	-10.10	
9.47	5.05	4.10	1.89	-2.21	-7.26	
15.78	4.10	4.10	2.84	00	-4.42	
22.10	3.16	3.16	1.58	-.32	-3.47	
31.57	2.84	2.21	1.26	-.63	-2.21	

ENTER END OR RERUN

END

stop - Program terminated.

APPENDIX E

COMPUTATIONS FOR THE DESIGN OF
A STILLING BASIN

E-1. Introduction. This example is used to illustrate the procedures and guidance provided by this engineering manual for the design of a hydraulic jump-type stilling basin energy dissipator. This stilling basin to be designed for this example is for the spillway crest design example described in Appendix D. This stilling basin design example will include the following:

- a. The determination of energy loss from the reservoir to the entrance of the basin.
- b. The stilling basin design.
- c. The computation of dynamic loads imposed on the stilling basin walls,
- d. The exit channel design.

E-2. Computer Programs. The CORPS computer programs are used where applicable for this example and are noted throughout. The design engineer should periodically check the available CORPS programs to determine if additional programs have been added to the system.

E-3. Design Considerations. Site topography and geologic considerations require a 500-foot-long chute between the intersection of spillway face and the drop into the stilling basin (Figure E-1). The site geology will allow the spillway, chute, and stilling basin to be founded on sound rock. Erosional damage to the river banks downstream from the basin is unacceptable. The following data are required for the example:

Spillway design flood tailwater elevation	1,330 feet*
Elevation of the intersection of the spillway face and chute	1,400 feet
Elevation of river channel at the stilling basin location	1,290 feet
Concrete surface roughness	
For velocity computations	0.002 foot
For depth computations	0.007 foot

E-4. Computations.

- a. Determine the energy loss on the spillway face and the depth of flow

* All elevations cited herein are in feet referred to the National Geodetic Vertical Datum (NGVD).

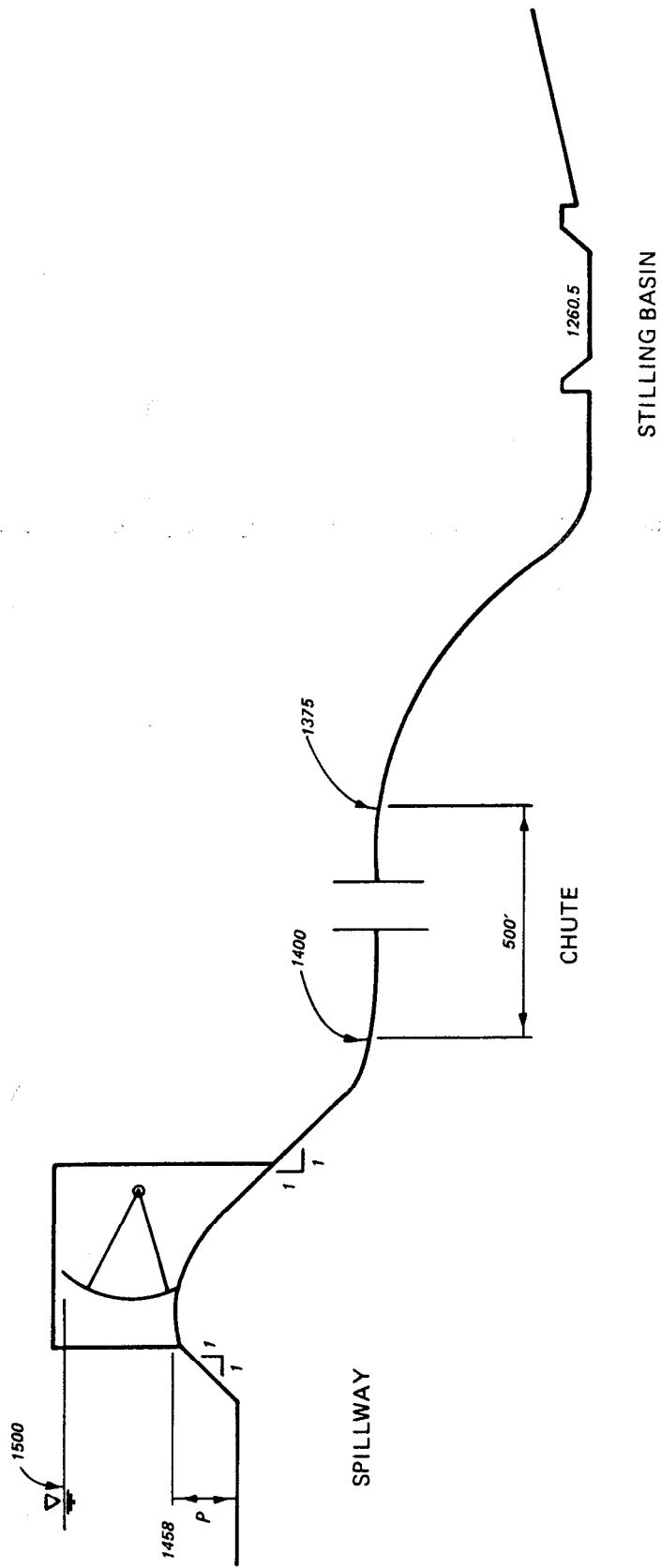

STILLING BASIN
CHUTE
STILLING BASIN

Figure E-1. Stilling basin design problem site geometry

at the intersection of the spillway face and the spillway chute using the procedures described in paragraph 2-11.

(1) Boundary geometry computations

(a) The longitudinal length L_c of the curved portion of the spillway crest can be determined using HDC 111-18/1

$$\begin{aligned} X &= \text{horizontal distance from crest axis to downstream point} \\ &\quad \text{of tangent from data derived for Appendix D} \\ x &= 35.61 \text{ feet} \\ H_d &= 31.57 \text{ feet (from Appendix D)} \\ X/H_d &= 35.61/31.57 = 1.13 \\ L_c/H_d &= 1.65 \text{ (from HDC 111-18/1)} \\ L_c &= 1.65(31.57) = 52.1 \text{ feet} \end{aligned}$$

(b) Length of tangent L_T , from the spillway tangent point to the spillway toe

$$\begin{aligned} L_T &= (\Delta \text{ elev change})/\sin \alpha \\ \alpha &= \tan^{-1} 1 = 45 \text{ degrees} \\ \text{elev} &= \text{elev of tangent point} - \text{elev of toe} \\ &= 1,458 - 19.25 - 1,400 \\ &= 38.75 \text{ feet} \\ L_T &= 38.75/0.707 = 54.8 \text{ feet} \end{aligned}$$

(c) Total crest length

$$L = L_c + L_T = 52.1 + 54.8 = 106.9 \text{ feet}$$

(2) Hydraulic computation

(a) Boundary layer thickness

$$\frac{L}{k} = \frac{106.9}{0.002} = 0.535 \times 10^5$$

$$\frac{\delta}{L} = 0.08 \left[\frac{L}{k} \right]^{-0.233} \quad (\text{Equation 2-19})$$

$$= 0.08 (0.535 \times 10^5)^{-0.233}$$

$$= 0.0063$$

$$\delta = 0.0063(106.9) = 0.68 \text{ foot}$$

(b) Energy thickness δ_3

$$\delta_3 = 0.22 \quad (\text{Equation 2-21})$$

$$= 0.22(0.68) = 0.15 \text{ foot}$$

(c) Unit discharge q

$$q = Q/L_g$$

$$L_g = \text{gross spillway width}$$

$$= 76 + 12 = 88 \text{ feet}$$

$$q = 66,200/88 = 752 \text{ ft}^3/\text{sec}$$

(d) Potential depth d_p and potential velocity u at toe

$$h_T = d_p \cos \theta + \frac{u^2}{2g} \quad (\text{Equation 2-22})$$

$$\cos \theta = 0.707$$

$$h_T = 1,500 - 1,400 = 100 \text{ feet}$$

By trial:

u ft/sec	$u^2/2g$ feet	$h_T - u^2/2g$ feet	$d_p = \frac{h_T - u^2/2g}{0.707}$ feet	$q = ud_p$ ft ³ /sec
75	87.3	12.7	17.9	1,342 > 752
79	96.9	3.1	4.4	348 < 752
77.4	93.0	7.0	9.9	763 \approx 752

(e) Spillway energy loss

$$H_L = \frac{\delta_3 u^3}{2gq} \quad (\text{Equation 2-23})$$

$$= \frac{0.15(77.4)^3}{2(32.2)(752)} = 1.4 \text{ feet}$$

(f) Energy head at toe of spillway H_{toe}

$$H_{\text{toe}} = 1,500 - 1,400 - 1.4$$

$$= 98.6 \text{ feet}$$

(g) Depth of flow at toe of spillway d

$$d = d_p + \delta_1 \quad (\text{Equation 2-24})$$

$$\delta_1 = 0.18\delta$$

$$= (0.18)(0.68) = 0.12 \text{ foot}$$

$$d = 9.9 + 0.12$$

$$= 10.0 \text{ feet}$$

b. Calculate Flow Characteristics Throughout the Spillway Chute

(1) Compute flow characteristics (depth, velocity, etc.) throughout the 500-foot-long constant slope portion of the chute using CORPS program H6209, and compute the flow characteristics throughout the trajectory portion of the chute, which immediately precedes the stilling basin. At present there is no CORPS program available for the computation of the flow characteristics on the trajectory slope; however, a number of standard step drawdown programs are available which will handle a variable-sloped channel. The computations for this example were made using the Seattle District program G3722040. Two sets of flow computations for each portion of the chute must be made: the first set, incorporating a relatively low resistance coefficient, will be used to determine design velocities and depths necessary for sizing the stilling basin and the chute floor trajectory shape. The second set, incorporating a relatively high resistance coefficient, will be used for chute wall height design. For brevity, only the first set of computations is included for this example and is found at the end of this appendix.

(2) Resistance Coefficients for Spillway Chute Floor. Paragraph 2-10e recommends effective roughness values of 0.002 foot and 0.007 foot for velocity design and discharge design, respectively. Converting these values to resistance coefficients for use in any of the energy loss methods described in paragraph 2-10 requires that the hydraulic radius be known. However, since the resistance coefficient is not highly sensitive to the hydraulic radius, a computation of the flow characteristics using a reasonably close approximation of the resistance coefficient will provide a sufficiently accurate hydraulic radius from which to compute the design resistance coefficients. Manning's method (see paragraph 2-10d) was selected to determine the energy loss through the chute, and the first approximation of n value was 0.011. This value resulted in a depth of flow on the 500-foot portion of the chute which ranged between 9 and 10 feet and on the trajectory portion between 6 and 9 feet. A reasonable average hydraulic radius for these depths on the 88-foot-wide chute is

$$R = A/\text{wetted parameter}$$

$$= \frac{88(9.5)}{88 + 2(7.5)} = 7.8 \text{ for the chute}$$

$$= \frac{88(7.5)}{88 + 2(7.5)} = 6.4 \text{ for the trajectory}$$

Using the Colebrook-White equation 2-6

$$f = \left[\frac{1}{2 \log \left(\frac{13.8R}{k} \right)} \right]^2$$

When $k = 0.002$ and $R = 7.8$: $f = 0.011$

When $k = 0.002$ and $R = 6.4$: $f = 0.012$

Using equation 2-17

$$n = \frac{f^{1/2} R^{1/6}}{10.8}$$

When $f = 0.011$ and $R = 7.8$: $n = 0.014$

When $f = 0.012$ and $R = 6.4$: $n = 0.014$

(3) Parabolic Shape for Chute Invert. The transition for a flatter slope to a steeper slope is discussed in paragraph 4-6 and the equation 4-5 is recommended for this transition. The parabolic invert shape will be used for the entire short portion of the chute between the end of the 500-foot-long constant slope chute and the stilling basin. The equation for the invert is

$$Y = -X \tan \phi - \frac{gX^2}{2(1.25V)^2 \cos^2 \phi}$$

with

$$Y = 78.8 \text{ ft/sec}$$

$$Y = -0.0875X - 0.00167X^2$$

(4) Stilling Basin Design.

(a) Floor Elevation. The basin floor (apron) elevation will be set to develop 100 percent of the conjugate depth d_2 at the spillway design flood discharge of 66,200 ft³/sec. By a trial procedure which involves assuming a basin elevation and the flow characteristic computations for the trajectory portion of the chute, the entering depth d_1 and velocity V_1 can be determined, from which the entering Froude number F_1 and required tailwater depth d_2 can be determined by equations 2-27 and 2-26, respectively. The required tailwater elevation is then compared to the actual tailwater elevation; when the required and actual elevations coincide, the basin apron elevation is set. Table E-1 illustrates the procedure.

(b) Basin length. The entering Froude number F_1 of 7.7 is sufficiently high to indicate potential cavitation problems around baffles (see paragraph 7-7a); therefore, baffles will not be used in this design.

TABLE E-1

Apron Elevation Computation

Apron Elevation (1)	Y feet (2)	X feet (3)	d ₁ feet (4)	V ₁ ft/sec (5)	F ₁ feet (6)	Required d ₂ feet (7)	D _{TW} feet (8)
1,250.0	125.0	248.6	6.5	115.4	8.0	70.4	80.0
1,258.0	117.0	239.8	6.6	113.6	7.8	69.8	72.0
1,260.5	114.5	237.0	6.7	113.0	7.7	69.7	69.5

- Notes: (1) Assume apron elevation.
 (2) Elevation of Y = 0 at start of parabolic drop (1,375) - apron elevation.
 (3) From trajectory equation: $Y = -0.0875X - 0.00167X^2$.
 (4)(5) From flow characteristics computation page.
 (6) $F_1 = \frac{V_1}{(gd_1)^{1/2}}$.
 (7) $d_2 = 0.5d_1 \left[\left(1 + 8 F_1^2\right)^{1/2} - 1 \right]$.
 (8) Tailwater depth (1,330.0) - apron elevation (1).

$$L_b = Kd_1 F_1^{1.5} \quad (\text{Equation 7-1 and Table 7-1})$$

$$= 1.7(6.7)(7.7)^{1.5}$$

$$= 243 \text{ feet}$$

(c) End Sill

(1) Height = $d_1/2$ or $d_2/12$, whichever (paragraph 7-8) is less

$$d_1/2 = 6.7/2 = 3.4 \text{ feet}$$

$$d_2/12 = 69.7/12 = 5.8 \text{ feet}$$

use height = 3.5 feet

(2) Top of end sill elev = 1,260.5 + 1,264.0

(3) Shape - upstream face to be sloped
1V:1H to minimize potential for debris trapping

(d) Determine basin wall pressures at X = 100 feet downstream from intersection of chute and basin apron (see paragraph 2-14)

- (1) Determine average minimum unit force

$$\begin{aligned} R_m &= 3.75H_s^{-1.05} \rho V_1 q F_1^{-1.42} && \text{(Equation 2-36)} \\ &= 3.75(200)^{-1.05} (1.94)(113)(752.3)(7.7)^{-1.42} \\ &= 130.9 \text{ pounds per foot (lb/ft) of wall} \end{aligned}$$

- (2) Determine static unit force due to d_2

$$\begin{aligned} R_s &= 0.5\gamma d_2^2 \\ &= 0.5(62.4)(69.2)^2 \\ &= 149,400 \text{ lb/ft} \end{aligned}$$

Assuming the jump length equal to basin length,

$$X/L_b = 100/243 = 0.41$$

- (3) Average Unit Force R

$$\begin{aligned} \frac{R - R_m}{R_s - R_m} &= 0.42 && \text{(from Plate 2-4)} \\ R &= 0.42 (149,400 - 131) + 131 \\ &= 62,800 \text{ lb/ft} \end{aligned}$$

- (4) Minimum Unit Force R_-

$$\begin{aligned} \frac{R_- - R_m}{R_s - R_m} &= 0.19 && \text{(from Plate 2-4)} \\ R_- &= 0.19 (149,400 - 131) + 131 \\ &= 28,500 \text{ lb/ft} \end{aligned}$$

- (5) Maximum Unit Force R_+

$$\begin{aligned} \frac{R_+ - R_m}{R_s - R_m} &= 0.68 && \text{(from Plate 2-4)} \\ R_+ &= 0.68 (149,400 - 131) + 131 \\ &= 101,600 \text{ lb/ft} \end{aligned}$$

(6) Maximum Unit Moment M

$$Y/d_{TW} = 0.34 \quad (\text{from Plate 2-5})$$

$$d_{TW} = 1,330 - 1,260.5 = 69.5 \text{ feet}$$

$$Y = 0.34 (69.5) = 23.6 \text{ feet}$$

$$M = 101,600(23.6) = 2.4 \times 10^6 \text{ ft/lb}$$

(e) Exit channel design.

(1) Width

$W = W_b + 5 \text{ feet on each side, or } W_b + (0.15)(d_2) \text{ on each side, whichever is larger (paragraph 7-11b)}$

$$W = 88 + 2(5) \text{ or } 88 + 2(0.15)(69.5) \\ = 98 \text{ or } 108.8$$

$$W = 110 \text{ feet}$$

(2) Length

$$\text{Slope} = 1V:10H$$

The channel elevation adjacent to the basin end sill will be set at elevation 1,263.3 or 0.7 foot below top of end sill

$$L = 10 (\text{natural channel elevation} - 1,263.3) \\ = 10 (1,290 - 1,263.3) \\ = 267 \text{ feet}$$

(3) Erosion Protection

$$\text{Velocity over end sill} = q/\text{depth} \\ = 752.3/(1,330 - 1,264) \\ = 11.4 \text{ ft/sec}$$

$$d_{50}(\text{min}) = 1.8 \text{ feet (HDC 712-1)}$$

Assuming specific stone weight (γ_s) = 155 lb/ft³

$$W_{50}(\text{min}) = 500 \text{ pounds}$$

$$W_{100} \text{ range} = 2W_{50} \text{ to } 5W_{50}$$

EM 1110-2-1603
16 Jan 90

= 1,000 to 2,500 pounds

$$D_{100} \text{ range} = \left(\frac{6W}{\pi \gamma_s} \right)^{1/3}$$

= 2.3 - 3.2 feet

Thickness $t = 2d_{50}$ or $1.5d_{100}$, whichever is greater

$$2d_{50} = 2(1.8) = 3.6 \text{ feet}$$

$$1.5d_{100} = 1.5(3.2) = 4.8 \text{ feet}$$

Riprap thickness = 5.0 feet

```
*****  
* CORPS PROGRAM # H6209 *  
* MICRO VERSION # 83/10/01 *  
*****
```

INPUT H6209-FLOW PROFILES IN PRISMATIC CHANNEL.

AA-ENTER DESIRED RESISTANCE LAW AS: MANN=MANNING, CHEZ=CHEZY, OR
COLE=COLEBROOK-WHITE.

MANN

AC-ENTER DISCHARGE IN CFS.

66200.

AD-ENTER VALUE OF RESISTANCE COEFFICIENT.

0.014

AE-ENTER CHANNEL INVERT SLOPE IN FT/FT.

0.05

AF-ENTER CHANNEL BOTTOM WIDTH IN FT. ENTER 0.0 IF TRIA. CROSS-SECTION.

88.0

AC-ENTER CHANNEL SIDE SLOPE AS COTANGENT OF ACUTE ANGLE WITH
HORIZONTAL. ENTER 0.0 IF RECTANGULAR SECTION.

0.0

AH-ENTER CHANNEL LENGTH IN FT.

500.0

AI-ENTER INTERVAL FOR WHICH DEPTHS ARE TO BE COMPUTED IN FT.
NOTE: CHANNEL LENGTH/INTERVAL CANNOT EXCEED 500. FURTHERMORE
THE INTERVAL IS AUTOMATICALLY ADJUSTED SMALLER TO OBTAIN
ACCURACY OF 0.01 FT. IN COMPUTED DEPTH.

50.0

AJ-ENTER THE INITIAL DEPTH IN FT.

10.0

AK-ENTER INITIAL DEPTH STATION NUMBER IN FT FROM POINT OF BEGINNING.

35.61

AL-ENTER DIRECTION STATION NUMBERS INCREASING AS DS = DOWNSTREAM
us = UPSTREAM.

DS

AM-ENTER ELEVATION OF CHANNEL INVERT AT INITIAL DEPTH STATION
IN FT ABOVE MSL.

1400.0

AN-ENTER ENERGY COEFFICIENT (ALPHA).

1.0

AO-STORE OUTPUT FOR GRAPHICS AND/OR OTHER USE?
ENTER Y OR N

N

CHANGE ANY INPUT BEFORE RUN?

EM 1110-2-1603
16 Jan 90

ENTER Y OR N
N
OUTPUT-H6209

FLOW PROFILE IN RECT CHANNEL USING MANN RESISTANCE LAW WITH THE
FOLLOWING GIVEN DESIGN DATA.

DISCHARGE: 66200.00 CFS
CHANNEL WIDTH: 88.00 FT.
INVERT SLOPE: .05000 FT/FT.
SIDE SLOPE: .00H:1V
RESISTANCE COEF: .01400
CHANNEL LENGTH: 500.00 FT.
ALPHA: 1.00

FLOW PROFILE WITH FOLLOWING CHARACTERISTICS:

CHANNEL SLOPE CLASSIFICATION: STEEP
ZONE DESIGNATION: 52
CURVE TYPE: DRAWDN
FLOW TYPE: SUPERC

NORMAL DEPTH: 8.54 FT.
CRITICAL DEPTH: 26.00 FT.
CRITICAL SLOPE: .001782 FT/FT.

STATION NO.	INVERT ELEV (MSL)	WATER DEPTH (FT)	WATER SURF ELEVATION (MSL)	FLOW VELOCITY (FPS)	VELOCITY HEAD (FT)	SPECIFIC ENERGY (FT)
0+35.61	1400.000	10.000	1410.000	75.227	87.875	97.875
0+85.61	1397.500	9.942	1407.443	75.663	88.895	98.838
1+21.22	1395.719	9.903	1405.623	75.964	89.603	99.507
1+71.22	1393.219	9.850	1403.069	78.374	90.573	100.423
2+21.22	1390.719	9.799	1400.519	76.769	91.515	101.314
2+71.22	1388.219	9.751	1397.970	77.152	92.428	102.179
3+21.22	1385.719	9.704	1395.424	77.521	93.315	103.019
3+71.22	1383.219	9.660	1392.879	77.878	94.176	103.836
4+21.22	1380.719	9.617	1390.337	78.222	95.011	104.628
4+71.22	1378.219	9.576	1387.796	78.555	95.822	105.398
5+21.22	1375.719	9.537	1385.257	78.877	96.608	106.145
5+35.61	1375.000	9.526	1384.526	78.967	96.830	106.356

ENTER END OR RERUN

END
stop - Program terminated.

EXAMPLE PROBLEM

DISCHARGE= 66200.

DEPTH SUPPLIED

STATION BOTTOM ELEVATION

0. 1375.

BOTTOM	CHAN	BED	SLOPE	N-COEF
WIDTH	S.S.			ROUGH
88.00	0.00	0.050000		0.014

DEPTH	VELOCITY	FRI(SLOPE ENERGY G.L.)									
9.50000	79.18660	0.035902	1481.87								
STA	WSEL	CBE	DEPTH	SLOPE	VEL	F	SLOPE	W	B	C	Z
25.	1381.24	1371.77	9.39	0.12920	80.15	0.0373		88.0			0.00
51.	1375.63	1366.24	9.17	0.21280	82.02	0.0400		88.0			0.00
75.	1368.44	1359.12	8.91	0.29640	84.47	0.0439		88.0			0.00
100.	1359.77	1350.63	8.62	0.33960	87.30	0.0486		88.0			0.00
125.	1347.33	1338.05	8.23	0.50320	91.45	0.0562		88.0			0.00
150.	1333.41	1324.38	7.86	0.54680	95.68	0.0647		88.0			0.00
175.	1317.56	1308.62	7.50	0.63040	100.30	0.0750		88.0			0.00
200.	1299.66	1290.81	7.15	0.71240	105.2?	0.0872		88.0			0.00
225.	1279.67	1270.88	6.82	0.79720	110.37	0.1014		88.0			0.00
250.	1257.60	1248.86	6.50	0.88080	115.70	0.1177		88.0			0.00
275.	1233.45	1224.75	6.21	0.96440	121.13	0.1361		88.0			0.00

APPENDIX F

COMPUTATION FOR DESIGN OF FLIP BUCKET
AND ROLLER BUCKET

F-1. Introduction. The following example will illustrate some of the procedures and guidance provided by this manual for the design of flip buckets and roller buckets. The example will show:

- a. Computations for design of flip bucket geometry.
- b. Computation of pressure acting on the invert of the flip bucket.
- c. Computation of the flip bucket jet trajectory.
- d. Computations for design of a roller bucket.

F-2. Design Considerations. Alternative designs for a flip bucket at the downstream end of the chute spillway described in Appendix E and a roller bucket at the toe of an overflow spillway similar to that described in Appendix D are required. Design criteria and geometric conditions are:

Spillway face slope	1V:1H
Chute slope S	0.05 ft/ft
Chute and flip bucket width	88 feet
Discharge	66,200 ft ³ /sec
Depth of flow entering bucket d ₁	9.5 feet
Bucket invert elevation	1,375 feet*
Spillway design flood tailwater elevation	1,330 feet
Allowable foundation bearing pressure	2 kips/ft

F-3. Computations.

- a. Flip Bucket Geometry. See Paragraph 7-18.

(1) Bucket radius.

$$r_{\min} = \frac{\rho V_1^2 d_1}{P_T - \gamma d_1} \quad (\text{Equation 7-3})$$

$$v = \frac{Q}{A} = \frac{66,200}{(88)(9.5)} = 79.2 \text{ ft/sec}$$

$$r_{\min} = \frac{1.94(79.2)^2 (9.5)}{2,000 - 62.4(9.5)} = 82 \text{ feet}$$

Use r = 100 feet

* All elevations cited herein are in feet referred to the National Geodetic Vertical Datum (NGVD).

16 Jan 90

(2) Minimum bucket height.

$$h_{\min} = r - r \cos (\phi - \tan^{-1} S) \quad (\text{Equation 7-4})$$

where

$$\begin{aligned} \phi &= \tan^{-1} \left\{ \frac{[d_1(2r - d_1)]^{1/2}}{r - d_1} \right\} \\ &= \tan^{-1} \left(\frac{\{9.5[(2)(100) - 9.5]\}^{1/2}}{100 - 9.5} \right) \\ &= 25.2' \end{aligned}$$

$$\begin{aligned} h_{\min} &= 100 - 100 \cos (25.2 - \tan^{-1} 0.05) \\ &= 7.48 \text{ feet} \end{aligned}$$

Use $h = 7.5$ feetand elevation = $1,375 + 7.5 = 1,382.5$

(3) Trajectory angle resulting from the minimum flip bucket height. Angles greater than the minimum can be used by increasing the bucket height.

$$\begin{aligned} h &= r - r \cos \theta \quad (\text{Equation 7-5}) \\ &= \cos^{-1} \left(\frac{r - h}{r} \right) \\ &= \cos^{-1} \left(\frac{100 - 7.5}{100} \right) \\ &= 22.3^\circ \end{aligned}$$

b. Flip Bucket Jet Trajectory Characteristics

(1) Horizontal distance, lip to impact area

$$\begin{aligned} X_H &= h_e \sin 2\theta + 2 \cos \theta \left[h_e (h_e \sin^2 \theta + Y_1) \right]^{1/2} \\ &= 217.3 \text{ feet} \end{aligned}$$

(2) Impact angle

$$\begin{aligned} \theta' &= \tan^{-1} \left[\sec \theta \left(\sin^2 \theta + \frac{Y_1}{h_e} \right)^{1/2} \right] \quad (\text{Equation 7-8}) \\ &= 41.8^\circ \end{aligned}$$

c. Roller Bucket Design.

(1) Assumptions:

Pool elevation	1,500 feet
Spillway toe elevation	1,245 feet
Spillway energy loss from boundary layer computation as illustrated in Appendix E	5 feet
Spillway unit discharge q	752.3 ft ³ /sec

(2) Bucket radius

$$r_{\min} = \frac{5.19 \left(d_1 + \frac{v_1^2}{2g} \right)}{F_1^{1.64}}$$

$$H = 1,500 - 1,245 - 5 = 250 \text{ feet} = d_1 + \frac{v_1^2}{2g}$$

$$\text{By trial } V_1 = 125.3 \text{ ft/sec}, \quad d_1 = 6 \text{ feet}, \quad F_1 = 9$$

$$r_{\min} = \frac{5.19(250)}{9^{1.64}}$$

$$= 35.3 \text{ feet}$$

Use $r = 40$ feet

(3) Bucket invert elevation limits

(a) Maximum depth invert elevation

(Plate 7-5)

$$F_1 = 9.0$$

$$\frac{r}{d + \frac{v_1^2}{2g_1}} = \frac{40}{250} = 0.16$$

Maximum tailwater depth $h_2(\max)$

$$= 15d_1$$

$$= 15(6)$$

$$\text{Elevation} = 90 \text{ feet} = 1,330 - 90$$

$$= 1,240 \text{ feet}$$

(b) Minimum depth elevation

(Plate 7-6)

Minimum tailwater depth $h_2(\text{min})$

$$= 13.7d$$

$$= 13.7(6)$$

$$= 82 \text{ feet}$$

$$\text{Elevation} = 1,330 - 82$$

$$= 1,248 \text{ feet}$$

Bucket invert elevation of 1,245 feet is acceptable.

(4) Roller depth

(Plate 7-7)

$$h_2 = 1,330 - 1,245 = 85 \text{ feet}$$

$$h_1 = 1,500 - 1,245 = 255 \text{ feet}$$

$$h_2/h_1 = 85/255 = 0.33$$

$$\frac{q \times 10^3}{g^{1/2} h_1^{3/2}} = \frac{752 \times 10^3}{(5.67)(4,082)}$$

$$= 32.6$$

$$h_b/h_1 = 0.2 \text{ where } h_b \text{ is the roller height}$$

$$h_b = 0.2(255) = 51 \text{ feet}$$

$$\text{Elevation of roller} = 1,245 + 51 = 1,296 \text{ feet}$$

(5) Surge height

(Plate 7-8)

$$h_b/h_1 = 51/255 = 0.2$$

$$h_s/h_1 = 0.44$$

$$h_s = 0.44(255) = 112 \text{ feet}$$

$$\text{Elevation of surge} = 1,245 + 112 = 1,257 \text{ feet}$$