



**PDHonline Course L120G (15 PDH)**

---

# **Construction Layout**

*Instructor: Jonathan Terry, P.L.S.*

**2020**

**PDH Online | PDH Center**

5272 Meadow Estates Drive  
Fairfax, VA 22030-6658  
Phone: 703-988-0088  
[www.PDHonline.com](http://www.PDHonline.com)

An Approved Continuing Education Provider

## Course Outline

Whether you're a professional engineer, land surveyor, construction layout contractor, entry-level employee working in a construction layout crew, party chief, construction manager, superintendent or architect, you'll benefit by a better understanding of this unique, essential component of any significant construction project.

By walking the reader through a typical, mid-sized project, covering bidding, contract negotiation, paperwork, interpersonal relationships, procedures, documentation, billing, site reconnaissance, geometric computations, and applying specific layout methods, the reader will not just be told *about* things but will see and experience the broad spectrum of construction layout and related disciplines through the eyes of its author. This approach makes remembering what's presented so much easier.

Tips (maybe even trade secrets) are freely shared - important lessons and experience learned by a surveyor licensed in 8 states, who's served as an employee of developers, construction managers, architects, engineers and surveyors since 1963 and possesses a wealth of knowledge gained through founding and operating a successful construction layout business.

Neither fear nor swelling pride fosters success in this unique business. And, both those attitudes are more common to providers of layout services than a quiet confidence born of real understanding. This course seeks to establish the latter.

Construction layout is a specialized, demanding function. It deserves study and the sincere respect it seldom gets. Its demands are uniquely complex and its rewards generous. This course is not merely a presentation of techniques and processes (though these are included); it's an equipping, enabling source of knowledge and understanding.

This course includes a multiple-choice quiz at the end, which is designed to enhance your understanding of the course materials.

## Learning Objectives

At the conclusion of this course, surveyors, architects, engineers, contractors plus technical and field personnel performing construction layout will have gained a better appreciation for the unique demands of providing construction layout and will better manage the business, procedural, technical and relationship aspects of providing control to guide new construction - and, hopefully you'll enjoy construction layout as much as I do.

- Learn important "trade secrets" from a person who's successfully founded and operated a business specializing in construction layout and established and managed a construction survey division within a large construction management firm.
- Learn how the professional Team that creates new development functions, and the importance of the place construction layout holds on that Team.
- Learn tips, tricks and special pieces of equipment that help you perform your layout more quickly without compromising precision.

- Learn how to confidently ask questions when you really don't understand the plans or know exactly what you should be laying out.
- Learn what plans to believe or not to believe and how to check dimensions when staking a building.
- Learn new ways to perform marketing and sales effectively – without assuming an exaggerated self-importance or using high pressure tactics.
- Learn how to level the playing field in a competitive bidding situation.
- Learn effective proposal writing guidelines unique to construction layout services.
- Learn how to structure your proposal format and language (or your bid) to handle layout items that may or may not be requested during the actual construction.
- Learn how to handle the correction of errors you discover in the plans and how to stake those items correctly without assuming liability for the correction.
- Learn the advantages and disadvantages of both small firms and large firms in relation to seeking clients for construction layout and how, in either case, to promote your strengths when seeking contracts.
- Learn the "full-service" layout requirements for a mid-sized, commercial project and how to structure these in your proposal.
- Learn how your billing relates to your proposal and what documents should accompany your monthly statements to your clients.
- Learn how to easily track and bill set-fee proposal items based on percentage of completion.
- Learn tricks for transferring building column lines or offsets to column lines to upper floors on multi-story buildings.
- Learn approaches to setting control for major buildings so that you can restore precise layout to its original location after building or column offset stakes are destroyed.
- Learn staking requirements for traditional utility construction methods and for pipe construction guided by a laser.
- Learn how to limit liability through your proposal, your contract, your correspondence, forms and private records.
- Learn the importance of receiving full sets of plans early and of attending the pre-construction meeting.
- Learn what digital files you should obtain and why you need both paper and digital plan sets - and why you need to get these early.
- Learn how the construction management firm's employees differ in experience and roles and how to handle your relationships with the persons filling each role.
- Learn why asking questions is critical to your success and know what questions to ask of whom and when.
- Learn why you and your crews must be familiar with your contract/proposal and carry a copy to the site.
- Learn why a project Field Folder must be created, what goes in it, and why it's taken to the site with each visit.
- Learn safety tips and principles unique to an active construction site.
- Learn how to make money "in the rain" (or at least maximize down-time due to weather).
- Learn what the "Geometric Plan" was historically, what it is today and when to believe or not to believe in the integrity of a digital drawing file.

- Learn tips for selecting the personnel who will perform construction layout and managing crews sent to perform layout.
- Learn tips for adjusting equipment on the fly - or on the job site.
- Learn suggested staking techniques and relative precision typically required for the many different features you're laying out.
- Learn standard ways to mark stakes that get the job done, avoid confusion and protect you from the potential for huge back-charges (You can stake correctly, but if you label a stake improperly or confusingly, you've just bought the farm!).
- Learn proven techniques for preserving your primary control (traverse/control points) that are needed throughout the entire project's duration.
- Learn why flagging on stakes should be color-coded consistently.
- Learn how color-coded file folders and certain standard forms give you the upper hand when clients misremember what they requested or agreed to, or what actually took place.
- Learn useful rules of thumb to apply when performing layout.
- Learn why Conversation Logs are essential records and how they can save you from client disputes and future claims against you.
- Learn why Work Orders are necessary, how to use them for all the layout you perform and how they facilitate billing – and you getting paid in a timely manner.
- Learn paper field book documentation that's still essential in our modern data-collection era and what notes to place in the electronic data collector's file.
- Learn how a standard rubber stamp impression at the start of each day's notes in the paper field book will train your crew to think more like business people.
- Learn how to expedite layout by copying sketches directly to field book pages.
- Learn how and when to write CYA memos, e-mails and letters.
- Learn suggested disclaimers to include in your proposals and on grade sheets to minimize disputes and back-charges.
- Learn typical staking and grade sheet preparation for single family residences and residential driveways (commonly needed in single-family, residential developments).
- Learn typical stake labeling and the sketches required for commercial building layout.
- Learn typical patterns for layout of curbing and parking lots.
- Learn stake labeling, grade sheet formats and sketches necessary to uniquely identify each stake you set in the field – to avoid confusion that often generates back-charges.

## Intended Audience

This course is designed for engineers, land surveyors, architects, contractors, or anyone contracting, providing, reviewing or writing specifications for construction layout services.

## Benefit to Attendees

This course teaches both technical and practical skills, contract and business considerations, staking and grade sheets, client relations, functioning in and with the design/build team, and relates countless tips and trade secrets learned only through solid, real-world experience.

## Course Author

The author is a surveyor who's obtained professional registration in eight states. He's served as assistant construction superintendent, teacher, writer, civil technician, site planner, land surveying department head for both civil/consulting firms and developers, created and managed the construction layout division for a large construction management firm, founded and operated a successful construction layout business and separate land surveying business plus worked as the employee of civil, surveying, and architectural firms, residential and commercial developers plus state government. His career began in 1963. He has personally laid out hundreds of millions of dollars worth of construction with back-charges under \$3,000.

Such a diverse background is rare, providing a breadth of understanding beyond what most professionals ever get to experience. This course generously shares the author's knowledge.

Construction layout is like a unique and fascinating jewel having many facets, each unique and worthy of careful study. As an object of study, construction layout must be placed in its proper setting - that is, in its relevance and relationship to the design/build process and the professional team that gets things built. Understanding construction layout from this overview yields success. This is our goal.

This course is not just for surveyors. It provides an overview and perspective of critical value to *any* person performing or associated with the disciplines related to construction layout. You'll gain a deeper understanding of this challenge and rewards of construction layout. The course is both educational and entertaining. It's an easy read and full of buried treasure.

## Table of Contents

Introduction.....	13
The writing style – holistic and personal .....	14
The place and function of construction layout – its importance – Some points to ponder.....	14
Respect it; don't fear it.....	14
To your competitors, I say... ..	15
OK. While your competitor licks his wounds, let's move on.....	16
Humility = Knowing Your Place on the Team .....	17
The Head of the Team – the Owner.....	18
Construction Management Firm .....	18
So who's the little guy?.....	19
On being a "Team Player" .....	19
On being "Presumptuous" .....	20
On being "A Servant" .....	20
Mercy – you may need it. ....	21
Team Recognition.....	22
Requests from people other than your client .....	22
The Essential Principle – What is Construction Layout? .....	23
Who should provide construction layout – large firms or small firms? .....	24
Large Firm Advantage – Service Considerations .....	24
Staffing Flexibility .....	24
Full Service Marketing .....	24
Design-Build Carry Through .....	24
Final Check of Design .....	25
Getting Paid – Eventually .....	25
Small Firm Advantage – Marketing Considerations .....	25
Personal Relationship.....	25
Generally better qualified field help .....	25
Better Communications .....	26
More Caring and Responsive.....	26
More Geared to the Task.....	27
Morale may be better .....	27
Able to Negotiate Extra Work – Or to Give it Away .....	28
Unfair to large firms?.....	28
Take courage, small business owners!.....	28
The Large Firm's Clout .....	29
Large firm or small firm, be the best and be bold! .....	29

The Marketing and Sales Effort..... 29

- Why even those employees who are not involved in marketing and sales should read this section ..... 29
- Sales or Marketing? ..... 30
- Who wears the pants? ..... 30
- People Love to Talk – About Themselves..... 30
- People Like to Help People..... 31
- Is There a Market? ..... 31
- Suggested Approach to Marketing..... 31
  - Consult the expert ..... 31
  - This is not a chat – You’re on a mission..... 31
  - Don’t gratitude jes warm yer heart?..... 32
  - The Worst is Over..... 33
- Northern Virginia in the mid 80’s and Northern New England in the early 90’s..... 33
- After Marketing, What? ..... 34
- Sales – a little understood profession..... 35

Bidding..... 36

- First, determine whether your potential client has actually been awarded the construction contract..... 36
  - If not, a general estimate may suffice. .... 36
  - Consider the odds:..... 37
  - If the firm requesting your bid already *has* the construction contract, then get very, very specific. .... 38
  - How to win playing the ‘Apples and Oranges’ Game ..... 38
  - Now to explain the “apples and oranges” game ..... 39
- Pre-bid Meeting to Define Scope..... 40
  - Remember, you’re only .5%. Be succinct..... 40
  - Best time for sales..... 41
  - Low Bidder – Apples and Oranges – and Extras..... 42
  - Strictly a low bid situation? ..... 43
  - What if the client beats you down?..... 44
  - Summary – The Bidding Process and the Pre-bid Meeting with the Client ..... 45
  - A word to employees ..... 45

CONTRACTS – This section does NOT constitute legal advice!..... 46

- Bid the Professional Way – Submit a Proposal ..... 46
- Contracts – Legal Documents (Consult a lawyer) ..... 47
- What Can We Say About the Nature of Contracts?..... 47
- Writing your Proposal - Specify, specify, specify ..... 48
  - How many toilets –or– how many stakes? ..... 48
  - Why your proposal gets so specific ..... 48
  - Creeping-Up Scope Syndrome (CUSS)..... 49
  - Assumptions..... 49
  - Scope of Services – Line Items in Sequence ..... 50
  - Time Elements-Be Unambiguous and Nonspecific (Be What?) ..... 65

Billing and Payment – Time to get specific! ..... 66

Collections – Go after payment. .... 67

Billing Disputes ..... 68

Fee Structure ..... 68

Liability Insurance ..... 75

Errors and Omissions Insurance ..... 76

Backcharges – If you break it, you buy it ..... 76

The Blame Game – Play to win!..... 78

Proposal language protects against unjust backcharges..... 81

Proposal Language – Summary ..... 82

    Pay the price of a printed form – or don’t..... 82

You’ve been awarded the Contract! ..... 83

    Your Contract or Mine? ..... 83

    Negotiate to win..... 84

Pre-construction Meeting..... 85

    Remember the distinction between the expertise of PM & Super ..... 85

        Cutsheets (Gradesheets) or Marked Stakes?..... 86

        What hours site will be available for staking? ..... 86

        Will there be a full-time, on-site superintendent?..... 86

        Will there be any on-site layout staff and equipment? ..... 86

        Bid-set of Plans still current? ..... 87

Communication..... 87

    Ask lots of questions–preceded by personal statements ..... 87

        Is mine the most recent plan?..... 87

        Where will the site remain undisturbed until this staking is no longer needed? Where is the best place for our control to be set? ..... 88

        What points do you want referenced?..... 88

        How do you want the stakes marked?..... 88

        Will you need Grade Sheets?..... 89

        If you marked grades on the stakes, ask when will the actual construction begin?..... 89

        Are you expecting any activities today that will block our line of sight?..... 89

        What are acceptable tolerances for this particular layout? ..... 89

        Is there any “dead” equipment on site that cannot be moved if it’s in the way? ..... 89

        What’s the name of the equipment operator? ..... 90

        If our work runs late, will we be able to stay to complete it?..... 90

        Who will sign our work order today and will that person be available all day?..... 90

        You are only *one* of the experts. Stay in your place. .... 90

        Expect to learn ..... 91

        Discuss your intentions ..... 91

        Know your contract and assignment..... 91



Job Folder – Take it each time ..... 93

Color-coded Folders..... 94

    Blue – “Contract” or “Proposal” folder ..... 94

    Red – “Billing/Work Orders” folder..... 95

    Yellow – “Written Correspondence – Non E-mail” folder..... 95

    Yellow – “Transmittals & Cover Letters” folder..... 96

    Orange – “E-mail” ..... 98

    Classification – the KEY to learning!..... 99

    Green – ”Conversation Logs” folder ..... 100

    Need more colors? ..... 104

    The filing philosophy ..... 104

Safety ..... 104

    Keep an eyeball in the back of your head ..... 104

    Mark your territory ..... 105

        Skillful operators sometimes show off. .... 106

    Cages in the van ..... 106

    Never go beyond what you’re trained for ..... 106

    The strange dichotomy - People in the most dangerous jobs often value life the least. .... 107

    Know what you’re expected to wear on the construction site ..... 107

        Hardhats ..... 107

        Safety Glasses ..... 108

        Boots ..... 108

        Safety Vests ..... 109

        Ear Plugs ..... 109

    Know your equipment operators..... 110

        Lull or Crane? ..... 110

        Daring or Caring? ..... 110

        Demon or Guardian Angel at the helm? ..... 111

    Know your blasting signals (AND your blaster) ..... 111

    Trust your instincts & your intuition ..... 111

Downtime Activities ..... 111

    On-the-Road..... 111

    Between assignments or during bad weather..... 112

    Training..... 114

        “It’s not my job!” – Training the team as a team..... 115

Preparation for Staking ..... 115

    The Geometric Plan ..... 116

    Revisions you make to the design..... 117

    On being a “team player” – Never fly solo! ..... 118

    Digital Drawings and Data..... 118

    To believe or not to believe – That is the digital question. (Answer: Don’t you *dare* believe!) ..... 119

    Architectural and Structural Drawings ..... 120

Site Development Plans ..... 121  
So, you discover errors in the plans. .... 123  
Never stake a building from a site plan – or stake *anything* from an OLD plan. .... 124

Never-never land – things to avoid (and to remember) ..... 125  
Never underestimate the task ..... 125  
Never send the “junior” crew ..... 125  
Never under-equip the crew ..... 125  
Never rush the crew ..... 125  
Never underestimate the liability ..... 126  
Never underestimate the Construction Manager’s role ..... 127  
Never underestimate the value making a friend – True Story ..... 127  
In relationships, never fail to keep the Big Picture in view! ..... 131  
Never underestimate the grapevine ..... 133

Always-always Land – The worth of time-honored values ..... 134

Fieldwork for a Typical Mid-sized, Commercial Project ..... 135  
The Field Crew – two or three people? ..... 135  
Hiring that third crew member (or any entry-level employee) ..... 138  
    The Newbie Employment Exam ..... 138  
    The Newbie’s Indoctrination Ceremony ..... 140  
    The Newbie’s Final Hurdle ..... 142  
Field Equipment – and some money-making tips ..... 144  
    Chalk Line & Clear Spray Lacquer ..... 146  
    Fiberglass Measuring Tape or Steel-clad Tape ..... 146  
    Stick-on Targets and Prisms ..... 147  
    Cordless Power Tools ..... 148  
    Double Right-Angle Prism ..... 148  
    Survey Belts with Pouches ..... 149  
    Stake Bag ..... 149  
    Radios ..... 150  
    Sledgehammer ..... 150  
    Orange Traffic Cones – as Backsights ..... 150  
    Tripod Stabilizer ..... 151  
    Dist-A-Line™ ..... 151  
    Tow Chain ..... 152  
    Adjustment of Equipment ..... 152  
    Checking of Equipment ..... 153  
Typical Requirements of Construction Layout ..... 161  
    Build on a foundational understanding. .... 161  
    Getting the right start. . . . . 162  
Preliminary Reconnaissance, Control Traverse, Traverse Adjustment (or not) – Your First  
Visit to the Site ..... 163  
    Geometric Plan Preparation ..... 172  
    You, the cause of being behind schedule. .... 173

Stake Clearing Limits ..... 173

Stake Rough Grade ..... 175

Stake for Blasting..... 178

Stake Building..... 180

Stake Site Utilities..... 195

Protect your control..... 203

Label your control points in the field..... 206

Be sure your crew THINKS in the field. .... 206

Color-coded flagging ..... 207

Labeling of Stakes..... 212

Rules of Thumb..... 216

    Angles ..... 216

    Steel Tape Corrections..... 216

    Balancing Foresights and Backsights for Level Runs ..... 217

Record Keeping ..... 218

    Covering Your A..... 218

    Digital World – Shortcut to Disaster ..... 218

    Record Keeping – Data Collection ..... 219

    Paper Fieldbooks – Not Outdated..... 219

        Bound v. Loose-leaf..... 219

    Field Note Reductions..... 222

        Double Copying – Triple Caution..... 222

    The Mail Rack..... 223

        An Undivided Mind is an Efficient Mind ..... 223

    Each and Every Day – Rubber Stamp..... 224

        Client / Site – Who are you working for – on what project, and what you are doing that day?  
..... 224

        Mission – What are you doing there? ..... 225

        Crew – Who did the work? ..... 225

        Date ..... 225

        Weather ..... 225

        Equipment: Instrument and Data Collector ..... 225

        Collector’s filename..... 226

    Field Notes – Essential Minimums ..... 226

        Inst. Point, B.S., H.I. (even on resets after lunch) ..... 226

        The CLOUDS of Confusion ..... 226

        Last Shot a “ckbs” ALWAYS..... 226

        Pages numbered at BOTTOM of pages, at corners ..... 227

        At End of Each and Every Assignment ..... 227

    CYA Memos ..... 228

        Most Recent Plan Memo..... 228

        Staking per Plans Dated..... 228

        Follow-up to direction given in field ..... 228

        Any requests that might be confused at to whether they are inside or outside the scope of  
your contract services ..... 229

Any site activities that might lead to confusion..... 229  
Equipment tracks along side of stakes ..... 229  
Grade Sheets (Cut Sheets) ..... 229  
Notes ..... 232  
Work Orders..... 237  
    You absolutely gotta have ‘em! ..... 237  
    Where to Obtain? What format?..... 238  
    Triplicate Forms should include spaces for: ..... 238  
    Aluminum Thing..... 241  
  
The TEAM ..... 242  
  
The Satisfaction of a Job Well Done ..... 243

# CONSTRUCTION LAYOUT

*Jonathan Terry, P.L.S.*

## Introduction

This Construction Layout course presents “Foundational Principles for Success.” It conveys knowledge that’s taken decades of experience to learn – information and principles that most who know such things won’t share freely with others. ‘Trade Secrets’ may be too strong a term for what’s conveyed in this course, but much of the information is at least of the flavor of trade secrets. Success at construction layout is not achieved through acquiring technical expertise or measuring skills alone. Construction Layout exposes the architect, engineer or surveyor to a culture different from its own – to priorities and viewpoints unique to its genre, to a team experience requiring cooperation, effort and communications quite different from most other interactions within the professional design team.

This course lays the foundations for understanding the ‘world’ of construction layout. For many who serve in design and surveying professions, experiencing the construction environment is like visiting another planet. It’s a planet that has a lot to share with us, a lot to teach us. It’s a fascinating place that functions to the rhythm of a drum-beat starkly different from the drone of quiet designers’ cubicles. It’s the last step between conception and reality. On the construction site, dreaming ends, theory meets the real world, and anything that doesn’t work gets modified until it does.

When a design reaches the stage of construction, things get real. This can be refreshing. Construction layout is just plain fun!

But, it’s a dangerous vocation, prone to frightening levels of liability exposures. Construction layout happens on a playing-field where the blame-game is played with high stakes. Many are afraid to perform construction layout services, and they’re right to be cautious. It’s not for the faint-hearted, for timid souls or for novices. There’s a lot to know besides cogo calcs and measuring skills.

This course introduces the big-picture – what you need to know to survive and even prosper performing construction layout - foundational principles for success.

## The writing style – holistic and personal

Have you noticed that technical course material is often written in a rather dry way? Let me say up front that the writing style of this course is intentionally holistic and personal. The subject matter is presented as it directly relates to other disciplines, to business and ethical considerations, and to how it interfaces with other members of the professional team. The material is often supported or illustrated through actual experiences – both successes and embarrassing failures. Learning evolves rather than progresses, expands rather than stacking fact upon fact. Word-pictures unite specific technical knowledge with whole processes so that raw information is more readily retained, homogenized with other relevant facts and some practical applications.

Dictionary.com defines holistic as “emphasizing the importance of the whole and the interdependence of its parts... concerned with wholes rather than analysis or separation into parts.” The word comes from holism, “The theory that... reality is made up of organic or unified wholes that are greater than the simple sum of their parts.”

Why choose a holistic approach in creating this particular course? Because success at construction layout requires focusing on the big picture and employing intelligent, integrated, informed, sensitive approaches to layout tasks. Expert measurement skills alone are simply not adequate, though these skills are essential.

To please your clients, make money, and stay clear of those dreaded back-charges that haunt the construction layout profession, expertise in measurement must marry an informed perspective. That necessary union, in a nutshell, dictates the content of this course and frames its essential purpose.

At the end of this course, you should feel like you’ve gained not only knowledge, but more importantly, experience. The former is important; the latter is essential.

## The place and function of construction layout – its importance – Some points to ponder

Many who provide construction layout services do so with timidity that betrays their terror of back charges. Deep down, no matter how skilled they are at measuring, they know they lack understanding of what they’re doing on the foreign soil of the construction site, and of how their function relates to the overall construction process.

Some brazen professionals bring a prideful overconfidence to construction layout, approaching the task just like any other, every-day, land surveying or engineering assignment – which construction layout definitely is NOT.

### **Respect it; don’t fear it.**

While most surveyors and engineers consider construction layout risky from liability potential and fee collection points of view (which it is), surprisingly few give it respect – *real* respect.

Often, department heads employed by large, multi-discipline firms view construction layout as a necessary evil – something that’s got to be done in order for their employer to offer full services to design clients. If you’ve ever staked a house on the wrong lot or watched a storm sewer system being ripped out of the ground (demolition and reconstruction you’re paying for because you staked it in the wrong place), you know personally that construction layout is important and critical work. In addition, it’s risky. The less you know about it, the more risky it becomes.

Sometimes, construction layout is respected only because of its capacity to wield severe consequences for blunders or mistakes. However, there is a better reason to respect construction layout as a truly important service; it is *inherently* important work. By its nature, it simply is very, very important work.

It’s worthy of respect as a professional activity, every bit as much as the work surveyors universally consider professional in nature – boundary surveying, for example. Sure, it’s different from analyzing conflicting evidence of boundaries to render a professional opinion as to where property lines are located. Surveyors everywhere consider that activity ‘professional.’ Nevertheless, construction layout is a VERY professional service. The work should be treated with respect, in keeping with the self-respect you gain as a valued participant in the construction process.

Layout contractors and construction managers often understand the layout needs better than surveyors or engineers do. But, they seldom understand measurement theory and geometric computations the way most surveyors and many engineers do.

Expertise in measurement is something any worthy surveyor brings to the construction site. But a thorough understanding of how that particular skill functions at the construction site is something gained over time, and many professionals simply lack this understanding.

Whether you’re a layout contractor, engineer or surveyor, if you possess both the insight into construction’s unique needs and measurement experience, this becomes evident to the seasoned construction superintendent. Conversely, if you’re a novice at construction layout (no matter how technically proficient you are), chances are you’ll frustrate those who use your layout. Inexperience in the world of construction is noticed. And, real competence in construction layout is readily discerned and greatly appreciated.

Everyone wants to feel that his or her work is important. But, do you realize how very important construction layout really is?

I know that *you’re* diligent, experienced and competent, and that you know how important your work is. So just listen in as I address your competitors for a minute. They need a word of correction to inspire them to new heights.

## **To your competitors, I say...**

To them I ask, “Do you appreciate from the *contractor’s* point of view how important your work is?” If you tell the contractor that you’ll be there Wednesday morning to fill his order for staking, do you know that contractor sets in motion all manner of effort and expense based on that promise? Do you know what grief you’re causing him if some other job of yours runs over due to weather or other reasons, and you don’t show up Wednesday morning as promised?

If you show up on time but take two or three days to deliver a cut sheet or other documentation needed to use your layout for construction, what is the contractor to do meanwhile? If your stake labels are unclear as to what exactly is referenced, or if the excavator operator can't tell if your stake reads C=4.3' or C=9.3', you're not thought of kindly by those who stand around scratching their heads instead of constructing.

Have you ever noticed how some roadmaps are confusing to use, even though they contain the same information as other maps of the very same area? You don't like those poorly designed maps, do you? Contractors don't appreciate any sloppy, unspecific or confusing guidance, no matter how bloomin' accurate and precise the actual layout may be. Sloppy handwriting or stake labeling that makes a 2 look like a 7 or a 4 like a 9 is simply inexcusable. Sketches that are not immediately instructive are deficient. Sheets without unique and useful titles are difficult to discern and use in the field or to locate in the mountain of paperwork in a superintendent's field office.

Contractors don't like waiting around while some soul bound on precision resets a tack in a hub for the second or third time to get it just right, when that control is for blasting the route of a new sewer line. They know such a person is lost in pointless details and is missing the essence of what they're there for. Contractors find it frustrating when they can't figure out if the stake is offset from the face of curb or back of curb or whether the cut is from the top of the guard stake or the top of the hub or the ground at the stake.

My survey career began in 1963, and what hair I have left is gray. May I use the excuse of age and experience to speak bluntly to engineers and to my fellow surveyors, (not you, but your inept competitors)? Most surveyors and engineers don't know what they need to know about construction layout. Worse yet, they don't know that they don't know.

Now, don't feel insulted. The construction site is not a place for fragile egos. I'll be gentler with you than most construction superintendents and a darn sight more patient than his sub-contractors. Nevertheless, there are some things we professionals need to hear about this peculiar and fascinating line of work. And it requires a measure of humility to learn them and even more humility to practice them.

## **OK. While your competitor licks his wounds, let's move on.**

Your competitor really needed to hear that. You and I already knew it. But, now that your competitors do too, we need to work even harder to play our part on the team.

Consider *Figure 1*.



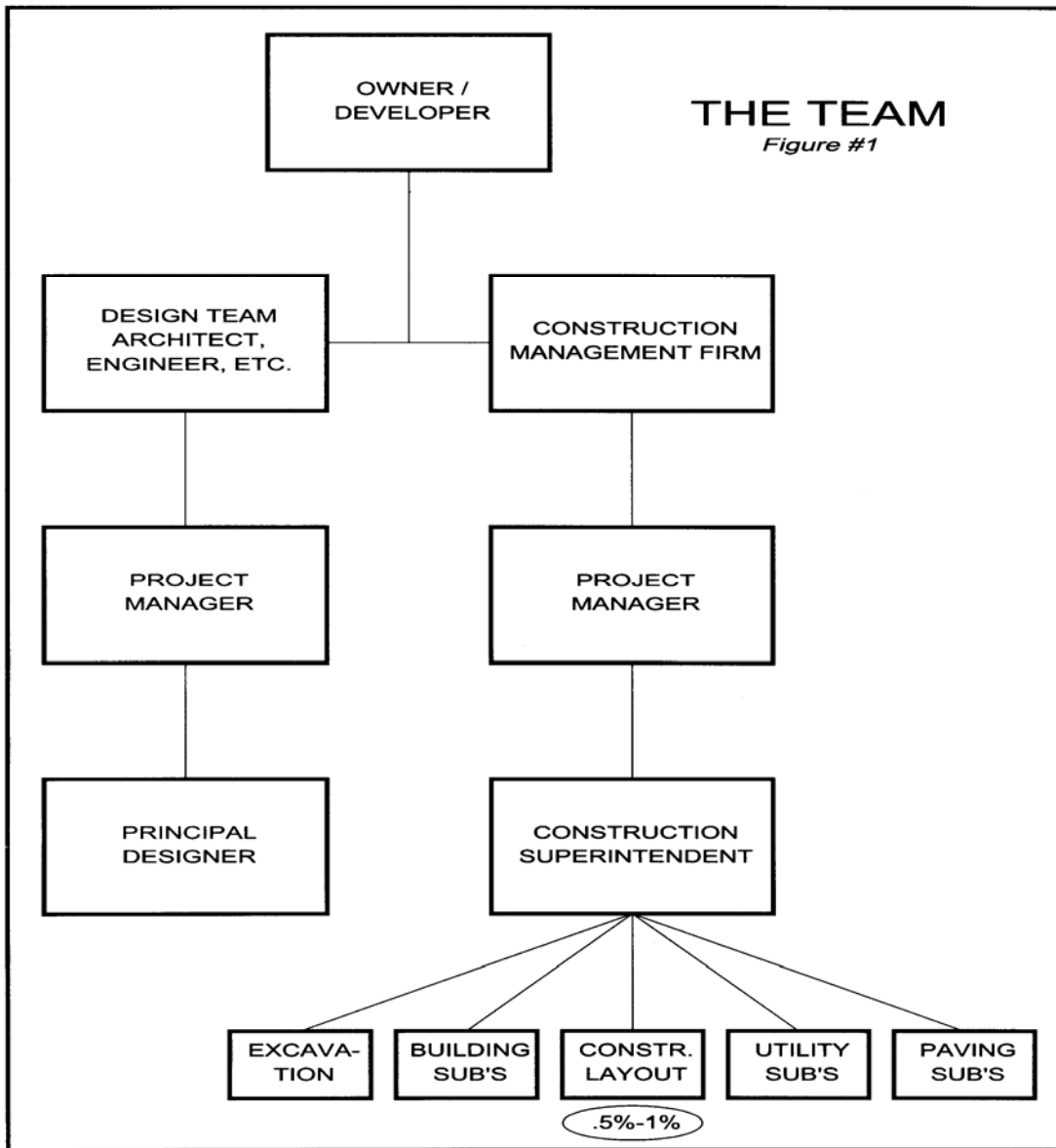

Figure 1

## Humility = Knowing Your Place on the Team

You are part of a team – a multi-talented, diverse group of designers and experts who bring various, professional talents to the project. The different disciplines may include lawyers, architects, engineers, landscape architects, surveyors, environmental consultants, wetland and soil scientists, cultural resources experts, permitting consultants and more.

Most of these disciplines work independently but coordinate their activities at points where their talents meet those of others and where their designs or their specific expertise merge or overlap with others serving the owner/developer on the project.

At the point where their work is completed and approved by all the various regulatory boards and review agencies, the project goes out to bid and construction begins. This is where the construction layout specialist enters the picture. But, the roles of the professional design team members do not entirely cease at this point.

Those who perform construction layout are one part of a team. Generally, the team is comprised of the participants depicted in Figure 1. The illustration is a purposeful over-simplification. It could be expanded to include different layers of management and disciplines on very large projects or even condensed considerably for small projects like residential subdivisions and individual lot development where many roles may be assumed by a design-builder or other talented person who wears many hats. But, the basic roles and functions typical to all construction projects are illustrated in *Figure 1*.

## The Head of the Team – the Owner

The obvious “head” of the team throughout design and construction phases is the owner/developer. This person or business entity foots the bill ultimately. Generally, as a construction layout contractor (whether you’re a surveyor, an engineer, a non-profession layout specialist or a subcontractor providing your own layout for what you’re constructing), you won’t have direct contact with the owner or developer.

Each of the owner/developer’s selected design consultants generally has an in-house design group consisting of a project manager or principle designer plus that person’s design team. This is depicted along the left side of *Figure 1*.

The illustration stops at the **Principal Designer** for a very special reason. It’s because **this is the person you will most likely contact when plans need clarification or correction.** More on this later. This person is the hands-on leader of a design team – the person actually acquainted with specifics of the design you lay out.

On the right side, is the team that gets the project constructed. On all but small projects, a construction management firm or general contractor selects, hires and oversees a number of subcontractors, of which you are most likely one.

## Construction Management Firm

For typical, mid-sized commercial projects with construction costs of several million dollars, a construction management firm assigns a **Project Manager** to oversee the project’s construction. Often this person is not actually present on the construction site but handles the administrative, contractual, scheduling and financial matters. This Project Manager generally has direct and frequent contact with the owner/developer. Often, this Project Manager has an assistant whose time is spent part-time in the office and part-time at the job site. One of these persons will choreograph the sequence of construction and determine what has to happen before another thing can take place and what things can take place simultaneously without conflicting with each other. Theirs is a big and an important job.

The **Construction Superintendent** is the construction management firm’s on site manager coordinating the efforts of many subcontractors represented along the bottom of *Figure 1*. These people along the bottom row, in my opinion, are heroes. Their work is physically demanding,

complex, and sometimes dangerous. Their profit margins are minimal, and they will pay for any mistakes they make in cold, hard cash. They are the worker bees, the ants carrying burdens many times their own weight. That's you. (And me.) There we are on the bottom, right where we belong. Unsung heroes, conquering and redefining the frontiers of civilization.

Soon we'll be forgotten. Our names won't be found on bronze plaques and generally not even on the temporary construction fence. Speaking of the construction fence, may I digress to suggest that you ask the construction manager or general contractor if you may place a small sign on that fence? "CONSTRUCTION LAYOUT BY [YOUR FIRM]." Providers of construction layout seldom seek this advertising opportunity. Many times, permission is granted. It's worth a shot. Remember, other construction people driving by that site hire people like you, and they always glance over to see what's happening on other construction sites. And, look. There's your sign!

## So who's the little guy?

OK, so the point is, *you're* the little guy. By the way, women have appeared on the construction site, so 'little guy' is genderless in my usage. Whether male or female, you're the little guy – one servant among many who actually do the work the others above you in rank and responsibility oversee and benefit from, probably a great deal more than you do. You're an unsung hero in the company of other unsung heroes at the low end of the food chain. Ain't it great?

Actually, it *is* great, and this course hopes to convince you that you're performing a truly noble task as a servant. Take for example, Jesus. He claimed He was the Son of God, yet He said, "I came to serve, not to be served." Catch a vision for the glory of being a servant and you'll have a happier life. (This is a great mystery.)

## On being a "Team Player"

The term "team player" has come to mean many things – from being a mindless slave to your superior's whims to actually functioning as an important member of a diverse, coordinated group of capable workers who respect and compliment one another's disciplines and specific expertise. In this course, I refer only to the latter definition. This course strives to make you an even better member of that dynamic team than you presently are.

This section is, for just a little while, unashamedly preachy. But, remember this: Any good preacher does you a favor, like the guy driving toward you and flashing his headlights to warn that you're approaching a police speed trap. Bear with me if you can, and consider these words of instruction. I'm not pointing my finger at you; just flashing my headlights. And very, very soon, I'll move on to less challenging topics.

A while back, I witnessed a party chief arguing with a construction superintendent about what points he would stake for a new commercial building. This party chief failed to recognize the limitations of his expertise and to humbly take direction from a person far more skilled in knowing what was needed. He also failed to recognize that the contractor was his boss's boss! This party chief came to the site equipped only to stake some points calculated for him back in the office. And these, by gum, he intended to stake! The superintendent walked back to his office trailer shaking his head and mumbling to himself. It's a very common tale.

## On being “Presumptuous”

Too often, layout set up in the office is based on PRESUMPTION. The office person who took the order for the layout and dispatched the survey party didn't ask specifically what layout was needed and therefore didn't know what the user of the layout really wanted or needed.

The policy in that surveying firm (whose party chief argued with the superintendent) was to compute in the office the angles and distances for radial stake out. The instructions to the party chief were to perform little or no computations in the field, even though his data collector was uploaded with the project's coordinates, and he was capable of doing so. So, when that party chief arrived on site, the superintendent directed him to stake something that hadn't been prepared in the office. The party chief argued against the super's wishes and needs, and in doing so felt he was following his bosses express directions. This happens more often than you'd think. Many a supervising surveyor has been heard to say, “I don't want my party chief to think too much in the field.”

While I truly understand the logic of such a view, I suggest that the surveyor who feels this way about his party chief should not be performing construction layout services at all. It's unethical for a surveyor to perform services for which he or she is not competent or to send incompetent people to render professional services. The construction site is not static. It is ever changing, dynamic, fast-paced and unpredictable. A capable construction layout person must compute in the field and flex with the need. Of course, original work computed in the field must be checked back in the office, but to think that all work can be prepared (emphasis on *pre-*) in the office is simply unrealistic.

Often, when preparing stake-out in the office, the office person presumes to know on which side of a storm line the offset stakes will be set or how far to place offset stakes from sewer lines or building corners, or which column lines should or should not be staked – all without asking the end-user what is needed. The result? The crew arrives on site prepared for a particular approach when that is not what's wanted or needed. This is not being a team player.

Always, always ask what is desired when the call comes for layout, and prepare the crew for the unexpected. The crew should be able to flex in the field, placing the layout control where it's needed. Even in our time, when data collectors can be easily uploaded with the project coordinates, many survey crews arrive on site with sheets of paper assuming certain control points are in existence and intervisible. Such brave and vain assumptions for the active and ever-changing construction site!

## On being “A Servant”

The surveyor (or anyone performing construction layout services) is there to SERVE. In our culture, being a servant is often looked down upon. This is nothing short of tragic!

It is an honor to serve others, and this is the proper attitude for the surveyor, engineer or layout contractor who sets foot on the construction site. Try to catch the vision of the glory of being a servant – of serving from the heart. Forget putting on professional airs. Look at *Figure 1*.

You're among the heroes at the bottom of the flow-chart. Eliminate the bottom row and all that construction is reduced to dreams and thoughts and lines on paper. You have specific expertise

and serve an essential function – and you do this from your place at the bottom. It's a great place to be.

Providing layout control is a critical function and an important one. But, the role is a small one when viewed from the perspective of the entire project's cost. On most mid-sized commercial projects, the total fees generated for complete construction layout services range from one half of one percent to one percent (½% to 1%) of the construction costs. For some projects, it's even less than ½%. And remember, we're assuming full-service site layout is required.

For a project costing \$5 million, the complete layout services (recon & preparation, clearing limits, rough grade control, blasting, storm, sanitary, water, curbing/paving and the primary building control and column layout, some restaking and maybe even the foundation survey and final asbuilt survey) may generate layout fees under \$25,000.

If the general contractor or individual subcontractors provide layout for some of their construction, your layout fees can be even less. Most building constructors have the expertise to lay out their entire building from corner offsets or column line staking. Because those actually constructing complex buildings normally have their own layout people who work off the primary control you provide, sites with multi-story buildings often generate layout fees well under ½% of the total construction costs.

The point to remember, from the financial standpoint, is simply this: you are one of the little guys.

Those who perform construction layout provide a vital need, serving along with numerous other disciplines, each requiring expertise and experience to complete the project successfully. Construction layout services play an important role, but a relatively small one, considering the scope of the average project. Others on the site usually know more than about what they want, what they need, where they need it and why than you do as the layout contractor. Be prepared to listen and give them what they want.

## **Mercy – you may need it.**

The bible admonishes, "Consider others better than yourself." Wise words in any circumstance and admittedly contrary to human nature – but, precious counsel for those serving on a construction site. Be quick to hear and slow to speak. Don't try to impress; just serve faithfully. This is what your client needs and wants. Believe me, you will be appreciated if you serve with this attitude and do your work competently.

When you make a mistake in your construction layout, and you will, it can be very costly to you. The confident yet humble person is likely to receive some measure of mercy when that frightful moment comes that an error in your layout is discovered. If you've been proud, boastful, and arrogant and otherwise impressed others with your high view of yourself, your client may delight in humbling you when your moment of truth comes. When you've made a mistake in construction layout, you need a compassionate client. Cultivate one.

Remember, it's hard to get mad at a humble person. Some wise person advised, "Keep your words soft and tender. You may have to eat them!"

## Team Recognition

OK, surveyors, we are THE experts in measurement. (I must address my fellow surveyors for a minute.) That's one thing we can be proud of, by gosh! Even here though, don't get proud. I've learned more about construction layout from the gray-haired superintendents (before I was gray-haired myself) than in any book. These geezers, the really old ones, learned construction from the ground up, and they just may know a thing or two about measuring you never learned as a modern surveyor. If they ever offer suggestions – and most will be exceedingly tactful to see if you'd be interested in the easy way or if you'd rather stay proud and suffer – then listen attentively and draw them out. You are a visitor on their turf.

The plans you stake from are in authority over you. They embody both talent and authority. And, they are often dimensionally wrong. You'll often find dimensional disagreement between architectural and structural drawings, especially if the building design departs from simple rectangular patterns for its column positions. In reporting the discrepancies you discover, assume a humble, inquiring posture. Say something like, "In looking over the plan set, Mr. Architect or Mr. Structural Engineer, I find an apparent discrepancy, and I just wanted to ask you to double check me so I don't lay it out wrong."

If a dirt (excavation) contractor or operator steps over to ask, "What the heck are you staking it that way for," explain your reasons. And, ask what he thinks would be better. Most times the person returns to the equipment, glad to be escaping the encounter. But, occasionally that person, the END-USER of your stakes, really is the only person who knows what is needed. Much is learned by listening.

Give the person who approaches you with suggestions or questions space to talk. Listen well to them. It may be that you're setting building offsets right where they'll be digging the next day. If you offend this person, your stakes may be gone before they're used. Never, never take the attitude that you don't care because you'll be paid hourly fees to restake if the control gets destroyed. Almost never will it be a waste of time to pause in your work to listen to someone trying to tell you something.

If the excavator or any other subcontractor suggests some layout other than what you've been instructed to do, and you think it's actually a better idea, go to the superintendent and ask if perhaps you should do what the other subcontractor suggested.

There are never, never too many eyes, ears and minds on a construction site. As a surveyor, did you ever have a hunch or intuition about where to find the iron pipe marking a corner? How do you explain that? You've developed a sixth sense of some kind, and instinct peculiar to your profession and your years of experience. Your fellow team members who spend all their days on the construction site have developed their sixth-sense about things, too. Listen to them. Give them room to express themselves. Seldom will you conclude time spent listening on a construction site or at a kick-off meeting has been a waste.

## Requests from people other than your client

Sometimes, other subcontractors come up to you on the site and ask you to perform some layout or checking or measuring service for them. Here's a tip on how to handle this.



Decades ago I did wedding photography to support my photography hobby. Often guests at the reception would want me to take their picture, and often they were drunk. Drunks can be unreasonable if refused. My strategy was to say, “Sure, I’d be happy to take your picture, but today I’m the employee of the bride. I’m hired by her to take the photos she wants, and she’s my boss. Just have her ask me to take your picture, and I’ll be happy to come right over and do it.”

That was always the last I’d hear of it.

On the construction site, if approached by another subcontractor for some favor or work request, I say, “Sure, but the superintendent is my boss. Just have him ask me to do it for you while I’m here, and I’ll be happy to do it.”

In some cases, I really do want to do the thing I’m being asked to do. Even then, it’s good to remember that I’m there as the servant of my client. Some small favor that doesn’t compromise my primary mission, done for another subcontractor at some convenient break in my work creates no problem. But, if it’s going to take much time, someone has to pay for it. If my client sees me doing something my client has not assigned or authorized, he or she may wonder if I’ve misunderstood the instructions or if I’m going to charge my client for the activity. It’s always important to keep the client informed and in control.

Some contractors want more than a little thing done, and they’re willing to pay for it, “if I can just do it while I’m there.” I’ll only do it if I’m certain I can complete my main client’s assignment in the time allotted. And, I’ll tell the superintendent what I’m doing for someone else on the site so there’s no confusion. Before starting work requested by another subcontractor, I’ll write it up on a work order noting the estimated fee and get the signature of the one requesting the work. More than once, that person has balked at signing the work order, and I simply tell them I can’t start the work without a signature to authorize the charge. (If they won’t sign a work order, do I really think I’ll get paid?)

Work orders are discussed in depth in Part 2 in this course. For now, suffice it to say that work orders are an absolutely essential tool. You’ve gotta have ‘em!

## **The Essential Principle – What is Construction Layout?**

Construction layout is the discipline of surveying in reverse, that is, the skills and measurement expertise of surveying applied in a reverse flow of information.

Surveying in general is comprised of gathering measurement data – of determining that a house or curb or other physical feature is located at a certain angle and distance from the measuring instrument, and is at a specific elevation.

Construction layout says, build that house or curb at a certain angle and distance from the measuring instrument, at a specific elevation.

Construction layout is a process that’s the reverse from that most common to surveyors. Surveyors typically set property corners, and this is a good example of what I mean by the reverse process. But, construction layout at its best requires specific knowledge and judgments

not gained in a lifetime spent locating evidence of boundaries and setting corners. Construction layout is complex, challenging and rewarding. As a professional service, it should not to be taken lightly.

Can just any surveyor or engineer provide construction layout services? Those who know very little about construction layout yet lots about land surveying and/or measuring can and do provide construction layout services. But, those few who possess expertise in construction layout stand out to the trained eyes and instincts of the site superintendent and other contractors. Such expertise does not come overnight, but through patience, attentiveness and conscious effort. Be certain of this: your client knows whether this expertise resides with you or not.

This course will shorten the time required to obtain expertise in construction layout. Some things, only personal experience teaches. To the best of my ability, the course teaches what another's experience *can* teach, so you gain personal experience as rapidly as possible.

## Who should provide construction layout – large firms or small firms?

Some small firms, really small – say two person firms – will feel they are too small to provide construction layout services. Some department managers of large firms will feel construction layout is too risky to perform and fear their advanced planning will be upset with sudden requests for layout. This section attempts to provide a broad-brush view of both large and small firms' advantages and disadvantages when it comes to providing construction layout services.

### Large Firm Advantage – Service Considerations

#### Staffing Flexibility

Larger firms having multiple survey crews in the field at any given time can often drop a large, ongoing project for a day or two in order to meet the needs of a construction layout request. Even a couple or three calls for layout coming in rapid succession may not overwhelm the larger firm. The small firm can sometimes receive multiple requests for urgent layout and may not be able to satisfy all clients at once. In this matter, large firms have a distinct advantage – if they use it.

#### Full Service Marketing

Often, the construction manager will automatically call the full-service firm that designed the project for the layout of that firm's designs. The assumption is that the firm can hit the ground running and provide fast, efficient responses to layout needs. This, of course, is not always true, but it's often the imputation granted to the large firm. In a sense, the other design disciplines of the large firm have provided the sales effort necessary to make the survey department's phone ring.

#### Design-Build Carry Through

It may facilitate the construction manager's mission to have project's design firm also provide the construction layout. Any design errors or problems found in the course of laying out the site



will presumably be resolved quickly and without tedious and time-consuming blame-game interactions.

## **Final Check of Design**

Some large firms consider the computations for the construction layout and the layout activity itself as a final check of their design. A new set of eyes within the firm necessarily reviews the plans one last time in the course of computing the layout – and those eyes are friendly. That is, they're the same firm's eyes, and any problems discovered will be kept as quiet as possible while a resolution is achieved. This provides significant motivation for the large firm to provide construction layout for their own designs.

## **Getting Paid – Eventually**

Receiving payment for construction layout activities may take some time, depending on the client and the contract. Larger firms, while hoping to avoid delays in payment, are sometimes geared through necessity to better survive the slow-paying construction layout clients than a small operation living more or less hand-to-mouth. The large firm may take on a slow-paying client when other activities are in a lull, knowing it will survive the slow time and eventually recover its pace. A small entrepreneur often can't afford to service a slow-paying client when food-on-the-table is a major consideration and no line of credit exists to cover payroll or living needs. Many small business owners are not the greatest at running the business side of their venture. Their business may be excellent at its craft, but their owners not crafty at its business. The large firm that stays in business year after year has managed both adequately.

## **Small Firm Advantage – Marketing Considerations**

Large and small firms alike provide construction layout services. Some small business owners may feel that they can't compete with larger, more diverse firms. They may not seek construction layout contracts, reasoning that larger construction management firms wouldn't consider hiring the small firm. In my experience, this simply is not true, and the construction manager probably knows better than the small firm owner does the advantages a small firm can offer.

## **Personal Relationship**

Often, the owner of a small firm providing construction layout is present on site during all or most of the layout activities actually participating in the layout. If you are that person, it creates an opportunity to promote your company and services and to carry the air of concern for the client's needs that party chiefs of larger firms don't normally represent as well. You, as the owner of a small firm are the decision maker who can flex when the need arises. Delays due to the need to "check with the boss" are nonexistent; you are the boss.

## **Generally better qualified field help**

If you are the business owner and are present on the site actually performing layout activities, you're generally better qualified than employees of a larger firm sent to perform those same services. Often in the small firm, a licensed surveyor who is also the business owner performs the layout. Let's face it: an employee who represents the true interests of the business owner is a

rare find. Employees who've never run a business may lack business sense and the awareness of a constant need to promote and market the firm. – Very few party chiefs of large firms make a conscious effort to show the client how valued he or she is and consistently represent the professional, mature standard that the business owner makes if physically present while performing layout services.

If the business owner is actually performing the layout, it's likely that person is qualified and equipped to compute in the field, using the full capabilities of software and less likely to make computational errors while doing so. In short, this person is empowered and capable.

I've heard more than one business owner say, "I don't want my field crews doing computations in the field." Some firms still send crews to perform construction their layout from letter-size printouts of angles and distances for radial stakeout. Such crews aren't furnished uploaded coordinates and aren't allowed to both set new control points and stake from it during the same visit to the site. While this makes sense from the layout provider's viewpoint, the policy creates delays for the construction manager.

While serving as an assistant superintendent, I've seen crews come to do layout, find control has been destroyed, set new control and leave without staking what they came to stake. The new data was brought back to the office, computed, new radial stakeout notes printed, and then the work was rescheduled and then the crew came back to the site. This never sets well with contractors or construction managers. Smaller firms, in my experience are more likely to overcome the unexpected loss of control or blocked lines of sight and deliver what they came to do in their first visit to the site. This is far more economical, but the real saving is in avoiding construction delays.

## **Better Communications**

Often in a small firm, the person who takes the call for construction layout is the same person who'll be performing those services. The right questions are asked reducing chances of miscommunication or lack of communication. In my experience, the small firm owner with a crew or two in the field is more likely to provide cell phones to the crews or to supplement the cost of their personal cell phones than a larger firm. The small business owner seems to better understand how critical it is to communicate immediately when problems, questions, uncertainties or emergencies arise.

## **More Caring and Responsive**

With frequent exceptions acknowledged, it may be fair to say that the small business owner is often in a position to be more flexible, more responsive and to simply care more about the contractor's needs than a large firm with huge contracts to fulfill and the need to satisfy numerous clients who provide long-term, continuing projects. In addition, the larger firms have in-house projects supplied by other disciplines within the same firm, and these often take priority over calls for layout. Performing construction layout may be viewed as a necessary evil in some large firms, whereas a small firm is more likely to view a few-thousand dollar construction layout contract as a significant business opportunity. And, it can be.

## **More Geared to the Task**

Finally, the small firm is more likely to gear itself for the task of construction layout. Many times, the survey vehicle of the small business is better equipped for the construction layout tasks than the larger firm's vehicle. Is some supply or piece of equipment needed? The small business owner will run to the hardware store and pick up a sledgehammer, a chalk line or a can of clear lacquer. The small business owner is more likely to empower the party chief to do the same than a large firm. Many party chiefs in larger firms simply do not have purchasing authority. They need prior approval to make a purchase – and they may not be reimbursed for three or four weeks.

## **Morale may be better**

In larger firms, the sense of division between management and labor tends, again in my experience, to be greater than in small firms. A small team is easier to build and maintain than the large one, where the lack of personal relationships between higher-ups and lower-downs breeds lack of communication and mutual respect for their differing roles. In larger firms, solutions are often sought through analysis of numbers (profits) rather than discovery and remedies of more systemic ills.

For example, in a large company where equipment-purchasing decisions are made by the bean-counters, low survey department profits may be the result of antiquated equipment, yet increased profits are demanded from the ailing department as evidence of the worthiness of further investment in that department. Catch 22.

The number crunchers of larger firms are routinely assaulted with requests for purchases from all departments, often presented with similar tones of urgency. Yet, these decision-makers lack personal familiarity with the daily workings of each department and are unable to separate true needs from desires. People who choose number-crunching careers are typically not “people persons.” They're seldom seen mixing with those who actually do the on-the-boards or in-the-field work of the firm, yet their decisions impact the day in and day out work of those employees.

In a small firm, where the owner is closer in disposition and chosen discipline to the workers, it's easier for employees to present their need with a hope of being heard.

Recently, I was in a doctor's office for a series of tests. The first employee administering a test loved her job and spoke glowingly about her career. I felt at ease and rested in the assurance that this office had good people doing their jobs well. This gave me confidence in the doctor, himself. The next person to administer a test griped and complained about the lack of space to work and of the doctor's intent to hire yet another employee to share the already inadequate facility. I found myself questioning whether I'd chosen the right specialist. Then I noticed how quickly I'd gone from confidence in the doctor to questioning his capability. This change was due solely to differences in his employees' morale.

While my experience can't boast of conclusive patterns, the small firms appear to suffer less from the negative impact of disheartened employees. Exceptions noted and admitted, my experience says smaller companies have, in general, better morale. Employees with poor morale

often reveal this fact to clients and convey more about the company (true or false) than owners care to admit.

In a small company, the person or persons who benefit most from their firm's services (the owners) are closer to their employees than in large firms, and there's greater opportunity to deal with the employee whose dissatisfaction infects fellow-workers and clients on a daily basis.

## **Able to Negotiate Extra Work – Or to Give it Away**

The owner of a small firm who actually performs the layout is able to negotiate what is or is not an extra charge when the client makes an unexpected request. Sometimes, the owner may decide to simply contribute the service that's been requested as a "favor" for the sake of relationship-building and business promotion or to build good will against the inevitable mistake the firm will eventually make. Other times the owner may say, "Well, I'll be happy to do this, but it's not in my contract. Do you see any problem in my performing this on an hourly basis as an extra fee?"

The party chief of a large firm is seldom as well acquainted with the contract as a business owner, doesn't know if the project is a rainmaker or is in the toilet budget wise. Rarely is the large firm's party chief adept at asking for extra money in some on-the-spot negotiation. Most large firms will not empower their party chiefs to assume this role, and for good reason. In this respect, my vote again goes to the small firm.

## **Unfair to large firms?**

Perhaps you've noticed that I believe the small firm is actually better positioned to perform construction layout services than large firms.

Some may take offence at my belief about small firms having an advantage over large firms. I speak only from my own experience as one who entered my first surveying employment in 1963. I've worked in very large corporations having hundreds of employees, medium-sized firms and one-crew firms. And I've run my own small businesses, one of which served construction needs exclusively.

Admittedly, some large firms perform better at construction layout than some small firms do. Whether the large firm or the small firm does better at it hinges on who runs the firms, their experience, their attitude toward construction layout, their love of mud, dust and noise, their personalities and temperaments, and primarily whether they have any genuine concern for their employees and clients. It may be unfair to generalize, but my opinion is that the small firm has inherent advantages.

Have I seen it all? Certainly not. My conclusions are entirely subjective and offered for your contemplation and criticism.

## **Take courage, small business owners!**

Why open this topic at all? Because small business owners may overlook a lucrative and interesting line of work by believing they're not up to the challenge of competing with large firms. Think again, small business owners. The most money I've ever made in the past 40+ years has been as the owner of a small firm specializing in construction layout. I was in the right place at the right time and had some wonderful opportunities handed to me by generous and honest

people. Even so, I never could have been successful through those breaks alone. My clients selected me because of my knowledge of their needs, my responsiveness, my honest concern for their well being, my ability to get the job done the way *they* wanted it done, my fairness, firmness and flexibility (each applied appropriately and with discretion) and the careful and thorough approach I took when serving their projects.

Am I bragging? Well, of course. But, beyond that, I'm encouraging you as the reader, whether you're working in a large or a small firm, to serve your clients (or your employer) from the heart, to strive for practical excellence and honor – and, if you own a small firm, don't be afraid to compete head-to-head with the large firms.

## **The Large Firm's Clout**

Having said all that, a large firm that maximize its inherent advantages is a force to be reckoned with! A well run, large firm with state-of-the-art equipment and software; a culture that honors employee's family obligations; retains competent, experienced people; accommodates the training needs of our times and of their employees; rewards good attitudes, excellence and extra effort; imparts a sense of fairness, security, and professionalism to its people; and meets the scheduling demands of their construction layout clients... Whew, I had to take a breath.

Such firms are a powerhouse!

## **Large firm or small firm, be the best and be bold!**

Ask around. Talk with construction management firms. I think you'll hear from them what I've heard. Finding a large firm that's responsive can be a challenge. Finding a small firm with the equipment, expertise and reliability that construction managers require can also be a daunting task.

Be the best, whether large firm or small, and someone out there is searching for you and has been for a long, long time. It's not a matter of selling yourself. It's a matter of revealing yourself to the people who need you. And, that's what we'll talk about next.

## **The Marketing and Sales Effort**

This section, while directly applying to firm owners seeking contracts for construction layout activities, provides insight to any employee performing construction layout services.

## **Why even those employees who are not involved in marketing and sales should read this section**

Please, employees, don't skip over this part of the course. You'll be a much better representative of your employer if you know what goes into getting a contract and how hard your employer works for you. Many, many employees fail to appreciate what their employer goes through to get contracts that provide the employees' regular paycheck.

And, your function as an employee performing construction layout is to honor the contract between your employer and the client. This course material is relevant to you.

## Sales or Marketing?

Before attempting to sell your services, doesn't it make sense to find out what services are typically needed? Why waste time trying to sell shoes to a person with no feet? Is there a need? Are you able to fill a need or to adjust your service package to fill a need? These questions must be answered before launching into any sales presentation. Keep some points in mind.

## Who wears the pants?

Who wears the pants in your family? You've heard that expression, and it means essentially, "Who is the decision-maker?"

Before making a marketing effort or sales presentation, doesn't it make sense to find out who has the authority to actually contract you to provide your services? Talking to the right person is a key to the success of your sales and marketing effort.

Suppose I'm the best roofer in town. I spend an hour giving the best presentation on roofing the world has ever seen to the occupant of a home that's in desperate need of a new roof. Then, at precisely the right moment to close of the sale, I turn the contract I've been filling out as we've been speaking so it's right-side-up to my potential customer and ask for a signature, so we can schedule the job. The person says, "This sounds great, I'll pass it to my landlord."

What have I done wrong? I've been talking to a person without the authority to buy what I have to sell. The need for re-roofing is clear. I've made it known that I'm capable to do it. Someone, if not me, will surely meet that need in the near future. There are many incompetent people out there wanting the assignment. I honestly believe I can do the most for my client. The problem is, I've not been talking to my client. My potential client is the landlord, not the tenant. And, the tenant will never represent me to the landlord with the persuasiveness I could have.

My first question should have been, "Are you the owner of this home?"

In marketing and sales, it's best to keep these two activities separate in your mind, so you don't try to sell something there's no market for or spend time selling to people who aren't empowered to buy.

How do you perform these two functions effectively? Talk to people. Get them to talk about themselves. And, LISTEN.

## People Love to Talk – About Themselves

Occasionally, you find people who *don't* like to talk about themselves, to tell you of their achievements and their expertise. Generally though, it isn't hard to engage people in conversation about themselves. Your client or potential client may find it refreshing that you ask about what they do and what they need rather than launching into a sales pitch for pre-packaged services.



## People Like to Help People

In general, I've found that people like to help others, provided there's an end in sight to the help provided. For example most people will allow you to ask them questions aimed at benefiting you, even if it is not to their direct advantage to do so – provided they know why you are asking and how long you intend to tie them up.

## Is There a Market?

If you are interested in providing construction layout services, you have to know a couple of things: first, who needs it and second, what precisely do they need?

When you've made a personal contact with someone who awards contracts for construction layout, you need to know if there's any possibility you will be considered to supply this need. You need to know if not, why not and if so, what can you do to make this happen.

## Suggested Approach to Marketing

### Consult the expert

Visit a construction site large enough to have a construction trailer or other construction office on site. Ask to speak with the construction superintendent.

Say something like the following: "Hi. My name is So-and-so, and I'd like to get into (or expand my services to include) construction layout, but I need some help understanding how your firm and firms like yours handle construction layout. I wonder if you'd consider allowing me to ask you some questions for about ten minutes to help me learn whether or not there's any potential for me to provide these services. I could come back if this is a bad time for you, or if you'd rather not help me, I'll understand."

You then pause and allow the other person to respond. Generally, you will get to ask your questions, if not in this meeting then at some other time when the person is available. If you are given a time to return, I suggest asking, "How do you take your coffee? I'll bring you a cup when I come back." The offer may be refused, but if you're told how the person takes his or her coffee, absolutely do bring a cup with you when you return. It's amazing how far this can take you.

### **This is not a chat – You're on a mission.**

The person who has agreed to meet with you is a busy person with an important job to perform. Have your questions prepared and don't try to small talk yourself into this person's favor. Carry a small pad to jot notes on, but don't pull your pen out yet. Get talking first.

Your questions should include:

Do firms like yours hire sub-contracted construction layout, and if so, how extensive is the layout performed by them? If the answer is the firm that employs your interviewee does all of its own layout, then there are two avenues of investigation. First, to the other person's knowledge, is this true of all similar firms in the area? If so, why is this and is there any possibility for change?

If not, which firms are known to hire/not hire out construction layout? (Now, out comes your pad. Write down names of firms that may hire out the services you'd like to offer.) Then, ask if there is anyone in any of these firms who you might speak with. If you're given a name, write it down, ask what their function or title is in the firm.

If the firm that employs the person you're speaking with *does* hire out construction layout, ask whom you should speak to in that company about your interest in providing future services. Find out if the person you're referred to is the only person who awards contracts or if there may be others in the firm with whom you should speak. Write their names down and their titles if possible.

Ask what layout services are typically contracted out. For example, does the firm typically supplement sub-contracted layout by doing some of it themselves? Do their subcontractors provide their own layout? Who marks clearing limits, stakes for rough grade, lays out primary building control, column lines, utilities, roads, drives and parking areas?

Listen well. Make short notes. You may even want your typical questions and answers pre-written on your pad, so you only need to place check marks next to key words, "building, utilities, parking, etc."

Everywhere else in this course, clear handwriting and labeling is celebrated. On your pad, though, don't strive for this. You don't necessarily want the person you're with to read everything on your pad.

Close with something like, "That's all I can think of asking. Before I leave, is there anything at all you've thought of as we've been talking or that I've not asked that I should have?" Any tips offered here represent the person's own initiative. You can receive invaluable counsel at this point. So, mean it when you ask.

As you stand to leave, shake the interviewee's hand and thank this person for the time taken out of a busy schedule to help you. Use the word, "help."

And, as you're leaving, if the interaction has been favorable, you might say, "You've been so helpful. If I think of something after I leave or when reviewing my notes, would it be all right to call you again? I promise not to make a pest of my self."

If this courtesy is extended, try to get the individual's business card and ask what times of day are typically bad or good if you should call again.

## **Don't gratitude jes warm yer heart?**

Think about it. When you make a hand-motion through your windshield, telling the other driver to go ahead of you or step aside in the line at the checkout counter to let the lady with her arms full of groceries check out before you do, are you like me? I'm happy to be courteous and helpful. But, I really would like my gesture to be acknowledged and appreciated. I'm annoyed when the driver goes ahead of me without a wave of thanks, or the lady in the grocery line just steps in like my personal space was reserved for her, and it's about time I figured it out.

I've received a free education more than once from people who were grad to stop their own work and answer my questions. So don't imagine I dress in a tutu when I say, "Send a Thank You



card.” (Select one without flowers and lace along the edge though – unless you’re trying to convey something different than I would be.)

So, within a day or two of your visit, drop a small thank-you card in the mail addressed to that person’s attention with a one or two sentence, hand-written note of appreciation for the time spent with you and the help given. Do not promote yourself or your firm in any way in this note, but do include something specific like, “Thank you for helping me with my questions regarding construction layout.”

Remember, by the time a couple of days have passed since your interview, the interviewee has likely forgotten you. Give some clear clue to bring you back to remembrance. If you merely say, “Thanks for meeting with me,” the person may not connect a jogged memory of you to the thank you card.

You might even consider including a coupon from the local donut shop with a note saying it’s a token of appreciation for taking the time to help you out. This way, you’re thought of once again when the coupon is redeemed.

The last thing I want is to give an ungrateful person tips on how to fake gratitude for the sake of marketing and sales. But, that’s not you. If it were, you’d be calling me during the dinner hour to sell me a time-share vacation package to Fargo in January.

But, I’ve been surprised by the benefits of showing gratitude. It’s a vanishing trait in our society, so you get a chance to bless someone and yourself at the same moment. Isn’t that great?

## **The Worst is Over**

Well, I’ve digressed with that Thank You card idea. So, you’ve finished your first interview. You’ve learned a lot. You’ve just done real marketing, and it really wasn’t as hard as you’d imagined.

Your mission was to find out if there is a need, a market for something you offer. It has been your first “cold call,” and it’s behind you. The next one is easier. Perhaps you’ve even gleaned a name to contact for your next interview and a name to drop when you get there. Don’t let your shoes cool. Make another call, and then another call. And, keep it up until you know what it is you have to offer and to whom.

## **Northern Virginia in the mid 80’s and Northern New England in the early 90’s**

Different geographical locations go about construction layout in very different ways. In the mid to late nineteen eighties, I founded a construction layout business in the Washington, D.C. suburbs of Northern Virginia, primarily in Fairfax County and eastern Loudoun County. Contractors were not generally allowed to begin construction of any specific construction until a county inspector personally delivered a “cut sheet” to the site. Much of the booming development in the Dulles Airport corridor was what construction management firms termed, ‘mid-sized development.’ Due to a high degree of regulatory oversight and the resultant

complexity of paper documentation, licensed surveyors performed most of the construction layout in Northern Virginia.

I was licensed as a surveyor in a few states by that time, but not a licensed surveyor in Virginia. Therefore, I functioned as a contractor providing construction layout services. Most measuring and staking for construction did not require the seal of a licensed surveyor and was not defined as “surveying” by that state’s statutes or administrative rules. The main exceptions were as-built surveys and setting final corner monuments. These functions must be performed by or under the direct supervision of a licensed surveyor. Usually, a surveyor employed by a project’s engineering design firm performed these tasks. Because I was not a licensed surveyor, services requiring the signature and seal of a licensed surveyor were simply not a part of my contract for construction layout services.

An important aside to those who are *not* licensed professionals: It’s critical if you’re providing construction layout to not inadvertently cross over a legal division line and provide measurement certifications, mapping or reports requiring professional registration.

It was difficult to fail at business in Northern Virginia during the mid-1980’s. Development was peaking. Design professionals serving the rapid development had too much work. In general, construction management firms told me that large engineering/surveying firms were not responsive to their construction layout needs. Rapid development was stressing construction management firms, contractors, and surveyors alike.

In Northern Virginia, my capabilities and a “market” met, and I prospered by providing my clients’ needs. My business in Northern Virginia was an immediate success.

Just a few years later, in northern New Hampshire, I learned through marketing that I stood a snowball’s chance in hell of getting a single contract for construction layout, and I might as well not even put forth a sales effort in that market. In that rural environment of northern New England, most layout was performed by the bulldozer (no layout at all in other words). When stakes were actually needed, the contractors set their own. Exceptions were rare.

The mission in your marketing effort is to determine whether it’s feasible for you to promote construction layout services. When making your marketing cold calls, you are not selling anything; you’re determining *if* there is a market. This puts the people you talk with at ease. If there is a market, they will steer you in its direction. They may even ask you to bid on a project or just plain hire you to do something for them. But, that isn’t what you’re there for? Don’t ask for work in this meeting.

## **After Marketing, What?**

After a dozen or two interviews (or at least a few), pause to digest what you’ve learned. You could become so good at interviewing that you forget why you are doing it. At some point, and you need to discern when, its time to offer services that you know are both needed and typically hired out.

Ask yourself, what is the most common complaint I've heard. What is it that I can offer to make the lives of the people I've interviewed easier or less troublesome? What do I have to offer that others providing service can't or don't give their clients?

Don't underestimate that you've recently developed a relationship with the people you've interviewed. They've helped you, and they've probably liked doing it. That, after all, is the basis of your relationship. Now, take it to the next step.

Make contact. Tell them you'd like to work for them and serve their projects. Tell them you know you can do what they need and you want the opportunity. Ask them how to best go about that.

Listen and follow their instructions.

But remember, this is not a marketing session; it's sales. If they already have someone who "does all their work," ask if it wouldn't be better to have two good someones? Suggest that maybe they'd be willing to throw you even a small job, just to see how you do. Or, perhaps there is some unusual task or immediate need you could meet. Ask if there is a project coming up for which subcontractors have not yet been selected. Can you bid on it? Suggest, ask, and be persistent. Don't be afraid to appear excited and eager.

But, don't be arrogant or demanding. Think of the stray puppy that won't leave your doorstep, but just keeps smiling at you with a look that says, "You are the person I've been looking for. I'd be a great pup if you'd just open the door and let me in and feed me." OK, you're nobody's pup. I understand. Just realize macho has its limits, and sometimes being likable and eager to please will get you what you need. Maybe that doesn't fit your personality. But, something does. Find it and stick to it.

## **Sales – a little understood profession**

Once driving 30 hours alone in the car, non-stop from Florida to Connecticut, I listened to recorded teachings on successful sales techniques. I listened attentively the whole way as it kept me interested and awake. Also, it transformed me.

Prior to this road trip, I viewed sales as a profession suited only to pushy, self-centered, foot-in-the-door sorts of people. After that 30-hour, sleep-deprived indoctrination, I realized the central role that legitimate and professional sales play in the well being of our nation. I came to understand that "buyer objections" are often presented so that you can help the person overcome them. Sales, I learned, is the act of helping people to have what they want in the first place, not manipulating them into spending for something useless or taking money out of their pockets just so mine could be stuffed.

If you, like so many people, feel that to sell your services would be to sell your soul in the process, may I recommend that you read or listen to teachings on sales? I've come to respect sales and see its role in the wellbeing of our nation's economy – not just my own. Selling your services is largely letting it be known that you are qualified, responsible, dedicated, capable, ready to serve and seeking to meet the needs of your potential clients. And, it's important to sense when this point has been made, and it's time to ask for a signature or a contract – to 'close' the sale. This course is not on sales, but many good courses are.

## Bidding

OK. So, you've marketed and determined the need. You've sold yourself, or you've seen a request for proposals or maybe learned through the grapevine about some upcoming project. You've been asked to provide a bid or proposal. You need to get a set of plans, review them, estimate the time involved in providing what's required for the project's construction layout, put numbers to the effort and come up with fees for your proposed services.

### **First, determine whether your potential client has actually been awarded the construction contract.**

#### **If not, a general estimate may suffice.**

Some construction management firms seek construction layout estimates just to determine construction layout fees they should expect IF they are awarded a contract THEY are bidding on. It's important to know if the firm asking you for a quotation of your fees has actually been awarded the contract for that specific project, or are they are bidding on it themselves and wanting your estimate of layout services in order to fashion their own bid?

There's a difference between your bidding to obtain a contract for your services and working for free for a prime contractor seeking their own contract – a prime contractor who may or may not use you even if they *do* get the contract themselves.

A dilemma is a situation in which there are two choices, and they both stink. The dilemma in this case is:

- Choice #1, to invest in bidding for a firm that's also bidding and may not even be awarded their contract, and may not give you a contract even if they get one themselves, or
- Choice #2, to decline making the effort, almost certainly knowing that firm won't call you if they do get the contract.

What to do in this loose-loose situation?

I found my solution in a third alternative. I determined through a joint investigation with a client that full-service, construction layout fees for mid-sized, commercial projects having one- or two-story buildings ran somewhere around one half of one percent (1/2%) of the total construction costs for the project.

With this formula, I was able to throw an approximate number at most projects simply by asking the person asking me for a quotation, what approximate construction costs were expected to run for the project. Knowing this, I could offer an estimate over the phone based on this formula:

$\$1,500 + (1/2\% \text{ of the construction costs}) + (\text{add } \$2,000 \text{ for an artistic layout of parking and drives or subtract } \$1,000 \text{ for a dull, rectangular parking and drive configuration})$

Thus, for a project with total, expected construction costs of \$4 million, the cost of providing full-service, typical layout costs runs roughly \$20,500 to \$23,500. If an as-built survey is part of the contract, add that in, but often it's not included in the construction management firm's proposal.

Construction layout costs are a very, very small part of an average, mid-sized construction project. Even if *complete* layout of typical items is contracted, as it was in Northern Virginia, it's still a rather small part of construction costs.

The above formula is an example, not one you should apply unless it fits your own experience. Once you gain experience providing typical services to projects of similar scope in your own region, then you may be able to provide rough estimates, but clearly qualify your quotation as such. This will save you lots of time.

Of course, if you're hungry for work and have nothing better to do, then go ahead and take the time to prepare a solid estimate, one you're willing to live with if you eventually do get the contract. It all boils down to whether or not you have a standing relationship with the firm requesting your "bid" and what that relationship or lack of relationship suggests.

The decision whether or not to provide a fee quotation to a firm seeking a contract themselves is a business decision and should be viewed as such.

If you've determined the firm requesting the number from you does not have the contract they themselves are seeking, don't be afraid to ask, "If you *are* awarded the contract, will you award the construction layout contract to me?"

### **Consider the odds:**

Suppose a firm asks you to bid on a project they don't yet have, but if they should be awarded the contract, then they will then put you in a competitive bid situation for construction layout with several of your competitors. Let's assume that firm gets about one in seven projects they bid on. Perhaps you get one in five awards for proposals you furnish. What are your chances of being awarded the contract? Low!

But, if the firm asking you for a number to include in fashioning their own bid habitually uses your services exclusively or nearly exclusively, your chances are nearly one in seven, and that's as good as it gets. Not so bad, really.

I've received calls from firms that I suspect will never use my services, asking for a bid on a project they don't yet have. Usually, I've politely declined, thanking them for thinking of my firm –or– I've thrown an approximation at them, like the example above, stating that I'll be happy to provide a firm number should they be awarded the contract.

Of course, you need to be careful about turning potential business away by being uncooperative or unresponsive. If you can afford the time it takes to meet their need, use it as a sales opportunity. Show them what its like to work with you.

Be alert to mathematical patterns of past fees for completed projects. Develop rules-of-thumb for typical projects and carefully track your completed project costs with actual assessments of your fees, profits and losses. The rules-of-thumb you develop will save you countless hours of

unbillable time estimating fees and help you not to run up your fees on the jobs you do get to cover your overhead for bidding on ones you didn't get.

## **If the firm requesting your bid already *has* the construction contract, then get very, very specific.**

If a firm requesting an estimate or bid already has a contract themselves and is truly in a position to award a contract for construction layout, I'll almost always provide a bid. As covered in the section of this course under Contracts, my bid and my contract are one-and-the-same document, called "A Proposal."

It takes time to review a set of plans and to determine the extent of layout the particular client is accustomed to needing or desiring. In my experience, the time involved varies greatly from client to client, from project to project and especially from one geographical area to another.

The key question to remember here is, what is the statistical probability of receiving a contract from this bid, and what is the promotional value of taking the effort and time needed to provide a firm bid? If you get one in five contracts you bid on for firms that already have their own contract in hand, and your average project costs you four to six hours to review a set of plans and make a formal bid, then the average project you're actually awarded must cover twenty to thirty hours of your administrative time spent bidding.

Bidding, contracts and client relationships are probably the hardest, most daunting aspects of developing a construction layout business. It will try your wits and test your patience, and the faint-hearted small-business owner may wilt. But, don't faint yet. The rest of this course will prepare you with the most important I've learned, and that – with serious, consistent effort on your part and what some call luck (I call grace) – will carry you a long way toward success.

## **How to win playing the 'Apples and Oranges' Game**

You've heard the expression, "You're comparing apples and oranges."

What's meant is that some significant differences exist between two things being compared, and therefore the comparison is invalid. When bidding construction layout, this is a big problem. More on this in a minute.

Should you review a set of plans, draft your proposal, stick it in the mailbox and hope for the best? There's probably a better way.

Some firms prefer that you review a set of plans in their offices, but I almost always request a set of site plans and foundation plans that I take with me, mark up and keep. Generally, this request is granted. The site plans show the site improvements (clearing limits drives, utilities, building location on the site, property lines, etc.) and the building foundation plan shows the complexity of the footing design and column layout. The extent of construction layout required (and thus my bid) is based primarily on the amount and the complexity of the specific project's layout.

If there's any way I can actually possess a plan set to keep, I'll go for that, even if it means having the most relevant-to-bidding sheets duplicated at my own cost. Another reason to retain



copies of the plans is to determine that no significant changes to the plan are made between the time of making a proposal and the awarded of a contract.

On my copy of site plans, I high-lite features to be staked in different colors to distinguish them. A map-measuring wheel run along the high-lited lines determines the linear feet of pipe, curbing, etc. Distinct colors make counting the number of storm and sanitary structures, hydrants, tees and valves a relatively fast procedure and generally insure I've not overlooked something significant.

In different geographical areas, curbing is constructed differently, and these differences change the amount of layout normally requested. This can greatly influence both the intensity of the layout needed.

## **Now to explain the “apples and oranges” game**

To be a successful bidder, one must play this game very, very carefully. Basically, the problem bidding construction layout services is that your competition may consider the layout needs to be less intensive than you do. Suppose both your bid and your competitors' bids list the identical line item, “Stake Curbing.” In each of these bids, a fee is associated with that item.

Your potential client assumes you and your competitors intend to provide identical services, and the only variable between you all is the fee associated with that same service. Yet, you and your competition may have vastly different intentions.

For example, in areas where monolithic, concrete curb-and-gutter are used, the majority of the curbing will be constructed by a machine following a string line the contractor sets from construction layout stakes. This type of curbing is constructed prior to paving operations. In other geographical locations, bituminous concrete (asphalt) curbing is set on top of previously constructed pavement.

Normally, concrete curb-and-gutter requires a significantly increased amount of stakes set to govern its construction than does bituminous curbing. Concrete curb and gutter layout should signal transitions from gutter sections pitched away from the curb to areas where the gutter slopes toward the curb. Stakes should indicate where depressed curb sections for drives or handicapped access or sidewalks occur. Staking high or low points is also necessary.

Why stake all these features? Why not just place stakes every 50 feet? Very few visual clues exist on the site to guide the contractor installing concrete curb-and-gutter, because it's often the first, surface site-construction to appear once utilities are installed. Skimpy layout that omits high points, low points, transitions from catch-curb to spill-curb gutter sections, depressed curb sections and handicapped ramps breeds the potential for costly construction errors. And these might be considered the fault (omission) of the construction layout provider.

Often, the laborers preparing the construction from your stakes are not the best at reading and interpreting plans. If your stakes don't draw attention to the above described curb changes, those features may be overlooked during construction. Concrete curbing is difficult to demolish and replace when errors are discovered after it's built. If a section of depressed curbing is omitted and the construction manager asks the curbing contractor for the reason, you don't want the answer to be, “Well the layout person forgot to stake it.” At this point a debate rages as to

whether the contractor should have seen this from the plans or if the construction staking should have included this important feature of the curbing.

Using concrete curb and gutter staking as our example, let's examine how the apples and oranges game is played.

If your bid includes thorough staking for curb-and-gutter, but your competition plans to stake at 50 foot intervals, regardless of what happens in-between, or to stake gentle horizontal curves in the curbing at 50 foot intervals, but you know the contractor really needs stakes set at 25 foot intervals for these curves, you are not competing on an equal footing. Your competition is not offering the same product you are. The "Stake Curbing" line item you and your competition list in your bids is an "apples and oranges" situation, or you might say a "Cadillac and Chevy" situation.

Before submitting a bid for a complex project where the client has not specified precisely the degree of layout required (which is almost always), I request an opportunity to speak briefly in person with the project manager or the person who will be overseeing the bidding process. My stated purpose is verifying that my proposal and the client's needs are in harmony.

If asked whether this meeting is necessary at the bid stage, I say that it is in the client's interest to avoid future "extras" or "hourly" fees that my firm or a low-bidder's firm may generate. These terms (extra and hourly) get the attention of general contractors and construction managers. Normally, dropping these words will get you the meeting. Saying the word, "extra" is like saying, "crash" in an airport control tower.

I call this the "Pre-bid Meeting to Define Scope." At this meeting, I start playing the apples and oranges game, and I'm playing to win.

## **Pre-bid Meeting to Define Scope**

### **Remember, you're only .5%. Be succinct.**

Remember the little ellipse at the bottom of *Figure 1*? For providing *full-service* layout on a typical, mid-sized commercial development project, your total fee amounts to ½ of 1 percent (and sometimes even less) of the project's construction costs. I can't remember bidding for a construction layout contract exceeding a few thousand dollars without first having a preliminary meeting with the construction management firm's project manager or superintendent. Whether I get my own set of plans to keep, or I'm forced to review plans in the construction manager's office, I will always review the plans, formulate my notes and questions related to the specific project, and only then ask for a meeting.

No construction management firm has ever refused me the opportunity to meet briefly with them. In requesting the meeting, I explain that I've reviewed the plans, and that has raised questions related to the project's layout requirements. I tell them I need to ask just a few questions. I want this meeting to be in person, so I'll make every attempt to make that happen. If asked why this meeting can't take place over the phone, I'll say that some of my questions require pointing to specific plans and it will take less time and be simpler to meet briefly in person to avoid miscommunication.



## Best time for sales

If you know your stuff, this meeting is a soft-sell opportunity during which you show your interest, diligence and knowledge of your client's needs. Construction projects are complex happenings. If you're sensitive to the nature of construction processes and to the functioning of the team that turns designs into 3D reality, you'll be a step ahead of most of your competition. If you're new to construction layout, simply state that you're aware that different firms require vastly different amounts of layout control, some providing most of their own control after basic points are established, and others preferring to have almost all construction control set by a specialist. Ask what your interviewee's firm historically requires for layout of similar projects.

As noted elsewhere, the construction management firm may have an assistant project manager assigned to the project, and this person is typically (though not always) somewhat inexperienced. This person may be a recent graduate working through a career path and handling some of the nuisance functions the project manager is pleased to off-load. If you do end up meeting with an assistant who appears to lack specific experience, ask a few questions that you know this person can't answer, and then ask if you might meet with one of their superintendents to seek some specific guidance about what this firm generally requires. Explain that the variables in actual staking provided to different firms are endless, and you don't want to either inflate your bid with fluff or fail to provide realistic fees for your layout by leaving out any service the firm normally wants.

## Amount of layout required – Questions to ask

In the construction layout business, profit or loss is primarily determined by the relationship of time spent to fixed fees. In order to create a proposal or submit a bid that's truly suited to both the client and the project, you must find out specifically what is needed.

Consider asking the following questions.

- Will you require clearing limits to be staked?
- Will you need rough grade staked, and if so, do you envision a grid approach or a features approach or a combination of both? (Having become familiar with the plans, you are probably in a position to suggest what's needed, unless the client already has thought this through.)
- Do you require full runs of utilities staked or just the structures themselves? Many utility contractors will set storm and sanitary pipe grades with a laser device that's set in the structure and projects a beam of light to keep the pipe that's being laid both straight and at a constant grade. This makes offset stakes set along the run of pipe of little value. This is a place to beat your competition at the apples and oranges game by specifying layout at structures only, if a laser is to be used.
- Will a control rectangle suffice for building construction or will multiple corners be staked and offset both ways? Will all column lines be staked or just a few major lines? Will the footings be marked with wall corner locations for forms or block work?

- How much control will be needed for drives, roads, parking, etc? Ask if curbing or parking and driveway layout is typically at 50 ft. intervals for straight sections and 25 ft. intervals for curves, with short radii staked directly. If GPS control on dozers and graders will be used, how much primary control will you be staking and where?

Find out as much as you can about what the client wants for the project you're going to bid on and make your bid or proposal reflect those wishes.

## **What client equip. & personnel will supplement your layout?**

Generally, but not always in my experience, new additions attached to existing buildings require little or no layout. However, this should not be assumed. Ask.

Some building contractors provide their own layout entirely. Others work from minimal, primary control that you provide, and still others expect considerable layout provided for them. Which is it? You need to know and to specify precisely what you include in your proposed fees.

Ask lots of questions, but keep perspective – not your own. Realize that your fees are likely to be 1/2% or less of the construction costs for an average, mid-sized commercial project, assuming ALL construction layout is performed by you with the exception of building control within the structure once it comes out of the ground. Your 1/2% is a tiny part of the whole project. Don't think the project manager or superintendent wants to spend the whole day in your company. Get in, ask your questions, make your impression and your points, and get out. Respect the construction manager's time and other priorities.

Some general contractors provide the lion's share of their layout using their own employees and equipment. Others view their role as strictly management and oversight and provide neither layout nor checks of layout on their own. You need to assess your client's participation in the layout/verification role and what exactly you will be expected to provide and not provide.

## **Opportunity to save client money with suggestions as to scope**

If you know your stuff, occasions will develop for you to suggest ways to minimize layout or to combine layout to your client's advantage. The construction management firm is always looking for ways to "value engineer" their projects. If you make a suggestion that saves a trip to the site, eliminates or combines layout or otherwise saves the client money and time, you will be appreciated. The more experienced you are and the less experienced the client, the more opportunities arise.

But, realize that your fresh set of eyes may see something the client is too close to the project to see. Never get haughty, but humbly ask if your suggestion might be useful or appropriate.

## **Low Bidder – Apples and Oranges – and Extras**

The primary focus of this pre-bid meeting includes getting a sense of what exactly is anticipated by the client in the way of layout services. This is a critical matter to both you and the construction manager. From your point of view, if you include more services in your bid than your competitors, you will most likely not be the low bidder. In the hustle and bustle of your

client's office, it's conceivable that some administrative assistant or lower-level employee will sort through the bids, not really understanding them and just enter a bottom line total from your proposal alongside that of a competitor who omitted some line items deliberately in order to come in as low bidder.

The consequences of your leaving out significant functions in order to be competitive with such folks are the generation of extra charges, change orders and hourly billing. And, this makes you very unpopular with your client. While in your meeting, state clearly that other bidders for the construction layout may play this "apples and oranges" game at the construction manager's expense and frustration. You don't want to do this, but you need a level playing field in order to be successful. Ask for an assurance that line items in the construction layout bid will be considered and compared.

In a humble posture, let the person you're meeting with know the games your competitors play when it comes to construction layout bidding, and tell them what it can mean to the project – unanticipated hourly fees and extras. Let them know that you're between a rock and a hard place: You don't want to leave things out of your bid, but you know others will, and you don't want them to unfairly underbid you. Your concern is that a competitor uses this tactic, gets the award and later throws lots of "extras" at the general contractor for items that should have been included in the original scope of the bid.

Get quiet, and listen to what you're told in response to this. You may be given some tips on how to frame your bid. You may get a commitment that bids for construction layout will be reviewed carefully, and that bids leaving out important items will be rejected as unresponsive. This is what you want. Again, try to get a commitment – the person's word on this.

You may receive a frank admission that low bid will prevail no matter what. In this case, try to elicit an agreement that you will not be looked down upon for stripping your contract services to the bone. Any helpful, sympathetic or candid response will mean this person is to some measure 'in your court.'

Most importantly, you establish dialogue with your potential client about matters important to the success of his or her project, and you'll leave the impression that you're a person who is wanted on the team. If this person WANTS you, you may find that he or she finds a way to make it happen, no matter what public face is put on the bidding process. You want to be remembered as the person who went the extra mile at the very beginning of the project to assure a smooth, hassle-free, professional, team approach. Do not underestimate the potential in this meeting to set you apart from your competitors.

It may be appropriate to say when leaving something like, "Well, I really do want this assignment. If there's anything in my bid that's extraneous or seems out of line, I'll be grateful for the opportunity to review it with you."

## **Strictly a low bid situation?**

Firms have called me in to discuss my bid and essentially told me what I need to change in my proposal to "make it happen." Generally, the change was something I could live with. Flexibility sometimes appears where none is thought to exist. If you are wanted by the client, the client can

often make it happen. Most of your competitors will not pursue a client in the way I've suggested, and this pre-bid meeting may create a strong advantage if you're sincere and capable.

Of course, if the situation is strictly a low-bidder-gets-the-award, then there will be no room for negotiation. I've been on both the winning end and the losing end of situations that appear to be strictly low-bid but are blended invisibly, if not secretly, with a negotiated-bid approach to the award. The key is to get the best information you can and tailor your bid to the client and project. If clients want you, they often find a way to make that happen.

In some cases, you may determine it's best to break your proposal into two categories: Essential or Expected Layout and Optional Layout. Using this approach, you place only truly essential construction layout in the first category and other things you think will be needed in a second category. My advice is total the first grouping and do not total the second. Make the optional items an addendum on a separate sheet, and pay attention to your graphics so that "Optional Layout" is in distinctive lettering. Remember, you are playing the apples and oranges game to win. When playing against tight competition, never get "flowery" and include everything you can think of.

## **What if the client beats you down?**

If your client cuts corners violently and squeezes you tight, then omit all fluff. Get the contract. Later, when layout is requested that's beyond the scope of your proposal, bill it as an extra or as hourly fees.

Often a recent graduate of a construction management educational program is assigned to the grunt work involved in procuring bids and sifting through them. You generally want to meet with a decision-maker, but if you have no option but to meet with a young person who you deem is "wet behind the ears," use the occasion to respectfully educate this person to the construction layout function, its significance, the importance of responsiveness to calls for layout, and the "apples and oranges" game construction layout competitors play. Sell your capabilities and stress anything that sets you apart from the competition.

Tactfully instruct this inexperienced person. Say that you know specifications seldom address the critical services you provide, resulting in wide variations in the actual usefulness of the layout provided by different firms. And, you realize that final costs for construction layout often run well above original bids. Let them know you're sensitive to the fact that sub-standard and unresponsive layout contractors significantly impact the project, causing delays, confusion and frustration. You understand this. You take their project seriously, just as they do. You are the one who cares, and you're available at any time to answer any questions that may arise or to help in any way you possibly can.

Seldom have I been unsuccessful with this approach to "bidding." Don't think of bidding as reviewing plans and throwing numbers in an envelope. Look at the big picture. Construction is a team effort by nature, and the bottom line for most subcontractors is their own interest and profits.

If you genuinely care about the project, have a heart to serve others and take your place on the team through diligent performance, you *will* stand out – and that's that! If you are such a person, the world is searching for you.

## Summary – The Bidding Process and the Pre-bid Meeting with the Client

If you can't get a contract for layout services, it matters little what your capabilities are or how expertly and professionally you'd serve those clients you don't have. Knowing the strategies discussed above should net you an edge over your competition. Much of your success in the construction layout business is linked to activities that are beyond the physical act of setting control:

- Applying marketing and sales strategies that work – each in its time
- Understanding the inner structure of the construction management firm and how to relate to your client's project team members
- Knowing how much layout is typically required in your region in general and specifically by the clients you wish to serve
- Knowing how to play and win the Apples and Oranges game
- Structuring your proposal to fit the specific needs of both the client and the project
- Establishing yourself as a true professional – one who places himself or herself in the head of the client and serves from the heart

### A word to employees

If you are reading this as an employee whose job places you on the sites, actually performing the layout, please don't think the sections of this course related to business are not for you. What you learn will benefit your employer in several ways.

If you know how much effort goes into getting the contracts that net you a regular paycheck, you'll be more appreciative of the fact that you can pretty much go home at night and forget the job. Most employers can't do this.

And, you'll appreciate more as the course develops how knowing the obligations and limits of your boss's contract make you confident as you work. You are clear-headed when approached by the client with a work request. You need to know what your boss is and is not obligated to perform on a set-fee basis and be able to handle requests for additional work with ease.

The more an employee understands the boss's and the client's business relationship and the considerations each must balance, the better employee you'll become. Knowing what is in the contract and taking care to meet those obligations without doing extra work for free increases your value as a team member. You'll stand out as one who's thinking and acting beyond the norm.

It's a terror to your employer to have non-thinkers doing their construction layout. You'll be appreciated and rewarded as your diligent performance and business sense becomes evident to your employer.

As an employer, I can state with certainty that I can find and hire a party chief for boundary and topo surveys far more easily than a party chief I'd trust with construction layout. The survey crew that knows its stuff at construction layout is a rare find.

## **CONTRACTS – This section does NOT constitute legal advice!**

A wise person offered the following advice long ago, and I've never forgotten it:

*“A lawyer is like a bulldozer. Hire one a size larger than the job requires, and you'll save money in the end.”*

### **Bid the Professional Way – Submit a Proposal**

My proposal essentially becomes a legal agreement or CONTRACT when signed by the client and returned to me. If the client signs my proposal and returns it to me, my offer is accepted. My proposal doesn't have to *look* like a contract, but it should function as one. That is, it should obligate me to perform certain, limited and well-defined services in exchange for specified consideration (money), once my client has signed a copy of my proposal and returned it to me.

Decades back, professionals did not enter into competitive bidding. Bidding was unprofessional conduct. Even though competitive bidding has become commonplace for professionals who perform construction layout, I don't submit BIDS; I submit PROPOSALS. Personally, I believe the construction layout services I offer are clearly professional in nature. I don't care if a client selects me because my fee is the lowest or because I'm the best qualified or for any number of other reasons.

Suppose a client has decided, based on my proposal, that I'm their pick. They just sign and return a copy of my proposal, and I become the official provider of their construction layout services, right?

Probably not, except for small business clients.

The reason is that larger construction management firms have their own, standard contracts with standard boilerplate language that they use with all their subcontractors. They add some wording to a blank area of their standard contract form and send it to the bidders they've selected. Because of this, larger firms seldom sign my proposal and may not even reference it in their contract. We'll come back to this later.

Before taking this topic further, let's briefly look at the nature of contracts to better understand what is at stake.



## Contracts – Legal Documents (Consult a lawyer)

Again and again I say, I am NOT a lawyer. I'm a surveyor. I speak from my experience and what I *think* is true. If you want sound legal advice, ask a good lawyer. If I should fail to state clearly that I'm not offering legal advice, and you got bad opinions or bad legal advice from me, I could probably be held liable for representing my self as a lawyer, which I'm not. So, if I give you bad advice and you follow it, you're up a tree.

Keep in mind, though, if you get bad advice from a lawyer and act on it and find yourself in a legal jam, you probably can't sue that lawyer. (There's justice for you!) In fact, that same lawyer will be happy to represent you in the legal action that's a consequence of having followed his or her original counsel. This way you get to pay that lawyer for both the bad advice and for representing you in the legal action you'll probably lose because of poor legal representation. (Did you follow that? Read it again if you need to, because it's an important point.)

The difference between following my bad advice and a lawyer's bad advice is that you get to pay thousands of dollars for a lawyer's bad advice and incompetent representation. My advice is free, is worth every penny of it, and comes with a money-back guarantee.

Simply put, here's the point: Get a *GOOD* lawyer, not just any lawyer. Get one experienced in what you need help with. Ask around. Have a preliminary consultation, even if you have to pay for it. Second point: Don't take my personal experience or even my opinions related to legal issues in this course as expert legal advice. What I say about contracts or other matters of law comes from personal experience and my own research. I honestly believe I'm conveying reliable information, but I relate these admittedly inexperienced opinions to prime the pump of your own interest and investigation.

## What Can We Say About the Nature of Contracts?

First, there are two parties to any construction layout contract.

Second, Two parties acting out of their free will have a legal right to agree to anything that doesn't violate the law, and to bind one another to perform or comply to the terms and conditions of their agreement.

Third, the party who drafts a contract or causes one to be created is favored in that contract to varying degrees. This happens naturally as the consequence of a lawyer's involvement (ever the advocate of the party who hired that lawyer). Yet, contracts written without professional legal help generally bear the stamp of human nature, which also exhibits a strong tendency to look out for ol' number one. So, whoever writes the first draft of an agreement is inevitably more sensitive to their own concerns than those of the other party.

Fourth, an agreement reduced to clear and unambiguous writing is generally held to represent ALL the intents of the parties as specified in the particular agreement. A claim of intent contrary to that in the clearly written agreement will seldom prevail against what has been written in the agreement. In essence, the intents of the parties expressed in a well-written agreement cannot be overcome by any verbal agreement that differs from the written agreement. I've heard people say, "Well, it says that in the contract, but I won't hold you to it."

My reply is, “Oh, I’m glad to hear that.” I say those words as I take a pen and cross out whatever the contract says that the person said I wouldn’t be held to. (It’s hard for them to object at that moment.) If a contract says I will be held to something, but the other party to the contract verbally asserts that I won’t be held to it, guess what. A court will hold me to it. Don’t ever be shy about insisting that all verbal agreements are clearly stated in writing.

## **Writing your Proposal - Specify, specify, specify**

OK, we’ve kind of jumped ahead in the sequence of getting a contract to discuss the contracts themselves and contract issues. We’ve seen why the specifics of your proposal are so important. With small clients, your proposal will likely become your entire contract. It better be well thought out. With large clients, your hope is to have your proposal referenced in and made a part of the contract. Again, it’s very important to specify clearly and thoroughly what you will do and what you’ll be paid for doing it. Even though your fees represent such a small percentage of the project’s construction costs, those fees represent your total revenue for your participation in the project, and it’s important to you. It’s your business, and proposal writing deserves care and diligence. If you fail to specify, you fail to limit your scope of services. Yet, your proposal has established set-fees for all or most of those same services. Lack of specificity may lead your client to expect more than you’ve envisioned performing for your set fees. This may lead to disputes and hard feelings, both of which are bad business.

Surely you’ve heard the saying, “Good fences make good neighbors.” A clearly written scope of services is that fence – a dividing line between what you owe your client and what your client expects of you and owes you. If your client asks you to perform beyond your scope, then your client owes you some extra compensation. If you stop short of providing what you’ve promised, then you owe your client. When the line between who owes whom becomes fuzzy, trouble and hard feelings will surely follow. The moral? Specify!

## **How many toilets –or– how many stakes?**

When specifying, remember this. The construction manager’s bidders are mostly constrained by plans and specifications to provide only certain products or equivalents, installed or constructed to known codes and standards. The plumber, for example, will install a certain number of the specified model toilets in certain locations to certain building code requirements. His work will be inspected to guarantee compliance. Plumbers will compete against other plumbers on a more or less even playing field. It’s the same for electricians, masons, etc. When preparing bids for construction layout services, you and your competitors may have vastly different levels of service in mind.

## **Why your proposal gets so specific**

The project’s design plans tell the plumber exactly what he must provide. But, the plans offer no specific guidance as to what will be physically staked to control or guide construction. The plans never show what specific features require layout or the intensity or scope of required layout.

So, how does anyone know what is needed or what terms and conditions are appropriate for construction layout in general or this project in particular?



You, as the provider of construction layout and control seldom perform to any well-defined requirements or industry standards. Your performance in the construction process is rarely defined specifically in writings other than your own. Someone must determine and reduce to writing how many stakes will be set during a maximum of how many calls to the site, etc.

Seldom has a client specified exactly what they want without my asking, not even when it comes to what level of control will be provided for the building layout. This is why the pre-bid meeting is essential. If you decide unilaterally what your client will want, you have no excuse when the client later demands something different. Remember the point stressed at the beginning of this course: The client is the expert in what they need; you are the expert in giving them that.

### **Creeping-Up Scope Syndrome (CUSS)**

On the other hand, if your proposal language is vague and leaves what you intend to provide open to your client's personal interpretation as the project unfolds, watch out for the disease called, "Creeping-Up Scope Syndrome," or CUSS for short.

Without a well-defined scope of services, someone is likely to cuss.

Your client may ask you for more and more and more layout, way beyond what you envisioned would be required. Your client may argue, "The site superintendent knows what layout is needed, and you're the person hired to provide layout, so why are you saying it's not your responsibility?"

If your proposal is vague as to limits on what you will provide, you're open to such conflicts.

If your proposal is SPECIFIC, your reply when asked to provide some layout you've not foreseen is, "You know, I certainly can provide that for you, and I'd be happy to do it. But, it's beyond the scope of my proposal, and I'll just need you to sign a work order authorizing it as work to be performed on an hourly fee basis. It should probably take me two or three hours. Is that what you'd like to do?"

I have never, never had a problem using this approach. Generally, the person ordering the work is happy to place a signature on my work order, and I've never had the client's accounts payable staff refuse to pay IF my work order bears the signature of their site superintendent or project manager.

### **Assumptions**

To keep your proposal fees or bid low and avoid future arguments over Creeping-Up Scope Syndrome, you should state in your proposal what assumptions are made in quoting your fees. They may or may not be specifically listed as assumptions, but you should keep clear in your mind what you are assuming and be certain to put in writing what you feel your client needs to understand and accept.

Some assumptions can be briefly conveyed with a few words added to a line item. For example:

Fee	Item	Description
\$3,200	Stake Curb	50' intervals except 25' intervals on curves + high/low & HC ramps

Others require a sentence or paragraph. An example is given below:

Fees within this proposal are based on plans dated [such-and-such]. Significant or general revisions necessitate time to review, recalculate and change the layout and will be billed per the *Table of Hourly Rates* attached to this proposal.

In addition, you should state an assumption that a digital drawing file will be provided for all the site drawings. Working from paper plots or reproductions of development plans alone will be time consuming. Nevertheless, you should require a paper plan set from which to stake improvements. These become valuable documents if you're accused of NOT staking according to the plans. Your digital files may change as you work with them, but the paper plans are excellent evidence of what you were directed to stake. Unless specifically directed otherwise, those paper plans are your boss. Your client must be made responsible for advising you of revisions to that plan set you've been given at the start of the project. More on this is found elsewhere in this course.

Specify that quoted fees assume that calls for layout provide a minimum notice, say two full business days, and that layout requested on an emergency basis or requested to be performed other than during normal business hours will be performed at your standard overtime rates subject to the availability of your personnel for the times requested.

Another standard assumption is that you are provided physical starting points in the field and the geometric data as discussed below.

Finally, if you are not a member of the firm that made the engineering design, or if you are not the record surveyor, your starting point for layout services is to get data and possibly points set in the field from these other professionals. I highly recommend that you state in your assumptions that your services can begin within so many days of receiving necessary plans, files and data from the record surveyor and design engineer. Make this small print, if you do include it. The record surveyor and design engineer can hit the ground running, because they already have this information. If you are not careful with this, you end up selling the wisdom of hiring those people for the layout. Face it; you will probably be scrambling at the start of a project. Very few construction managers realize how much time it takes you to get information, verify it through your own field locations and computations and compute whatever layout they want first.

## **Scope of Services – Line Items in Sequence**

To this point, I've been general about specifics. Now, it's time to get specific about specifics. So just what line items should you specify? I'll share from my own experience. Forgive the many uses of the first personal pronoun. As stated up front in this course, this material is a me-to-you presentation. Where feasible, for the sake of not offending the writing police, the use of I, me, my and mine are avoided, but in some sections, it's unavoidable. And, this is one of them.

Please understand, I don't presume to tell you what to do; instead, I'll share what has worked for me, and thus many "I's" will follow. You decide what elements of my experience are applicable to you own situation. My word processor's grammar-checker will drive me nuts over all these first-person sentences.

The reason I write in this forbidden manner is to make this course more like a seminar you attend in person, where I share my personal experiences with you, so that you can benefit from anything I've learned and apply it or not as you see fit. As in any seminar, some attendees are there simply for the needed credits; others come to learn the easy way what the instructor learned the hard way, and this second group I consider to possess great wisdom. You know who you are. For those readers truly seeking to learn from my experience, I promise to hold nothing back. I've paid dearly to learn some of the 'trade-secrets' and horse-sense in this course, knowledge other professionals may be reluctant to share – and I'll probably tell you some stuff they haven't yet discovered.

## **How many, how distant, how often and how precise?**

My rule of thumb is to specify the minimum layout that I think provides necessary control to guide the specific construction. Stating fees for the minimum necessary layout is important to winning the apples and oranges game.

My proposals specify number of stakes or stake intervals (frequency or distances between stakes), the maximum number of visits to the site allowed in the set-fees for each line item, and in some cases how precise the layout will be.

## **A closer look at a proposal's typical line items**

I normally list my proposal's line items in the same sequence as they'll be ordered by the client. This makes my proposal logical in nature and may flag for the person reviewing the bids some omissions in my competition's proposals.

## **Contract Line Item #1 – Field Reconnaissance and Preparation of the Geometric Plan**

### **Background for this line item:**

This first line item requires discussion, because how you handle it depends on whether you are or are not the record surveyor – or whether you are the surveyor working for the design firm for the project. Other variables we'll cover also impact how you package this line item and how much you actually get paid for your effort, whether you roll it into fees in the overall scope of your proposal or maybe don't get paid at all for it.

So, there are a number of IF-THEN's regarding this first item in your contract. I'll try to make this simple.

### **But first, what exactly is a Geometric Plan?**

Computing the coordinates of points to be staked and preparing a plan drawn to scale based on those coordinates has traditionally been called, "Preparation of a Geometric Plan."

In most cases, *where* the future improvements get physically staked (and built) is dimensionally governed by site development plans or separate layout plans showing the position of such improvements in relation to parcel boundaries. Normally, critical dimensions are shown on the plans of development, and the positions of all improvements constructed are related to those dimensions.

## **A little history for you youngsters.**

The term “Geometric Plan” dates back to the time when site development plans were hand-drawn. Even into the early 1990’s in many regions, during the first phase of a significant project, the boundaries of the parcel under consideration were often drawn with a protractor and scale (or similar method) from deed descriptions. No great care was exercised at this point during this preliminary, feasibility or conceptual design phase of a project to create a truly to-scale map.

Alternate development schemes were sketched on cheap tracing paper (called “onion skin”) and overlaid on the hand-drawn boundary sketch. Often this original base map, created initially for preliminary work, survived unaltered through to the final design. The plan was overlaid and traced to linen or mylar and became a final plan – yet, it was not truly to scale.

Often, no drawings were plotted from coordinate values of the boundary until the time of construction layout computations. Only then were the first to-scale drawings made to facilitate construction layout, and these drawings were called, “Geometric Plans.”

Later in the course, I’ll tell you a true story about the trouble I had on one project in the late 1980’s because the designer never made the effort to create a drawing to scale. I created a Geometric Plan in order to perform construction layout of the project. And, the building didn’t fit on the site as designed. Later for that story.

## **That was back then, but...**

One thing has not changed to this day. Because proposed improvements are dimensioned off property lines as they’re depicted on the design drawings, property corners and the property lines running between property corners serve as computational starting points for most new construction. Parcel boundary markers or monuments are the essential, primary control points in the field the dimensionally relate to the plan of development. These physical objects on the face of the earth control where everything actually gets built. The results of computations to determine this are represented visually on a “Geometric Plan.”

We may generalize then and say that the parcel boundaries or phase lines are dimensional starting points for computing all layout. The record surveyor (the surveyor who performed the boundary survey of the parcel being developed) must be responsible for marking the parcel boundaries – the physical starting points for layout – prior to commencement of construction layout activities.

## **Don’t delay the start of construction!**

Aside from the business promotion/management and liability issues involved in large-project construction layout, the hardest thing is just getting started on a project. As noted elsewhere, the worst time crunches and coordination hassles come at the start of the project – between the time you’re told you’ve been awarded the work and the time your first call for layout comes.

In the next few paragraphs, it’s necessary to address several variables depending on which person you are:

- The licensed surveyor who performed the boundary survey of the parcel being developed
- A licensed surveyor who *didn’t* perform that boundary survey

- The record surveyor who is an employee of the firm that prepared the Site Development Plan
- A layout contractor or engineer (not a licensed surveyor) performing construction layout

### **This brings us to the IF-THEN's.**

The next few paragraphs may require re-reading due to the variables (your role, present and past), and some “if/then's,” (about what boundary evidence or other starting points you recover on the site being developed). Defining these variables helps suggest how you can best navigate the choked logistical waters at the start of any construction layout project.

### **Variable 1: You are the record surveyor.**

If you are the one who surveyed the boundaries of the parcel being developed, you're in a strong position. You've already set primary control points on the site, and you know where the property lines are in relation to those control points used when performing the survey. But, what if the owner did not want property corners set at the time of the survey? They should be set prior to construction as a general rule. You may be confident that you can perform the construction layout without needing corners set, but my advice is, set them. This gives you one last reality-check of your boundary decision as it actually fits on the planet with other site features. And if by some stroke of CADD-luck your control network and your boundary have become disassociated from each other positionally, this may be discovered in setting corners.

It happens in the CADD world that data gets corrupted as control networks and property lines get moved separately in the drawing. While competent CADD operators realize this and take great care to keep the drawing “pure” in this regard, accidents do happen. You need to verify that your control and the property boundaries are still rightly related to each other before you stake for construction. If you think this can't happen to you because you are so very careful, just wait.

Setting missing property corner markers should *not* be part of the construction layout contract, *even if you are the record surveyor and the one performing the construction layout*. The reason for this is that including the monumenting of property corners will not appear in your competitors' bids or proposals. If you know the property corners need to be set, still don't include it in a construction layout bid or contract. Setting corners is not a construction layout activity.

Generally, in my experience, the construction management firm requires the owner or developer to have the primary corners of the parcel or phase lines set or marked in the field prior to construction. The best construction management firms are aware of this need. Then there are the other not-best firms. Often, you will need to prompt the team's awareness of this critical detail.

If you *are* the record surveyor and you've already set the corners in the past, you still must go to the site to verify that your previously set corners and/or control points are still present, undisturbed, and recoverable. If the corner markers do not meet these three conditions, they need to be re-set – but as noted above, generally not as part of the construction layout contract.

The best bet (if you want to get paid for setting corner monumentation) is to have the construction manager require the owner to have the corners set. The owner then calls you, and you establish a fee for that service. Generally, there's a little overlap of services between your

two clients (owner for the sets and construction manager for initial reconnaissance and control work that must precede your actual layout functions), and this overlap represents a financial opportunity for you.

**Variable 2: You're not the record surveyor, but you are a licensed surveyor.**

If you have the survey map or plat, go to the site to search for evidence of corners. If you find them, you have your starting points – with or without any help from the record surveyor.

If you can't find sufficient evidence of corners, you either have to somehow get the record surveyor to set them; or to provide you with other adequate control data; or you have to do a resurvey before you can start the construction layout. One obvious solution is you doing a survey for free, thus decreasing your income and increasing your liability exposure. Not good. What to do?

Let's hope the person who surveyed the boundary doesn't hate you. If you can obtain that surveyor's coordinates for the corners and his permanent control as well, you're off to a running start. If the surveyor's permanent control points are undisturbed and recoverable, you've got your starting points for your computations and layout work.

Suppose the record surveyor hates you. There's still hope. The record surveyor has an established relationship with the owner (or a former owner) and therefore has an incentive to set the corners at a relatively small fee, since his records research, field survey and computations are essentially completed.

Call your construction layout client and ask your client to contact the owner or developer directly. Give your layout client something in writing that states what you need set at the site. Be sure to require enough for you to feel comfortable that you've got solid starting points for your computations.

Using this approach, you've successfully dodged the liability bullet for anything whatever to do with where the parcel boundaries are located.

The construction manager makes the owner/developer understand that not knowing exactly where the property corners are will delay the start of construction. This gets the owner's immediate attention!

Construction is a blame game. When a project is undeveloped and under construction, the owner/developer is spending money with none coming in. Construction delays are not tolerated.

A fringe benefit for you in handling the need in this manner is that your client will understand the situation and blame the owner (not you) for delaying the start of construction if those property corners don't get set in a timely fashion. If the owner's surveyor is unresponsive or slow to deliver, you are not to blame. You're out of the line of fire. A fringe benefit for your construction layout client is that your client can't be blamed by the owner for delaying the start of the project. You've dodged the first blame-bullet. In the process, you've probably made a good impression on your client through foreseeing a potential problem and bringing it to your client's attention.



After corner markers have been set, you go locate them. Computed positions of the recovered corner markers are your starting points for computations; two corners suffice in theory, but three corners are much, much safer, as any surveyor appreciates.

It bears repeating in this context that if you are *not* the record surveyor (whether or not you're a licensed surveyor), state the assumption in your contract that a minimum of three property corners and two benchmarks shall be established on the site to serve as your starting points for the computations and layout performed under your contract. State that they must be set and flagged a minimum of five business days (or period of your choice) before the first layout can be performed under your contract. This clause gives you time to field-locate and verify those points supplied by some other party and to compute at least enough to get you started.

Two benchmarks, not just one, are needed to be certain the benchmarks' elevations have been correctly posted and to eliminate the possibility of mistaking some other point for the intended benchmark. Checking into the second benchmark confirms the first. Never accept only one benchmark as sufficient vertical control. If the new construction ties into existing utilities, it's a good practice to check inverts or other features just to be sure whoever provided the bench marks didn't mess up. If you catch a mistake like this BEFORE the start of construction, you'll be loved by your client.

### **Variable 3: You're the record surveyor, AND an employee of the firm that prepared the Site Development Plan for the project.**

If this applies to you, then you have a distinct advantage over your competition, because not only are you familiar with the boundary and the on-site control that already exists; you're already in possession of the site development drawing created by the firm you work for. Larger civil engineering firms often have in-house surveying. If you *are* the record surveyor and also employed by the firm providing the site design, you already possess what you need to start your geometric plan.

Namely, these are

- the random control points from the initial existing conditions survey,
- the boundary data and coordinates, and
- your firm's digital design drawings.

In almost all civil engineering firms today, the basis for construction layout is the CADD generated design product. This is usually a "pure" drawing, that is, a to-scale CADD product that incorporates both parcel or phase boundaries and the design elements that will be staked. All this necessary data undoubtedly had your control traverse as the starting point for your property survey. This is one "big firm advantage" noted earlier in this course.

In this case, computations for layout begin with object snaps to and offsets from points or objects in the digital CADD drawing. There may not be any "Field Reconnaissance and Preparation of the Geometric Plan" line item in your proposal at all. Isn't that great?

No. It isn't great because it may look to the person reviewing your bid that you left that line item out by mistake. My suggestion for winning the "Apples and Oranges Game" is that you include



the line item (Reconnaissance and Geometric Plan Preparation) and put “no charge” for the associated fee.

The record surveyor who’s also an employee of the project’s design firm has a distinct advantage over the competition, because this surveyor is the only surveyor who can hit the ground running, with little or no reconnaissance or preparatory computations and checking. Most of the work that a newcomer to the site has to perform before staking anything is in your hand already.

One word of caution: Never forget that the digital product is subject to corruption by those who use or modify it. Too often, the non-surveying employees of large, multi-discipline firms, when working from the surveyors base map, unknowingly disturb the relationship of the CADD image (objects) to the coordinated points developed by the surveyor. A significant movement of the CADD objects (such as a rotation of the graphic elements representing the project, made to “square” the CADD view of the site to the computer screen) will usually announce itself as you begin work with the digital drawing. However, beware of those *small* changes that are not readily apparent on the computer screen. Corruptions of the digital product are commonplace. It’s a reckless act to assume the digital product is dimensionally pure.

**Variable 4: You are not a licensed surveyor; you’re an engineer who didn’t prepare the design drawings –or- you’re an unlicensed layout contractor.**

Assuming you’re competent at necessary computations and field staking procedures, and that you have equipment needed to service the construction layout need, your situation is almost the same as that of Variable 2 – an obvious exception being that you can’t legally perform a boundary survey yourself. Aside from this limitation, your approach is similar to Variable 2.

**Summary Regarding the Geometric Plan Preparation**

(We’re still talking about Contract Line Item #1.) Whether or not you’re the record surveyor, and no matter whose digital product you receive, be it from the multi-discipline firm that employs you or an outside source, some time is needed to verify the graphic integrity of the digital data, to field check agreement between physical boundary evidence and control points with the coordinates of the CADD imagery provided, and to make any adjustments needed. You must also determine what points will be held as primary control for the duration of the project and set additional control points in the field at strategic locations. After this, points with N,E & Z coordinates must be assigned to items to be staked, and a certain amount of checking, set-up and uploading of coordinate files to a data collector is always required.

Therefore, my recommendation is that proposals include some fee for “Field Reconnaissance and Preparation of the Geometric Plan.” In all cases and variables discussed above, some cost is associated with this function. At the least, verification of control points set earlier is needed.

A final reminder: If you’re competing with the design engineering firm for the construction layout contract, realize that you have a distinct disadvantage with this first line item. You’re going to spend much more time getting ready for your initial staking.

You may need to spread the costs of work that categorically belong in this line item to other services, to layout items that you stake more efficiently than your primary competitor. If your

firm is a small, responsive, well-oiled machine that knows its stuff, don't be afraid to go head-to-head in competition with any firm for construction layout contracts.

Even though the design engineering firm with in-house surveying seems the likely first choice of the construction manager, and seemingly *should* be for lots of reasons, larger firms are often slow to respond, assign inexperienced crews to providing construction layout and are often disconnected from the heart of the construction need through layers of management. Many of these firms would actually prefer not to do the construction layout. This is the little firm's frequent advantage. There are exceptions, but in general, this is what I've observed.

## Item #2 – Stake for Clearing

Now, that the variables of that first layout challenge have been covered, I'll get back to telling you how I approach proposal writing and why.

Usually, the first call from the construction layout client after being awarded a contract is to stake clearing limits.

I want to make an important distinction. There is a difference between writing in your proposal, "Stake Clearing Limits" and "Stake for Clearing." The first might be interpreted to imply more of a role than I wish to assume. My intent is to "stake for clearing," not to assume a role that says, "Thus far and no farther shall ye go." Do you see the difference? Keep reading.

The preservation of trees and wetlands is of ever increasing importance. If the site development plans do not show individual trees, my line item for marking clearing limits reads something like, "Stake for Clearing – as scaled from plans."

This provides some leeway, since scaling is an approximate method. Clearing limits are often not shown with definite dimensions on the plan. Even if I "pick" the coordinates for this layout activity from the CADD file, I'm essentially scaling them, since no dimensional cross-verification is available. If that line has slipped or moved as the result of a CADD mistake, and the plans don't look markedly different (always check this), then I have no ability to verify that the clearing limit is in the right place. Essentially, I am scaling the limits.

If the clearing limits of the design are drawn along the base or top of slopes, without an apparent attempt to save certain trees, then it will be hard for anyone to fault me for the destruction of some significant trees along that line, provided I accurately reproduce the plan's clearing limits on the ground. It is not up to me to determine what vegetation is or is not preserved. My role is to accurately reproduce within reasonable limits the clearing limits drawn on the plan.

However, if a tree survey has been performed or the topo base mapping for the project identifies individual trees, and certain trees are shown in the plans as ones to be preserved, then I assume the responsibility for locating and clearly flagging those individual trees. This can take more time, so I state in my proposal that the tree trunks of trees designated on the plans to be saved will be marked. This implies I don't have to flag the drip line or perform additional measures to protect those trees. That responsibility will hopefully fall to the excavator.

It is beyond the limits of my expertise to protect those trees. My role is to identify them visually. For this function, Item #2 of my proposal will state:

Item #2 – Stake for Clearing and Mark Trees to be Preserved

### Item #3 – Topsoil Storage Areas – Quantities Analysis

These services are often not required, do not take very long, vary in required effort to perform and are better off not assigned a fee unless specifically required of all bidders by my client.

If for some reason I elect to note one or both services as line items, the fee is noted as, “To be performed per Table of Hourly Rates.”

If a client insists on a firm number for staking topsoil storage areas, I’ll normally include a line item that reads like this:

Item #3 – Stake 3 Topsoil Storage Areas – 4 stakes at perimeter plus 1 at center                      \$ n/a

    If performed while on-site for other layout services ----- \$###.## --or--

    If separate visit to site required to complete ----- \$###.##

Perhaps this is a good time to note that what I fear most in competitive bid situations is a non-thinking, non-analyzing assistant project manager or clerical person sifting through the bids for the lowest-priced construction layout provider. I want that person to slow down and think! My proposal is constructed to stand out because of its appearance and its merit and not be easily reduced to a bottom line. I also don’t want the alternative fees shown above to be mistaken as *two* fees to be slammed into an adding machine. That’s the reason for the generous indent for the alternative fees and the \$ n/a at the right margin. Be careful with the appearance (really, the graphic design) of your proposals.

Want to win the Apples and Oranges game? Don’t make life easy for the mindless, fatigued, or lazy person in the construction manager’s office who’s been told to look through the stack of bids and pick the lowest one for each bid category. Your proposal should appear simple at first glance but defy the wits some gnome at the adding machine. You want your proposal to get before the eyes of a person who understands what sets you apart from the competition. And, if such a person perseveres and just plows through with an adding machine anyway, make your proposal’s right-hand column contain only dollar amounts for absolutely essential layout that you’re certain all competitors will include in their proposals.

### Item #4 – Stake for Blasting

I state that staking for blasting will be billed per *Table of Hourly Rates* if requested.

### Item #5 – Rough Grade

Rough grading of a site normally takes place after the site has been cleared and grubbed, stumps removed and topsoil stockpiled on-site or trucked off-site. I discuss this function in the pre-bid meeting with the client to determine if all bidders are required to include a fee for this in their proposals. If not, it’s another “*Table of Hourly Rates* if requested” item.

If it is required, I mention in the pre-bid meeting that there are widely varying ways to stake rough grade. I say that rough grade stakes could be set on a grid once the site is cleared, or it can

be a features-based layout where drives, tops and bottoms of significant slopes, building pad and detention basins are staked separately from open areas of the site that get staked on a grid system. I tell my client in this meeting that I don't want to specify a 'full-service' scheme when my competitors figure on a grid system throughout the site, and then some clerical person in the client's office just adds up numbers without seeing the differences in scope of services between the construction layout competitors.

I ask if this person will personally review the construction layout bids to analyze these important differences. This is very important information to know, as you can appreciate. And, if the answer is yes, I've elicited a commitment I can remind this person of later - IF I don't get the award.

If this person indicates what I fear most, that some clerical person goes through the bids and posts a bottom line number to a spreadsheet for the manager, then I state that I will assume a 50' grid system approach throughout the project to not fall prey to my competitors' tactics.

In this case, my line item simply looks like this:

Item #5 – Rough Grade – provide 50' grid. Stakes reference proposed grade ----- \$###.##

If my client is one I've worked with before and have a good working relationship with, that relationship is golden. If I am certain my proposal will be analyzed by discerning eyes, then I may get specific. In this circumstance, my proposal will stand out because it shows my knowledge of what's best for my client that many or most competitor's lack.

Below is the background for how my line item appears in a proposal for such a client.

### **Open Site Areas and Large Parking Lots**

The open areas of a large site as well as large parking lots, bottoms of large detention basins or athletic fields may often be graded by the setting of stakes on a rectangular grid at 50-foot (or greater) intervals. Grid spacing is discussed with my client, agreed upon at the pre-bid meeting, and specified in the proposal.

### **Retention Areas**

Areas for the on-site storage of storm water seldom lend themselves to staking per a grid-scheme because of their rounded shape, steep side slopes and flat bottoms. Normally, I specify X-number of stakes around the top of slope and X-number at the toe of slope at the basin.

### **Building Slab**

If a building is to be constructed slab-on-grade, the slab itself will often need to be staked so that the area can be cut or filled and compacted to precise grades in preparation for construction. This is also something to discuss in the pre-bid meeting with the client and ask what will be required of all bidders. I need to know if a few stakes will do the trick or if I'll have to spend any significant time in addition to the site's rough grade staking for the building itself.

If I'm told a few stakes at the building location will suffice, I state the number of stakes I'll provide in the line item related to the building's rough grade.

If instead I learn that any significant effort will be required, I make this a separate line item, to distinguish the matter from other bidders' proposals.

When I include a separate line item for staking building rough grade, I note in my assumptions that the fee assumes building rough grade will be staked at the same time as site rough grade, and that an additional fee of \$\_\_\_\_ will apply if building rough grade is requested separately from site rough grade staking. If the site is very close to my office, I may omit this qualification. This can be placed in the 'Assumptions' list if it makes the appearance of the proposal too congested.

### Number of calls to complete

This may be a good time to mention that I normally limit the number of trips to a site for any line item. This could be noted in the wording of the line item, for example: "Stake water line for construction, assuming completion of initial layout in no more than three calls to the site." However, this usually goes in a separate 'Assumptions' listing so as not to draw undue attention to conditions that may generate additional fees.

With a client who appreciates the thought I put into each individual project and appreciates me for doing so, my line item looks like this:

Item #5 – Stake Rough Grade – assumes FULL-SERVICE layout as discussed

In meeting with so-and-so on [date] ----- \$###.##

### Item #6 – Building(s)

#### Primary Building Control

##### Control Rectangle

Often single-family residences and simple commercial buildings having just a few variations from an essentially rectangular footprint require just a "control rectangle" to be staked, normally with just four stakes set. My fee is based on guidance received in the pre-bid meeting, and is so stated in the line item.

Figure 2 shows single offsets from a "box" drawn to dimensions of major, exterior walls, an approach common for single family homes and simple commercial structures.

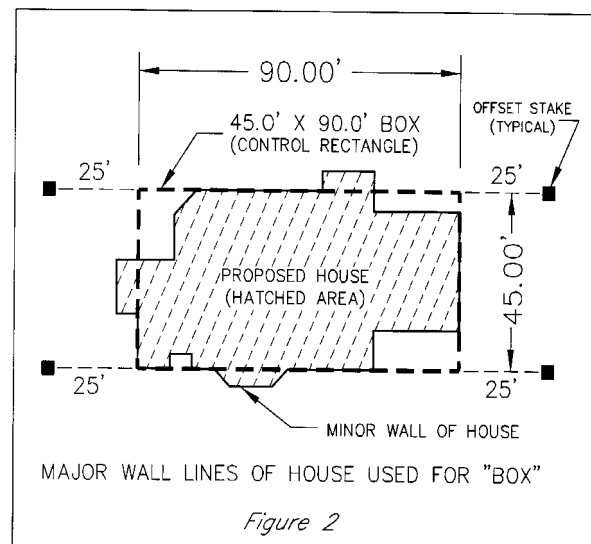

Figure 2

Double offsets for this house require four more stakes, offset the other way from the corners of the 45' x 90' "box".

The actual staking of the control rectangle and labeling of stakes is discussed in more detail further on in this course in the section on actually staking for column layout. The same principles apply in most respects.

### **Column Offsets**

Some custom residences of significant size and complexity as well as larger commercial buildings normally require more involved layout.

Keep in mind that many of your competitors will assume what is needed without discussing it with their client. You gain an edge through knowing what is expected and specifying exactly what's been discussed. If after such discussions, the client decides on another approach to the layout, it's much less likely the client will try to hold you to the proposal's fee. After all, the client had a hand in misguiding you. It should come as no surprise to the client if you amend your fee to accommodate your client's change of mind.

Staking column offsets and labeling of these stakes is discussed in more detail further on in this course.

### **Anchor Bolt Checks**

Since anchor bolt checking is sometimes required and sometimes not, and sometimes difficult to perform and sometimes easy, and sometimes a report is required and sometimes not, I do not include this in my proposals. Somewhere in my proposal, I may note that anchor bolt checks or wall checks, if required, will be billed at standard hourly rates. It's best not to lock-in a fee for this work.

### **Elevator Layout**

A similar note may be included stating that computations and staking related to elevators, lifts or other building features not specifically listed in the scope of services will be billed at hourly rates if required.

Keep in mind that to stake these, you need current architectural and/or structural plans. Then, you may need to verify numerous dimensions, compute locations in relation to column lines or other controlling dimensions not related to previously computed points within the building. Once computed, you may need to restake your control points that have been destroyed by other building construction or to locate existing columns, walls or holes in upper floors and lay out the elevator from computations made from this as-built data. It's best to always charge hourly fees for this work. When a client orders "just a stake in the middle of the elevator shaft," beware of the word, "just." It could take a long time to stake interior building elements once your original control has been destroyed.

### **Special Needs and Layout Requests**

Once I was asked to find the center of a rectangular room being constructed within a cancer treatment center. The room was made with concrete walls about three feet thick and had only one door. It was presumably to be used for some radiation device. The mission was to mark the



centers of each of the four walls and stake the intersecting point in the floor. Lines marked on the four walls had to intersect at a 90-degree angle.

This may seem easy at first glance, but give it some thought. It wasn't as simple as you might initially think, since the room was not perfectly constructed, and some variation in the lengths of the walls and the angles at the room's four corners was present.

The assignment was not envisioned at the time a proposal was drafted.

Once I had to stake a point on the floor of the world headquarters of a major time-oriented corporation where the sun, shining at noon through a fabricated hole in the roof at the vernal equinox would hit a certain point on the floor, some thirty feet below the hole in the ceiling. Our firm also had to provide an astronomic north reference on the ground for a large Stonehenge type of sculpture to be constructed on the grounds at the site.

You never know what clients and developers can come up with for requests. Be sure they pay you for your part in helping them realize their dreams with a qualification in your proposals that any building layout that differs from that within your proposal will be billed at standard hourly rates.

### **Upper Floor Projections**

Not infrequently, I've been asked to project column lines to upper floors or to provide other control to upper floors of a building. Often this is requested after the original building stakes have been destroyed. This can represent a considerable effort and should not be performed on other than an hourly basis. For this reason, this function is also included in my Assumptions listing as work to be performed per *Table of Hourly Rates* if requested.

### **Auxiliary Structures & Features**

Unless advised to the contrary in the pre-bid meeting, normally the following items are included in the listing of items that will be staked on an hourly basis, only if required.

#### **Containment Structures**

#### **Pump Stations or Pump Islands**

#### **Detached Garages and Carports**

#### **Pools, Bath Houses, Cabanas**

#### **Athletic or Recreation Areas**

#### **Walks and Trails**

#### **Gauge Stations**

#### **Switching Stations**

#### **Dumpster Pads & Trash Enclosures**



## **Transformer Pads**

### **Site Lighting**

Staking for these last three items should only be included in a proposal as line items if specifically requested by the client. I generally leave them off for this reason: Contractors will often locate these themselves from some other staking or construction already in place. If I specify a fee in a line item, I risk that someone reviewing bids in the client's office will include it in what they perceive as my proposal's "bottom line." If my competitors have been silent on the matter, this hurts me in the Apples and Oranges game.

### **Utilities**

Usually the construction of site utilities and the buildings will be happening at the same time. As a rule, the deepest utilities will be constructed ahead of the others.

### **Sanitary**

Because the gravity sanitary sewer system is normally the deepest, it is often constructed first. The horizontal position of sanitary structures is often not super-critical except where the manhole cover must fit in a sidewalk, close to a curb, or there is some other constraint. You may wish to ask your client (usually the site superintendent) or the utility contractor how close the structures need to be staked for horizontal alignment.

Remember, you can't err in being too accurate and precise, but you can in being too sloppy. But, a question worth asking may be, do you need to provide a tack in an offset hub for a sanitary manhole in the middle of a parking lot or one on a line running through the woods? If not, why spend twice as much time achieving precision that is not needed? The average survey crew is worth about \$2 per minute. If your crew saves a half hour by not wasting precision on things that don't matter, you are \$60 richer for their lack of wasted effort.

You need to make your own informed, and hopefully correct, decisions regarding precision and accuracy in staking for construction. I simply want to say that significant money is wasted in needless precision. And, conversely, work performed to less than the needed precision is bad business. Learn to know the difference and count the minutes. Each minute you save is worth about \$2.00. These add up, and they add up quickly.

A word of caution. Sanitary sewer pipes can have very, very flat slopes, often in the order of 4/10 foot (or about 5 inches of fall) in 100 feet. The vertical component in your staking of sanitary sewers is often very, very critical. Don't get sloppy with this!

### **Storm**

Installing storm sewers usually follows construction of sanitary sewers. Again, know what precision is needed. In general, basins along the curbing are more critical for horizontal layout than are manholes. However, don't assume. Make judgments based on experience gained over time and be humble enough to ask contractors and superintendents how precise various kinds of layout need to be. In the end, it will make you far more profitable and competitive than those who never take the trouble to learn what degree of care to put into the various elements. There's

a lot of money to be made in the accumulated minutes not spent in the pursuit of needless precision.

Some regions use elongated concrete troughs precast as part of long rectangular concrete tops for catch basins along curb sections. These troughs vary in length depending on the amount of water the designers expect the basin to collect. For this layout, stakes along the curb line are necessary in order for the contractor to align the base of the structure and its top with the future curb line itself. Both the horizontal and vertical components are quite critical for such layout, as well as the position of the stakes so that excavating equipment can work without destroying the stakes. Be sure to ask what layout is required and where it should be placed for these and any custom structures you're asked to stake. No one ever minded my asking, and most showed appreciation. And, I learned a lot.

### **Water**

Again, ask to learn what is critical. The exact horizontal or vertical position of a water line may not be very critical (but, don't take my word for it), yet some jurisdictions specify a very precise setback of hydrants behind the face-of-curb line. Also, the height of the hydrant base above the curb may be critical. Know what is needed in your area and deliver it.

### **Electric, Telephone and Cable**

Often, underground electric, telephone and cable lines are installed without staking. Normally, I don't include these as line items in my proposals, but place them under Assumptions, in a listing of items I'll stake on an hourly basis if requested.

I recommend discussing this in the pre-bid meeting.

## **Item #7 – Foundation As-built Survey and Site As-built Survey**

My recommendation for non-licensed (as a surveyor) layout providers is that you go silent on these services in your proposal. Often, the owner is responsible for this anyway and not the construction manager or general contractor.

It is good, however to have a relationship with a licensed surveyor who will provide this service for your client, and for you to know ahead of time what the fee for this service will be.

**CAUTION!** Just be very, very careful not to represent yourself as a provider of services defined in your state as "surveying." If you want to sub-contract licensed surveyors to perform this work under your proposal, get the advice of an attorney familiar with professional licensing in your state who can determine whether or not you can legally do this and, if so, how to go about it. Also, check the fine-print on your contract with your client. It may not permit you to subcontract services offered within your proposal.

## Time Elements-Be Unambiguous and Nonspecific (Be What?)

### Notice Required

I find it beneficial to include in contract language clear yet non-specific clauses regarding time commitments. What? Non-specific contract language? Bear with me – and of course, check with your lawyer. But, when you do see your lawyer, ask him or her to read this section before laughing me to scorn.

One item I always include covers how much notice the client must give me when calling to request layout services. The Agreement says that notice of LESS THAN this amount of time MAY be deemed, “Emergency Service,” billed at higher than normal hourly rates. See more on this under, *Include a Table of Hourly Rates*, elsewhere in this course material.

A specific phrase like, “Two full working day’s notice is required when calling to order layout services...” may cause concern on your client’s part, since experience dictates that it is not always possible to foresee some needs two or three days in advance. Generally, a seasoned superintendent can schedule within this time frame, but the construction setting is fluid, ever changing and sometimes unpredictable. A rigid notice requirement may be interpreted to say, “I am unsympathetic to what your life is really like, and I ALWAYS require a minimum notice – no matter what.”

Consider instead something gentler like, “Normally a minimum of two full working days notice shall be given when requesting layout, however a genuine effort will be made to accommodate situations where standard notice cannot be given.”

This softens the tone of the matter without, in my opinion, opening the door to consistent late afternoon calls for layout the following morning.

Why include something so vague in a contract? Aren’t contracts supposed to be specific? The reason I suggest this is, it has worked for me. Such a clause allows me to loosely quote my contract to a superintendent who is consistently ordering work at the last minute.

The real-world complication here is that some superintendents (the ones generally making the calls for layout) are good managers who can look ahead a few days, while others simply are not. One superintendent will consistently give me notice of several days, while another is always calling at the last minute, in frantic need of layout.

I consider that part of my occupation is training those ordering my services to appreciate that I can’t always respond to last minute calls for layout, but that I always try to meet their requests. Sometimes I’ve said, “Gosh Joe, I was able to make it Tuesday in response to your call Monday afternoon, but you know, my contract calls for two full working days notice, and I can’t always put off another client who called two or more days ahead. Tuesday we were lucky, but try to give me more notice next time, so I can better meet your needs.”

I’ll even suggest they call to give me a heads up like, “Hey Jonathan, it looks like I’ll need the parking lot laid out next week; I’ll give you a call when I know better what day I think the prep-work will be ready.”

If I can get them to do this, I've not only made my own scheduling less hectic, but I've helped them to be better managers. If they do this with me, and many have gotten into the habit making such calls, they will probably do it with other sub-contractors. I've made my life easier and helped them to better manage their own work.

Words like "normally" and "generally" and "a genuine effort will be made" or "in most cases" are normally something to avoid in contracts, but in this case putting forth an expectation of what is normal has worked for me better than either locking in on a notice requirement (thereby placing performance requirements on me) or leaving it out (resulting in the client thinking I don't need sufficient notice).

## **Report Preparation and Checking**

You may want to consider stating a minimum period for preparation of Grade Sheets after the field layout is completed and/or for checking your layout back in the office.

If you are marking stakes with grades or other data in the field, you normally need time back at the office either to publish your data or to check what has been marked in the field **BEFORE** construction actually commences.

When you mark grades in the field, chances are your work will be used by the time you drive off the site. But, you don't want to be liable for errors you've made until you have checked your work, made any necessary corrections and notified your client of those changes.

Your contract can be a critical defense against an unjust back-charge in the case where your field-marked data (usually marks on stakes) is used for construction before you've had a reasonable chance to check your work.

Your contract might state something to the effect that a minimum of one full working day following the day you complete stake out of construction will be required to check and verify your field work and publish grade sheets, reports or other written authorization to construct, and that work based on your services that is commenced prior to your written authorization to use such data is done so at the contractor's own discretion and risk. The idea here being that a contractor should not work off cuts and fills you've marked on stakes before you've had time to check your work while back at your office.

## **Billing and Payment – Time to get specific!**

I recommend as noted elsewhere in this material, that if cash flow is important to you, you inquire of your client whether or not their operation has a certain time of month when accounts payable cuts checks. If so, I time my monthly billing to arrive a few days ahead of their paying of invoices, in enough time for the project manager to approve my billing and pass it to their accounts payable department.

This strategy can save me almost a month in some cases. Here's how it works. Suppose my client pays approved invoices once per month on the 25<sup>th</sup> of each month. I may learn that no matter when I bill, if my invoice arrives in the client's office by the 15<sup>th</sup> of any month (and my documentation is complete and charges authorized), I can get paid on the 25<sup>th</sup> and have my

money in hand before the end of the month. But, if checks are cut on the 20<sup>th</sup>, my invoice arrives too late to be approved and paid in my client's current monthly cycle.

In the above example, knowing my client's cycle, say I bill on the 13<sup>th</sup> of the month so that my bill is in the project manager's hands by the 15<sup>th</sup>. Accounts Payable cuts my check on the 25<sup>th</sup>, and I get paid by the end of the month. But, if I routinely bill on the 20<sup>th</sup> of the month, the project manager doesn't have time to approve my billing and get it to accounts payable in time for the 25<sup>th</sup>. I'll get paid the following month on the 25<sup>th</sup>. In this example, by billing this client one week earlier, I've cut my wait-time to get paid by this client from about six weeks to about two or three weeks.

No matter what convolutions may exist in the chain of payment, I simply state in my contracts that payment is due within 30 days of billing. No client has ever discussed this with me and asked me to change my contract. Some clients substitute their contract for my contract, and in it, they have a different payment arrangement, even the horror-of-horrors: I get paid when *they* get paid! I've accepted this arrangement, but not often. It generally means I'll be paid in 60 to 120 days. That's a long wait for a small business to receive payment.

## **Collections – Go after payment.**

Bottom line: The clients pay when they get ready to pay, or when I pester them into paying. Another bottom line: A personal contact is more likely to get you paid than ANYTHING written. In this context, a phone call is considered a personal contact.

But, before taking a confrontational stance, don't lose sight of the benefit of learning your client's internal cycles. When your contract states you'll be paid within 30 days of billing, that a late fee or interest will be applied or that work may be stopped if payment is not received according to the terms of your contract, then you have cause to call your client's accounting/accounts payable staff when you aren't paid in 30 days and try to work out something with them.

If approached in a business-like way, without ill temper or pushiness, I've found I can cut weeks off the time between billing and payment by simply timing the arrival of my billing at the client's office to fit their monthly payment schedule as noted above.

This may not solve every problem, especially when the delay is because a project manager lets billing sit on his or her desk and get buried under "urgent" matters. Some project managers process billing approvals quickly while others, even managers in the same firm, let this function take a back seat.

What spells the difference to a project manager between an urgent matter and one less important (like my billing)? Often just a phone call. More than once I've called a project manager to say that I've been talking with their accounts payable regarding overdue payment, and they indicate the approval for my billing has not come back to them.

Almost always, some lame excuse is offered. In this case, I say that I understand, but that it's as important to my business to be paid promptly as it is to their business to have me provide layout

in a timely manner. Before the person has a chance to speak, I ask, “Will it be possible for you to pass this to your accounts payable staff today?”

I’ve always received a commitment before I get off the phone. “Sure, Jonathan – if not today, then tomorrow.” I thank them for understanding how important this is to me and let them know I’ll follow up with accounts payable to be sure they’ve received the approval.

On just one occasion, I had to threaten not to service a client until I was paid up to my last billing. I communicated it nicely, with regret at having to consider that action. I expressed my wishes that this one hindrance to a good working relationship could be rectified. I stated that I had done all I could, since I really had no control over their payment function and could do nothing myself to solve the problem short of not servicing the client until I was paid. I reminded them that we had a work-for-pay relationship that was falling down on the “pay” end, and that left me with no further options. In that case, the client changed its ways and devised a way to pay me what was past due and then to keep current (with occasional maintenance from me) in the future.

Does it seem I’ve strayed from the topic of “contracts?” It’s important to include payment terms in the contract and take stock of the leverage gained in doing so. Many talented people fail in business because they lack business skills, and particularly, they lack the courage to first state they must be paid (in a contract), to pursue payment (through billing AND through personal contacts made in the right spirit and with pleasant firmness), and to eventually demand, based simply on reason and business needs, that payment be made.

By including payment terms in your proposals, you have every right to pursue payment for your services according to those terms. If you mention in passing that your contract terms are not being met, you have subtly (and do be subtle) noted that your client is in the wrong, and that you are simply trying to cooperate in finding a solution.

## Billing Disputes

You may want to include in your contract a statement to the effect that any billing disputes must be presented in writing within 60 days (or other reasonable time) of the date of your billing in order to be considered valid. Consult with your attorney, of course, but make some provision to hopefully avoid a trumped-up complaint arising as a means to avoid paying you for work performed.

## Fee Structure

In the construction world, your client classifies your services as either CONTRACT (set-fee) items, HOURLY charges for certain anticipated services, or rude, unbudgeted surprises called EXTRAS. Always keep in mind, whether drafting your proposal or performing work for your clients, these three terms:

- **Contract** Amounts (services performed for a set-fee, regardless of hours required)
- **Hourly** Fees (work authorized in your contract, to be billed per your hourly rates)

- **Extra fees** (unanticipated work beyond the scope of your contract)

## Contract Amounts

In your proposal, many layout services on a typical project are predictable in scope, and you commit to perform complete, one-time layout of those items for a set fee. Your monthly billing for “contract services” is based on percent of completion to date (at the time of billing) for each set-fee line item. Your computation for current billing for layout of any set-fee item is based on the percent completed to date minus prior amounts billed for the particular line item.

For example, if your contract’s set-fee for layout of storm sewer is \$3,000 and you’re half done with that layout at the time of billing, your current fee shown on your monthly statement or invoice for that line item is computed at \$1,500(50% of \$3,000) minus the sum of all previous billing for that particular layout. If the month prior to this current billing, you first billed for this layout at 20% complete, you’ve already billed for \$600, or 20% of \$3,000. If as of your current billing, you’ve completed 50% of the layout, your current billing is \$900. Simple, yes? But, keep in mind that for layout of 10 or 15 items over a period of six to twelve months, you need to track the sums of prior billings for each line item and the current percent of completion.

Unless you own a sophisticated software package for this, I suggest a spreadsheet be constructed for each project (each contract) to track your percent-complete billing for contract items. This automation will greatly reduce your billing time and effort IF you’re careful to check your spreadsheet’s formulas to avoid errors. A portion of a sample spreadsheet might look like the table shown below as *Figure 3*.



PROJECT: VILLAGE SQUARE SHOPPING MALL						
	TOTAL FEE	PER CENT COMPLETE (TO DATE)	PER CENT COMPLETE (MONTH)	MONTHLY BILLING	BILLED TO DATE	REMAINING
<b>STORM SEWER</b>	<b>\$ 3,000.00</b>					
MARCH		0%	0%	\$ -	\$ -	\$ 3,000.00
APRIL		15%	15%	\$ 450.00	\$ 450.00	\$ 2,550.00
MAY		15%	0%	\$ -	\$ 450.00	\$ 2,550.00
JUNE		30%	15%	\$ 450.00	\$ 900.00	\$ 2,100.00
JULY		50%	20%	\$ 600.00	\$ 1,500.00	\$ 1,500.00
AUG		50%	0%	\$ -	\$ 1,500.00	\$ 1,500.00
SEPT		75%	25%	\$ 750.00	\$ 2,250.00	\$ 750.00
OCT		85%	10%	\$ 300.00	\$ 2,550.00	\$ 450.00
NOV		100%	15%	\$ 450.00	\$ 3,000.00	\$ -
DEC		100%	----	----	----	\$ -
<b>SANITARY</b>	<b>\$ 1,750.00</b>					
MARCH		0%	0%	\$ -	\$ -	\$ 1,750.00
APRIL		15%	15%	\$ 262.50	\$ 262.50	\$ 1,487.50
MAY		50%	35%	\$ 612.50	\$ 875.00	\$ 875.00
JUNE		100%	50%	\$ 875.00	\$ 1,750.00	\$ -
JULY		100%	----	----	----	\$ -
AUG		100%	----	----	----	\$ -
SEPT		100%	----	----	----	\$ -
OCT		100%	----	----	----	\$ -
NOV		100%	----	----	----	\$ -
DEC		100%	----	----	----	\$ -

Figure 3

You might then copy this spreadsheet and include it with your billing to make the job of the person who must approve your invoice easier. This may get you paid sooner.

Your spreadsheet must cover the anticipated life of the project. The numbers generated will be calculated through formulas in the spreadsheet, and herein lies both the convenience and the danger in using such a method. The ease in obtaining automated calculations sometimes results in automated errors.

All the cells of the spreadsheet containing formulas should be locked to avoid unintentional overwrites or modifications of formulas. In the spreadsheet of *Figure 3*, only the total fee column and the percent complete to date columns should NOT be locked.

Finally, always look over automated (formula-generated) data to be sure it looks reasonable. An error in a formula within a spreadsheet can cost you and/or embarrass you. A client may wonder, if this firm can't get their billing correct, I wonder if their stakeout data is correct.

Thoroughly test the spreadsheets you create and then save a prototype to be opened and saved as some new name for each project you serve.

## Hourly Fees – for impossible to predetermine scope of services

Occasionally, it's impossible to set a definite fee for certain layout activities or items. The amount of layout required or effort to stake these items is simply unknown and unpredictable.

Fees for such work should be noted in your proposal as, "Items to be staked per *Table of Hourly Rates*."

Your client may not like this, any more than you'd like receiving an estimate for reroofing your home that said, "To be billed at our hourly rates." Why would this disturb you? Probably because the roofer is left on his honor to be efficient and diligent in his obligations and to not charge for more hours than actually worked.

In the same way, hourly fees without limit create more problems for your client than contract (fixed fee) amounts. To accurately predict project costs, your client has to put in some fudge-factor for your hourly fees. If you don't know what you will charge, how is your client to know? For this reason, avoid hourly fees on your proposal's standard line items wherever you can, balancing this concern with your apples and oranges game strategy. Define the scope of services as well as you possibly can at your pre-bid meeting, and items with hourly rate fees will naturally be fewer.

You may ask, "What about hourly rates combined with a "not to exceed" ceiling?"

In my opinion, this is attempting to solve a problem with another problem. First, your "not to exceed" number has to be high enough to cover any eventuality. And, this high number may be punched into an adding machine by the person comparing bids. The result is that your bid will be artificially high, and you won't get the contract.

Second, it is no secret that "not to exceed" quotations are usually billed to the maximum amount by many if not most firms. One partner of a fairly large consulting engineering company once said to me, "Oh, don't worry, we'll find a way to bill up to the 'not to exceed' figure." Unfortunately, this practice is common, and it's no secret from your savvy construction management clients. To my remembrance, I've never used not-to-exceed figures on a construction layout contract. Some things are truly impossible to predict and must be billed on an hourly basis.

If you must quote a set fee for work that simply can't be predicted ahead of time, my suggestion is that you provide some minimal scope, well defined and clearly limited, with a fixed fee associated with and limited to that specific scope. Then qualify your quotation with something like, "Work requested in addition to this scope will be billed per our *Table of Hourly Rates*."

This approach could mean the difference between you being awarded the contract or not, and you've not risked that your client will ask for the moon at your low fee, provided your scope of services has well defined limits. At the same time, you've allowed your client to put some number into his cost for the activity, and you've set the stage for negotiation of an additional set fee or compensation at hourly rates when and if additional layout is requested.

As noted elsewhere, items like anchor-bolt checks and similar services that may or may not be requested must necessarily be billed on an hourly basis.

## Hourly Fees – Restake

Sometimes your stakes will be destroyed during construction before they've served their purpose. Your contract should state the obvious: Calls for restaking will be performed per our *Table of Hourly Rates*. Nothing more need really be said in your contract, in my experience. All contractors know this hazard exists.

## Hourly Fees – Extras

“Extra” is a word to avoid in construction, just like the word “crash” in the airport control tower. An Extra is a cost not expected at the onset of a project, and the construction manager has to find a way to recover the cost from the owner.

This is why you don't want to play the game: “leave it out of the proposal (to keep the bid low) and add it as an extra when I'm asked to lay it out later.” Some folks bid this way, and it's unethical. Be assured, your client will not like you if you play that game.

And, this is why it's so important to meet with your potential client in the pre-bid meeting and discuss the specific project you are bidding on. This pre-bid meeting is discussed fully elsewhere in this course material.

Don't mention the word, “Extra” in your contract. Simply note in your proposal that items requested that are not a part of the proposal will be billed per your *Table of Hourly Rates*. This phrasing should cover extras.

## Hourly Fees – Down-time due to delays or site not ready

You may wish to include language to the effect that if you are called to a site that is not ready for the requested layout, an hourly fee will be charged for waiting time and that a minimum charge of two hours in addition to any waiting time will be made in the event the layout cannot be accomplished due to these causes. This decision is yours, first as to whether to include such language and second, whether or not to enforce it.

My usual choice is to include the language in my proposal. Then, when called to the site that isn't ready for staking, I notify my client that I'm waiving this fee for the first occurrence, but that I can't absorb such losses on a continuing basis.

Temper your strict enforcement of this provision with this thought: while you may resent standing around losing money for an hour or two, don't lose sight of the big picture. You may need mercy from this client in the future. Cut them a little slack, and when appropriate, let them know you are not enforcing the terms of your proposal. The Bible says, whatsoever you sow, that shall ye also reap. Sow mercy.

Don't expect to hit your client for a couple of hours of hanging around the site and then not show until a couple of days after the date you've promised you'd lay out something for that client.

Often the construction layout function causes more delays than it absorbs. Don't alienate your client needlessly, but occasionally you find a superintendent so inept that you are repeatedly called to a site that isn't ready for you. A clause in your contract may remedy this situation and help the superintendent to plan ahead better.

## Hourly Fees – Emergency (Short Notice) Fees – Overtime/Weekend/Holiday Fees

You may wish to state a percentage in addition to standard hourly rates that applies for Emergency Work, defined somewhere in your fine print as “work ordered giving less than standard notice or requested to be performed outside of normal working hours.”

How do you handle emergency calls or weekend calls for layout for which you’ve committed to “contract” amounts, or set hourly rates? Have your contract specify hourly fees ABOVE normal hourly rates and/or contract fees that will be billed in addition to normal fees for emergency work.

An example: Suppose your “emergency” fee is based on 150% of your standard hourly rate. In other words, if your standard hourly rate is \$100 per hour, your “emergency rate is \$50 per hour above your standard hourly rate. Then, for emergency calls for fixed fee work, you simply bill the fixed fee as usual, based on percentage of completion, but you also bill for time spent on that emergency request at an additional 50% of standard hourly rates.

I strongly advise that a work order be signed for such fees before you do the emergency work. It is amazing how emergencies can vaporize at the mention of the additional fees called for in your contract. On the other hand, time is money to the construction manager. If you supply emergency service, often your client will be grateful and happy to pay a premium for the quick service.

## Include a Table of Hourly Rates

Always attach to your proposal or any client’s contract a *Table of Hourly Rates*. If you are not a licensed surveyor, do not use the word, “surveyor” in any of the work classifications. Instead, substitute some non-regulated title such as “Sr. Layout Specialist.” A sample *Table of Hourly Rates* follows:

***ACME Surveying and Construction Layout, Inc.***

*107 Periwinkle Mountain Road*

*Plitzcreek, AK 00000*

*888.555.1212*

Proposal for project: \_\_\_\_\_

Proposal submitted: \_\_\_\_\_

**Table of Hourly Rates – Effective Jan. 1, 2005**

<u>Classification:</u>	<u>Hourly Rate</u>
Principal	\$120.00
Senior Surveyor	100.00
Surveyor	80.00
Sr. Technician	70.00
Technician	55.00
Jr. Technician	35.00
2-Person Crew	120.00
3-Person Crew	145.00
Secretarial	35.00

Hourly rates for work performed after December 31, 2005, will increase approximately 3%.

Emergency service (less than 2 working days notice or work requested to be performed outside of regular working hours or on holidays is billed at 1½ times above rates.

2 hours time plus time actually spent on site will be billed for calls to sites that are not ready, resulting in a field crew having to leave and seek reassignment on another project. Significant delays not resulting in the crew leaving the site will be billed at above rates.

## Special Equipment

You may want your proposal to state that costs for client-requested special equipment that's not normally carried in a typical survey vehicle will be billed at cost or cost plus a small percentage, and time spent to acquire, rent and transport such equipment will be billed at standard hourly rates.

If you need a boat, an ATV, extension ladder or bucket-truck for some particular project, or traffic closures with costs for signs, cones, barriers, police, etc., you want to have a contractual right to recover these costs. My advice is to use special equipment needs as a basis for additional charges only with prior client approval in writing.

## Liability Insurance

It's important to understand the difference between limiting your liability under an insurance policy and limiting it under terms of a contract. To avoid confusion, I'll first discuss insurance. Keep in mind that in addition to not being a lawyer, I'm also not an insurance agent. I recommend you seek the advice of an insurance professional remembering that insurance agents are also sales people. The more investigation you perform by asking around and reading up on these issues, the better equipped you'll be to assess risks and come to your own determination of what level of insurance protection you will purchase, balanced against what level of risk you will assume.

Following this discussion of liability insurance, we'll look at contractual matters that help limit your liability (or limit and discourage unjust 'backcharges' from your client).

Liability Insurance, in my opinion, should not be mentioned in your contract or proposal unless your client has specifically set forth the need to carry certain types of insurance with specified limits. Before you start work on a project, you're often required to furnish proof of having liability insurance to whatever limits the client requires. I've never seen any benefit gained by including this subject your proposal.

Be certain when purchasing liability insurance to inform your agent of the nature of your activities on the construction site. Rates for your activities should not be astonishingly high, as your activity is not likely to injure the persons or property of others. Most other contractors on the construction site are operating equipment that may back over people, or that are lifting heavy loads that could spill, or operating saws or pneumatic tools. To get the best rate, be certain your agent knows you are not involved in any such activities and that your primary work takes place on the ground, not on upper stories where you might drop something on someone. Once agents understand this, they usually find a way to classify construction layout activity in a way that results in manageable premiums.

Your clients will normally require a certificate specifically naming them that verifies your general liability insurance coverage and secures their interests under your policy. Your insurance agent will send this directly to your client at your request.

## Errors and Omissions Insurance

Every professional activity brings with it the potential for claims against you based on deficiencies in your work. Usually such deficiencies in surveying work are referred to as “errors and omissions.” Some clients will require you to carry insurance to cover your errors and omissions. In my experience, I’ve not been required to carry this form of insurance.

Many small firms and new firms find the cost of obtaining errors and omissions policies prohibitive. This could possibly limit the clients that will hire you, and may be something you investigate before seeking work from a particular client or spend time writing proposals.

One client who requested I have errors and omissions insurance backed down from the request when I stated that deductibles alone were generally higher than the costs of correcting any errors I could conceivably make, and the premiums were outrageous. If I had such insurance and filed a claim for several thousand dollars above high deductibles, my premiums would skyrocket. So, what was the point of having errors and omissions insurance, I asked. This client backed off.

## Backcharges – If you break it, you buy it.

Perhaps the most common form of liability exposure in performing construction layout is through “backcharges.” A backcharge is money your client deducts from your billing to cover costs of fixing errors attributed to your work.

Many competent surveyors shun performing construction layout services for fear of backcharges. For a surveyor, construction layout is essentially “reversing the projector” (running the film backwards). Instead of locating existing features through collection of data and then mapping them, the construction layout specialist is staking features from mapping data or design drawings. What is so hard about that?

The difficulty comes perhaps in not being too good at reading architectural or structural plans, or in not liking mud, dust and a noisy site environment. More importantly, people not acquainted with construction may not know how to make their marking of stakes and their reports clear and unambiguous; they may not know where to place stakes so they’re not in the way of construction. This can be overcome by asking questions and should not deter a competent person from performing construction layout services.

But, the bone-chilling fear so common to those providing construction layout comes primarily from the potential for making mistakes and paying for them. Client's will backcharge you for demolishing work you’ve staked in error and for the costs of reconstructing it in the right place. Generally, you’ll also eat all costs to verify that an actual error was made, that it was really your fault, and of recomputing and restaking corrected control. Yes, this is scary, but nothing worth doing is without some element of risk

Before deciding not to perform construction layout services, consider these points:

- If you are competent and have competent help, construction layout errors will not occur frequently.



- If you are redundant in computing your layout and carefully verify your staking with independent checks at critical points, your errors will be infrequent.
- If you document your work, and it is correct, you will seldom be backcharged unjustly for errors.
- The liability for errors is normally discovered in the course of construction. Once a project is built and occupied, little likelihood exists that any errors will surface. In other words, your liability concerns are generally laid to rest when the owner receives a certificate of occupancy. (Compare this with land surveying statutes that often extend liability for surveying errors to long periods AFTER the error is discovered.)
- Consider the emotional state of your construction layout client compared to the landowner who perceives you've erred and damaged his 'stuff.' The construction manager is constantly dealing with problems. It's a problem solving business. Most construction managers just want the problem solved so things can move on. They are not out for blood as so many landowners are. Landowners can carry a grudge forever and broadcast your inadequacy and incompetence at every social gathering they attend for years on end. Construction managers deal in 3D reality all day, every day. They just want problems and mistakes fixed. Generally, they are not judgmental, vindictive, or mean spirited.
- When you are wrongly accused of making an error, if you calmly defend your innocence through documentation without undue emotionalism, your professional presence under fire will be appreciated. The first thing to do when the call comes saying you've made an error is to immediately gather all the evidence you can about what is wrong and what may have caused it. Then analyze it as if you were not involved in the matter. Be unbiased. Try to find what caused the error, even if it was your doing. Don't triumph over your enemies when you find someone else is to blame. Your turn will come to eat humble pie. This just dessert always tastes bitter to the proud and arrogant.
- If you find you're at fault, readily admit your error and promptly take any corrective action necessary, your client will appreciate your cooperation and readiness to accept blame and responsibility when it's your error. Your client already knows you're human and make mistakes. All the other sub-contractors make errors, too. You'll be appreciated for your honesty and cooperation and remembered as one who refrained from pointing the accusing finger and helped resolve the problem.
- If you take extreme care with large structures, especially buildings, dams, bridges, and retaining walls – the stuff that can cost huge amounts if staked wrong – the other things on site are generally not so costly that they'd bankrupt you if you make a mistake.
- If you document in writing what plans you are working from (dates, plan numbers, change orders, etc.) and you follow your own good sense and suggestions in this course, you can often avoid being held responsible for laying things out from the wrong plan, assuming it's the one you've been provided for the purpose. This matter is covered more deeply elsewhere in this course.

- If you are a surveyor reading this, you know how shocked a landowner is when you discuss your fees. How nice it is, at the end of a typical day of construction layout, when you hand a work order to a superintendent for \$800 to \$1000 and get a ready signature and a sincere thank you. You can come back day after day and get the same response. Try this with your typical landowner who needs your expertise but hates to pay for it! Most construction managers and general contractors know the value of your services and gratefully pay the competent and responsive construction layout specialist. And, they are return customers.

Sure, there is exposure to liability in the form of backcharges. But, a good client will give you contract after contract, year after year and will forgive you the occasional mistake with ease. You may have to pay for your mistake, but you won't be hated for having made one. And, yes, the construction layout realm is fraught with the potential for liability for any errors you make and worse, for errors you didn't make that you unjustly get blamed for making.

## The Blame Game – Play to win!

If you've made the errors, you *should* be responsible for the damages. This is only fair. But, what isn't fair is when you're blamed for an error and charged for it without being given opportunity to verify your fault. What isn't fair and sometimes happens is this: Incompetent or lazy subcontractors should notice your obvious mistake before they construct something in error, but they appear to be blind. Or, they should provide a reasonable measure of verification of your data and don't. They just go ahead and construct something in error, then sit back and expect you to bear full blame.

Ah, blame! CONSTRUCTION IS A BLAME GAME! Why? Because we are human. We make mistakes. Many people will not readily admit having made a mistake due to pride, insecurity or fear of retribution from their boss or their client. So, they try to pass off the blame to some innocent party – you!

Most often, it's not be your client, the construction manager, who blames you for things; it's some other subcontractor who either discovers an error or invents your fault to cover their own error.

TRUE STORY – The following is a true story, the moral of which is this: On high-liability work, always provide independent, redundant checks of your work, and document what you've done. The second moral is probably, don't behave as I did – unless you are 100% sure of yourself and maybe a little nuts.

It started as a routine staking of a long narrow building several hundred feet long that was to be a strip shopping center. The footings were poured per my staking, and I was asked to provide “brick points” (nails in the footing to indicate exterior building corners at each of its numerous jogs).

These nails were set in the footings by radial stakeout from two well-preserved, intervisible control points previously set at opposite ends of the proposed building during my first visit to the site, in areas undisturbed by construction. From these two control points, I set the “brick point” nails in the foundation to mark the many jogs in the block wall to be built on this footing. I

checked three or four corners near the middle of the building by setting them from the first occupied point and later turned to them from the second occupied point, thus verifying both the nails just set in the footings and the positional integrity of the two control points in relation to each other.

After radially staking all these “brick points,” I set the total station at a random point in the middle of the building footprint where I could see two property corners, all the brick points and the two primary building control points. From this random point, I located all the aforementioned points.

Then, I measured between the brick point nails with a steel tape to check the future wall distances against the plan dimensions for those walls.

Back at the office, I did a three-point resection to determine coordinates of the new, random point used for the checking. Coordinates were established for all the as-staked locations. Next, I inverted between the theoretical computed locations of wall corners and the as staked, “brick point” positions. This confirmed all points were set correctly. Finally, I drew lines between the set points in the computer and labeled them, checking the wall lengths per the computer-generated labels against the structural and architectural plans, finding agreement for all wall lengths. Everything was tight!

At this point, I must say that I felt a bit foolish at taking such pains to prove my layout correct. Now, I always did make redundant checks, including measuring between the points set, but the additional, random setup and location of points, inverting, etc. was a bit much for me. I accused myself of being anal-retentive for double- and triple checking, against which self-accusation I could make no defense. But, I followed my gut, which seemed to be leading me at the time.

Within a few days, the superintendent at that site called and asked me to come to the site to meet with him and the mason constructing the block walls of the building. He said the mason said I’d laid it out wrong and two walls were about 9 inches off.

During that call, the superintendent verified that the plans I’d staked from were current. This seemed to eliminate the only possible cause for my layout being wrong. Now, it must be said that in every case but this one, I always kept my attitude humble when called to a site because someone found what they thought was an error I’d made. After all, it might have been true, and arrogance is not a winning card to play at such a time. But, I acted out of character this one time, largely due to the excessively redundant and independent proofs I’d intuitively made when staking. There, see? It wasn’t that I was anal-retentive after all – just intuitive!

Frankly, I was excited to get this call saying I’d make a mistake, a call that under most circumstances would make my blood run cold. After verifying that my plans were current, I said to the superintendent with whom I’d built a working relationship by this time, “No, I really don’t need to come to the site; the mason built it wrong.”

There was a moment of silence on the other end of the phone. Then the superintendent said, “Look, I believe you, but the mason is insisting you staked it in error, and I really need you to come out here and meet with us so you can defend your layout.”

I agreed to come to his site the next morning and do some non-urgent staking that I'd planned to do later that week. That way, I wouldn't be contributing free time to the venture.

After working at the site a couple of hours the following morning, I noticed the superintendent and another man looking and pointing at walls near the middle of the building. I took a break from the staking we were doing and strolled over to them, leaving my assistant in the van (a conversion van with drafting area and on-board computer) to do some computations and checking.

The superintendent introduced me to the mason who wasted no time in telling me I'd laid the building brick points out wrong. Without hesitation, I got on my radio and called to my assistant, "Tom, bring me the 10-pound sledge, I'm going to break down a corner of this building."

The superintendent and mason looked at each other in disbelief. The mason asked, "You're going to knock down the wall?"

"Just in this corner," I replied flatly, "I need to show you the nail you've covered with the walls."

In the few minutes it took my assistant to get out of the van and bring the sledge to me, I stooped to the shallow trench that had a thin film of ice over the couple of inches of water covering the footing. I broke the ice with my fist and began scooping water from the corner with very fast motions, trying to get a look at the wall corner in question. I wanted to see if my nail was visible.

Beneath the surface of the water in the trench, I could see my orange paint marking an "L" at each nail. The orange "L" had been spray-painted on the concrete footing at the nails and marked the 90-degree angle the wall took at those points.

Just as my assistant arrived with the sledge, I called to the superintendent and the mason to watch as I scooped water from the trench. "Look!" I said, "There's the orange plastic ring on the ram-set nail." It was poking out, half visible on the WRONG side of the concrete block. The masons had placed the wrong edge of the block on the nail as their starting point for that portion of the wall, and the wall was constructed a block-width off.

The mason just stared blankly at the evidence, and the superintendent's face bore a wry smile. He privately admitted later that he enjoyed my theatrical presentation and my threat to break down the wall. Truth is, I would have smashed down the wall to prove my position, for I was a touch angry at being conveniently accused of making the error by a person who was ignorant of the facts and willing to blame anyone in sight.

It hadn't dawned on the mason that two walls offset by a short, perpendicular section joining them together, were about 9" short for one wall and 9" long for the other, the approximate width of a concrete block. Neither did he notice that the short, perpendicular wall he'd constructed between two longer walls was sitting very near the edge of the footing, not closer to the center as was typical.

**DON'T TRY THIS AT HOME!** I don't know what possessed me to be so rash. Seldom is taking such a posture appropriate. I relate this story because it illustrates several important points:

- Well-documented, redundant checks limit your liability.

- It's important to build relationships with your clients. This particular superintendent enjoyed my unconventional handling of the situation, and I knew he would.
- Expect to be blamed for things that go wrong – things that aren't your fault.
- Be prepared to defend your work with neat and thorough documentation or other proofs.
- If you decide to be cocky, be certain your client will appreciate it. When in doubt, don't! A wise guy is seldom appreciated; a confident yet humble presentation is a safe posture. Know your audience.

## **Proposal language protects against unjust backcharges**

If the matter just related had resulted in a backcharge, and I'd not been given opportunity to verify or disprove the mason's false claim, my proposal states that I'd bear no liability. My proposals anticipate such incidents and attempt to limit my liability for errors that are not my fault.

## **Not responsible for unreported, undocumented errors**

I suggest you include in your proposal that you will not be held responsible for errors that are not reported to you in a timely manner or that you've not been given opportunity to verify.

## **Will give immediate attention to calls to verify apparent or suspected errors**

It states that when notified, I'll give immediate attention to investigate suspected errors and assist in determining the cause of and the party or parties responsible for the error.

## **Must be shown evidence of fault and given opportunity to verify**

It states that I must be supplied with evidence of the fault or error and provided an opportunity to verify the claim.

## **Wrongly placed construction and stakes or control not to be removed for 24 hours of notice**

My proposal states that stakes with bad data or incorrectly set shall not be removed or destroyed prior to my inspection, and that I will not assume responsibility for claims arising from stakes that have been destroyed or disturbed prior to such inspection.

## **No notice? No backcharge.**

My proposal states, "If above notice and opportunity to investigate is not given, it will be assumed that, at the discretion of [client], demolition and reconstruction was performed without recourse to [me]. Let a lawyer advise you on this and craft appropriate language, because this is a critical protection! Without a legally enforceable clause to cover an unjust backcharge, you are defenseless against deductions from your bills that appear 30 or 60 days after some alleged error in your work is discovered.

## **If construction commences prior to notice to proceed (stakes marked in field)**

Sometimes you will be asked to mark cuts and fills on your stakes in the field, rather than return to your office to prepare and check a grade sheet showing that data. This request makes sense from the contractor's point of view. When you provide a grade sheet, the contractor has no grades to work from until receiving that grade sheet and then marking the stakes you've set.

But, your risk increases if you provide cuts and fills marked stakes during the same visit to the site in which you set those stakes. You have no opportunity to verify your data in the office, and you or your crew may mark the stakes incorrectly, even if the math done in the field is correct.

If you elect for the contractor's convenience to mark stakes in the field, it makes sense to provide some time for you to check your work back in the office and only then, to advise the contractor to proceed based on those stakes. You will be held responsible for errors whether or not you check your work. So why take the extra risk?

If the contractor immediately sets to work from stakes marked by you at the time of staking, you should not be responsible for the work you've not had opportunity to check. Therefore, I suggest some proposal language be included to place responsibility for such action on the contractor's or construction manager's shoulders. After all, they are the ones who may decide that the benefits of moving ahead with construction offset their risk in working from your unchecked layout. They have every right to make that decision – so long as they don't hold you liable for the correctness of your unchecked work.

## **Proposal Language – Summary**

### **Pay the price of a printed form – or don't.**

I suggest you carefully craft the standard, limiting and disclaiming language of your proposal, to include generic assumptions: when hourly, extra, or special fees apply, disclaimers, client responsibilities, reference to your *Table of Hourly Rates*, etc.

Take your draft, along with all questions you have, to an attorney. Refine the language and content of the document.

When that is done, put it all in a word processor and format it using small text, say 7 or 8-point text at the largest. Make it fit on one sheet of paper with generous white space around the margins and between the paragraphs. This will become the back side of your printed proposal form for construction layout. When you have something you like the content and looks of, take it to a printer along with your art-work for the mostly blank, front side of your standard proposal form.

Or, since you will probably not use a large quantity of these forms, you may wish to make the form yourself using a word processing or forms program on your computer



For a starting point in your design, check Internet sites that provide standard and custom forms printing. You'll find some ideas to get started. Standard off-the-shelf proposal forms have not worked in my experience for the construction layout business.

Finally, I suggest that you print your proposal forms two-sided. Print the back side using fine print in a readable, gray or screened font, like the contracts you sign regularly in the course of your life. Don't make the print hard to read! Say what you need to say in the fine print concisely and clearly, in everyday language wherever possible. Then, make a standard template or simply a document you open to start your proposals.

When you have a specific proposal to craft, know what you're going to place in the available space on the front of your standard proposal form and enter it on your computer using the template you've pre-designed. When that is printed, turn the paper over and run it through the printer adding the fine print to the back side of the proposal form.

If you have the money and really mean to impress, you can seek the aid of a professional printer to make forms for you, even carbonless, color-coded, and two- or three-part forms. Just make sure the format allows you to stretch to more than one page without the form looking like it's inappropriate for its use.

Remember, your proposal is a contract when countersigned by your client and returned to you. And, we HOPE it has the force of a contract when you are awarded a project based on that proposal. Again, ask your attorney!

## You've been awarded the Contract!

What great news! You've been awarded the contract. The question is, whose contract? When you made your proposal, you put great thought into it and paid for legal advice and even took a course in construction layout (this one).

Next thing you know, your client presents you with a contract document to sign, and your proposal is nowhere in sight!

## Your Contract or Mine?

So, whose contract is going to prevail? It's a sure thing that the person who drafts any contract is likely to find the terms to his favor. I suppose it depends on how hungry you are for work, how much you trust your client, and how good a negotiator you are, whether or not this is an acceptable situation.

The first thing to determine is whether your proposal is referenced in the contract provided by the client. If your proposal is directly referenced in the new contract, it's a good sign. As always, check with your attorney, but for my money, a contract that references a proposal, legally includes a proposal, so the real questions are:

- Does this new document conflict with the proposal, on what points and to what harm or potential for harm? If in conflict, which prevails?



- Finally, knowing the facts, ask yourself, “Do I really care about the differences between my proposal and this contract I’ve been given to sign?”

If you do, you have some negotiating to do. While construction layout is your livelihood, don’t lose sight of how small your role is in the overall project and its budget. (Remember that little ellipse at the bottom of Figure 1!) If you’re too much of a pain to your potential client, the award may pass to someone easier to deal with.

## **Negotiate to win.**

If you decide to negotiate, know what battles you need to win, if any. During negotiations, whenever possible, make some concessions prior to bringing up the thing(s) you just can’t live with. Then, if you meet with resistance point out how reasonable you’ve been and concisely explain why this matters so much to you. Be sure your attitude is one of working together, not a contest of wills. Seek the common good.

Sometimes you’ll get some verbal assurance like, “Oh, we’d never do that to you. But, we’re stuck with this contract; we can’t deviate from it, or our insurance company (or our lawyer, or our underwriter...) made me do it.”

If you’re willing to live with the risk, you might ask at this point, “OK, Joe. I trust you. May I quote you on that?”

Joe is in a spot now. If he says, “Sure,” you mostly have what you want. If he says, “No, you can’t quote me because I’m a liar,” you have a problem. Of course, he won’t admit he’s a liar, but if he’d never do that, and assures you with his ‘trust me’ look that he’d never do that, then why the heck can’t you quote him? Something is wrong with the picture, wouldn’t you agree?

Suppose Joe offhandedly says sure, you can quote him, then do it! In some unobtrusive way, like an e-mail you request a “read” receipt on, or even a “sent” e-mail you print (which will show time and date sent), you go ahead and quote him.

Your communication says something like this: Per our conversation on the phone today, I’m accepting your contract and want to thank you for this opportunity to serve you on this important project. You’ve stated that [whatever Joe said you can quote him on] even though the written contract stated otherwise. Based on your verbal assurance, I am pleased to be a part of your team and will make every effort to provide your needs on this project.

Make your stab at providing some formal evidence of Joe’s assurances clear, exact and concise and bury it in the middle of blah-blah stuff. I suggest a nice, long paragraph of meaningless drivel with your silver bullet buried deep in the middle. It may not turn the legal tide if push comes to shove, but at least you’ve created evidence that could prove embarrassing should Joe forget his promise, and that might be enough to give you some needed power in any future struggle over this issue. Remember, Joe has no right to lie to you or to make assurances he has no intention of keeping or authority to keep. He has no cause to complain if he’s quoted. You asked him if you could!

Finally, keep this in mind. The simple solution that may avoid any difficult negotiations is to ask if the contract can be amended to simply reference your proposal. Explain that your proposal

says that in the event of conflict between the proposal and any contract to which it is attached or in which it is referenced, the contract terms shall prevail over the proposal. (Of course, your proposal needs to contain such language.)

Point out that because of that clause, the client's standard contract will not lose force. But, because the contract is generic in scope, it doesn't address some concerns that your particular proposal specifies, and these are important to you and to the client. See if this logic flies. If so, probably you can just find a place in the contract where you can write, "This contract incorporates by reverence [my] proposal dated \_\_\_/\_\_\_/\_\_\_\_." Again as always, ASK YOUR LAWYER.

## Pre-construction Meeting

Now you've landed a mid-sized commercial, industrial or institutional construction layout contract. (A project of this scope is useful to illustrate conditions found in many smaller and larger assignments.) Congratulations! You've reviewed the bid set of plans, had your Pre-Bid Meeting, refined your scope of services to fit the project and the client, made a Proposal and been awarded the contract. The next thing you want to do is get yourself invited to the Pre-Construction Meeting.

Normally this meeting takes place with many of the subcontractors present. The project schedule is discussed, and in particular, the superintendent or project manager wants to get start date commitments from subcontractors whose work comes early in the construction. For example, demolition may be required on a previously developed site; then clearing, stripping and storage of topsoil, excavation, rough grading, building foundation or footing construction, etc. Did you notice that some of these early functions require your layout? That is why you want to be at this meeting.

And, closely observe your client's employees at this meeting. What are their titles and roles they assume? Get clues about how your client administers the construction oversight function. Who runs the meeting? If the site superintendent takes the lead, it suggests that this person will probably be your main contact throughout the course of the project. If a project manager who'll be functioning from the client's office (not stationed on site) leads the meeting, this suggests you'll have more than one boss. You need to get a feel for how your client's personnel relate and share responsibilities.

## Remember the distinction between the expertise of PM & Super

In a construction management firm of significant size, you're likely to find a structure comprised of project managers, assistant project managers and superintendents.

The superintendent is the person stationed on the site, usually in a construction trailer or temporary office. The project manager and assistant project manager may or may not be physically present at the site during construction. It helps to know whom you are meeting with, because your primary communication once the project starts is with the superintendent in most cases. The superintendent, in my experience, is most likely to really know what is needed for

layout. The project manager has many, many administrative duties to perform, project scheduling, monitoring of schedules and budget constraints, dealing with lots and lots of paper work and phone calls. The assistant project manager performs varied duties and may have little or much to do with ordering construction layout. This varies from firm to firm and possibly even from site to site with the same company.

But, for my money, the superintendent is your best bet for finding out specifically what is needed in the way of layout. It is to your advantage to provide the ones actually constructing what they want and need for layout. One of the most common and greatest failings I've observed in people providing construction layout is not asking specifically what is desired for layout.

Generally, at this pre-construction meeting or soon after, you will want to ask at least the following questions:

### **Cutsheets (Gradesheets) or Marked Stakes?**

Ask what layout will require you to mark stakes in the field rather than provide gradesheets. Gradesheets, sometimes called cutsheets, are generally letter-sized pages of rows and columns with data providing the vertical and horizontal relationship between your stakes and the proposed construction. More information about Grade Sheets is included near the end of the course.

### **What hours site will be available for staking?**

Find out when the site will be open for your staking activities. It is common that construction sites are fenced and locked when the construction manager or superintendent is not present. In many areas, the construction activities start at 7:00 in the morning or earlier and end promptly at 3:30 in the afternoon. Surveying and engineering companies often don't start work until 8:00 in the morning, and survey crews won't leave the office (to head for the coffee shop) until later than that. It best for client relations and most cost-effective to make your crews' work hours coincide with those of your construction layout clients.

### **Will there be a full-time, on-site superintendent?**

This is important, assuming your client is the firm employing the superintendent. Some construction management firms spread a single superintendent across multiple projects. This makes it difficult for you to get direction and work approval. You should obtain pager and cell phone numbers for the superintendent, so that you can coordinate or ask questions as needed. You should also arrange verbal authorization for your work in the event the superintendent is not available to sign work orders. Write a letter or send an e-mail to your client stating that you were authorized by so-and-so to accept verbal instructions plus authorization for work by phone. Ask that they notify you in writing if that should change. Be sure to write the name of the person who approved or ordered layout plus the date and time of the approval on your work order.

### **Will there be any on-site layout staff and equipment?**

Occasionally, you will be providing primary control from which your client will perform the bulk of the staking. A simple example of this is when you provide a control rectangle for a

single-family residence, and the contractor actually stakes all the jogs in the home from your four stakes.

On a commercial site, the degree of control you provide can vary greatly. A client may rely on you entirely for at least “ground level” control. Other times, you will provide minimal control to be supplemented by your client or sub-contractors.

In some instances, you will provide most control, but the client’s personnel will come behind you and check your work. Typically, the person checking your work will be a young graduate of some construction management program who is high on theory and light on experience. This can create a special problem for you, especially when this person is equipped with better equipment than you possess. A true story related later will illustrate this.

Ask in your pre-construction meeting whether the client will have its own layout personnel present on the site to perform either supplemental layout or checking. If so, you may wish to inquire who will actually be doing that work and what equipment will be employed.

## **Bid-set of Plans still current?**

Sometimes, the plan set you used for bidding is not current at the time of groundbreaking. Be absolutely certain to verify that the bid-set is current or to obtain a current set of plans.

And, e-mail or send a memo stating that you’ve been informed that such-and-such a plan set or sets is current (stating the latest revision date of the plans) and that you will use them for all layout unless directed otherwise by your client.

## **Communication**

### **Ask lots of questions—preceded by personal statements**

Questions are manipulative devices. They seldom reveal the reason they’re being asked. Consider, for example, those times when the boss comes over and asks, “How long will it take you to finish that?” You don’t know why you’re being asked this. Is the boss upset at how long it’s taking or does the boss simply want to know when you’ll be looking for your next assignment?

What if a detective knocks on your door and asks, “Where were you on the night of October 9<sup>th</sup>?” Don’t you want to know WHY you’re being asked that question?

Questions put the person asked at a disadvantage. Questions you ask put you in control of the other person. Questions therefore make people uncomfortable – subconsciously if not consciously. Questions you ask another demand information from that other person, but don’t reveal why you’re asking.

### **Is mine the most recent plan?**

Consider the difference between asking a site superintendent “What’s the most recent site plan?” or, saying instead, “I’ll be staking the curbing west of the building today and want to be certain

I'm staking from the most recent plan. Mine is dated October 9<sup>th</sup> of this year. Could you confirm that this is the correct plan to stake from?"

Which do you think is going to be better received by the superintendent? Did you notice I just manipulated your thinking? Did you mind? There, I just did it again!

Not only are you providing the superintendent with better information in the second approach noted above, you're likely to get a considered answer and an accurate one, not just a tossed off answer.

Seldom will the construction managers mind your interruption if they realize it's for a good reason. Briefly explaining your reasons for asking shows respect for their busy lives, helping them know why you're taking up their time and redirecting their activity with your questions. Also, you are many times more likely to get an answer that truly addresses your need.

## **Where will the site remain undisturbed until this staking is no longer needed? Where is the best place for our control to be set?**

Having ascertained that you are working off the most recent plan, your next effort is to find out WHERE you should set your stakes so they have the best chance to outlive their usefulness.

## **What points do you want referenced?**

The site superintendent knows what should be referenced: a column line or a building corner, the center of a catch basin or the point where a line through the center of the basin intersects the face of curbing along the street.

## **How do you want the stakes marked?**

Should the stake note a cut to the bottom of curb at the gutter line or top of curb? Should the offset be to the gutter or back of curb? Be very careful with your computations if you are asked to show cuts to the gutter grade, but the plans show proposed top of curb spot elevations.

And, ALWAYS mark your stakes and label your grade sheets CLEARLY as to what horizontal and vertical points your cuts and fills are referencing!

Once, a surveyor I knew almost bought an entire, newly constructed street because his crew marked the offset stakes, "2' O/S BACK CURB," meaning behind the face of curb. The contractor took the stake to mean, "two foot offset to the *back* of the curb," not to the *face* of the curb as the surveyor intended. What do you think got constructed? The result was a road got constructed one foot too narrow to conform to the town's standard, that is, two times the width of the curb. The town decided to accept the street anyway, and the surveyor got to keep his house and his business. This was a narrow escape that might have bankrupted the surveyor if the town had been rigid. What caused this crisis? The surveyor's crew marked the stakes in a manner that made his intent unclear to the contractor. The devil is in the details.

## **Will you need Grade Sheets?**

Grade Sheets (also called, “Cut Sheets”) allow more careful review of the control you've provided to the contractor than stakes you mark in the field. Grade Sheets are safer and generally preferred over just marking cuts and fills on stakes when they're set in the field, as discussed earlier. When using Grade Sheets, construction can't begin until you've checked and delivered them. If you leave stakes in the field with cuts and fills marked on them, construction often starts from the marked stakes – before you've had a chance to check your work back in the office.

## **If you marked grades on the stakes, ask when will the actual construction begin?**

If you've provided cuts and fills marked on stakes, the danger is that construction may begin immediately and not allow you time to correct mistakes. Also, if pressed by too much work to complete in too short a time or by a budget that is in bad shape on the construction layout project, you may elect to not check the layout notes at all. (A very bad idea.) But, if you're delivering cutsheets, you'll have opportunity to rethink the layout provided, and you're therefore more likely to discover errors before anything is built.

For this reason, when marking cuts and fills on stakes set in the field, ask when construction will begin using those stakes and state that you have not checked your work yet. Any work started before you've “signed off” on the marked stakes is at the risk of the client. At least, as noted earlier, your proposal should note this point in its disclaimers. Advise your client to either not start until you've notified that the stakes are correct or to assume the risk of working from unchecked work.

## **Are you expecting any activities today that will block our line of sight?**

If you explain where you expect to be working, often the superintendent will run interference for you, getting areas cleared of obstructions to your sight lines, and tell subcontractors to keep the area open for you.

## **What are acceptable tolerances for this particular layout?**

Want to make money? Lay it out as accurately as necessary, not as accurately as possible. Document the stated, acceptable tolerances on your work order and get it signed. (Work Orders are specifically discussed near the end of this course. Their use is introduced throughout this material.)

## **Is there any “dead” equipment on site that cannot be moved if it's in the way?**

On a site jammed with equipment, stockpiles and storage areas, you may have trouble seeing necessary lines of sight. It's helpful to know if certain pieces of equipment in the vicinity of your



work can or can't be moved. If you see a concrete truck in your area of work, ask how long the activity is expected to continue.

## **What's the name of the equipment operator?**

If you notice that a piece of active equipment will be getting in your way, find out the operators name. When you approach this individual later and ask that something be moved, address the person by name. It'll make a difference in that person's response to you if you know his name.

## **If our work runs late, will we be able to stay to complete it?**

Some sites will be locked and inaccessible after a certain time. Most construction sites I'm familiar with operate generally between 7:00 and 3:30. Some sites lock their gates at 3:30. If you have a half hour to finish at 3:30, too bad. Come back in the morning. On other sites, I've finished by flashlight and locked the gate on my way out. The superintendent allowed us to lock up when we were finished. It pays to know which applies to you and if there is any flexibility available.

## **Who will sign our work order today and will that person be available all day?**

A work order signed by the superintendent (or other authorized client employee) prevents most future disputes over hourly, re-stake or extra charges. For this reason, it's important to have your work order signed at the end of each day that you perform layout at your client's site.

At projects where the superintendent is not always present on the site, it's best to ask if another authorized individual will be there to sign it. If that's not possible, at least get the superintendent to sign authorization for your work during this conversation. Write on the face of your work order, "Work authorized by \_\_\_\_\_" and have the superintendent sign there. A signature there doesn't necessarily approve the hours you end up spending, but at least the client's request for the work is documented. Most often, this will suffice to get you paid without a struggle.

This signature (or some authorization in writing) is critical protection for you. At the end of the day, note your hours on the work order for any work performed other than set-fee work, and leave a copy in the superintendent's office if possible.

If the work you've performed is for set-fee items of your proposal, the hours you spend at such tasks need not be stated on the work order. For set-fee layout, your fees for any given month are based on percentage of completion for each such item at the end of your monthly billing cycle.

Imagine your client trying to remember what you did on any particular day a couple of weeks back in order to authorize that work if no work order was made and signed. But, a copy of a signed work order immediately ends all uncertainty. An ounce of prevention...

## **You are only *one* of the experts. Stay in your place.**

In communications with others on the site, especially with your client, recognize that they are experts in their field, as you are in yours. Don't forget your place in the overall picture is



proportionally quite small. This point is restated often throughout this course for a reason: it needs to be.

## **Expect to learn**

You'll be ever learning in the construction environment. It has its own vocabulary and its unique culture. In many ways, it will be refreshing to deal with practical people if you've been cooped up with engineering-folk. In the construction world, you're dealing with people whose job it is to solve problems and get the thing built. Construction managers are the last people to handle the project's design and the ones who know how it goes together – often better than the designers do. Designers can be anal-retentive, and they're often in their profession precisely because they are. Construction managers can't afford to indulge pointlessness; they need to move forward. They're often a delight to be around, because they're problem solvers, doers and facilitators, not finger pointers. Listen well and learn.

## **Discuss your intentions**

When you arrive on the site to perform layout services, BRIEFLY tell the superintendent what you intend to do. I'm not speaking of a long, drawn-out explanation of your processes, but a general and concise statement of your plan of action. You either will have to get his blessing or be instructed in a better way. Either result is highly beneficial. Later in this course, different approaches to laying out various proposed construction is discussed in more detail. For now, it is enough to say don't just set about your work without discussing what you are about to do with the superintendent.

In my experience, surveyors and engineers often arrive on a site and set about doing what they *think* is needed. And, often this is not what's really wanted. Offsets may get staked on the wrong side of the work for the convenience of other needs. Offset distances may be too far away for convenient use or too close to work around when constructing. Discuss your intentions before staking.

## **Know your contract and assignment**

It can't be said too often: Know your contract; know what you're being asked to do; and know if it's in your contract as a set-fee item or as an hourly-charge item.

If your contract is specific enough about the work requested, and you or your crew know what is and is not a part of that contract, then work requested that exceeds what you've committed to provide must be charged as an "extra" or made a gift to your client.

Any last minute "Oh, while you're here, could you please..." request is legitimate as long as it is in your contract and you have the time to do it without compromising another client's previously ordered and scheduled requests.

## **Be prepared for Extra Work**

Be sure you and your crew(s) know how to respond to requests that are outside the scope of your contract. Always, always have blank work orders with you in your vehicle, and get your client used to signing them, even for contract work. When the extra work requests are made, your client will be used to your appearing with the work order to be signed before you start the work.

## **Memorize names and titles**

Know to whom you are speaking, and tell your crews to do the same. Never permit your crew to come back at the end of the day and say, “A guy on the site asked us to stake the dumpster pad, so we did it.”

You or your crew **MUST** know the name of anyone requesting work and that person’s title. Some sub-contractor may be requesting the work – a person who has no business relationship with you and either thinks you are there to serve any site needs (at someone else’s expense) or is sly enough try for some free work.

If you are not personally on site, your crew **MUST** know what is and is not in the contract; what is a set-fee item; what is an extra-fee (not in contract) work request; and how to handle each type of service provided.

## **No work authorization? No work.**

If you and your crews follow a policy to get **ALL** work authorized with a signed work order, even your proposal’s set-fee items, then it is much easier to get the on-site superintendent (or other client representative) to sign your work orders for hourly or extra work items.

And, don’t do even contract work that is requested by someone other than your client. For example, if the building contractor asks you to stake the elevator shaft, and it’s in your contract to perform that layout, don’t do it without a signed work order from your client.

All subcontractors will understand that you do not have a contract with them if you mention this fact. When a subcontractor asks you to perform layout services not in your contract with your client, it is always a winning strategy to say, “Will your firm be paying for this, or is [name of your client] paying for it?”

As soon as they say your client will be paying, you say something like, “Sure, I’ll be happy to do what you’ve asked. I just need to get a signed work order from my client to authorize this work. The best thing is for us to walk over to the site office together so you can ask [my client] to authorize this work.” If that subcontractor is trying to ‘sneak one in,’ they’ll find some excuse to put off that encounter with your client.

## **Educate your crews and require their compliance**

Never allow the crew to take direction from someone or discuss the mission with a person whose name, employer and position they didn’t write down and can’t remember. “The fat, red-haired guy” is not a name! **WRITE THE NAME DOWN.**

Train, train and train. The average field crew, especially one used to performing boundary surveying and land surveying functions, can’t be function as adequate business representatives unless you train them to faithfully represent your business interests and follow your policies on the construction site.

If you are normally available by phone, a safe policy is for your crews to always call you in the presence of the person requesting any work other than what you’ve sent them to the site to perform. This, of course, requires that you either provide your crews with cell phones or have your crew’s permission to use their private cell phones for this purpose. In this case, your

training is easier. You simply instruct your crews to call you the minute someone asks for layout you didn't anticipate when you sent them to the site.

Some crew chiefs are generous souls, who will give away the shop. Some are cantankerous individuals who will not represent you well in negotiations. Occasionally, you find an employee who handles business and client relations well and can be relied upon to represent your interests. The party chief who does this well stands out.

Know your personnel and fit your direction and instruction to the person. Educate them in what you expect from them with regard to client relations and business decisions. This aspect of construction layout is often overlooked by supervisors who are used to overseeing primarily land surveying assignments. A crew performing traditional land surveying work almost never gets into contract or money discussions with your clients while on site. The leader of your construction layout crew will frequently represent you and your business interests. It pays to train them for this.

Finally, all junior members of your crews need to know that the rule is, "Never, never dialogue or discuss the work with someone on site. ALWAYS refer conversations to the senior member of the crew or the supervisor in the office."

Explain to your crews that this is not a flexible policy. It is the Rule, and it must not be violated. Be sure your employees know that it's not a reflection on any person. It's a policy recognizing that the business relationship with clients is always conducted by the most senior person present, and many times will need to be referred to the office. Often even the superintendent (who should know better) will approach the closest member of the crew and negotiate as though this person is authorized to make business decisions. Drill junior crew members to say, "I'd like to help you, but you really need to talk to [the crew chief or my office] about that."

Train the junior members not to answer questions even when they know the answer. They should say something like, "Come with me, and let me introduce you to the party chief. He (or she) can answer any questions you may have."

Your crew chief needs to be told to not allow discussions related to the work between his or her subordinates and the client or contractors. There is considerable liability in your work, and any inadvertent miscommunication, lack of necessary communication or confusion can backfire on you with horrific consequences!

## **Job Folder – Take it each time**

The job or project folder, or at least a field folder for the project, should be taken to the site with each visit. In a small business, when you're generally the one actually going to the field, take the entire job folder with you to every assignment.

In larger firms, or when both field and office functions are taking place simultaneously on the same project (or when you have a crew chief prone to losing things), create a field folder that contains everything that may be needed in the field. Make copies of items that go in both field and office folders. It may be prudent to have a self-inking 'FIELD COPY' stamp made to avoid confusion.

## Color-coded Folders

I always use colored folders for each project, and these go in an accordion (expanding) project folder. This makes it much easier to recover or properly file paper work. My color scheme is logical (once explained), and easy to remember. Personally, I don't know why the entire world of business hasn't discovered the benefits of using colored folders. I think my medical/dental providers have though. I see many colors in their racks of patient files, and I suspect those colors mean something.

But, in engineering/surveying firms, perhaps due to our bland personalities, we typically see just those manila folders – those dull, boring, creamy-yellow folders stuffed with filed and misfiled white papers.

Manila and white. How often have you cursed manila and white? Isn't it a pain to deal with job folders, especially for very large projects? Wouldn't it be nice (and worth a very slight, extra expense) to open a job folder and be guided directly to the stuff you need?

Consider color! Colored folders can let you know at a glance, without even reading the scribble on the little tabs, what's in them. Why stop there?!? Colored paper, when used consistently for just one category, classification, or type of business activity, announces instantly what manner of record it is.

Here's my color-coding scheme for construction layout projects:

### **Blue – “Contract” or “Proposal” folder**

The terms, contract and proposal will be used interchangeably in this discussion. A signed proposal returned to you is a contract.

I keep the contract, and little else, in a blue folder. It's always just a few seconds away, available for ready and easy reference, and it **MUST** be reviewed with every call for layout and before every trip to the site. You absolutely must know if what you are being asked to stake is what you've agreed to stake for a set fee, for hourly fees or work that's being requested in addition to what you've agreed to perform. I recommend that you always check the contract either as the call comes for layout or immediately after you hang up the phone. Check to see if you have an agreement for the work you are being asked to do. If not, get one before you do the work.

And, quibbling about it when you arrive on the site is a not a good idea. By the time you arrive on the site, your service is needed right then. If authorization is needed beyond the normal, it can take time. This delays the project and generally means you have to scramble to rearrange your own schedule. And, you've lost at least a couple hours of billable time to regroup and go to another site if the work you've been asked to do is not authorized. Worse yet, you've probably offended your client in the process.

If you have several projects, especially serving different clients, your contracts will vary on significant points. One client may rely on you for partial layout, while another has you lay out almost everything on the site. One client wants offsets to sanitary sewer lines at 50-foot intervals, and another wants only manholes staked with double offsets. Or, perhaps a project manager told you in the pre-bid meeting to bid based on providing a four-point control rectangle for the

building, but the superintendent has just ordered column layout with offsets. In this case, no one has authorized column layout. Are you going to do it for the fee you quoted for a four-point control rectangle?

Make frequent reference to your contract. And, by the way, did you notice in the last paragraph how important written notes taken at your pre-bid meeting with the project manager become? Imagine the power position you are in when you call the PM and say, “Hi Jim. I have a question about how to proceed on your Bedrock Bank and Trust project. Maybe you can help me out. My notes made during our meeting on June 16<sup>th</sup>, as we discussed how to structure my proposal, you said I should base my fees on providing a control rectangle for the building layout, and that your subcontractor would take it from there. But, I just received a call from your superintendent asking that I stake column lines, which of course is more intense layout than you suggested. Could you look into this and find out if I should do what your superintendent asked as an extra fee or stick to the control rectangle approach per my proposal?”

By having a conversation log from that meeting and keeping your contract close at hand and easily retrievable, you’ve disarmed a bad situation in a matter of minutes and placed the ball in your client’s court, where it rightly belongs. (Conversation Logs are discussed in detail shortly.) You’ve helped your client avoid an embarrassing situation. Otherwise, months down the road he would discover that the building contractor was contractually obligated to provide the layout you were asked to perform. This kind of mistake happens often; it’s uncomfortable for everyone involved; it strains good relationships, and it’s avoidable.

Sometimes you’re buried in work when the calls for layout come. After a few minutes of digging through manila and white and not finding the contract (because it was misfiled in manila and white the last time you looked at it), you just schedule the work, expecting to check the contract when you find it sometime later. Later never comes, and you do the work only to discover at billing time that you have no agreement for the services. This places you in a very, very weak position.

## **Red – “Billing/Work Orders” folder**

Red folders are great for your billing and as a place to keep your work orders not yet billed. Why red? If you aren’t paid, your business will STOP. (Red means negative money amounts, which means stop.) Also, if you have plenty of work, your billing will be done late at night, when your eyes are red. Your clients will see red if you don’t provide documentation of authorizations for extra work. Red is great for billing.

## **Yellow – “Written Correspondence – Non E-mail” folder**

I don’t know how to say it any other way. Correspondence is a pissar (yellow). Usually in the construction layout business, you don’t get paid for your time spent corresponding, documenting and CYA’ing. Therefore, all my correspondence is filed in yellow folders except printouts of e-mail correspondence. With the advent of e-mail came large volumes of sort-of-written correspondence. Filing of this is covered shortly. I don’t put e-mail in my yellow folders.

Much success in the construction layout business is due to covering your a\_\_ with correspondence. You don’t *make* money with correspondence; you *keep* money through it.

Your gently and discretely phrased correspondence and documentation is taken by your client perhaps as over-zealous attention to detail (typical of surveying personalities) when you create and distribute your paper trail. But, should the time come when you and your client are at odds, the client will remember that you're a person who documents EVERYTHING, and if you say you have documentation of a phone call or a conversation or a direction given or a promise made, you mean it!

Never forget that wonderful saying, "The most faded ink has better memory than the sharpest of minds."

In a well-run construction layout business with competent people performing the layout, functioning within a consistent system of checks and redundancy, you'll seldom get into contentions with your clients. BUT... when you do, a good offence is the best defense. Your offence is your paper trails and documentation. These are easily retrievable, so you can quote dates and specifics, if they are filed in your yellow folders.

Yes, folders – plural. A very small business might get by with one yellow folder per project. Probably, you'll be better served by having more than one.

## **Yellow – “Transmittals & Cover Letters” folder**

I suggest a separate folder for Transmittal Letters and Cover Letters plus a spreadsheet-format log of supplementary data or information you receive from others, like plans, change orders, supplementary sketches, etc. This spreadsheet is a hand-written record of ANY sketches, plans or documents I receive that impact, clarify or change the work I perform on the project.

For example, if I'm at a construction site, and a superintendent gives me a copy of a sketch clarifying some missing dimensions on a structural plan, as soon as I get back to the office, that sketch is stamped with the date received and is filed with my plans. Often this new sketch is taped directly onto the old plan or bound into the plan set, and a bold notation in red at the affected area of the plan indicates the area of revision and references this sketch. Notations about the sketch go on the spreadsheet.

Copies of any digital drawings I may have or coordinate files are saved with their original name followed by the word "old" and the present date, and the digital files are then updated to reflect the sketch's impact. A note is added to the digital file to document the date and source of the change.

Now, that takes care of filing the sketch, noting its impact on the original paper plans and modifying the digital files. But, a hand-to-hand transmittal has taken place and plans updated which has not been documented in my correspondence files. Since no transmittal letter accompanied this sketch, a record of it goes on a form in the yellow transmittal file folder. This simple form is placed in the front of my folder to record receipt of the sketch and all other plan revisions, revised details, etc. The form (Figure 4) is shown next:





and know what you did in response to its impact. Of course, you will preface your comments with, “Well, let’s see. My records show that on (date), Joe Marber, your superintendent, gave me a sketch clarifying structural dimensions. We modified our plans per that sketch prior to staking.”

You found your record of that in seconds – no call back required, no fumbling through plans or waiting for the crew to return with them; no digging through heaps of manila and white. Instead, you went straight to your yellow folder marked “Transmittals,” ignoring all other colors, and lifted out your simple form always kept at the front of that folder.

Do you have any idea how seldom your client finds anyone as organized as yourself? You’ll be noticed and remembered.

## **Orange – “E-mail”**

If ever a category of correspondence deserved its own color, it’s e-mail! In my list of “technology that has compromised our quality of life,” e-mail ranks just beneath those pre-recorded telemarketing calls received during the dinner hour.

It’s amazing how e-mail has revolutionized society! In a few short years the young among us will not believe that before e-mail the subject lines of memos reflected the content of the memos – back in the days before the SEND and REPLY buttons existed; back when written communications were less frequent and more meaningful.

Instead of e-mail, back in the dark ages, envelopes were addressed and stamps licked, and people walked to the post office, or at least to the mailbox. Folks sometimes spoke to each other on the phone using real words, or occasionally even in person. Those who received these old-fashioned communications thought them important, and written communications were actually filed in project folders.

But, how times have changed! The lazy folks among us (not you or I, of course) can avoid having to place an e-mail address in the TO box by simply hitting the REPLY button, over and over and over, long after the subject line has lost all relevance to the body of the e-mail. So now, we have countless back-and-forth e-mails on evolving and differing subjects, all bearing the original subject line. Each e-mail must be read or at least scanned to learn the true nature of its content when this happens.

PLEASE, PLEASE, DON’T OVERUSE THE REPLY BUTTON! When you do reply to an e-mail, your communication should truly be a reply, not new business. Always make the subject line of e-mails announce what the e-mail is about. If you use the REPLY button to avoid the need to enter the recipient’s address, at least modify the subject line to fit the content of the new message.

Break the cycle! Create NEW e-mails whenever the subject matter changes. Hit the REPLY button only when actually replying to the matter in the subject line of an e-mail you’ve received. This way, the subject line will always reflect the content.

OK, OK! I admit it; we’ve hit a nerve in my pet-peeve funny bone. (Perhaps you noticed.) But, there’s a point to this tirade, maybe two points, namely:

- E-mail communications create special filing considerations not present in simpler times.

- E-mails are prolific and a royal pain in the filing system.

Should you print out *every* e-mail and file the paper copy? I say yes. At least in the construction layout business. If you generate or receive a lot of e-mail correspondence, it may be beneficial to use two e-mail folders for each project, one for the “not likely to ever be needed again” and one “for possible future reference.”

For example, suppose you have a large project and receive regular e-mail communications from your client on a variety of matters. In this case, you may wish to create separate e-mail files for scope issues, financial issues, ‘unfinished business’ issues, for questions that haven’t been answered (“out-due-back”) and the like. You might even need a TO DO e-mail folder so as not to lose sight of them. The possibilities are limitless, and herein lies the problem. So, beware! You could end up with something worse to manage than the confusion of having all the e-mails filed together in one folder.

Here’s the approach I use:

What to do with an e-mail that pertains specifically to billing? I file it in the red billing folder, not with general e-mail correspondence in the orange e-mail folder. How about an e-mail that modifies the contract? Attach it to the contract (filed in the blue folder) and maybe put a copy in the red billing folder, if billing is impacted. This copy serves as a reminder when billing time comes around.

What if a single e-mail from your client asks for clarification on last months billing and also instructs about tells you what offset distances to use for the building staking? Make three copies. File one copy of it in the red folder for billing and a second copy in the blue, contracts folder, since the specific services to be provided are always, by nature, “contract” matters. In this case, I’d not file the third copy with general e-mail correspondence, but I’d be sure to staple it to the copy of the contract kept in the field folder. When instructing the crew about the building staking assignment, I’d refer to that e-mail in their field folder.

E-mails that don’t fit nicely into any primary category generally just go in a catch-all, e-mail folder.

Finally, the reason I don’t just make a directory folder or folders in the computer’s e-mail program (probably a subdirectory such as “INBOX\projectname\...”) is that I can yellow hi-lite the important matters in the printed e-mails and make multiple copies to file in different folders.

How about saving some e-mails in the computer and others in paper folders? I’ve found that saving some in the computer and others on paper copies leaves me never knowing where to look for them later. For my money, printouts of e-mails work best – IF logically filed.

## **Classification – the KEY to learning!**

A teacher once said, “Classification is the key to learning.”

Classification is also the key to keeping your non-billable, overhead, and administrative costs under control. This section of the course is all about classification. By classifying your paperwork, and filing accordingly you accomplish several things:

Specific items are easy to find, even in large project files.

- Communications are more effective because they are not lost and forgotten. Classifying clearly when filing also makes paths in your memory, and less is forgotten.

- When the phone rings and you need to refer to a specific piece of correspondence, to your contract or previous billing, the relevant pieces of paper are at your fingertips in seconds.
- Frustration is reduced. You don't have to flip through page after page of items having nothing whatever to do with the thing you are trying to locate. Who among us doesn't hate large files full of everything under the sun? It's time-consuming, aggravating and wasteful to search through disorganized filing systems.

And so, classification is the key. Most people under-classify, simply because they have never developed their step-back-and-look-at-the-whole-picture skills. Most business activities fall into a few, routine classifications if you think about it. On the other hand, over-classification tips the scales, and you begin to lose what you've gained through classification. If there are too many filing options, it becomes confusing as to which place is appropriate for a given piece of correspondence.

## **Green – “Conversation Logs” folder**

I have pads of conversation logs made from a form of my own design printed on light green paper. In the green folder is a pad of these blank green forms along with all my filled-out Conversation Logs, torn off the pad and filed sequentially by date. This folder is not likely to become overly full, and you may ask why this isn't included with other correspondence in a yellow folder. Good question.

In the field, ANY conversations that provide direction or in any way could POSSIBLY need to be recalled in the future at a moment's notice are logged and filed in this folder. Any similar phone conversations are documented on the green form and filed. Crews are instructed to make a written log of any such conversations and are required to do this – absolutely no excuses are accepted for not doing so.

If these green, written records of conversations are ever misfiled, their green color will announce their presence in the wrong folder.

Because the conversation log green folder is seldom a large file, and since conversation logs are not mixed into files bursting with transmittal forms, e-mails, memos and such, they are instantly available. In the office, whenever the phone rings, a pad of blank conversation logs is nearby. Any verbal instruction or specific discussion related to a project is documented on a Conversation Log and placed in the project's green folder.

What is so important about this? Check the divorce rate. What does it tell you? Among other difficult realities in life, we must accept that human communication is full of misunderstanding and confusion. Our memory of what we've promised or been promised is flexible, forgetful and sometimes dishonest, even among friends.

When on the phone with a client, I've quickly located some conversation log that relates to our conversation. It was instantly recognizable by the sheet's unique color in my project files. Many, many times my part in a conversation has gone something like this:

“Yes, Joe, give me a second to find my... oh yes, here it is. Joe, I'm looking at my conversation log dated last Monday at 3:10 PM. Pete Quarsby of your office told Ken Fiddler, party chief, and I quote, 'Don't bother to lay out the dumpster pad. We will pull off the building and transformer pad and locate it ourselves.'”

In EVERY case, and there have been many – some of which might have led to disputes and hard feelings – the person on the other end of the phone offered no resistance to my report based on a conversation log that I read over the phone. I can't remember ever being asked to furnish a copy of the conversation log. Conversation logs frequently avert difficult situations, and always I've been able to locate the needed conversation log in a matter of seconds, usually while making some small talk as I locate it like, "Let me get my Conversation Log from my file, Tim. While I do, tell me, what's it like being a new father?"

In a few seconds, I have the paper in hand and scan it for what I'm after. Then, when Tim has finished bragging on his new baby I say, "Ah, yes. Here it is Tim. I'm holding a conversation log of my phone call with Jim Simmons on Friday, October 19<sup>th</sup> at 10:15AM in which he said, and I quote, 'We will authorize the staking of the dumpster pad as an extra.'"

It pays to know what is going on in your client's life – and to care. I really do care about my client, and a new baby or grandchild is important to my client. Therefore, at times like the one above, I always have something to ask so the other person is talking while I search my files. It pays to document your conversations and verbal instructions and agreements. But, it isn't enough to have the documentation "somewhere" in your files. Timing is everything! You are most convincing right at that moment when the problem is revealing itself. Be able to instantly pull your green Conversation Log from the green file folder and quote directly from it.

You may ask, if the file folder is green, why go to the trouble to make the conversation logs on green paper. If a conversation log should be misfiled, it will yell, "Green, green," at you from wherever it is located. It's visible, even when misfiled.

If you've never tried color-coding in this way or to this degree, its power will amaze you.

A simple Conversation Log (Figure 5a) is included below:

<b>Jon Terry Associates, Inc.</b> 888 Happy St. Perfectedville, PA 18888		<b>CONVERSATION LOG</b>	
PROJECT No. <u>PA 3270</u>	<input checked="" type="checkbox"/> INCOMING	<input type="checkbox"/> OUTGOING	
PROJ. NAME <u>LOT 7 BRIDGE</u>	<input type="checkbox"/> IN PERSON	<input type="checkbox"/>	
DAY <u>Tu</u> TIME <u>3:10pm</u>	SUBJECT: <u>S-1 DIMENSION QUEST.</u>		
DATE <u>9/7/05</u>			
WHO? <u>JT</u>	SPOKE WITH WHOM? <u>BILL SADDLERAY, PE</u>		
	OF: <u>HILDERGARTEN &amp; SPATH AIA</u>		
<b>DISCUSSED:</b>			
<u>APPARENT BAD DIM STRING - N. END BLDG.</u>			
<u>WILL FAX NEW DETAIL BY END OF DAY</u>			
<input type="checkbox"/> Continued on reverse			
<b>FOLLOW-UP REQUIRED:</b>		<b>RESOLVED / IMPACTS:</b>	
<u>CALL 1ST THING IN AM</u>		<u>AGREED - NEEDS REVISION</u>	
<u>IF NOT RECEIVED</u>		<u>WILL CORRECT</u>	
<u>TODAY.</u>			
<input checked="" type="checkbox"/> <u>CALL CLIENT TO EX-</u>			
<u>PLAIN DELAY IN STAKING</u>			
<u>FOUNDATION</u>			
<u>(DONE J.T. 3:15pm)</u>			
<input type="checkbox"/> Continued on reverse		<input type="checkbox"/> Continued on reverse	

Figure 5a



## Need more colors?

Colored folders come in other colors (like purple and pastel colors), should your needs for color-coded folders exceed the examples above. Of course, the truly less important filing can always be stored in standard, manila folders.

## The filing philosophy

My filing philosophy is this, and it's an important principle:

Create standard, *major* filing categories common to all projects of a given type (such as the system being discussed here). Once these primary categories are established, create additional folders *only* as dictated by how confusing your primary folders become with all that stuff in them.

Any filing system is made for man, not man for the filing system. Don't let the tail wag the dog. Make classification your faithful servant, but don't become the slave of over-classification. Your filing system must always remain your servant. It serves a critical purpose: allowing you to quickly find what you need.

If you under-classify, what you try to find is always mixed up with other stuff that's nothing like what you're looking for. If you over classify, you can never be sure which folder contains what you're looking for. If you classify appropriately, you always know in what folder you'll find what you're looking for. There is a bit of an art to this, and it requires stepping back from the daily grind and reflecting on your overall business activities. But, the rewards are in gaining a sense of control over the tyranny of paper work and administrative tasks.

Imaging that you're in a difficult conversation with your client Your credibility and maybe some money or even future work for this client is on the line, there's a big difference between you calling back after you've finally found what you're looking for and finding what you're after in a matter of seconds, enabling you to make an immediate response during that same phone call.

Having documentation at your fingertips for ready retrieval is your reward. Classify to that end, and with that purpose always in mind.

The scheme above has served me very, very well. I urge you to adapt it to suit your business; try it and see for yourself how freeing it is before you label me as anal-retentive!

## Safety

### Keep an eyeball in the back of your head

Have eyes in the back of your head. Know what's around you on the construction site. With all the noise that abounds on the site, keep tuned for the telltale signs and signals of change that alerts you to danger.



Vibrations on the ground (often causing the cross-hairs in the instrument to jiggle or your feet to tingle) may signal equipment approaching. Turn around frequently and reassess the dangers.

Be alert and stay alert; and stress to your crew the need to stay alert. Don't allow yourself or your crew to turn their backs on any potentially dangerous situation. Most situations are fluid on construction sites, and conditions can change radically in a matter of seconds.

Generally, when staking, the instrument person is facing the person setting stakes and visa versa. When facing each other and concentrating on your interactions, you are least able pay attention to any dangers behind your back. At such times, you are responsible for watching the other person's back and sounding the alarm when danger is present. Never, never joke about a danger or scare the other person for 'fun.' It could cost a life if your partner thinks you're kidding when you shout a word of true warning.

Take this seriously!

## **Mark your territory**

Set orange cones around your instrument to mark your territory. Keep equipment from getting too close to your setup. Even if your safety is not threatened by equipment coming close to your instrument, it may disturb the setup. Don't hog the tight space existing on most construction sites, but don't be shy about protecting your turf. You need room to work and room to be safe while doing it.

Look for potential dangers. Think in what ifs. For example, if your instrument is set up along side a tall row of construction materials that block a clear view of you from the other side, keep in mind that someone may push or load that material from the other side, and push it over on you or even run you over.

In just such a situation, I narrowly escaped probable death. I was running the total station when a tractor trailer loaded with huge rolls of reinforcing pulled on site and parked such that the mid-point of the trailer was a few feet from my back. The driver unsecured his load and headed for the office trailer, presumably to speak with the superintendent.

A forklift approached the truck on the opposite side from me. It was a noisy site, so I didn't hear it, and my view of the forklift was blocked by the trailer and its load. The forklift operator couldn't see me and didn't know how close to the edge of the trailer that roll of steel was. As he slid his forks under the roll on his side of the trailer, he pushed the roll on my side toward the edge of the trailer on my side. I heard the screeching noise of the steel on the bed of the trailer, turned and saw the roll coming toward me at the same instant I heard over my radio, "Run. Run!" I instinctively grabbed the instrument (not the wisest move) and ran from the trailer as the roll of steel mesh teetered at the edge of the trailer and then fell where I'd been standing.

If you must work alongside any stack of materials, before setting up your instrument set a row of guard stakes on the other side of the pile with flagging running between them. An equipment operator on the other side of the pile from where you are working must at least stop to consider before knocking the pile over on you.

An instrument or backsight left unattended on a construction site is equipment at risk of being destroyed. Mark as vividly as possible around your pieces of equipment. If you or your equipment will be in the vicinity of machinery in use, step up to its operator and respectfully ask if your equipment and personnel will be safe in that area and if the operator will be able to safely work around it. Most operators see this as a courtesy and are proud to personally assure you of their ability to protect your stuff. They are, in the process of agreeing to look out for your investment, bragging on their skill at controlling their machinery. Usually, they'll like you for asking and involving them in the responsibility. By involving them in your concerns, they may tell you about a truckload of something coming into the area where you'll be working later in the morning, and you'll be much better off knowing this ahead of time.

## **Skillful operators sometimes show off.**

While on the topic of equipment operators, let me be a bit redundant with another portion of this course. I've found it's important to set witness-stakes an adequate distance around primary control points. Have you ever returned to a site to see your control still in place, with black tire marks along the side of a hub? Or have you planned your layout from a particular control point only to arrive on the site and see the control point you intended to occupy along with its guard stake sitting on a tuft of undisturbed ground that's one foot in diameter and five feet high?

Equipment operators are often very, very skillful. They can brush the edge of your hub without destroying it or cut around your control point, leaving it standing five feet high on a finger of original earth pointing skyward. Of course, it's impossible to set an instrument over it, but it's there!

Equipment operators sometimes "preserve" your points while making them useless at the same time. Give important stakes a wide berth with extra guard stakes and flagging. Not only is your control point important to maintain; it's also necessary that you have room to occupy and work around it.

## **Cages in the van**

Have you ever seen what a SUV-type vehicle loaded with survey equipment looks like after hitting a tree at 35 miles per hour? I've seen tripod legs that penetrated through the back of the front seat. Pick-up trucks with an unprotected rear window are not much better, because the rear end of a vehicle that hits an object while moving forward jumps upward at the moment of impact, lifting equipment off the floor and shooting it through the back window. I just don't know why so many survey firms fail to install "cages" to keep equipment in place in the event of a collision. If it's within your power to make this modification to your vehicles, do it. Cages save lives. There is no excuse not to have them.

## **Never go beyond what you're trained for**

For years, before I knew better, I climbed into manholes to get pipe sizes and inverts. Now, I do know better. If you're not trained and equipped for any situation of risk, don't risk it. When it comes to hazardous waste sites or entering confined spaces, get the training and equipment or just don't do it. Sacrificing your life is noble for some causes. Gathering whatever information is

in some manhole is not a cause worth risking your life over. Many have died because they underestimated the danger.

## **The strange dichotomy - People in the most dangerous jobs often value life the least.**

Risk-takers take risks. It's an immutable principle. Often, people employed in risky occupations, enjoy the risks involved. The bustling construction site is an environment of risk. Be aware that the people working around you may not be as careful with your life as you are. Expect the unexpected, and do your best to not let others take risks with your life. If a crane operator thinks it's grand to pass a piece of steel over your head, you may want to move to another location until the risk has passed. You're not a steelworker after all.

Speaking of that, if a superintendent asks you to walk steel beams to check their elevations over a few columns, offer him the rod. Seriously, speaking of walking beams, while staking the driveway to a custom home under construction, a superintendent asked me to check the top of steel beam elevations. These beams were about 10 feet above the ground below and only about 6 inches wide. Because there was no advance notice of this request, I didn't have a ladder with me. A young assistant with me that day said he'd have no problem walking those beams. I stupidly allowed him to head out onto the beams.

As he headed off across a beam about four inches wide, my heart was in my mouth. I realized I'd made a mistake. But, fate smiled on me that day. I was more than impressed with the skill of this young man. He could have made more money, I'm sure, as a tightrope walker in the circus than on a survey crew. He walked those beams as casually as I walk a sidewalk. He did the job and didn't fall. To the superintendent I was a hero. (Or maybe it was my assistant.) My boss heard of this, and the hero-status was short lived. I deserved the dressing down I got for allowing an employee to walk those beams.

## **Know what you're expected to wear on the construction site**

Some sites are very lax regarding safety gear. On one site, you'll be thrown off if not wearing a hardhat and safety goggles, while at the next site, nobody on the site is wearing them – even those people at risk that should be out of common sense.

### **Hardhats**

If the site's posted as a hardhat area, but nobody on the site is wearing them, my advice is wear one anyway.

What kind of hardhat should you buy? I'm so glad you asked. Most people who don't know better think, "A hardhat is a hardhat." Ah, not so! Why do people hate wearing hardhats? Because they don't have the *right* hardhat.

A *good* hardhat adjusts to different head sizes with the twist of a knob. This type of suspension mechanism is, to my taste, the best, most comfortable choice for this essential piece of

equipment. On windy days, you twist that adjustment knob to make the hat stay put. Similarly, when you're leaning over something with your head upside down to mark a point, a twist of the knob tightens the hat so it doesn't fall down from where you're working. Another twist relaxes its grip on your head for stand-up work. You may wear a helmet liner some cold morning to keep warm and remove it later in the day when the sun is high in the sky. Just a twist changes the headband size to accommodate this change. If you've never worn a hardhat with such an adjuster, you just have to try it.

How about hardhat color? White reflects the sun's rays and is noticeably cooler in hot weather. To some degree, a dark hardhat will be warmer in cooler climates. One hat may not be enough to suit all occasions.

Some hardhats have a wide brim on the front, baseball-cap style, and must be worn backwards so as not to hit and disturb the instrument when looking through its scope. Some have a brim all the way around like a pith helmet. This is my favorite style, because it protects the tops of my ears and to some degree the back of my neck from sunburn. It tips backward on my head when looking through the instrument's scope. This pith helmet style is a little harder to find than the more common, front-brim style.

Attachments to keep you cool are available for hardhats. Hardhats with your favorite NFL team logo are available. An eagle and American flag design is, too.

## **Safety Glasses**

Most sites I've been on do not require the use of safety glasses. One site superintendent did tell me not to come back without safety glasses that wrapped around the side of the eye. I wear tri-focals. These are a pain when operating the instrument. With most instruments, I have to take them off to get a useful field of vision through the scope. Can you imagine trying to operate an instrument with safety glasses over tri-focals.

For most surveying or construction layout activities, safety glasses are of questionable benefit. Even so, I'd recommend that you have them with you. Sometimes, the superintendent knows that someone will be on the site that day looking at safety issues. In that case, wear them for the sake of the client.

Superintendents are normally very reasonable and understanding people. If you explain that you have to take safety glasses off every time you look through the scope, and that you'll be taking them on and off all day long, generally the superintendent will agree to not require the instrument operator wear them.

## **Boots**

One day, a superintendent told me that I'd not be allowed back on the site with my new-hire assistant dressed in shorts and running shoes. This was the lad's first day of employment, and I'd neglected to instruct him on what to wear to work.

Driving back to the office at the end of the day, I told my new employee he needed to wear work boots and long pants the next day. He said he didn't own any boots.

I said he'd have to buy work boots that night and wear them to work the next day. I explained that the superintendent would throw us off the site if he weren't dressed appropriately. Wearing work boots was a requirement of the client, not an option. And, it was altogether appropriate attire. I apologized for not telling him earlier, so he'd have what he needed to start work.

He said he didn't have the money to buy boots. I told him I'd be happy to advance him the funds.

"No, that's OK," he replied.

He never came back to work. Was it I, the work we do, or the boots?

## Safety Vests

Safety is of primary concern no matter what type of surveying services are performed. When surveying in the woods during the fall season, safety vests may keep you from being shot by hunters. The same vest may prevent your being run over when working in the middle of the road. That vest can also save you from being crushed at a construction site or struck by some object hanging from a crane. Don't think that because you and your crew are off the road and not in the woods, that wearing a safety vest is unnecessary. Being visible on the construction site is critical to your safety.

In the warmer climates, a bright orange tee shirt or other vibrant color may suffice. A similarly-colored jacket is a possibility in the cooler seasons.

While safety is the primary consideration, being easily spotted is something that makes the work flow more smoothly. How many times each day does the instrument person have to "find" the person doing the staking? It is so much easier when that person is clearly visible and distinguishable from the foreground, background and other workers.

## Ear Plugs

Some site locations are simply too loud to safely occupy without earplugs. These come in a variety of designs. They are cheap. Decades ago, I operated a chain saw for a few hours without ear protection. Since that day, when things get really quiet I hear ringing in my ears instead of blessed silence. I'm pretty much used to it, but as I write this and call attention to it, the ringing in my ears is louder than the whirring of my computer and a fan operating in the room.

Ear protection is perhaps the most neglected area of safety typically ignored by construction layout crews. Earplugs are so very inexpensive.

Sure, you need to communicate with crewmembers when performing construction layout. Earplugs don't prohibit this, although a little extra effort may be required.

My favorite style is a pair on a strap that allows them to be inserted or worn within easy reach hung around the neck. The actual part inserted that I like best looks like a triple-decker mushroom. The "stem" is used to push the three-tiered, sound-deadening portion into the ear.

I love the sounds of silence. I lost that for the rest of my life from just a short time of sound-abuse decades back. Enough said?

## Know your equipment operators

### Lull or Crane?

A “Lull” is a front-end loading, fork-lift-type thing with large rubber tires. It’s the brand or make of a piece of equipment used often by masonry contractors to lift tubs of mortar and pallets of blocks/bricks up to the scaffold where masons are constructing walls. Other trades use them to lift lumber, steel, sheetrock and other materials to upper floors. I don’t know what it is about the Lulls and their operators, but I’ve learned to fear them. Almost always, these machines are traveling too fast and too close for safety.

Often, Lull operators are junior, entry-level laborers who seem to like speed, and they appear oblivious to common courtesy and consideration of others.

On more than one occasion, I’ve had to tell them to slow down around my crew and me or I’ll report them to the superintendent and ask that they be removed from the site.

Then there are the crane operators. The bigger the crane, the more skillful the operators seem to be. They are wonderful. They know exactly where their equipment is and what it’s doing. I usually feel safe around cranes. One word of caution, though: often crane operators are being directed by someone who can see the load, someone who’s communicating by hand-signals and/or radio with the crane operator. This person, not the crane operator is truly directing the crane’s operation. If this is the case, be certain the person giving the crane operator directions can see you and knows you are there. This is another good example of why you should wear your bright and visible colors.

If you are on a large site, huge dump trucks or vehicles that scrape earth into their bellies may be moving fill from one location to another. These off-road monsters can really move! They not only speed, but they usually cause huge dust storms that billow in their wakes and cover you and your equipment with dust. These are harder to control without the authority of the superintendent, because their operators are passing you at speed, they are usually a rougher cut of individual, and they are frankly on a mission – to move earth quickly. Normally, if the situation is unsafe or unbearable, I will tell the superintendent that I can’t work under the circumstances and ask for suggestions. Sometimes the superintendent will tell the excavation contractor to use an alternate route while the construction layout activity is taking place.

### Daring or Caring?

Whether operators are daring or caring, skillful or willful, is something I try to determine each day on each site for each, individual operator. Some operators I turn my back on confidently; others I carefully observe when they get anywhere near me. It isn’t hard to spot the different temperaments, dispositions and aptitude levels “behind the wheel” of construction equipment.



## **Demon or Guardian Angel at the helm?**

Some equipment operators seem possessed. Others are like mothers with babies, caring for the welfare of others. Get to know the signals and learn to tell them apart. Your life could depend upon it.

## **Know your blasting signals (AND your blaster)**

What is that air horn? It doesn't sound like a steam engine or a truck.

If you see drilling rigs preparing for blasting activities, approach the people involved in the activity and ask when they expect to blast, how far away you need to be, what the warning sounds will be and how long between the warning horn and the explosion. This is important information. Sometimes, when the charge goes off, the earth appears to inhale and rumble and rise like a belly full of air. Other times rocks fly in the air and land some distance from the blast site.

These blasting folks know what to expect, and so should you. It is frustrating to have five minutes left on a setup and go running when the blasting is still ten minutes off. The reverse is worse. In my experience, the blasters don't do baby sitting. You are expected to know the signals and head for the hills. You may have to choose between closing out your backsight and saving you backside.

## **Trust your instincts & your intuition**

Finally, regarding safety (and probably everything else in life), TRUST YOUR INTUITION. If you feel concern, don't put it down without investigation. In some cases, when intuition is accompanied by a sense of urgency, just act on it. In time, you develop instincts suited to your environment. Construction sites are dynamic, changing, challenging environments. I think they're fun! But, stay alert. Stay alive.

## **Downtime Activities**

### **On-the-Road**

I once had a silly fantasy. Actually, I had it more than once as a teenager. In it, I had a job for a mattress and bedding store. My job was to crawl into a bed at the front of the store – you know, that showcase area of the store where people on the sidewalk can look through the glass and see a sampling of whatever the merchant thinks will draw people into the store.

Anyway, I would sleep there, in a bed in the showcase, and demonstrate how wonderful that mattress was. I'd actually be paid just for sleeping! The lazy-bug in me was quite captivated with that fantasy. What a silly idea. Someone paying me to sleep?

Some survey crews traveling to distant sites think they're being paid to sleep. I strongly disagree with this unindustrious notion. Do your crews think time spent traveling is "time-off work" for anyone not actually doing the driving? Enlighten them!



Does the field book need indexing for that day or prior days' work? Are there notes to be reduced, sketches to be made, cut sheets to be started? Are tack balls loaded with tacks? If space in the vehicle allows, are there stakes that could have flagging tied on them? Some firms have a policy that the party chief doesn't drive the vehicle. This is based on the assumption the party chief will review the file or set up the data collector or perform some other necessary function on the way to the job site. (Can't you hear the groans and the excuses forming?)

Persons riding in the vehicle are on the payroll and need to know they're expected to work at something – anything – that needs to be done, anything that *can* be done on the road. Sure, there may be times when there is really nothing productive that can be accomplished while riding a half-hour or more to the job site. But, when the crew comes to the point of viewing habitual nap times as a regular fringe benefit and arrives on the site without opening the job in the data collector, getting the paper field book set up, finding the list of available point numbers, looking at the plans or records to get a feel for how to approach the work, reviewing the scope and contract – well that's just plain lazy. Excuse me!?! Is there something odd in this philosophy? Does the term “work ethic” have meaning anymore? Has it become a bad word? Has goofing-off become noble?

Working in New York City near the former site of the World Trade Center, we were making a level-run between benchmarks. I set a turning point right next to a van parked at the curb. While the instrument person advanced to the next setup, I glanced over my shoulder, which was nearly touching the van's right-side mirror, and looked inside. The driver was sound asleep with his head tilted back against the drivers-door window, mouth hanging open and chest gently rising and falling, as he drew in long, deep, peaceful breaths. Lying across the bench seat behind the driver was another person, also sound asleep. My immediate thought was that they must be surveyors, and a sympathetic tinge of shame passed through me for our profession.

You can imagine my initial relief when I stepped back from the van to read the logo painted on its side and saw in huge letters, NYPD.

It may not be easy to build a team of workers who take their work seriously in a society that has lost its bearings, when those in power use their position to get out of responsibilities instead of to set good examples – but it's worth the effort to try. Truth is not a flexible commodity, though it's often ignored. Ethics, including the ‘work ethic’ once considered good and honorable, don't change either, since ethical standards rest on the foundation of Truth. Truth never changes with the times. And, there is still something in many people that *wants* to be inspired.

Sleeping when there's work to be done, when being paid to work, is just plain wrong. Get this across to the crews; inspire them to nobler pursuits if you can; and furnish a sample list of what can be done when riding to and from the site.

## **Between assignments or during bad weather**

There are days when there's simply no project to go to or when it's raining or snowing outside. In those occasional lulls between calls for layout, or during inclement weather, managers often think it's unprofitable to get bogged down with unbillable, administrative time. Think again.

Time that's *unbillable*, needn't be *unprofitable*. Remember, profit is a bottom-line word, not necessarily a word to describe the task being performed at a given moment. Some unbillable tasks *must* be performed as a housekeeping function of any business. No amount of careful management can eliminate such tasks.

However, what is subject to the control of wise management is **WHEN** these tasks are performed. Profits increase if these chores are saved for between-job times or for days of inclement weather.

When the billable project workload is heavy, this is not the time to be adjusting equipment or making a trip to the mill for stakes. Crews standing around with hands in pockets during down-times is equally senseless. Equipment should be checked and adjusted not on a fixed date, like the first Monday of every month, but on a flexible schedule. For example, some firms perform the check-and-adjust-equipment function on the first bad-weather day of the month, but not more often than every three weeks, unless the equipment declares its need before that time.

A list of chores to be completed during down-times should be posted in a place where crews congregate. The crew members should be told to review that list during any and all significant down-times and to perform something on the list or come to a supervisor and ask for work when everything on the list is completed. Certain personnel should be the ones "qualified" for certain tasks such as equipment adjustment. Obviously, you don't want the new-hire adjusting the cross hairs of the total station.

Here is a starter-list of chores to be done during down-times:

- filing and indexing of records, maps, field books and such
- cleaning out/washing/servicing survey vehicles
- servicing of survey vehicles (Quick-lube establishments or tire and muffler shops can probably perform routine service without advance scheduling. It's raining and the truck is due for an oil change? Why have it out of service on some sunny day?)
- organizing, updating the inventory of consumables
- ordering consumables (Some firms require that each and every purchase have a Purchase Order signed by the owner. The person who heads surveying or construction layout operations should have established purchasing privileges with reasonable limits as should every party chief.)
- equipment checking and adjustment (List and uniquely identify each piece of equipment needing periodic adjustment, even prism poles and tribrachs. This way even short breaks in the work can be used productively. Perhaps prism pole #3 was the only one adjusted during a short break while the party chief transferred a coordinate file to the data collector. But, JT's initials are there on the checklist next to prism pole #3 along with today's date. What could be clearer? This is better than JT sitting in the truck waiting for the party chief.)
- inventorying supplies and equipment
- numbering pages of new, blank, bound field book pages

- mission planning and network planning for GPS observations
- advance work on projects you *expect* or *hope* to get (This beats doing nothing at all. At the very least, it's practice.)
- computer file housekeeping
- picking up stakes and monuments
- buying and replenishing consumables
- organizing the equipment room
- practice for newbies holding a plumb bob accurately and steadily
- practice for newbies holding a prism pole plumb and steady
- instructing the newbie on how to set up an instrument
- practice for the newbie setting up an instrument
- practice measuring with steel tape and plumb bob
- pacing practice and contests (space permitting)
- lunch for the field crews on the boss's tab
- a newbie class taught by a party chief

Make down-time profitable indirectly through meaningful chores and activities. Get the crews used to working at something instead of hanging around. Consider little incentives like, the newbie gets a five-dollar gift certificate to McDonald's when training module #1 is completed with a grade of 85% or more is achieved on module #1's test. A grade of 90% or higher on modules #1, 2 and 3 earns a \$20 gift card to Home Depot.

## Training

The last item in the bulleted list and the last paragraph above lead us naturally to the topic of *training*. Training is another overlooked downtime function that will increase profits. Young members of the crew can study data collection methods, memorize point descriptions (feature codes), or study prepared materials with some method to assess what has been learned, such as a quiz or test.

Field personnel often benefit from just watching what office people go through while processing their data and making finished maps and plans. Modern data collection capabilities require greater computer literacy and more complex thinking than earlier methods, and many field people think the office staff is simply loading up their own work on the field parties, so the work in the office is easier. Think of the benefits if the field crew could really appreciate that a few seconds of sloppiness and lack of attention on their part repeatedly costs a quarter or half hour of office time.

Many firms are afraid to let anyone but equipment suppliers adjust cross-hairs. Some people are simply brutes and can damage delicate equipment by over tightening. But, you know who they

are in your firm. Why not train the gentler, more sensitive types to maintain and check your instruments? And, all permanent employees who work in the field should know how to adjust tribrachs and prism poles.

One way or another, a modern surveying firm has a training budget, either a recognized, planned approach to training or the all-too-common, invisible one – time wasted day after day, week after week, and year-after-year for lack of training. You decide. You pay either way. This is a law of nature, like gravity. Learn to explore its benefits.

Purchase or create, and USE, training materials that provide some means of measuring progress (timing expected to study various units, tests, etc.). Make certain that accountability is built into the process. A little work performed by your more capable personnel to develop/assemble study materials, which can be done during down-times, will produce study material that can be used over and over again for years with little additional input.

Remember, that newbie standing around talking about sports to the people performing the more skilled work (like equipment adjustments), is learning nothing, distracting those who know what to do and encouraging mistakes and lack of completion through distractions. It's better that this non-productive, chatty person be isolated with some study materials and expected to learn something new. That's why this person is being paid instead of being sent home for the day.

### **“It's not my job!” – Training the team as a team.**

In our competitive times, success depends upon your business being a well-oiled machine. In other words, it should run without friction as its many (or even a few) members function without resistance and ‘squealing’ in their respective roles. Each member of your team is dependent upon the others in order to have their own role fulfilled. In a true team-environment, the work becomes enjoyable.

Routine chores should be assigned to SPECIFIC individuals so that a sense of responsibility is given to the person assigned a task. Failure to do the task should be addressed. Repeated failure to meet an assigned responsibility must be corrected.

When routine and necessary functions are left to chance, you just don't get that well-oiled performance. Everybody expects someone else to take the initiative. Human nature says, “Let someone else do it.” Some employees may even heckle those who do take individual initiative.

If ever the phrase is heard, “It's not my job,” it's usually an indicator of trouble in the camp. Everyone needs to know whose job it is to do the regular chores and still be willing to pitch in and do the other person's job when that person is for some reason unable to do it. This is what a team's about. It doesn't just happen. It requires training, and not all training is about technical matters; people need to be trained and mentored to function as a team.

## **Preparation for Staking**

Now we come to the actual layout activities and the computations needed for layout. The needs of every project are similar but different. The person or persons using the control you stake should be consulted regarding what they want and need. In any case, the items to be staked must

be related to each other in some fixed grid of coordinates that relate to points on the earth, usually the parcel boundaries.

## The Geometric Plan

This Geometric Plan is discussed earlier in the section covering proposals, and later under *Typical Requirement for Construction Layout*. A very brief review: In earlier times, final site/design plans were developed often without any coordinate geometry calculations having been performed. Plans were hand-drawn and dimensions from boundary line to proposed improvements were often scaled from boundary lines that were not drawn to scale. In those days, the first thing to do when awarded a contract for construction staking was generate a coordinated, geometric plan, TO SCALE – in other words, establish north and east coordinate values for features to be staked and actually plot them. In the mid 1980's, many firms were using COGO (coordinate geometry, usually DOS based programs to compute the coordinates) and plotting these by hand, and it was a time consuming process. In today's world, it would be uncommon not to have as a starting point for construction layout a CADD file, often a .dwg or .dxf file.

Many designers providing a digital file of their design will require a licensing agreement or disclaimer prior to releasing their file. Some may even require a fee for their trouble. Fees charged for the release of recent designs seem to be disappearing as do licensing agreements, but normally its worth paying the plan originator a nuisance fee rather than starting over to create a geometric plan from paper plots.

If you are not the surveyor who performed the boundary survey upon which the project is based, you need to disclaim clearly in writing, best done in your proposal, that you are not resurveying the boundary or certifying its accuracy. This is covered in detail elsewhere in this course.

Almost always, except in very large tracts being only partially developed, the property and/or phase boundary is the outer geometric constraint within which all development must fit. So, the physical evidence of the boundary needs to be located in the field and the dimensional constraints of the design drawings fit to that evidence. It is best to develop a geometric plan with critical coordinates computed and plotted prior to staking any features for construction. If you are pressed for time and fail to do this, it is possible that you will verify, for example, that the building fits on the site within the area allowed per the plan's zoning setback lines (sometimes called building lines of yards), but later determine that the parking areas don't fit, and that it would have been necessary to move the building slightly to make all construction fit in areas permissible for construction.

Technically or legally speaking, this determination may not be your responsibility. That every improvement should fit within setbacks really should have been verified by the site designer (architect or engineer, or sometimes surveyor) long ago. But, you can avoid the "blame game" that is so common in construction layout squabbles by notifying the team of problems before they become costly by creating your geometric plan up front and early. If you leave the computation of coordinates for each item to be staked until a call comes ordering that staking, you discover problems at a time sure to cause delays and embarrass somebody.

## Revisions you make to the design

Because of my experience as a site planner/designer and my computational genius (really, inflated ego), early in my professional career I made small adjustments to design drawings when I thought that my idea was better than the designers' were. (The bible warns that pride goeth before destruction, and this haughty attitude brought me some scrapes and bruises.)

Once, because of a hand-drawn, out-of-scale boundary on a site plan, a building I had to lay out didn't fit on the site without some rotation to keep it out of the building setbacks. To the best of my memory, I rotated it three or four degrees and set the parking and drives with their drainage structures to the orientation of the building.

I'm now embarrassed to confess that back then, I did this without the approval of either the architect or the site designer. The short story here is that the building was a mosque, and its position on the site had been designed to face Mecca, a fact of which I was totally ignorant. After it was built, I was called to the site to perform celestial observations and publish the as-built, astronomic bearing of its sidewall.

The astronomic bearing of WHAT? I'd never heard of such a thing. I asked why this was needed. Only then did I learn why my slight building rotation to "improve" the plans and keep the project moving was downright foolish behavior. Nothing disastrous came of my unauthorized change to the plan, but I sweated it for some months, wondering if the axe would fall. The plan I was given was out of scale to the point of being unworkable, a fact I discovered creating a geometric plan. But, I should have called the civil engineer who created the site plan and coordinated a solution with the professional who knew what constrained the design.

Another time, about eleven o'clock one evening, I was preparing to stake some curbing first thing the following morning. I noticed that the parking area would drain better if I increased the slope of the adjacent parking by lowering the nose of a curbing island. So, I changed the elevation at the nose of that island when I laid it out the next day.

The curbing was shown on a grading and drainage plan for that job, and the sanitary sewer was shown on its own plan. I did not review the sanitary plans prior to making this change. Therefore, I didn't notice that on those other drawings in the plan set, a sanitary manhole was proposed about three feet from the nose of the parking island I had lowered a few inches to improve surface drainage. This "improvement" of mine to the design cost me nearly a thousand dollars, and at that, I got off cheap. I had to pay the costs of ripping out the curbing and reinstalling it as per the design so that the curbing would fit to the grade of the sanitary manhole rim.

A little knowledge is a dangerous thing! In this example, I failed to consider the full plans for starters. Then, I failed to recognize the expertise of the other team members, specifically the design engineer. Had I sought approval for my "improvement," I would have been saved the backcharge and most of the embarrassment.

It's not easy for me to relate these stories. But, if my experiences can save you from being as prideful and stupid as I was, then relating these true stories is worth the exposure. I could have



related the same information in some hypothetical fashion, but nothing has the power of a true story.

## **On being a “team player” – Never fly solo!**

Its important to note that neither of these two, true stories just related represents either errors or omissions. They illustrate the result of ignorance, pride and a failure to recognize my place on the team and to show proper respect for other professionals.

I learned through these two episodes that one must never make corrections or improvements to plans without the blessing and documented consent of the professional who prepared the plans. The architects, engineers or other professionals on the team know things I don't know about why the plans were designed as they were.

I've met people who err on the other end of the spectrum – those who will just stake something they believe to be in error, taking the attitude that the one providing layout is only responsible to stake per the plans, and if it's wrong, the designer will have to take the fall. This is not being a team player either. Before long, a person with this attitude won't be on the team at all. There is no place for an independent and uncaring attitude on any team.

It's good to remember that there are two faces to independence. One is essentially caring, yet ignorant (as in my case – really trying to better the product but without consulting the designer). The other is uncaring (the person who will just stake a design, thinking it to be inferior or even in error, reasoning that the axe will fall on another's neck). These are two sides of an ugly coin. Independence is a currency of negative value on the construction team.

## **Digital Drawings and Data**

In our time, with a few rare exceptions, any project drawings of consequence are produced on computers, and you will likely be provided with digital files.

Some firms require you to sign a disclaimer intended to shield the plans' author from your misuse of the plan. Some disclaimers would seem to make you responsible for verifying all their data. It's a legal question how much liability can be passed to the layout professional through signing a designer's disclaimer. Occasionally a licensing statement will appear on the digital drawing. A few firms require a fee to cover the cost of their efforts – or maybe just to make a buck. I don't see this as much as I once did, especially when drawings are shared to move a current project forward.

Most firms readily provide digital design drawings in AutoCAD or MicroStation format (\*.dwg/\*.dxf -or- \*.dgn) to work from. Most firms designing in the MicroStation \*.dgn format will save their drawing in AutoCAD \*.dwg format or \*.dxf format if asked. Some firms have associated LDD/LDT project files or file formats created with other software. Usually, you should obtain files compatible with you own software if it's possible for the provider to save their digital files to your format. It's always worth asking. Don't assume the designers can't save to your format. A lot of duplicate work is involved if you can't get the data in a format compatible with your software.



At the very least, request an ASCII file of the coordinates for the boundary points, any control traverse placed on or near the site and any critical points controlling proposed improvements such as wetlands, easements, building placement, pavement centerlines, parking corners, etc. These coordinates can be generated in the designers CADD product very quickly. Pay for them if you need to, and save yourself both the unnecessary exposure to liability and the time (money) it will take you to develop those primary coordinates from scratch. If you take this approach plot your product and lay it over a final plan on a light table (or taped to a large window) to verify no visible deviation from the design has been created by your computations.

## **To believe or not to believe – That is the digital question. (Answer: Don't you *dare* believe!)**

Always verify that the line work in a digital drawing matches the dimensions provided on the plans that specify actual spacing between improvements and other controls. Some plans contain 3D objects and polylines. Even lines may have elevations associated with them. Many times manholes and other proposed and existing features will be placed in the drawing with elevations.

In prior, 2D times, CADD drawings were essentially 2D products. Back then, all distances between the drawings' objects were horizontal distances.

Not necessarily so today. This means that distances queried between pick-points on features in the drawing file may report vertical distances between those elements and not the desired horizontal distances. Such differences may not be immediately apparent in the distances you list if the difference in the elevations of the objects queried is not significantly different. Be VERY careful, as some objects may be two-dimensional while others have non-zero elevations associated with them. Always list the objects' properties to determine if they are 2D or 3D. Never just assume they are 2D. Labeled dimensions will usually govern over distances between the graphic elements in the drawing. Unfortunately, some CADD graphics, whether 2D or 3D, are not dimensionally "pure." That is, the objects that display as graphics are not drawn to scale, or they've been corrupted. When any doubt exists, ask the maker of the plans which should control – labeled dimensions or CADD objects. Never assume the designer's intent if it is less than crystal clear.

Another common problem is that designers unfamiliar with the need to not move or rotate the drawing may have moved the drawing off the points associated with the boundary or other control. If the designer furnishes coordinates for proposed improvements, they may not relate exactly to coordinates derived from the original survey. Large shifts of this kind will be apparent. Beware of the little shifts that don't appear to the eye. Verify that your drawings and all coordinates you may have been given do, in fact, agree.

This verification of digital CADD data and listed coordinates is absolutely critical to perform at the beginning of the construction layout phase.

## Architectural and Structural Drawings

Personally, I rarely request digital Structural/Architectural drawings. I always use paper drawings after verifying with the designer that the plan set I've been given is the latest version available and is truly "for construction." Even experienced construction management clients have given me outdated plans. This has happened repeatedly. It is amazing how often I've even received superseded plans, even to stake buildings from. It's unbelievable how dense construction layout clients can be about this. Make the extra effort to verify that your plans are absolutely the most recent, current, for construction, plans. Then, document the assurance you've been given in writing, in a CYA memo. More on this near the end of this course.

Most site plans are conceived while the principle structures are still under design. Thus, the buildings shown on site plans are often not the exact buildings to be constructed. Always stake the building footprint and columns based on the architectural or structural plans. Never, never assume the footprints of the buildings shown on site plans are correct or final.

Whenever possible, get your plans directly from the architect and/or structural engineer. Verify that they are indeed "final" plans and are "for construction." Even if you must get your plans from your client, call the architect and structural engineer and verify that the plans you have are the latest and the final plans. Write CYA memos stating the name of the person or persons who provided the latest plans, the date, time and place of the conversation or meeting or method of delivery, and the latest revision date and specific title and sheet number of every plan you've been furnished to lay out the building. At a minimum, copy the architect, the structural engineer, the civil engineer, the contractor who will construct the building and your client.

On a recent project, I did have both paper and digital versions of structural drawings for a very expensive, structurally complex, immense residence. The plans were drawn purposely out of scale to illustrate a very slight offset in one column line from another. If drawn to scale, the plan would have visually portrayed one continuous column line, so the AutoCAD drafter separated the two lines for graphic clarity, thus destroying the dimensional integrity of the digital product. The paper plans were made graphically clear at the expense of the digital data. I suspected this to be the case, but called to verify this was true and documented my conversation. Be very, very careful. When in doubt, ask. In fact, when you feel confident that you know what is going on, as in this example, ASK! Beware of assumptions.

Was it a bad decision on the part of the structural engineer or structural draftsman to corrupt the dimensional integrity of the CADD product for the sake of the visual clarity of the paper plans? No, I don't think so. But, it surely would have been a bad decision on my part to trust the digital product without verifying that its graphic elements should yield to labeled dimensions on the paper plans.

I never use just the architect's or structural engineer's digital drawing for construction layout. Signed and sealed paper drawings are still the basic authority regarding the professionals' design. Digital drawings are shared generously in our time, and those of us who spend countless hours in CADD drawings sometimes forget that paper prevails.

Almost always, paper plans bearing the professional's seal are the authority when I'm creating my geometric plans for staking. Be careful if using digital files. They are a tremendous convenience, but they're potentially dangerous if used without proper analysis and verification.

Some providers take the attitude that they'll stake buildings only from structural drawings, and that they have no need to obtain, much less review, architectural drawings or compare them with the structural drawings. The fact is, often the two do not agree perfectly regarding common dimensions. In addition, it is not always the structural drawings that prevail over architectural drawings, as I've heard some surveyors state confidently in their ignorance. Often, too, architectural and/or structural plans lack dimensional integrity or omit critical dimensions.

Never assume the value of dimensions that are not clearly labeled on the plans or that cannot be verified by comparing the sum of individual dimensions to the overall, total dimensions. I always check strings of critical, intermediate dimensions to verify that their sum equals overall dimensions. Redundancy is crucial to verification. Believe me when I say that, often missing dimensions indicate some critical component of the design has not yet been determined. Don't assume column spacing is uniform if one dimension in a string of dimensions is missing. Never, never, NEVER fill in the blanks with your logical assumptions. Let the design professionals who made the plans do it.

Sometimes the architect is waiting on the structural engineer's determination, and other times the situation may be reversed. This is often the reason for missing dimensions on so-called "final" plans.

Some providers will not even look at the individual strings of dimensions and only stake per the overall dimensions. They think that raising the flag is unimportant when intermediate dimensions don't agree with overall dimensions or when there aren't enough redundant dimensions for verification. This may work when staking the "box" for a simple, residential home, but never take that attitude when staking commercial buildings or buildings of any significant complexity or size or even residences large enough to have column lines named and dimensioned.

Finally, I must impress upon you the countless number of times I've discovered errors in the plans that could have resulted in stakeout errors and construction errors. Would I have been liable? Most times, no – provided the plan error was not glaring, and if I did not fill in some missing dimension with my assumption. But, the project would have suffered in some way if I had not raised the flag in the form of a question – a request for clarification or confirmation.

## Site Development Plans

On site plans, in most cases, the line work of the digital file is drawn to scale. Exceptions and things-to-watch are noted above. If a parking lot is labeled as being 65 feet wide, the lines representing its edges will usually be found to be parallel and 65.00 feet apart. BUT... not always! Be careful.

A danger in the digital world that didn't present itself in the paper world of the bygone, DOS/cogo era is that a non-technical person can now effortlessly and mindlessly generate coordinates used to stake improvements by merely "picking" points on the line work and the symbols in the digital file. This is extremely fast and can be equally dangerous. A thorough

knowledge of the old cogo calculations seems unnecessary anymore. SEEMS unnecessary! Today, cogo calculations can be accomplished by most survey software packages functioning in a graphic, CADD environment. Be sure your technical help knows how to use this power responsibly.

For example, non-professional, inexperienced personnel may “pick” a coordinate at the corner of a parking lot or at the insertion point of a manhole in a CADD product and establish coordinates in mere seconds based solely on the graphic positions of features. A digital representation of something may be a foot or two or even more off in the digital drawing file without being noticed. Zooming in and out of the CADD drawing destroys the sense of scale that one has when viewing a paper drawing. If you allow a CADD person who is not familiar with the your discipline to generate coordinates used for layout, a graphic error of several feet may not be discovered until the as-built survey is drafted. Horrors!

Assigning inexperienced personnel to create today’s version of the geometric plan is, in my opinion, both reckless and irresponsible. My advice is that more experienced personnel perform the task of generating coordinates for the layout. In today’s competitive environment, the level of checking that was common practice 40 years ago has all but vanished. Final plans are regularly published with errors, and that’s how it is.

It has become common practice that computations to establish coordinates for layout often not checked. One business owner/surveyor fired a senior surveyor for staking catch basins wrong on a subdivision roadway. That unfortunate surveyor who lost his job had computed the layout at the end of a 14-hour day, and the surveyor/owner did not check his work. Work that is not checked will occasionally have errors, no matter what caliber of person does the computing. You decide (and take personal responsibility) for whether or not you check the work of subordinates, or of whether anyone checks *your* computations. It’s a business/risk-management decision. Unlike the surveyor/owner in this illustration, take responsibility for your decisions.

Since you as a layout professional may be the last eyes to see a design before it presents itself in three dimensions, it’s always wise to have experienced eyes and intuitive minds creating the coordinates from which staking is performed. To think of this function as just the mindless task of popping coordinates into the digital product by “picking” objects in the drawing is a dangerous viewpoint to hold.

The person establishing coordinates for construction layout may be the last line of defense against errors NOT discovered prior to construction. This is a noble role. Don’t assign it to an inexperienced person. And, check the work of even your experienced personnel – unless you are willing to assume the risk of not checking.

We live in a difficult time. When I began my surveying career in the mid-sixties, EVERYTHING was checked. That was the typical, professional way. And, that is how it still should be. Sadly, that’s not how it is. Professionalism has bowed to pragmatism; the pure character of ethics has been imprisoned by the tyranny of budgets; and what ought-to-be has been crushed under the feet of what-works. Result? Plans have errors, lots of them.

## So, you discover errors in the plans.

No design professional with good sense will resent your humbly presented inquiry about lacking, confusing or apparently erroneous data on his or her plans. Corrections to paper or digital plans are inexpensive compared to problems that go unnoticed until they appear on the site as new construction.

It is beyond the scope of this session to cover this fully, but a few suggestions will convey essential principles and alert you to common pitfalls.

- Trust nothing but redundancy – Always look for two or preferably three things to confirm dimensional agreement. This applies to site design drawings as well as architectural and structural drawings.
- Make personal calls for clarification when something looks wrong or suspicious – When something looks ‘funny’ call the document’s author/designer. Humbly request clarification for interpretation of the plans. Many times some other plan in the plan set provides the clarity, and you just didn’t know where to look. Other times, you’ve discovered something wrong on the plans. This doesn’t make you a hero any more than it makes the designer incompetent. Humans make mistakes, and your turn is coming. Whatsoever you sow, that shall you also reap. Thank the person who erred for helping you figure out the question. They know they erred; you needn’t point that out to them.
- Put the resolution in writing – AFTER you’ve worked out the solution in a personal, friendly call, THEN draft a C.Y.A. e-mail or memo that goes something like this:

*Dear Bill,*

*Thank you for clarifying my dimensional question regarding the distance between Column 1A and 2A on Sheet S-3 dated \_\_\_\_\_, and revised \_\_\_\_\_.*

*This is my understanding of your direction: The overall dimension string is correct per the plan and I am to change the distance noted above to 30’6”, not use the 30’0” dimension shown on the plan. Please advise immediately if I’ve misunderstood anything, as we will be staking this for construction tomorrow.*

*Again, Bill, I appreciate your rapid response to my question.*

*Sincerely,*

*Jonathan Terry, PLS*

This should always be the tone of your letters, e-mails and CYA memos. You’ve stated the source of the error, should it ever come to a battle. You’ve cleared yourself of blame, placed responsibility for your direction on the designer and made a friend in the process. Who could ask for more?

## Never stake a building from a site plan – or stake *anything* from an OLD plan.

OK, you know this. I've said it before. But just in case your 10 year old has stolen this and has just started reading it by flashlight under the covers, let me re-state the warning:

*Never stake a building or any significant improvement from a plan created primarily for another purpose or a general purpose.*

For example, site development plans depict the building, sometimes with dimensions, but that is not the main purpose of site plans. Architectural and structural plans are created for the express purpose of the building construction, and they must be used to determine building dimensions and data.

Sometimes both the architect's site or first-floor plan and the engineer's site plans show different views of proposed improvements close to the building. When shown on both plans, I suggest asking both designers for clarification on whose plans govern in that area. If they don't agree and give the same answer, put them together in a conference call with you to resolve the issue.

This is one example of why I consider it foolish to layout buildings only per the structural plans, as some surveyors will state. This is a bad policy. I always compare architectural plans with both site plans and structural plans. Many, many errors have been caught prior to construction by doing this.

Often, the site development folks have not been given the current architectural/structural plans, which are being developed concurrently. Architectural plans change as the structural design is refined. Sometimes, an architect's aesthetic interests result in changes to the structural plans. Designs change after bid sets are released. Nothing is stable. The change-it-demon is out to get you!

Principle: Everything changes and nobody tells the others on the team about it.

Principle: You have an old plan. Didn't anybody tell you it's changed?

I suggest a periodic mailing to your client via snail-mail. (NOT e-mail – that most unread, unheeded confusing convenience in communication since the Tower of Babel, and that promises to spell the downfall of modern society).

My client's project managers and project superintendents receive a memo in the mail saying, "Remember – it doesn't get built according to the most recent plan; it gets built according to *MY* plan!"

I follow this by noting, "I am about to stake \_\_\_\_\_ per plans you supplied on \_\_\_\_\_, dated \_\_\_\_\_. If these are NOT the most recent plans, or if there have been any supplemental plans affecting the layout, please advise me immediately, so I can adjust my computations and layout to conform to any changes.



Don't underestimate the need to CYA regarding the building layout. Buildings are expensive! Stay clear of the blame-game when it comes to building layout. Document everything you can in writing. And, check your computations very, very carefully.

## **Never-never land – things to avoid (and to remember)**

### **Never underestimate the task**

A “simple” layout request may turn to an ultimate challenge once the crew hits the site. Construction sites are dynamic, always-changing environments. Control points get destroyed; sight lines get blocked and layout needs change constantly.

### **Never send the “junior” crew**

Send your most detail-oriented, competent, personable, flexible, thorough, cool-under-pressure, business minded, emotionally mature personnel to do construction layout, and send them prepared with an uploaded collector capable of computing in the field. The days are gone when a sheet of paper with presumed instrument set-up points, backsights and angles-to-turn will suffice for most layout needs. Your client will think you a dinosaur if you send crews out so ill prepared.

Often I've heard surveyors say, “I don't want my field crew to do too much thinking out there.” I heard it the week prior to preparing a portion of this course. I've worked for firms whose owners abide by that philosophy. Their field crews translate this to mean, “I don't trust your judgment and capabilities.” A survey crew incompetent to function professionally should not be sent on a construction layout assignment. Period.

### **Never under-equip the crew**

A layout person lacking the equipment necessary to perform the job is as insufferable on a construction site as a carpenter without a hammer or an equipment operator sitting around because his fuel tank is empty. No amount of excuses will win the admiration of the people you disappoint. Equipment needs are discussed elsewhere in this course. Suffice it to say that your client has no patience with subcontractors who under-equip their personnel.

### **Never rush the crew**

Some managers are in the habit of thinking work should always go smoothly and be completed in a minimum of time. Their crews often hear, “This will be simple; you should be done with this assignment and move on to another other job right after lunch.”

This is not a winning strategy when it comes to construction layout (if it works anywhere else!?!). The construction site is a noisy, sometimes dangerous environment. Placing the person responsible for the layout under unnecessary, additional pressure will eventually lead to costly errors and maybe injury or death. A rushed mind is not a clear mind. A person who is not present to the task at hand but instead is feeling rushed, whose mind is churning with images of the boss's displeasure over taking too long, is a self-fulfilling prophecy waiting to happen.



A word on errors – Errors are the construction layout provider’s nightmare. On the construction site, errors seldom go undiscovered. If a person is breathing and active, he or she WILL make errors – unless that person is like the owner of a firm I once worked for. That company was in its second generation, and the current owner honestly believed and clearly stated that neither he nor his retired relative who founded the business several decades earlier, EVER made a mistake. (Honest!) The employees of this firm were placed in a constant atmosphere of tension, waiting for their inevitable human failing and the abusive tirades this owner dumped on the unfortunate souls who erred.

This created a climate of pressure that emotionally distracted his employees and sometimes made them frantic. ‘Frantic’ has no place in the layout crew. Methodical, unhurried and confident staff is what’s needed.

You may have guessed it: that business owner was a surveyor. Surveyors can become quite lost in their own view of life. (I know. I am one.)

Contractors know better. They know errors occur, and they are generally more tolerant of fallible humanity than those engineering-surveying personalities who spend lots of time in theoretical realms. Even though contractors and construction managers are immersed in practical realities, and readily forgive human errors, you will probably have to pay for your errors. So, you may as well create a climate that minimizes them. Specifically, my advice is this: never put your employees under pressure when they are headed for the construction site.

A preacher once said, “All pressure is violence, and all violence comes from the devil.” Do your employees see you in their dreams adorned with horns or a halo? You may chuckle, but this is a serious question. Its answer has certain and inescapable consequences, good or bad. It’s just a matter of time.

## **Never underestimate the liability**

When errors do occur, you or your firm will be back-charged for the costs occasioned by the error. In the course of my own construction layout business, occasionally a call came to my office. “Something seems to be wrong with your layout. Can you come take a look?”

Nothing, absolutely NOTHING received a higher priority than such a call. I would say something like, “OK. I’m on a job about 45 minutes away. I’ll shut down here immediately and be at your site within the hour.”

If it turned out to be an error I’d made, which thankfully it seldom did, the consequences would increase with time. Equipment could be standing around or some subcontractor might proceed along with construction knowing that anything built wrong would create an extra fee for them to cover demolition and reconstruction (which they’d approach at their leisure), and I’d pay the tab – often a padded tab.

Generally, whatever generated the frightening call only “looked wrong.” But, I was never upset with a false alarm, even if it pulled me off another important job. Discovering it was a false alarm was so much better news than if it had been an actual error. I’d patiently check and explain why my layout was right. I would humbly and respectfully clear the confusion in the mind of the person who cried wolf; and I didn’t charge for the visit. I thought of this as PR or business

promotion. My responsiveness was always appreciated and it was truly self-serving in that it promoted the all-important working relationships.

On the thankfully rare occasion when I or my firm staked something in error, I'd frankly admit my error, plead for mercy, correct the staking (without fee, of course), and thank the supervisor who called me to the site for letting me know so promptly. Unlike the surveyor mentioned above who believed he'd not erred in decades, construction people live in the real world and know that errors occur. They just need it corrected, and they move on.

## **Never underestimate the Construction Manager's role**

Throughout the rest of this material, depending on the scope of the project, the term Construction Manager may mean, the Design-Builder, the Constructor, the Project Manager, the job-site Superintendent, the Construction Management Company with its staff, the General Contractor – any or all of the above. Where clarity demands, I'll specify which I'm speaking of. Usually, I'm referring to a construction management firm or site superintendent. But, because most of this presentation applies more-or-less to all these entities, I'll hereinafter call the firm, person or team responsible for coordinating the construction the **CM** – meaning in a general, broad-brush way, the **Construction Manager** or the **Construction Management firm**. This person or business entity is almost always your client.

The CM hires you to perform necessary construction layout activities. But, the role of the CM goes far beyond this simple interaction with you or your firm. The CM serves as facilitator, problem solver, coach, mediator, choreographer, morale-builder, budget-keeper and sometimes whip-cracker. Think about it. The CM is the last link between all the heady and creative design disciplines and the thing that gets constructed. The CM is like the narrow part of an hourglass. All the design elements and financial resources squeeze through this narrowing between theory and tangible reality.

In this important capacity, the CM often finds plan or design errors, or things that just don't work well, are inefficient, or unnecessarily expensive. The CM transforms thought into creation, paper into concrete, theory and design into three-dimensional reality. The CM is a problem solver by nature. Theory be damned; the thing must be built!

The CM is a realist who knows better than most design professionals do the value of relationships. If you've made a friend of the CM, the CM's representatives and the sub-contractors on the site, they will empathize with you if you err; they won't scold you or resent you. And, building relationships is so important.

## **Never underestimate the value making a friend – True Story**

The impact of a true story is many times greater than any illustration based on what *could* happen or *might* happen. What follows is another true confession of what *did* happen, believe it or not.

On a job back in the late 1980's, my firm made a significant error. Actually, my right-hand assistant made it. He calculated the centerline intersection angle of two roadways at a major

office park development, *assuming* the centerlines of two intersecting roads were at 90-degree angles to each other. (The plans we had at the time did not specify the angle.)

A surveyor-friend of mine is fond of saying, “ASSUME makes an ASS of U and ME.” However logical or reasonable an assumption may appear, don’t make it – not when performing construction layout!

Here’s what happened. The late 1980’s was a boom time. Development in the greater Washington, DC area was thriving.

One day, I received a call from my client to stake clearing limits for a proposed, mile-long roadway running through a wooded, commercial development project – a development of considerable, economic impact to the area that government regulators had placed on fast-track. I’d not worked on this project prior to receiving this call.

I serviced several fast-track, major developments at that time. What is a fast-track project? Fast-track status was awarded to projects deemed by Fairfax County, VA to have particular importance to that county’s economic development. What made these projects unique was they were allowed to start construction prior to county approval of final design plans. Based on preliminary plan approval, certain elements of the construction were allowed to proceed ahead of the final design approval of the project as a whole.

For me, these projects were especially dangerous. The potential liability for errors increased on fast-track, because plans were being revised and finalized at the same time actual construction activities were taking place. Thus, my geometric plan computations for layout of any particular features on fast-track projects were not performed until calls for that specific layout came in. This approach sacrificed the checks I normally enjoyed when computing projects as a whole. Instead, piecemeal calculations were made, here a little, there a little. Calculating the project as a whole is much safer because dimensional relationships of all elements are considered together; everything designed to be constructed must fit dimensionally on the site with other elements. When an entire site is computed at the same time, plan errors (or my own computational errors) may be discovered when one feature doesn’t fit correctly with another. But, taking the usual, holistic approach to geometric plan computations was simply not possible for fast-track projects.

On fast-track projects, I’d receive a request for layout, go to the client’s office, pick up the latest version of design plans and supplemental drawings, compute the layout, compose and mail my CYA memos (covered later in this course) and then go stake it – all in a very, very short time frame. Typically, information was incomplete on the plans because they were not truly final plans; they were works-in-progress. Design work, county reviews and approvals, and construction were taking place simultaneously – in steps that often overlapped.

At the time, my client requested staking of roadway clearing limits, the site plans did not specify the centerline angle formed by the two intersecting roadways that served as the starting point for the staking. But, the clearing limits for this project’s proposed roadway network were not super-critical. The plans furnished enough information to establish the new road’s starting point at the centerline intersection as well as the centerline alignment of the proposed road through the site. We could scale the roadway’s clearing limits from the centerline.

Since the project's new road centerline was tied dimensionally to the perimeter boundary lines, and evidence of the property corners was present and checked well, the plan information was sufficient to fulfill our first assignment on this project: to stake clearing limits for a mile of proposed roadway winding through the project.

My business was overloaded with work at that time. I assigned the computations for this layout of the clearing limits to my right-hand assistant, a person who lacked years of experience and the instincts born of such experience, but who was a quick learner. I performed minimal checks of my assistant's computations. I placed a plot of his work over the to-scale design plans on a light-table and found agreement between the site plans and our plot showing the proposed road's centerline and its clearing limits. I did not check my assistant's coordinates for the existing, intersecting roadway's proposed centerline, because it didn't matter at that point in time. It wasn't needed. Again, our mission was simply to stake clearing limits for a new roadway at that stage of the project.

About nine months later, and many revisions of site plans later, the developer was ready to construct utilities at that same roadway intersection that served as our starting point for our first layout.

Not remembering that the computations for that major intersection were unchecked, and finding points with coordinates along both intersecting roadway centerlines, I staked several huge drainage structures at all four corners of that four-way intersection. I staked them based on our original, centerline intersection computations having totally forgotten by then that my assistant, not I, had performed the initial roadway centerline computations.

Two weeks after staking this intersection's storm structures, my phone rang. It seems that another surveyor had staked the curb and gutter for the parcel across the street from the project I'd been staking. Per some arrangement between developers, my client was responsible for installing all the storm drainage at the intersection, and the developer across the street was to construct the curb and gutter for that intersection. The other surveyor's staking for concrete curb and gutter wasn't matching several huge drainage structures already in place at that intersection (staked by me) that were supposed to align with the proposed curb lines. I was asked to come to the site and try to determine why a discrepancy existed between the storm structures installed per my stakes and the curb and gutter stakes set by the other surveyor.

First, I set up the instrument and checked the as-built locations of the structures. They were constructed in the right place per my coordinates. I noticed that the curb and gutter stakes reflected an agreement as to where the two centerlines of roads intersected, but the realigned and widened roadway appeared to be rotated about the point where the two centerlines intersected.

My assistant and I researched our records to refresh our memories of the basis for our computations at that intersection. Months passed between that first call to stake roadway clearing limits and the call to stake the drainage structures that were now installed. Gradually it dawned on me, to my horror, that I had not initially computed the intersection myself; my assistant computed those points.

Those early plans did not specify the angle at the intersection of the two roadway centerlines, and so there was no way to compute points along the realigned centerline. Had I been the one

computing that initial layout, I would not have created points along the realigned road's centerline. My assistant, thinking he was going the extra mile, made a critical and wrong assumption. The roads 'looked like' they were at 90 degrees to one another, so he computed the realigned roadway that way and established points along its centerline. I used those points in computing the drainage structures at that intersection, and now they sat there – in the ground, in the wrong place. My heart sunk. This was going to be very, very expensive.

This took place in Fairfax County, Virginia. Larger storm structures in this county were designed with openings along the curb line that varied in length depending on how much water would flow to that structure. The four structures at this intersection were custom-made in three, precast concrete sections each and shipped to the site for installation.

The top section of the each storm structure was a "cap" about six feet wide by twenty feet long that included a "throat." When installed, the throat appeared as an opening along the curb line. These throats varied in length depending on how much water each structure was designed to intercept and collect in the sections below. All four structures had throats about twenty feet long. Below the cap section was a middle section, essentially a rectangular, precast concrete box having neither top nor bottom. Because of the long throats, these middle sections measured about six feet wide by twenty feet long and were three or four feet high. The four bottom sections were the same size and shape as the middle sections except these had bottoms and holes to accommodate the large pipes that entered and left the structures at various places.

Pipes connecting the basins ran under the roadways (which fortunately were not yet paved). Pipes from three of the basins ran to three different headwalls.

Can you grasp the magnitude of this layout error? Do you know how I felt inside?

I approached the CM's on-site project manager, explained how the error had occurred and concluded, "It's my fault. I'll restake it right now." There was nothing more I could say except, "I'm very sorry to have caused you this problem."

The project manager asked, "Can we move the intersection to match the structures that are already in place?"

As you can imagine, I liked that idea. But I replied after some thought, "No, I don't think so. The road alignment has been approved; the dedication for the new right of way is established based on that alignment; your engineer isn't the one who designed it; all the development across the street from your project is based on it; an as-built survey would declare the change; getting the roadway alignment changed will mean delays; the rotation along the throats of these structures is a much a two feet, and that is too much to warp the intersecting road's alignment. It's my fault. Be as merciful as you can with me. I'm a small businessman, and this is going to impact me severely."

So, that was the situation. Now we come to the point of telling this story.

What had been my relationship to this project manager up to this point? I'd served this supervisor and his firm faithfully on many project sites and occasionally gave assistance that was clearly beyond the scope of my contract without charging an 'extra' for my services. I was always polite, respectful and flexible. Once, when this project's site superintendent was in the

hospital for an operation, I called his home that evening to ask his wife if it went well. Another employee of the CM experienced a painful family problem that I became aware of, and I sought him out on the site to express my sincere concern for him and to tell him I'd be praying for him and his family. (His religion was Islam and mine Christianity, but he smiled and was clearly grateful.) I made it a point to be friendly to everyone I met on the site at all times. In short, I had cultivated a caring, sincere and consistent attitude of service. Beyond that, I genuinely cared about these people, and I think they knew it.

How much was I back-charged for this very significant error?

The unbelievable truth is that this contractor never back-charged me at all! Up to that tragic miscalculation, my posture as a servant to this client had never been faked; I served the CM from the heart and enjoyed doing it. My performance as a team player was never a put-on for self gain. It was simply who I was and how I did business – with EVERY client.

This particular client was not the easiest to work with. They would call me to the site for a half-day of layout and then ask for additional work once I was there. This cramped my schedule and made it difficult to keep commitments made to other clients. They didn't think ahead like some of my clients. They always wanted me to work on their projects on an hourly basis. (I could make about 20% more money on jobs I bid, because I was considerably faster than my competitors were. I preferred to bid, but agreed to work on an hourly basis for this client on project after project.)

I was more than rewarded through this one event for any inconvenience I may have suffered in being agreeable and flexible and treating this client in a caring, understanding way.

Most clients will not forgive such a significant error. However, if they like you, they may at least not pad the back-charge or let some subcontractor pad their hours to fix your error. Do you want to limit your liability? Do your best work every single day, and be a genuine friend to your clients. Serve them from the heart. They put food on your table.

Who knows? They may even save your skin some day. It happened to me.

## **In relationships, never fail to keep the Big Picture in view!**

In the true story just related, justice was not served, and it was good for me that it wasn't! My client was unfair to his own interests; I should have paid dearly for my assistant's error – really for my failure to check the work of my assistant.

In another circumstance, justice was also not served. In the true story I'm about to relate, I was treated unjustly by a client. I could have demanded justice, or at least pursued it more vigorously. But, it was my turn to cover another's shortcoming and their mishandling of a situation. I absorbed a back-charge that was unjustly applied against my billing. I did everything right and yet paid for someone else's mistake.

My contract was for all the construction staking of a mid-sized, commercial development – a 14-acre, combination, office-warehouse ("flex-tech") project. The back charge was significant, including costs for demolition of over 30 feet of curb and gutter, removal of debris and construction of a driveway opening with two adjacent, curbed islands.



I didn't even know of the problem until the back-charge was applied against my monthly billing and I called for clarification. The project manager said I should speak with the site superintendent. When I arrived at the project site, the super told me I'd staked a section of curbing along a parking lot, straight through an intersecting driveway, as if the driveway didn't exist. He said a section of the curbing had to be demolished, two islands installed and the driveway apron paved.

By the time I became aware of the situation, the curb and gutter contractor had already made the "correction" in the field and the parking lot's curbed islands and driveway apron (the one I missed) were constructed. Grading had not been a critical issue at the place my error occurred, so the sub-contractor just tore out a 35-foot long section of curbing, built two new, curbed islands and the driveway apron. He did this without any additional layout from me by simply matching his new curbing to what was saved from my layout. No additional staking was thought necessary, so I was left entirely out of the loop - in express violation of my contract's language regarding suspected or discovered errors.

I went to the site feeling a bit angry that I'd learned of the error over two months after my stakes were destroyed. I'd been given no opportunity to verify or dispute my responsibility in the matter. Nobody communicated with me about it. The client simply deducted the backcharge from my billing. Rude! And this, from one of my best two clients. Besides my frustration with my client's behavior, I was upset with myself for making the error. I couldn't imagine how I missed an intersecting driveway while staking. Was I blind?

After I arrived on at the site, the superintendent walked with me to one of the parking areas on the 14-acre site and pointed to the driveway opening that I'd supposedly failed to stake. I unrolled the plan set I was carrying and saw that my plans showed no opening in the curb for the intersecting drive. The plans I'd staked from ran the curbing for that parking lot straight through, just the way I'd staked it; no driveway was called for on those plans. My stakes were had been set according to the plans I'd been furnished for that very purpose.

This site was also a fast-track project, like the one in the previous story. It was clearly my client's responsibility to copy me on any revisions to the plans I'd been given. I asked, "Where did this driveway come from? If there is some newer plan, why wasn't I advised of a revision?"

I got only half an answer – an answer to the where-did-it-come-from part. It seems the developer of the site purchased an adjacent parcel after this site was already under construction, and he requested the driveway opening be constructed to facilitate vehicular travel between the two sites that had come under his common ownership. No one thought to advise me of the change. I was clearly not at fault. And, I was very relieved. This was not a small back charge!

I sent a memo to the project manager explaining that I'd staked per plans I'd received from his CM firm. I wrote that I had no record of receiving revised plans and would have no way of knowing of a revision unless the CM informed me. I reminded this project manager that as this project broke ground, I'd sent a standard reminder (really a CYA memo) stating, "Remember. It doesn't get built according to the most recent plan; it gets built according to Jonathan's plan!" That standard memo exhorted the project manager to keep me in the loop should any changes to plans occur that affect my layout. I asked the project manager if he had a transmittal letter to document that I'd been advised of a change to the plans, and if so, please send a copy. (Of



course, I knew that no such transmittal existed, and that the project manager had erred in not advising me of the revision. This particular CM *always* documented *everything* the sent out with transmittal letters.) I expected a check in the mail for the amount of the back charge.

Instead, the project manager replied in a memo, saying he'd look into it. After that, I heard nothing more about it; and, I didn't receive a check.

Clearly, I should not have been back-charged, as the CM was responsible for providing revised plans and failed to do so. BUT... the person in the CM's organization who should have actually handed the revised detail to me was the site superintendent. If I had pursued the matter to its just conclusion (Legally, justice was in my favor.), I would have brought the site superintendent's omission to the attention of his superiors, it would have gone right to the owner of the firm and damaged what had always been my good and cooperative relationship with that superintendent.

The superintendent's job is a challenging one, full of crises and emergencies, and the little, letter-sized plan showing a change in a 35 foot long section of curbing on a 14-acre site probably arrived at his trailer in the middle of a swirl of noisy, frantic activity. He simply didn't relate that relatively insignificant change to my layout activities.

After due consideration, I decided to absorb the back-charge without further argument. The CM's team on that particular project must have been under some pressure that made them reluctant to face their responsibility. This firm had given me many contracts, and its owner was a personal friend. For the sake of the continuing relationships involved, I ate the loss without taking legal action. Making waves in this large construction management firm would not be a wise business move. I kept the Big Picture in focus.

I was wronged. The backcharge was significant and took a big bite out of my fees for that contract. It came as a shock when my expected revenues that month took a hit, and I still had to make payroll. It was rude, unjust and undeserved treatment.

My emotions, I must admit, were quite compelling. But, as I cooled down, I examined the Big Picture. Business and personal relationships were involved. The backcharge would not put me out of business. The amount was a small percentage of what I billed this firm over the course of two or three years. In general, this firm and its several teams had been very good to me. Considering the Big Picture, I had to let it go.

And so, my advice is, always keep the Big Picture in mind. Those of us who do this kind of work are usually detail-oriented people. It's easy to look at any given business situation with tunnel vision and lose sight of the Big Picture.

## **Never underestimate the grapevine**

If you perform badly, stake when it fits your schedule instead of when it's needed, behave inappropriately or haughtily or otherwise alienate your clients, word of your insensitivity to the needs of your client will probably pass through the construction grapevine. Conversely, If you show up when you say you will, provide what you came to do and make friends of the CM's staff, they'll be your best advertising.

Too often, construction is held up waiting for the 'surveyor' to show up. Well run firms that earn a substantial portion of their fees from construction layout services will place construction layout high on their list of conflicting priorities. The impact of timely layout cannot be stressed too strongly. So many professional firms are ignorant of the importance of timely performance, and their service to their clients proves it.

If you understand your CM's need for responsive service and consistently provide what they need, when they need it, your firm will be praised, and news of its good service will be broadcast through the grapevine.

The construction world is a fraternity of sorts. People circulate from one company to another, and construction people tend to be talkers. They're outgoing, and they network both formally and informally. Your reputation is in their hands. You have no idea (well, maybe you do) how important it is that they like you and believe you have their best interests at heart.

## **Always-always Land – The worth of time-honored values**

The sum of the above, nine never-nevers, is this: the benefit to you of living in a time when traditional and proven values are rare, is that you and your firm will stand out simply by doing what is right. In addition to the never-nevers, here are some suggested always-always:

Always-always:

- Consider other members of the team worthy of your honor.
- Send competent people to perform construction layout.
- Provide subordinates with the tools needed to perform the job.
- Allow enough time to perform construction layout without undue pressure.
- Remember how difficult the CM's job is and how small your part is in it all.
- Be reasonable.
- Be quick to hear and slow to speak.
- Be a person of your word.
- Be responsive.
- Be respectful of people in general and of the expertise of all others on the team.
- Be humble.
- Be unswervingly honest and ethical, even when it hurts you in the short run.
- Be on time; show up when you say you will.

- Communicate clearly, humbly, professionally and adequately.
- Do good deeds.
- If faced with the choice to expose or to cover the shortcomings of others, always choose the latter, and
- Stake your layout right.
- Remember the saying, “Keep your words soft and tender. You may have to eat them!”

## Fieldwork for a Typical Mid-sized, Commercial Project

The mid-size, commercial project is chosen as our typical layout job because it’s size and type illustrate the most common phases and requirements of development in any tightly regulated urban area or densely populated suburban region.

The same processes and procedures apply to a diverse range of construction layout projects. The mid-sized, commercial project includes most if not all of the disciplines required for large-scale development, and smaller projects usually require at least some of the same layout. Single-family, residential subdivisions and row-style apartment and condominium projects typically require essentially the same types of layout, too.

Don’t think I’m losing the train of thought as we digress from the work itself for a moment to consider the *doing* of the work.

Most firms have adopted the two-person field crew as their standard. In a little while, when we outline the typical fieldwork for a typical mid-sized, commercial project, allow yourself to imagine performing it with a three -person crew instead of a two-person crew.

### The Field Crew – two or three people?

In order to perform construction layout, you need a field crew. Pretty basic, yes?

Let me start by promoting an idea you need to seriously consider. Since the advent of the total station, and even before to some degree, the trend has been toward the two-person crew. This trend I’ve never subscribed to, though for reasons of practicality or lack of available personnel, I’ve functioned with a two-person crew when necessary. But, I don’t believe it’s always the best approach, the most practical or the most profitable. I know you’re thinking robotic instruments and GPS and the one-person crew, but bear with me and hear me out on this.

The party chief is a good organizer of the work to be accomplished and the person or people doing it, right? The party chief is the one with that sixth sense developed through years of experience, right? (Why is the party chief the ‘chief’ if not?) With a seasoned party chief who *is* a good organizer, there’s seldom a time when two assistants are too many. A capable party chief expedites most work assignments if provided with a third person in the survey crew.

It used to be that the “rodman,” as he or she was called long ago, was the dummy on the crew – the entry-level person most lacking in experience. Since the advent of data collection and automated line work, the “rodperson” responsibility normally falls to the party chief, the most experienced member of the crew or, properly, to the person most capable of knowing what points must be located or staked and what feature codes (or point descriptions) will properly construct the automated figures (line work) as the collection file is processed. Of course, the person operating the data collector and instrument must also be methodical and disciplined at the least.

The rod is now a prism pole, and data collection’s capacity to record line work and actually perform mapping simultaneously with the age-old practice of point location has demanded that a skilled, experienced person “run the rod.” Staking from offsets to alignments and using the data collector to change offset distances when something blocks the line of sight means the person on “the gun” (and data collector) also must have experience.

Back to the point: Like making money? Then consider returning to the three-person crew, the old-time standard survey party from the transit and tape days. How can the third member of a crew increase productivity and profitability as well as provide a competitive edge? I’m so glad you asked.

First, don’t forget the obvious: your vehicle has a spare tire, even though occurrences of flat tires are rare. And, that spare tire has no practical use except that one time when you have a flat. The rest of the time is just takes up room. But, you still carry it with you wherever you go. Far more often than your vehicle having a flat tire, your staff members go flat: sick days, doctor and dentist appointments, vacation days, day-care emergencies, etc. Periodically, a member of your survey crew finds other employment or turns out to be unsatisfactory or unreliable and must be let go.

How often do you ask yourself, who is going to work with my party chief today, because Jim called in sick? Or, Pete can probably fill in for the party chief, but where can I find someone knows enough to work with him today?

IF your standard resource is a three-person crew, you just keep on ticking with two people left – and, not just and two people, two people who are used to working together.

Have you tried to train a new-hire lately in the two-person crew? Have you made an enemy of your party chief by expecting normal production when the party chief’s experienced person has been replaced with a newbie? Productivity goes out the window with the inexperienced new-hire, and it’s compromised seriously when even an experienced new-hire is brought into the two-person crew.

And, what does your client observe during such transitions? Your crew’s performance looks more like a baby-sitting operation than a well-trimmed, professional service. This awkwardness lasts days or weeks with a really sharp new hire and longer with a dud. Meanwhile, you’re unproductive, unprofitable, and unresponsive, plus you just plain look inept to your client.

Your party chief is an organizer. (Again, should that person really be a party chief if not?) If your crew is a reasonably good-performing, two-person team, then there is almost always efficiency in adding the third person to that team. A newbie can flag stakes, pound stakes, label stakes, move the truck, set up safety signs and cones, go and ask the superintendent to drop over to talk with the party chief when he gets the chance, load the truck with supplies in the morning, sweep

it out, wash it so your company image looks sharper, charge the instrument and radio batteries, keep the truck's inventory current, list needed supplies, etc. This list assumes the new person is essentially ignorant of what you actually do for a living and why.

Even with the entry-level employee, it doesn't stay this way for long. Soon this person is not only performing these mundane yet essential tasks, he or she is turning up the angles or pushing buttons on the data collector, and before you know it, you have a person who actually functions in repetitive or less critical roles, taking his or her place in the crew as a true team member.

When someone quits, or it's time to expand to another crew, someone has evolved to at least a junior party chief level of expertise, an employee you know and who knows the way your work. Your expansion is facilitated by the training that's taken place in the three-person crew.

A trained, coordinated three-person crew can really clean up on contract (set-fee) layout functions, since most of your competition is less productive than you are. Your hourly fees are structured to cover this third person's costs, overhead and profit margin, so there's no loss there.

So, what do you lose by having a third person? I know what you'll say, so consider this. When that person is hired, simply say, "You know, there may be times when we just don't have survey work for you because of gaps in assignments or bad weather. In those cases, I may ask you to paint the office, rake leaves or do odd jobs I'd have to pay someone to do anyway if you didn't do them. Is that something that you'd mind being assigned when we don't have the money in a budget for a third person or we just don't have billable work you can do?"

At this point, you read this person's response very carefully to be sure your point is made and that person is not struggling with the concept. You only hire the applicant with a willing heart to serve, no matter what the task. Believe me, you will always find a task that needs doing. You can line them up ahead of time, as the inspiration hits you, and file them in your "Jobs for Junior" folder. You may even assign some chores from your wife's "Honey-Do" list. She'll love you for hiring this third crew member!

A great danger I see coming is the one-person crew. A robotic instrument is a great thing, within limits. It is not a person and doesn't take the place of a person. On the active construction site, it is not only *seeking* its target, it *is* one. It can't get up and run away as a truck backs toward it. It can't think. It can't say, "Hey, wait a minute. Do you really think this layout looks right?"

One invaluable security against thoughtless and costly errors is the thought (and word) interaction between experienced crew members as the work progresses. Many, many times, one person sees something the other doesn't. It's the "can't see the forest for the trees" syndrome. Our work is detailed, and we sometimes lose the big picture and stake something precisely wrong. Other crew member(s) often sense this and speak about it or question why something is being done, and sometimes that question saves you half the cost of a robotic instrument.

Yes, employees are a constant pain in the administration. Instruments don't complain, call in sick, not get along, ask for a raise, bathe too infrequently or the endless host of problems encountered with employees. I know this as well as you do. But, a robotic instrument doesn't THINK. Construction layout is all about thinking. Think about it.

## Hiring that third crew member (or any entry-level employee)

This conveniently leads to the topic of hiring a new employee for the survey crew. If you've been around a while and done this repeatedly, you know the problems encountered. Generally, you'll add to the crew at the bottom, adding an inexperienced or relatively inexperienced new-hire. Typically, and often disastrously, little effort is put into interviewing and hiring an entry-level employee. This is a mistake. You're hiring a team member; this is building the team. It's best to view hiring an entry-level employee as team building, so the act of hiring is given its proper priority.

### The Newbie Employment Exam

Since the subject of hiring an inexperienced person has been raised, this is a good time to relate how I go about this task.

When I hire a person who's green (Where does that expression originate, anyway?), I have a four-part exam.

**PART 1** – The first is something every employer should observe – trust gut instincts and check the references.

**PART 2** – The second is simple. I ask very early in the interview if the person can read and write while riding in a moving vehicle without getting sick. I explain that being able to do so is important to the success of my business, because often there is paper work to do or materials to be studied on the way to and from job sites. I make clear to the person that this is a condition of employment, and if they wish to terminate the interview now it will not be a problem. If I sense any uncertainty at all, I tell them that the best test is to arrange a ride with someone – a ride away from a congested area, where the vehicle they're in is more-or-less in constant motion, a ride long enough to allow the candidate to read a chapter in a novel and write something (anything) for 10 minutes without looking away from the paper. Finally, I advise that it's best to have an empty wastebasket and a few paper towels along, just in case it doesn't go as well as hoped.

I don't actually perform this experiment with the person myself for two reasons. First, it would protract the interview time considerably. Second, the smell of vomit elicits a responsive chord in me, and one wastebasket would probably not be enough.

**PART 3** – I take the person outside and have the candidate drive a dozen hub stakes into the ground using full, from-behind-the-back, over-the-head swings with a 10 pound sledge. (I don't want my employees tappy-tap-tapping a hub into hard clay with a three pound hammer; I don't know about you, but I can't afford it. It takes too long. Besides, it's hard on their wrist joints.)

OK, back to the test. This driving-stakes part is such a great test; my heart rejoices at just the thought of it! What's so good about it? Well, for one thing, this is what the person is going to do for a living. They might as well face it now, for the sake of all involved. Would you hire a surgeon who fainted at the sight of blood? What's so different about this? It's downright practical. I'm looking to see if the person *can* drive a stake and *wants to* drive stake after stake after stake... Personally, I still get a kick out of driving stakes. It's fun! Call me simple.



True story: One summer I hired a star, high school baseball player. Believe it or not, that person couldn't drive a stake. This young stud, who could hit baseballs over the fence, didn't get any better at driving stakes during his term of employment. He just couldn't do it. Go figure.

Also, some women have applied for work who professed a ready willingness to drive stakes at the sit-down portion of the interview, but whose minds changed radically while actually doing the pounding. Needless to say, some of their male counterparts also wilted as they confronted reality.

I've learned that a person who can actually hit the stake occasionally and who misses less often by the time the 12<sup>th</sup> stake is set is a good candidate, provided they face me with a smile on their face after stake #12. Hey, what can I say, some people really like driving stakes. The other thing I learned is to use a sledge with a fiberglass handle and a rubber pad designed to prevent breakage that's placed over the handle down by the head.

**PART 4** – The last and a very critical phase of my employment exam is asking the person to hold a prism pole steady and plumb.

Yes, it does take practice and often some instruction to bring a person to the point where he or she can consistently and steadily hold the pole plumb per the pole's level bubble.

I've found hunters to be particularly challenged during this test. Hunters are used to bracing their weapon in some convoluted system of rigid triangles fashioned from their body parts: upper arms and elbows are held rigidly against the body, and the weapon itself becomes one leg of the triangle. This promotes a steady aim with a rifle, but that technique defeats holding the prism pole steady.

While holding a prism pole, the body rocks back and forth, as it does unnoticed all the time I suppose, even when aiming a rifle. The problem is this: if the body is rigidly linked to the hands holding the prism pole (say by a triangle made of elbows pressed firmly to the person's side, the pole rocks and sways along with the body. I've found that a flexible, finger tip positioning of the rod works best for me and for most people. As the body sways and rocks, the finger tips respond to correct movement of the level bubble and keep it centered in the circular vial.

So if a person comes to my interview wearing a hunting jacket, I cut them some slack and offer instruction – usually after the crack marksman has utterly failed using the body-part/triangle approach and is properly humbled and ready to try a more flexible approach.

Again, incorporating this phase of the test evolved through a bad experience. I hired another summer-help guy who just couldn't hold the prism pole plumb and steady. He simply couldn't do it – and, he couldn't learn it. I honestly didn't know when I hired him that some people just can't make the neurological connections necessary to relate the movement of a level bubble to their body parts.

This person was a nice kid, and I didn't want to let him go. Only a couple of weeks of his summer employment remained before he would take an overseas trip with his parents for most of August. So, I gave him odd jobs to do. I assigned him to wash my new survey van, one I'd equipped as a traveling office with a \$4,000 custom conversion of my own design. The van was shiny white, and I liked to keep it looking good. This meant frequent washing to get the mud and dirt off. This same assistant washed the van for me one afternoon. It took him about three hours,

but he was a very particular individual, so I assumed he was probably detailing the van. I didn't go outside to check on him.

Finally, he came in glowing and asked me to go look at the van with him. It didn't look right. At first I wasn't sure why. Then I noticed it was flat white, not shiny white. The whole thing was like that. "Gee, Kevin," I asked (not his real name), "the paint looks quite different. What did you clean it with?" I instinctively ran my fingers over its surface hoping to feel some dried wax.

He replied proudly, "Oh it was really dirty! I walked home and got some of my mom's SOS pads. That really took the dirt off."

It sure had! For the rest of than van's life, it was flat-white.

A particular visitation of grace was on me that afternoon. I simple patted him on the back and said, "Ah yes. You certainly did make a difference in the way it looks."

Well, back to the point. The last thing you want when staking column centerlines and offsets is a person who can't hold the pole perfectly still and plumb, or darn close to it.

If an unsteady person is otherwise an excellent employee, and can hold the pole within 0.02' with consistency, then certainly a bipod can be used for the occasional, super-critical layout. But the person who can't relate the movement of the bubble to which way the pole must move to be plumb is just not material for a construction layout career.

**CONCLUSION** – Honestly, this is really how I interview the inexperienced, entry-level applicant seeking employment on a construction layout crew . I try to tell them up-front, before setting a time for their interview, exactly what to expect in the interview. And, I let them know that they're under absolutely no obligation to go through with the interview if any part of it is not to their liking or if they're uncomfortable about it.

When that "test" portion of the interview process yields favorable results, and I sense the interviewee will actually consider employment (after such a weird experience), I try to convey a sense of what life in my employ will be like through my indoctrination speech.

## **The Newbie's Indoctrination Ceremony**

The person who passes the four-part interview is ready for my indoctrination speech. And this part is really fun.

Essentially, I inform them that they will get dirty. They will work in the noise, the mud and the dust. They'll probably want to shower every night because the work will make them both sweaty and dirty, and the other people they'll be working with don't like bad smells.

You think I'm kidding? More than once I've had to ask an employee if they have running water at home and strongly suggest they use it. (Hey, not too many preppies apply for this poison-ivy league work.) I tell them that productivity is impacted negatively when co-workers have to hold their noses.

Of course, the candidate by this point has caught on to my sense of humor, which some call 'dry humor.' In my case the condition has advanced to the point I've labeled it 'parched dementia.' (I think the first time I classified my condition this way was speaking to my doctor during a colonoscopy, but that's another story.)

Anyway, I tell the person seeking employment that my ideal candidate is part bull and part ballerina. This usually gets them listening.

I explain that they need to be brutes, inflicting blunt-force trauma over and over to the stakes they're driving into the ground. Once the stake has been driven into the ground, while they're out of breath from the exertion of the effort, they must stand and hold a delicate surveying instrument (the prism pole) perfectly plumb by the tippy-tips of their fingers, balancing motionless, panting and sweating, just like a ballerina at the end of her exhausting performance.

They need to be both strong and gentle, brutish and delicate – each of these opposite natures applied at the right moment to various tasks.

It's great isn't it – this bull and ballerina analogy? Of course, some candidates need to be told what a ballerina is or they miss the glorious wisdom I'm imparting.

I tell them that my profits are made in the accumulated seconds shaved from every task – that construction layout is a hurry-up-and-wait activity. There are periods when there is nothing to do, when senior members of the crew are occupied with some computation or other need. I tell them this is not a time, even when bored, to strike up conversations with the person or persons involved in some task that requires intense concentration. So, inevitably, there will be periods of inactivity and boredom.

Then, suddenly, the computation or other preparation for staking is complete, and it's time to do some staking. At this point the lazy-bug that bit them while waiting for the instrument to be set up or the party chief to make a calculation or review plans, has to be crushed under the sheer force of their will so that they hurry up and get the task done as quickly and efficiently as possible. Time spent walking from one point to another is often down-time for the other member(s) of the layout crew, so that should be done briskly. This can feel unnatural after several minutes of having nothing to do. Just about the time doing the work quickly feels normal, another period of time comes when they have to wait for the other member(s) of the crew to accomplish some task. On and on it goes. Hurry up and wait, then hurry up again.

It's stand and do nothing; then walk and work with a sense of urgency; then wait; then pound stakes with vigor, advance to the next point and wait for the instrument person to turn an angle... Hurry up and wait, hurry up and wait, hurry up and wait.

The profits are made in those times when there *is* something to do, provided it gets done efficiently and correctly. It's the nature of the work that even though there are longer periods of continual work than waiting-around time, the hurry-up-and-work aspect, especially for the less experienced members of the crew, is here to stay. A person who gets sluggish or lazy in those wait-times, and therefore can't get up and running when the time to work arrives, is not the ideal candidate.

I remind them that what makes participation in sports most enjoyable is the team spirit that accompanies a job well done, where every member contributes just the right effort and skill at just the right time. And, this is the joy in being a crew member performing construction layout (or surveying). It's enjoyable to work as a team, to know your part, to anticipate needs, to fill gaps productively without being told to do so and to seek ways to contribute to the team effort. It's not a heavy burden; it's fun.

I tell them that the construction site is dynamic. There are real, 3D things being done there – fun things, unlike so many employment situations where papers and computer screens form the vista for eight hours each day of the week. People working on construction sites are typically unpretentious, hard workers. On the construction site, you meet some of the most talented builders of our nation. Your team (the crew) is part of a much larger team, and the more you learn as you work, the better you become at serving that team and playing your position well.

Now, when someone actually seeks employment with me after this, there's an even chance they'll work out. And, as you employers know, an even chance is as good as it gets.

As supervisors and business owners who have done time in the field know, hiring the entry level employee is not a cake walk. Many don't work out. Few stay on long enough for you to recover costs of training. The typical survey crew of today is too often the two-person crew. Place an entry level employee with the best party chief in the world, and work will slow to a creep. It takes weeks to get the crew back to reasonable productivity after losing a productive member of the crew. Never underestimate the costs of losing a trained, functioning employee. And, don't be unsympathetic with the party chief who gets frustrated at how little gets done with a new hire on the crew – even if you, yourself are frustrated with the crew's level of production.

Many studies have been made to assess the true costs of losing an executive or supervisory employee. Yet, I'm not aware of any such study made to establish the costs of losing the low-guy in the construction layout crew. Of this I am sure, it is very, very costly. Anything that increases the odds of hiring and keeping the right person is golden. This is why I take such pains hiring those who many employers unfortunately view as “expendable employees.”

## **The Newbie's Final Hurdle**

If I intend to place the newbie primarily with a certain party chief, it makes sense to ask the party chief to interview the person before I make an offer of employment. If I have two party chiefs with whom the new-hire may work often, then I'll try to have both chief's present for a time with the candidate.

The party chief is told what I expect before the meeting takes place. I expect the party chief to have a list of questions designed to draw out the candidate and get that person talking. I ask the chief to have three questions that stem from his experience of difficult situations that hopefully can be avoided by the right choice of assistant. I ask that the chief establish dialogue on a personal level during this interview; find some interest in common with the interviewee, whether it be hunting, sports, cars, hiking, cooking, photography or whatever. I tell the party chief to ask the new hire about favorite hobbies or pastimes. Finally, I tell the party chief to ask point blank if the candidate feels there will be any trouble taking instruction and direction from him while working in a subordinate position. I tell the party chief that I need to hear the words, “taking instruction” and “subordinate position” used in that question.

Interviewing this way accomplishes three important objectives:

First, I get to observe the party chief and the candidate as they interact together. This approach tests the chemistry between the candidate and the party chief while allowing me to observe their interactions largely undistracted and unobserved. Of course, everyone is on his or her best behavior at this meeting, but telltale signs generally give me some indication of their chemistry. I look for signs they may explode if mixed together. Is there any sign of a tendency toward

foolishness between them? (Some people simply are bad for each other – thus for my business.) Is the candidate being respectful or trying to establish himself as an equal right off the bat. This portion of the hiring process is never rushed. I want to save time, money and aggravation in the long run, and hiring rightly is a key to achieving that goal.

Second, it gives both the party chief (who *is* in truth a supervisor) and the new hire (who will have to get along with that supervisor) a chance to see what they each think of the other, based on first impressions. And, their impressions are at least as important as mine.

Third, it establishes the party chief's authority. It's sad when two people who are each good at what they do, can't do it together because they don't get along or when the new person starts testing the chief's authority or competing for position and favor with the boss. Some new hires don't realize how difficult the party chief's job is or how much experience it takes to become a good one. They may think that the party chief is not a person under authority and therefore is someone to contend with or compete with or even to overthrow.

The new hire knows from this experience that the party chief is under my authority and therefore has authority. And, the party chief feels included, important, and to some degree in control of his or her destiny while employed by me.

I make it clear to the candidate during this portion of the interview process that the party chief will be the new hire's boss, and that the new hire's success will depend on allowing the party chief to run the crew without strife or distraction. I say emphatically that I don't want the party chief distracted from the huge responsibilities of the position by bickering with anyone about what should be done or how it should be done, by incessant chattering when the party chief needs to be concentrating, or by other distractions from any team member. I explain that terrible financial consequences come with errors, and that I have confidence in the party chief, provided he or she is not distracted by trying to silence or direct a subordinate.

I did say, she. Hiring a male subordinate to work under a female party chief – or the reverse – may require an extra bit of tack, scrutiny and ongoing oversight. The world of political correctness tries to deny this, but we all know the “chemistry” aspect can, in some cases, be complicated by gender differences between two people who work in a close situation, day after day. Enough said on this point.

I've seen so many instances where supervisors, department heads or owners interview and hire a new team member without consulting the person that new-hire will be responsible to day after day. In most cases, the first time the party chief sees the person is on the first day of the new-hire's employment. This speaks volumes to both the party chief and the new hire. And, what it speaks ain't good! This simply should not happen.

Anyway, after the introductions and get-acquainted-time, I privately and separately ask the candidate and the party chief, if they think they'd be comfortable working all day, every day with the other person. Their responses will hopefully reveal their gut reactions to each other. Generally, these initial impressions are an indication of how things will go.

I tell the party chief that I will not hire someone that the chief has problems with or a bad feeling about – that I'll trust the party chief's gut and honor it. Together, the party chief and I make the decision of whether or not to make an employment offer to this candidate.

A fringe benefit of this approach is that it can't help but impress the candidate of how important the position is. Yes, it is an entry-level position, but entry-level and unimportant are NOT synonymous terms. Team building is critical to the safety, success and profits of construction layout. In our stressed-out society, way to little attention is given to it.

## Field Equipment – and some money-making tips

Equipment considerations for construction layout go beyond those of the land surveying profession, so even surveyors are advised to read this section. Surveyors know what equipment is needed for routine land surveying work. Any well-equipped survey vehicle has *almost* all you need for construction layout, but not everything.

Remember, in this section we're discussing typical construction layout fieldwork using the illustration of a mid-sized, commercial project. The demands of construction layout require that thought be given to the people or team performing the work (covered above) and to the equipment that team uses to accomplish their tasks (discussed below), and we'll talk about performing the tasks themselves very soon.

It may be worth noting that the bulk of this course applies regardless of the equipment employed to perform the layout. Below is a typical list of equipment needed to equip a survey vehicle with what a layout crew need to function efficiently at construction layout. The expense of adding GPS equipment is not covered in the table below, and it's beyond the scope of this writing to discuss the conveniences and risks (the benefits and burdens) of using GPS for your layout needs.

A word of caution: The more automated the process, that is to say, the more smoke-and-mirrors involved in your computations as today's modern equipment just pumps out the results of its calculations at the touch of a button, the greater the opportunity for unnoticed errors to creep into your layout. REMEMBER THIS:

The less thought that's required to perform construction layout, the greater thought is needed to make certain it's done correctly.

The following table is a suggested, bare-bones list of equipment that any construction layout vehicle should have. Prices for the items listed vary by choice of brand, model and one's ability to dicker. Whatever equipment is used, knowing what you're doing when you perform construction layout is, at the end of the day, your only safeguard.



ITEM	QUAN.	EACH	TOTAL
Total Station	1	\$ 9,500.00	\$ 9,500.00
Tripod (HD)	3	300.00	900.00
12v Charger	1	50.00	50.00
Spare Battery	1	150.00	150.00
Auto-level	1	450.00	450.00
Data Collector w/ Software	1	1,800.00	1,800.00
Double Rt-angle Prism	1	120.00	120.00
Drill & Bits (rechargeable)	1	150.00	150.00
Magnetic Locator	1	750.00	750.00
Prism Pole 8'	2	140.00	280.00
Bi-Pod	2	135.00	270.00
Tribrach	2	275.00	550.00
Radios/Batteries	3	40.00	120.00
100' Yellow Steel Tape	1	150.00	150.00
200' Steel-clad Tape	1	85.00	85.00
Fire Extinguisher	1	25.00	25.00
First Aid Kit	1	30.00	30.00
Level Rod 20'	1	90.00	90.00
Peanut Prism	1	130.00	130.00
Rotatable adapters	2	65.00	130.00
Tilting Prism/Target	2	125.00	250.00
16 Oz Plumb Bob/sheath	2	22.00	44.00
6' Folding Rule	2	15.00	30.00
Felt Markers (for conc)	10	2.50	25.00
Flat Shovel	1	30.00	30.00
Hammer 3 or 4 lb.	1	25.00	25.00
Hand Level	1	70.00	70.00
Hard Hat	3	25.00	75.00
Machete (22") & Sheath	2	25.00	50.00
Sledge 10 lb.	1	35.00	35.00
Spade Shovel	1	30.00	30.00
Stake Bag	1	35.00	35.00
Chalk Line	1	10.00	10.00
Tack Ball	2	4.50	9.00
Tape Clamp	1	8.00	8.00
Axe	1	30.00	30.00
Belt/Tool Pouch	2	26.00	52.00
Clear Lacquer	6	3.50	21.00
Cones	6	8.50	51.00
Manhole Pick	1	30.00	30.00
Pick	1	30.00	30.00
Rain Suit	3	40.00	120.00
Rubber Boots	3	30.00	90.00
Safety Vest	3	45.00	135.00
Signs	2	25.00	50.00
Tow Chain	1	60.00	60.00
Dock Spikes	24	0.80	19.20
Field Books	6	8.00	48.00
Flagging-assorted colors	24	0.90	21.60
Guard Stakes 24"	48	0.45	21.60
Guard Stakes 36"	48	0.70	33.60
Hubs	48	0.35	16.80
Lumber Crayons	10	1.25	12.50
Mag. Nails Lg. (box)	1	8.00	8.00
Mag. Nails Sm. (box)	1	7.00	7.00
Paint/ orange & pink	12	3.50	42.00
Ram-Set nails (box)	1	20.00	20.00
Rebars	24	1.75	42.00
Tacks (box)	1	6.00	6.00
			<u>\$ 17,423.30</u>

Cheap, huh? Just load \$15,000 or \$20,000 of gear in the family SUV and you're off to the construction site, ready to do some damage! (to the SUV)

A few items that often aren't found in vehicles used for traditional land surveying are standard equipment for construction surveying. The list above is intended to approximate the cost of basic field equipment. You'll spend more on some items and less on others, of course.

Below are some tips and notes on equipment that you don't want to be without.

## Chalk Line & Clear Spray Lacquer

You'll be a hero to your client on occasions when these are needed, and nothing else works like it. Many of your surveyor-competitors are unaware of this "trade secret," and your client is likely to notice and appreciate your foresight. See more about their use under the section, *Marking Projections on Upper Floors* (of a building).

## Fiberglass Measuring Tape or Steel-clad Tape

All survey vehicles should carry these but often don't. A 200 or 300 foot long, decent-quality- (but not super-precise), cloth measuring tape on a reel has many uses. Did I say cloth? My age is showing. They used to be cloth tapes. Now they're made of fiberglass, and some are even coated steel tapes are very affordable. I suggest marking this inexpensive measuring tape at 25 foot intervals, so these intervals can be seen at a glance as the tape feeds off the reel and you can spot these interval markings when the tape is stretched out along the ground. Be sure to mark the back of the tape as well as the front side at these intervals. This can make rough staking (staking in situations where the *exact* horizontal distance is not critical) very, very fast.

If the measuring tape is marked at these intervals with orange-glo paint, brightly colored nail polish or other inventive marking method, it can be stretched out and stakes slammed in at approximate multiples of 25 feet without taking "EDM" instrument readings for distance and barking the tedious calls to "come to me 2 feet" or "go away 1.3 feet." Only line needs to be given by the instrument person who's stepping on the zero-end of the tape in situations where the exact distance from the instrument is not critical. If the instrument person is the one feeding out the tape, those marks make it unnecessary to repeatedly stop the tape to read its graduations until the even 25 foot points are located.

Consider the time saved if you are setting offset stakes along a run of curbing for a straight section of roadway. The offset stakes for a straight run of curbing need to be set in a straight line, and this is fairly critical. But the distance between stakes set along the line of curbing (depending on the situation) often is not super-critical.

In such cases, the tape stretched out on the ground will render distances along its length easily within a foot over its length, provided the grade is not too steep or uneven.

Here's an example: if the straight section of curb you're staking is designed at a 6% grade and your stake is placed one-half foot off of the correct distance, the elevation difference between theoretical grade at the true distance and the grade at the position of your offset stake (being one half foot off for distance) is 0.03 foot in elevation. In most situations, an elevation difference of this magnitude is acceptable. Can anyone see if the curb is off 3/100 foot in elevation in a 25 foot

run? Will water still flow if it's off 3/100 foot, and your grade is 6.1% instead of the design grade of 6.0%?

Using this method, assuming a clear line of sight, a hub stake can be set without using a prism pole or plumb bob simply by holding the stake along the edge of the measuring tape for distance and determining the critical line ("Move it left," or "Move it right.") from the instrument. I can hear some reader in the distance saying, "Yeah, but what about..."

And sure, this won't always be appropriate. Just consider the principle and understand that I've made a lot of money with this approach – when it was appropriate.

For the sake of easy math, let's assume your layout crew bills out at \$120 per hour. That's \$2 per minute. Assume you've accurately bid some layout function at this rate, thinking you'd stake the curbing on several long runs of straight curb using the prism pole to establish the distance for your stakes. Instead, you used the method I've described and saved two readings on a prism per stake for 20 stakes where using this approach was feasible. Let's say that each stake was set 30 seconds faster by this method. You saved 10 minutes using this shortcut. You earned \$20 that day over your bid amount through using this approach. Suppose you see a \$20 bill sitting on the ground as you return your equipment to the truck at the end of the day, would you pick it up or scoff at it as trivial and drive off leaving it behind?

\$20 dollar bills like these are laying around all over the site just waiting for you to pick them up. And, they add up. I have consistently made \$2,000 to \$4,000 more per contract (bid) job than I would have made billing that work at my standard hourly rates on those same projects. I made this extra money by applying the tips, techniques, and principles related to ethics, client-relationships and business management that I'm relating in this course. Most of those contracts ranged from \$8,000 to \$14,000 each, so we're looking at 20% or more profit above my hourly rates that themselves have a reasonable profit built in.

Another thought before leaving the use-a-tape-instead-of-a-prism message: For more critical work, if you have a three-person crew, you can use a steel or a fiberglass tape to get the person holding the prism close enough to the point you're about to stake to avoid the time it takes to get multiple readings on the prism before setting the stake. Your third person feeds out the tape to the specified distance, and the prism-holding person uses that for distance and the instrument person's direction for line. If the prism pole is positioned for its first reading by this method, that first reading on the prism will be within a couple of tenths of a foot of the desired point. Usually, a hub can be set after a single measurement off the prism, since an experienced person can easily visualize one or two tenths of a foot.

Let me state again in a new context that the extra profits to be made in construction layout are in the accumulated seconds saved through ingenuity, appropriate shortcuts suited to the level of accuracy actually needed for the specific layout and by crews moving quickly as a team to accomplish the layout.

## Stick-on Targets and Prisms

Stick-on targets placed discretely on buildings or other vertical surfaces as backsight checks or references, save lots of time in subsequent set-ups on known control points. Redundancy is critical, as some mischievous soul might move the targets when you aren't looking. Some targets

are self-sticking, red and white targets for horizontal sighting, but stick-on prisms are also available, and they're useful for lots of ingenious purposes, among them to help verify your occupied point by distance as well as angle. Considering these when repeated set-ups over time are required on the same control point.

In former times, I used to epoxy a white bicycle reflector onto my Gammon Reel for setting points within a couple of tenths of a foot at close to moderate distances. Range was, of course, limited. Now, stick-on prisms are worth considering for lots of ingenious uses.

## **Cordless Power Tools**

A cordless drill-driver, hammer-drill and/or circular saw is excellent for making drill holes or "x" marks in sidewalks, slabs, ledges or large rocks to serve as control points. Such points tend to be permanent, stable and free from disturbance more than stakes or pins.

On many projects, I've set control points in a concrete sidewalk across the street from the project under construction. I used an inexpensive, cordless drill to set drill holes in the sidewalk for these points, and almost without exception, they lasted throughout the entire time of construction.

I always tried to generously set such control points, setting more than would be set for boundary surveying and using points on line, avoiding any occasion of having the same distance between points on line.

## **Double Right-Angle Prism**

The double, right-angle prism is the poor man's instrument for turning approximate 90 degree angles without setting up an instrument.

Anyone who's performed topo surveys has experience situations when the line-of-sight between the instrument and some point being located is blocked by some other object. Typically, for work not requiring high precision, the point that can't be seen directly will be recorded by a right-angle offset. The shot is first taken to a point that can be seen, and then a right-angle offset distance is measured to the true location. Data collectors allow this input and compute the true angle and distance from the instrument to the point that can't be seen from the instrument.

When the rodperson uses just his or her unaided eye to approximate the 90 degree angle to the point being located, the accuracy of results varies greatly. Being more than a few feet from the feature being located can result in significant errors. It's amazing how inaccurate these shots often become. Using a right-angle prism significantly improves the accuracy of these locations.

Right-angle prisms are also good for placing yourself on line (or nearly so) between two points, one being on the left and the other on the right of where you're standing. More than one staff member has insisted he could place himself directly on line between two points while standing mid-way between them. No matter how much I've declared it to be impossible, many people have insisted they possess this ability. A demonstration using the double right angle prism was more convincing than my words. After that, they used this device.

Recently working alone and setting control points on a site, I couldn't tell for sure if two points I was setting were intervisible. Limited equipment was available me, and even if I had tripods and

range poles I wouldn't have used them to determine if the two points I was setting could be seen from one another. That would have been too time-consuming.

Lamp posts and sign posts were scattered between the two points, and a slight hill rose between them. I could tell that the hill wasn't high enough to block a line of sight between an instrument set at one point and a prism pole on the other, but the hill was high enough that I couldn't see the paint mark I'd left at one point while standing over the second point I was setting.

To the rescue came my double right-angle prism. With it, I was able to position myself approximately on line between the two points while standing near the crest of the small hill. My double right-angle prism placed me on line between the two points and confirmed there were no lamp posts or sign posts on that line-of-sight.

Double right-angle prisms can also make taking of cross sections or staking approximate grids faster and easier than with other methods. If high precision is not required, the double right-angle prism can make the work fly.

## Survey Belts with Pouches

Survey belts and stake bags. I always provided my crews with well-equipped survey belts-with-pouches and insisted they be worn whenever my personnel worked on sites. Crews sometimes complained that the belts are somewhat uncomfortable and cumbersome. Too bad. My crews wore them. No discussion permitted! One employee did genuinely have a back problem, and the belt caused him some distress. About the time I was going to let him off the hook, he rigged work suspenders to the belt and pouches, allowing him to wear the belt more loosely. This solved his problem. Some people really can't wear them, but most just resist because they are uncomfortable. To this I say, "So are seat belts, my friend; buckle up!"

Trips back to the truck for needed items are almost eliminated by well-equipped belts and pouches, and the time taken for trips back to the truck is disruptive to the work flow and time-consuming. At the minimum these belts with pouches carry hard-tipped felt markers, suitable for marking repeatedly on concrete surfaces, lumber crayon, plumb bob with gammon reel, pencil, scales, tack-ball, two pockets (minimum) for nails, flagging, etc., another pocket for field book and one for a heavy-duty, six-foot folding rule. The well-stocked, seven-pocket surveyor's pouch is a winner, and generally will suffice for most projects with the addition of a tack ball.

One crew person I knew insisted on using a 5-gallon bucket for stakes, hammer, nails, field book and everything else. This really doesn't work well, since small nails have to be dug for at the bottom of the bucket, and longer stakes tend to fall out of the bucket or tip it over. If a bucket must be used for some reason, at least get one of the accessories now available for your bucket, the many-pocketed, canvas "overall" that fits over the bucket to hold a variety of tools in various sized pockets.

## Stake Bag

I've used all kinds of stake bags and found that a stake bag similar to a rectangular piece of canvas with handles on the ends was the best for my use. It lays out flat on the ground. Stakes are placed in the center along with the sledge hammer, and then it is lifted by the two handles to "cuddle" the contents. It carried guard stakes of any size, plus the 10 pound sledge (my weapon

of choice). My bag had pockets on the side in which I carried hubs. This type of bag carries iron pins or pipes equally well. For surveyors setting just traverse control, almost any carrier will work. But if you have to set 50, 100 or more stakes per day on a construction site, get, make or buy a stake bag or carrier that's right for you. Between your belt with pouches and what can be carried in one hand in your stake bag, you want to carry everything needed, thus leaving the other hand free for a prism pole, GPS unit, radio or whatever.

## Radios

I must make a pitch for “disposable radios.” The expensive, “professional” radios costing hundreds of dollars are fine if you have the money to repair them when they fail or break or are dropped into a sanitary manhole or stream, and you're faithful to replace their rechargeable batteries when your crews can no longer get a full day's service out of them. If you've not made an iron-clad commitment regarding maintenance and replacement of these expensive radios, just get the commonly available walkie-talkie type radios. Some have voice activated capability, headsets and privacy channel options, and they'll work well under almost all typical circumstances. When they break, just throw them away, open your locked supply closet and pass out another.

Your crews **MUST** have communication. It's frustrating and inefficient to not be able to hear what one member of the crew is saying to another. Morale is important! This one, easy-to-solve problem faced by many crews is a silent (no pun intended) thief, causing time to be wasted and crews to struggle – and this always, **ALWAYS** costs you.

## Sledgehammer

Pick a sledgehammer that suits your strength and skills. (Allow your crews to do the same.) I discourage the use of a 3 or 4 pound hammer for driving stakes, as the effort expended and time taken for the number of swings needed to set a stake offsets any advantage of carrying reduced weight. The 10-pound sledge in the hands of a skillful person has enough force to pound hubs through light frost and most hard-packed soils. Once this weapon rises from behind my back and swings over my head, gaining in velocity, the sheer weight of the head does most of the work of hitting a stake, without extra effort from me at the moment of impact. Non-slip tape (like the kind sold for tennis racket handles) affixed to the sledge handle near the tool's head, provides a grip for one-hand pounding of guard stakes. This has worked well for me. I was more efficient and less tired at the end of a day using the 10-pound sledge than working with a lighter, 8-pound sledge or a 3-pound hammer.

This, of course, is strictly a matter of personal choice, but if you're going to pound stakes day in and day out, all day long, pick a tool that is your friend, not one that just happens to be lying around.

## Orange Traffic Cones – as Backsights

A couple of orange cones of differing heights can be useful as a backsight when you'll be occupying one instrument station for a long session. It is important to check the backsight frequently. Two cones set after the backsight is established by conventional methods can do the trick, without leaving an expensive tripod and prism over the point. Simply set the short cone a



few feet in front of the taller one, each positioned such that a survey tack stuck in the cones' plastic surface is visible on each cone, and each is exactly on line with the true backsight.

If someone moves one or both of the cones, you'll notice immediately that the tacks line up when the backsight is checked. It can be very frustrating to check a backsight after two or three hours and find that somehow (do we ever know why?) we've lost our zero-set on the point. If a vandal moves even one cone or a car hits them, you know immediately because the tacks don't line up. And, if a wayward vehicle does run over your traffic cone, you'll rejoice in the fact that you're not picking the pieces of a tripod, tribrach and prism off the ground, as you would be if you'd left them on the backsight. If you've ever had a tripod, tribrach and prism stolen or severely damaged while your back was turned, you'll appreciate the two-cone approach.

In other circumstances a recorded angle to a point on a building corner, sign, or distant radio tower can suffice as a backsight check without the need to have someone return to the point for the backsight check. And don't forget the stick-on targets noted earlier.

In the woods, of course, a substantial branch of a tree or tree trunk marked with a nail or survey tack may provide the same service. Even a guard stake with a tack set firmly on the line of the backsight can allow the tripod with prism to advance to the foresight. This can expedite your work when a two-person crew is turning multiple angles to establish a control traverse, provided your data collector and software support the angle-only, second backsight.

## Tripod Stabilizer

The smoothly finished concrete floor of a building can be too slippery for your tripod feet to securely set on, as the feet may slide on the finish and send your instrument or prism crashing down. Simple devices can be bought or made, usually consisting of three pads (that the tripod feet sit on) connected by equal-length chains to a circular ring (through which your occupied point remains visible). Some units have solid, steel or aluminum bars instead of chains. Whatever the design, the devices are compact and keep tripod legs from spreading on smooth or slippery surfaces. These are also useful when setting tripods on icy sites or frozen bodies of water. Tripod feet can usually be pressed into the surface of the ice to make them secure, they tend to settle rather quickly. The high pounds-per-square-inch exerted on the ice by the pointed tripod feet melt it, and you'll soon find yourself releveling and resighting in order to continue your work.

## Dist-A-Line™

A Dist-A-Line™ is a device consisting of a small prism set in a machined, Gammon Reel holding device. It provides accurate distance measurement when shot with a total station. It's a rather expensive device, but well worth the investment in my opinion, particularly when the vertical component of your measurement is not needed or is not critical. If vertical is required, what I've done is this: Have the instrument person shoot the little prism with the instrument's scope locked in position (to keep the vertical angle). Then the instrument



person sights and reads a six-foot rule held vertically on the point and records the “rod” height from that reading.

The real beauty of this device is that it needs no adjustment. Gravity takes the place of a level vial. Without adjustment, it remains plumb and as steady as the user’s hand and experience allows. And, the device is quite durable.

Recently through an Internet search, I found the creator and manufacturer of the item at [http://www.kmproductsofnc.com/spec\\_items.htm](http://www.kmproductsofnc.com/spec_items.htm).

Explaining why I’d have to wait to get one the last time I ordered several years back, the vendor said the device is hand-made in limited quantities once enough orders have accumulated. In my experience, not all suppliers have carried this device. The last time I needed one, I purchase through Lo Ink Specialties ([www.loink.com](http://www.loink.com)). Recently, similar products have appeared on the market, though I’ve never personally used those.

## Tow Chain

Did you notice that item in the list? If you use a two-wheel vehicle on construction developments of significant size, you’re going to either do a lot of walking or take your vehicle into muddy conditions whose significance you occasionally misjudge. On active sites, I’ve always managed to get some equipment operator to pull me out of whatever my truck is stuck in – but, I had to provide the tow chain.

Also, on some sites, I’d stop on clean ground near the entrance of the site and put tire chains (not listed above) on the vehicle. To my taste, this got me around on muddy sites better than four-wheel drive vehicles. They did take a little while to place on the tires, but that is what assistants are for, right?

Some reader is saying, “What the heck are tire chains?” I had to special-order them when I lived in northern Virginia. To view several varieties, go to <http://tirechain.com/TRUCK-SUV-CHAINS.HTM>.

## Adjustment of Equipment

Is it unfair to state that most users of surveying equipment will NOT have periodic servicing performed? Well, that’s been my observation. The difficulty in being without the equipment while it’s being serviced can’t be overstated, and I understand it well. But, if equipment is only sent for servicing after it refuses to work, performs erratically or reports obviously bad data, it can go out of adjustment without being noticed, and your work can suffer. It’s no fun finding yourself on a site with some particularly critical layout assignment and being unable to get your instrument to double an angle acceptably or repeat a distance measurement consistently.

It pays to know how to perform the routine adjustments on your total stations, as well as levels and auto-levels. As noted earlier, this is an excellent rainy-day activity for your employees. They really need to know how to do this, and to do it whenever needed. They will pick up on the need as soon as it presents itself.

## Checking of Equipment

### Auto-level

In my experience, self-leveling levels go out of adjustment more often than most survey crews realize. A good, sharp bump (such as when setting up on crushed stone when a tripod leg slides off one stone and stops suddenly on the one beneath it) is all it takes to cause maladjustment of the cross hairs on some levels.

A simple two-peg test takes only a few minutes to accomplish, and most levels can be adjusted on-the-fly when necessary. I always tested my level after such a “bump” and frequently in the normal course of business. Some users seem to think an annual tune up is all that is required for an auto-level, and many more never give adjustment of the level a thought – even after numerous “bad” vertical closures – assuming operator-error is to blame for the recurring two or three hundredth errors of closure that begin to appear regularly.

### The two-peg test and adjustment

This test is so easy to perform, I just don't know why more people don't routinely test their levels. It is even easier if you set up a test range at or near your office. In surveying books, one can find very complex ways of computing your error and making adjustments. The following method works for me.

- 1) Set up two stable points about 200 feet from each other that have a difference in elevation of a couple of feet or so.
- 2) Set your level between the two points about as close to one of them as your minimum focusing distance.
- 3) Read the rod you're closest to, recording your reading to the thousandth. Estimating it is easy at this close range.
- 4) Rotate the instrument and read the distant rod and record that reading, estimating as well as you can to the thousandth.
- 5) Subtract the two readings to determine the difference between them.
- 6) Move the instrument very close to the other point and repeat Steps 3, 4 and 5.
- 7) Add the two differences and divide by 2 to get the average differences observed. This is very, very nearly the true difference in elevation of the two points.
- 8) Leaving your instrument where it is, adjust your cross-hairs so that the difference between the close-rod reading at the second setup and the far one equals the averaged differences.

Example: You set your instrument 5 feet from your first point about on line between the two points, and your first close reading is 6.005. You turn and sight the distant rod at 8.335. Now, you move 5 feet from the second point, again about on line with the first, and you read the near rod (on the second point) at 4.992. You turn the scope around and read the distant rod (on the first point) at 3.322. The differences in readings are respectively 2.330 and 1.670, the average of these two = 2.000 which is almost exactly your true difference, give or take a or so. (One thousandth of a foot is close enough for my trifocals!) You adjust your cross hairs to read this

difference. For a final check, go to the first setup and check to verify you still get 2.000 as a difference.

A variation on this is to set your instrument exactly half-way between the two points where you should get the true difference in elevation between the two points, then go set up close to one of them and adjust the cross-hairs there. Finally, set up close to the other point and check your results there, to confirm you've done your math and the adjustment correctly.

Either formula-free approach will achieve excellent results for everyday leveling needs.

## Prism Pole

More than one wise surveyor has embraced the saying, "A prism pole is a precision instrument." I wish I could quote the original source of this wisdom. I also wish more folks realized its importance and absolute truth. A properly adjusted prism pole, held steadily and plumb is a precision instrument. They go out of level frequently if dropped or subjected to a sharp motion.

Once I was discussing the use of a prism pole with a supervisor of crews for another company. He indicated he couldn't rely on prism poles, as they were always going out of adjustment. Within a few days, I passed one of his crews on the street. The person holding the prism pole was waiting for instructions from his crew chief, and appeared very bored. While he waited, he repeatedly tapped his prism pole point on the concrete sidewalk, apparently to the beat of some tune he had in his head. Any one of the repeated one or two inch drops he gave the prism poles was enough to render the tool useless for precision work without readjusting the level. No wonder that supervisor couldn't rely on the prism poles.

Not so long ago, I was astonished to watch a person setting a point with the aid of a prism pole, simply let go of it when the instrument person said, "Good. Set it."

The pole fell over and bounced on the ground as the user reached into his stake bag and pulled out a stake. The site was planted in grass that was about 6 inches tall, but who knew what rocks were in that grass? If breaking the glass of the prism was not a concern, what about bending or breaking the frame holding the prism. And, in my experience a prism pole falling to the ground is often enough to throw a prism poles level vial out of adjustment.

After seeing this, I better understood why this person's plastic prism-holders were chipped with several pieces broken off. Need I say that a precision instrument should not be dropped on the ground or rapped on concrete to the beat of a tune some cool dude has thumping in the brain?

Finally, how often have you seen someone jam the pole's point into the ground to make it stand upright while the stake is set, thus avoiding the need bend over and pick it up off the ground after the stake is set? Sometimes when spearing it into the earth, it hits a rock just beneath the surface. Its downward thrust stops suddenly, violently. Other times, it does "stick" only to stand upright for a few seconds before slamming to the ground.

These examples illustrate abuse of precision equipment and should not be practiced or tolerated.

## Total Station

Today, almost all surveyors and many larger contracting firms use total stations for all or some of their layout. It's important not only that they measure correctly, but that they measure consistently.

In most boundary surveying work, a hundredth or two of measurement error is not particularly noticed, even when doubling distances off fixed sights. (It may never be noticed if prism poles are used instead of tripods, tribrachs and prisms.) For most horizontal measurement on the construction site, a hundredth or two is not going to matter very much and may go unnoticed.

But, not so long ago, I was asked to visit a site to help the crew chief discover the cause of his inability to check his primary building control for a proposed structure measuring about 120 feet wide by 350 feet long.

Fortunately, the four primary-offset control points he was attempting to set were intervisible. Even so, after measuring and setting using 90 degree angles, he simply could not get the diagonal distance across the rectangle to check. I suspected total station distance measurement error as the cause, since this crew chief was a stickler for precision. He used the Dist-A-Line™ mentioned earlier, and he was steady as a rock with it – no prism pole problems here! (Incidentally, I may *suspect* total station error or malfunction early in my analysis of a problem, but I'm disciplined to conclude it only after all human and other-equipment errors have been systematically eliminated. Almost always in my experience, the total station has NOT been at fault.)

When I arrived on the site, the party chief explained the steps he'd taken. Finding no fault with his process or logic, I essentially repeated the steps he'd taken to set the control rectangle. To eliminate the Dist-A-Line™ as a suspect, we compared distance readings using the Dist-A-Line™ and a freshly adjusted prism pole steadied with a bi-pod. They agreed. Then, we rotated the prism pole 180 degrees and read the distance again as a double check of the pole's level adjustment. Exactly the same reading again.

By now, I was obsessing too. Many of us surveyor/engineer-types are born with an obsessive-compulsive disorder when it comes to precision. But, something was clearly wrong, and I wasn't about to be defeated by the fact that nothing made sense.

Next we got out the steel tape and measured with temperature correction applied between points set at the shorter ends of the rectangle and checked less than .01 foot with the prism readings. We checked the total station's optical plumb by carefully leveling and rotating through 360 degrees while looking through it. Right on.

We set the total station on all four corners points and got mixed results. We again adjusted the points set, only to get further bad checks of diagonal distances and repeat measurements between the same two points.

Once more, we adjusted the four control-rectangle points. Checking the diagonal, it again missed by 1/4 inch to 3/8 inch (two to three hundredths). We set the instrument on the backsight and the prism on the former instrument point, measured the other way and checked exactly with theoretical or expected distance (that is, measuring between the same two points we got different readings).

After a couple of hours of this madness, my business sense got the better of me, and I said, “OK, close enough. But, let’s keep an eye on this and see if we continue to see inconsistent distance readings on measurements.”

Did this small amount of error really matter? Probably not in the real world, and most crew chiefs wouldn’t have reported it in the first place. Truth was, this particular crew chief was always obsessive over precision. He consistently turned in absurdly good horizontal and vertical closures on large tract surveys where his obsession cost very little and his consistent results saved return trips to find bad closure errors. But, making money in construction layout was indeed difficult with this person at the helm. He couldn’t let go of his quest for precision when rough staking for construction layout purposes. Absolutely everything he staked had to be perfect. That takes time, and is a profit killer when such exactness is not required. But, that’s another story. In this case, precision was important, as he was staking primary building control that we hoped would last throughout our involvement with the building construction.

The tale here is that the total station appeared to be giving slightly inconsistent distance readings. The errors, if they indeed existed, were random in nature and occurred unpredictably. It seemed like the proverbial car with air conditioning that won’t work except when at the repair shop. We could not make the error repeat.

Before a few weeks had passed, we were called to lay out a three-section athletic center at an upscale, private school. The three sections were connected together, but were not parallel with one another. It was a tricky layout, and column line offsets were requested for the three, interconnected buildings.

This time, I went with the same crew and same total station at the start. Again, we were coming up two to three hundredths off when trying to check layout of the three separate control rectangles that had to fit together with very little tolerance for error. We finally got it to check everywhere within two hundredths and called it a day. It was absolutely the best we could do, but now I felt certain the instrument was to blame. I had never been unable to do better than this before. Sadly, the total station was fairly new.

Did this matter in the real world. How could it, really? I’ve seen tighter tolerances in architect’s specifications, but c’mon guys; does it really matter. The people who actually build the structures say no.

But the next day, we received a call from a young assistant project manager who worked for the construction management firm overseeing and coordinating the construction. He was working with a more respected brand of total station costing considerably more than ours (the kind I wished we had) and checking behind us.

I went to the site, and he explained that the points we staked were two hundredths to three hundredths off in some places. I had to confess that he was no doubt correct. I explained to him the trouble we were having with our total station and that we had only just confirmed our suspicions on his project. I suggested we go to the gray-haired superintendent who was his boss and see if the discrepancy really mattered.

The seasoned superintendent said, “Don’t worry about it.” The sharp young assistant seemed baffled. I was considerably relieved. A subsequent call to our instrument supplier elicited a



confession that a few users of the same make and model instrument had reported this same problem, and it was uncertain if it really could be eliminated.

A hard decision was made to replace the not-very-old instrument with a new model. This was an expensive solution, but the only sure one. If we'd only been doing land surveying work with this instrument, I'm not sure the problem would have been discovered. But, since we were routinely performing layout of expensive and complex buildings (with our clients looking over our shoulders), it seemed the only wise thing to do was replace the otherwise good total station.

What is the point of this story? Well, we're talking about checking equipment, specifically the total station. It is important to have a baseline near your office that is stable and secure, where you can check near, medium and far distances on a regular basis. We probably would have turned up this problem sooner, if we used such a base line and made periodic, scheduled checks.

You might even be able to set up a base line on the ground level of a shopping mall or under the overhang of a strip mall. This way you can check without much difficulty even on a rainy or snowy day. Also, a calibrated steel tape can be used (with temperature correction, of course) to set the points by measuring on the floor or walkway surface, thus eliminating sag problems from inadequate tension on the tape when measuring. To be honest, I've done this with out-of-the-box steel tapes for decades and never found that I needed a specially calibrated tape for this purpose. But, suit yourself.

Precision has its limits, and I've done very precise work when proper care of equipment and procedures was observed.

Just so the point is not lost in the telling of the illustration, it is this: Don't wait until the instrument betrays you to discover even intermittent problems. Check it on a schedule, even if that schedule is the first inclement-weather day of the month. It was embarrassing to have a green-behind-the-ears, recently graduated construction assistant tell us professional surveyors that we couldn't measure accurately. And, he was absolutely correct – regardless of whether or not the small amount of error mattered in the real world.

## **Adjustments in General**

My observation is that most surveying instruments are designed to permit routine adjustments by their users, and documentation in their manuals instruct on how these adjustments are performed. Yet, most times, the equipment is sent to a repair facility once they fail to meet tolerances for direct and inverted angle measurements. Why is this?

Apparently the art of simple adjustments to the cross hairs has been lost, at great inconvenience and cost to their owners. In my experience, some dealers will even instruct you over the phone on how to remedy common problems like tangent screws bottoming out and the instrument therefore losing its ability to lock upper or lower motions. We need to recover these skills that once were routinely employed by any self-respecting instrument person.

## **Take it for repair when necessary – Don't "limp along."**

Finally, when equipment really needs service, don't delay. I know of a surveying firm whose total station logged a few readings per data collector file with incorrect distances. When larger raw files were processed, one or more points fell well outside their expected positions.

Fortunately, these errors in distance were very large. Generally they were discovered when the files were processed, though not always. The errant points often fell outside the view on the computer screen, so some were discovered some time after the files were processed. Small errors might have gone undetected forever, but these were at least large errors, and all were hopefully discovered eventually.

For a while after the problem appeared, most of the bad shots were simply dropped from the job.. Other times, the bad shot might be on a point that the survey manager decided could be “fudged in.” Sometimes though, the bad shots were critical to the project, say a building corner or fence corner, and the crew had to return to the site and locate the missing point.

Multiple instruments and data collectors were in use by this firm. For a while, we weren't sure if the problem was caused by a certain combination of data collector and instrument. (This is another example of why throughout this course I advocate THOROUGH record keeping.) Analyzing the raw files from several projects, we were able to isolate the problem to a particular total station.

A decade or so earlier I'd encountered a similar problem using another make of total station. Digging deeply into my memory bank (the dust bin of my mind), I recalled that the problem back then was an unexplained add-on of 300 or 400 meters to the occasional shot's true distance, making the recorded distance to the shot considerably longer than the true distance to the point.

Once this old memory of mine surfaced, some experimentation determined this to be the case once again; a 300 meter add-on to true distance to a point was the problem. It was not too difficult to diagnose, as a row of equally spaced bollards had been located by shots taken on each individual bollard. One of them plotted in an absurdly distant place, and the gap in evenly spaced bollards was readily apparent. When 300 meters was subtracted from the distance logged in the data collector, the bollard fell right where it should have, taking its rightful place along the row of bollards. The horizontal and vertical angles were fine. Once corrected for distance and reprocessed, the data collector's file placed that bollard in line with the others, equally spaced with a correct elevation. It should be noted that we were not collecting data in meters, but in U.S. feet at the time. Nevertheless, the distances on these bad shots all appeared to be 300 meters too long.

A few shots taken in a controlled experiment confirmed both the amount of the error and what was causing the error. When shooting a prism at some distance from the instrument, most total stations will allow the shot to be taken with the instrument's crosshairs sighting the edge (or even slightly beyond the edge) of the prism's glass. When taking distance readings with this particular total station purposely sighting the edge of the prism or just off it to the left or the right (no data collector connected at the time), we discovered this same 300 meter add-on of distance occurred frequently. The instrument was only about six months old when we isolated the error and its cause. It still had a year and a half left under its two-year warranty.

Having confirmed exactly what was causing the errors in collected data what do you think happened? The firm immediately sent it in for service, right? Nope!

As any field personnel reading this course know, when making non-critical observations (for example, topo shots taken in a grassy field a couple hundred feet from the gun), it's expedient to turn the gun to the approximate location of the prism for the shot. Exactly centering horizontal

and vertical crosshairs on the precise center of the prism is simply not necessary. What difference does it make if the shot is 0.1 foot from its true horizontal position elevation? Or, when shooting a building corner at some distance from the gun, rather than take the shot using a horizontal offset routine, it is faster and less prone to error to align the crosshair on the building corner right next to the prism. Provided the point is not too close to the instrument, most total stations will read the distance correctly by “sneaking into the prism,” and the angle is taken simultaneously from the crosshairs positioned at the building corner. This method is safer than using an offset function of the data collection software, because there is no risk of entering a wrong right-or-left or physically keying in the wrong distance to the offset position. Sure, most collectors allow taking one shot for distance and a second for angle. But, this means two shots to get one point, which is more time consuming and means pushing more buttons on the data collector creating additional opportunities for error.

The commonly used shortcut (shooting the edge of the prism when longer distances between the gun and the prism allow) saves considerable, accumulated time and provides a safer way to log shots like building corners, fence corners and the like. But, this method had to be abandoned during the time this total station was in need of repair.

Finally, the week before the instrument’s two-year warranty expired, the firm sent the instrument to the dealer. The dealer narrowed the gun’s angle of acceptance when reading a prism, and the problem was corrected – a year and a half after its cause was diagnosed!

In the office, for a year and a half, these bad shots had to be isolated and manually corrected by calculating both the correct horizontal distance (300 meters less than the recorded distance) and the vertical correction (a function of vertical angle and corrected distance) for *every* point where this occurred on every project. This took time and introduced opportunity for errors in the hand-made calculations of all those bad points.

In the field, too, time was lost. Once the problem was attributed to shots taken near the edge of the prism rather than at its center, the instrument person had to be careful to center the prism on every shot, whether or not the point being located required such precision. The person holding the prism had to take extra care not to let the prism pole drift to the side while the shot was being taken. This extra care taken in the field for thousands upon thousands of non-critical locations reduced occurrences of this equipment error to about two or three shots per thousand.

This took time. For every single shot, the instrument operator needed to precisely center both the horizontal and vertical cross hairs on the center of the prism. For non-critical shots, a properly functioning instrument allows the gun to be turned toward the prism until it begins taking the reading. The person holding the rod had to keep close watch in the level bubble instead of glancing ahead to plan the location of the next shot. The instrument person needed to look at the distance before accepting the shot to see if it was reasonable or if it was three football fields too long. Lots and lots of time was wasted, while the occasional bad shot still crept in unnoticed.

Because the crew using that instrument was often collecting topo in fairly developed areas, lots of shots were taken each day. This meant that almost every day at least one such error slipped their notice and had to be hand-calculated and corrected – or, the data collector file had to be hand-edited and reimported.

The net results of *not* taking the instrument for repair until about a year and a half after the problem was discovered were all of the following:

- Opportunity for errors due to hand-made corrections increased.
- Increased costs of processing data increased due to manual calculations and modification of point databases by hand or reprocessing of collector files.
- Constant extra care was needed to achieve the otherwise unnecessary precision that alone avoided most occurrences of the error. Over a year and a half, this added days of extra effort on the part of field crews, distracted them from *what* they were locating with the need to concentrate on *how* they were locating it, and increased fatigue while adding frustration to the crew.
- Indirect costs of poor morale caused by frustration of both field and office personnel may be the greatest cost of all.

Be good to yourself and your staff. One of the most unnoticed, substantial costs of doing business today is the significant, indirect expense of poor employee morale.

The probable reason for delaying repair of the instrument in the above, true story was avoiding the expense of renting an instrument while the one on warranty was in the shop for repairs or adjustment. Perhaps the manager thought a slow time would come when the instrument wouldn't be missed. Yet, this one instrument problem frustrated numerous personnel and slowed both field and office processes for a year and a half before it was easily and quickly resolved.

My advice: Never, never be penny-wise and pound-foolish. If some piece of equipment doesn't work like it should, bite the bullet and git the dern thang fixed!

## **Adjusting the Firm to the Times**

The preceding tale took place in a large, multi-discipline firm. Before leaving this topic, I must say that we are in a difficult period when it comes to management of large firms. The reason is that the owners of large firms have in most cases been successful and grown their companies precisely because they stopped doing the work themselves a couple of decades ago and delegated production to others so they could devote their time to business promotion. They promoted and circulated and wrote proposals and eventually delegated some or most of that to managers of departments. Accountants and even comptrollers who have never surveyed a day in their life make ultimate decisions and impose Catch-22 constraints on office managers and department heads.

In short, many business owners don't really know how things are done in our time, and the folks who keep the books and count beans for the owners don't have the remotest idea how things are done either. Many older owners and partners honestly believe it can still be accomplished the way it was in the days when employees were given a pencil, calculator and Leroy lettering set. Just throw any computer and software package at them, and expect results! Staff is told, "Just make it happen. I don't care how you do it!" There is no awareness of the time it takes to develop CADD standards, of the time it takes to get up and running in a new CADD package or even an upgrade.

Yet these folks who count the beans and those who spend the beans are decision makers and authors of policy.

Example: In the mid-1990's I heard a branch manager for a several-hundred-employee-firm ask his surveyor, "How long is it going to take for you to get up to speed in AutoCAD?" The branch manager's tone betrayed some evident displeasure with that surveyor's perceived rate of progress at learning the program.

The surveyor answered, "Well, I don't have a computer to work on."

The office manager replied hotly, "Well, you have a key! You can come in on evenings or weekends and use a computer when somebody else isn't."

I feel very sorry for all the 'guys and gals in the trenches' who are required to perform in today's ruthless, competitive market with yesteryear's programs, equipment and computers. And, sadly, it's a pretty common tale, a *very* common tale.

And, I also feel sorry for owners who don't have a clue how profitable their firms really *could* be if they would simply listen to the experts – those who actually produce on a daily basis, often with one hand tied behind their backs.

Many owners of large firms don't mean to be this way. They don't know they're shooting themselves in the foot. The reason small firms don't generally suffer these ills is that the owner is still actually producing the work product, understands what it takes to get the job done, knows how to do it, and can balance the bean-counting analysis with the increase in his end-of-year profits that result from making wise expenditures.

Enough said.

## Typical Requirements of Construction Layout

### Build on a foundational understanding.

Up to now, we've said little about the step-by-step procedures involved in the actual acts of laying out the typical construction site. Now we come to the part many have been waiting for – some actual how-to instructions and step-by-step methods.

I could not present the remainder of this course divorced from what's been presented up to this point. Achieving maximum success at construction layout requires a foundational knowledge of your clients' needs and of business considerations peculiar to the specific layout being performed at any given time.

Surveyors have always prided themselves as being "experts in measurement." If that's the only claim to fame a surveyor has, then he or she will have difficulty competing for construction layout contracts. Today's measuring devices and equipment allow almost anyone to become an expert in measurement in a fraction of the time it used to take to acquire consistent, accurate, "expert measuring skills."

Today's technology presents a serious problem for anyone who does not understand the differences between measuring for land surveying and measuring for construction layout needs. Twenty years ago, surveyors were called in to perform construction layout because of their skill

in computing coordinates (that is, their mastery of coordinate geometry computations) and their expertise at measuring precisely. This required special knowledge of math, geometry and trigonometry plus acquired, disciplined, physical skills. Measuring with a steel tape demanded that adequate tension be used in measuring; temperature and sag corrections had to be computed and applied correctly to observed measurements; physical strength was needed to pull the tape hard enough in contorted body positions. Even the skill required to hold a suspended plumb bob steady while making measurements took time to learn. This, like any difficult physical discipline, took lots of patient practice. And, some people never really got good at it.

Creating a geometric plan from which to lay out the construction of a site required considerable computational ability twenty years ago. Now, even that has been made immensely simpler due to the graphic solutions of the CADD world.

Today, it is not rare to encounter a recent graduate of a two-year construction management program checking or supplementing the work of surveyors on a construction site. (Remember the true story related earlier in this course under the “Total Station” section.)

Many older surveyors who perform construction layout services haven’t noticed this evolution. They rest on their laurels, boasting expertise in measurement as their claim to fame. But, they haven’t noticed that their laurels have become brown and brittle.

Sadly, many surveyors assume they are experts in construction layout simply because they are experts in measurement. To be truly effective, construction layout requires more than basic measurement skills – more than *advanced* measurement skills. To stand out as a provider or construction layout services demands an understanding of the matters presented in this course. And, don’t think that the party chief sent to perform construction layout doesn’t need to know these things, too.

By diligently applying the material presented in this course (whether you’re an owner, manager, office or field person), you can stand out among the competitors and serve your firm’s clients in a way that makes them happy and keeps them coming back.

## **Getting the right start...**

The key to getting started ‘on the right foot’ when performing construction layout is taking care with the initial fieldwork and making necessary office preparations at the very beginning of a project – BEFORE any actual layout is performed.

### **...in the field**

Your control traverse (network) should be plentiful, located to last throughout construction wherever possible and be as precise and accurate as you can possibly make it.

### **...in the office**

Getting the current plans at the start of the project is critical, as is performing necessary checks and computations *before* attempting any critical layout.



## **Preliminary Reconnaissance, Control Traverse, Traverse Adjustment (or not) – Your First Visit to the Site**

This section necessarily requires many if/then's. Bear with them and try to follow the variables. It will be worth your effort. Study even the headings that don't appear to apply to your situation.

### **Assuming you are a surveyor, but not the record surveyor**

On a typical project for which you are *not* the record surveyor (the surveyor who performed the boundary survey for the parcel being developed), your initial visit to the site is to recover evidence of property lines and corners or whatever the design drawings (usually site development plans) dimensionally tie the locations of the new construction to. Usually the proposed improvements are dimensioned from property lines or phase lines of the project.

Typically, you'll run a closed traverse around the site to "prove" the positions of such evidence and best-fit your traverse to any supplied coordinates of pre-existing control you recover on the site. This data may be provided to you by the design engineer or record surveyor, as noted earlier.

### **What if You're an Engineer or Layout Contractor, But You Aren't a Licensed Surveyor?**

As stated earlier in this course, if you are in the business of providing construction layout, but you are not a licensed surveyor, the 'Assumptions' portion of your proposal should state that at least three property corners and two vertical benchmarks exist on the site prior to the start of your work. If, on your first visit to the site you do not find confirming evidence of at least three corners of the site to be developed, you may be off to an awkward start – and a SLOW start.

SLOW is your enemy at this juncture. Your client won't tolerate delays at the start of a project.

This is the sticky part of offering construction layout services if you aren't a licensed surveyor. Also, if you're not a surveyor, be careful to know your state's definition of "a surveyor" and of "surveying," so that you don't expose yourself to the public scorn and penalties for overstepping your bounds by performing the services of a regulated profession.

The bottom line is this: You **MUST** recover and locate property corners as a starting point for your *horizontal* control and computations. Sometimes you can get by without established, on-site, *vertical* benchmarks by checking the tops of several existing utility manholes or catch basins that are shown on the site development plan and best-fitting for your elevations to those features, provided you confirm essential agreement between the labeled elevations of those structures.

Some surveyors will give you their coordinate values of property corners AND their traverse points. With this information, assuming you find and verify coordinates of three points of their traverse, you can compute exactly where that surveyor's property corners are (whether or not they exist in the field). Always check any such data very, very carefully to be certain it all agrees with itself and with whatever mapping that the surveyor produced. Then write CYA memos to both the surveyor and your client stating what you've found and how it relates to unrecoverable property corners. Sometimes the surveyor's control traverse and the property corners get

positionally disassociated from each other in the CADD drawing. This shouldn't happen, but it does. Just believe me on this. I've seen it happen several times. This is why you MUST draft carefully worded CYA memos, closing with something like, "Please advise if there is any reason or condition that makes the approach I've taken insufficient to establish coordinates of the missing evidence of property corners."

If you've been to the site and set a traverse, and you later hire a surveyor to set corners, (or your client or the developer does), ask that surveyor to locate two of your traverse points while there on the site setting corners, and get the surveyor's coordinates of the corners and your two traverse points. With this information, you can simply rotate and translate so that your traverse and the record surveyor's corners are based on the same coordinates and north rotation. This helps place the liability for the orientation of your staking of new construction squarely on the shoulders of the surveyor. As an unlicensed person, this is where you MUST keep it – on the surveyor's shoulder.

If you are not a surveyor, familiarize yourself with the statutes governing and defining "surveying" and also study the Board rules and regulations governing surveying so that you don't violate any in the course of your work. As an unlicensed person, you may have as much expertise in measurements as some surveyors, but you can't certify to it. You may know where the property corner belongs (especially if the surveyor gave you the coordinates of the point), but you can't monument it. And, you certainly can't weigh the value of conflicting deed elements or make judgments about where a boundary is located. If you are capable at laying out a site for construction, you are probably capable of locating what is built at the end of construction. But, you can't sign and seal an As-built Survey.

The above guidelines are presented as a starting point for your own research. Laws and regulations vary widely from one geographical area to another and political subdivision to another. Avoid learning the hard way that you've inadvertently crossed that line into professionally regulated activities.

For the unlicensed person performing construction layout activities for hire, the delicate "dance" of getting the corners staked by a licensed surveyor may be the trickiest part of contract negotiation with your clients. Sometimes, you may even have to subcontract that service to the record surveyor and absorb the expense. Keep in mind that you'll also need to hire a licensed surveyor for anything in your contract that requires a surveyor's certification. And, offering such services as an unlicensed surveyor may be illegal in your state. Typically, at a minimum these services include setting of property corners, performing wall-checks (or foundation as-builts), final as-built surveys, and *anything* that requires accuracy certifications.

A word of caution and advice: If you are not licensed, be very careful in your proposal not to word anything in a way that can be construed as you holding yourself out to be a licensed surveyor. Save yourself trouble later, and hire a lawyer to help you phrase your standard, proposal boilerplate. You MAY be able, for example, to say, "will *provide* an As-built Survey bearing the seal of a licensed surveyor" and not "will *perform* an As-built Survey." This example may or may not be legally correct. In some states, this simply won't fly. I note it here simply to give you an idea of the types of questions you need to discuss with a lawyer. If, unlicensed as a surveyor, you can find a legally sound way to provide full-services under your umbrella contract, (that is, the services of a licensed surveyor you subcontract), then you can compete head-to-head

with your licensed-surveyor competitors. Your client's contract as well as your proposal language (and of course the law) can impact the feasibility of this approach. Your client's contract with you may not permit assigning any of the services of your contract. Ask your lawyer about all these things.

Please be clear in your understanding of this one point: I am NOT advocating any approach or offering any legal advice. Except this: If you are not a licensed surveyor, get sound legal guidance on how to handle your situation in your geographical area. While I have obtained licenses as a surveyor in eight states, I have practiced construction layout, and that *very* successfully, in a state in which I was NOT licensed as a surveyor. I did this legally without dishonesty or resorting to unethical means. I sought sound legal advice and stuck with that counsel.

Get legal advice from an attorney familiar with professional regulation and Board hearings! If you ever are called before the Board that regulates professionals in your state, remember that in many states, the Board acts as both investigator and prosecutor and has the authority under their Administrative Rules to levy large fines and order you to cease conducting business – if they feel you're practicing without a license. Those words “investigator AND prosecutor” do not sound awfully friendly, do they? My advice is, don't conduct business in such a way that you're called before the board; and, if you should be, don't attend a hearing without an advocate, a lawyer. I've never been called before a Board, and I hope never to be.

Not all surveyors appreciate competition from non-licensed people who get construction layout contracts they wanted for themselves. Know the law and stay within it. If you are unlicensed, make friends of your local surveyors whenever possible and walk softly around those who put you on notice that they don't like what you're doing. If you give them cause, they may report you to the Board.

### **Set primary off-site control where possible. When running your control, be precise!**

OK. Whether you're licensed or not, your core construction layout needs require that you perform the same preliminary activities before you can provide layout.

Let's start with your first, post-award visit to the site. You are here to set your control points for all future layout. This should always include a closed traverse, so that you can verify the accuracy of your work. Set primary off-site control points in places where you expect them to remain undisturbed throughout the course of the new construction and on-site control points where you think they will last throughout construction. Often I try to place such control well outside the clearing limits and often across the street from the project or on adjacent property where that's legal (or if necessary permissions have been obtained). When feasible, I like to set drill holes in a sidewalk or some distinct, stable points not likely to be disturbed or covered by vehicles or snow banks in colder climates.

Off-site control should usually be a part of your on-site, closed traverse used to locate the existing evidence of property corners. Wherever possible, set on-site control where it will survive the new construction.

One key to profitability in construction layout is knowing how much precision is required for different types of layout and not fussing to obtain a high degree of precision (or accuracy) when its unnecessary to do so. This is a real challenge for an anal-retentive personality, a nature often present in surveyors.

And, the key to learning how much precision or accuracy is required is to ASK. Who should you ask?

Ask lots of questions of the people actually constructing what you are staking. These people know what most surveyors and many engineers never really know. Ask different people on different sites who perform similar sorts of construction, "How accurate do I really need to stake this?"

Want to know how accurate your work has to be when staking sanitary sewers? Ask three or four different contractors constructing sanitary sewers on different sites. Ask how precise both horizontal and vertical (elevation) references (your stakes) have to be. Ask whether they generally prefer two offset stakes on line with the proposed manhole, say for example a 10' and a 20' offset stake, or do they like a 10' offset stake set at 90 degrees to the line back and another 10' offset stake set at 90 degrees to the line ahead. Ask everything you can think of. Take notes. Compile and compare the answers you've received. Do all their answers agree? If so, you've probably learned in general what level of precision to put into staking typical sanitary sewer construction and where in relation to the manholes most contractors like your stakes to be set.

And don't forget to ask what they can think of that might be exceptions to whatever guidelines they've given. For example, a storm catch basin that has a flat top and is designed to be constructed in the middle of a parking lot driveway could probably be constructed a half foot off, to one side or the other of the dead-center of the drive. But, a basin fit into the curb line, having a pre-cast concrete top with its own curb section might cause a problem in the curb alignment if set a half foot off. Don't use this as a fact, unless you confirm it for your specific application. I'm just illustrating what you are trying to determine when you ask the experts – the ones who use your stakes to construct everything on site.

OK. Back to the control network you're establishing. BE PRECISE! Never wonder how precise the control network for a project should be. Do your very best work. Just believe me on this one if you have any doubt. When running your control loop, always, *always* be as precise as your equipment allows. Be certain all your equipment is adjusted prior to running the traverse – the optical or laser plumb of your instrument, the tribrachs, the prism poles, the cross hairs of the instrument, everything you use! Set the correct PPM setting in the instrument for the weather conditions of the day. Turn multiple angles sighting with direct and inverted scope.

I always run the initial control traverse with foresights and backsights set on tripods, with tribrachs that I know to be sighting accurately through the optical plumb. I measure and record heights of instrument and prisms in decimal feet plus feet-and-inches or meters for verification.

And here's a tip. Make sightings on prisms with care, wagging the head so the eye moves side to side behind the instrument's eyepiece to check critical focus. If the cross-hair appears to move on the target as the head wags side to side, the scope is not properly in focus, even if the naked eye can't notice that the focus is not quite correct. Sighting errors due to parallax are common if the

instrument is not focused exactly. This is typically overlooked and is often a source of error. When precision matters, always check for parallax in this way.

## Run Your Traverse **PRECISELY!**

Why such concern for the precision and accuracy of the traverse? Consider the following illustration of how things go in the real world of construction layout.

Suppose you've been awarded a contract to perform construction layout for a facility on a site that measures about 600 feet by 1500 feet. The new building will be cross shaped with one leg of the cross measuring 400 feet and the other 500 feet. To keep your primary control traverse outside the limits of new construction, you run around the outside of the site, on opposite sides of the road wherever possible.

This hypothetical example is illustrated in *Figure 6*, below. Refer to it so the written explanation makes sense.

In this example, for the sake of illustration, suppose the following:

- Traverse length 4,300 , more or less
- The site is nearly level throughout – less than ten feet difference in elevation distributed evenly over its entire length, rolling gently from one end to the other.
- Distance from #4 to #6 = 660 feet, more or less. These are drill holes set in a sidewalk on the opposite side of the street from the site, and #5 is a point on line between #4 and #6. Distance #6 to #7 is another 245 feet.
- Your raw error of closure for your closed traverse is 1:10000.

Well, you usually do better but, hey, 1:10,000 is good enough, right?

You adjust the traverse as usual, knowing the 0.43 ft. error of closure will be distributed over the 14 legs of the traverse. No big deal, you think.

After the site is cleared and rough graded, your client asks you to stake the building. Your client wants two control rectangles for the building, one for each major group of columns. These two sections of the building are at right angles to one another.

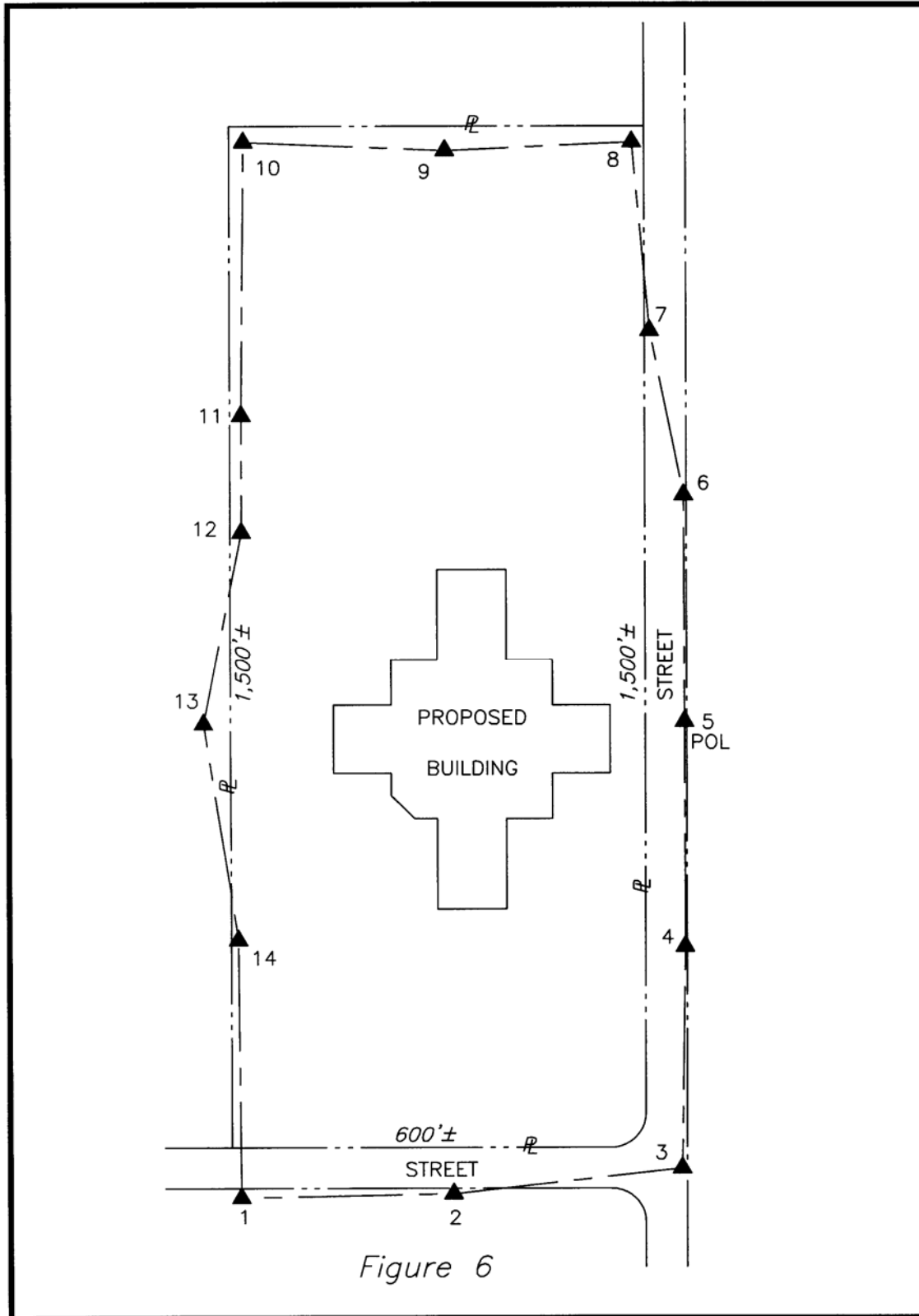



After the site is cleared and rough graded, your client asks you to stake the building. Your client wants two control rectangles for the building, one for each major group of columns. These two sections of the building are at right angles to one another.

At this point, you feel very proud of yourself because you set your traverse anticipating this exact circumstance. You took the trouble to set your traverse points where they'd facilitate this layout. You even set #5 as a point-on-line between #4 and #6, so that you'd have three traverse points that would last throughout the course of the job. You located them along the sidewalk across the street. Not only that, you placed #5 and #13 so that they could be useful to layout one leg of the building's control if needed. You planned to shoot across the site between #5 and #13 as you ran your traverse, but the site was lightly wooded at the time. You didn't realize until you occupied #13 that there was a tree on line blocking your view of #5. You decided to skip tying across the traverse.

So, for the building layout, you arrive on the site ready to fly through the assignment because of your forethought and planning in setting up your control traverse. But, when you arrive, you notice that something new has been added: topsoil stockpiles – two of them. You're faced with the situation illustrated in *Figure 7*, a blown-up section of *Figure 6*.

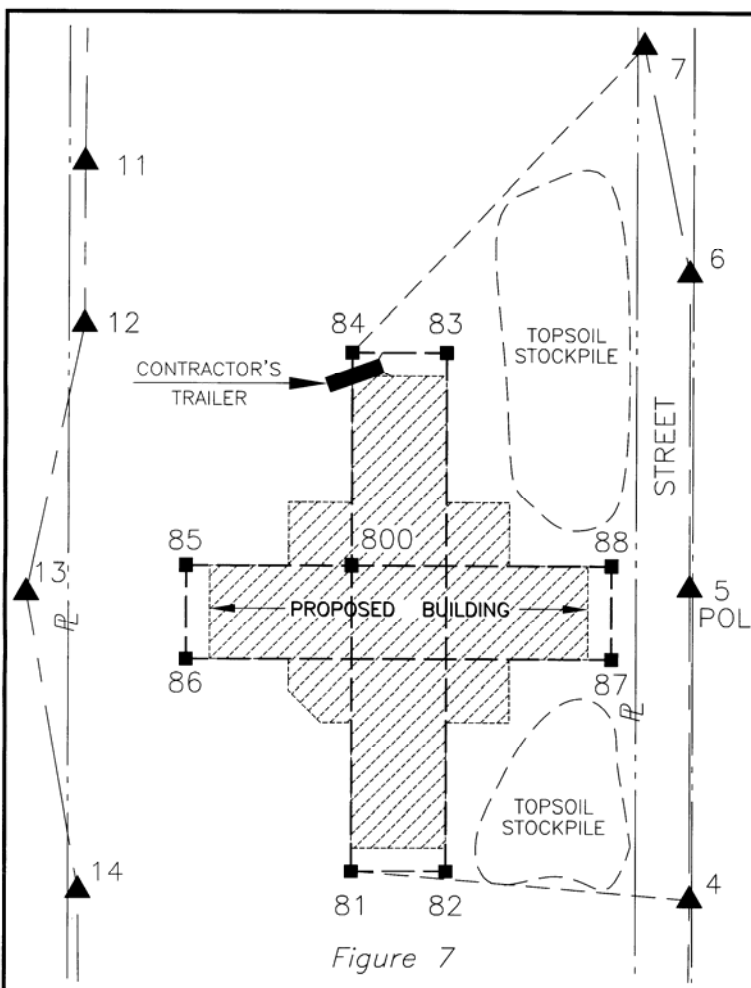

You had a plan for staking the building, but you'll work around this unforeseen development of finding stockpiles of topsoil in your way. You set your instrument on #4 and backsight #5 and then turn an angle to set #82. But, you hit smack into the side of the stockpile. Same with #81. Still, with a little help from a backhoe operator you chatted-up on some other project, the edge of the stockpile is soon cut away, and you radially stake #81 from #4.

Next you set on #81 and backsight #4. From this setup, you intend to stake #84, but when you turn the angle, you hit the trailer part of a tractor-trailer that the plumbing contractor parked on the site. No one is there to move it. No problem. You stake #800 and #82. You check the angle 800-81-82 and confirm that it's 90 degrees, dead-on. Distance 81-82 is perfect, also. Now you're cranking!

You advance the instrument to #800, backsight #81, turn 90 degrees and set #85, then 270 degrees and set #88. While on #800, you radially stake #86, #87 and #83. You know you can check and adjust these slightly later if needed.

You next set the instrument on #88 and backsight #85. You check the diagonal angle 85-88-86 and distance 88-86 and find everything is tight. Next, you turn to #87 and get a real good check on 270 degrees. Distance to #87 is good, too. Your radial staking is doing great.

You turn the angle to set #83 and again see dirt; the other stockpile is smack in the way. A little nervous now you turn the angle to set #84 and find that, sure enough, Murphy's Law got you; all you see in your scope is the dead trailer. What a rotten break.

While you're here on #88, you decide to check into POL #5, just to be sure everything is on track. Your distance checks within a hundredth of a foot or so, but your angle is off by over a minute. Now you're beginning to sweat. But still, everything you've staked for the building and been able to check is tight so far. You're not sure what's going on with #5 failing to check, but you decide to keep moving and see what happens.

Since you staked #83 radially and have been unable to check it, you consider your options. You could see #83 from #82, but you'd be checking a radial stakeout *with* a radial stakeout. Trying to set #84 has challenged your manhood. (If you're a woman reading this, you've seen how obsessed men can get when things go wrong. If you'd been there, you probably would just stop, think and analyze and come up with a better idea than our hypothetical man. But, for the sake of what I'm trying to illustrate, just bear with this example.)

On impulse, you set the instrument on traverse point #7, backsight #6 and turn the angle to check #83, one of the points that you radially staked from #800. If this checks well, you feel you can be reasonably confident in setting on it (#83), backsighting #82, turning 90 degrees and staking #84, even though you can't see much of anything with that darn trailer on line. You're mumbling aloud now, "Why did the plumber have to park it there?" You set the angle to #83 in the gun, look through the scope and again see only dirt. The stockpile is on line. You say a bad word.

You're having more bad thoughts about that plumber, but you steady yourself as you dial up the angle to set #84.

"Take that, Murphy!" you shout. You can see past the stockpile to stake #84; your line of sight is just grazing the stockpile. As your assistant goes to set #84, you have him stomp the edge of the stockpile, and you now see through nice and clear. You're feeling better, now. You set #84, from #7, realizing that the moment of truth is coming.

You advance the instrument to #84, backsight #7 and turn the computed angle to check #83. If this checks, you're as certain as you can be (since that trailer's in the way) that everything is OK. You'd hoped for clear lines of sight, but what can you do? You look through the scope to compare this theoretical position for #83 with what you staked from #800.

Your assistant is holds the prism pole on the staked position of #83 and steadily looks at the level vial. But, he hears nothing from you for some time and glances up. He sees that you're walking in circles behind the instrument, shaking your head and muttering. Your fists are clenched.

This is because you missed hitting the #83 hub entirely. You're off its left edge, over 8 hundredths of a foot from the tack you set from #800. This you know is about one inch, and that's nowhere near tight enough. Something is wrong. What to do now? Check another point. Check #85.

You turn to check between #84 and #85, and now you really lose your cool. That plumber's trailer is blocking that line of sight, too. Your assistant stands very still, waiting for the moment to pass, as you look to the heavens and let out a primal scream. "How can you be so far off?"

You had a decent closure on your traverse, and everything up to this point checked so well... except the angle to POL #5, you recall.

And, this is the clue you are looking for. Think about it.

### **Traverse Adjustment. Time to rethink it?**

The distance from the traverse point you started the building layout from (#4) and the one you last occupied (#7) is over 900 feet. If 1:10,000 (your traverse's closure) is applied along that distance you have a possible difference between the distances you measured when you ran the traverse and the adjusted traverse of 0.09 ft. Did the adjusted traverse differ from the sum of the observed distances from #4 to #7 by 0.09? By half that? Even half a tenth is way too much to let float for steel column layout.

The worst of this is that even many surveyors wouldn't suspect of their traverse *adjustment* as the culprit. But, if the traverse adjustment contributed even half a tenth to the "error" and your work is perhaps another two or three hundredths off, then your instrument could conceivably report an error of seven hundredths of a foot in this hypothetical. And, this is really too much. If you don't realize that your traverse *adjustment* has mathematically ruined your ability to repeat measurements and get the same result as before, you don't know where the error is or what caused it. In such a case, there's nothing to do but to find it and fix it – or try some other layout approach. This is a dilemma – a situation in which there are two choices, and they both stink.

### **To adjust your traverse or not to? That is the question.**

If you are a surveyor, you're likely to adjust your traverse out of habit. The point to remember from this example is, you may want to *check* your traverse closure but not allow the computer to adjust it. Or you could decide to manually constrain the adjustment in areas where you know you need to repeat your original observed relationships of angle and distance.

In this example, you know you will want to use at least #4, #5 and #6 for the building layout. Your traverse closure is not all that good, and you probably don't want those points to have any relationship other than what you observed on them when you ran the traverse. In other words, you don't want them mathematically adjusted to distribute the error. Why? Because being able to repeat your actual field-measured distances between those points is the only way you can lay out one end of the building from #4 and the other end of the building from #6 or #7 and still have the overall length of the building check.

In our day, pushing a button to balance a traverse works for most boundary surveying, but not always for construction layout.

In the above example, many of us when hunting for the source of our error would have neglected the traverse adjustment as a prime suspect, especially when we're ranting and raving about the plumber's trailer instead of keeping a cool, analytical, thoughtful, practical head on our shoulders.

You may recall that several paragraphs back, I urged, BE PRECISE. Your traverse CAN'T be too tight. Consider the same situation if you had a 1:40,000 closure instead of the 1:10,000 closure. The maximum likely adjustment between #4 and #7 is more like two hundredths in that case. Why not constrain those points to observed values (for the sake of the building layout) and let the rest of the traverse that will be used for less critical layout be the place where closure adjustments are made?

I'm not recommending any single approach except to say that, from my own experience, the control on a site NEVER gets better as the project progresses. It only gets worse. I learned to put effort into establishing the primary control, looking for 1:30,000 to 1:40,000 as a norm. In the end, on a large project, it saved me more to fuss at this initial stage than it cost to wrestle with problems later. And, I learned to constrain some points to their observed relationships in areas that would later be used for critical layout. Usually, the only layout on a site that can't tolerate being a tenth or two off horizontally is the building layout. And, you've got to do some real sloppy traverse work to result in alignment or distance problems of two tenths of a foot between any two items to be constructed on the site, even after you constrain some traverse points near the proposed building.

I've taken some time with this example for a couple of reasons. First, to illustrate what can and usually does go wrong on the site. Stuff gets in the way. Second, to encourage you to reconsider the button-push adjustment method we all use today. Third, to emphasize the critical aspects at the start of a construction layout project. This is the point at which certain things MUST come together, or you delay the project. Coordination is very, very important at this point.

You can't always sit back and wait to be awarded the contract before doing some preliminary work on the site – even on speculation. The timing at the start of a project is always tight. Your client's construction management personnel almost never realize that they can't call you on Monday to start staking for construction the next morning.

You have to set your primary control, locate it PRECISELY, and adjust it (with human analysis, forethought and care).

Only then are you ready to relate your control traverse and all the evidence you found to the design drawings and coordinate data you've accumulated.

With this field and proposed data in hand, you're ready to create the Geometric Plan.

## **Geometric Plan Preparation**

The geometric plan has been introduced and discussed in earlier sections of this course. In this section we're speaking about typical layout requirements, and it's worth expanding briefly in this context. I also encourage the earnest course-taker to review the material on the Geometric Plan earlier in this course, and then come back to this place and continue studying.

The Geometric Plan is your prerequisite to actually staking in the field. Once your preparation of the Geometric Plan has been completed and you've verified the data you've received from Engineers and other professionals on the design team, you're ready to actually stake something.

Again, and I can't emphasize this enough to save YOU from avoidable stress, this is the CRUNCH time for most layout projects. You may be awarded the contract one day and asked to stake clearing limits the next. This is generally difficult to impossible. It's important to get across to your client that initial lead-time is required between being awarded the contract and the first call for layout to allow you to prepare your essential base-work for the project.

But, unless your client is the best-of-the-best, you may have to scramble to satisfy the client at the start of construction. Be flexible. If you are viewed as the person who single-handedly got the project off to a start BEHIND SCHEDULE (two VERY bad words), you've got an uphill battle to win this client's praises in the future. And, we all know about first impressions, don't we?

## **You, the cause of being behind schedule.**

This is an aside, but something critical to your understanding. The contractors who need your layout completed in order to begin their work will blame you for them not showing on the site. They'll say, "We were all ready to work on this project, but the construction layout was lacking, so we went to another project that was ready. Now we're stuck here for the rest of the week. We can't just pick up and leave this half completed."

They will say this even though they wouldn't have made it to the project that you're staking if your stakes *had* been there. In addition, they'll use your tardiness as an excuse to pull off the job and go to another, thus satisfying some other raging customer of theirs who's been put off through various excuses.

In short, you'll be blamed for delays whenever you don't stake within your client's requested time frame. How often, I've been told that a certain contractor is waiting on my layout to service the site. I go and do the staking, yet that contractor doesn't show up on that site for days afterward. But, this is not my business. My business, and yours, is to stake when asked. This shuts the mouths of those needing an excuse, and that's good business for you and me.

Remember that construction is a critical path management challenge for the construction manager. The nature of it is: this thing must happen before that thing can take place. Your layout must happen before much of the site and initial building construction can commence. Your role, though a small part of the construction budget, is a vital one. This is why you are so conveniently poised to be blamed for delays in the schedule.

The best defense is to just do what you're asked when you're asked, whenever humanly possible. The inconvenience you suffer is a cost of doing business – construction layout business. Get used to it.

## **Stake Clearing Limits**

OK. From this point, we assume you are either a licensed surveyor or that you have obtained what you need from one in order to tie your control to property corners or other documented control set by a licensed surveyor; you've computed and found agreement between field evidence and plan data, made appropriate adjustments, and you are ready to stake!

Your first call for staking is often to mark clearing limits. Be sure you know how critical this layout needs to be. The more populated and developed the region, the more accuracy you'll need to bring to this task. Check your plans VERY carefully for any 'hard' dimensions associated with clearing limits and any specific 'trees to be saved.'

If there are specific trees to be saved, discuss with your client how to mark this. Should you stake the drip line of the trees to be saved? If you simply flag the tree trunks, will the contractor fence around them, or will the excavator know enough to stay off their roots? (As you may know, compacting the soil over the roots of trees with heavy equipment can kill them.)

Make sure you get a signed work order that reflects your client's express directions. Remember, when that tree is gone, your flagging and stakes will be gone along with any visible evidence that you marked it for preservation as directed. Document your instructions on the work order and drop a short note or e-mail to your client's office or project manager stating what you've staked and how you've staked it.

General Principle: After e-mailing any important communication, print and file your e-mail. Print it AFTER you've sent it so that it bears the date and time sent. In that e-mail, you state that you have marked for preservation x-number of trees as directed by so-and-so [trunks only or at drip line] as noted on Work Order #\_\_\_\_\_ dated \_\_\_\_\_.

Failure to document this could cost you the price of setting large, mature trees to replace the goners, and maybe even fines. Don't buy any trees!

If you are a modern surveyor, you like to radially stake from coordinates uploaded to the data collector. When I started surveying, there was no such thing as a portable calculator. Just stop and think about this if you're considerably younger than I am. There may have been one electronic distance measuring device in the entire state at the time I started surveying. (I heard rumors such a device existed, but I'd never seen one in 1963 and frankly doubted its existence.) One thing I was absolutely certain of back then: As long as I had a steady hand, I'd always have a job. I was a draftsman, and a good one. I was certain that nobody could EVER make a machine that could draft a map! Of this I was very confident.

I love the way we do things now. I was the first surveyor I knew who closed traverses in the field before returning to the office. I wrote my own programs that could carry 44 points when popular computing devices weighing 40 times that of mine couldn't carry a point's coordinates from one operation to the next.

By the mid-1980's, I worked out of a van conversion of my own design and computed in the field at a wall-to-wall drafting table inside the van, communicating by mobile phone (that cost \$1,400!) to my office, and I carried a pager. Sometimes, I computed in the van while my crew worked on site. I listened to their communications through a radio in the van and could thereby pick up on any confusion or need for direction they might have while I worked on computations. This facilitated training and allowing a junior party chief to try his wings at leading the crew as I listened to their verbal communications.

I love technology and have always pioneered in it if given the chance. And, I've made a lot of money by NOT waiting for the prices to come down.



BUT... I'm old enough to remember creative ways to get things done. It usually is possible for you to stake clearing limits before your Geometric Plan is ready. If the boundaries are well marked with fences or walls and the limits can be related to these or to specific trees or other physical objects on the plan, and you are both clever AND careful, then you may be able to do your magic without having any coordinates already computed and uploaded to a data collector. I've done it many times with an engineers scale and cloth tape.

Remember, that gray-haired superintendent on the site has done it knowing nothing about coordinates, so you may not be able to sell the idea that you need a week to compute and verify everything before staking clearing limits. But, staking clearing limits and MAYBE even staking for rough grade by scaling off the plans is generally my limit for staking on a site before my Geometric Plan is complete. Use good business and good risk-management judgment if you're pressed by your client to stake clearing limits before you think you are confident and ready. Better to do it right and late than to do it wrong and early. Best to do it early *and* right.

The good news is that staking the clearing limits will generally keep your client off your back for a while.

A site that's already cleared by demolition activities by the time you get the news that the job is yours can really stretch you at the start of your contract.

## Stake Rough Grade

Rough Grade stakes guide the earthmoving that gets the site from whatever elevations it was at prior to construction to its approximate final grade. Staking this can be accomplished conveniently using a data collector uploaded with 3D point data based on design grades at the points being staked.

Good data collectors allow you to radial-stake your point and then record a shot you take on the point you've just staked. They can report cut or fill – without tedious hunting through menus and having to re-enter your set-up data to stake another point. If you do a lot of construction layout, be sure to verify this capability exists in your data collector prior to purchase.

By including the Z value (elevation) of proposed points while you're calculating in the office, you can expedite the layout. Uploaded N-E-Z coordinates of points to be staked can make your staking process a one-stop effort. Of course, in some cases GPS can be used, too.

You may be asked to mark your cuts and fills to some grade that is below the final proposed grades shown on the plans. For example, in a parking lot, the final grade shown on the site plans is to the top of pavement. But, to achieve that grade, the area to be paved needs to be cut lower than final grade to allow for crushed stone and a base course of paving to be placed below the top course of asphalt. When staking rough grade for the concrete slab of a building, the finish floor elevation is not the grade the contractor is likely to want referenced on your stakes because the earth beneath the slab must be at a certain distance below the eventual top of slab elevation to allow for its base and the thickness of the concrete.

Take care in marking stakes!

Be certain to document what grade your stakes reference (sub-grade, finish grade) and what point on the stake to use as the reference for those cuts and fills (top of stake, ground at stake or mark on side of stake). For lack of knowing how important this is, I almost paid costs of excavating and carrying 25,000 cubic yards of fill off the site, for trucking it back to the same site it had been removed from, and for the costs of regrading and compacting that fill. (Sounds like the Army doesn't it? Dig a hole and fill it in.)

This is how the 25,000 cubic yard mix-up happened: When starting out in construction layout, I staked rough grade and noted the cuts and fills on guard stakes. The cut and fill notations that I marked on the side of the tall stakes were referenced from the TOP of the tall stakes. But, I didn't note anywhere that the top of the stake was the point referenced. This worked fine for several projects, until...

An equipment operator on a 10-acre site thought my cuts and fills were referenced from the ground at the **BOTTOM** of the stake. I used 24" tall stakes for the layout, so the whole site was cut to almost two feet below design grade due to that lack of communication – and I almost had to pick up the tab for that error. Have you done the math on this one? I'd still be paying for it, or maybe hiding in Brazil.

Ever since that near miss with the grim reaper, when tall stakes alone are requested to control grades, I mark those stakes in the fashion illustrated below:

This method eliminates confusion over what point on the stake the excavator should use to measure cuts and fills. This should avoid any possible confusion when marking stakes for rough grade, right?

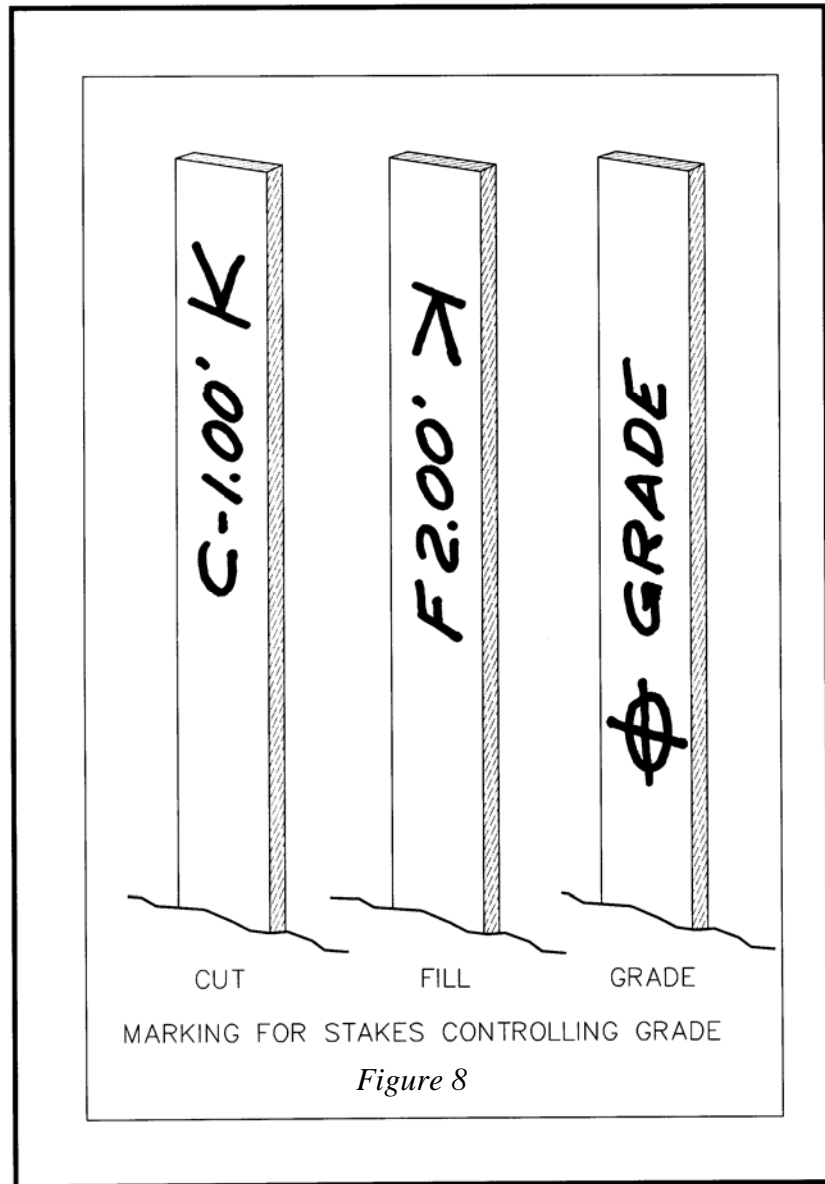

No, not really. This alone does not remedy the potential for confusion over whether you've referenced your cuts and fills to final pavement grade or to subgrade; to top of building slab or

grade on which construction materials (crushed stone, etc.) will be placed. This is a critical distinction and you may pay for any confusion you create – or even for any confusion you fail to eliminate.

In your contract, you may wish to include a phrase to the effect that you will not be responsible for communicating directly with other subcontractors regarding your layout because you are not regularly on the site; and that your client will be responsible for relaying all information you provide to your client's individual sub-contractors.

Be CERTAIN to advise your client in writing of any pertinent information that can't be written on the stakes. For example, write: "At the direction of Mel Harper, foreman for Lightwell Excavation, all rough grade stakes reference two inches below finish grade for unpaved areas of the proposed site and six inches under drives, parking and the building's proposed finish floor elevation. This direction was given by Mel in person to Pete Flannery, my party chief, at 10 o'clock in the morning, last Wednesday, the 14<sup>th</sup> of September as recorded on our conversation log."

Thus, I repeat a principle that applies to ALL your staking, though the near-miss just related occurred while I was staking for rough grade: Take care in marking stakes! YOU may know where on the stakes the cuts apply and what grade you are actually referencing, but be sure the people performing the construction know what you're thinking.

At this point, in view of the 25,000 yards of material I almost bought (plus all associated costs), consider this: Rough grade staking, while not immune to liability concerns, does not demand ultra-precision in most cases. If a stake for rough grading the open areas of the site is a foot left or right of an exact position, how much is the rough grade impacted by that? If a stake here or there is a couple of tenths off for elevation, can the site be rough graded to any closer tolerance than that anyway? One might reasonably generalize that staking for rough grade is not super-critical layout in most cases.

This is what probably tripped me up and almost cost me more than I could afford to pay. True, the rough grade staking did not demand extreme precision. But, COMMUNICATION about that (or ANY other) staking ALWAYS requires redundancy, precision and written documentation.

Be sure you are out of the firing line when some contractor misinterprets your intentions. Generally, if you have faithfully informed your client, then your client is responsible to pass that information along. But, tell those using your layout anything they need to know if you have the opportunity, and try to leave nothing to anyone's imagination.

## **Stake Building Pad for Grade**

Often you will be asked to provide grade for the building, particularly if it is a large building to be constructed on a slab, like a strip shopping center for example. The above advice bears repeating: be certain to ask your client what grade is to be referenced, top of slab or some specific depth below that. Also, use a different color-scheme for your flagging on stakes referencing building grades. This will help the equipment operators visualize this area of the site more readily. Compaction may be an issue under the building and paved areas but not in the future open or landscaped areas. You can set yourself apart from your competition by being

sensitive to this and making a picture for the users of your stakes through creatively flagging different features your rough grade in distinctive colors.

## Stake Roadway Rough Grade

If staking for a road, most contractors will prefer stakes placed at offsets from the centerline, so that the equipment operator can grade the road without grading around stakes set down the center of the road. But, don't assume this. Ask. In many large-scale developments, the area of future roads will be cleared and cut to grade prior to constructing other, proposed improvements. This facilitates access to different portions of the site for the workers and their machinery. The contractor grading the road may prefer the centerline of the proposed road staked at this early point. It's best to give the users of your stakes what they want and not what you *think* they want. When centerline of road stakes are requested, these be used for clearing and rough grading, and offset stakes may be required later for paving and curbing. As in all things, know your contractual obligations and get paid for work beyond what your contract commits you to perform at set fees.

If you're staking the overall site and the road at the same time, be certain to use distinctive flagging on stakes used for the road, and mark all stakes clearly in large, neat characters, so the operator can see what the grade should be without getting off his machine.

## Stake for Blasting

Here's a true story about precision, accuracy and profit:

Once, when my business was slow, I subcontracted for a firm that employed me before I opened my own business. My mission was to stake water line for blasting. The project limits covered a vast area. I was given design drawings (site plans), a map depicting the general location of control points along with a listing of their coordinates, and coordinates of the proposed water line points to be staked.

For some reason, the future roadways had been cleared quite some time before my arrival on the site. It appeared that the project must have sat idle for years. Finding the original control points was more challenging than expected. My reconnaissance at the site recovered only a couple of control points near the start of the staking, but nothing near the end point of my assignment, about a mile away. In the project folder I'd been given, I found a plan showing an earlier phase's control points with their coordinates noted. As I reached the end of my staking for blasting, I tied into a point on that other site (also surveyed by the same firm) by quickly traversing a couple thousand feet to reach those points.

When I reported back to the person who ran my former employer's six or eight field crews, he asked how I'd made out.

"Oh fine," I said. "The control near the end of the water line staking has been totally destroyed, but I found points in Phase 1 and made a quick traverse over to them. I checked in missing by less than half a foot off."

"Oh gosh," the man said as his eyebrows narrowed into a worried look, "I hope that's close enough. That's only a 6" water line, you know." He face bore a look of deep concern.

“George,” I said (not his real name of course), “where they’ve already blasted on Phase 2, the earth mounded up about six feet high with something that looks like huge chunks of granite the size of your drafting table. That blasting is creating a very wide swath under the ground. Besides, they can’t lay that 6” line using a 6” bucket on the excavator. The trench will be at least two feet wide. There can’t be a problem with the staking when I check in half a mile beyond the end of the run within half a foot. And, George, all our stakes were placed on the waterline’s path, not offset; they are marked, ‘FOR BLASTING,’ and they’ll be destroyed by the blasting operation. Your crews will be back there staking the waterline for construction. This staking was only for blasting. There’s absolutely no way it isn’t good enough.”

That chief of parties was the best I’d ever seen at overseeing over a half dozen crews. But, he didn’t know the variables of construction layout very well.

Point of this story: If you want to make money, know what accuracy is required for whatever you’re staking and adjust your methods accordingly – unless, of course, you love pointless precision more than money. In that case, indulge yourself, if you can afford it.

### **Speaking of Required Precision...**

At another firm, working as an employee, I was always sent out by the firm’s owner on significant construction layout assignments. This was because his regular party chief was terrified of construction layout. He’d been with my boss’s firm a long time, but the firm didn’t do a lot of construction layout, and this party chief was unnerved by it. So, I was a party chief over the regular party chief on complex construction layout projects or any layout prone to high-liability.

On one such mission, we were staking clearing limits for a single family residence in the middle of a 40-acre, wooded site. Now, this was *not* precision work, and I really can’t be sure why I was needed to supplement the party chief’s talents on that day. But, my boss said go, and getting out of the office is always refreshing.

Whatever, I was running the instrument and remember saying over the radio to this fastidious party chief known for his penchant for precision, “OK, go back 8 tenths and stake it.”

I turned the angle off that point and was setting the angle for the next clearing limit stake when over the radio came his voice saying, “Check me here, Jon.”

Now, this guy was seasoned and would have no trouble estimating the 8 tenths of a foot I’d told him to go back to set the stake. And, if he staked it within two feet in that particular setting, it would have been almost too precise anyway. But, this poor soul lived for precision. He couldn’t let go of his quest for it, even if it made the work take three times as long. He was a precision junkie. I knew that if I’d not been out there running the crew in his place, he would have made the work take considerably longer.

“Two feet off is too close,” I replied, “Just nail it.” He got mad at me because I refused to reset the first angle and check him a second time.

So, if you want to make money doing construction layout, match the accuracy to the need. Often your competition is a lot like this guy I was working with that day. They will take too long on

stuff that doesn't matter, blow their budget and then try to save the project by skimping on what really does deserve precision. This is your lucky break, because you can compete with these people, underbid them, and make money, too.

Also, the seasoned construction personnel on the site, including the employees of the firm that hired you (or your boss), will be refreshed to see someone with the ability to let go of precision when it's wasteful, and it's slowing down the project.

## **Stake Building**

Often the building construction on a commercial, industrial or institutional site will take place consecutively with the site construction. Offset stakes must be set close enough to the future building to not be destroyed by site construction yet far enough away to survive building excavation and construction. Be guided by the site superintendent or the building sub-contractor on placement of stakes.

## **Stake Control Rectangle**

If staking a control rectangle, normally the four longest walls or outermost column lines will be offset. This approach is generally used for single family residences and "row-house" types of multi-family buildings. A control rectangle may be requested for commercial buildings that are essentially rectangular in shape, especially if the building contractor has layout capabilities sufficient to take your basic layout and develop remaining control from there.

## **Stake Column Lines**

For very large custom homes and larger structures, clients frequently request staking of offsets from proposed columns. The column layout of buildings is generally some rectangular array with or without some additional columns set between the basic array.

A very simple example of a column array and essential staking of offsets on column lines is depicted below in *Figure 9*:



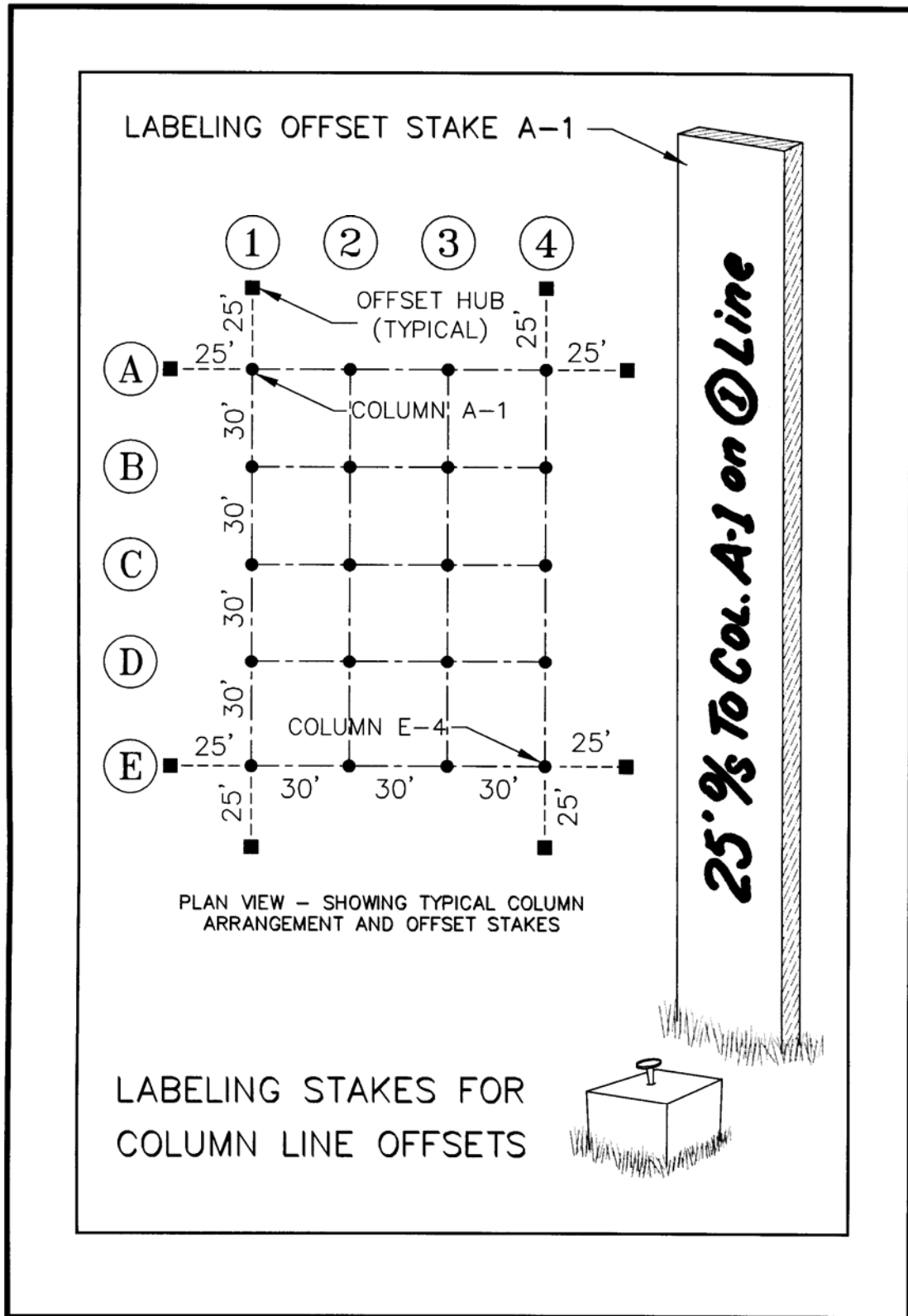

Figure 9

Columns are individually identified by the grid, for example, Column A-1 or Column D-3. Often, intermediate columns are located in between the major grid of columns to meet some specific structural need. If the column is located midway between the D and E lines and the 2 and 3 lines, the column might be designated as column D.5-2.5.

When staking column offsets, it is important to note not only the column being offset but also what column line the offset stake is placed on. Note that the sample stake labeling of Figure 9 depicts not only the offset to the named column (A-1), but the column line the stake is set on, column line 1.

Similarly then, the stake labeling for the other offset to Column A-1 in Figure 9 should read:

*25' <sup>0</sup>/<sub>s</sub> To Col. A-1 on (A) line*

The principle, one which is best applied to ALL construction layout is, LEAVE NOTHING TO THE IMAGINATION. Be specific. The person using the stakes is not as familiar with the intent of the staking as the person setting the stakes. Whenever possible, make a sketch to depict what has been staked. This often benefits the persons using the stakes to place construction and can avoid mistakes. It can protect you from frivolous claims. Never allow anyone using your stakes to claim your labeling and/or sketches were confusing. I always strive to ask myself, “If I hadn’t prepared or set this layout, and all I knew about the stake in the ground is what I can learn from the stake labeling and the sketch, would I conclude the right information, or would I have unanswered questions?”

I once read a book on beekeeping. Early into the book I came across an unfamiliar term, “brood.” I kept reading, expecting the word would soon be defined, or I’d learn it’s meaning from the context in which it was used. At the end of the book, I still didn’t know the meaning of brood as it applies to bees. In fact, I was brooding over it. The author’s failing may be ours in construction layout: The author’s familiarity with his material made him insensitive to the lack of familiarity in the users of his product. When workers and equipment stand idle as supervisors walk around scratching their heads over your stake labeling and sketches, unable to figure out what exactly you’ve staked or what you mean by the labels or sketches, your popularity is diminishing rapidly.

Finally, when staking columns or column layout, keep in mind that some architectural specifications call for columns to be constructed within plus or minus 1/8<sup>th</sup> of an inch over the length of a 600 ft. long building. Good luck! This tells me that the spec-writer hasn’t done much surveying or constructing. It also tells me that I’d better set my stakes so that no one can find more than a hundredth of a foot (1/8<sup>th</sup> inch ) variance between stakes, and that I’d better get the overall length to check as close to the 1/8<sup>th</sup> inch as I can. And, this can be done – with good people and good equipment that’s finely adjusted.

I never skimp on column line layout and advise that you don’t either. Too many surveyors (known for their obsession with precision) blow their budget setting their rough-grade stakes to the nearest hundredth (for no good reason or practical purpose) or setting hubs-with-tacks plus tall stakes when tall stakes alone would suffice, and then rush through the building layout because they’ve blown their budget. Bad idea! Really bad idea. ALWAYS fuss with column staking.

How do we make our column layout precise and accurate? Prism poles must be carefully adjusted prior to building layout (as should your equipment), and a person skilled at holding the prism pole must be doing that job. A bi-pod attached to the prism pole may help a less steady person achieve the desired results, though it will slow things down a bit. One assistant superintendent I ran into actually SET column stakes using a tripod, tribrach and prism with target. He'd move it and move it until the instrument person told him he was over the point. Then, he'd have the instrument person run over and look through the optical plummet on the tribrach to guide him as he set his point. He'd then pick up the tripod, and repeat this to set the next point. To me, this smacks of overkill. And, even this degree of effort leaves room for errors due to the tripod level or the optical plummet —cross-hairs being out of adjustment. Good people with good equipment can perform accurate layout a lot faster with other methods.

### STAKING DOUBLE OFFSETS TO FOUR PRIMARY COLUMNS (VARIATION ON A CONTROL RECTANGLE)

How would I suggest staking column lines if my client asks me to double-offset stake the four outer columns (Columns A-1, A-4, E-1 and E-4)?

Let's assume our building has the column layout seen in illustration. First, stake a rectangle at the outermost, major-column's, gridline intersections. Simply put, stake the centerline of columns A-1, A-4, E-1 and E-4.

You may decide to radial-stake all four corner-columns, but do save time in the long run by doing this as precisely as possible, initially making a mark on the tops of hubs rather than tacks. You'll set tacks during your final adjustment.

Once these four points are staked, the rectangle formed by those four stakes **MUST** be checked for square by checking the angle and distance across the diagonal (the hypotenuse), the 90-degree angles at the corners and the distances of the four legs. How you do this is largely a matter of personal preference. Make any adjustments necessary to get your rectangle precise and accurate before proceeding.

If you took care with your radial staking, these final adjustments should be very small and will be made rather quickly. Most readers will know how to do this checking, but just in case you need refreshing,

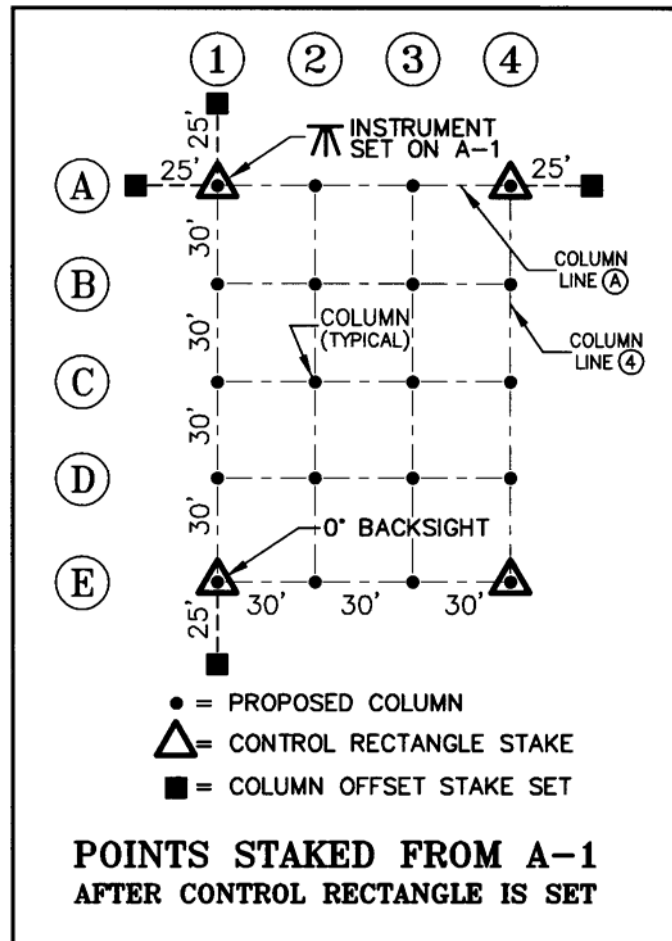

it's the Pythagorean Theorem to the rescue – gotta love that guy! Pythagoras says that the sums of the squares of the two short legs of a right triangle equal the square of its hypotenuse. The United States Naval Academy website offers a nice little animated graphic at <http://www.nadn.navy.mil/MathDept/mdm/pyth.html> to prove the theory. For a teaching aimed at 6<sup>th</sup> to 8<sup>th</sup> graders, visit <http://www.arcytech.org/java/pythagoras/index.html>. If you're not convinced, see 43 proofs for the theory at <http://www.cut-the-knot.org/pythagoras/index.shtml>.

Next, occupy a corner of the rectangle, say at Column A-1, backsight your stake already set as a corner of your rectangle at Column E-1 and set E-1's offset stake at the proper distance beyond E-1 on Line 1. Then flop the scope or turn 180 degrees and set the offset stake for Column A-1 on Line 1.

Then, turn 270 degrees and set one of the 25 ft. offset stakes for Column A-4. Of course, this line should check well on your rectangle's corner stake already set at Column A-4. Next, flop the scope or set 90 degrees and stake the remaining offset stake to Column A-1. When this is completed, check the backsight on Column E-1 to be sure the zero-set was not lost.

The instrument is now set over the control rectangle stake set at Column E-4, and zero is set backsighting A-4. The same procedure as noted immediately above completes the remaining offset staking, and all four primary columns are now offset staked. From these 8 offset stakes, the contractor can set remaining offset stakes with a steel tape and transit. Some contractors will take it from here.

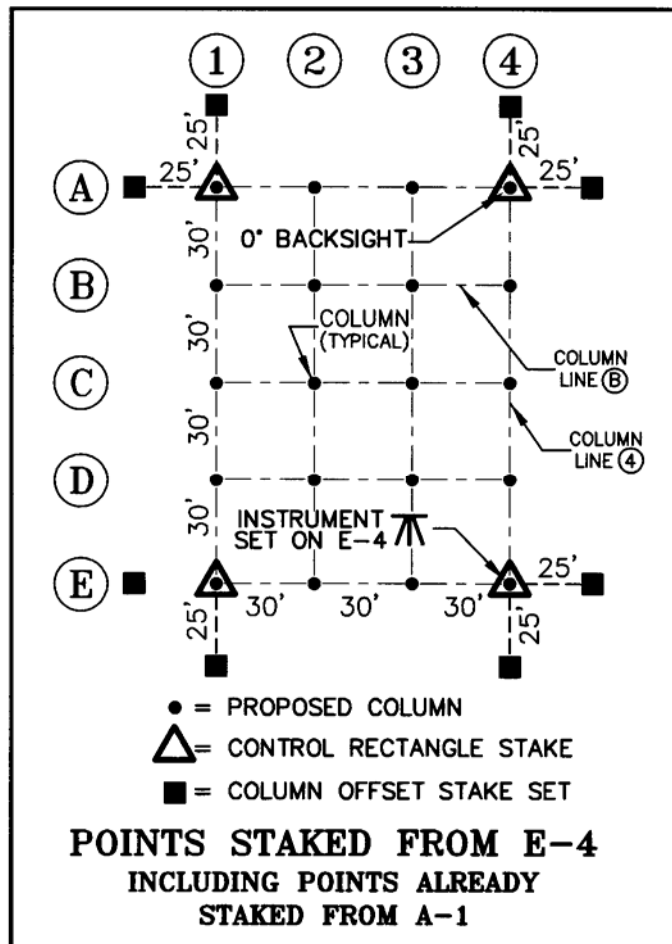

### Staking Column Offsets – All Major Column Lines

When asked to stake offsets to all the major column lines, the control rectangle is set at the four intersecting offset lines, and no actual column locations need normally be staked.

The control rectangle must first be staked and checked for 'square' and dimensional integrity as discussed above.

Next, #1 as shown in the illustration below is occupied with #2 backsighted. Offset stakes are set along the line to the backsight. Then, 270 degrees is turned, and that line, of course should be looking at #4. Offset stakes are set along the line between #1 and #4.

The backsight on #2 is checked to be certain the zero-angle is still good.

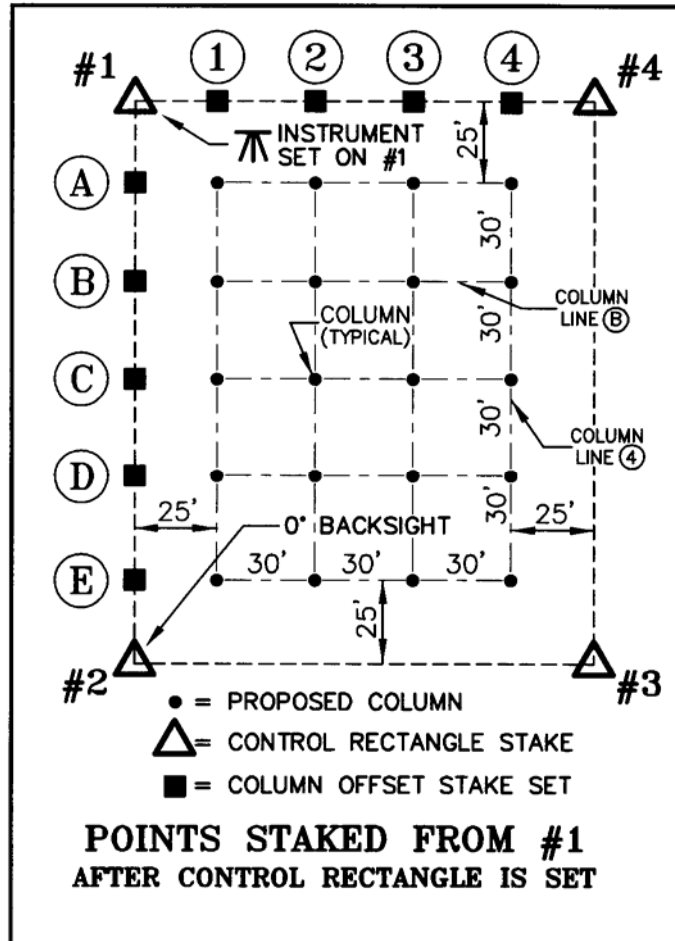

The instrument is next set on #3, with zero set sighting #4.

Offset stakes are set along the line between #3 and #4. Then 270 degrees is set in the instrument and this angle should be sighting on #2.

The offset stakes between #3 and #2 are set and the backsight checked to be sure it is still 0°, thus completing the staking of all the offsets.

Using this method may seem a bit old fashioned. One may argue, “Why not just stake it radially?”

With the best of equipment and personnel, that would probably yield results good enough, but the key word here is *probably*.

When your client sets up an instrument and sights along a line of offsets, it is important that they line perfectly. If they don't, you'll probably be receiving a call. And this is very hard to accomplish by radially staking. Also consider that you are talking about turning 22 angles in this example. Then you're telling the person with the prism to move back or come forward so much; then you're probably fine tuning line to set the hub and another shot is needed to set the tack; and for column layout, you'd better check that tack and adjust it if it's off a full hundredth.

But, by setting the rectangle, getting it TIGHT and turning only multiples of 90° angles, your layout proceeds quickly. Often you are on level ground for this layout, and you can use a quality steel tape for the layout and accomplish it rather quickly. This is really the best way and by far the safest way to perform column offset layout.

A reminder: Stakes must be labeled carefully as discussed above.

### Checking the Layout

No matter which method is used, I always check the layout before leaving the site.

Usually, I set the instrument in some random location where I can do a two- or three-point resection sighting my control points and see all the building points I've set.

I want the angle I record between two of the control points to be as close to 90 degrees as feasible, but in no case less than 45 degrees. The data collector will establish the coordinates of

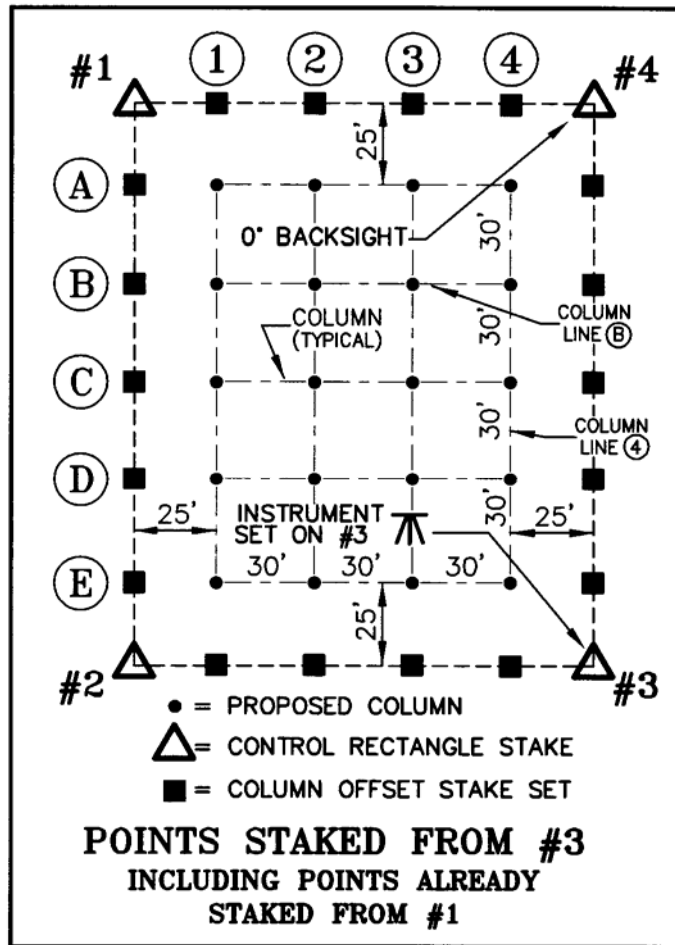



my position, which I sketch and note in a paper field book along with the essential data related to the staking of the control rectangle and the checking of it that I've already recorded.

To digress for a moment, some people record in their paper field books the point occupied, the point backsighted and every angle and distance they turn to set their stakes. This is pretty good evidence, particularly if logged in a bound field book rather than a loose-leaf style field book for obvious reasons. But, some party chiefs record the angles and distances before staking, often while sitting in the truck, and then do their layout from the collector, never taking their field book out of their pocket. This speeds things along, especially with a one-person-and-robotic-instrument approach or a two-person crew staking in a conventional manner. The problem here is that it is fabricated evidence. The angle and distance to the staked point should actually be shot on the as-staked point and logged to the paper field book. This is what really was staked, not the theoretical stuff from the collector.

Whether or not you keep a paper record is a personal choice. In this specific example, I download my collector files of this final check and make these a permanent part of the project files. Both raw files and coordinate files generated in the collector should be kept.

Meanwhile, back on the random point... From the random point, I locate and record in the data collector every building stake I set. Usually, I number the point numbers of the points I'm collecting some increment higher than the calculated point numbers for the points I just staked. For example, if the points I set were #501-519, I might number the check shots #1501-1519.

Then, while still on the site, I inverse between the theoretical, computed locations of the points set and actual shots taken on the stakes themselves. This inversing is somewhat easier if the points are incremented as noted above.

I am hoping for little more than 0.01 ft. between the inverses. In some cases, they may all be off 0.02 ft. or 0.03 ft. in generally the same direction (same bearing or azimuth). This would indicate some difference between the control points I staked from and the ones used to establish the random point presently occupied.

This points out, as is noted elsewhere in this course, the importance of getting your initial control stable and located as precisely as you possibly can. Also, traverse adjustment can make this not check as well as you'd wish. The concept of NOT adjusting your traverse (for the sake of repeatability) is also discussed fully elsewhere in this course.

This random point must be located so that I can see the stakes I've set, or a second point from which I can see the remaining stakes I've set must be established in the same manner and documented in the paper field book. It is best to do the resection from the same two or three points though, and to have the random set-ups as close to one another as possible. If a second point is needed, overlap the check shots some to aid in your analysis of your data if the check shots on points shot from two random points don't yield the same coordinates from each setup.

The staking methods noted above leave little room for error, and this is precisely the point. This approach guards against the potential to set an offset point a foot off along the line you are sighting. Things like this can happen, and the results for you can be disastrously expensive. This check will catch any significant errors in time for you to correct them.

You never know what you will be blamed for, so it pays to document that your building is both staked accurately, AND that it is located in the right place on the site. The random-point setup is proof positive of both. But, don't use the same two control points you staked from to perform your check at the end. If you do this, you lose the proof-positive that you've staked the building in the right place.

You never want to go to court to prove the unlikelihood of having made an error. It is far cheaper and better for client relations to simply, humbly and POSITIVELY demonstrate why your layout could not possibly be wrong.

### Setting Extended Building Control

At the time of staking column control, I also set extended, permanent building control at some convenient distances. In the above examples, this control is set either side of the building on at least two perpendicular column lines, two points staked on each column line.

I set these well outside of construction limits or at some point that appears safe from disturbance until the proposed building is actually coming out of the ground. I usually coordinate this with the site superintendent. If at all possible, I always try to set two very distant points on each outer, major column line in case all my points set near the building get destroyed.

If you should lose building control and primary control located near the building, it can be very difficult to re-establish building offsets (column offsets in this case) close enough to their original positions to meet specifications. This can be extremely frustrating and time consuming, and your client may feel you lacked foresight if the process becomes terribly costly in restaking fees for your re-establishment of control. Your client may feel you should have foreseen this possibility and made provision for it. Legally, this is probably not true unless some contract provision states otherwise or you included it in your proposal. But, it pays in client relationships to set some points from which you can conveniently re-establish your original position of the control you staked.

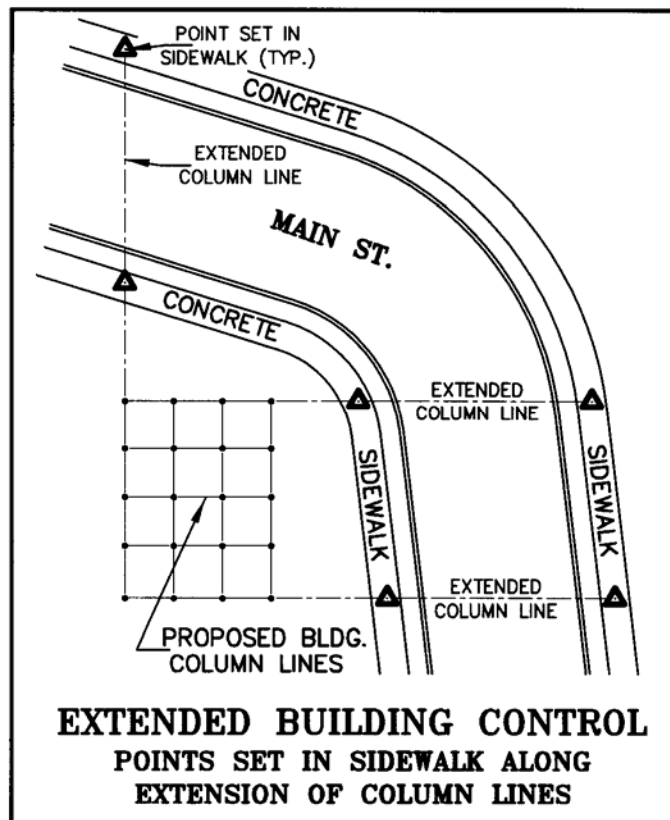

Also, if through some mishap the building stakes are misinterpreted, or through the contractor's own error the building is constructed on the wrong location on the site, you have additional evidence of your original staking. This could possibly happen if most stakes are knocked out and

the contractor tries to re-establish it, for example, if a column line offset stake is assumed to be an actual column location.

I've serviced sites where the contractors pull my tall stakes to use somewhere else on the site, and the hubs I've placed are unlabeled as a result.

Admittedly, the responsibility to protect your initial control and to correctly interpret it rests with your client provided you've coordinated its placement with your client, set stakes with uniquely colored flagging, and labeled your stakes conspicuously, thoroughly, consistently and correctly. Still, considerable experience has taught me that if I can establish building control points well beyond the building in a half-hour or so, I'll be very, very wise to do so. For the sake of efficiency, this should be done while staking the building control rectangle. At that time, you're already set up on the rectangle and sighting along column lines. It won't take much longer to set a couple of points at specific distances along those lines you're sighting to set your close-in, building offset stakes.

Frequently, the client requests anchor bolt checks. Most times, the offset stakes set near the building are gone or disturbed by this point in time. That distant control is absolutely golden at this moment.

I can't stress how worthwhile the time spent extending building control is in most cases.

## **Set Vertical Controls**

Whether for a single-family residence, a strip mall or multi-story building, it is important that the vertical position (the elevation) of the structure be controlled and accurately placed. Take time setting bench marks of whatever kind and in whatever locations the client requests, and provide considerable redundancy in determining the elevation of the benchmarks you provide. Maintain the utmost care in calculating and documenting your processes and calculations.

Sometimes you'll be asked to set a point at a specific elevation, for example to set a rebar in the ground near the center of the building with the top driven to the finish floor grade. Do not label the stake or pin "Finish Floor Grade" or any such thing. Label the point with its elevation. The design team has raised and lowered the finish floor elevations of buildings without my knowledge on numerous occasions, and I don't want to buy any buildings I don't already own by stating what the finish floor elevation should be. The plans may say one thing, but sometimes, that has been changed without my knowledge. If I label the stake stating that it's set at floor or slab elevation, the entire building may be constructed at the WRONG elevation. But, if I label that stake with its elevation, then someone else must decide if that is the current intent of the designers.

Also, when asked to provide a bench mark, I always provide TWO bench marks, not one. This way, the contractor has little or no excuse for accepting my elevation without checking between the two benchmarks for agreement. Sometimes, bench marks are disturbed without necessarily looking as if they have. For this reason, I always set two and instruct the person requesting the bench mark of the presence of TWO bench marks. I advise (in writing if possible) that neither bench mark should be relied upon without checking into the other to confirm that neither has been disturbed or mislabeled. If this advisement has been verbal, I note this in a conversation log

and file it and also make a note in the field book right along with my notes related to setting those bench marks.

Generally, it's not advisable to use a total station to set bench marks, and almost never to use GPS, unless you *really* know what you are doing. If you're a GPS button-pusher, use a level and a rod! It's much safer.

## **Brick Points – Sometimes called, Wall Points**

Frequently, concrete footings are marked with nails set in the footing at outside corners of the walls to be constructed on those footings. This guides placement of the first course of concrete blocks or forms. The number of points required varies, but often marking every outside wall corner is requested.

Be certain to document on your work order which side of the wall your points represent. I've never been asked to locate inside corners, but I make it a point to note on the work order, CYA Memo or e-mail that I've set points at the outside corners.

The field conditions vary. Sometimes, the footings are under water or even ice. Often they are covered with dirt or mud. Sometimes, rebar sticks out of the footings requiring extra care in walking along them. Slippery footings and rebar sticking up make for dangerous working conditions.

It is very difficult to predict the time involved in providing this layout, or even if it will be requested, so I normally do not include it in my bids unless specifically asked to. Instead, I perform this task as an "extra" if this layout is requested. Including it also places me at a disadvantage in the apples and oranges game discussed at length earlier in this course.

If a client requests a firm number for this layout in my proposal, I always state that the fee assumes clean, dry footings at the time of layout and that the control I've staked for the building remains undisturbed.

These are reasons I give if asked why I did not include wall corners marked in footings in my proposal: (1) Some contractors will provide their own wall points from the primary building control without my assistance, (2) the number of corners marked varies widely from project to project, (3) about half the time, the building control I've staked is disturbed requiring restaking, and (4) footings are often covered with mud, dirt, water or even ice, and hourly fees then apply in addition to the fee noted in the proposal.

This work must be fairly precise, and it can be hard to get a nail into the concrete footing without it slipping off an unseen stone lying just below the troweled surface of the concrete. When this occurs, it busts up the surface of the footing rather unpleasantly, and some fussing is required to set the points accurately.

I've found that the short, ½ inch or ¾ inch nails typically used in gunpowder-powered nail guns work well for this purpose. I don't use a gun to shoot them into the footing, but rather set the nail on the desired point with the little orange "washer" that comes on them pulled to the bottom of the nail. The little nail will "stand" there on its orange washer, and I give it a smart rap with a carpenter's hammer (not a 3 or 4 pound hammer). This usually sets the nail, and a second sharp

hit will work if needed. I drive the nail to the point it squishes the orange washer, leaving the head of the nail up 1/8<sup>th</sup> inch or so. Then, I spray the footing with paint to indicate the corner and the side the blocks or poured wall will go on.

Below is a photo of longer versions of these nails.



## Marking Projections on Upper Floors

Sometimes, the client asks that some reference line or construction line be projected to upper floors and marked on those floors. A request might be made, for example, to mark a line on the second and third floors of a building at two feet outside of the outermost column lines. This is another situation where your distant building control that I recommended earlier comes in handy. Normally, the primary building control is too close to the building to see through the scope to the upper floors. And, often the control set for the columns has been destroyed. Lines of sight through the building are more often than not blocked by this point in time as well.

If you were able to set and preserve solid control that is distant from the building, you've just saved yourself the tearing out of your hair and also saved your client a good sum of money. (Consider blowing your own horn a little with your client over this.)

A word of caution at this point. You will no doubt have to offset your extended building control in order to see by the columns you're being asked to reference as you mark the upper floors. Be certain to check into the column lines on the upper floors before you commit to paint-on-concrete marks on those upper floors. Your client may not want a theoretical offset from the column lines (based on your original control) but the *actual* offset from the as-built locations of the columns. Theoretical (or calculated) location of the columns and as-built locations may not be exactly the same, and you need to be certain which you are being asked to reference and to note it in your conversation log and on your work order.

One tool you must have for this assignment – and it's seldom found in most survey trucks – is a good quality chalk line. Two are even better, one with orange chalk inside and the other with blue chalk. If one color is already in use on the floors you want to mark, use the other color to avoid confusing your work with another's. Also note the color chalk you use in your



conversation log and your work order. On the work order write something like, “Marked with blue chalk-line second and third floors, two feet outside of calculated (or field-located) position of column lines A and E.”

No one will criticize you for noting the “blue” on that work order. But, if someone mistakenly references the orange chalk-line placed by some other contractor, that adjective could save you from a back-charge.

Another important supply not found in most survey trucks is a couple of spray cans of clear lacquer. After you are sure of your marked chalk lines, gently spray just a DUSTING of the clear lacquer over the chalked line. It will last a long time and not be erased by wind and rain. If you are in a pinch and have only your traditional orange or red spray paint, it will work if you have a delicate hand. DUST the chalk line with the paint, being careful not to discharge enough paint to obscure the chalked line. This will work fine if you have a light hand at spraying.

### **Never use a chalk-line for marking a consistent vertical slope!**

Most surveyors and engineers are *not* experts in the use of a chalk line. A word of caution: if you are ever asked to use a chalk line to mark VERTICAL control, such as the approach slab to a bridge, don't do it. (Or be darn sure you know your limits and the limits of a chalk-line.)

A surveyor I know was employed by a bridge contractor. He once bowed to pressure to provide the vertical control for a bridge approach slab with a chalk line, and he did it. The firm's level was providing erratic results, and the boss barked the order to just do it with a chalk line.

The line was suspended in the air and snapped to mark a grade along the side of a stake set mid-way between the beginning and the end of the approach slab. That surveyor pulled very, very tightly on the line in an attempt to insure against sag in the middle of the line. Sighting by eye along the line didn't reveal any sag either.

Well, it didn't work. The mark he made looked good, but it wasn't. Even pulling so hard he thought the line might snap, sag was still present in the line and the chalked reference line made on the vertical reference point mid-way between the ends of the chalk line was lower than it should have been due to the sag in the line. But, it was not visible to the eye.

Driving over that finished approach slab at sixty-five miles per hour made your stomach drop as your car hit the bottom of the sag and then rise as your car crested the end of the approach slab and rode onto the bridge deck. The contractor had to demolish and replace the entire approach slab. This necessitated lane closings and state police rolling-road-blocks to slow the traffic ahead of the reconstruction. And it meant night-work on this busy, interstate highway – overtime pay, night delivery of concrete, extra pay for inspectors, etc. All this to save the trouble of breaking out an instrument (or of having one that worked!) Some head had to roll, and that surveyor was fired for the mishap, even though he was following orders. If that surveyor had been a sub-contractor to the bridge builder, he would have been back-charged for the costs. Be very careful never to be pressured to do something you aren't confident and at peace in doing.

String lines sag. Never forget that. They are for marking on horizontal surfaces, and this, too has its limits. If you equip yourself with a chalk line, get some practice snapping it and check your results over distances with an instrument.



Remember, there's a degree of skill involved in snapping a precise line even on a flat, horizontal surface. The line you snap is influenced by wind, by anything on the surface along the snapped line, by how tight the line is pulled just before being snapped and by whether or not you are directly above the true line between the two end points or off to the side when you let go to make the snapped line. Practice with your chalk line prior to using the tool professionally. It's kind of fun, actually.

## Special, unexpected requests for layout from plans you've not seen before.

As a professional layout person, you may be asked to perform layout you've never anticipated, from plans you've not reviewed. Be cooperative, but be very, very careful. It is critical to your financial well-being that you receive and document specific instructions for what you do in these cases, and that you're confident you understand both the plans and your assignment.

Be humble! If you've never dealt with whatever plans you're asked to interpret, calculate and stake from, don't be afraid to ask your client if you've understood the plans and verbal instructions. In a sense, try to get the person who assigned the work to check your understanding of the work or even review the calculations you've made. Most often, you will not be looked down upon for this level of caution and coordination.

If you say something like, "Look, I'm an expert in measurements but not in constructing what I'm about to lay out for you. Would you mind looking this over to be sure it's what you want?"

Then explain your steps involved in calculating the layout. Do this slowly and seek nods or verbal confirmations that you're seeing things rightly. Of course, make whatever notes you can on your work order to specify what you are laying out, from what plans, dated what date, and at whose direction. In your conversation log, note the steps you went through to obtain client-verification of your work. And, label your marks or stakes specifically and clearly.

### 3-4-5 and Patterns

Finally, when it comes to staking structures or parts of structures, don't forget the carpenter's mantra: "3-4-5." These three dimensions form a right triangle, as do multiples of them. (Long lives Pythagoras!) Times may come when you will find it easier to mark column bolts on a bridge pier or some other thing using a right angle off a centerline you've marked along the surface. With care and practice, you can form your right angles using the 3-4-5 approach, and set points more accurately and quickly than you can by fussing with a radial stakeout method or the offset function of the instrument.

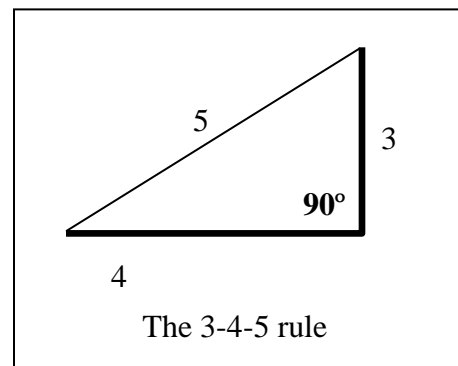

Sometimes, it is easier to take an hour and make a template or pattern used to mark your points. This is especially useful in certain building and bridge applications.

As an example to illustrate the use of a template, suppose you have to mark anchor bolt locations along a slab and many of the anchor bolt patterns are identical.

All sorts of convoluted approaches can be hatched to fulfill such an assignment. The more complex and difficult the approach, the more likely that errors will result.

Wouldn't it be nice if you could sight along a column line and simply set a template at the proper distance, rotate it until it lines up with the column line you're sighting and trace the locations from a pattern?

Using an anchor bolt template like the one illustrated at right, the first step is to set the instrument so that its line of sight is along a column line. Then, locate the centerline of column intersection by measuring the correct distance with a prism pole, mini-prism, steel tape or Dist-a-Line™. Once the intersection of column lines is marked on the slab, place the template over that point. The person at the template simply rotates the pattern around the marked, centerline intersection point (while sighting through the center hole) until the two nails line up along the instrument person's line of sight. Then the four anchor bolt locations are marked at the four holes.

If you elect to make and use a pattern or template, don't neglect to verify which columns (or whatever you are laying out) do or do not have the same dimensions. Not all columns for a given building, for example, may have identical anchor bolt dimensions or even the same number of anchor bolts. Be careful to check the plans to know for certain which columns your template fits and which it doesn't.

Carpenters have an expression: Measure twice and cut once. This wisdom cannot be overvalued. We need to check the plans and re-check them to be certain we are applying the correct detail for the thing we are laying out.

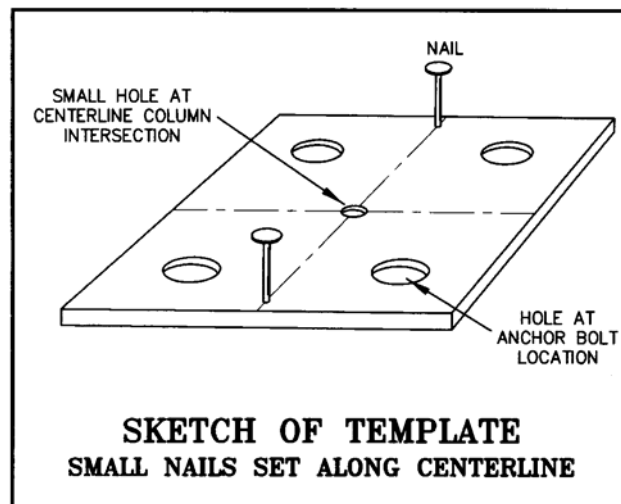
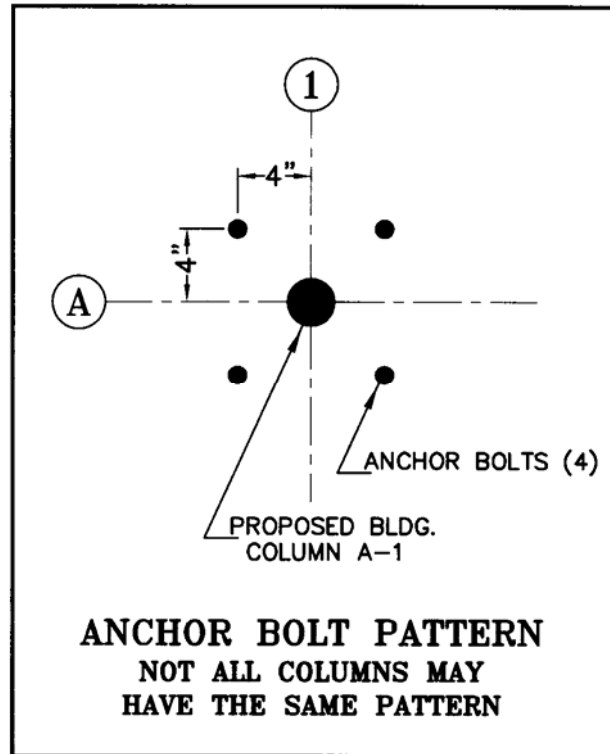

We surveyors and engineers can make things unnecessarily hard at times. Watch and learn from the people who work construction every day of their lives. It's amazing what can be learned from them. If they seem to question how I'm approaching some layout task, I always ask, "How would you do this?" In many cases, I now do it the way they would do it, not the way I used to do it.

## Stake Site Utilities

### Sanitary Sewers

Traditionally, stakes set for construction of sanitary sewer lines were comprised of a line of stakes set at offsets to centerline of pipe stations along the run of the line, with double offset stakes set at manholes or chambers.

The double offsets might be in line with each other so that the workers constructing the line could "line between them," or, if the manhole was at an angle point in the run, the offsets might be at right angles to both the line-back and line-ahead pipe runs. The workers would then "swing tie" the offsets or use an instrument to determine the center of the manhole.

Always place offset stakes for the structures the on the side or sides the client or pipe crew says to stake on. Often they don't care, but sometimes they know on which side of the trench they'll place excavated material.

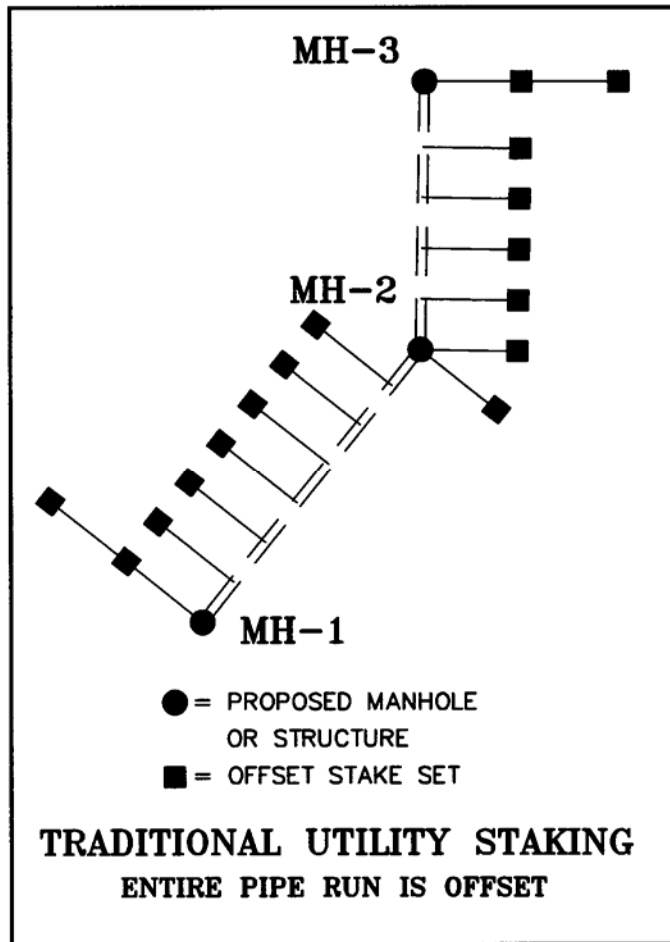

For pipe contractors using lasers to guide the line and slope of the pipes, really only the manhole locations need to be staked. As a precaution, I always stake at least one or two pipe offset stakes ahead of the manholes and instruct the contractor in writing to use it as a check. This provides some measure of protection for me if there is an error in my cut noted to the manhole invert. If my manhole cuts are labeled in error, and the contractor fails to check the pipe grade from my stakes set 25 to 50 feet ahead of the manhole, I at least have an argument against paying to reinstall an entire run of pipe.

When placing these check stakes, bear in mind that gravity utilities are normally constructed from the low end up. This way, the pipes aren't constantly being filled with storm water flowing through as they construct the lines.

It's important to check with the site superintendent or utility contractor to know exactly how intensive the staking must be as well as on which side of the utility run to set my offset stakes.

### Storm Sewers

Typical storm sewer pipe and manhole staking is similar to sanitary sewer layout. But, often there are more variables to consider. Almost all storm sewer systems include structures along the curbing of parking lots, drives or roadways. This makes staking accuracy critical. Tops of drainage structures constructed along curbing must be rotated to align with the run of curbing. Often, different size pipes require the installation of different sized structures.

Staking storm structures can be tricky. An illustration from my experience will best illustrate the danger in not knowing your local standard details and when they apply or don't apply.

This story takes place when I was operating a business specializing in construction layout in Northern Virginia, just outside of Washington, DC.

On a particular project, a young graduate engineer serving as project manager for the construction management firm overseeing construction of a large commercial development decided to "split the bids," awarding me some of the construction layout for the site and a

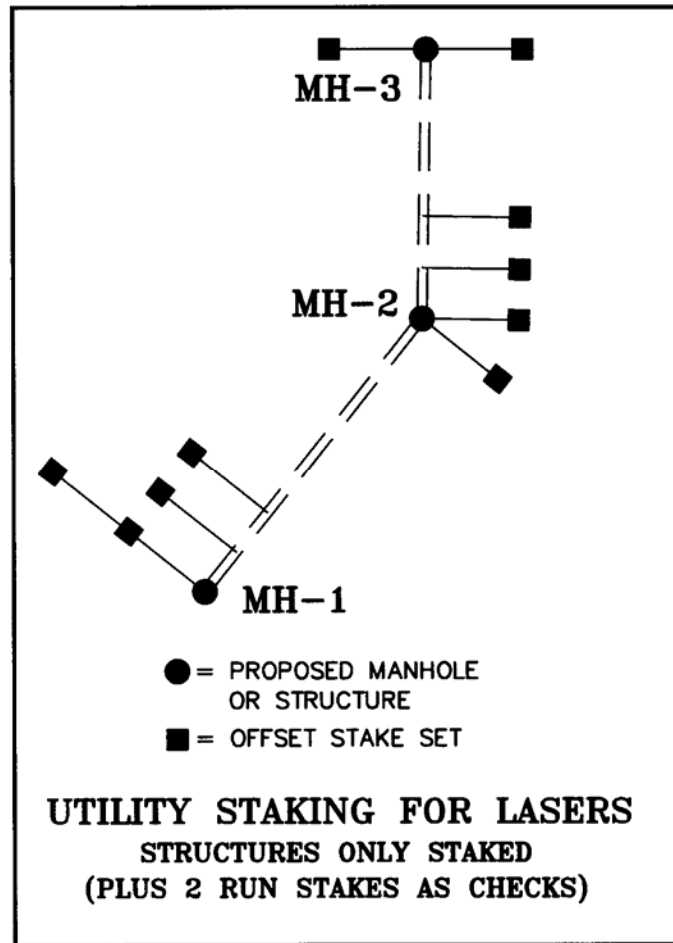

Maryland firm the rest of the layout. The project site was located in Virginia, but the Maryland firm was only about a 45 minute drive from the site.

This young, inexperienced project manager reviewing the bids for construction layout noticed that a firm competing with me had lower fees than I did for certain line items, so he picked and chose the lower numbers for various line items from my bid and from that of my out-of-state competitor.

He awarded the curb layout to me. (Virginia typically used a monolithic, concrete curb-and-gutter approach.) The storm sewer layout was awarded to the Maryland firm, and the rest of the layout was divided between our two firms.

To the best of my memory, my competitor was furnished coordinates for the geometry of the parking lots by the design engineer, as was I, so we both had the same geometry to work with regarding where on the site the parking lots with their curb-and-gutter and storm structures actually belonged. My competitor was, of course called to stake the storm sewer structures along the curbing before I asked called to stake the curb-and-gutter.

Since the Maryland firm and I both shared the same geometry for the proposed location of the parking lot curbing, the curb-type storm sewer structures staked by them should, in theory, be constructed in the right relationship to the curbing that I would stake after the storm structures were in place.

I received the call saying that the storm sewer was installed and that I should stake the curb-and-gutter as soon as possible. While staking the parking lots, I found that storm structures were not fitting properly with the curbing I was staking. I checked my computations against the coordinates furnished to both me and the Maryland firm by the design engineer. The catch basins appeared to be staked a half-foot or so off from where they should have been. I reported the conflict to the site superintendent, who called an urgent meeting with both me and the Maryland contractor present.

At the meeting, I asked my competitor's three representatives (who arrived on the site dressed in suits) how exactly they had computed the catch basin locations. One of them pulled out an inch-and-a-half thick Virginia DOT manual and placed it on the desk. He opened it to a page showing a standard detail of the basins being staked. He also had a sheet of graph paper on which he'd extrapolated the salient dimensions and began to proudly present the logic and perfection of his tedious calculations made from the admittedly not-so-easy-to-figure-out standard detail.

As soon as my competitors broke out the Virginia Standards, the superintendent and I exchanged knowing glances. Because I discerned an air of superiority in the Maryland team, I allowed him to take about five minutes to explain and defend his elaborate computation of how from the face of curb line the actual center of the basin should be located. The superintendent also allowed the presentation to run its course.

When he finished his "gotcha" presentation, he leaned back in his chair with a go-ahead-and-try-to-prove-me-wrong smirk on his face.

I paused for a few seconds, then said sympathetically, "So this is the first job you've staked in Northern Virginia, is it?"

The Maryland team exchanged quick sideways glances as I sat silently with raised eyebrows, looking from one to another and waiting for an answer to my question. I wondered who would speak first.

Their faces slowly transitioned from over-confidence to something approaching dead-pan. Still, I said nothing and waited. The superintendent was absolutely motionless. He knew where I was headed.

Finally one of them replied with considerably less bravado than expressed in their computation demonstration, “Yes, actually this is our first venture into the Northern Virginia market, but we’ve carefully checked and re-checked our computations and confirmed that we staked the structures precisely per the Virginia standard details.”

“Yes,” I said, “I can also confirm what you’ve said. My locations of the structures built from your layout confirm everything you’ve said.”

At this, they began to ease back into their superior posture. I had mercy on them at this point and spoke before they could get themselves all puffed up again, “But we don’t use that standard in Northern Virginia. Here, for all the smaller size pipes, we use a standard, 4-foot diameter barrel the center of which is always set 2 feet off the face of curb for curb-line inlets. Nobody in this area constructs by that standard detail, and for larger structures, I always need details supplied by the pre-caster who’s supplying the specific structures. Then, I stake from those dimensions.”

A look of incredulity passed between those who moments earlier were so confident. One of them asked, “What do you mean, you don’t build to Virginia standard details in Northern Virginia?”

As they realized all or most of the storm structures they staked were already constructed in the wrong place throughout the entire site, their cockiness-turned-incredulity quickly transitioned to something close to panic.

With my competitor properly humbled, a cooperative air was not hard to achieve in that construction trailer. I turned to the superintendent, who I knew well, for I had set up a construction layout division of his boss’s company just a couple of years earlier and recently bought it out to start my own business. (The Maryland firm’s men were of course not aware of this relationship, or of the fact that I’d cautioned the young project engineer who split the bid against the wisdom of that approach.)

Anyway, I turned to the superintendent, who’d remained silent – I think enjoying the interaction that had taken place – and said, “Well Pete, let’s put our heads together and see how much of the storm drainage we can leave in place. Where can we warp the curb layout or shift the parking lot to match the catch basins without causing trouble?”

We began reviewing the plans to see which basins and runs of pipe we could save and which storm structures and pipes absolutely had to be removed and replaced. Together, we were able to save most of the storm drainage constructed per my competitor’s wrong locations. In a few places, structures and pipes had to be moved, but by working together, my competitor was spared most of the back charges that they might have suffered.

Have I said before in this course, “Ask lots of questions?”



Standards vary by region and sometimes, as in this case, the most detailed, official standards are not even followed in daily practice. Never be too proud to ask how to do your own job. Just ask someone who knows. Contractors know what most surveyors and lots of engineers don't really know, and that's how it's actually put together. We surveyors don't admit this to ourselves, but the contractors have figured it out through long experience, and they already know our closely guarded secret. Don't ever be too proud to ask questions.

Remember the above, true story. If only that Maryland firm had asked if the state standards applied, they would have been told not to use them. Ask!

Also, keep in mind that larger storm and sanitary pipes require larger-than-standard structures to accommodate the pipe sized. Obviously, a 48" pipe can't fit into a 4' diameter manhole or catch basin base. Be sure to ask what conditions determine the size of structures to be installed and become familiar with the kind of structures used in your region, especially storm structures constructed along curbing. Very little tolerance for error (or ignorance) exists with these structures, as the Maryland firm learned on their first Northern Virginia project.

## **Water Lines**

As the above story illustrates, it's best to ASK how the contractor wants things laid out. When staking water lines, this carefulness and diligence is particularly true regarding fire hydrants.

In some areas, the hydrants must be installed a certain distance behind the face of curbs and a certain elevation at the bottom flange above the top of curb. Be sure you know just how critical such layout is and what governs both the horizontal and vertical position of hydrants. Some jurisdictions are quite lax and others very strict.

## **Roadways, Drives and Parking Areas**

In my experience, offset stakes along gently curved sections of curbing for roads, drives and parking are typically set at 25 foot intervals and at 50 foot intervals along straight sections, plus high points and low points and sometimes drop curbing for driveway openings or wheel chair access.

For roadways or major driveways, the design plans provide stationing, usually expressed as 1+00, 2+00, 3+00, etc., referring to distances 100, 200 and 300 feet, respectively, from a point of beginning at 0+00. Thus, on gently curved sections, you may be asked to stake every 50 foot station or every 25 foot station. In addition to regularly spaced stakes, you will normally stake high and low points and beginnings and endings of curves in the roadway. Normally, a profile is provided in the design plans, and these will show the high points and low points. The plan view of the road will show the stations of the beginning and end points of curve, but you will usually have to get or compute the elevations of these points from data on the profile sheets.

In driveway areas and parking lots, spot grades or contours are normally shown, and you'll have to interpolate between them to find proposed grades at your stakes' positions.

Parking lot corners are normally offset two ways. Small islands with "noses" having a radius of about five to eight feet or less usually get just one stake at the radius point (center) of the arc. Assuming you're using cut sheets to report the relationship of your stakes to the proposed

construction, you must always provide a labeled sketch to indicate where multiple cuts and fills that are referenced off the same stake apply. For example, a single radius point stake may provide control for three points along the nose of the future curb, the PC, the end of the nose and the PT. I recommend always supplying a sketch with your spreadsheet-style cut sheet. The best approach I've found is to use circled letters both on the sketch and in the tabulated area of the cut sheet, indicating exactly where the grade for each circled letter applies along the curb.

In the illustration, points A, B and C all are likely to have different proposed grades, yet the three points on the proposed curb are referenced off one stake. Your cut sheet will require three lines for this. The stake identification and stake elevation will be the same for all three stakes, but proposed grade is likely to differ, as will the cuts or fills at those three points along the future curb.

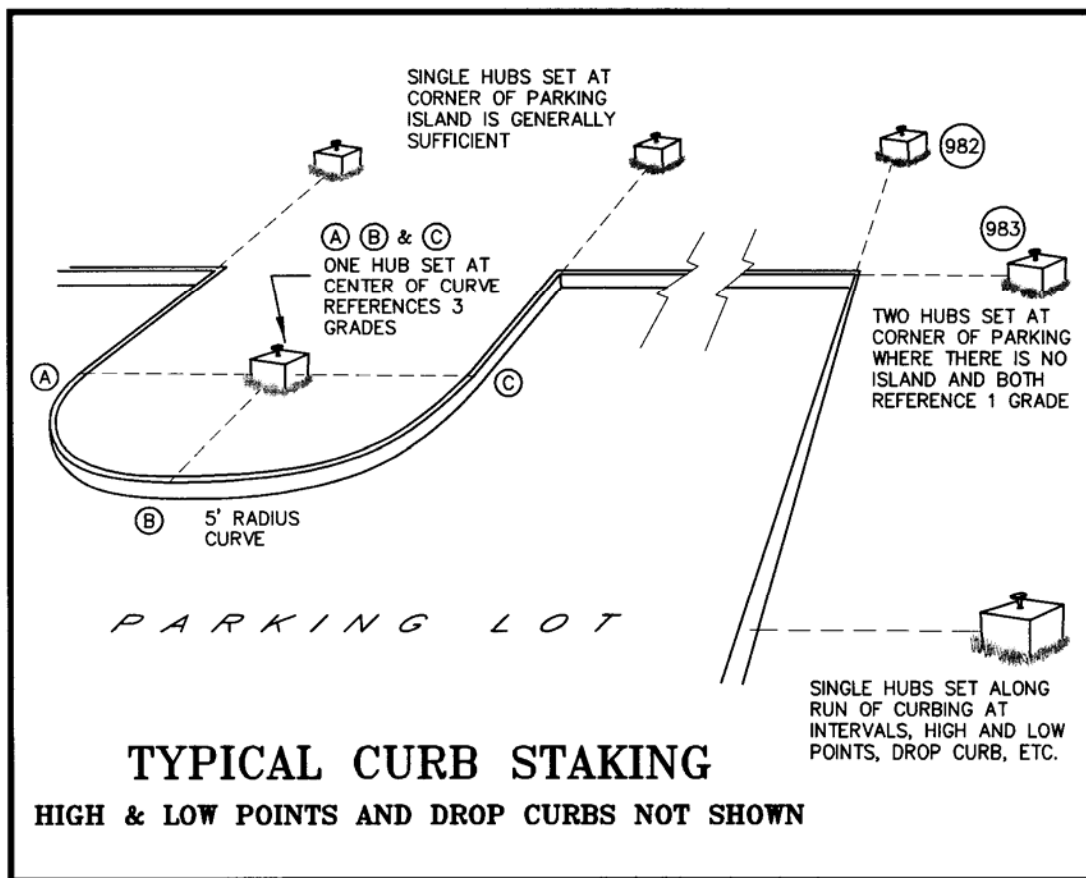

Where multiple stakes represent a single point on the future curb, for example when a parking lot corner is offset two ways (#982 and 983 in the illustration), I always label those stakes with circled letters or numbers and make a clear sketch in my fieldbook linked to the shot taken on that stake for elevation, so that there is little chance of reversing them on my cut sheet or on a sketch I provide. This is important, because one of the two corner stakes may be destroyed prior to construction, and if you've reversed their cuts on the cut sheet, it will probably be constructed at the wrong elevation.

Find out what is typically referenced, top of curb or gutter grade. Often the contractor building the curbing will want cuts and fills referenced to the top of curb grades, but the site plans will most often show grades along the pavement or bottom of curb. Be sure to be clear headed when listing the proposed grade. It's easy to forget the add-on from gutter grade to the top of curb.

The portion of a sketch accompanying a grade sheet for the illustration above might look like this:

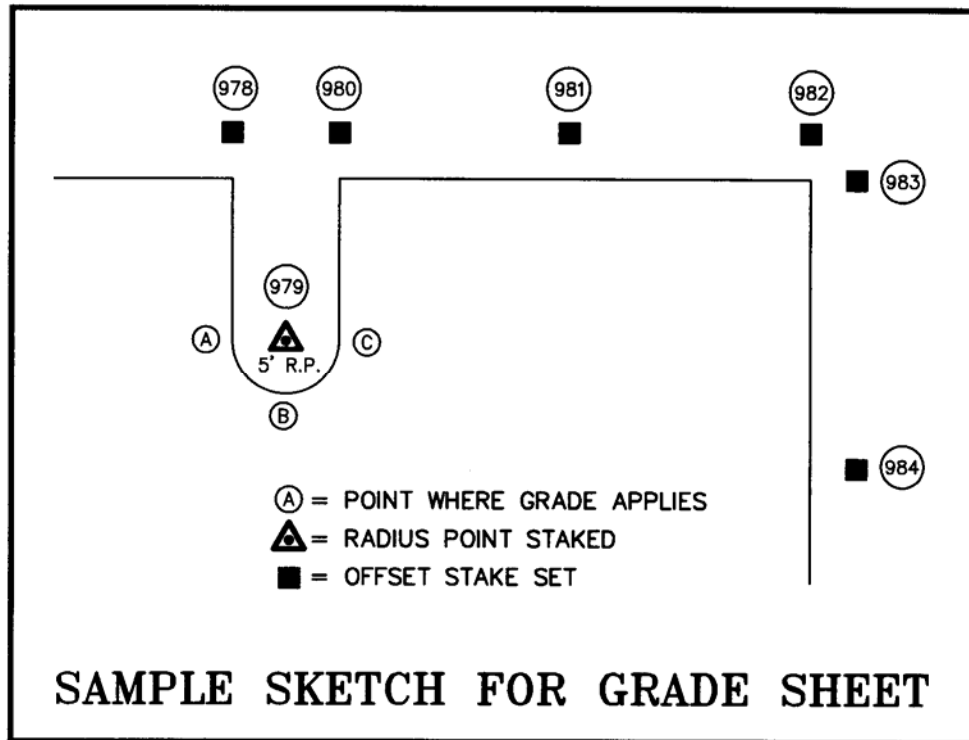

### Misc. Calls for Layout

Sometimes you'll receive calls for other miscellaneous layout, that is, layout beyond the scope of your contract. I normally do not place possible staking in a bid, because of the apples-and-oranges factor discussed under bidding in this course. In short, I don't include it because it makes my bid higher than my competitors.

These miscellaneous requests are handled as "extras," and one must be very careful to document an authorization to proceed through a signed work order or other form of written approval that acknowledges the services are in addition to your set-fee, contractual obligations. It's all too easy for your client to assume that ANY layout they desire is part of your contract. This is why your contract must specify exactly what you've agreed to stake. Always document in your Conversation Logs any verbal authorization for work that exceeds the scope of your proposal or your contract with your client.

As in all issues pertaining to construction layout, when a request for extra services is made, never be afraid to ask the persons requesting the layout how and where they'd like it staked. Always find out if they need a vertical reference. Ask if they need horizontal offsets or just a stake for the point itself. They almost always know the best distance and side to place offsets and whether

they need offset at all. Remember, you'll impress them more with your questions than you will by providing control that's hard for them to use or that's too far or too close to their work or gets destroyed by adjacent construction before they use it. Ask what plan you should stake it from, making certain you have the latest information.

Then, make a work order and note any important instructions you receive, being certain to note the date of the plans you are staking from.

Miscellaneous calls for layout may include:

- Site Lighting
- Transformer Pads
- Containment Facilities
- Auxiliary Structures
- Equipment Sheds
- Playgrounds
- Off-site Utilities
- Garages and Carports
- Elevator Shafts
- Trash Areas or Dumpster Pads
- Menu Boards
- Bus Shelters
- Swimming Pools and Fountains
- Decorative Walls, Walks, Stairways and Patios
- Athletic Fields, Backstops, Tennis Courts
- Ticket Booths
- Sign Locations
- Walls
- Fences
- Anchor Bolt Surveys/Checks

### **Like working for free?**

Again, you **MUST** get written authorization **THAT INDICATES THE WORK IS BEING PERFORMED AS AN "EXTRA!"** If there is any confusion in the verbal communication or written documentation of this work order, you may not get paid. Never forget that although

construction layout is your business, and even though your contract is specific as to your limits of services, your client views your services as routine and rather a small part of the overall project budget. Your client's attention to the details and specifics of your contract is likely to be lacking. It's up to you to point out that the services being requested are not a part of your contract and to specifically ask if an extra fee is being authorized for this work. Then, **GET IT IN WRITING**. Use the words, "authorized extra" in your brief description on the work order, and get it signed before you start the work.

This is good business, and your construction client is good at business and understands the need for pre-approval of extras. Don't be shy about doing business in a business-like way.

It is very, very common for your client to think of services you can perform "while you're here." This is why it's so important that you and your crews are familiar with your contract and know exactly what is and is not in it.

Many, many requests vanish when the person asking for it realizes you need to be paid for it. It is also good business to occasionally provide an extra service without charging, if it won't take too long and you have the time. Occasionally, you can make a friend of a site superintendent by providing some service that's easy for you to do but hard for him to do on his own. But, he can't authorize an extra charge for it because of the red-tape he'd face with his superiors. You'll make a friend if you do it for free. Be smart, but not rigid. Train your crew chiefs to know the difference and to call you when in doubt.

## **Protect your control**

We're back on the subject of control points – the initial control traverse and any additional control set during construction. This is very important material, so please don't skip over it. Every surveyor/engineer thinks he or she knows all that needs to be known about control traverses and networks. But, really, the stuff below is important. If you don't learn something by reading it that you didn't know before – or you're not reminded of something you've forgotten – I'll be surprised.

The safety of your personnel and equipment is not the only consideration on the site. Your control points have significant value to both you and to your client and must be protected.

Whenever possible, carefully coordinate the placement of primary control points (points that will hopefully last throughout the layout processes) with the site superintendent. Including the superintendent in the decision process helps that person feel connected to the importance of the control. The superintendent's knowledge of what will happen where on the site is invaluable. In the course of my discussions with the superintendent, I state that each control point is flagged in certain, unique colors and represents about \$300 in re-stake fees if disturbed.

I always mention to the superintendent that I have no problem with the point being destroyed if it's cheaper to destroy it than to work around it. Sometimes, the area occupied by a control point is better used for storage of materials or some other need. If the superintendent knows that using the area occupied by the control point for some other purpose will cost about \$200-\$300, then he can freely decide whether it's better to use that area or save the control point.

You may ask, why such pains about protecting control points? With the modern two-point and three-point resection features of instruments and data collection packages, can't new control be set on the fly?

There are two things construction layout providers learn:

- You can never restake a point in exactly the same location it was in when you first staked it, and
- Precision diminishes as new traverses are run from one point in a previously adjusted control network to another.

The more educated reader may contend with these two principles, raising arguments about least squares adjustment, the increasing statistical probability obtained through redundant observations (resulting in smaller error ellipses), and other lofty notions. Yes, theoretically and statistically one may dispute almost any practical wisdom.

But, what's important to remember in the 3D world of construction layout is this: Any point you *restake* to control the position of a building corner or the centerline of a column **MUST** be in the **EXACT** same place as the original stake that got disturbed or destroyed.

Of course, this is humanly impossible to achieve. Thus, a restaked control point (or any newly created control point) that you occupy to restake some *other* critically precise point won't get the restaked point in the same place as your original stake. Experience will convince you this is true if I can't.

How about a typical example – one that will have you tearing your hair out? You receive a call to restake some primary building control you set a week or two earlier. You find that a control point you occupied to stake some column offsets has been disturbed or destroyed. All you need to do is restake that control point, and then restake the missing building control, right? Simple enough – until you try to do it. Then, theory be damned; the new column offsets you've just restaked aren't checking as well as you'd like with the surviving, original column offsets.

In this example, assume that virtually no human errors or equipment errors exist. You arrive on the site and restake the control point that got destroyed. From this restaked point, you restake the original column offsets. Your restaked control point used for this purpose was originally part of a closure-adjusted loop run between two points on your original, closure-adjusted traverse that looped the entire site. What could possibly be wrong?

The fact is, any number of things can cause you trouble when you try to restake control points. The surface of a construction site is normally unstable. Heavy equipment is vibrating the earth on and near the site, and often some settling occurs. Surviving control points that are used to restake a missing control point may look undisturbed, but in truth, they've moved. The adjustment of the traverses may have "moved" the coordinates of the points from their true positions in relation to one another. Your equipment may be in either better or worse adjustment than when the control was originally set.

Construction layout is a great teacher. It has taught me that facts exalt themselves against theory, truth and experience. Any classroom theory is worthless if it doesn't achieve consistent results in the mud and dust of the construction site. The key word here is **CONSISTENT**.



Principle: Put extreme care into establishing your primary off-site and on-site horizontal and vertical control. Be as precise as you *possibly* can. When it comes to precision, accuracy and repeatable consistency, from the moment your initial control network or traverse gets established, it's all down-hill from that point forward. Repeatable consistency falls apart with time and with every re-setting of control and with additional loops and legs of new traverses adjusted to older ones. Some surveyors simply can't grasp this fact, and living in denial creates mutually exclusive realities that defy any consistent explanation.

So, what is the solution?

**Set your primary control as precisely as you possibly can, and make it as plentiful as you can at the beginning of each project. And, make every reasonable effort to preserve these points throughout all critical phases of construction.**

Principle: Be redundant. Normally, a surveyor is accustomed to setting as FEW traverse points at as great a distance from one another as possible. This is great for boundary surveys and for good, mathematical traverse closures, but it's absolutely NOT a winning strategy in construction layout applications. Instead, set as many primary control points as you reasonably can. As usual, keep a good distance between them (to increase angular precision), but set points on line at frequent but random intervals between your primary traverse points. Set them very, very accurately; you may later need them to use as primary control or to reestablish lost control.

And don't let your computer adjust these P.O.L.'s off-line, even a little. Their coordinates MUST fall on a line between the end points. Hand-adjust P.O.L.'s if necessary, proportioning the distance between them, to maintain their computed positions perfectly on line between primary control points.

Turn angles from control points to distant, permanent reference points like building corners across the street or recognizable points like the dotted "i" on some distant store-front sign. This redundancy may pay off later as little by little, your primary control gets disturbed by the construction activities.

Some may argue, "Hey, I'll get paid to restake any control that the contractors destroy. Why take such pains setting original control? Setting original control has a set fee in my bid, but I'll get paid hourly fees to restake anything they knock out?"

Well, take that attitude if you want to, but you're expected to know how life goes on the construction site. There are limits to how much patience your client will have with your inexperience if you initially set too little control to properly service the site. You should always have off-site control, set in areas not impacted by your client's site development, and this must be adequate to establish new on-site control points in a minimum of time.

When on-site control has been destroyed, it really shouldn't take you more than an hour or two to occupy some original, off-site control, verify it with two other original control points, set a new point on the site, and check that new point against one or two existing, on-site control points, making any adjustment you deem prudent and get on with the task you've been called to perform.

Never say to the client, "All my control has been destroyed."

Your client will understand by such a statement that you don't know your business and either skimmed or didn't take appropriate precautions in setting and densifying your initial control.

As soon as you discover some of your on-site control has been destroyed, immediately inform the superintendent or whoever is paying you. Do it right away! Your client may be able to recover your fees for re-establishing control from the contractor who destroyed it.

For example, if loss of a primary control point is reported immediately upon discovery, it may be obvious from tracks left at the destroyed control point that a certain piece of equipment ran over the point or came too close to it. The superintendent probably knows whose equipment that is. If the point was adequately marked (with a staking scheme as described in this course), your client has the option to seek costs of restaking from the firm that destroyed it – or at least to warn the firm that any future repeats of such carelessness will cost that firm.

## **Label your control points in the field**

Whenever feasible, label your control. Obviously, one-foot high orange numerals painted on a concrete sidewalk across the street from your job may bring criticism. But, one-inch high felt pen numerals probably won't. Have your crews ever set up on point #44, backsighted #45 and reversed these point numbers in the paper or electronic field book? It happens all the time, especially when the control points are not physically labeled in the field.

## **Be sure your crew THINKS in the field.**

While on the topic of control points, a word of caution: Always provide your crews with the data necessary to check distances between control points. Instruct them to check their observed distance between any existing control point the instrument is set over and the backsight on a known control point. Obviously, close agreement between inversed distances and observed distances must be verified. This agreement provides comfort that the crew truly knows what point they are occupying and what point they're backsighting.

Notice I said, "comfort," not proof. What if the crew thinks they are occupying point #44 and backsighting #45, when in truth they are actually on point #45, backsighting #44? The check of backsight distance will not declare this common error.

Next, the crew must check the angle between their backsight and another known point. This will verify that the point numbers for the instrument and backsight are not reversed. This also verifies that you're using YOUR drill hole or x-cut and not that of another surveyor.

Surveyors know that a backsight distance check plus a check to another known point are essential to confirm that they are actually occupying and backsighting the points they intend to use. Therefore, *always* check a second, known point for both angle and distance agreement. This alone provides the extra confidence that the ever-lurking potential for liability requires.

Sending a crew out to perform ANY survey work from a pre-established control network without giving them the data necessary to verify their set-up and backsight points is tempting fate.

This happened recently to a surveyor friend. Another survey firm had set an x-cut that my friend's crew mistook for their own. My friend's crew did not check the backsight distance or

turn an angle to another known point to verify the instrument's position, and proceeded to locate points from there. The results were costly.

This is a very common tale when management's attitude is, "I don't want my crews to do too much thinking in the field."

## Color-coded flagging

### The "Orange" Firm -or- It's hard to scratch your head while wearing a hardhat.

Color-code your layout. Every major category of future construction getting staked should have its own color to distinguish it from other features staked. Consider this story:

Once there was a small firm whose expertise was in land surveying. This firm ordered flagging by the gross, all orange-glo in color, the *only* color flagging this firm used. This was a little confusing when retracing their property surveys, because traverse points and property corners and points marked during their initial recon on a project were all flagged in orange.

Their party chief flagged remnants of wire fence and other evidence of boundaries in orange during his initial visit to a property. Next, his traverse points were marked with orange flagging. When he came back to set corners, these were flagged with orange. If the project required vertical control, the bench marks were flagged in orange. When they staked a house for construction, they'd stake offsets with orange flagging. Most of their work was in rural areas and caused only occasional, minor aggravation to the firm's clients.

For example, once a house offset stake was set about ten feet from a stake marking an angle point in the property's side line. As always, both stakes had orange flagging. The contractor had to go to the stakes and read their labels to know which stake was which. Later in the day, he instructed the man digging the foundation to use "that stake over there," pointing to the stake marking the angle point in the property line instead of the only remaining offset stake for the house at that end of the proposed house. The lot was quite large, so the location of the house didn't seem critical to the operator, who dug the hole for the foundation ten feet toward the rear of the lot from the intended position. Because of mistaking the property line stake for the house offset stake, the house was built encroaching within a wetland setback. If only the house offset stakes and the property line stakes had been flagged in different colors, this costly mistake would have been avoided. Flagging is cheap!

Another time, this little firm received a layout contract for a major, commercial center. And, you guessed it, control points, boundary points, clearing limits, rough grade, column lines, elevator, sanitary, storm, water, elect/tel/cable, curbing, site lighting, retention basin – all were staked in orange. Equipment operators repeatedly got off their equipment to read the stakes, walking between them and scratching their heads as they tried to get the picture of which stakes applied to their immediate work and which were irrelevant to the task at hand.

Show more consideration for your clients than the orange-firm does. Use different flagging colors for each different feature staked. And, be consistent! Your regular clients and your own crews will appreciate the clarity brought by standardized color-schemes, and any error in your

staking might declare itself prior to construction because of its proximity to another staked feature that's recognizable by the color of its flagging. With consistency, your color-coding becomes familiar to your crews and the end-users of your stakes. And, this is what you want. The site plans are 2-D representations of what the finished site will look like. Your color-coded stakes are the first on-site view of what that is. This is not only kind and helpful; it could save you a bundle if you stake something wrong, but your error is discovered early because of the picture made by the different colored stake flagging. A wrongly staked feature is far more likely to "look wrong" if the picture made by the flagging is clear in the field. Unique colors for each category of staking help tremendously in making a picture of the future construction in the minds of people using your stakes.

Determine your firm's color-coding standard and insist your crews stick to it. Once they learn it through repeated use, they will apply it by habit and appreciate it themselves (eventually if not immediately). Certainly your clients will!

And lastly, imagine this: You have a repeat client, a commercial developer, who is used to your color-coding scheme and knows what each color represents. Then, some competitor underbids you, and your client hires that firm for their next project. Guess who's been hired in your place. It's the 'Orange-Firm!' What do you imagine your client will think of the confusion the Orange Firm creates? That firm has just become your sales force, and they don't even know it.

Little things mean a lot sometimes.

## **Suggested Color-coding Scheme for Flagging**

Below is my personal color-coding scheme. Any consistent scheme is better than none. Being anal-retentive, I've put considerable thought into this scheme. It may benefit you to read through it to learn the reasons for my choices.

### **Orange & Blue – Primary Control Points (one strand of each color)**

Orange-glo and blue (separate strands of each) make a stand-out color scheme for primary control. Primary control is comprised of the following:

- Traverse points that you hope will last throughout the job
- Primary control-rectangle points for buildings
- Distant building offsets (discussed earlier)
- Other semi-permanent points used for construction
- Property corner markers and monumentation
- Street right-of-way monuments or reference points
- Permanent reference points (NGS, County, City, etc.)
- Bench Marks

I always flag the most important control with this color scheme and triple or quadruple guard these critical points with similarly flagged guard stakes that claim a territory around each control point, often an area sufficiently large to set up and operate an instrument.

This is my territory on the site, and destruction of these will almost always result in hourly fees for restaking. Because of the importance and critical nature of these stakes, I coordinate their placement with the superintendent and advise of the expense associated with their destruction. If the superintendent is involved in choosing the placement of on-site control, you have an advocate to watch over your control when you're not there. Upon returning to one site following such a discussion with the superintendent of a 'better' construction management firm, I discovered that as extra security, he'd placed orange plastic snow-fence material on steel posts driven into the ground around all my on-site control points. These did last throughout the entire project on a very tight sight.

I tell the client, "Orange-and-Blue is EXPENSIVE. Every orange and blue point disturbed is worth about \$200-\$300. If disturbing it is cheaper than working around it, then by all means destroy it. Otherwise, if you can, keep people away from it."

After handling my control staking in this way, I've actually witnessed a superintendent telling an equipment operator, "If you disturb that point, it will cost you \$300."

### **White – Clearing Limits**

I like white for clearing limits because it's not used for any other staking. It's good because it shows against the usual green shade of whatever is to be cleared, namely grass, brush and trees. Plain colors are cheaper per foot than vibrant colored flagging, and staking clearing limits on a site consumes lots and lots of flagging.

Usually, I run flagging from tree to tree or bush to bush, more or less continuously stringing the white flagging along the clearing limits where vegetation is continuous. In doing this, I make the pieces of flagging a maximum of around 25 feet long so that the equipment doesn't rip off a whole line of flagging before the operator knows what is to be cleared. But, the *appearance* of the flagging is continuous in heavy vegetation.

In grassy areas or not-too-tall brush, stakes set along the line are needed at appropriate intervals. I generally don't run flagging from stake to stake, because such an approach tends to pull the stakes over as the clearing takes place .

When staking the clearing limits, confusion can exist. Does flagging on a tree trunk mean clear this tree or clear leaving this tree? Normally, I stake a limit based on a line drawn on the plans to denote limits of clearing. This line in a digital file is easily reduced to points with coordinate values set at appropriate points along that line.

These points are then staked in the field. I leave decisions about specific trees or shrubs to remain to the client or excavator unless a specific tree or easily identifiable group of trees is to be saved. In the case of specific trees to be saved, I may flag the drip edge as well as the trunk, so that the equipment operator stays away from the roots. Often trees are killed by root damage. In my limited, inexpert knowledge, the critical root area is approximately at the drip edge of the foliage, and soil disturbance close to the trunk may kill the tree. Not all equipment operators realize that a tree to be saved needs some undisturbed ground space to exist. If a little extra

expense in flagging saves a tree, it's worth marking such limits. Flagging is cheap, and a mature, healthy tree is of great value in what it ministers to the inner man and the "feel" of the sites we develop.

### **Blue and White Stripe – Rough Grade**

Once the site is cleared, you're often asked to stake the site and building for rough grade. It is important to ask and document in writing what grade you are instructed to reference on your stakes. You may be asked to use a particular depth below finish grade for parking and another depth for seeded areas, and another for the building itself. Normally, I add a second color of flagging to the blue and white striped flagging to help the excavator know what area is being graded.

For example, to the blue and white stripe I might add a strip of red for parking and drives and perhaps green for the building pad, if there is one.

This takes time, but the contractor will love you for this extra bit of care and concern for the team. (I can almost guarantee that your competition will not be so kind.)

### **Pink – Building Control**

Pink-glo flagging is very visible on a construction site. The building layout is something you really don't want to restake, because getting something in the same place twice is somewhere between difficult and impossible. Pink helps to avoid this simply because it's visible and exists nowhere else on site.

A second color should be added for special features within the building, such as elevator shafts, etc., so as not to confuse these stakes with other building stakes. For example, you might double-flag an elevator shaft with pink-glo and green-glo flagging, so that it's distinguished as something unique from stakes set for columns or other features. There is so much activity with people and equipment, and the layout is so critical, that flagging for buildings should be chosen for its visibility.

Stakes should be marked clearly in a manner similar to that illustrated elsewhere in this course, and a sketch or plan showing what you've staked should be created and provided to your client.

### **Yellow or Yellow with Black Stripe– Sanitary**

Sanitary sewer is usually deeper in the ground and usually gets built early in the site work process. Yellow is distinct, but not highly visible on a site void of vegetation. I use yellow at this point primarily because little else has been staked on the site. In areas of traffic, I may spray the stake itself with orange or pink paint to make it more visible.

### **Orange-Glo and Black Stripe – Storm**

Often stakes for both sanitary and storm sewers are present at the same time on the site. This orange-black combination is very distinct and visually separates the storm drainage from any sanitary stakes that may be nearby. Getting the two mixed up can be a problem, and the contractors appreciate recognizing one from the other at a glance.

### **Blue – Water**



Requests for staking water lines usually follow storm and sanitary. Water lines are pressurized and can generally be installed at a fairly consistent and comparatively shallow depth below the proposed grade. For this reason, they are often constructed after storm and sanitary utilities are in place. The color blue and water seem made for each other.

### **Red – Pavement/Curbing/Walks/Patios**

Red (not red-glo) is cheap, yet distinct. You may use a lot of it staking pavement and curbing. It does the job and is both visible and inexpensive. I often added a second piece of flagging in some other color to distinguish stakes at radius points. Even if your competition uses distinctly colored flagging, they are not likely to distinguish between curbing offset stakes and radius points by adding a second color of flagging. This small, extra effort may endear you to your client and to the subcontractor constructing the improvements.

That little extra touch may cause your work to be praised in brief conversations between contractors, or between contractors and your client. Nothing is more valuable than a good report.

### **Yellow plus Green-glo (one strand of each color) – Miscellaneous Features, with purpose of stakes clearly labeled.**

Envision the complete site staked with the distinguished colors as suggested above. Go ahead and conjure up an image. Any will do. Now, imagine the same site staked out by the orange-only firm. While not all features of a site are ever likely to be staked at once, many stakes referencing different features typically coexist at the same time. With a distinctly colored flagging scheme, all a superintendent of contractor needs to do is glance at a site to determine if new staking has been performed. Imagine an excavation contractor walking a site trying to determine if water lines have been staked when every stake on the site is flagged in orange. Now imagine this same supervisor trying to determine if equipment should be mobilized or not. This person familiar with your work and color-coding, need only look for blue flagging flying on the site in the general location of the water lines. No blue? Not staked yet. Blue flagging there? It's staked.

Can you imagine the advertising your blue flagging has done if this person has just come to your site after roving throughout the maze of the orange-only surveyor's work?

If asked to stake electric, telephone or other features like a transformer pad or dumpster pad or menu board, I use combined colors that are distinct from any other stakes on the site. The particular color chosen is not as important as the distinctiveness of the staking. But, I must be certain it is not a color or combined color scheme I use for standard staking.

### **Summary – Color-coded Stakes**

In this world, people think too little about what it's like to be the other guy. Following this or your own system of color-coding stakes will make the other guy's work easier. Most of your competition won't take special care with this. Many firms will stake like the "Orange Firm" mentioned above. Others will look around the site and maybe pick a color they don't see there already. Only a few firms truly have a color scheme and stick to it.

Be one of those few. Beyond this, why not make pocket sized, laminated tables of your color schemes and distribute it to your crews, your client and the subcontractors, particularly the excavator and utility contractors. If you don't have a laminator, maybe you should get one.

They're relatively inexpensive and are useful for your list of feature codes, data collector menu structure and for lots of just plain fun or promotional uses.

## Labeling of Stakes

### Hubs/Hubs with Tacks

A "hub" is typically a tapered stake six to twelve inches long having a top about one or one and a half inches square. I know of a firm that calls ALL their control points "hubs," even though the physical objects actually used for control points were rarely hubs but rather, 12" spikes, mag-nails, cross-cuts in rock or concrete, drill holes or rebars with plastic caps. A hub is a particular type of wooden stake. A control point can be any of a number of physical marks or objects, including a hub.

Many times, when staking for construction layout, a hub or a hub with a felt pen mark or tack in the top is set in the ground, along with a taller stake along side to call attention to the presence of the hub.

Hubs disappear from view on cleared sites because they blend in color with dirt. Why not make a rainy day activity the painting of the tops of your bundles of hubs with a bright pink or orange color? Hubs normally arrive bundled, and this facilitates spraying them.

Sometimes, when setting a hub and tack, you may wish to fold a piece of flagging to form a square or a square with a tail and put your tack through it in the hub.

In high traffic areas, you can spray the exposed portion of the sides with paint to make the hub more visible. In grass, you can spray a circle around the hub. Paint applied to grass can last quite a while, so use discretion.

### Guard Stakes, Witness Stakes and Lath – Tall Stakes

A "guard stake" or "witness stake" is usually a tall stake (usually 18" to 48" in length) with a flat surface wide enough to write on with a felt pen, placed along side of a hub and labeled to identify the hub and its relevance to future construction. "Lath" is sometimes used, lath being a thin strip of wood similar to that attached horizontally to vertical wall studs under plaster in older homes. For simplicity, I'll call these "tall stakes" in this discussion.

In my own business, I used oak stakes about ¾" by 1 ½" and 24" to 36" long, the length depending on both the type of soil the stake would be set in and the amount of labeling I expected to place on the stake. These stakes were planed (not just rough cut), stored indoors at the mill before I bought them and indoors at my office (Oak will turn black if it sits wet and also stinks.), and provided a smooth surface for labeling. They had a wide, flat top that made pounding them into the ground easy. They were sturdy, close-grained pieces of wood that almost never split or broke when being set.

One firm in my area used pine stakes made by one of their employees. They were made in a barn near the employee's home. I purchased these on occasion but found them to be rough, making writing with a felt pen difficult. And, they had knots that often caused them to break when being set in hard soil. When these broke, the sharp, splitting stake was a danger to the shins of the one installing the stakes, and the path the sledge hammer took as a stake broke under its blow was

unpredictable. Once the sledge hammer deflecting off a breaking stake injured an employee's knee. Cheap stakes can be expensive.

Another firm used rough-cut, 48" long lath, without even a point on one end. These 1/4" thick slices of pine were flimsy, springy and unwieldy to set. Placing one in hard soil required making a hole with a hub or frost pin prior to setting the lath. The edges were so rough, they were very hard to write on.

It never ceases to amaze me the truth in the expression, "penny-wise and pound-foolish." My advice: buy a good grade of stake and save some money by spending a little more for something that saves time and is safe to work with. Don't get thrift and intelligence confused. The former must remain under the dominion of the latter.

## **When to Use Hubs, Hubs with Tacks, and Tall Stakes**

In some cases, particularly for layout of construction requiring less precise horizontal location, no hub stake need be provided, a tall stake being sufficient for the purpose.

If you want to profit from your contract services (that is, from your fixed-fee layout services), it's good to know when providing just a labeled guard stake is sufficient, rather than setting both a guard stake and a hub,. Likewise, when the horizontal, positional tolerance of the item being laid out does not require the accuracy implied by the presence of a tack in a hub, it is best to not place a tack in the hub.

Does this seem like splitting hairs? While employed as an assistant superintendent, I remember watching a surveyor set a hub to mark blasting for utilities. This struck me as an absurd waste of time and money, because a tall stake alone is generally more than sufficient for the purpose. But, that surveyor wasn't through. Next another shot was taken to set a tack in the hub. Finally, the surveyor called for a third measurement to confirm the set position of the tack. I kid you not! After that, of course, a guard stake was placed and labeled. This penchant for precision took time. That layout activity was being charged to my employer on an hourly basis. For that blasting work, just a tall stake set within a half foot of the theoretical position would have been more than adequate, maybe even overkill. The fee for the surveyor's service was considerably higher than it should have been.

You've heard the expression, "The devil is in the details." This is true in the construction layout business. Knowing when to major or minor on details is a key to financial success.

Many surveyors and engineers, because of their lack of construction experience, simply and honestly don't know how precise the layout needs to be for a particular construction item. My advice is, never be afraid to ask the superintendent or the person requesting the layout, "How precise does this need to be, both for horizontal position and vertical cut or fill labels?" I'm convinced that most people love to help and instruct others. They like the experience of doing it. Seldom, if ever, have I had anyone refuse to tell me the answer to this question. And, to my knowledge, no one ever thought less of me for asking. If anything, they appreciated being asked. Remember, any seasoned construction person has watched surveyors split hairs on things requiring little precision and yet fail to provide sufficient precision for things that do matter.

In general we may conclude that a tall stake is generally sufficient for any blasting activities, and column line staking almost always requires all the precision one may bring to it. In between these tasks are layout items requiring varied levels of precision. Some require more precision in the horizontal component than the vertical, or visa versa. Know where to place the extra effort and when not to spend energy and time on precision if it just plain doesn't matter for that layout.

### Marking Guard or Witness Stakes

Remember, the person using your stake as they work may be on a piece of equipment or walking some distance from your stakes. Make your writing as large as reasonable and as legible as you can. Sloppy writing on a stake is annoying to the person trying to decipher its meaning. Never allow a 9 look like a 4 or a 3 to become confused with a 5. No one should stand scratching the head because your 7 has such a short top that it looks like a 1. Be consistent in the format of your labeling and in the positioning of the various labels on the stake.

When you label a tall stake with a cut or fill referenced off a hub stake, note "HUB" along with the cut or fill or grade notation, so that there is no possibility of confusion over what the cut or fill should be measured from. The illustration at right shows stakes clearly marked with reference to the hub.

Also, note that the illustration shows the clear space between the tall stake and the hub as 5". In my experience, if 5 inches or more is left between the tall stake and the hub, seldom, if ever, will driving the tall stake into the ground cause movement of the hub. For the critical horizontal reference from a tack set in a hub to be accurate, the hub

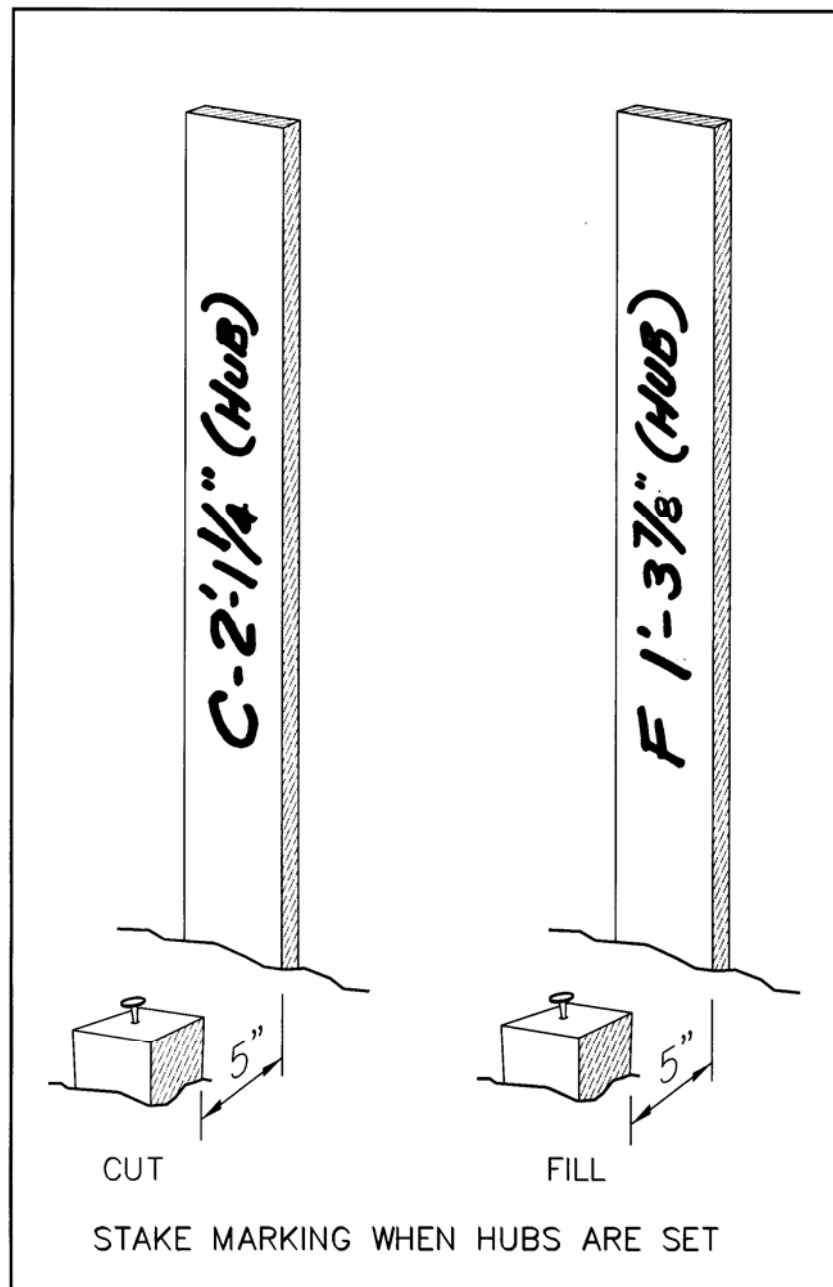

must not move when the tall stake is set in the ground. Probably the safest thing to do (not always the most convenient thing) is to set the hub, then set the tall stake, and set the tack in the hub last.

If the primary use of the stake is to control grade, place the cut or fill labeling on the side most likely to serve the person using the stakes. For example, if the offset stake is for a sanitary sewer, place the cut labeling on the side facing the future trench. If the offset stake is to a house or building corner, try to mark both the offset distance and the cut or fill on the side facing the excavation. On the back, you can add the point number or some specific detail regarding the point being offset. Once the person using your stakes has identified the relationship of your stake to the “hole,” that stake will be referenced again and again from within the hole, not from behind the stake. So, give that person the ability to stay in the hole and read the ‘cut.’

Be certain the person ordering the layout or using the stakes knows what point is being referenced. Remember the true story related earlier in this course where a large site was rough graded about two feet too low, with all that material carried off site because the contractor thought tall stakes with cuts marked on them referenced cuts from the ground level at the base of the stakes. The surveyor’s intended reference was from the top of the tall stakes. This was a near disaster, and I’ll never forget it.

Little things mean a lot. (Have I said that before?) I always tie my flagging to tall stakes by wrapping the flagging three times around the stake an inch or so below its top and tying the knot on a corner of the stake. This activity can be done prior to staking, because the flagging will not slip up and off the stake while pounding, if the flagging is good quality and is wrapped and tied tightly. I find it faster to pre-tie by holding the stake between my thighs than to tie-when-staked. (I once tried to teach this method to a very skinny employee. With his knees together, the stake simply couldn’t be held tightly.) I turn the stake when setting it, so the flagging (tied on a rear corner of the stake) is less apt to obscure the writing on the stake. Without wind, the flagging hangs toward the side of the stake away from the most-useful labeling. You may have seen equipment operators leap happily from their equipment when the coffee and food truck drives on the site. Don’t let this confuse you. Equipment operators don’t like having to get off their equipment to read your stake.

*Figure 8*, found earlier in this course, illustrates a suggested method for labeling grade stakes. Note the redundancy of the “C” or “F” with the V-shaped symbols that point to the reference line, and how those symbols are distinct from the “Grade” symbol. Of course, any labeling scheme will suffice if it clearly meets the following, essential requirements:

- 1) The point referenced by the stake – the unique name or identification of the point the stake references (N.E. Cor. House, Column 1-A, Sta. 3+50 Water Line for Blasting, Face of Curb at CB-17, a point per labeling on a sketch you provide, or whatever the plans call the point)
- 2) The horizontal position of the stake in reference to the point being constructed (10’ offset left, 25’ offset to Col. A-1 on A-line, Stake “A” on grade sheet sketch, Bottom of Retention Basin, etc.)

3) The vertical relationship to the point referenced (cut or fill to the future point or grade, ...to Top of Curb, Rim of M.H., Basement Floor at Elev. 104.50, Top of Top Step, Pavement Grade, etc.)

These THREE components MUST be present and presented clearly – not subject to misinterpretation. Your familiarity with what you are doing becomes your greatest enemy in this regard. Always ask, “How many ways can a person unfamiliar with what I’m staking interpret the information I’m providing?”

If the answer is anything but ONE, you’re at risk of paying for the resulting confusion and what gets constructed under its influence. Not all construction workers are brilliant people. Many are, don’t get me wrong. But some are not. You need to think like the less intelligent folks and make your labeling so simple that the least literate or least intelligent laborer will get it right.

## Rules of Thumb

Your work will go faster and be as precise as is needed if you memorize rules of thumb to help you interpret data or circumstances easily.

## Angles

A rule of thumb I use very, very often is this:

One hundredth per 100 feet for 20 seconds.

If you turn an angle to check something you’ve set 100 feet from the instrument and find the angle is off by 20 seconds of arc ( $0^{\circ}-00'-20''$ ), the point is about 0.01 foot left or right of its intended position. At 200', it’s doubled ( $0.02'$  or about  $\frac{1}{4}''$ ). I love this rule of thumb.

What if you stake some point 50 feet away and discover when checking it that it’s a whole minute off for angle. One minute is, of course 60 seconds or 3 times the 20 second rule per 100 feet. So, in 100 feet, being a minute off for angle shifts the point 0.03 foot left or right. But at the distance you are checking (50'), the error is half that, or 1 and  $\frac{1}{2}$  hundredths of a foot. Is that close enough for what you are staking? If so, move on. If not, fix it.

## Steel Tape Corrections

If you are skilled in the use and care of a high quality, steel measuring tape (or willing to become so), you will find many ways to save time and even increase accuracy using one. But, the steel tape expands and contracts with temperature changes, and corrections must be made for precise work. How much?

Another rule of thumb: one hundredth per 15 degrees Fahrenheit. If your steel tape is standardized at the usual 68 degrees, and it’s actually 15 degrees hotter (not the air temperature, the tape’s temperature), then the steel tape is 0.01' longer per 100 feet than it reads.

In my experience, many construction layout people have scratched their head over differences in redundant measurements observed using the same steel tape because of wrongly thinking that temperature correction is insignificant.



Yet, it's not uncommon for a cold morning to turn into a hot, sunny afternoon. If the difference between morning and afternoon air temperatures is 30 degrees, the temperature difference between the black-top road the tape is lying on first thing in the morning and later in the day, after the sun has soaked into the black pavement for hours, could be twice that, or 60 degrees. In this example, applying the rule of thumb, one hundred feet measured to set a point in the morning will measure 0.04' short later that afternoon. A half inch different? Yup.

The steel tape is a wonderful tool in the hands of someone who knows how to use it, knows how hard to pull to eliminate errors due to sag (very, very hard on longer distances – harder than you'd care to pull usually), and how to care for the tape so it doesn't look like the edge of a lasagna noodle as it comes off the reel.

The purpose of this course is not to instruct in its use, but IF you use one, be aware of its strengths and limitations, and keep this rule of thumb memorized.

For my first years of construction, prior to the total station, I used the 200' steel tape as my standard measuring tool – for control networks and for layout. It never failed me. It had no battery to go dead. But, in our time, not many people know how to use it for precise work, and this is a loss to the surveying profession and construction layout trade alike.

A thirty-something surveyor recently said to me, “Well, I'm not checking into some very old control points recovered. But, that was probably set back in the days when crews dragged a steel tape around.”

I used those steel tapes for over twenty years before my first total station. And I got better closures on control traverses than many less skilled crews get today with total stations and prism poles. There is nothing wrong with using a steel tape – providing you know how to use it. It is becoming a lost art, I'm sad to say.

## **Balancing Foresights and Backsights for Level Runs**

Not a rule of thumb, really, but a RULE.

IF – the crosshair in a level is out of adjustment (too high or too low in the center of the scope as you sight the level rod), and if it is consistent (meaning that the self-leveling mechanism of an auto-level is functioning properly),

THEN – if you balance the backsight and foresight distances between the level and the rod sightings, you will get the true difference between the elevations of the backsights and foresights.

Therefore, it is always a good idea to make your backsight and foresight distances to rod readings approximately equal when doing level runs.

## Record Keeping

### Covering Your A\_\_\_\_\_.

CYA, CYA, CYA!!! I used to say, “I spend 70% of my time performing construction layout services and 30% of my time Covering My A-a-a-activities.”

Construction is a blame-game! Beware. Do your work right and according to the plans or to written instructions, or at least to some form of written authorization or documentation. Try to think of what *could* go wrong, or how your labeling *could* be misinterpreted, or of who *might* unfairly blame you for inaccuracies in your work that did not actually exist. Then, CYA.

This theme is oft repeated throughout this course. Construction layout is like police work – lots of paperwork; lots of documentation, lots of reports, and occasionally a little work of the kind you imagined when you decided to do this for a living. You get the picture. Don’t think for a minute that all this CYA’ing isn’t an integral part of your job, your success, and your prosperity. When you get back to the office and you’re exhausted, write that e-mail, memo or letter instead of going home.

### Digital World – Shortcut to Disaster

In the digital times we live in, there is a tendency toward the elimination of paper and documentation. We don’t need the paper field book set up with all the angles we expect to turn and the stakeout distances written down. Our coordinates are uploaded, and we need merely tell the collector what point we’re occupying, what point we’re backsighting and what point we intend to set. The person with the prism pole heads in that direction and we push a button. The collector tells us how far to go or come to set the point. Some even tell us if our angle is wrong or how much left or right to go. We set the point and press on to set the next point, right?

Maybe not. If it is a critical point, subject to significant back-charges if we set it wrong, writing down the angle turned as read on the instrument (not the collector) and the distance (from a reading taken on the SET point) provides two benefits. First your work can be checked in the office. Second, you’ve made a record from which you can mount a defense against claims that you staked it wrong. How much more convincing it is to point to a record in a field book than to say, “Hey man, we used modern equipment!” Of course, if your angles and distances written down as checks *exactly* match their calculated, theoretical counterparts, we all know you’re lying.

Another and often better approach is to shoot the point you’ve staked and record it in the data collector with an unused point number. The collector can be downloaded, and the office computer can quickly inverse between the theoretical point and the very one you staked and then located. This set point remains in your digital data base, and can provide substantial proof of your work, even when the stake you set is long gone. Not too many will choose to argue with such proof, though it could be faked. Your field book should, of course note the point number used to locate the point set and adequately describe the identity of the feature staked to relate it to the new point number. Keep your data collector’s coded files. From these, you can demonstrate

that your raw files are unaltered by making the conversion from the coded file and comparing that to your raw file or other output.

As noted elsewhere in this course, digital plans are subject to corruption. Methods exist to reduce chances of this happening (such as locking layers and making frequent, permanent back-up files of work-to-date) but these methods are beyond the scope of this course to cover. But, do keep in mind that an inexperienced or inept CADD operator has the potential to do great damage unawares to the digital product. Be very careful who you let at the drawings that are as critical to your work as cogo points used to be in the dark ages of twenty years ago or less.

## **Record Keeping – Data Collection**

It amazes me that many of today's crews do not make notes in their data collection file using their collector's keypad. Often, looking at the files, it's impossible to tell what project, what function, what crew, which positions in the crew, environmental conditions, or much else about the job or exactly who did what and why.

We need to get back to basics, folks. A fieldbook contains a record of certain essential things, whether electronic or paper, that have been standard operating procedure for surveyors or other professionals doing construction layout since the Flintstones. Basic surveying books from antiquity speak of these things, and people once observed their sage advice. What has happened?

Get back to basics, and keep good digital records when using data collection!

## **Paper Fieldbooks – Not Outdated**

### **Bound v. Loose-leaf**

Debate will always abound regarding this, but one fact is certain: It's infinitely harder to fake data, particularly past data, or to create the impression you performed some task you didn't or in a way you didn't, if you log your activities each and every day in a bound field book. Its bound pages can't be torn out or new pages inserted between others without leaving traces of those actions. For this reason, bound books are generally adequate evidence that you've made a habit of consistent, sequential record keeping. Loose-leaf field books offer many advantages, but this is their weakness. If you are ever in court, you'll appreciate the benefit of using bound field books.

### **Loose-leaf Fieldbooks:**

#### **Advantages of Loose Leaf Field Books**

##### **Copier Sketch or hand-drafting easier**

If you elect to use loose-leaf fieldbooks, don't overlook the advantage of sometimes copying an image directly to the fieldbook paper.

Here's one way: Suppose you have a reduced sketch or plot of a column layout with point numbers for a building you are going to stake, and that it will fit on a loose-leaf sheet. Wouldn't it be helpful to have that sketch right in the fieldbook?

You can place the sketch in your copier and make a copy on a regular sheet of paper. Next, place the fieldbook page over top of the image on the just-copied sheet of paper, with cellophane tape holding the leading edge of the loose-leaf sheet to the copy paper, letting just a little of the tape cover the leading edge of the loose-leaf sheet (most of the tape being on the full sheet of regular sized paper).

Without moving the sketch you are copying, pass the paper with the loose-leaf sheet taped to it through the single-sheet feeder of the copier and voila! You have the plot right there on the loose leaf sheet for insertion into the field book.

I've done this often, and it's wonderful not to be wrestling with large plans when staking for construction. It becomes a part of your documentation, too – all in one place.

### **Not lose all or damage all**

A second advantage of loose-leaf sheets is you don't lose a whole book if you or your crew misplaces the day's work or leaves it on the roof of the truck when driving off the site. You lose only what was in the binder. Having lots of pages in the binders I've used makes turning the pages difficult, so a few pages is all I usually carried while performing the work in the field. The benefit? Less to lose that way.

### **Lighter to carry**

With all the stuff I carry on my belt, I appreciate the lighter field book.

## **Disadvantages of Loose Leaf Field Books**

### **Not as good legally**

Any old-time surveyor and many young ones will tell you that the bound-book style of fieldbook is superior to loose-leaf fieldbooks when introduced as evidence in a court of law.

### **Individual pages are easier to misplace, misfile or lose.**

A record in the wrong job folder is as good as lost. It's easier to misplace or misfile individual pages than a whole book. Individual pages disappear in a project folder and easily fall out of folders when they are being handled. They fall on the floor of the survey vehicle unnoticed. They blow out the window as you're driving.

### **Copying slightly more difficult**

I find copying loose-leaf pages more challenging than copying from a bound book. Somehow, the flip-flop of pages to make facing pages copy on one sheet and get returned to the binder in the right order is sometimes confusing. Then again, I'm copier challenged.

### **May lose count when numbering pages resulting in skipped numbers or duplicate page numbers**

It's always been a no-no to erase in a fieldbook. If someone gets confused when numbering fieldbook pages in a loose-leaf binder (or pages that have just blown off your desk), it may be

hard to get straight which page goes where. If you cross out or erase page numbers, your work looks messy and disorganized. You may take a few loose-leaf pages with you to a project and forget that pages 20 through 30 are in the office, so you start numbering pages with numbers that are already used. Or maybe you don't number them at all, because you aren't sure what the starting page number should be. This is a hassle.

### **The raised rings of loose-leaf binders make note taking harder.**

Sometimes notes are neater in bound books because the raised rings on loose-leaf binders makes writing difficult by interfering with the free movement of your hand. The rings also make using templates difficult.

### **Do as I say, not as I do.**

In spite of these truths, I've used loose-leaf field books for construction layout. This is a personal choice. To date, I've not suffered for this choice, a decision made contrary to the text books, my own advice and common sense.

## **Bound Fieldbooks:**

### **Advantages**

#### **Legally Superior, as stated above**

Did I mention that bound books make better legal evidence? A bound field book with dated pages and entries made without erasures has always been the surveyor's friend in court. Instead of erasing in a fieldbook, conventional wisdom says that errors or bad entries should be crossed out with a single line – a line bold enough that the entry can't be mistaken for good data, but lightly enough so the voided data can still be read.

Of course, entries can be altered in a bound field book at any time by a determined and clever person. But, it is hard not to leave trails. Adherence to the age-old rule, "Never erase in a field book," with the use of bound field books is the safest rule for creating sound evidence. Just remember: evidence is evidence, whether for you or against you.

#### **Can't open in the wind and scatter pages**

Sometimes a dropped, loose-leaf field book opens its rings and sends your pages flying on the winds. The sight of you chasing them across the construction site will amuse the other contractors on the site, and there's something to be said for lightening their day. But, pages that are lost in the chase or destroyed by landing in the mud or being run over by equipment may contain data you can't afford to lose.

### **Disadvantages**

#### **Not convenient to copy to**

You can't photo copy directly to pages of a bound field book like you can to loose leaf pages (in the manner noted above). Still, it's possible to tape a photocopied image directly to the bound

page. This may be easier than photo copying directly to a loose leaf fieldbook page. (The idea of taping a copy directly to the bound page should not be dismissed lightly. It's sometimes a tremendous convenience and time-saver, and yet is almost never done.)

### **Sketching more difficult**

It's harder to make sketches at a table due to the thickness of the binding. Single pages are easier to make sketches on when making sketches in the office. (Of course, bound field books are easier to sketch in when working in the field.)

### **Entire book may be lost or destroyed.**

If you leave a bound book on the roof of the truck and drive off, you've lost a whole book of data rather than the few pages that would be in a loose-leaf book. For this reason, photo copies of your bound field book should be made current with each day's completed work. That way you may lose the book, but you never lose more than a day's notes.

## **Field Note Reductions**

Field books, whether bound or loose-leaf, frequently contain data to be reduced, for example, conventional level runs. The land surveyor typically checks to verify that the sum of backsight readings and the sum of foresight rod readings are equal or near equal for a given run. But, the individual turns along the route of the level run are reduced back in the office.

Many surveyors copy their field book pages and make all reductions, averaging of angles and such only on the copies, and these calculations are typically made in red pencil. For most land surveying applications, this is fine. For construction layout, this may not work.

While performing construction layout, information is often needed immediately and repeatedly. The field book may be the place to make and record these calculations so that the information is always available in one place for the field crew's use.

## **Double Copying – Triple Caution**

This may seem like a simple administrative task, but... How can you make certain that copies of *final* reductions and calculations are available to the field crews and also safely backed up in the office?

When a field crew needs to know the elevation of a particular turning point observed a few days earlier, they need that elevation right then – and, it needs to be the *final* elevation as computed and adjusted in the office. If the firm's policy is to copy the field book and then make final adjustments on these paper copies, that's great. Most firms do this.

But, copies of the copies that contain final adjustment need to be in the field folder for the crew's use. Any revisions made later (say, in the light of additional information or evidence) must also be updated in the field folder's copies of copies of field book pages.

Of course, at the moment the office person making updates thinks of placing it in the field folder, the field folder is where? Probably in the field. So, the updated pages are set aside on the cluttered desk of the overworked office person and are soon covered over with the mound of



paper generated by that person's next assignment. The revised pages that should be in the field folder get buried or misfiled with some other project.

## **The Mail Rack**

I recommend a mail rack to solve this administrative problem. This is a place to put paper work or notes for each crew chief or each active project (or maybe both if different crews service the same project).

This Mail Rack must also have slots for the field crews to leave notes or copies of the previous day's field notes for the office people. The field person may quickly scribble a note on a piece of paper for the office technician saying, "Downloaded Parsons Way – Pars-9.rw5. Ready for edit & processing." This note attached with a paper clip to the copies of newly created field book pages for that data collection file let the office person know exactly the status of the field work.

In that crew chief's mail slot are copies of the reduced level run with final, adjusted elevations to be used for the duration of the project.

## **An Undivided Mind is an Efficient Mind**

This simple system ensures essential back-and-forth correspondence among field and office workers. You and I know the problems that occur because we place a piece of critical correspondence on someone's cluttered desk and the uncertainty we feel as we walk away. Will that person see it? Will a less important piece of paper cover it before it's seen and acted on?

These concerns, whether we're conscious of them or not, are parasite ideas that nibble at our consciousness and consume a part of our faculties that should be present to the next task we tackle.

Or, we wonder if the crew closed out a data collection file the previous day, and if so, what did they name the file. So, we begin searching the project files in the computer, trying to remember what the crews named their raw files or looking at dates of files to find the most recent. Then we open the newest one and see what point numbers were used for that collection, and then we open the drawing file or the cogo file to see if anyone reduced and processed that electronic file.

The larger the firm, the worse it gets!

All this wondering if something has been done and trying to remember to check with so-and-so to be sure the paper you left on his or her desk has been acted upon is taxing, distracting and inefficient.

The Mail Rack is your friend. You know if so-and-so got your note by whether or not it's still in the rack. You can be certain the crew will receive the latest data on the project because it was placed where the crew looks each morning to get their instructions and updates.

Equally important, you can say good-bye to parasite ideas that bring you tension, stress and uncertainty. Your mind is free to attack the next project with undivided concentration (except for the phone calls, distractions from co-workers, malfunctioning software, administrative duties, e-mails...).

Isn't your work difficult enough without having to do the job a Mail Rack would do faithfully for you, day after day after day, project after project, never complaining, never asking for a raise, never creating a disaster for lack of follow-through?

### Each and Every Day – Rubber Stamp

Most crews and firms I've work with in the last two decades have lost the art of diligent record keeping and thorough communication.

The field book, whether paper or electronic data collection file, must have the following records for each and every day. I require the following notes at a minimum, and have a large rubber stamp that is carefully applied to the field book each day before leaving the office for the site. This is helpful, because the information is placed consistently in the same location on the page of the paper fieldbook every single day, no matter which persons make up the crew that day.

This stamp fits a #1 (standard) stamp pad. Before a crew leaves in the morning, they stamp their beginning page in the fieldbook and fill in the blanks. This format not only encourages keeping a complete record, it also builds a consciousness into the party chief regarding whether the assignment is hourly work, contract work, extra work or restaking (the meaning of the H, C, X, and R boxes). The boxes at the bottom are the "end of day" reminders: The party chief states that the assignment was or was not completed, is reminded to fill out any Conversation Log(s) for conversations or instructions that took place that day, and the Work Order number is placed here, so the actual work can be easily linked to the Authorization.

Proj. #: <b>05-237</b>	Date: <b>10/27/05</b>
Client / Site: <b>HARTSLANDING PHASE 2</b>	D.C. filename: <b>HL2-07</b>
Mission: <b>BUILDING 5 STAKE COLUMN OFFSETS</b>	<input type="checkbox"/> H <input checked="" type="checkbox"/> C <input type="checkbox"/> X <input type="checkbox"/> R
Weather: <b>WINDY-LIGHT RAIN</b>	<b>40° AM</b> <b>50° PM</b>
Crew / Role: <b>PTG X #0C PRF ΦM</b>	
Instrument: <b>DTM-502 (1)</b>	Collector: <b>RECON (2)</b>
New Work or Continued From Fldbk: Started <input type="checkbox"/> Today: <input type="checkbox"/> # <b>05-3</b> Pg. <b>37</b>	Finished? <input checked="" type="checkbox"/> YES <input type="checkbox"/> NO
Any New Conversation Logs? <input type="checkbox"/> YES <input checked="" type="checkbox"/> NO	Work Order No. <b>2347</b>

### Client / Site – Who are you working for – on what project, and what you are doing that day?

Every page (or pair of facing pages) MUST note this essential data. This data automatically gets noted on the start-page because of the rubber stamp, but the crew must be required to note it once at the head of every double page so copies don't get shuffled with some other project. It is not sufficient to just place this on the first page used each day.

On successive pages for the same assignment and project, an abbreviated notation is acceptable like, "Baker Subdiv, Ph. II – Stk. Robbins Dr. for Clearing." The person who is not the driver returning to the office can add this to each page at the end of the day.

## **Mission – What are you doing there?**

How hard is it to place prominently in a note what the mission for the day is? “Stake water line for blasting” This facilitates office work so much, and it makes finding some particular matter so much faster. The larger the project, the more critical this becomes. Yet, I’ve seen page after page in a field book lacking this basic and essential information.

## **Crew – Who did the work?**

Not only the WHO should be recorded, but the WHO-DID-WHAT must be logged. I want to know who made the notes or operated the data collector, who ran the instrument and who ran the rod or prism pole. When the roles change during the day, I want to know exactly where in the day’s work that change of roles took place.

Often the experienced crew will swap roles after lunch. This should be noted in the data collector and in the paper field book.

Is this necessary? Absolutely. Is this being a Big Brother Control Freak? No, and here’s why. I’ve seen crews who’ve been collecting automated line work in data collectors for years who don’t know how to code and shoot the curves correctly. When I speak to them and show them examples of what went wrong, it’s always the other guy who was running the prism pole for the shots – or – if it’s a problem in the notation in the data collector, it’s the other guy who was running the collector that day.

This doesn’t happen when the collector indicates a specific person was running it after lunch, and that’s when the mistake occurred.

Having this information is not for the purpose of condemning anyone; it’s for the efficiency of correcting bad data in a timely manner. It’s way down the road that any one person is chastised for the problem – only after repeated instruction goes unheeded. And, it seldom comes to that.

## **Date**

EVERY pair of facing pages MUST be dated.

## **Weather**

A simple note like “Intermittent Rain, 40 degrees & windy” may not seem very important, but two years later, that information may bring the particular day to remembrance. This note may be made at the end of the day when the weather for that day can be summarized. A note made at the start of the day can’t possibly summarize the day’s weather.

## **Equipment: Instrument and Data Collector**

What instrument was used? If you own more than one instrument of the same model, enter the serial number or the firm’s instrument number. The filled-in sample of the rubber stamp above indicates the firm’s #1 DTM-502 was used with the #2 Recon data collector

Have more than one collector or instrument? Which was it? This can be critical information when you’re trying to figure out which instrument/collector combination is giving inconsistent performance, intermittently fails to function or gives occasional bad data. These things do

happen, and it is a diagnostic nightmare to find out which instrument, collector or operator is at fault. Finding the pattern is so much easier with good records.

And what if you discover an instrument is adding some constant to its distance readings? It's a simple matter to go back job-by-job with these records and quickly determine which ones may have been impacted and if so, which ones matter for the degree of error.

## **Collector's filename**

The paper fieldbook that most people keep to accompany electronic data collection, should note the data collector's file name. No one in the office should ever have to turn page after page in the field book hunting for that information.

## **Field Notes – Essential Minimums**

Some common sense and age-old, standard procedures must be applied if field notes are to be efficiently interpreted and contain adequate information.

## **Inst. Point, B.S., H.I. (even on resets after lunch)**

Most firms, even when using data collectors, will note in paper field books the occupied point identification (point number and physical description of the point set), backsight point number, H.I. and rod heights (that is, the initial rod height and each change in prism height made before what point number). On large projects, the instrument will often be taken down for lunch and reset after lunch. Some crews fail to record the reoccupation and backsight and even exchange roles within the crew without noting that change. This should not be.

The little three-legged transit symbol should appear in the paper field book each and every time a new instrument setup is made. And, incidentally, a new backsight equals a new setup!

I've seen paper field books in which there's an obscure notation about the horizontal angle being zero-set on a new backsight point without moving the instrument. The note was buried among other busy notes and easily overlooked. A critically important note that is graphically lost amidst general notes can bring much confusion.

## **The CLOUDS of Confusion**

I always instruct my crews to draw clouds around notations in the paper fieldbook that indicate errors, deletions or changes that need to be made to the data collection files prior to processing. This causes essential notations jump off the page at the reader. They are hard to miss. Conversely, critical notes buried among other notations in the paper field book are easy to miss, and this can be very, very costly.

## **Last Shot a "ckbs" ALWAYS**

How can you prove that the zero backsight setting was not lost during your layout or recorded observations, if you don't record a final reading on the backsight before picking up the instrument? Answer: you can't!

Imagine yourself in court answering the question, “How do you know the zero backsight angle was not lost?”

Can you point to the last line in the data collection file, or do you say, “Well, the guys always check.”

The simple truth is, if it isn’t recorded, it can’t be proven. When problems appear in the data, there is no way of knowing if the backsight was lost at some point during the shots taken at that setup.

In data collection, a unique description (feature code) can be used for this shot, something like “CKBS.” If you don’t like the shot plotting in your drawing for the backsight check, you can easily convert that line in the collector file to a note before processing. But it will always remain in the original downloaded file and can prove the integrity of the angles turned at that setup if the need should arise.

## **Pages numbered at BOTTOM of pages, at corners**

If fieldbook pages are to be copied with facing pages on a single sheet of copy paper in landscape orientation (8 1/2” high and 11” wide) and bound at the top, place page numbers at the bottom of the pages paper field book pages, not at the top. This makes finding a particular page number easy, without having to lift entire sheet after sheet of copies to peek at a page number stuck up there under the binding edge. If loose-leaf fieldbook pages are used, use the same number for facing pages, so that the two facing pages have the same number, labeling each.

Pet peeve: Field book pages should be copied so that a blank area on the finished copy coincides with the binding edge on the copied pages. Believe it or not, some folks just don’t get this, and stuff you need to read gets stuck out of sight under the binder.

## **At End of Each and Every Assignment**

### **“End of Day” note**

At the end of the day, place a bold “**END OF DAY**” note at the end of that day’s work in the paper field book. Also, an “END OF DAY” note should be placed in the electronic data collector if the file is to be added to on another day, and the standard notations should be placed in the electronic file at the start of each new day. A sharp crew person will do this during the drive to the site, so time is not taken on the job site to log these entries.

## **Index in front pages of paper fieldbooks**

Leave plenty of blank pages at the front of the paper field book and use them as index pages. Entries should be neatly and consistently entered in columns, appearing as they would in a spreadsheet. I know some crews who feel that during long drives to distant work sites, one person drives to the site while the other sleeps, and those roles reverse on the way home. Neither person thinks it necessary to take a couple of minutes to index the day’s work in the front of the fieldbook. Unbelievable!

## CYA Memos

Much has been said in this course regarding your CYA function – an integral part of the construction layout business. In fact, if you analyze this course material, you'll find this topic lurking beneath the surface just about everywhere. As said earlier, construction is a blame-game. Play to win.

Certain standard memos are sent to my clients as a matter of course.

### Most Recent Plan Memo

As noted earlier, I periodically send memos with a catch phrase in bold type saying,

**“Remember – It doesn't get built according to the most recent plan!**

(It gets built according to Jonathan's plan.)”

Then I briefly note that I am working from plans dated such-and-such and will continue to use these plans unless notified of revisions.

This sort of memo is always sent when I am awarded the contract, since time has passed between when I obtained or reviewed a bid set and the time a contract was awarded.

In many cases a new plan has evolved, and I don't want to waste time computing from an old plan. This is one of the first orders of business upon being advised of the award. Obtain current plans.

### Staking per Plans Dated

With each new feature to be staked (utilities, building, etc.) I consider whether or not to send another memo advising that I am staking based on plans dated \_\_\_\_\_. I don't want to be a pest to my client, but some clients need to receive such a memo in order to protect both them and myself.

### Follow-up to direction given in field

If given direction to stake contrary to plans, I will ALWAYS get signed authorization from the client on my Work Order to do this or anything contrary to plans. Sometimes, depending on the significance of the change from design, I will follow-up with a memo to my client's project manager or the designer.

Do be careful not to offend the person who gave you this direction in the process or C'ing-Y-A. It may be a good idea to let that person know you will follow with a memo to their office and the designer just to CYA. The site people know this is a regular part of your self-preservation, and they'll normally not take offense at your carefulness in this regard.



## **Any requests that might be confused as to whether they are inside or outside the scope of your contract services**

Normally, on a typical site, the superintendent is both capable and empowered by his employer to authorize you to do work as an extra, that is, to perform work beyond the scope of set-fee services listed in your contract.

If you have any doubt about this or have gotten burned by this client, then a memo to your client's project manager may be necessary.

My experience is that the superintendent will almost never take offense at my memo to his superiors if I advise the superintendent of my need to do so prior to sending the communication. I'll say something like, "Well, you know, I'll have to shoot off a CYA memo to your office, because this isn't in my contract, and I don't want them to argue about paying me later. I'm sure you understand."

And they do.

## **Any site activities that might lead to confusion**

Have you observed that activities of others on the site might compromise the integrity and usefulness of your stakes? Have vandals removed, or worse yet moved your stakes? Have you seen other subcontractors moving your stakes or robbing them for other purposes, especially before they've served their intended purpose?

You may wish to document such observations to your client in writing. It is possible that someone may use the relocated stake without knowing that it's out of position. You need to be out of the firing line when this happens.

## **Equipment tracks along side of stakes**

Have you observed equipment tracks along the side of your stakes set to mark some critical element of the construction, column offsets for example? Verbally notify the superintendent and the contractor who will use your stakes, if that contractor is available or easily reached by phone. Put this in writing and copy both your client's field and office supervisors. Make a Conversation Log to document whom you've told about the condition and when.

Is this really your responsibility? Of course not – until something goes wrong because the stake was disturbed. If you know about it, let others know.

## **Grade Sheets (Cut Sheets)**

The sample Grade Sheet on the following page illustrates essential information typically found on grade sheets. This Grade Sheet (sometimes called "Cut Sheet") accompanies layout of a driveway and house on a single, upscale subdivision lot. Note this is Sheet 1 of 3. It's advisable to always include sketches to make your Grade Sheet understandable. Don't make the contractor walk the site, analyzing your stake placement and it's labeling just to try and form an understanding of your approach. Make clear sketches. Sheets 2 of 3 and 3 of 3 illustrate this and are shown and discussed in more detail on pages that follow.

<b>GRADE SHEET</b>					
PROJECT NO. <u>PA 3763</u>		CALC BY <u>HPL</u>		SHEET <u>1</u> OF <u>3</u>	
PROJ. NAME <u>HERITAGE DRIVE</u>		CHECKED <u>JT</u>		DATE <u>10/15/2005</u>	
ITEM: STAKE DRIVE AND HOUSE - LOT 16 PER PLANS REVISED 10/7/05					
STATION/ STAKE #	MARK & OFFSET	STAKE ELEV.	WORKING GRADE *	DECIMAL FEET	CUT OR FILL
---- DRIVEWAY STAKE-OUT ----					
0+14	HERITAGE DR. (EXIST'G GRADE @ DROP CURB)	1116.65	1116.60		
0+68.8 PC					
#156	HUB 25' OFFSET LEFT - TO C.L. DRIVE	1124.79	1123.99	C = 0.80	CUT = 0' - 9-5/8"
1+48.3 PT					
#159	HUB 25' OFFSET LEFT - TO C.L. DRIVE	1128.32	1136.19	F = 7.87	FILL = 7' - 10-1/2"
2+28.7 PC					
#165	HUB 25' OFFSET LEFT - TO C.L. DRIVE	1147.80	1147.56	C = 0.24	CUT = 0' - 2-7/8"
3+17.6 PT					
#166	HUB 25' OFFSET LEFT - TO C.L. DRIVE	1154.75	1159.44	F = 4.69	FILL = 4' - 8-1/4"
4+42.6 PC					
#167	HUB 25' OFFSET LEFT - TO C.L. DRIVE	1165.67	1169.97	F = 4.30	FILL = 4' - 3-5/8"
5+04.8 PT					
#170	HUB 25' OFFSET LEFT - TO C.L. DRIVE	1173.23	1177.69	F = 4.46	FILL = 4' - 5-1/2"
6+06.5 PC					
#172	HUB 25' OFFSET RIGHT - TO C.L. DRIVE	1190.81	1190.78	C = 0.03	CUT = 0' - 3/8"
6+70.4 PT					
#173	HUB 25' OFFSET RIGHT - TO C.L. DRIVE	1194.90	1197.63	F = 2.73	FILL = 2' - 8-3/4"
---- HOUSE STAKE-OUT ----					
#31	HUB 25' OFFSET BLDG. BOX	1200.32	1203.00	F = 2.68	FILL = 2' - 8-1/8"
#32	HUB 25' OFFSET BLDG. BOX	1195.40	1203.00	F = 7.60	FILL = 7' - 7-1/4"
#33	HUB 25' OFFSET BLDG. BOX	1197.17	1203.00	F = 5.83	FILL = 5' - 10"
#34	HUB 25' OFFSET BLDG. BOX	1200.45	1203.00	F = 2.55	FILL = 2' - 6-5/8"
<p>* The elevations shown in this column were taken directly from our copies of the construction plans for your project. If you, or your contractor, differ with any of the elevations, please notify us immediately. PLEASE REVIEW THIS COLUMN</p>					

First, let's look at the first sheet in the set. Grade Sheets are set up in various ways, but the essential information usually includes the following:

**Heading Data:**

- Project data.
- Date of preparation
- Other miscellaneous data you may wish to include (your firm's logo, who prepared and checked the data, etc.)
- Under "Item:" (or similar heading) the grade sheet must always state what future construction was staked, in this case a driveway and control rectangle for a house. It's

important to note very specifically what was staked and where on the site it's located. For example, on a commercial site, it might be "Storm Sewer, North and East of Building." In the case of this Grade Sheet, the construction is taking place in a residential subdivision, and the location is clear from the project name and lot number.

- Also, prominently on your grade sheet, be certain to state the date of plans upon which you based your layout. This could help to save you the cost of demolition and reconstruction in the event you have not been provided with current plans. On this grade sheet format, that information is included with the description of the layout provided in the hopes of drawing the contractor's eye to that information.

### **Cut and Fill Data:**

- In this sample case, the subdivision's roadway has already been constructed and paved. The contractor knows to match the driveway to the existing drop-curb (the driveway opening in the curb) at the edge of road. This is the first station given, 0+14.
- In the first column under Station/Stake #, the first driveway point actually staked in the field is at station 0+68.8 (68.8 feet from the centerline of the road). At this station a curve in the driveway begins (noted "PC" for point of curvature).
- Next under Mark & Offset, the grade sheet tells the contractor the control point is a hub placed at a 25' offset left of the centerline of the proposed driveway, looking up-station. The contractor will find a guard stake placed next to a hub, and on the guard stake a point number (#156) is labeled.
- The top of hub stake elevation at this point is 1124.79.
- The working grade (the proposed grade at the centerline of the driveway is 1123.99.
- The grade at the final centerline of constructed driveway must be 0.80 lower than the top of hub elevation (thus, Cut = 0.80).
- An equivalent Cut is given in feet, inches and fractions of an inch, because this contractor works in feet and inches, not decimal feet.

It's important to always state the physical type of reference mark you've placed in the field to guide future construction. In this case hubs were used. Hubs are tapered stakes normally about 6" to 12" in length, with a 1½" by 1½" to 2" by 2" square top. For precise layout a surveying tack or nail is set in the top of the hub to mark precisely the reference point on the stake. Because hubs are driven flush with the existing ground surface or close to it, guard stakes are normally placed along side the hub and serve both to "guard" the stake and to provide identification and other information about the hub.

Guard stakes, sometimes called witness stakes, vary in dimensions, as noted elsewhere. Whatever their size, they are normally flagged (hopefully using a color-coded flagging scheme), and each guard stake's labeling tells the contractor information about the hub it guards. When you provide a grade sheet, all a guard stake's labeling must accomplish is to distinguish it from any other stake on the site. A stake number is adequate, though you may often add the station plus the offset distance and direction (left or right) and the point referenced (in this case, the centerline of drive). In some cases, you will be asked to mark the cut or fill on the stake, which

makes creation of a grade sheet redundant and generally unnecessary. But, there are added liability risks in *not* providing a grade sheet, as discussed elsewhere in this course.

In some geographical regions, contractors want cuts and fills expressed in feet, inches and fractions of inches. If you provide this, be most careful in making conversions and be sure to check them carefully. I use my spreadsheet's LOOKUP function to make the conversions, but it's dangerous to always trust the results of a spreadsheet's formula or lookup table. Three sources of error are:

- Any fault in the formula or table,
- Any corruption a user may inadvertently cause, or
- An unknown occurrence of input data that causes your formula or table to return wrong answers. This is usually a rare circumstance unforeseen at the time you built the formulas and lookup tables in your spreadsheet. A typo in a lookup table could also return an occasional or rare error.

Any of these may cost you dearly. I always review the spreadsheet's conversions to be sure they look right.

Finally, note any disclaimers or warnings you feel are prudent to include.

## Notes

You may wish to include standard notes like the one at the bottom of the sample Grade Sheet. Additional notes, disclaimers or warnings that may be appropriate for some applications are given below:

### Check two stakes

“Contractor is advised to check elevations of two stakes at critical points prior to construction to verify accuracy of data provided.”

### Based on Plans Dated.

“Computations based on plans dated \_\_\_\_\_. Do not construct per this sheet if newer plans exist.” (In the sample, the plan date is included at the top of the sheet, but this caution's importance is one that can't be overstated.)

As noted elsewhere in this course, frequent problems exist because you, the surveyor, engineer or layout contractor, are generally out of sight and out of mind. When plan revisions are distributed, you'll often be left out of the loop.

Always, always include the date of plans used for your computations somewhere in the material you deliver to guide construction. On the sample Grade Sheet this is noted in the heading of Sheet 1 of 1.

## Abbreviations

You may want to create a standard table of abbreviations, such as L=left, R=right, C=cut, F=fill, O/S=offset, CL=centerline, EP=edge of pavement, BLD=building, FNDN=foundation, or any abbreviations you think require explanation.

## Offsets to

Some grade sheet forms specify in their heading what the offsets are to. For example, a blank line at the top of the sheet labeled, OFFSETS TO: \_\_\_\_\_. A Grade Sheet can be set up any way that works for you and your clients.

## Sketch(s) Attached

The sample Grade Sheet does not specifically note that sketches are attached. The fact that it is sheet 1 of 3 implies that additional pages follow, but it would probably be better if a prominent note were included saying something like, "SEE 2 SKETCHES ATTACHED".

For the above Grade Sheet, two sketches are provided (one for the driveway stakes and one for the house), and these are shown next:

SHEET 2 OF 3

# GRADE SHEET

## HERITAGE DRIVE - LOT 16

SKETCH SHOWING DRIVEWAY STAKES SET  
ACCOMPANIES GRADE SHEET DATED 10/15/2005

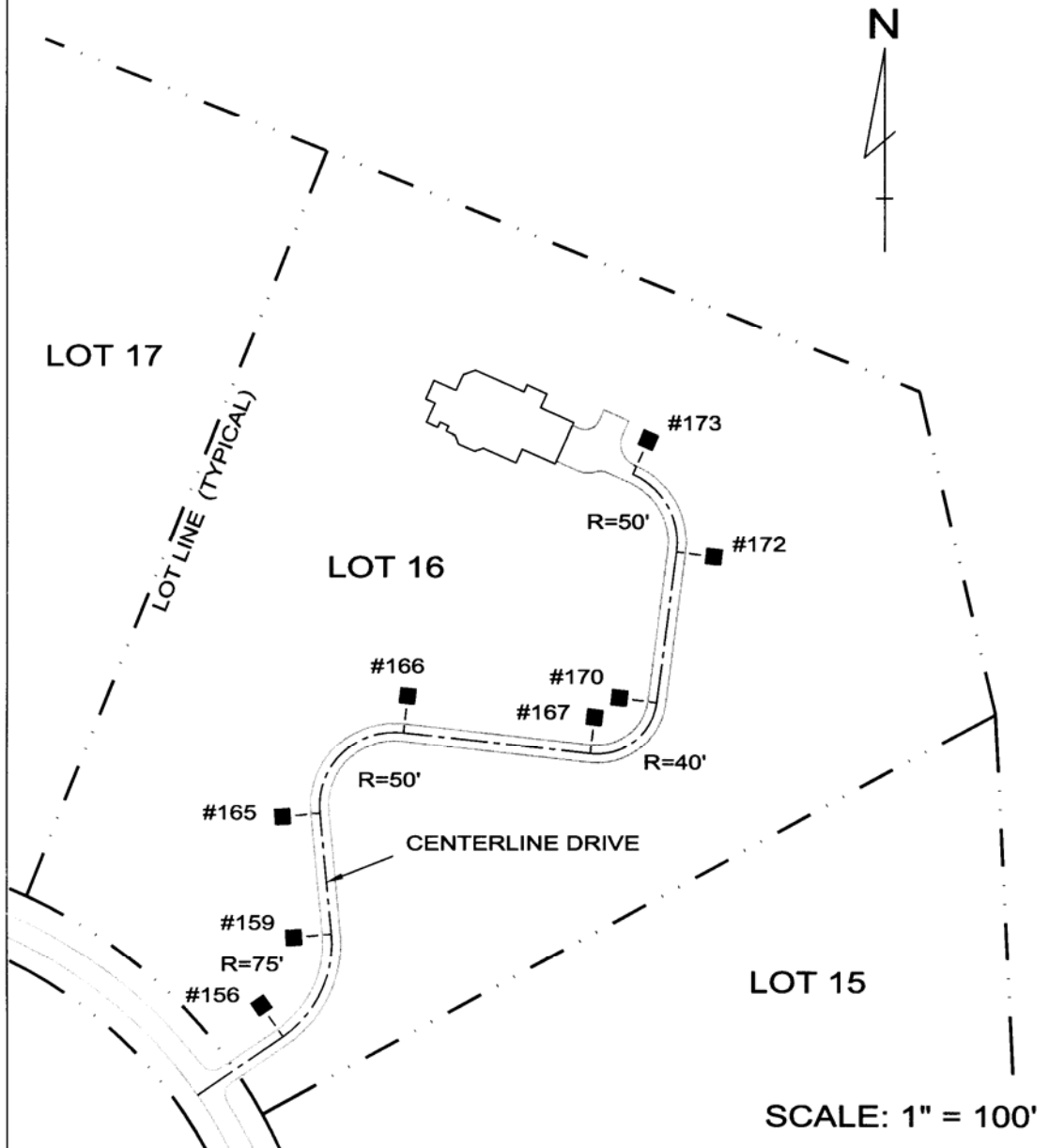



SHEET 3 OF 3

### GRADE SHEET

HERITAGE DRIVE - LOT 16

SKETCH SHOWING HOUSE STAKES SET  
ACCOMPANIES GRADE SHEET DATED 10/15/2005

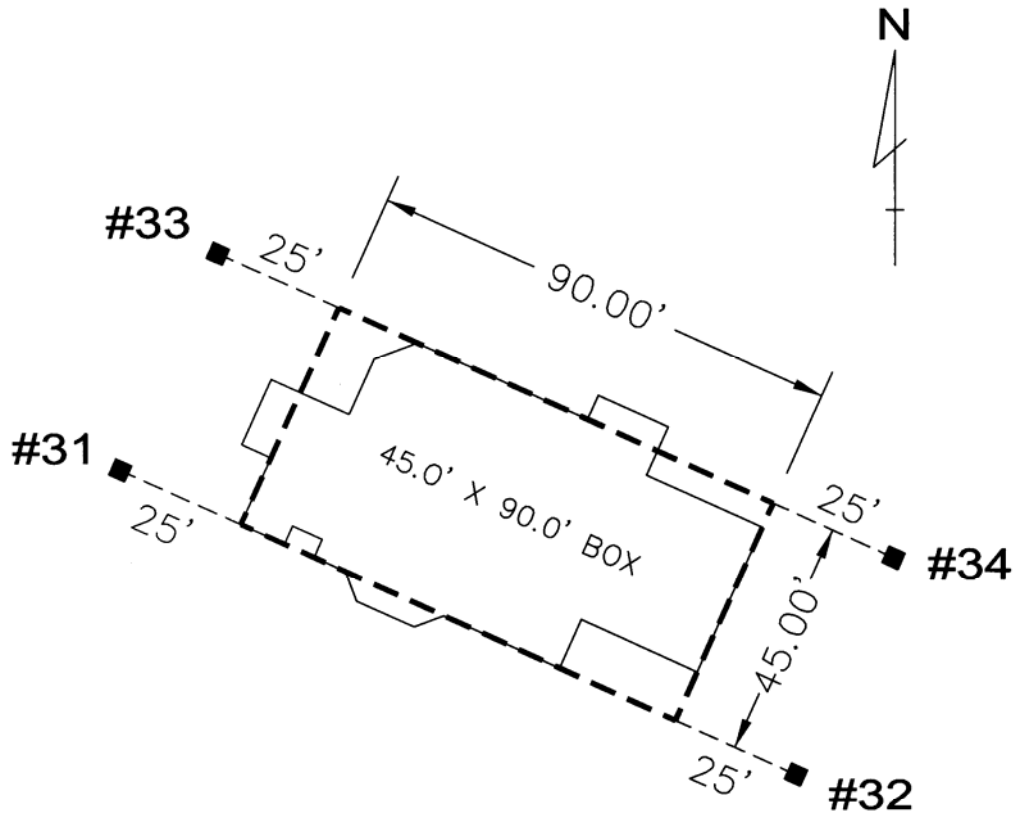

APPROX. SCALE: 1" = 20'

STAKES BASED ON MAJOR WALL LINES AT THE  
DIMENSIONS OF THE CONTROL RECTANGLE OFFSET  
AS SHOWN HEREON. IF HOUSE DIMENSIONS VARY  
FROM THIS, ADJUST ACCORDINGLY.

It's best to indicate clearly when a sketch or multiple sketches are attached, since sketches may detach from the grade sheet and the contractor not realize they are needed to clarify notations on the Grade Sheet form.

Imagine trying to perform even the simplest construction from a Grade Sheet alone. Impossible? Of course not. But, the contractor must relate the grade sheet data to physical control (stakes) set in the field, and those stakes to the completed construction. Typically, the contractor walks around, finding the stakes and marking cuts and fills to guide equipment operators. His work is much less prone to errors caused by misinterpretation of your data when you create a picture in the contractor's mind with sketches.

Remember, you are intimately acquainted with the plans and with your grade sheet data. The contractor has never seen your grade sheet before and is aided in grasping your intent when you provide a simplified sketch, even a hand-drawn, not to scale sketch, that illustrates the relationship between the grade sheet data and stakes set in the field.

For example, it's likely you've created the stationing on the sample grade sheet above for the residential driveway solely for convenience in performing your computations. That data often appears nowhere on the design plans for residential driveways unless the reviewing authority requires a profile for the proposed driveway.

On the sample Grade Sheet above, the contractor will find #156 written on one of the guard stakes. But, the stations noted on the Grade Sheet are something you created for your convenience in computing the driveway centerline, and they will be meaningless (or nearly so) to many contractors or equipment operators who walk around the wooded site trying to find and make sense of your stakes – UNLESS you provide a sketch.

The simple sketch on Sheet 2 of 2 clarifies where the stakes lie in relationship to the driveway. If you notice the stationing in the sample grade sheet, you'll see that there is considerable distance between stakes. This is because the lot is large, the proposed driveway is not close to any property line, and the contractor requested merely a rough guide to align and grade the driveway. The stationing reveals that the driveway is longer than two football fields, as it winds up a hill to the proposed house. Only eight stakes are provided on this wooded site. This is all the contractor wanted.

Can you imagine how helpful the driveway sketch is as the contractor hikes almost 100 feet in elevation through the woods to find your stakes and figure out what they mean? How difficult this would be without a sketch!

With an adequate sketch, misinterpretation and errors are minimized. Also, you'll be appreciated for making your work product easily understood. This is good business promotion.

## **Sheet \_\_\_ of \_\_\_**

Sheet numbers are important for the same reason as stated above. I always attach my sketches and label them "Page \_\_\_ of \_\_\_," so that a person looking at the first sheet showing data in a spreadsheet format (rows and columns of numbers and letters) realizes additional sheets follow and are required to complete the "Grade Sheet" package. I label these sketches "GRADE SHEET," so they are more evidently an integral part of the package comprising full data for layout control.

## **Not responsible for errors that are not reported prior to removal or destruction of evidence showing source of error.**

The sample Grade Sheet a few pages back omits an important note:

**We will not be responsible for suspected errors unless we are notified immediately upon their discovery and provided opportunity to verify and document the source of any actual error before stakes provided for the layout are disturbed or destroyed.**

It's imperative that you are called to the site the moment a suspected error in your work has been detected. Often, your work will not be the cause of the error or problem, and being called to the site while your stakes are still present and undisturbed allows you to discover the true source of the problem and show others why your staking is correct (hopefully it is!), before they go off and assume you've messed up. For some reason, contractors seem to think they can just bill you for costs to remedy whatever they believe to be your fault without any proof. Do your best to change that thinking.

This disclaimer has worked for me, and I strongly advise establishing the policy that you won't be responsible for errors if you're not advised in a timely fashion and given opportunity to confirm the source of any error to be your fault. If you're called to a site because someone thinks you've made an error, respond immediately. It can save both your reputation and your money. And, of course, be responsible for what you really do mess up. Your client may well assume that you'll deny you're at fault no matter what. Once you've owned up quickly to a problem you've caused, your credibility when you deny your fault is increased.

## **Work Orders**

### **You absolutely gotta have 'em!**

Work Orders are mentioned throughout this course, and I urge you not to underestimate how critical their use is to your success.

Remember, you're not creating extra or unnecessary paperwork with Work Orders. They perform several functions vital to your success and prosperity, such as:

- They create documentation so that you will get paid for work performed outside the scope of your contract.
- They prove you've been instructed to do certain things, especially layout that differs from design plans, on the authority of one empowered to make such decisions (You are not!!!).
- They are little mini-contracts to document understandings between you and your client.
- They're proof that you were on the site performing work on a given day. (This provides an instant, amicable solution to a billing dispute.)

- Work Orders document delays or down-time due to the site not being ready or other causes beyond your control.
- They foster good habits: Daily use of your Work Orders gets your client accustomed to the routine of signing authorizations for your work. It also makes you or your party chief used to approaching the client for a signature. This makes obtaining authorization for extra work or restaking part of a familiar exchange between you and your client. If you only pass a piece of paper to your client for a signature for extra money, the client may be wary. Instead, do it every day. You'll find that you're much more at ease "asking for money," and any natural resistance your client has to signing your Work Orders has been vastly reduced.
- Work Orders eliminate most traumas between your client's accounts payable staff and you. A Work Order signed by the superintendent provides necessary documentation to your client and authorizes you getting paid. If the accounts payable department has a beef, it's with their own superintendent, not with you. Result: you get paid! There are some loops it's better to be left out of.

## Where to Obtain? What format?

I have not seen pre-printed or standard forms that I consider suitable for the construction layout function, although some standard "contractor" forms come close. Early in business, you might get by with an initial order of some standard forms, but I suggest you order pre-numbered, triplicate, carbonless Work Order forms, tailored to your specific needs.

## TriPLICATE Forms should include spaces for:

### Task

This is a short space for a general comment like, "Stake Water Line for Blasting."

### Description

In this space, you specify the extent of your work assignment, something like, "Station 10+00 to 23+50" or "In parking areas west and north of Building #3."

### Ordered by

Place the name of the person who ordered the work in this box.

### Contract/Restake/Hourly/Extra

Have four check boxes with the above words next to them. It is critical that your field crews know how to distinguish the four billing categories of work, as discussed elsewhere in this course. (Again, your rubber stamp used in the field book pages at the start of each day provides training in this awareness.) Be sure you and your crews know what these four categories mean, what they apply to, and where one starts and another begins.

**CONTRACT** – Briefly, to summarize, you do not specifically need special authorization for set-fee, contract services; your contract has already authorized such services and determined how much compensation you will receive for these services. BUT, I always have the superintendent or contractor sign a work order anyway for two reasons. First, even though you contract authorized the work, it can be important to know *when* you were asked to do the actual work. If you stake something too early, before the site is prepared, it may need to be restaked, you're your client may not want to pay for that restaking. If you can prove you were only following the client's direction, then the fault for staking too soon is not yours. Second, it gets your client in the habit of signing without resistance. This makes getting a work order for extra work signed easier, since the superintendent of other client representative is accustomed to signing work orders each day without a fight.

**HOURLY** – Again discussed earlier, restaking is *always* performed on an hourly basis; it's impossible to predict these fees ahead of the need, and fees for restaking vary widely from site to site, because considerably more destruction of your initial staking happens on one site than on another. Hourly work is authorized in your contract (if you've constructed your proposal carefully), yet may not be paid for if not performed under the signature (thus, authorization) of the client's representative in the field.

Hourly work is essentially Contract work, the scope or intensity of which is impossible to predict ahead of time. It is thus distinguished from set-fee work often called, "Contract" work.

In your proposal, it is good to keep Hourly work to a minimum. If, for example, you're staking a large corporate headquarters on a site with many acres of land used for paved walking paths, there is no way to tell if these will be located by the contractor or by you, or some joint effort of both. This item can be listed in your proposal as, Stake Walking Paths – Standard Hourly Fees if Requested. Or, as noted earlier, you may wish to just be silent on this item to avoid losing at the Apples and Oranges game.

**RETAKE** – Your client may grumble about authorizing restaking, but smile and agree that it's really too bad the stakes got knocked out. Remember, you never stake twice and get paid just once unless you're correcting a mistake you made in the first layout. May this happen rarely.

**EXTRA** – Oh boy! Check this box only when you can't find any other box that works. It is hard to get Extra Work authorized. Your client may have a hard time getting paid by the owner, and you may have a hard time getting it out of your client. It's a bad word to the construction manager, so be prepared. Be absolutely certain you know it's outside of your contract scope and that it's neither restaking nor hourly. Then, and only then, check the EXTRA box on your work order and talk about the weather while its being signed.

But, sometimes, the construction manager's own contract with their client causes some activity to be designated an "Extra." This is a time when your client probably wants you to call your work an Extra, so they can collect your fees from their client.

**Per Plans Dated** \_\_\_/\_\_\_/\_\_\_; **Revised** \_\_\_/\_\_\_/\_\_\_

The time to make these entries on a Work Order prior to having it signed is time well spent. You must be certain that the copy you leave with the superintendent or contractor shows this data. **THIS IS CRITICAL!** By now, you know why I'm saying it yet another time. If you stake from outdated plans, let someone else be responsible!

### **This Work Order authorizes work differing from the plans.**

Train your field staff to make this hand-written note whenever it applies. If they (or you) are directed to stake something different than the plans you've been officially given, be absolutely certain someone in authority authorizes that activity in writing – and that they have the authority to do so. Drill into your crews that they have no authority to stake anything contrary to plans, ever, without written authorization from somebody important. If such work is requested, be absolutely certain to note this on the Work Order before you getting it signed, so the copy you leave with the person requesting the deviation has their own instructions in writing and put their signature to it.

### **White – Always kept. PINK – first to go.**

Assuming your first (top) copy is white, your second is yellow and your third is pink, **KEEP YOUR WHITE COPY** after it's been signed, and give your 3<sup>rd</sup> (PINK?) copy to the client's representative who authorized you to do the work by his or her signature.

### **Yellow – kept with billing copies**

This second copy is presumably more legible than the third copy. Don't let your field personnel get away with NOT pressing hard enough with a ball-point pen to make a legible third (PINK) copy! Anyway, I send the second (YELLOW?) copy with my monthly billing if the box checked is Restake, Hourly or Extra.

If the work assignment on a Work Order will be billed as a Contract item, I don't usually send such Work Orders with my billing. The reason is, I want the person authorizing payment to know that the Work Orders I do send require their attention. Contract work is billed on percentage of completion, and whether or not it was authorized is almost never questioned. If it ever is questioned, I have a Work Order for it and will supply a copy to the accounts payable department.

I note on my billing statements Work Order numbers for each item or occurrence of non-contract items billed. I make a clear cross reference between my billing for all Hourly, Extra and Restake fees and my Work Orders' authorizations for work performed. I want my billing and specific authorizations to arrive at accounts payable together, to avoid delays in me getting paid. When the accounts payable folks have to pass my billing to the project manager, who passes it to the superintendent for confirmation, who forgets to do it, I don't get paid quickly. And, I spend time chasing payment for work already performed, when I could be generating more income from new instead.



## Format of Work Orders

What format is best for your Work Orders? Design your own.

Begin your design based on a standard format similar to work order forms you find at major office supply stores or from an Internet supplier like NEBS. A basic, generic format may be viewed at: [http://www.nebs.com/NASApp/nebsEcat/products/product\\_detail.jsp?pc=6558#](http://www.nebs.com/NASApp/nebsEcat/products/product_detail.jsp?pc=6558#)

Study standard forms and begin to sketch one that works for you, remembering the points above. It really isn't that difficult. Then get a local printer or an Internet provider to make them for you. It will be worth the cost.

## Aluminum Thing

You just gotta have an aluminum thing. They're often called portable desks, and one version may be seen on the right side of the web page using the above link. Some models hinge at the top and others on the side. Some are great to use on your lap, and others are not. Some provide better protection against the wind taking away your completed work orders that are stored in the device.

These provide a means to keep your blank and signed work orders together and safe from loss. The surface has a clip to hold the current work order or other paper and makes handing your work order to your client for signature convenient, even when standing out on a site.

The device is also handy for keeping a few blank Conversation Logs at the ready. Again train yourself and your crews to fill these out faithfully whenever direction or important information is transmitted verbally.

I recommend keeping a few sheets of graph paper (or sheets from a computation pad) in there, too, plus an extra stick pen and pencil.

Be sure to keep a copy of your contract in there for ready and easy reference. Contract questions often come up when you are trying to get a work order signed, and you want to have your contract at the ready. If you leave the superintendent's trailer to go get a contract out of your survey vehicle, you can be sure that superintendent has occupied himself with another person or phone call, and you'll have a wait on your hands.

File folders cut to make 8 ½ by 11 inch sheets make excellent separators between your Contract, Work Orders, Conversation Logs and graph paper.

Sound like this thing is stuffed to the full? A few blank Work Orders are enough to have in the aluminum portable desk, leaving plenty of room for a few conversation logs and sheets of graph paper. The device itself doubles as a clip board, so any letter size sheets can be clipped onto it. Stores of blank forms should be kept in each survey vehicle and refreshed at the beginning of each week. During the week the aluminum thing can be refilled as needed from this supply.

The aluminum device also comes in a smaller than letter-size, made specifically to hold Work Orders. Because of the multiple-use of the item, I recommend getting a letter size unit, even for use with smaller work order forms.

Finally, I recently saw a plastic version of the aluminum thing. Pick the size and the material it's made of, but do get one. You'll love it!

## The TEAM

Construction Layout is fun! It's a dynamic, ever changing environment full of challenge and learning. The folks on the construction site are generally competent, hard working and practical. They don't have time to ponder grand theories, although they are generally open to a better idea, one that makes their work go more easily and more efficiently. I find this refreshing and fun.

One thing that turns any enjoyable work into an unpleasant chore and increases liability exposure is a poor attitude in a member of the team. Construction layout requires sharp thinking and alertness. Everyone has to be thinking about the task at hand and yet maintaining a mental/emotional peacefulness that's capable of discerning that little voice inside that warns, "Wait a minute here. I'm not sure this is correct."

A lazy or contentious person is a drag to be around under any circumstance, but it's particularly dangerous to share construction layout responsibilities with such a person. There can't be too many eyes and ears on the construction layout crew. The nature of the work requires this, and lives can even depend on it. Things do go wrong on a construction site, and occasionally people do get killed. An alert yet peaceful person is valuable in preventing costly mistakes and may even prevent serious injury or death.

A person who is raging inside or who is hating their work makes a lot of internal noise. Such people are not sensitive to the changes around them; they are not attentive to what other people on the team are thinking and doing; they are making so much mental noise, and they're so preoccupied with their own issues that they can miss critical signals and thwart the function of intuition.

The team is very, very important and should be chosen wisely. No winning team allows a member to goof off, be foolish or act inappropriately without accountability.

Construction layout is sometimes viewed by surveyors as "less professional" than land surveying of boundaries. I've done both and simply can't agree with that opinion. In fact, my experience says that it is easier to perform conventional land surveying than to be truly successful at construction layout. At least, it is easier when performing boundary surveying to find enough help to "get the job done." The dynamics and demands of construction layout deserve a team, not just a group of workers, and often one qualified person can perform boundary surveying.

While the advent of robotic instruments and GPS has facilitated both realms (traditional surveying and construction layout, it is my opinion that construction layout remains the more demanding activity. Clients will tell you how hard it is to find truly qualified people to perform their construction layout. Do well at this and you'll stand out from the competition.

## The Satisfaction of a Job Well Done

And, that's what this course has been about:

- developing a broad overview of the dynamics and processes of construction layout,
- encouraging participation on the Team – a team is made up of skilled, talented and diverse people. Together, things get done, and that's fun!
- generating even a little excitement over the opportunity to serve in the building of a nation – That's what you're doing, folks; may as well admit it.
- bringing together specialized skill, knowledge of the role it plays, managing the processes and records involved, dealing successfully with those who pay you to do what you do best,
- making sound judgments about what precision is needed and being free to let what is needed be good enough, and
- knowing when to split hairs and get every bit of precision possible, and having the talent and skills to do just that!

I love the construction layout business and activity, the ever changing environment, the down-to-earth people on the site, the opportunity to work in a team of experts in their field and to function as an expert in my own profession. I enjoy learning. In construction layout, that never ceases. It's been fun to record for your benefit some of the things I've learned, and my sincere hope is that you've found this course enjoyable and beneficial. Any feedback on this course work will be gratefully received and thoughtfully considered for future refinement of this material.

Thank you for making the time to take this course.

--- END ---