



PDHonline Course M284 (5 PDH)

Kitchen Makeup Air

Instructor: Steven G. Liescheidt, P.E., CCS, CCPR

2020

PDH Online | PDH Center

5272 Meadow Estates Drive
Fairfax, VA 22030-6658
Phone: 703-988-0088
www.PDHonline.com

An Approved Continuing Education Provider



**CALIFORNIA
ENERGY
COMMISSION**

**MAKEUP AIR EFFECTS ON
COMMERCIAL KITCHEN EXHAUST
SYSTEM PERFORMANCE**

CONSULTANT REPORT

DECEMBER 2002
P500-03-007F



CALIFORNIA ENERGY COMMISSION

Prepared By:

Grant Brohard,
Pacific Gas & Electric Company

Richard Swierczyna, Paul Sobiski, and
Vernon Smith, P.E.
Architectural Energy Corporation

Donald Fisher, P.Eng.
Fisher-Nickel, inc.

Contract No. 500-98-031

Prepared For:

Donald Aumann, P.E.,
Contract Manager

Nancy Jenkins, P.E.,
PIER Program Area Lead

Terry Surles,
PIER Program Manager

Robert L. Therkelsen,
Executive Director

LEGAL NOTICE

This report was prepared as a result of work sponsored by the California Energy Commission (Commission). It does not necessarily represent the views of the Commission, its employees, or the State of California. The Commission, the State of California, its employees, contractors, and subcontractors make no warranty, express or implied, and assume no legal liability for the information in this report; nor does any party represent that the use of this information will not infringe upon privately owned rights. This report has not been approved or disapproved by the Commission nor has the Commission passed upon the accuracy or adequacy of this information in this report.

This report was prepared by Pacific Gas and Electric Company. Neither Pacific Gas and Electric Company nor any of its employees and agents:

- (1) Makes any written or oral warranty, expressed or implied, including, but not limited to those concerning merchantability or fitness for a particular purpose;
- (2) Assumes any legal liability or responsibility for the accuracy, completeness, or usefulness of any information, apparatus, product, process, method, or policy contained herein; or
- (3) Represents that its use would not infringe any privately owned rights, including, but not limited to, patents, trademarks, or copyrights.

Acknowledgments

The authors acknowledge the many people who helped with the planning and completion of this research project. The enthusiasm of our industry colleagues toward this commercial kitchen ventilation (CKV) study was remarkable, while manufacturers' contribution of appliances and hoods for testing was vital to its outcome. We found ongoing support from the kitchen ventilation industry as we updated interested parties at professional meetings and forums, participated in ASHRAE seminars, provided tours of the CKV lab and demonstrations of our findings, or presented formal updates at the Food Service Technology Center Advisory Board or California Energy Commission meetings.

Risking oversight, we extend appreciation to Captive Aire Systems, Exhausto Inc., Greenheck Fan Corporation, Halton Company, Vucan-Hart Corporation and McDonald's Corporation for supplying test equipment. A thank you is owed Tim Cole, Gas Technology Institute, for handing down valuable instrumentation when he decommissioned a recognized CKV research facility in Cleveland. With respect to the suggestions and contributions of individuals, we have not even attempted to compile an inclusive list. Please know that if you offered advice, it was appreciated.

Multi-year financial support from the California Energy Commission (CEC) was imperative for a study of this magnitude, while the understanding of the research and its benefits by Don Aumann, CEC Project Manager, was a key factor in its success. It is essential to acknowledge the Electric Power Research Institute (EPRI) as one of the original proponents for the study. The project would not have been viable without the significant investment that EPRI made in the CKV test facility and protocols from 1993 to 1999, especially in the focusing schlieren flow visualization system.

The establishment of a Food Service Technology Center reflects Pacific Gas and Electric Company's commitment to the food service industry. The goal of the research program is to provide Pacific Gas and Electric Company's customers and the California food service industry with information to help them improve the performance and energy efficiency of CKV systems by performing flow-visualization research and publishing design guidelines for the food service community. Pacific Gas and Electric Company's Food Service Technology Center is supported by its National Advisory Board, which includes:

Advantica Restaurant Group, Charles Rutherford, Manager Restaurant Equipment Engineering
Applebee's International, Inc., Ray Bond, Director of Facilities Management
California Energy Commission (CEC), Michael Martin, Codes and Standards Director
California Restaurant Association (CRA), Jot Condie, Director of Government Affairs
Carl Karcher Enterprises, Inc., James Yeung, Equipment Manager
D.J. Horton and Associates, Inc., Doug Horton, Food Service Consultant
Enbridge Consumers Gas, Boris Mladjen, Program Manager, Technology Applications
Gas Technology Institute (GTI), Tim Cole
Harvest Restaurant Consulting, Tim Bohan, Consultant
International Facility Management Association (IFMA), Charles Claar, Director
Lawrence Berkeley National Laboratory, Jeff Harris
McDonald's Corporation, Anthony Spata, Director, Building Systems and Facility Design
National Restaurant Association (NRA), Steven Grover, Vice President Technical Services
Safeway, Inc., Mike Flanagan, Purchasing Agent, Corporate Construction & Design
Southern California Edison, Carlos Haiad, Project Engineer
U.S. Environmental Protection Agency, Rachel Schmeltz, Energy Star Program Manager

Underwriters Laboratories (UL), Dan Restelli
University of California, Berkeley, Nancy Hudson, Program Director, Dietetics
University of California, Riverside (CE-CERT), William Welch, Principal Development Engineer

Table of Contents

Section	Page
Preface.....	xv
Executive Summary	1
Abstract.....	9
1.0 Introduction and Background	11
1.1 Project Objectives	13
1.2 Report Organization.....	15
2.0 Experimental Design.....	16
2.1 Airflow Visualization	16
2.2 Hood/Appliance Relationships.....	18
2.3 Appliances	25
2.4 Griddle Idle and Cooking Conditions	26
2.5 Charbroiler Idle and Cooking Conditions.....	28
2.6 Cross Draft Generation	28
2.7 MUA Strategies	28
2.7.1 Displacement.....	28
2.7.2 Air Curtain Diffusers	29
2.7.3 Face Diffusers.....	29
2.7.4 Ceiling 4-Way Diffusers	29
2.7.5 Short Circuit	29
2.7.6 Backwall supply.....	29
3.0 Methodology.....	30
3.1 Capture & Containment Testing.....	30
3.2 Exhaust Air Flow to Supply Air Flow Comparison.....	31
4.0 Discussion.....	32
4.1 Displacement Diffusers	32
4.1.1 Test Setup	33
4.1.2 Findings for Charbroilers	39

4.1.3	Findings for Griddles.....	41
4.2	Air Curtain Supply	44
4.2.1	Test Setup	44
4.2.2	Findings for Charbroilers	47
4.2.3	Findings for Griddles.....	49
4.2.4	Air Curtain Sensitivity Analysis.....	51
4.3	Front Face Supply	53
4.3.1	Test Setup	54
4.3.2	Findings for Charbroilers	57
4.3.3	Findings for Griddles.....	59
4.3.4	Front Face Plenum Internal Design Sensitivity Analysis.....	61
4.4	Four-Way Ceiling Diffusers.....	68
4.4.1	Test Setup	68
4.4.2	Findings for Charbroilers	79
4.4.3	Findings for Griddles.....	82
4.4.4	Analysis of Diffuser Air Velocity Effects at Hood Lower Edge.....	85
4.4.5	Analysis of Diffuser Effect on Appliance Duty.....	88
4.5	Short Circuit Supply	90
4.5.1	Test Setup	90
4.5.2	Analysis of Findings.....	94
4.6	Backwall Supply.....	97
4.6.1	Canopy Hood Test Setup	98
4.6.2	Proximity Hood Test Setup.....	101
4.6.3	Findings for Charbroilers	105
4.6.4	Findings for Griddles.....	109
5.0	Outcomes.....	113
5.1	Outcomes Specific to MUA Strategy.....	113
5.1.1	Displacement Ventilation (Base Case).....	113
5.1.2	Air Curtain	114

5.1.3	Short Circuit	114
5.1.4	Front Face	115
5.1.5	Four Way Ceiling Diffuser	115
5.1.6	Backwall Supply	116
5.1.7	Summary: Influence of MUA Strategy on C&C Exhaust Rate.....	116
5.2	Outcomes Specific to Hood Design.....	117
5.2.1	Hood Style	117
5.2.2	Side Panels.....	117
5.3	Outcomes Specific to Room Conditions	118
5.4	Outcomes Specific to Appliances.....	118
6.0	Conclusions and Recommendations.....	119
6.1	General Conclusions.....	119
6.2	Benefits to California	120
6.3	Recommendations.....	120
6.3.1	MUA Strategies.....	121
6.3.2	Temperature Effects	122
6.3.3	Energy Balance (Heat Gain) Protocol	122
6.3.4	Computational Fluid Dynamics (CFD)	122
6.3.5	Test Method Development.....	123
7.0	References.....	124
8.0	Glossary	125
	Attachment 1: Design Guide - Improving Commercial Kitchen Ventilation System Performance	126

Appendices

- Appendix I Summary of Data
- Appendix II Laboratory Description

List of Figures

Figure	Page
Figure 1: Summary of Exhaust-to-MUA Trends.....	5
Figure 2: Cross-Section of Wall-Mounted Canopy Hood with Short-Circuit MUA Theoretically Working Properly.....	12
Figure 3: Cross-Section of Wall-Mounted Canopy Hood with Short-Circuit MUA Actually Causing Spillage	12
Figure 4: Naked Eye and Schlieren Optical System Views of an Open Range Top with Burners on, under Canopy Hood.....	17
Figure 5: Plan View of Flow Visualization Equipment Setup.....	18
Figure 6: Two Griddles Under an 8' Exhaust Hood with Transparent 1/4 Side Panels	19
Figure 7: Two Gas Charbroilers under an 8' Hood Canopy Hood with Attached MUA Plenum with Front Face Supply.....	20
Figure 8: Side View of an 8' MUA Hood with Air Curtain Supply.....	21
Figure 9: Two Gas Griddles under an 8' Exhaust Only Canopy Hood	22
Figure 10: Cooking Test of Two Gas Charbroilers under a Wall Mounted Short Circuit Canopy Hood.....	23
Figure 11: Two Gas Charbroilers under an 86-in Long Proximity (Backshelf) Hood with Transparent Partial Side Panels.....	24
Figure 12: Side View of Two Gas Charbroilers under an 86-in Wide Proximity (Backshelf) Hood with Transparent Partial Side Panels.....	25
Figure 13: Cooking Simulator Setup: Pipes with Small Holes Dispense Timed Jets of Tap Water onto the Cooking Surface	27
Figure 14: Two Gas Griddles under a Canopy Hood with the Cooking Simulator Installed	27
Figure 15: Floor Mounted Displacement Ventilators as Used for the Baseline Replacement Air Case	33
Figure 16: Cross-Section Drawing of the Exhaust Only Canopy Hood.....	34
Figure 17: Test Set-Up of the Exhaust Only Canopy Hood and Two Gas Griddles as Viewed from the Schlieren Optical Box.....	34
Figure 18: Schlieren View of Exhaust Only Canopy Hood and Two Griddles Simulated Cooking at 2525 CFM Exhaust Flow Rate Showing C&C	35
Figure 19: Schlieren View of Exhaust Only Canopy Hood and Two Griddles Simulated Cooking at 1850 CFM Exhaust Flow Rate Showing Spillage	35
Figure 20: Cross-Section Drawing of Proximity Hood	36

Figure 21: Test Set-Up of the Proximity Hood and Two Gas Griddles as Viewed from the Schlieren Optical Box.....	37
Figure 22: Schlieren View of a Proximity Hood and Two Charbroilers Simulated Cooking at 1250 CFM Exhaust Flow Rate Showing C&C.....	38
Figure 23: Schlieren View of a Proximity Hood and Two Charbroilers with Simulated Cooking at 1050 CFM Exhaust Flow Rate Showing Spillage	38
Figure 24: Exhaust C&C Flow Rates for Two Charbroilers during Idle Conditions and Replacement Air from Displacement Units.....	39
Figure 25: Exhaust C&C Flow Rates for Two Charbroilers during Cooking Conditions and Replacement Air from Displacement Units.....	40
Figure 26: Exhaust C&C Flow Rates for Two Griddles during Idle Conditions and Replacement Air from Displacement Units.....	41
Figure 27: Exhaust C&C Flow Rates for Two Griddles During Cooking Conditions and Replacement Air from Displacement Units.....	43
Figure 28: Cross-Section Drawing of the Wall Mounted Air Curtain Canopy Hood.....	45
Figure 29: View of Two Charbroilers under a Wall Mounted Air Curtain Canopy Hood from the Perspective of the Schlieren System.....	45
Figure 30: Schlieren Image of a Wall Mounted Air Curtain Canopy Hood with Two Broilers Simulating Cooking Showing C&C at an Exhaust Rate of 4100 cfm with 250 cfm (6 percent) MUA Through the Air Curtain Supply	46
Figure 31: Schlieren Image of Wall Mounted Air Curtain Canopy Hood Showing Spillage at 4100 cfm Exhaust with 1200 cfm (29 percent) Air Curtain Supply over Two Broilers with Simulated Cooking.....	46
Figure 32: Side Panel Comparison of Two Charbroilers Idling under an Air Curtain Canopy Hood.....	47
Figure 33: Side Panel Comparison of Two Charbroilers Cooking under an Air Curtain Canopy Hood.....	48
Figure 34: Side Panel Comparison of Two Griddles Idling under an Air Curtain Canopy Hood.....	49
Figure 35: Side Panel Comparison of Two Griddles Cooking under an Air Curtain Canopy Hood.....	50
Figure 36: Summary of Successful Air Curtain MUA Percentage for Two Griddles Cooking under an Air Curtain Canopy Hood	51
Figure 37: The Amount of Exhaust Air Required as a Function of the Amount of Air Brought in Through the Air Curtain Supply	52
Figure 38: Cross-Section Drawing of Front Face Plenum and Canopy Hood	54

Figure 39: Test Set-Up of the Front Face Supply Hood and Two Gas Charbroilers as Viewed from the Schlieren Optical Box.....	55
Figure 40: Schlieren View of C&C of the Thermal Plume from Two Charbroilers Idling at 3600 CFM Exhaust and 300 CFM Front Face Airflow Rates	56
Figure 41: Schlieren View of Spillage of the Thermal Plume from Two Charbroilers Idling at 3600 CFM Exhaust and 1200 CFM Front Face Airflow Rates	56
Figure 42: Exhaust and Front Face Flow Rates for the Two Charbroilers during Idle Conditions	57
Figure 43: Exhaust and Front Face Flow Rates for the Two Charbroilers during Cooking Conditions	58
Figure 44: Exhaust and Front Face Flow Rates for the Two Griddles during Idle Conditions.....	59
Figure 45: Exhaust and Front Face Flow Rates for the Two Griddles during Cooking Conditions	60
Figure 46: Detail Cross Section of Front Face Supply – Original and Modified Designs.....	62
Figure 47: Air Speed in Feet per Minute as Discharged from the Front Face Plenum at an Airflow of 1800 CFM.....	63
Figure 48: Exhaust and Front Face Airflow Rates as Front Face Airflow Rates were Increased as Percentages of the Original Displacement Ventilation Rate	64
Figure 49: The Amount of Exhaust Air Required as a Function of the Amount of Air Brought in Through the Front Face Supply Plenum.....	65
Figure 50: Air Speed in Feet per Minute as Discharged from the Modified Front Face Plenum at an Airflow of 1800 CFM	66
Figure 51: Exhaust and Front Face Airflow Rates as Front Face Airflow Rates were Increased as Percentages of the Original Displacement Ventilation Rate with Modified Supply Plenum.....	66
Figure 52: The Amount of Exhaust Air Required as a Function of the Amount of Air Brought in Through the Front Face Supply as Tested with the Modified Supply Plenum.....	67
Figure 53: Cross-Section Drawing of the Exhaust Only Canopy Hood.....	68
Figure 54: Test Set-Up for Exhaust Only Canopy Hood and Locations of the Four-Way Ceiling Diffusers.....	69
Figure 55: Test Set-Up for Exhaust Only Canopy Hood and Two Gas Griddles as Viewed from the Schlieren Optical System	70
Figure 56: Schlieren View of C&C of Exhaust Only Canopy Hood and Two Griddles Simulated Cooking at 2525 CFM Exhaust and 1000 CFM Front Center 4-Way Diffuser Airflow Rates	71
Figure 57: Schlieren View of Spillage from Exhaust Only Canopy Hood with Two Griddles Simulated Cooking at 1850 CFM Exhaust and 1400 CFM Front Center 4-Way Diffuser Airflow Rate	71

Figure 58: Cross-Section Drawing of Proximity Hood	72
Figure 59: Test Set-Up for Proximity Hood and Two Gas Griddles as Viewed from the Schlieren Optical Box	73
Figure 60: Schlieren View of a Proximity Hood and Two Charbroilers with Simulated Cooking at 1250 CFM Exhaust and 425 CFM Front Center 4-Way Diffuser Airflow Rates Showing C&C	74
Figure 61: Schlieren View of a Proximity Hood and Two Charbroilers with Simulated Cooking at 1250 CFM Exhaust and 1000 CFM Front Center 4-Way Diffuser Airflow Rates Showing Spillage.....	75
Figure 62: Four-Way Ceiling Diffuser and Proximity Hood Locations-Plan View	76
Figure 63: Four-Way Ceiling Diffuser Locations and Velocities at 1000 cfm Diffuser Flow Rates-Plan View.....	77
Figure 64: Exhaust Flow Rates for an Exhaust Only Canopy Hood and 2 Charbroilers Idling with Displacement Ventilation Compared to Three Different Ceiling Diffuser Locations ...	78
Figure 65: Exhaust Flow Rates for the Two Charbroilers During Idle Conditions Under Canopy and Proximity Hoods for Displacement and 1000 cfm through the Center Front 4-Way Diffuser	79
Figure 66: Exhaust Flow Rates for the Two Charbroilers During Cooking Conditions Under Canopy and Proximity Hoods for Displacement and 1000 cfm through the Center Front 4-Way Diffuser	80
Figure 67: Exhaust Flow Rates for the Two Griddles During Idle Conditions Under Canopy and Proximity Hoods for Displacement and 1000 cfm through the Center Front 4-Way Diffuser	82
Figure 68: Exhaust Flow Rates for the Two Griddles During Cooking Conditions Under Canopy and Proximity Hoods for Displacement and 1000 cfm through the Center Front 4-Way Diffuser	83
Figure 69: Detail Cross Section of 4-Way Ceiling Diffuser.....	85
Figure 70: Velocity Profiles along the Front Lower Edge of the Canopy Hood for 4-Way Diffuser Flow Rates Between 100 and 1400 cfm.....	86
Figure 71: The Amount of Exhaust Air Required as a Function of the Amount of Air Brought in Through the Front Center 4-Way Diffuser for Two Griddles and Two Charbroilers Idling Under a Canopy Hood	88
Figure 72: Cross-Section Drawing of Wall Mounted Short Circuit Canopy Hood.....	91
Figure 73: View of Two Charbroilers under a Wall Mounted Short Circuit Canopy Hood from the Perspective of the Schlieren Flow Visualization System.....	92
Figure 74: Schlieren Image of C&C for Two Charbroilers Idling under a Wall Mounted Short Circuit Canopy Hood Exhausting 3500 cfm with 600 cfm (17 percent) Internal MUA.....	93

Figure 75: Schlieren Image of Wall Mounted Short Circuit Canopy Hood with Two Charbroilers Idling, Showing Spillage at 3375 cfm Total Exhaust and 2100 cfm (62 percent) Internal MUA	93
Figure 76: Summary of Successful Short Circuit Air Percentage for a Short Circuit Canopy Hood	94
Figure 77: Summary of Successful MUA Quantity for a Short Circuit Canopy Hood.....	95
Figure 78: The Amount of Exhaust Air Required as a Function of the Amount of Internal MUA Brought into a Short Circuited MUA Hood	96
Figure 79: Cross-Sectional Drawing of the Wall Mounted Backwall Supply Canopy Hood	98
Figure 80: View of Two Charbroilers under a Wall Mounted Backwall Supplied Canopy Hood from the Perspective of the Schlieren Visualization System.....	99
Figure 81: Schlieren Image of C&C with Two Charbroilers Idling under a Wall Mounted Canopy Hood Exhausting 3600 cfm with Displacement-Only MUA.....	100
Figure 82: Schlieren Image of C&C with Two Charbroilers Idling under a Wall Mounted Canopy Hood Exhausting 2950 cfm with 2000 cfm MUA from Backwall Supply	101
Figure 83: Cross-Sectional Drawing of the Wall Mounted Backwall Supply Proximity Hood ..	102
Figure 84: View of Two Griddles under a Backwall Supply Proximity Hood from the Perspective of the Schlieren Visualization System	103
Figure 85: Schlieren Image of C&C with Two Griddles Idling under the Proximity Hood Exhausting 1250 cfm with 325 cfm MUA from the Backwall Supply.....	104
Figure 86: Schlieren Image of Spillage from the Proximity Hood Exhausting 1250 cfm with Two Griddles Idling with 940 cfm MUA from the Backwall Supply	104
Figure 87 : MUA Comparison of Two Charbroilers Idling Under Backwall Supply Hoods	106
Figure 88: MUA Comparison of Two Charbroilers Cooking under Backwall Supply Hoods....	107
Figure 89: MUA Comparison of Two Griddles Idling under Backwall Supply Hoods.....	109
Figure 90: MUA Comparison of Two Griddles Cooking under Backwall Supply Hoods	111
Figure 91: The Amount of Exhaust Air Required as a Function of the Amount of Air Brought in Through the Backwall Supply Plenum	112
Figure 92: Summary of Exhaust to MUA Airflow Rate Trends.....	117

List of Tables

Table	Page
Table 1: Testing Matrix – Wall-Mounted Canopy Hood	13
Table 2: Testing Matrix – Island-Mounted Canopy Hood.....	14
Table 3: Typical Flow and Throw Data for a 15 inch by 15 inch 4-Way Diffuser.....	85

Preface

The Public Interest Energy Research (PIER) Program supports public interest energy research and development that will help improve the quality of life in California by bringing environmentally safe, affordable, and reliable energy services and products to the marketplace.

The PIER Program, managed by the California Energy Commission (Commission), annually awards up to \$62 million to conduct the most promising public interest energy research by partnering with Research, Development, and Demonstration (RD&D) organizations, including individuals, businesses, utilities, and public or private research institutions.

PIER funding efforts are focused on the following six RD&D program areas:

- Buildings End-Use Energy Efficiency
- Industrial/Agricultural/Water End-Use Energy Efficiency
- Renewable Energy
- Environmentally-Preferred Advanced Generation
- Energy-Related Environmental Research
- Energy Systems Integration

What follows is the final report for the Makeup Air Effects on Commercial Kitchen Exhaust System Performance Research Project, CEC Contract # 500-98-031, conducted by Pacific Gas & Electric Company and its subcontractors Architectural Energy Corporation and Fisher-Nickel, Inc. The report is entitled *Makeup Air Effects on Commercial Kitchen Exhaust System Performance*. This project contributes to the Buildings End-Use Energy Efficiency Program.

For more information on the PIER Program, please visit the Commission's Web site at: <http://www.energy.ca.gov/research/index.html> or contact the Commission's Publications Unit at 916-654-5200.

Executive Summary

A universal concern regarding the commercial kitchen space is having an effective ventilation system. A large portion of kitchen ventilation planning is dedicated to properly exhausting cooking effluent. Appliance layout and the energy input are evaluated, hoods are located and specified, the ductwork size and routing are determined, and exhaust fans are specified to remove the proper volume of air. Unfortunately, much less time is usually dedicated to planning how the exhausted volume of air will be replaced, although an air balance schedule is commonly used to indicate the source and quantity of the makeup air (MUA).

Overlooking the details of the MUA delivery system can have a negative impact on the performance of an otherwise well-designed kitchen. Cross drafts and high air velocities due to improper introduction of the MUA can result in a failure of the hood to capture and contain effluent from the appliances. This effluent spillage may include convective heat, products of natural gas combustion (carbon dioxide, water and potentially carbon monoxide), and products from the cooking process, such as grease vapor and particles, odors, water vapor, and miscellaneous hydrocarbon gasses. The overall commercial kitchen ventilation issues include indoor air quality, fire prevention, safety, employee comfort, and equipment first costs, energy operating costs and maintenance costs. These costs often compete with the ventilation issues for foodservice industry and operator attention.

Energy efficiency is often a minimal concern to the design team. However, the energy efficiency of commercial kitchens is directly related to the exhaust ventilation system. It has been shown that the HVAC load in a restaurant represents approximately 30 percent of its total energy consumption. Depending on facility layout, the kitchen ventilation system can account for up to 75 percent of the HVAC load (including fan energy) and represents one of the largest energy-consuming end use within a commercial food service facility.

These problems exist in part due to a lack of comprehensive design information for commercial kitchen ventilation (CKV) systems. Although the ASHRAE Handbooks are recognized as a fundamental source for information on designing HVAC systems, the Handbooks did not have a chapter devoted to ventilating commercial cooking equipment prior to the 1995 edition. Even the 1999 edition is lacking information on the introduction of MUA and the effect that a MUA strategy may have on hood performance and energy consumption of the system. Thus an HVAC engineer without extensive knowledge of CKV research might specify exhaust ventilation rates based on the more prescriptive code criteria. The research described in this report provides some answers to these issues, but it also reveals that kitchen ventilation is a very complex subject and that additional investigation will be needed to strengthen comprehensive design guidelines.

Objectives

The objective of this research project was to improve the performance and energy efficiency of CKV systems by performing flow-visualization research and publishing design guidelines for the food service community. This R&D project focused on how the introduction of replacement (makeup) air affects the C&C performance and energy use of CKV systems.

Approach

To address the MUA effect issues, this research project focused on how the introduction of replacement (makeup) air affects the capture and containment (C&C) performance of commercial food service ventilation equipment. A total of 214 distinct sets of test conditions were investigated, involving combinations of hoods, appliances, cooking conditions, MUA strategies, and other factors. The capture and containment evaluations were performed according to ASTM Standard F1704-99, *Standard Test Method for Performance of Commercial Kitchen Ventilation Systems*. Focusing schlieren and shadowgraph systems, which visualize the refraction of light due to air density changes, were the primary tools used for airflow visualization.

Three hood types were tested: (1) Wall Mounted Canopy, (2) Island Mounted Canopy, and (3) Proximity (Backshelf). Charbroilers and griddles, representing heavy duty and medium duty appliances respectively, were tested. Idle and emulated cooking conditions were tested. The influence of air mass disturbances (drafts) and tapered side panels was also investigated.

The MUA strategies included (1) Displacement Ventilation (base case), (2) Ceiling Diffuser, (3) Front Face Diffuser, (4) Air Curtain Diffuser, (5) Backwall Supply, and (6) Short-Circuit Supply. Certain features of the hoods and local makeup air devices were modified to represent designs and configurations found in commercial kitchen installations, but not necessarily the best or worst designs or configurations.

To determine how the MUA strategy affected the exhaust hood's ability to fully capture and containment (C&C), the research team tested the following hypothesis:

If the MUA strategy were to have no effect on exhaust hood performance (i.e., equivalent to the displacement ventilation base-case condition), then it would be possible to replace 100 percent of the air exhausted through the makeup air configuration being investigated, while maintaining C&C.

For most cases, the hood exhaust rate was held constant at the displacement ventilation case C&C threshold while gradually increasing the local MUA supply flow (and decreasing MUA flow from the displacement diffusers) until spillage of effluent was observed.

Results for specific MUA strategies, hood styles, cross drafts, side panels, recommendations for future research, and general conclusions, including limitations of the study, are discussed in separate sections below.

Outcomes Specific to MUA Strategy

The results for the baseline case, displacement ventilation, are discussed first and then each MUA strategy in turn from the most intrusive to the least intrusive.

Displacement Ventilation (Base Case)

Displacement ventilation was the baseline for the study because it provides a uniform, nearly laminar bulk airflow. From the project team's past testing experience, low-velocity bulk supply attains C&C with the lowest exhaust flow rate. It also allowed parameters other than locally

distributed MUA to be evaluated, such as such as hood type geometric differences, cross draft effects and side panels. For example, using a proximity hood instead of a wall-mounted canopy hood over the same appliances allowed a reduction in exhaust rate as high as 59 percent for the griddles and 70 percent for the charbroilers (for base case cooking conditions, no side panels, no drafts).

Air Curtain

The air curtain MUA strategy was the worst performing design for this project, even at very low supply rates. For the test conditions where C&C was achieved, the average percentage of local MUA through the air curtain was about 10 percent of the exhaust rate. At local MUA flow rates greater than 10 percent, the exhaust airflow had to be increased by almost ten cfm for every one cfm of air delivered by the air-curtain strategy in order to maintain C&C. Performance of the tested air curtain suggests that this strategy is highly sensitive to design geometry and local MUA flow rate – consequently, there may be better performing designs available. Although the degradation of performance was much greater than anticipated at the onset of the study, it is consistent with anecdotal experience of the CKV industry. Several hood manufacturers recommend that the percentage of MUA supplied through an air-curtain be limited to less than 20 percent of the exhaust rate. The data generated by this study can be used effectively within CKV design guidelines and the ASRHAE Handbook to caution designers about the application limitations of air curtains.

Short Circuit

The short-circuit strategy did not perform well. For the test conditions where the hood was able to achieve C&C of the plume, the average allowable short-circuit supply rate was 14 percent and the maximum possible was 21 percent. Operation above 21 percent of the exhaust rate, such as at typical short-circuit specifications of 50 percent, 75 percent or 80 percent of exhaust rate, resulted in the hood's failure to capture and contain the effluent plume. To achieve short-circuit airflow rates of 50 to 80 percent usually requires increasing the exhaust rate above the base case, which of course increases fan energy use and costs.

Front Face

Front-face supply has been widely promoted by hood manufacturers and is representative of a large population of systems in commercial kitchens. It was the local MUA strategy that the research team had anticipated would least impede the performance of the exhaust hood. Results of testing demonstrated otherwise, as the front face supply significantly compromised the ability of the exhaust hood to capture and contain. In a fashion similar to the air curtain, the velocity of the MUA tended to aggressively “pull” the effluent plume from beneath the hood. For the test conditions where the hood was able to achieve C&C of the plume, the average percentage of MUA allowable from the front face was about 14 percent.

An important caveat to this observation was the fact that the front-face plenum and perforated grille tested was not a manufacturer's catalogue item. It had been designed and fabricated within the scope of the research project to facilitate switching from the air-curtain to face-discharge configuration. Although the air-curtain component probably was representative of some typical off-the-shelf designs, the face supply may not be representative of manufacturer-specific designs. Since modifications that were made to the front-face plenum by the researchers

resulted in significantly improved hood performance, it is hypothesized that design differences from one manufacturer to another could influence the impact of this MUA strategy.

Four Way Ceiling Diffuser

This study focused on documenting what has been anecdotally reported as being the worst type of ceiling diffuser to install in the vicinity of an exhaust hood – namely, a 4-way louvered diffuser. Five four-way ceiling diffusers were mounted at a distance of about two feet from the diffuser to the vertical face of the hood. These were tested one at a time to determine sensitivity to location. The most sensitive location was centered left to right along the front face of the hood. The remaining tests were performed by introducing local makeup air through this diffuser. For the single diffuser test setup under all test conditions, the average percentage of MUA allowable from the diffuser was about 15 percent of the exhaust rate.

In general, the average increase in exhaust flow rate for the canopy hood cases due to 1000 cfm introduced from the front center 4-way diffuser ranged from 350 to 650 cfm compared to the displacement only case. The key to successful use of ceiling diffusers (of all types) is to assure that the air velocity at the hood entrance is relatively low (50 fpm or less). While determining location sensitivity, it was found that the connection between the 4-way diffuser and the ductwork had a significant effect on the velocity distribution from the diffuser.

Four-way diffusers located close to kitchen exhaust hoods operating at maximum design flow rates may have a detrimental effect on hood performance. C&C performance is affected by the airflow from the diffuser moving across the lower edge of the hood and entraining the thermal plume. The greater the vertical velocity of the air at the lower edges of the hood, the worse the effect. This downward velocity from the diffuser entrains the thermal plume along the lower edge of the hood and spills effluent into the kitchen.

Backwall Supply

The backwall supply configuration was the most successful local air introduction strategy tested. The percentage of MUA supplied from the backwall supply while maintaining acceptable hood performance was the highest tested for the study.

The canopy hood was able to use a higher percentage of MUA from the backwall supply system (average 46 percent) than the proximity hood (20 percent average) without affecting hood performance. However, the proximity hood design used between 36 percent - 57 percent of the exhaust flow and net replacement flow rates required by the canopy hood. For this particular set of hoods, the laboratory air supply to the backwall reached maximum capacity; backwall flow rates greater than 57 percent (and its influence on exhaust rate) could not be tested.

Summary: Influence of MUA Strategy on C&C Exhaust Rate

What was not anticipated during the design of the study was how sensitive the C&C threshold would be to the local introduction of MUA. Spill conditions often were observed when as little as 10 percent of the exhaust rate was supplied by a given local MUA strategy.

Figure 1 shows the trends for changes in exhaust airflow rate as MUA flow rate increases for each of the strategies tested. The graph shows that the air curtain strategy required the greatest exhaust rate increase and the backwall supply strategy required the least. These trends reflect

the relative amount of disturbance that each MUA strategy had on plume stability, and hence C&C, for the conditions tested. These trend lines are revealing, as most of the strategies investigated required significant increases in the exhaust rate to overcome the negative impact of the MUA introduction. Note that the “0” cfm on the Y-axis represents the C&C flow condition for the given hood/appliance combination being tested.

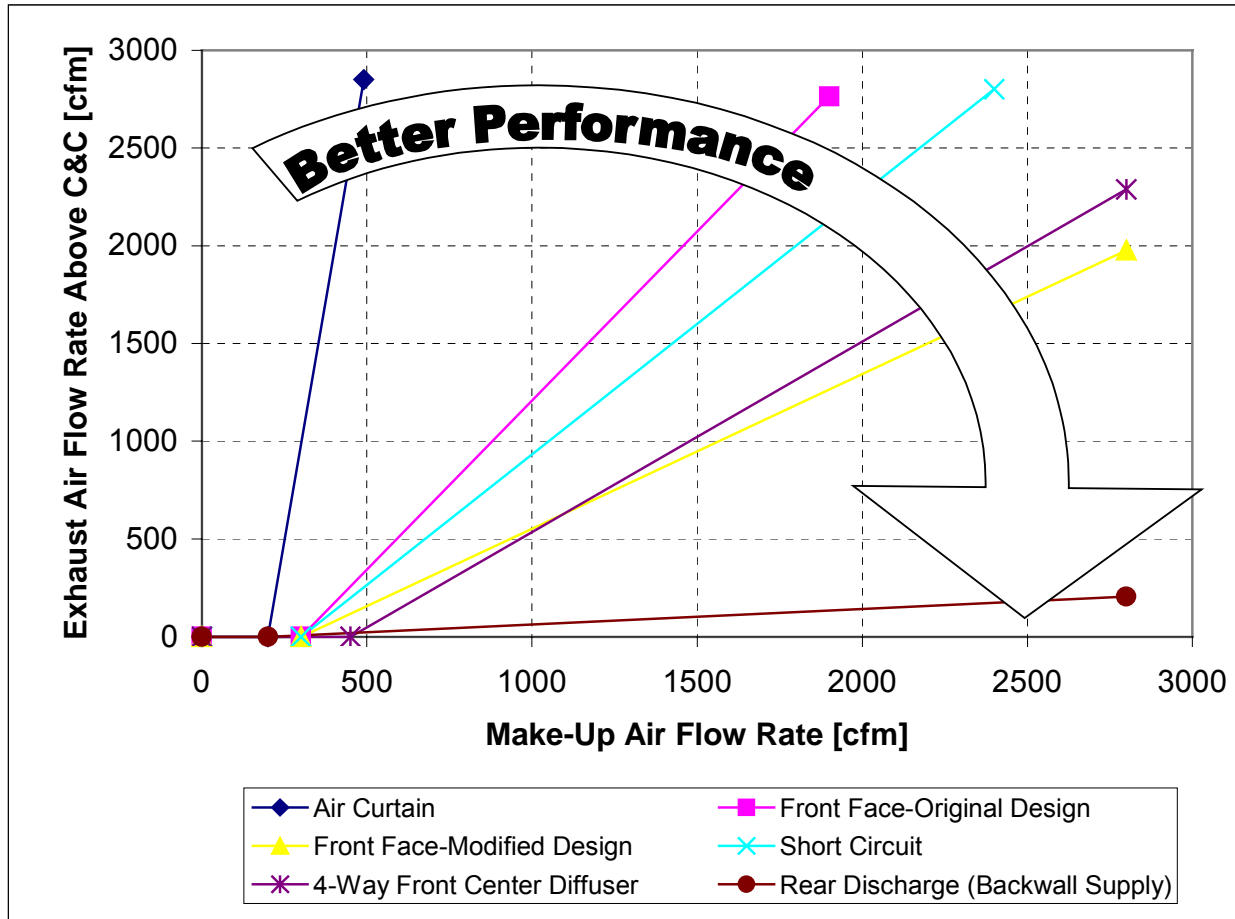

Figure 1: Summary of Exhaust-to-MUA Trends

Outcomes Specific to Hood Design

Hood Style

As anticipated in the design of this study, hood type had a significant impact on the exhaust rate required for C&C over the tested appliances. The results confirmed that the single island-mounted canopy hood required the highest exhaust rate, the wall-mounted canopy hood required less, and the proximity hood required the least. The single island canopy hood proved to be more sensitive to the effects of MUA velocities and air disturbances when compared to the wall mounted canopy hood. Increases in exhaust rate ranged from a few percent to immeasurable because the exhaust capacity of the lab was exceeded.

Side Panels

The installation of side panels improved C&C performance in static conditions (average 10 – 15 percent exhaust reduction) and in dynamic conditions (up to 35 percent exhaust reduction).

Outcomes Specific to Room Conditions

The required exhaust rates for C&C were always higher for the heavy-duty broilers compared to the medium-duty griddles. To give a representative example of the effect of room dynamics on hood performance, a pedestal fan was used for this study. Test results showed that the disturbance caused by the cross draft of the fan had a detrimental effect on all hood and appliance combinations. As anticipated, cross drafts had the greatest impact on the island-mounted hood, since all four sides are open to the space. Subjecting the island canopy hood, in all MUA configurations, to the fan-generated cross draft caused the laboratory exhaust fan to top out at maximum capacity. For example, the cross draft required that the exhaust rate be increased by 238 percent while testing griddles cooking with displacement ventilation, but C&C could not be achieved.

Outcomes Specific to Appliances

Under all test conditions, exhaust rates for idling conditions were less than for cooking conditions. Using two-speed or variable exhaust flow rates for idle and cooking conditions would minimize operating costs by operating at higher airflow requirements only as needed. Appliances idle for much of the day in commercial and institutional kitchens, so energy savings and environmental impact could be significant over time.

Conclusions

The strategy used to introduce replacement (makeup) air may significantly impact hood performance and should be a key factor in the design of kitchen ventilation systems. MUA introduced close to the hood's capture zone may create local air velocities and turbulence that result in periodic or sustained failures in thermal plume C&C. Furthermore, the more MUA supplied (expressed as a percentage of the total replacement air requirement), the more dramatic the negative effect.

The experimental design incorporated a test setup that produced a steady-state, worst-case cooking effluent challenge for each combination of appliance/hood/MUA system that was investigated. This allowed the effects of a given MUA strategy and airflow to be documented and compared to each other with a level of confidence. However, this condition of peak effluent production may only represent a fraction of appliance operating time in a working kitchen. Thus the failure of an exhaust hood to capture and contain due to a MUA disturbance may not be continuous. The negative impact of a specific MUA strategy may be suppressed on a time-weighted basis to such an extent that the food service operator is not be aware of the compromised performance.

The base case for evaluating MUA strategies was threshold C&C for displacement diffusers. By definition there is no safety factor built in for threshold C&C. If a designer of a CKV system applied a significant safety factor to the exhaust ventilation rate, then the negative impact of a MUA supply strategy may be suppressed.

The influence of MUA being supplied in close proximity to the exhaust hood had not been systematically investigated before this project. Consequently, the research plan was broad in scope but not exhaustive, and was designed to investigate suspected failure mechanisms, including some worst-case scenarios. There are numerous configurations that were not investigated, several of which merit additional research. This factor must be considered before one extrapolates the results of this study to real-world design and manufacturer-specific MUA configurations. ***Although the study demonstrated the potential for a given MUA strategy to impede capturing and containing cooking effluent, we were not able to conclude that performance degradation of the exhaust system would always result from a given strategy.*** For example, the negative impact of a 4-way diffuser was demonstrated for a worst-case location and relatively high airflow through the diffuser. The results confirmed anecdotal experience of kitchen ventilation professionals. But one cannot conclude that all 4-way diffusers installed within the vicinity of the hood will be detrimental to the performance of the exhaust system.

Having stated this caveat, it was conclusively demonstrated that each of the MUA strategies and specific configurations tested in this study created a situation where the ability of the exhaust hood to completely capture and contain the thermal plume and/or effluents was compromised.

Key Findings

- Hood type has a significant influence on C&C exhaust rate. The island and wall mounted canopy hood types required more than twice the exhaust rate of the proximity hood type for the same appliances and operating conditions.
- Supplying large percentages of replacement air within the vicinity of an exhaust hood may interfere with capture and containment. Although the study demonstrated the potential for a given MUA strategy to impede capturing and containing cooking effluent, we were not able to conclude that performance degradation of the exhaust system would always result from a given strategy.
- The internal design of integrated supply plenums and air outlets (air curtain, front face, and short circuit) influences discharge velocity rate and velocity uniformity, which in turn, impacts hood performance.
- For canopy hoods, greater hood overhang can improve C&C performance.
- Side panels permit a reduction in the C&C exhaust rate and provide a method to mitigate cross draft problems in existing or new kitchens.

Applying the Findings

Attachment 1 of this report is a design guide that presents the findings of this research as well as the practical experience of the authors, from a perspective of good design practice. The ultimate indicator of research success is adoption of the results in the marketplace. The impact these research findings will have on the marketplace is evident by the high level of industry interest and involvement, including:

- Both during the research phase, and now, as early commercialization is initiated, there has been active engagement from manufacturers, designers, utilities, and restaurant owners throughout the state.
- The principal investigators for the project have already applied the research results in projects with their clients. One full service restaurant now has an improved ventilation system using a backwall supply for replacement air. Several other projects are in the design phase.
- Recent proprietary testing at the Commercial Kitchen Ventilation Laboratory for kitchen manufacturers Captive Aire, Greenheck, and Randell, used the results of this Commission-sponsored study as a foundation for further development.
- California utilities have supported this work in several ways. Several have hosted customer seminars highlighting the findings. Southern California Edison is planning a companion design guide that elaborates on the design process needed to take advantage of the research results. Additionally, the Emerging Technology Coordinating Council (comprised of San Diego Gas & Electric, Pacific Gas & Electric, Southern California Edison, and Southern California Gas) has started a commercial kitchen ventilation demonstration program based on the research results from the project. Four sites have been earmarked (including two Applebee's and Islands, and a Panda Express) and two to four more locations are likely to be identified. Several replacement air designs as well improved hood designs and variable speed exhaust systems will be demonstrated.

In addition to the Design Guide, current information may be found on the following web sites:

www.fishnick.com

www.archenergy.com

<http://www.energy.ca.gov/pier/reports.html>

Benefits to California

The Commission estimates that in the year 2000 food service facilities accounted for about 145 million square feet of commercial floor space, 5960 GWh of electric use and 929 MW of demand. Growth in restaurant floor space may add an additional 33 million square feet by 2012.

Based on an estimated 225 million cubic feet per minute of exhaust air from existing food service facilities in the State of California, exhaust and replacement air fan energy uses about 460 GWh and 90 MW demand. Applying the research results would lead to a reduction in electric energy use and demand of about 69 GWh and 14 MW, assuming an across the board reduction in exhaust and replacement air fan energy of 15 percent. These savings do not include cooling and heating energy associated with replacement air. Reductions up to 50 percent are possible with innovative new designs.

Abstract

The objective of this research project was to improve the performance and energy efficiency of commercial kitchen ventilation (CKV) systems by performing flow-visualization research and publishing design guidelines for the food service community. The project focused on how the introduction of replacement (makeup) air affects the performance and energy efficiency of commercial food service ventilation equipment. A total of 214 distinct sets of test conditions were investigated, involving combinations of hoods, appliances, cooking conditions, makeup air (MUA) strategies, and other factors. Three hood types were tested: (1) Wall Mounted Canopy, (2), Island Mounted Canopy, and (3) Proximity (Backshelf). Charbroilers and griddles, representing heavy duty and medium duty appliances, respectively, were tested. Idle and emulated cooking conditions were tested. The influence of cross drafts and tapered side panels were investigated. The MUA strategies included (1) Displacement Ventilation (base case), (2) Ceiling Diffuser, (3) Hood Face Diffuser, (4) Air Curtain Diffuser, (5) Backwall Supply, and (6) Short-Circuit Supply.

As anticipated in the design of this study, the results confirmed that the island mounted canopy hood required the highest exhaust rate, the wall mounted canopy hood required less, and the proximity hood required the least.

Although the study clearly demonstrated the potential for a given local MUA strategy to impede the capability of the exhaust hood to capture and contain cooking effluent, we were not able to conclude that performance degradation of the exhaust system would always result from the application of a given strategy. Having stated this caveat, it was conclusively demonstrated that each of the MUA strategies and specific configurations tested created a situation where the ability of the exhaust hood to completely capture and contain the thermal plume was compromised. In some cases, this was due to the generic strategy itself (short-circuit supply, air-curtain supply), while in others it was a result of design-specific features of the configuration tested (e.g., face-discharge supply).

Relative to the base case using displacement ventilation, the general results for the five MUA strategies were the following:

- **Short Circuit Supply:** The short circuit strategy did not perform well. For the test conditions where the hood was able to achieve capture and containment (C&C) of the plume, the average allowable short circuit supply rate was 14 percent.
- **Air Curtain:** The air curtain MUA strategy was the worst performing design for this project, even at very low supply rates. For the test conditions where the hood was able to achieve C&C of the plume, the average percentage of MUA allowable from the air curtain was about 10 percent.
- **Ceiling Diffusers:** Four-way diffusers located close to kitchen exhaust hoods showed a detrimental effect on hood performance, particularly when the flow through the diffuser approached its design limit. For the single diffuser test setup under all test conditions, the average percentage of MUA allowable from the diffuser was about 15 percent.
- **Front Face:** The two front face plenum designs tested did not perform well. In theory air discharged from the front face exits perpendicular to it. In practice, the internal design of

front face plenums can result in a variety of discharge velocity profiles. The ones tested discharged the MUA downward (nearly parallel to the front face, due to internal plenum design). For the test conditions where the hood was able to achieve C&C of the plume, the average percentage of MUA allowable from the front face was about 14 percent.

- Backwall Supply: The backwall supply configuration has potential for being a successful local air introduction strategy. The percentage of MUA supplied from the backwall supply while maintaining acceptable hood performance was the highest tested for the study. The canopy hood was able to use a higher percentage of MUA from the backwall supply system (average 46 percent) than the proximity hood (20 percent average).

The testing revealed that the greatest increase in exhaust flow rate was required for cross drafts, which can be caused by portable fans, kitchen traffic, or drive-through windows. Side panels allowed a reduction in the exhaust rate required for C&C under all test scenarios.

The strategy used to introduce replacement (makeup) air may significantly impact hood performance and should be a key factor in the design of kitchen ventilation systems. MUA introduced close to the hood's capture zone may create local air velocities and turbulence that result in periodic or sustained failures in thermal plume C&C. This study was a general investigation into the challenges of MUA introduction. There are numerous configurations that were not investigated, several of which merit additional research. This factor must be considered before one extrapolates the results of this study to real-world design and manufacturer-specific MUA configurations.

1.0 Introduction and Background

A successful commercial kitchen design can mean many things to many people. To the chef, it is a convenient and ergonomic layout in which cooking can be performed in comfort. To the owner, it is a cost-efficient design that provides the production capacity and the safety features needed by the operators. To the designer, it is a simple but effective plan, which allows the specified equipment and utilities to be installed in compliance with all applicable codes.

A universal concern regarding the commercial kitchen space is having an effective ventilation system. A large portion of kitchen ventilation planning is dedicated to properly exhausting cooking effluent. Appliance layout and the energy input are evaluated, hoods are located and specified, the ductwork size and routing are determined, and exhaust fans are specified to remove the proper volume of air. Often, much less time is usually dedicated to planning how the exhausted volume of air will be replaced, although an air balance schedule is commonly used to indicate the source and quantity of the makeup air (MUA).

Overlooking the details of the MUA delivery system can have a negative impact on the performance of an otherwise well-designed kitchen. Cross drafts and high air velocities due to improper introduction of the MUA can result in a failure of the hood to capture and contain effluent from the appliances. This effluent spillage may include convective heat, products of natural gas combustion (carbon dioxide, water and potentially carbon monoxide), and products from the cooking process, such as grease vapor and particles, odors, water vapor, and miscellaneous hydrocarbon gasses. The overall commercial kitchen ventilation issues include indoor air quality, fire prevention, safety, employee comfort, and equipment first costs and energy operating costs. These costs often compete with the ventilation issues for foodservice industry and operator attention.

With respect to the kitchen ventilation system, the designers' primary focus is capture and containment (C&C) of the cooking effluent and thermal plume. The building owners' major interests are minimized design and installation costs of the HVAC system. Energy efficiency is often a minimal concern to the design team. However, the energy efficiency of commercial kitchens is directly related to the exhaust ventilation system. It has been shown that the HVAC load in a restaurant represents approximately 30 percent of its total energy consumption. Depending on facility layout, the kitchen ventilation system can account for up to 75 percent of the HVAC load (including fan energy) and represents a large energy-consuming end use within a commercial food service facility.

In the 1970s, concern about kitchen ventilation energy costs gave rise to a new design concept, referred to as the short-circuit exhaust hood. Alternatively referred to as compensating, no-heat, or cheater hoods, they were developed as a strategy to reduce the amount of conditioned MUA required by an exhaust system designed to code. By introducing a portion of the required MUA at ambient outdoor conditions directly into the exhaust hood, the net amount of conditioned air exhausted from the kitchen is reduced. Thus, the total exhaust capacity of the system will be able to meet code requirements while the actual quantity of MUA that needs to be heated or cooled is minimized. Figure 2 illustrates the intended functioning short-circuit hood. Unfortunately, the amount of short-circuited air often reduces the net ventilation to the point where spillage of cooking effluent occurs (Figure 3), compromising the kitchen environment.

However, if less "net" exhaust air is adequate, why not simply design the exhaust system to ventilate the cooking equipment at a reduced rate in the first place?

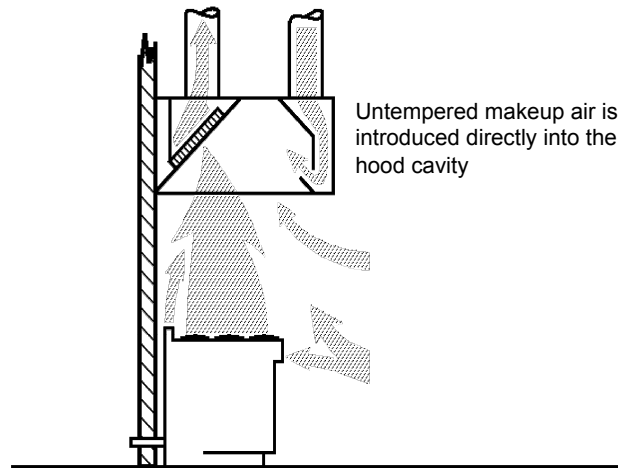

Figure 2: Cross-Section of Wall-Mounted Canopy Hood with Short-Circuit MUA Theoretically Working Properly

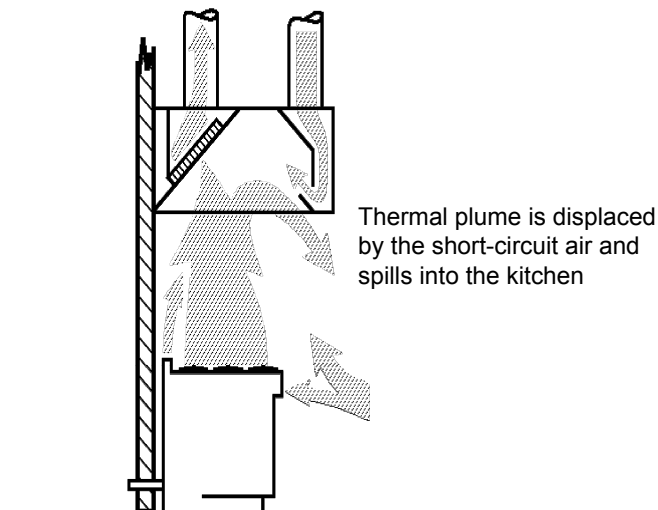

Figure 3: Cross-Section of Wall-Mounted Canopy Hood with Short-Circuit MUA Actually Causing Spillage

These problems exist in part due to a lack of comprehensive design information for commercial kitchen ventilation (CKV) systems. Although the ASHRAE Handbooks are recognized as a fundamental source for information on designing HVAC systems, the Handbooks did not have a chapter devoted to ventilating commercial cooking equipment prior to the 1995 edition. Even the 1999 edition is lacking information on the introduction of MUA and the effect that a MUA strategy may have on hood performance and energy consumption of the system. Thus an HVAC engineer without extensive knowledge of CKV research probably will specify exhaust ventilation rates based on the more prescriptive code criteria. The research described in this report provides some answers to these issues, but it also reveals that kitchen ventilation is a very complex subject and that additional investigation will be needed to strengthen comprehensive design guidelines.

1.1 Project Objectives

The objective of this research project was to improve the performance and energy efficiency of CKV systems by performing flow-visualization research and publishing design guidelines for the food service community. This R&D project focused on how the introduction of replacement (makeup) air affects the C&C performance and energy use of CKV systems.

Table 1 and Table 2 list the combinations of hoods, appliances, cooking conditions, MUA strategies, and other factors that were tested. The combinations total 214 distinct sets of test conditions.

Table 1: Testing Matrix – Wall-Mounted Canopy Hood

Wall-Mounted Canopy With and Without Side Panels With and Without Drafts	Makeup Air Source						
	Appliance Setup	Baseline: Displacement Diffuser	Ceiling Diffuser	Face	Air Curtain	Backwall	Short Circuit
Heavy Duty: Charbroilers							
Idle C&C	√	√	√	√	√	√	√
Simulated Heavy Cooking C&C	√	√	√	√	√	√	√
Medium Duty: Griddles							
Idle C&C	√	√	√	√	√	√	√
Simulated Heavy Cooking C&C	√	√	√	√	√	√	√

Table 2: Testing Matrix – Island-Mounted Canopy Hood

Island-Mounted Canopy	Makeup Air Source					
With and Without Side Panels	Makeup Air Source					
With and Without Drafts	Makeup Air Source					
Appliance Setup	Baseline: Displacement Diffuser	Ceiling Diffuser	Face	Air Curtain	Backwall	Short Circuit
Heavy Duty: Charbroilers						
Idle C&C	√	√	√	√	N/A	N/A
Simulated Heavy Cooking C&C	√	√	√	√	N/A	N/A
Medium Duty: Griddles						
Idle C&C	√	√	√	√	N/A	N/A
Simulated Heavy Cooking C&C	√	√	√	√	N/A	N/A
Proximity (Backshelf) Hood	Makeup					
With and Without Side Panels	Makeup Air Source					
With and Without Drafts	Makeup Air Source					
Appliance Setup	Baseline: Displacement Diffuser	Ceiling Diffuser	Face	Air Curtain	Backwall	Short Circuit
Heavy Duty: Charbroilers						
Idle C&C	√	√	N/A	N/A	√	N/A
Simulated Heavy Cooking C&C	√	√	N/A	N/A	√	N/A
Medium Duty: Griddles						
Idle C&C	√	√	N/A	N/A	√	N/A
Simulated Heavy Cooking C&C	√	√	N/A	N/A	√	N/A

N/A: Not Applicable

1.2 Report Organization

This report contains seven sections in addition to the Introduction. Sections 2 and 3 provide experimental details and mythology while sections 4 and 5 break down the findings and outcomes for the various types of equipment and conditions examined. Section 6 contains the conclusions of this project and recommendations for further research. References (Section 7) and a Glossary (Section 8) are also provided.

Attachment 1 of this report is a design guide that presents the findings of this research as well as the practical experience of the authors, from a perspective of good design practice.

In addition, there are two appendices: Appendix I: Summary of Data, and Appendix II: Laboratory Description.

2.0 Experimental Design

A variation of the visual C&C test protocol in ASTM Standard F1704-99, *Standard Test Method for Performance of Commercial Kitchen Ventilation Systems*, was used to evaluate hood performance under each test setup listed in Table 1 and Table 2. This section describes the airflow visualization system, the hoods and appliances tested, the operating conditions emulated, and the testing process. See Appendix II for the laboratory description.

2.1 Airflow Visualization

Focusing schlieren systems and shadowgraph systems were the primary tools used for airflow visualization. Schlieren systems visualize the refraction of light due to air density changes. Schlieren means smear or smudge in German. The visual effect can be directly observed when looking over a hot road during the summer or at the exhaust of a jet engine. Using sophisticated optical technology, the laboratory schlieren flow visualization system amplifies this effect for lower temperature differences, providing higher sensitivity and contrast than what is seen by the naked eye. Figure 4 is an example of what is seen with the naked eye compared to what can be seen from the same vantage point through a schlieren optical system. Shadowgraph systems also make use of the schlieren effect, providing similar sensitivity but with less contrast than laboratory schlieren flow visualization systems.



Figure 4: Naked Eye and Schlieren Optical System Views of an Open Range Top with Burners on, under Canopy Hood

Figure 5 shows a plan view of the test setup and the flow visualization systems. One schlieren system was aligned to the front edge of the hood and another schlieren system monitors the rear edge of the hood. Both schlieren systems were located at a height that is half the distance between a typical 36-inch appliance height and a canopy hood mounted 78 inches above the floor. The left and right edges of the hood are viewed using shadowgraph systems on portable stands. Generally, the shadowgraph systems were located at the same height as the hood edges being monitored

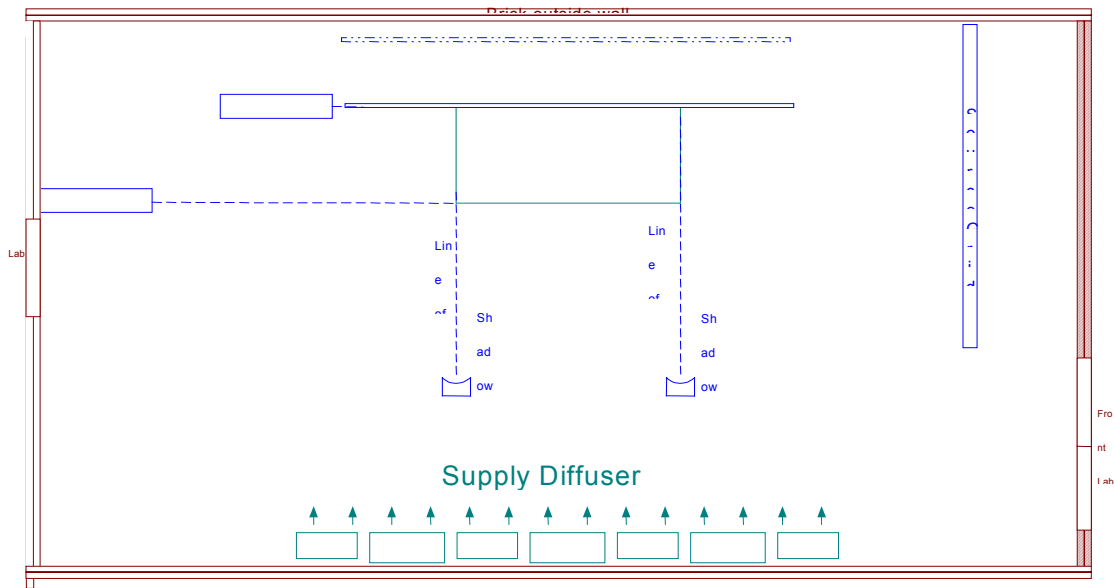

Figure 5: Plan View of Flow Visualization Equipment Setup.

2.2 Hood/Appliance Relationships

For most canopy hood tests, two identical appliances were positioned 6-inches horizontally behind the front, left, and right edges of the hood – often referred to as setback or overhang. Any gap between the appliances to achieve these positions was filled with sheet metal attached near the cooking surfaces of each appliance. This prevents air from rising between the appliances and influencing the effluent plume.

To avoid the appliance height affecting the test results, the appliances were set to a common height of 37-inches above the finished floor. This height is near typical installation heights for most commercial cooking appliances. The griddles were raised to 37 inches and the charbroilers were left at their designed height of 37 inches.

Except for the short circuit setup, all canopy hood testing was performed using one canopy hood. This hood measured 8-feet long by 4-feet deep by 2-feet tall. It was equipped with baffle-type grease filters, and exhausted through a 3-foot by 1-foot exhaust collar. This collar was transitioned to the laboratory’s existing 24-inch ductwork over a height of 3-feet. To allow for generic testing, the canopy hood was modified by removing a performance enhancing interior angle and replacing the sides with clear plastic for visualization purposes. Tapered side panels constructed of clear plastic were temporarily installed in selected test scenarios to evaluate performance effects.

For front face supply and air curtain makeup strategies, an 8-foot by 1-foot MUA plenum was installed on the front surface of the canopy hood. The plenum, fabricated specifically for this research project, was a simple box with interchangeable inserts for perforated front face or a slotted air curtain setup.

Figure 6 through Figure 12 show the different hood and appliance combination test setups.



Figure 6: Two Griddles Under an 8' Exhaust Hood with Transparent 1/4 Side Panels



Figure 7: Two Gas Charbroilers under an 8' Hood Canopy Hood with Attached MUA Plenum with Front Face Supply



Figure 8: Side View of an 8' MUA Hood with Air Curtain Supply



Figure 9: Two Gas Griddles under an 8' Exhaust Only Canopy Hood

For the short circuit evaluation, a hood from another manufacturer was used. For testing purposes, the hood was modified by replacing metal side panels with clear plastic and by removing a piece of slot-type sheet metal located directly in front of the hood's baffle filtration system. This hood measured 8-feet 8-inches long by 4-foot 2-inches deep by 2-feet tall. Exhaust travels through a collar measuring 16-inches by 8-inches and transitions to the laboratory's 24-inch ductwork over 3-feet. Tapered side panels constructed of clear plastic were also evaluated on the short circuit canopy to assess potential benefits.



Figure 10: Cooking Test of Two Gas Charbroilers under a Wall Mounted Short Circuit Canopy Hood

The proximity (backshelf) hood was from a third supplier. Clear side panels were installed and a proprietary performance-enhancing shape was removed to generalize results. The length of the hood is 86 inches, with the front lip of the hood located 67.5-inches above the finished floor. The sides of the hood have integrated tapered side panels that extend to 42.5-inches above the finished floor at the rear of the hood. The hood is equipped with baffle-type grease filters and exhausts through a 10-inch by 14-inch collar to the laboratory's existing 24-inch ductwork. Full side panels constructed of clear plastic were used in selected test cases on the backshelf hood to evaluate potential benefits. Full side panels are provided by the manufacturer when this hood is installed over extra heavy-duty appliances.



Figure 11: Two Gas Charbroilers under an 86-in Long Proximity (Backshelf) Hood with Transparent Partial Side Panels



Figure 12: Side View of Two Gas Charbroilers under an 86-in Wide Proximity (Backshelf) Hood with Transparent Partial Side Panels

2.3 Appliances

The MUA study included evaluations with medium and heavy duty cooking equipment. Two identical gas griddles were chosen to represent medium duty appliances and two identical gas charbroilers were selected to represent heavy-duty appliances.

Each gas griddle had a rated input of 90,000 Btu/hour (4 burners at 22,500 Btu/hr each). The cooking surfaces were 28.5 inches deep by 36 inches wide. The overall footprint of each griddle was 39.5 inches deep by 38 inches wide. Griddle stands were modified so that the cooking surfaces were 37 inches above the finished floor.

Each gas charbroiler had a rated input of 96,000 Btu/hour (6 burners at 16,000 Btu/hr each). The cooking surfaces were 22.75 inches deep by 32 inches wide. The overall footprint of each griddle was 33 inches deep by 34 inches wide, with an overall height of 37 inches above the finished floor.

C&C performance was evaluated for idle and cooking conditions for both appliance types. To provide consistent and comparable results, procedures were established for all tests, including appliance condition for idle C&C evaluation, MUA introduction location and direction, cross draft generation, and cooking simulation.

2.4 Griddle Idle and Cooking Conditions

During idle C&C performance evaluations, the thermostatically controlled griddles were stabilized at the 375°F average surface temperature defined in ASTM 1275-95 *Standard Test Method for the Performance of Griddles*. After stabilization, the control power was turned off to prevent the gas burners from cycling during the evaluation. A brief evaluation was made, and then the power restored to the griddles to maintain temperature setpoint.

Cooking hamburgers on a griddle provides peak effluent production for approximately 10 seconds during a 6-minute cooking session. Ten seconds is not long enough to properly evaluate C&C under changing makeup air conditions. For consistent testing conditions, a realistic surrogate was needed to provide a longer peak effluent condition, as well as to allow timely and cost-effective test turn around. Using actual cooking as a baseline, a strategy for cooking plume simulation was developed.

Figure 13 shows a schematic of a cooking plume simulator and Figure 14 is a photograph of the one used in the research. The cooking plume simulator concept was based on spraying water onto the hot cooking surface. Tap water was piped to a pressure regulator and timed relay valve. The relay provided a pulse of water to each manifold, allowing relatively high pressure to fill each generator without flooding the griddle surfaces with too much volume. From the relay valve, the pipe divided into two lines, each leading to a griddle. Near the cooking surface, the water passed through a needle valve, which throttled the water distribution between the two simulators. A manifold with four branches then transported the water, front to rear, along the griddle. The branches distribute the water from side to side, with a small hole located above the cooking surface where each hamburger patty would be cooking. The water sprayed onto the cooking surface vaporized quickly. This vapor plume was very similar to the plume created by hamburger patties during cooking, but was more consistent for C&C evaluation.

The simulator was calibrated by maintaining the cooking C&C exhaust rate while adjusting the water flow rate. Airflow was then adjusted in small increments to ensure spillage at a slightly lower exhaust flow rate, and capture at the previously established cooking C&C rate.

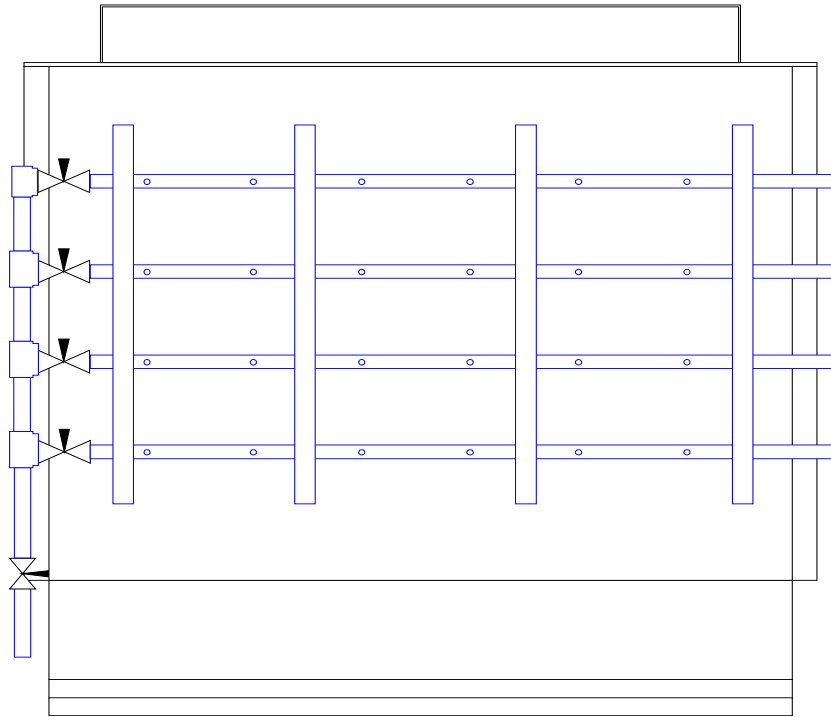

Figure 13: Cooking Simulator Setup: Pipes with Small Holes Dispense Timed Jets of Tap Water onto the Cooking Surface



Figure 14: Two Gas Griddles under a Canopy Hood with the Cooking Simulator Installed

2.5 Charbroiler Idle and Cooking Conditions

Since the charbroilers were not thermostatically controlled, the idle condition was based on determining C&C after the broiler reached a ready-to-cook state. Broiler calibration was performed according to ASTM 1695-96 *Standard Test Method for Performance of Underfired Broilers*, which required an average cooking surface temperature of 600°F. The cooking C&C condition was based on actual cooking with hamburgers.

The cooking simulator used with the griddles proved ineffective in emulating the charbroiler cooking plume because the water spray on the broiler cooking surface flash vaporized due to the very hot surfaces. Since the charbroilers are not thermostatically controlled, thermal plume production is steady compared to the griddles. This characteristic provided a simple way to simulate cooking. First, a series of actual cooking tests were completed to establish the C&C threshold. These were recorded on videotape. Second, while exhausting at the cooking C&C rate, the gas flow was increased to visually match the recorded actual cooking plume.

To allow for quick and repeatable changing from idle to simulated cooking, parallel gas regulators were installed. One regulator was set to the manufacturer's specified gas manifold pressure. The other regulator was set at the increased gas pressure necessary to simulate a cooking plume.

2.6 Cross Draft Generation

Evaluating the performance degradation due to cross drafts required a repeatable and practical disturbance. For this task, a pedestal-mounted fan, operating on its highest power setting, was selected. The axis of the 16-inch diameter fan was located at 57 inches above the floor, halfway between the lower edge of the hood and the cooking surface. The axis of the fan was positioned on the diagonal that connected the opposite corners of the 4-foot by 8-foot exhaust only canopy hood. The air speed along the axis at the right front corner of the hood was 470 fpm, and at the left rear corner was 190 fpm.

2.7 MUA Strategies

Six ways of introducing replacement air into the kitchen were evaluated: (1) Displacement Diffusers, (2) Air Curtain Diffusers, (3) Face (of hood) Diffusers, (4) Ceiling 4-Way Diffusers, (5) Short Circuit Supply, and (6) Backwall Supply. ASHRAE's HVAC Applications Handbook, Kitchen Ventilation Chapter, also lists Transfer Air as another way of introducing replacement air. Transfer Air is conditioned air that was originally introduced in an adjacent space, such as the dining room or server areas. It can adversely impact hood performance if it does not flow into the kitchen at low velocity. It was not tested directly under this research project; the Displacement Diffusers used for the base line emulated low velocity transfer air.

2.7.1 Displacement

Displacement ventilators are designed to provide low velocity laminar flow from the diffuser surface. Displacement diffusers can be placed inside a wall, at the floor, or a few feet off the floor level on a wall. They consist of a large area of perforated plate relative to the amount of air discharged, which promotes nearly laminar flow from the face of the diffuser. A design using displacement diffusers aims to cause "pooling" of conditioned air in the comfort zone, which

displaces warm, contaminated air upward, where is returned to the HVAC system or exhausted. Air supplied through displacement diffusers is usually not as cool as that supplied through ceiling diffusers because it is not intended to mix in the zone. In the case of this research project, displacement diffusers were used as the base case due to their laminar flow characteristics.

2.7.2 Air Curtain Diffusers

Air curtain diffusers are located at the bottom edge of the hood and are usually supplied by an internal MUA plenum. On canopy hoods, this strategy was thought to be an effective way of cooling the cooks and providing MUA to the hood. The diffuser may consist of perforated plate or fixed or variable vanes, or combination of these. Air curtain diffusers may also be included on a proximity hood; this design was not tested as part of the research.

2.7.3 Face Diffusers

Face diffusers are located on the front vertical face of a canopy style hood. The diffuser may consist of perforated plate or fixed or variable vanes, or combination of these. Due the design of proximity hoods (e.g., backshelf hoods), face diffusers are usually not incorporated into them. Face diffusers were not included as part of the proximity hood research.

2.7.4 Ceiling 4-Way Diffusers

These are common painted sheet metal devices, with a few layers of fixed vanes. As air moves downward through the diffuser, it is deflected by the vanes and moves outward and slightly downward. In most commercial building applications, these diffusers are furnished in dimensions to fit the grid spacing of suspended ceilings, such as two-feet square. The replacement air supplied to ceiling diffusers may come from an integrated hood supply, from independent MUA units, or from HVAC units conditioning the kitchen.

2.7.5 Short Circuit

Diffusers located inside the hood reservoir characterize internal discharge (commonly known as short circuit) hoods. Replacement air is introduced directly into the exhaust hood cavity and it is typically not conditioned. Depending on local climate, manufacturer's design, type of cooking equipment and local codes, some conditioning may be required.

2.7.6 Backwall supply

Backwall supply is based on a MUA plenum that is installed between the back of the hood and wall. The full-length plenum typically extends down the wall to approximately 6" below the cooking surface or 2 – 3 feet above the floor. The plenum is commonly 6" wide (front to back). The MUA is discharged behind and below the cooking equipment.

3.0 Methodology

This section describes the C&C evaluation procedure used in the research, as well as how exhaust airflow rates were determined and how heat gain testing was performed.

3.1 Capture & Containment Testing

To understand C&C testing, it is necessary to define some key terms. The phrase "hood capture and containment" is defined in ASTM-1704 *Standard Test Method for the Performance of Commercial Kitchen Ventilation Systems* as "the ability of the hood to capture and contain grease-laden cooking vapors, convective heat and other products of cooking processes," Hood capture refers to the products getting into the hood reservoir from the area under the hood, while containment refers to these products staying in the hood reservoir and not spilling out into the space adjacent to the hood. The phrase "minimum capture and containment" is defined as "the conditions of hood operation in which minimum exhaust flow rates are just sufficient to capture and contain the products generated by the appliance in idle and heavy-load cooking conditions, or at any intermediate prescribed load condition." The phrase "threshold C&C" is used in this report interchangeably with "minimum capture and containment."

During the baseline displacement ventilation C&C tests, the exhaust flow rate was reduced until spillage of the thermal plume was observed. The exhaust flow rate was then increased in fine increments until full C&C was achieved for the test condition. The airflow rate at this condition is referred to as the threshold exhaust airflow rate for complete C&C. These values provided a baseline case to judge the various MUA strategies against.

For most initial local MUA C&C evaluations, the exhaust airflow rate was set to the rate determined in the baseline displacement ventilation test. As the local MUA was introduced, the displacement flow rate was decreased to maintain the pressure balance in the space and the exhaust rate. The local MUA was increased until spillage of the thermal plume occurred. The local MUA was then reduced to achieve C&C. This local MUA rate was the minimum airflow rate reported relative to the displacement exhaust C&C rate.

After the initial local MUA C&C evaluations, the local MUA was increased in increments, resulting in spillage. After each increase in local MUA, the exhaust rate was increased to regain C&C.

Exceptions to the general procedure for local MUA C&C testing included the ceiling 4-way diffuser and backwall supply testing. Testing the 4-way diffuser was performed with a constant airflow from the 4-way diffuser, and modulating the exhaust system to achieve proper thermal plume C&C. In addition, the backwall supply plenum proved able to supply more local MUA than the laboratory's local makeup supply system was capable of providing. Therefore, to provide a reasonable estimate of allowable MUA percentage, the local MUA system was maximized, and the exhaust system reduced to find the threshold of C&C.

To provide a basis for comparison among the tests, a performance metric was created. The performance of the exhaust system and local makeup air system can be expressed as the ratio of exhaust air [EA] rate to the local makeup air [LMUA] rate, or EA:LMUA. High values of EA:LMUA (> 1.00) mean that the exhaust rate has to be increased by an amount greater than the increase in the local makeup air rate, relative to the C&C exhaust rate for the base case (no local

makeup air). Low values indicate that the local makeup air strategy has less impact on capture and containment, and hence the exhaust rate does not have to be increased as much. Negative values of EA:LMUA [> 1.0] mean that the local makeup air strategy has improved capture and containment and the exhaust rate can actually be decreased compared to the base case.

3.2 Exhaust Air Flow to Supply Air Flow Comparison

The CKV laboratory has a primary supply air system, a secondary supply air system, and one exhaust system. Metrology is located on the supply system and the room is designed to be airtight. This configuration provides precise airflow rates to supply a kitchen system and provided the data necessary to calculate heat gain loads. When airflow rates are adjusted to standard conditions, the airtight room allows calculation of the airflow for the supply systems and the exhaust system.

To indirectly measure the exhaust airflow rate for each hood installation, the supply and exhaust systems were operated without cooking appliances turned on. The primary air supply system for the laboratory was set manually and the exhaust system was allowed to automatically adjust to maintain a 0 ± 0.002 inches of water pressure differential with respect to the air outside of the laboratory. The fan speeds and airflow data were recorded for up to ten airflow rates. The exhaust fan motor speeds with correlated with supply system airflow rates to develop a linear equation. This linear relationship was incorporated into the laboratory control program, and allowed the operator to set an exhaust airflow rate by referencing the exhaust fan motor speed. Therefore, regardless of MUA or room conditions, the exhaust flow rate could be calculated by reference to the measured supply flow rate.

However, while airflow rates are simple to correlate with appliances off, actual exhaust flow rates change with appliances operating. The relatively cool air supplied to the room is heated and expanded as it passes over the hot appliance and natural gas appliance burners. Since the room is airtight, one of the air systems must adjust to compensate for the change in density and additional volume of air in the laboratory. For the testing under this project, the exhaust airflow rate was always set by the laboratory operator, as was the local makeup airflow rate from the secondary supply system. This required the laboratory's primary air supply system to modulate according to room pressure.

4.0 Discussion

4.1 Displacement Diffusers

The displacement system represented the baseline case in the study and replicated an ideal case of a kitchen receiving transfer air at low velocity from an adjoining space such as a dining room. Floor mounted displacement ventilators are not common in the restaurant industry due to the value of floor space for operational requirements. However, for research purposes, they were deemed to be the best way to establish base case conditions. Commercially available ventilators were used with distribution from a common supply trunk. Each unit had adjustable dampers within the supply collars to achieve even distribution among the units over the range of flow rates. During testing, the temperature of supply air from the diffusers cycled between 62 and 78 F to maintain a lab space temperature between 75 and 78 F. The temperature difference between the supply and the lab space was sufficient for visualization on the schlieren system. The visualization showed that the air discharged from the ventilators tended to move uniformly across the occupied zone (i.e., within eleven feet) towards the hood.

The most important findings were the following:

- Cross Drafts: Testing using displacement ventilation revealed that cross drafts were the condition that caused the greatest increase in exhaust flow rate, up to a 2750 cfm increase (141 percent) for two griddles during a cooking condition. Cross drafts affected the two griddles more than the two charbroilers.
- Side Panels: Side panels reduced the required exhaust flow rate to a greater degree for cross draft situations than without cross drafts, Similarly, side panels reduced the flow rate to a greater degree for charbroilers more than griddles. Partial side panels allowed a 1000 cfm reduction for the case of two charbroilers under a canopy hood with cross drafts. Full side panels on the proximity hood had a marginal effect on reducing the C&C flow rate below the exhaust rate required for operation with the integrated partial side panels
- Hood type: Using a proximity hood instead of a canopy hood over the same appliances reduced C&C rates by as much as 1150 cfm (60 percent) for the griddles and 2850 cfm (70 percent) for the charbroilers.

The findings led to the following observations:

- Hood Type: From a design viewpoint, the key difference between the proximity hood and the canopy hood appears to be that the hood intake area is closer to the appliances. This has the effect of reducing the area through which the replacement air flows. If a constant minimum velocity at the edge of the hood is required to contain the thermal plume, as the open area decreases so does the C&C exhaust flow rate.
- Side Panels: As a general observation, it seems that as the length of the side panel (along the lower edge) occupies less and less of the open perimeter, the opportunity to reduce the exhaust rate becomes less and less. Assuming a constant minimum velocity at the hood edge to capture and contain the thermal plume, as the hood-length increases, the 4-foot side panel (for example) closes off less and less of the open area. The open area is decreased to a greater extent with a shorter hood than a longer hood. This means that side panels yield diminishing returns in the reduction of C&C flow rates as hood length increases.

- Appliances: The griddles cooking were 2 to 3 times more sensitive to cross drafts than charbroilers cooking. We attribute this to the relatively greater strength of the thermal plume from the charbroilers compared to the griddles.

4.1.1 Test Setup

Figure 15 shows the displacement ventilation system. Aspirated temperature sensors suspended on floor stands are also shown in the photo. These were used to measure bulk air temperature as it approached the exhaust hood.



Figure 15: Floor Mounted Displacement Ventilators as Used for the Baseline Replacement Air Case

The exhaust-only canopy hood and proximity hoods were tested with the displacement ventilation system. Figure 16 is a cross section of the 8-foot long exhaust-only hood. The front lower edge of the hood was located at 78 inches above the finished floor. A 6-inch fascia was attached between the top of the hood and the suspended ceiling. The ceiling was located 108 inches above the floor.

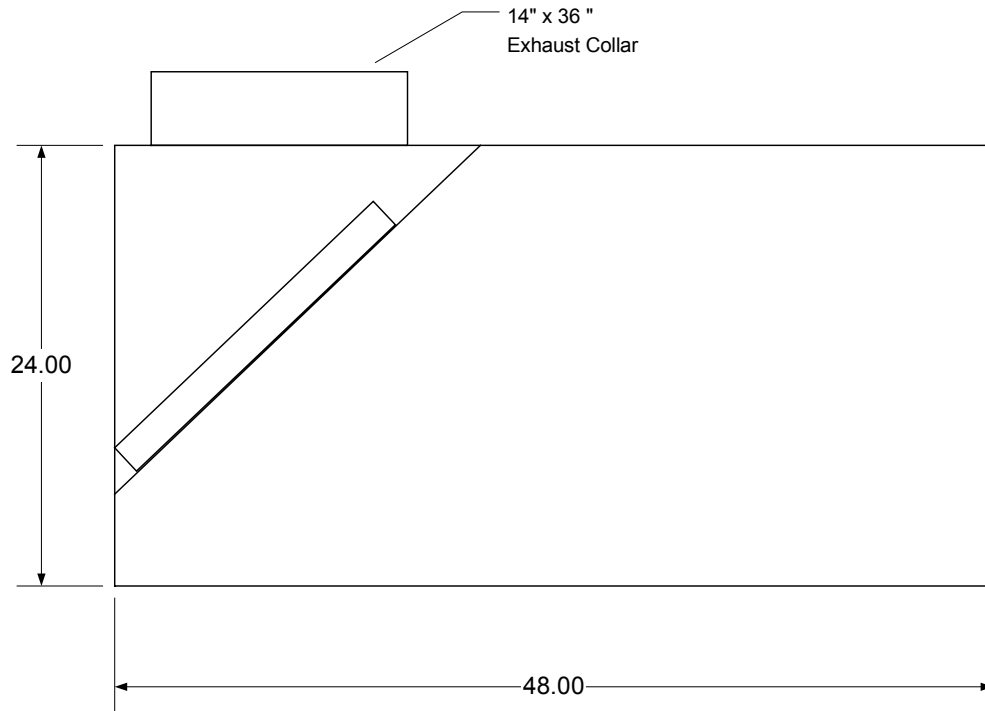

Figure 16: Cross-Section Drawing of the Exhaust Only Canopy Hood

Figure 17 shows the test set-up as viewed from the schlieren optical box.



Figure 17: Test Set-Up of the Exhaust Only Canopy Hood and Two Gas Griddles as Viewed from the Schlieren Optical Box

Figure 18 is from the same vantage point as in Figure 17, as viewed with the schlieren optical system during a condition of C&C with an exhaust flow rate of 2525 cfm.



Figure 18: Schlieren View of Exhaust Only Canopy Hood and Two Griddles Simulated Cooking at 2525 CFM Exhaust Flow Rate Showing C&C

Figure 19 shows a schlieren image of spillage of the thermal plume at 1850 cfm exhaust flow rate.

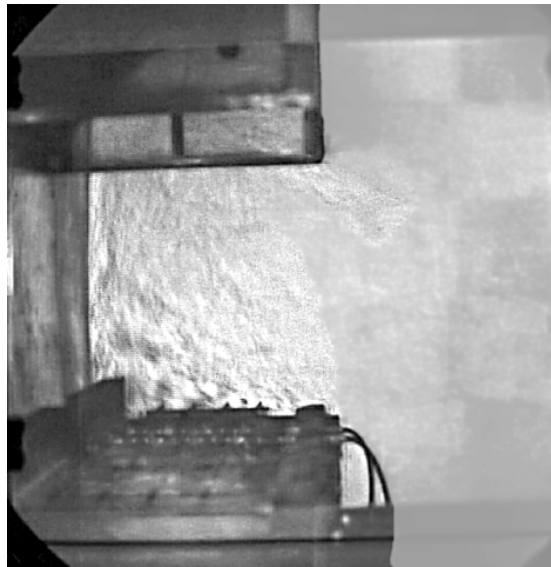

Figure 19: Schlieren View of Exhaust Only Canopy Hood and Two Griddles Simulated Cooking at 1850 CFM Exhaust Flow Rate Showing Spillage

Figure 20 is a cross section of the 86.5-inch (about 7.2 feet) long proximity hood used.

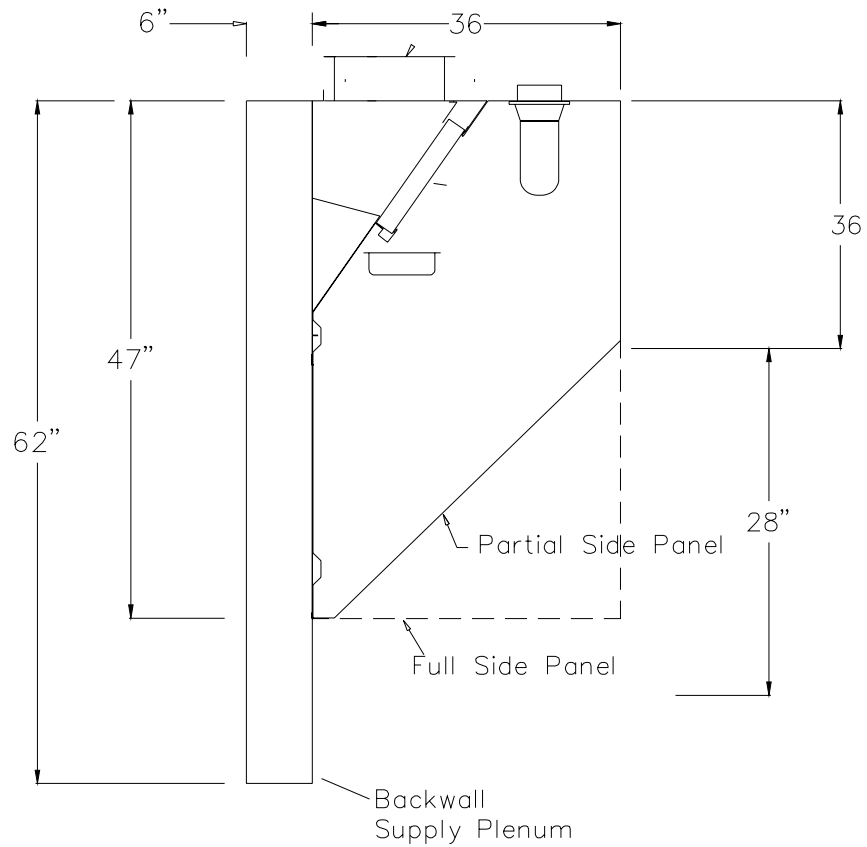

Figure 20: Cross-Section Drawing of Proximity Hood

The proximity hood was hung from the ceiling of the lab. The top of the hood was located at 90 inches above the finished floor. The ceiling was located 108 inches above the floor.

Figure 21 shows the test set-up as viewed from the schlieren optical box.



Figure 21: Test Set-Up of the Proximity Hood and Two Gas Griddles as Viewed from the Schlieren Optical Box

Figure 22 shows the same vantage point as Figure 21, as viewed with the schlieren system during a condition of C&C with an exhaust rate of 1250 cfm.



Figure 22: Schlieren View of a Proximity Hood and Two Charbroilers Simulated Cooking at 1250 CFM Exhaust Flow Rate Showing C&C

Figure 23 shows a schlieren image of spillage of the thermal plume at 1050 cfm exhaust flow rate.



Figure 23: Schlieren View of a Proximity Hood and Two Charbroilers with Simulated Cooking at 1050 CFM Exhaust Flow Rate Showing Spillage

4.1.2 Findings for Charbroilers

4.1.2.1 Charbroilers Idling

Figure 24 shows the results for two charbroilers in the idle condition.

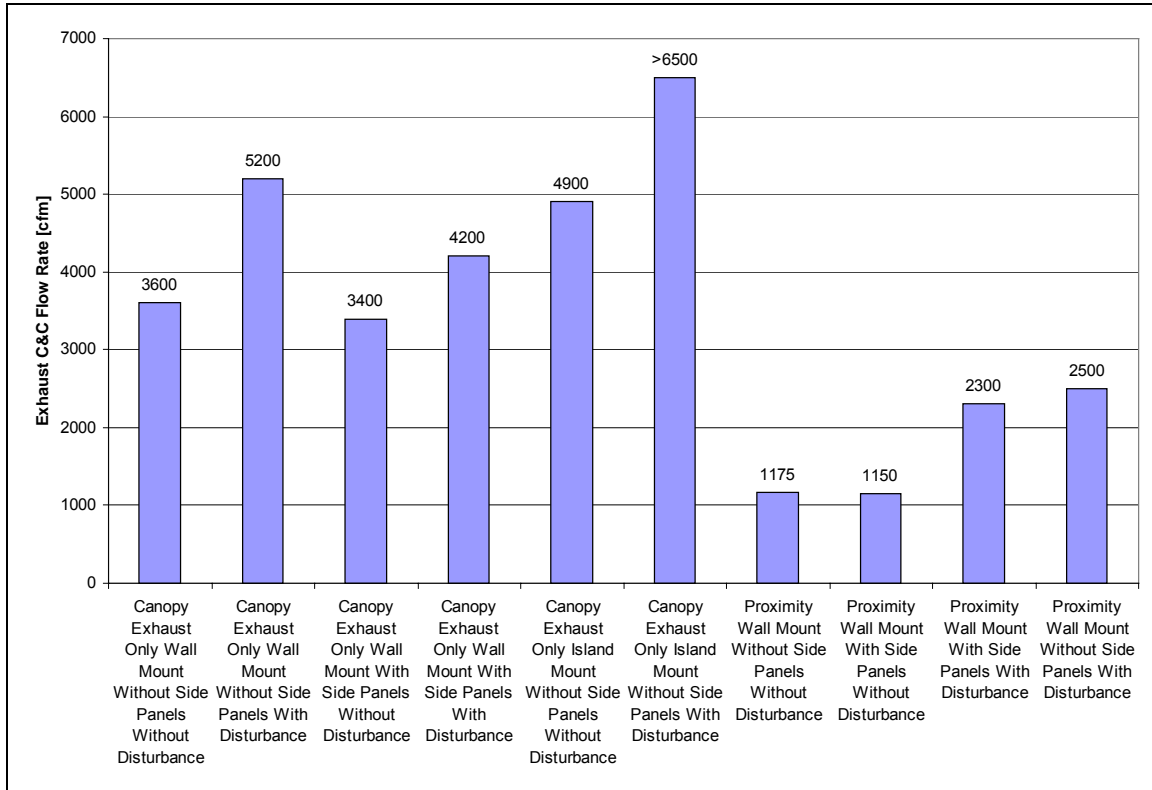

Figure 24: Exhaust C&C Flow Rates for Two Charbroilers during Idle Conditions and Replacement Air from Displacement Units

The wall-mounted canopy configuration required 3600 cfm when only displacement ventilation was used. When a cross draft was introduced, C&C was achieved with a 1600 cfm (44 percent) increase in exhaust from the base case (5200 cfm total). Adding side panels for the cross draft case saved 1000 cfm, a 19 percent reduction. Adding side panels for the base case (without a cross draft) saved 200 cfm (a six percent reduction).

The island-mounted canopy configuration required 4900 cfm when only displacement ventilation was used. When a cross draft was introduced, C&C could not be achieved within the lab's exhaust capacity for this test (> 6500 cfm or >33 percent increase). Side panels were not tested the island mount configuration.

The proximity hood configuration required 1175 cfm when only displacement ventilation was used. When a cross draft was introduced, C&C was achieved with a 1325 cfm (113 percent) increase in exhaust from the base case (2500 cfm total). Adding side panels for the cross draft case saved 200 cfm, an 8 percent reduction. Adding side panels for the base case (without a cross draft) saved 25 cfm (a two percent reduction).

To summarize base case conditions for broilers at idle conditions, the lowest exhaust airflow required for C&C was 1175 cfm using a proximity hood. The wall-mounted canopy hood required 3600 cfm, which was 2425 cfm higher (206 percent) than the proximity hood. The island-mounted canopy hood required the highest airflow rate of 4900 cfm, which was 3725 cfm (317 percent) greater than required by the proximity hood and 1300 cfm (36 percent) greater than the wall-mounted canopy hood.

4.1.2.2 Charbroilers Cooking

Figure 25 shows that during cooking using the two charbroilers, the C&C rates for the hoods tested were higher, but exhibited similar characteristics as in the idle condition.

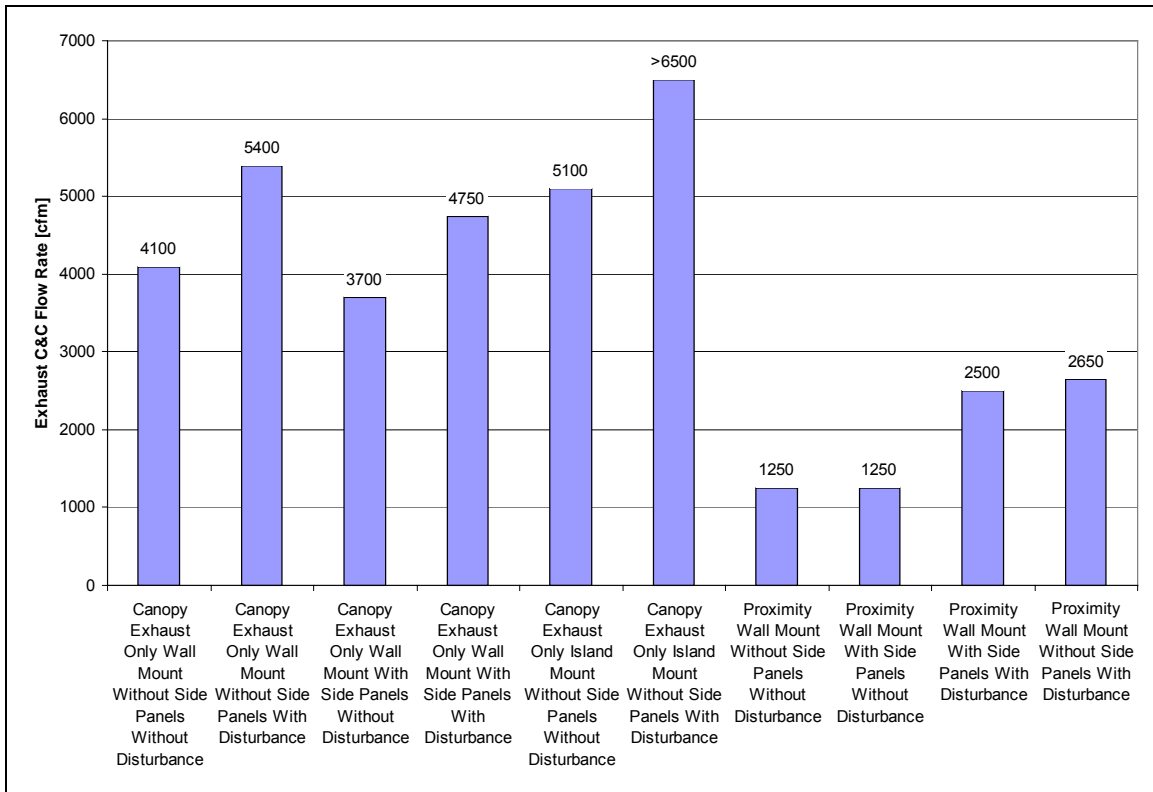

Figure 25: Exhaust C&C Flow Rates for Two Charbroilers during Cooking Conditions and Replacement Air from Displacement Units

The wall-mounted canopy configuration required 4100 cfm when only displacement ventilation was used. When a cross draft was introduced, C&C was achieved with a 1300 cfm (32 percent) increase in exhaust from the base case (5400 cfm total). Adding side panels for the cross draft case saved 650 cfm, a 12 percent reduction. Adding side panels for the base case (without a cross draft) saved 400 cfm (a ten percent reduction).

The island-mounted canopy configuration required 5100 cfm when only displacement ventilation was used. When a cross draft was introduced, C&C could not be achieved within the lab's exhaust capacity for this test (> 6500 cfm or >27 percent). Side panels were not tested the island mount configuration.

The proximity hood configuration required 1250 cfm when only displacement ventilation was used. When a cross draft was introduced, C&C was achieved with a 1400 cfm (112 percent) increase in exhaust from the base case (2650 cfm total). Adding side panels for the cross draft case saved 150 cfm, a six percent reduction. Adding side panels for the base case (without a cross draft) resulted in no change.

To summarize base case conditions for broilers at cooking conditions, the lowest exhaust airflow required for C&C was 1250 cfm using a proximity hood. The wall-mounted canopy hood required 4100 cfm, which was 2850 cfm higher (228 percent) than the proximity hood. The island-mounted canopy hood required the highest airflow rate of 5100 cfm, which was 3850 cfm (308 percent) greater than required by the proximity hood and 1000 cfm (24 percent) greater than the wall-mounted canopy hood.

4.1.3 Findings for Griddles

4.1.3.1 Griddles Idling

During idle conditions, two griddles exhibited similar characteristics within the conditions tested as the two-charbroilers, but some effects were magnified. See Figure 26.

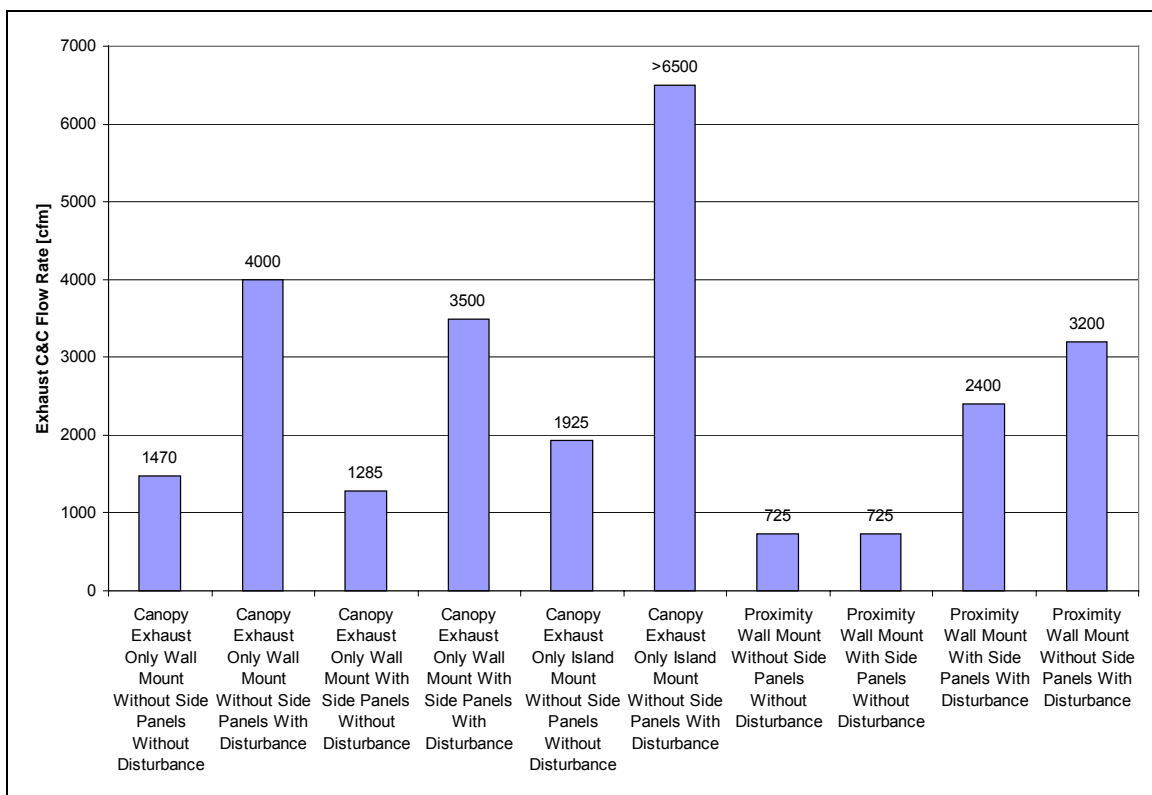

Figure 26: Exhaust C&C Flow Rates for Two Griddles during Idle Conditions and Replacement Air from Displacement Units

The wall-mounted canopy configuration required 1470 cfm when only displacement ventilation was used. When a cross draft was introduced, C&C was achieved with a 2530 cfm (172 percent) increase in MUA from the base case (4000 cfm total). Adding side panels for the cross draft case

saved 500 cfm, a 13 percent reduction. Adding side panels for the base case (without a cross draft) saved 185 cfm (a 13 percent reduction).

The island-mounted canopy configuration required 1925 cfm when only displacement ventilation was used. When a cross draft was introduced, C&C could not be achieved within the lab's exhaust capacity for this test (> 6500 cfm or >238 percent). Side panels were not tested the island mount configuration.

The proximity hood configuration required 725 cfm when only displacement ventilation was used. When a cross draft was introduced, C&C was achieved with a 2475 cfm (340 percent) increase in MUA from the base case (2475 cfm total). Adding side panels for the cross draft case saved 800 cfm, a 25 percent reduction. Adding side panels for the base case (without a cross draft) resulted in no change.

To summarize base case conditions for griddles at idle conditions, the lowest exhaust airflow required for C&C was 725 cfm using a proximity hood. The wall-mounted canopy hood required 1470 cfm, which was 745 cfm higher (103 percent) than the proximity hood. The island-mounted canopy hood required the highest airflow rate of 1900 cfm, which was 1175 cfm (162 percent) greater than required by the proximity hood and 430 cfm (59 percent) greater than the wall-mounted canopy hood.

4.1.3.2 Griddles Cooking

During cooking conditions with the medium duty griddles, the exhaust flow rates were similar to the idle condition although much higher than charbroiler cooking for the cross draft conditions. See Figure 27.

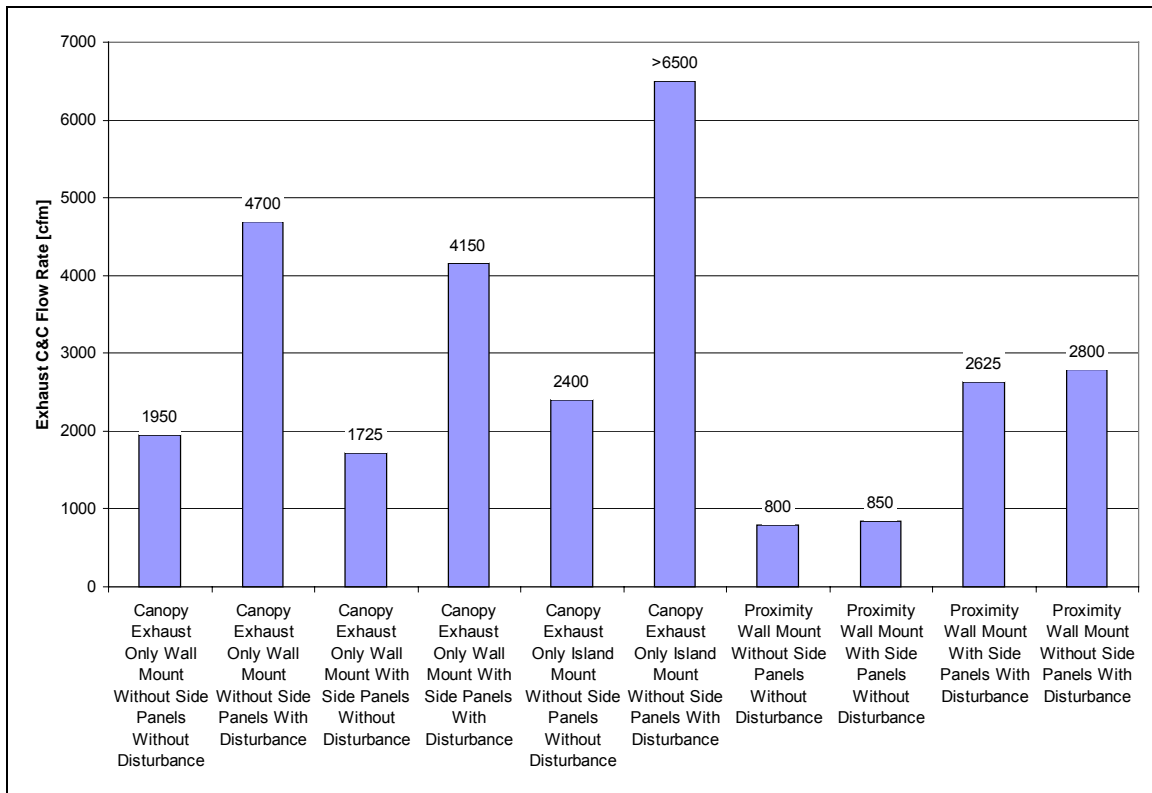

Figure 27: Exhaust C&C Flow Rates for Two Griddles During Cooking Conditions and Replacement Air from Displacement Units

The wall-mounted canopy configuration required 1950 cfm when only displacement ventilation was used. When a cross draft was introduced, C&C was achieved with a 2750 cfm (141 percent) increase in exhaust from the base case (4700 cfm total). Adding side panels for the cross draft case saved 550 cfm, a 12 percent reduction. Adding side panels for the base case (without a cross draft) saved 225 cfm (a 12 percent reduction).

The island-mounted canopy configuration required 2400 cfm when only displacement ventilation was used. When a cross draft was introduced, C&C could not be achieved within the lab's exhaust capacity for this test (> 6500 cfm or >171 percent). Side panels were not tested the island mount configuration.

The proximity hood configuration required 800 cfm when only displacement ventilation was used. When a cross draft was introduced, C&C was achieved with a 2000 cfm (250 percent) increase in exhaust from the base case (2800 cfm total). Adding side panels for the cross draft case saved 175 cfm, a 6 percent reduction. Adding side panels for the base case (without a cross draft) saved 50 cfm (a 6 percent reduction).

To summarize base case conditions for griddles at cooking conditions, the lowest exhaust airflow required for C&C was 800 cfm using a proximity hood. The wall-mounted canopy hood required 1950 cfm, which was 1150 cfm higher (144 percent) than the proximity hood. The island-mounted canopy hood required the highest airflow rate of 2400 cfm, which was 1600 cfm (200 percent) greater than required by the proximity hood and 450 cfm (24 percent) greater than the wall-mounted canopy hood.

4.2 Air Curtain Supply

One method of locally supplying MUA to a kitchen exhaust hood is through an air curtain, which is an arrangement of diffusers located on the front bottom edge of a canopy hood. The air curtain discharges MUA vertically along the front of the hood. A supply plenum typically is designed into the hood in front of the exhaust reservoir and is supplied with replacement air from the outside. The outside air is typically heated and not cooled. In mild climates, such as Los Angeles or San Diego, the outside air is not tempered (heated or cooled). In theory, the air curtain design should reduce operating cost by supplying the exhaust hood with outside air that is tempered less than fully conditioned MUA from the room. The location of the air curtain on the bottom edge of the hood and the discharge velocity of the MUA can have a significant influence on the C&C performance of the hood.

To evaluate a worst-case air curtain hood design, an exhaust-only canopy hood was fitted with a removable supply plenum with a slotted air curtain consisting of two 8 inch by 44 inch slotted registers. The louvers were adjusted to the wide-open position.

Testing revealed that if high percentages of air were supplied through the air curtain, performance was degraded, while relatively small percentages could be introduced with minimal impact on performance. The performance of the tested air curtain design was a function of the location and style of registers as well as the velocity (and hence the quantity) of MUA air discharged. The installation of side panels improved hood performance and had a negligible effect on the amount of air curtain supply that could be successfully introduced. While the side panels provide a positive effect on the exhaust rate required for capture and containment, they are not able to overcome the inherent problem of the effluent becoming entrained in the airflow from the air curtain, which spills into the kitchen.

4.2.1 Test Setup

The hood measured 2-feet high by 8-feet long by 4-feet deep. The exhaust collar measured 36-inches long by 14-inches deep. The exhaust traveled through 20-inch tall baffle filters along the length of the hood. Attached to the front face of the hood, the supply plenum measured 2-feet high by 8-feet long by 1-foot deep, with a centered supply collar measuring 8-inches in diameter. Figure 28 shows a cross section of the canopy hood with air curtain supply.

Figure 29 shows a photograph of the air curtain canopy hood over two charbroilers. The photograph illustrates the image a human eye would see with the two broilers idling at an average cooking surface temperature of 600°F. The filter side of the hood is against a clear plastic backwall, and the front lower edge is located 78-inches above the finished floor. A sheet metal insert is between the two charbroilers to prevent drafts between the two appliances. The appliances were positioned with a 6-inch side overhang at the ends and front of the hood.

Figure 30 and Figure 31 are schlieren images of the two broilers under the air curtain equipped canopy hood. In Figure 30 the hood is exhausting 4100 cfm with 250 cfm (6 percent) being supplied to the air curtain. The plume is completely captured and contained within the hood, showing acceptable hood performance. Figure 31 shows spillage when the exhaust rate was held constant and MUA supplied through the curtain was increased to 1200 cfm (29 percent).

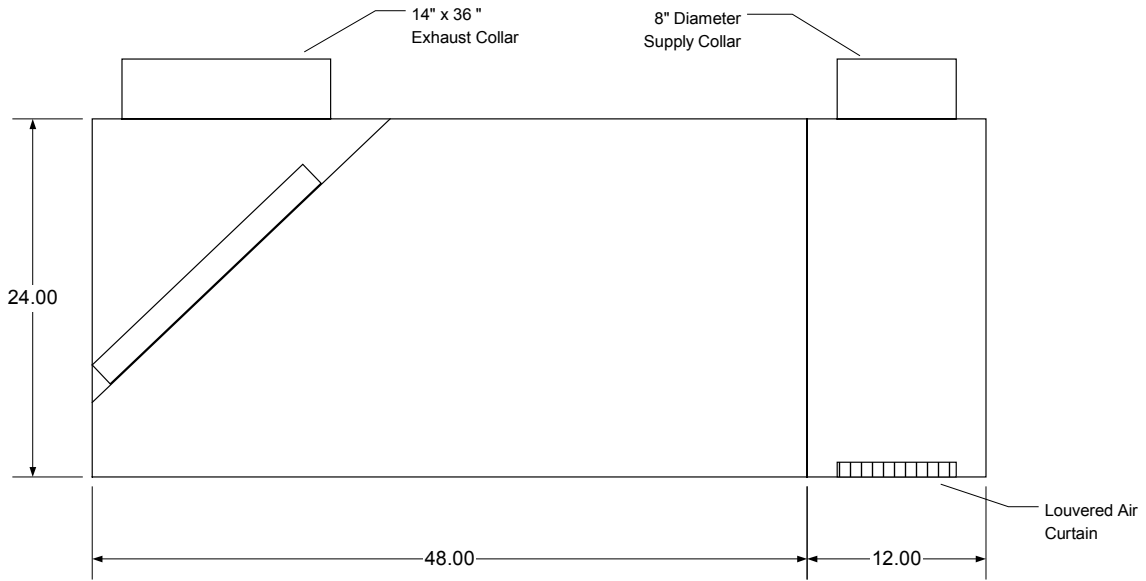

Figure 28: Cross-Section Drawing of the Wall Mounted Air Curtain Canopy Hood.



Figure 29: View of Two Charbroilers under a Wall Mounted Air Curtain Canopy Hood from the Perspective of the Schlieren System

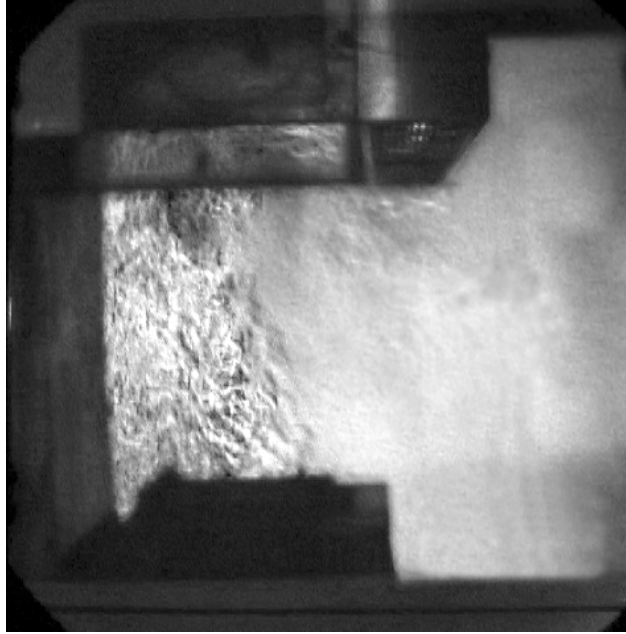

Figure 30: Schlieren Image of a Wall Mounted Air Curtain Canopy Hood with Two Broilers Simulating Cooking Showing C&C at an Exhaust Rate of 4100 cfm with 250 cfm (6 percent) MUA Through the Air Curtain Supply

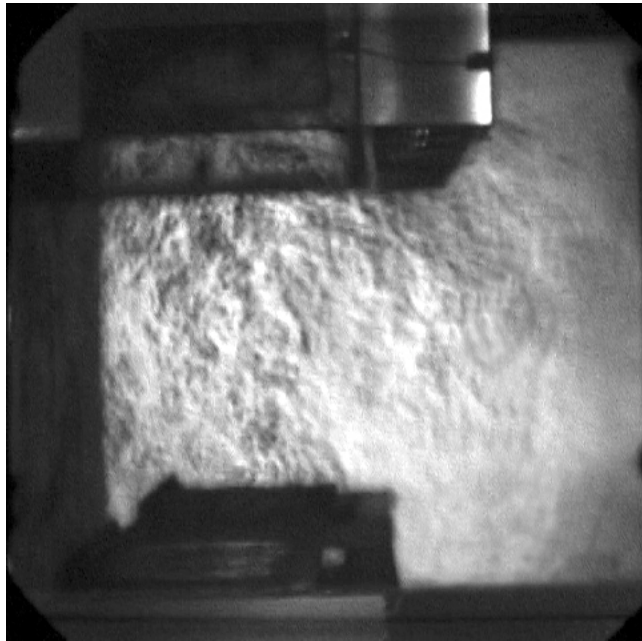

Figure 31: Schlieren Image of Wall Mounted Air Curtain Canopy Hood Showing Spillage at 4100 cfm Exhaust with 1200 cfm (29 percent) Air Curtain Supply over Two Broilers with Simulated Cooking

4.2.2 Findings for Charbroilers

4.2.2.1 Charbroilers Idling

Figure 32 shows C&C rates for two gas charbroilers idling under the air curtain canopy hood. In the wall-mounted configuration, the minimum exhaust rate was 3600 cfm when displacement ventilation was used. At this exhaust rate, the MUA could be increased to 200 cfm (6 percent) while maintaining acceptable performance. With a constant cross draft, C&C was attained with a 1600 cfm (44 percent) increase to 5200 cfm with 300 cfm (6 percent) supplied to the air curtain.

Adding side panels resulted in a 200 cfm reduction in required exhaust flow from 3600 cfm to 3400 cfm, while allowing 300 cfm of air curtain supplied air. A constant cross draft required a 4200 cfm exhaust rate, with 200 cfm of air supplied by the air curtain.

The island configuration required an exhaust rate of 4900 cfm while allowing 250 cfm of air curtain supplied air. When the cross draft was added, C&C of the plume was not possible at any exhaust or air curtain airflow rates possible in the laboratory.

Comparing canopy hood configurations over two idling gas charbroilers, the wall-mounted canopy hood with side panels required the least amount of exhaust flow while maintaining proper C&C performance. The worst case was the island configuration, which required an additional 1500 cfm with all MUA supplied via displacement diffuser (essentially emulating perfect conditions), and failed to perform properly with up to 2300 cfm (64 percent) of additional exhaust flow when a cross draft was present.

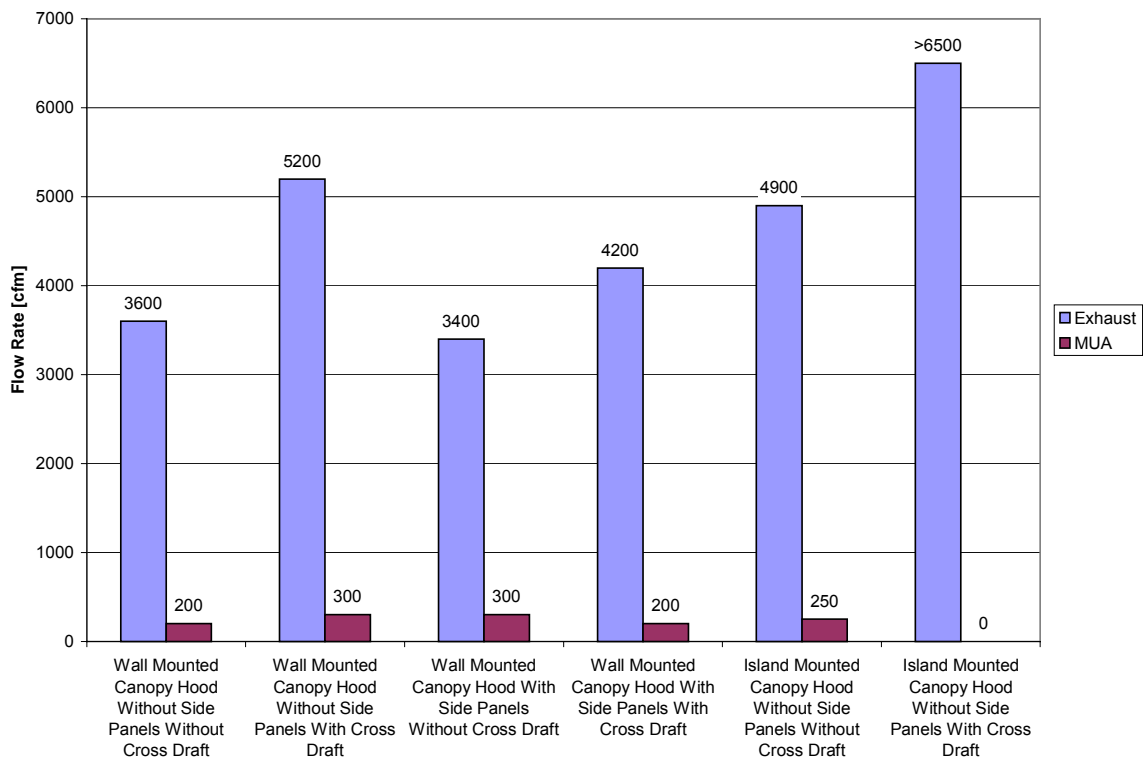

Figure 32: Side Panel Comparison of Two Charbroilers Idling under an Air Curtain Canopy Hood

4.2.2.2 Charbroilers Cooking

Figure 33 shows C&C rates for two gas charbroilers cooking under the air curtain canopy hood. In the wall-mounted configuration, the minimum exhaust rate was 4100 cfm with displacement ventilation. At this exhaust rate, the MUA could be increased to 250 cfm (6 percent) while maintaining acceptable performance. When a cross draft was present, C&C was attained with a 1300 cfm increase (32 percent) to 5400 cfm with the elimination of air supplied to the air curtain.

Adding side panels resulted in a 400 cfm (10 percent) reduction in required exhaust flow from 4100 to 3700 cfm, while allowing 250 cfm of air curtain supplied air. A constant cross draft required an increase of 1300 cfm (32 percent) above the baseline airflow rate to 5400 cfm, with the air supplied by the air curtain reduced to zero.

The island configuration required an exhaust rate of 5100 cfm while allowing 250 cfm of air supplied by the air curtain. When the cross draft was added, C&C of the plume was not possible at any exhaust or air curtain airflow rates possible in the laboratory.

Comparing canopy hood configurations over two gas charbroilers cooking, the wall-mounted canopy hood with side panels required the least amount of exhaust flow while maintaining proper C&C performance. The worst case was the island configuration, which required an additional 1400 cfm (38 percent) with all MUA supplied via displacement diffuser (essentially emulating perfect conditions), and failed to perform properly with up to 1400 cfm (27 percent) of additional exhaust flow when a cross draft was present.

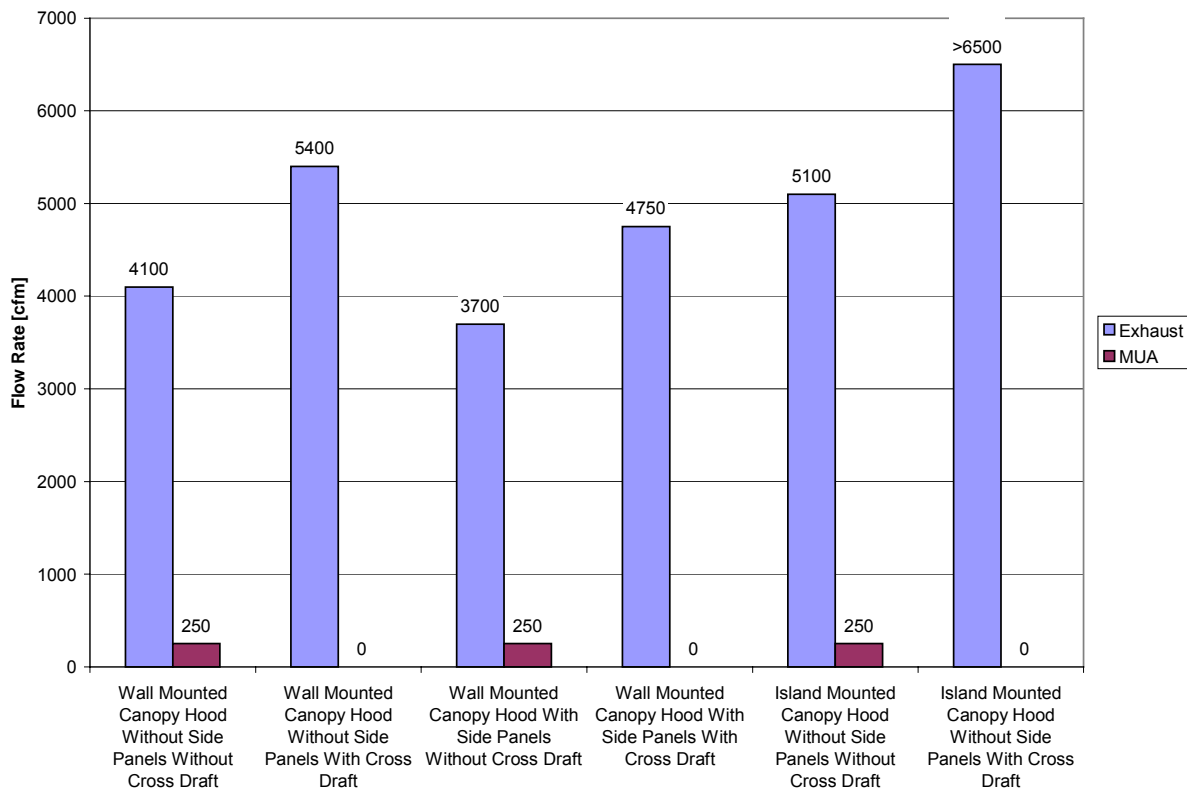

Figure 33: Side Panel Comparison of Two Charbroilers Cooking under an Air Curtain Canopy Hood

4.2.3 Findings for Griddles

4.2.3.1 Griddles Idling

Figure 34 shows C&C rates for two idling gas griddles under the air curtain canopy hood. In the wall-mounted configuration, the minimum exhaust rate was 1475 cfm with displacement ventilation. At this exhaust rate, the MUA could be increased to 700 cfm (47 percent) while maintaining acceptable performance. With a constant cross draft, C&C was achieved by increasing the exhaust rate by 2525 cfm (171 percent) to 4000 cfm and eliminating the air curtain supplied air.

Adding side panels resulted in a 200 cfm reduction in required exhaust flow from 1475 cfm to 1275 cfm, while allowing 250 cfm of air curtain supplied air. A constant cross draft required an increase of 2025 cfm (137 percent) to a 3500 cfm exhaust rate and the elimination of the air supplied by the air curtain.

The island configuration required an exhaust rate of 1975 cfm while allowing 200 cfm of air supplied by the air curtain. When the cross draft was added, C&C of the plume was not possible at any exhaust or air curtain airflow rates possible in the laboratory.

Comparing hood configurations over two idling griddles, the wall-mounted canopy hood with side panels required the least amount of exhaust flow while maintaining proper C&C performance. The worst case was the island configuration, which required an additional 700 cfm with all MUA supplied via displacement diffuser (essentially emulating perfect conditions), and failed to perform properly when a cross draft was present.

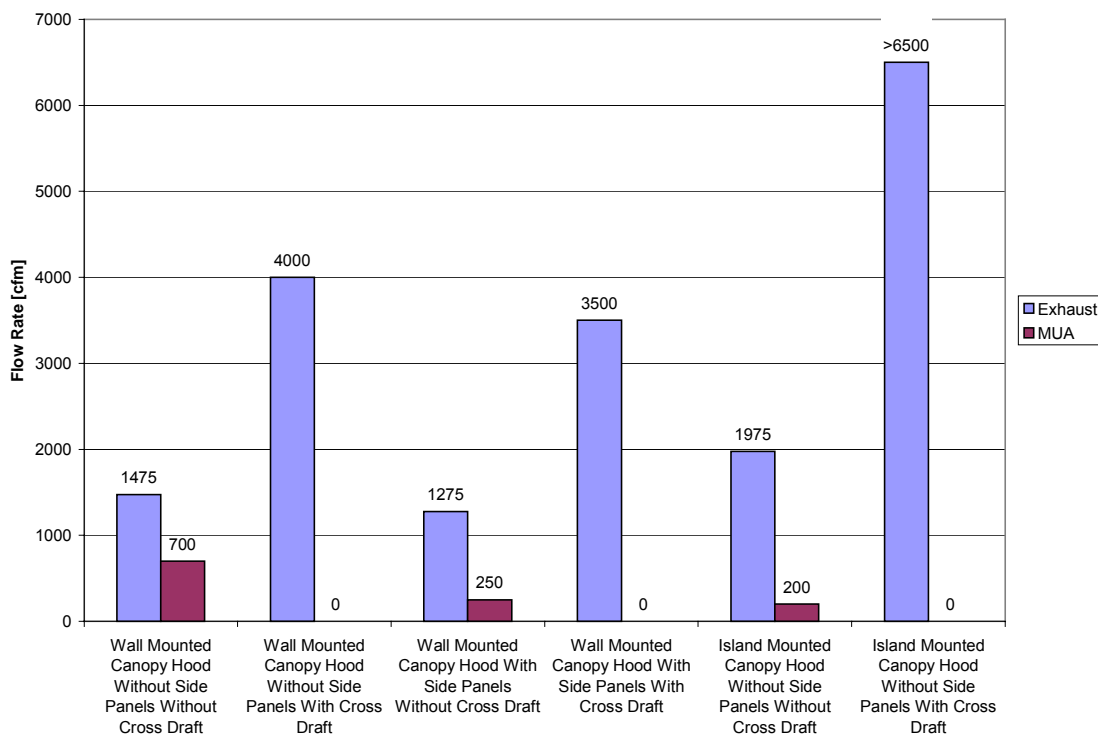

Figure 34: Side Panel Comparison of Two Griddles Idling under an Air Curtain Canopy Hood

4.2.3.2 Griddles Cooking

Figure 35 shows C&C rates for two gas griddles cooking under the air curtain canopy hood. In the wall-mounted configuration, the minimum exhaust rate was 1950 cfm with displacement ventilation. At this exhaust rate, the MUA could be increased to 200 cfm (10 percent) while maintaining acceptable performance. With a constant cross draft, C&C could not be obtained at any exhaust rate, up to and including the maximum 6300 cfm available.

Adding side panels without a cross draft condition resulted in a 225 cfm (12 percent) reduction in required exhaust flow from 1950 cfm to 1725 cfm, while allowing 150 cfm of air supplied by the air curtain. A constant cross draft required a 4150 cfm exhaust rate, with 150 cfm of air supplied by the air curtain.

The island configuration required an exhaust rate of 4150 cfm while allowing 250 cfm of air curtain supplied air. When the cross draft was added, C&C of the plume was not possible at any exhaust or air curtain airflow rates possible in the laboratory.

Comparing canopy hood configurations over two gas griddles while cooking, the wall-mounted canopy hood with side panels required the least amount of exhaust flow while maintaining proper C&C performance. The worst case was the island configuration, which required an additional 675 cfm (35 percent) with all MUA supplied via displacement diffuser (essentially emulating perfect conditions), and failed to perform properly when a cross draft was present.

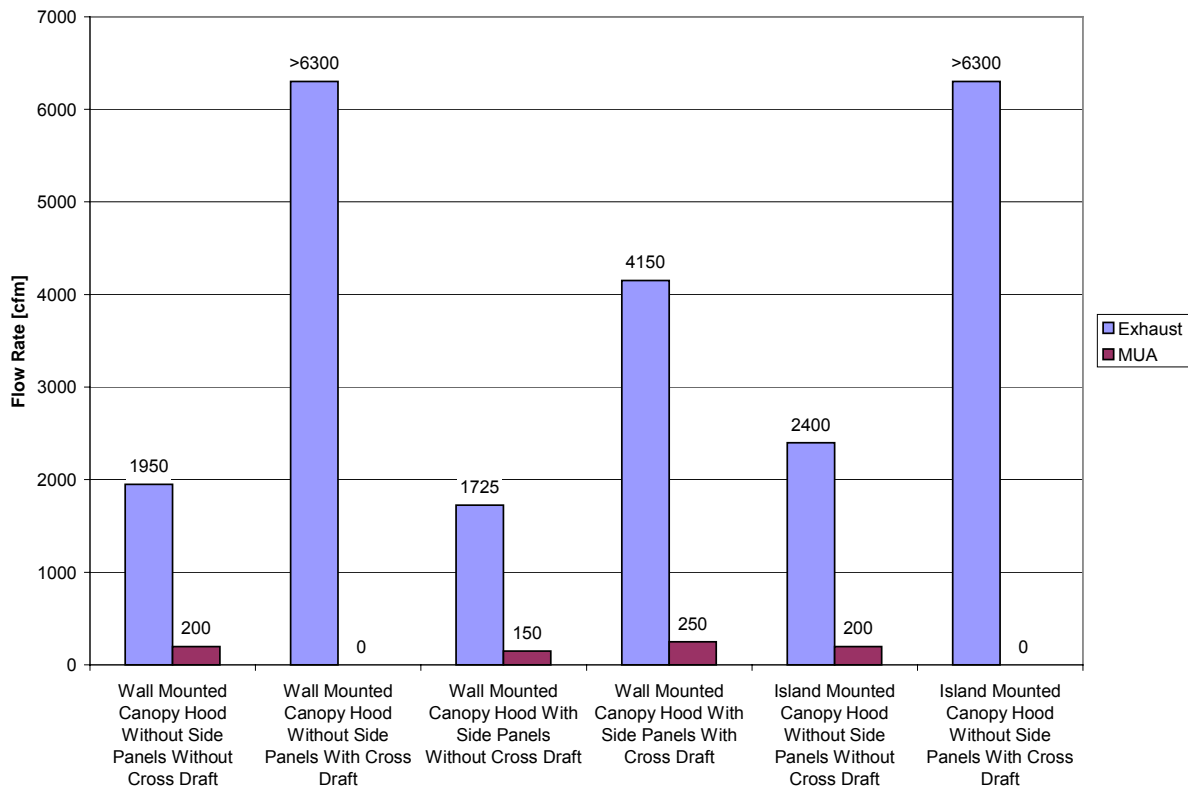

Figure 35: Side Panel Comparison of Two Griddles Cooking under an Air Curtain Canopy Hood

4.2.4 Air Curtain Sensitivity Analysis

A test was performed to evaluate the effect of increasing the supply rate to the air curtain. First, C&C was achieved while using displacement ventilation. Then, the air curtain airflow was increased until the maximum air curtain rate was achieved while maintaining proper hood performance. Next, the air curtain was increased to 25 percent of the exhaust rate that was established for the displacement ventilation case. Finally, the exhaust was increased to achieve proper C&C at the higher air curtain flow rate.

In all configurations, the percentage of MUA allowed before the exhaust increase was approximately 10 percent. After the MUA adjustment to 25 percent, the exhaust flow needed to be increased for proper plume C&C. When calculated, the air curtain percentage was again approximately 10 percent of the new exhaust rate. The island configuration was the exception; C&C of the plume could not be achieved at the laboratory's maximum exhaust flow rate. Figure 36 shows the results graphically.

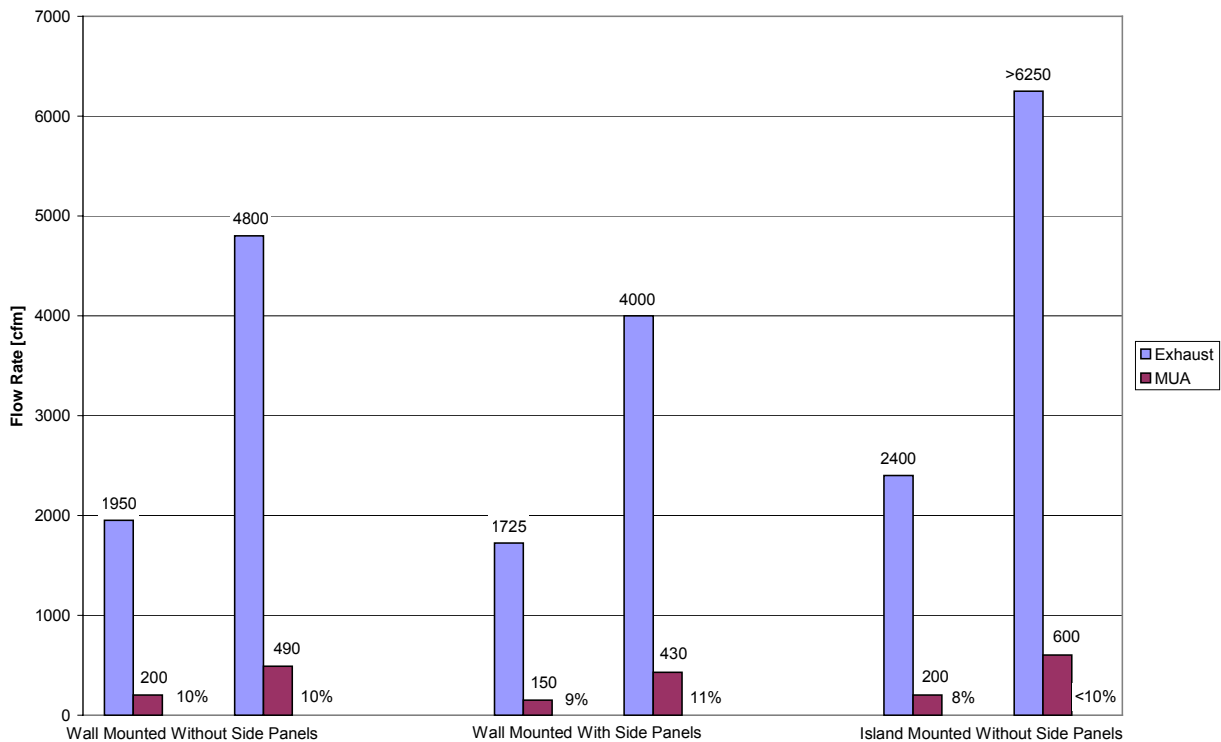

Figure 36: Summary of Successful Air Curtain MUA Percentage for Two Griddles Cooking under an Air Curtain Canopy Hood

The exhaust to local MUA ratio was calculated for the air curtain supply. Increasing makeup supply through the air curtain showed no effect on hood performance up to 200 cfm. At 490 cfm through the air curtain, the discharge angle of the jet and increased air speed entrained the thermal plume at the hood's lower edge. This led to higher requirements in exhaust flow rate for every cfm brought in through the air curtain. The exhaust flow rate to local MUA ratio was 9.83; or for every one cfm of MUA introduced, the exhaust flow rate had to increase 9.83 cfm. The ratio is shown graphically in Figure 37.

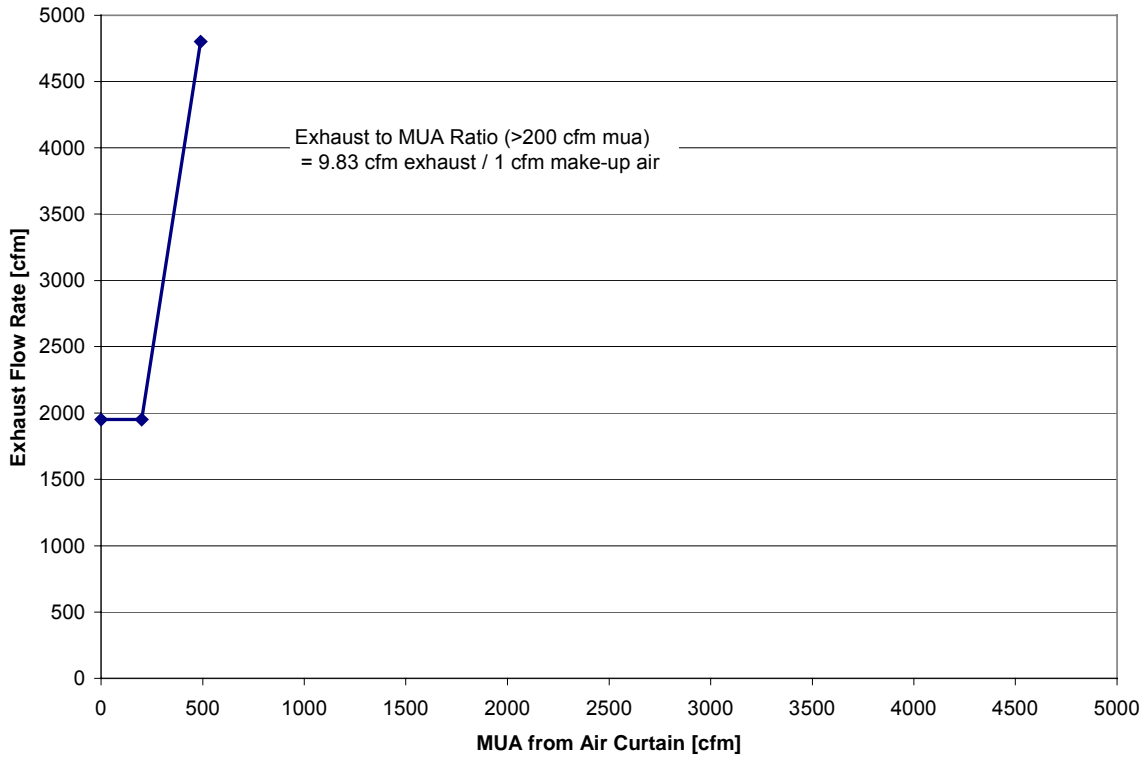

Figure 37: The Amount of Exhaust Air Required as a Function of the Amount of Air Brought in Through the Air Curtain Supply

4.3 Front Face Supply

The introduction of replacement air from the front vertical face of a canopy hood is known as front face supply. A supply plenum typically is designed into the hood in front of the exhaust plenum and is supplied with replacement air from the outside. The outside air is typically heated, and not cooled. In mild climates, such as Los Angeles or San Diego, the outside air is not heated or cooled. The front face plenum is designed to discharge the air horizontally (as opposed to the air curtain, which discharges vertically). There are two common styles of front face apertures: (1) louvers and (2) perforated plate. Louvers direct the air at higher velocities 6 to 12 feet into the kitchen space, usually near the ceiling level, which causes the replacement air to mix with air supplied by the kitchen HVAC system or air transferred from adjacent zones. A perforated front face is designed to reduce the discharge velocity and use a “lazy” flow to direct the supply air to the exhaust plenum with minimal mixing. There are also styles that combine the air curtain and front face design to give the operator limited control over the airflow direction.

The testing results show that the front face supply hood performance is very sensitive to the supply discharge angle from the front face. In the same way that a horizontal discharge positioned too close to the lower edge of the hood can entrain and pull out the effluent plume, the discharge angle from the front face diffuser that is close to vertical can create the same phenomenon. Therefore, at low discharge velocities, and consequently low flows, effluent was pulled out of the hood reservoir.

The performance of the front face supply hood is dependent on the amount, direction, and velocity of the airflow from the front face supply. The front face supply plenum used in the testing allowed the appliances’ thermal plumes to be entrained by the airflow from the front face because the discharge angle was very steep (i.e., close to the vertical).

A change in the internal design of the front face supply plenum improved discharge velocity uniformity and hood performance. The change in hood performance can be seen in the amount of exhaust airflow required for an amount of makeup airflow introduced. The exhaust to local MUA ratio was improved from 1.73 to 0.81 when an internal baffle was added to the MUA plenum design. This represents a 53 percent improvement.

The testing showed that the C&C performance of the hood was adversely affected by the direction of the front face supply air. The internal design of front face plenums can result in a variety of discharge velocity profiles. The closer the MUA is discharged to the lower edge of the hood, the greater the effect. The closer the MUA is discharged to vertically downward, the greater the impact on hood performance.

4.3.1 Test Setup

The front face supply unit tested consisted of an exhaust-only hood with a removable supply plenum. The supply plenum, designed and fabricated for this research project to represent a generic supply plenum, included a louvered air curtain and perforated front face supply. For the front face testing, the louvered air curtain was blanked off. There were no baffling or perforated screens internal to the supply plenum. Figure 38 shows a cross section of the hood used.

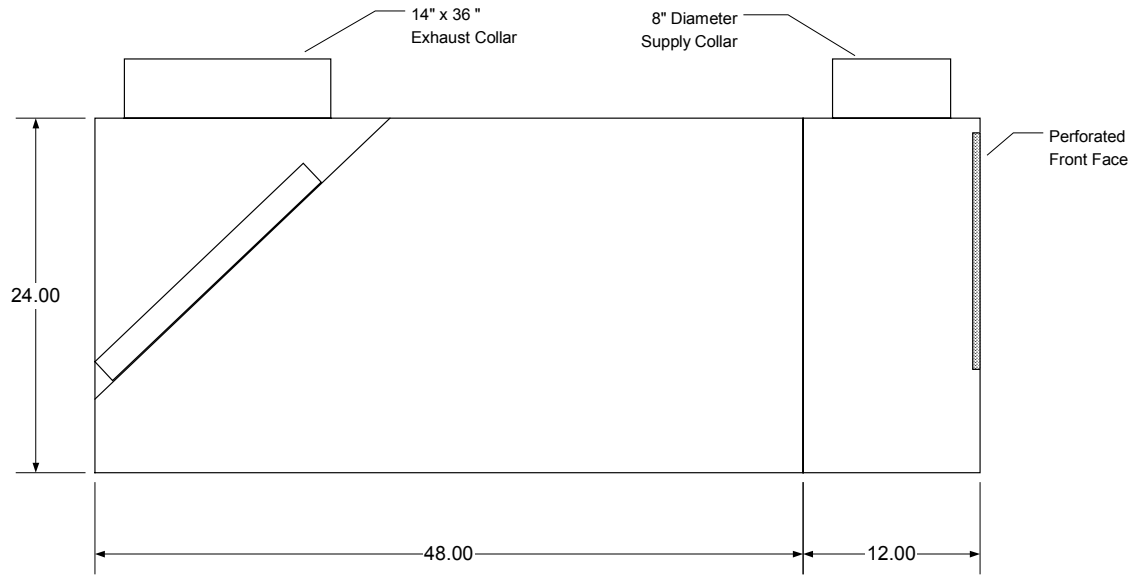

Figure 38: Cross-Section Drawing of Front Face Plenum and Canopy Hood

Figure 39 shows the test set-up as viewed from the schlieren optical box.



Figure 39: Test Set-Up of the Front Face Supply Hood and Two Gas Charbroilers as Viewed from the Schlieren Optical Box

Figure 40 shows the same vantage point as Figure 39 above, as viewed with the schlieren system. It is a photo of the thermal plume from the appliances idling during a condition of C&C with an exhaust rate of 3600 cfm and 300 cfm discharging from the front face.

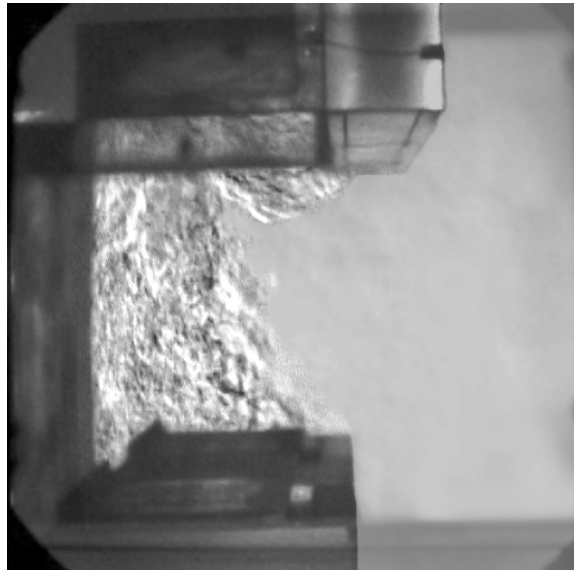

Figure 40: Schlieren View of C&C of the Thermal Plume from Two Charbroilers Idling at 3600 CFM Exhaust and 300 CFM Front Face Airflow Rates

Figure 41 shows a schlieren image of spillage of the thermal plume at 3600 cfm exhaust and 1200 front face supply airflow rates. At high discharge rates the thermal plume is pulled from the front lower edge of the hood. The as-designed plenum created a discharge flow from the front face plenum that is nearly parallel to the front face rather than perpendicular, which is desired design condition.

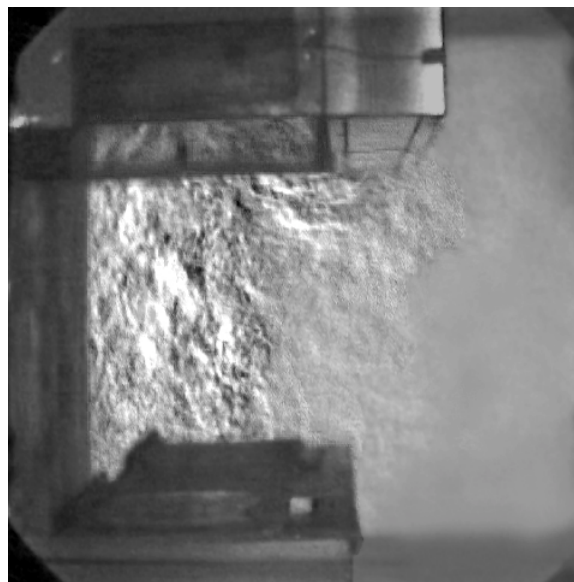

Figure 41: Schlieren View of Spillage of the Thermal Plume from Two Charbroilers Idling at 3600 CFM Exhaust and 1200 CFM Front Face Airflow Rates

4.3.2 Findings for Charbroilers

Figure 42 shows the results for two charbroilers in the idle condition.

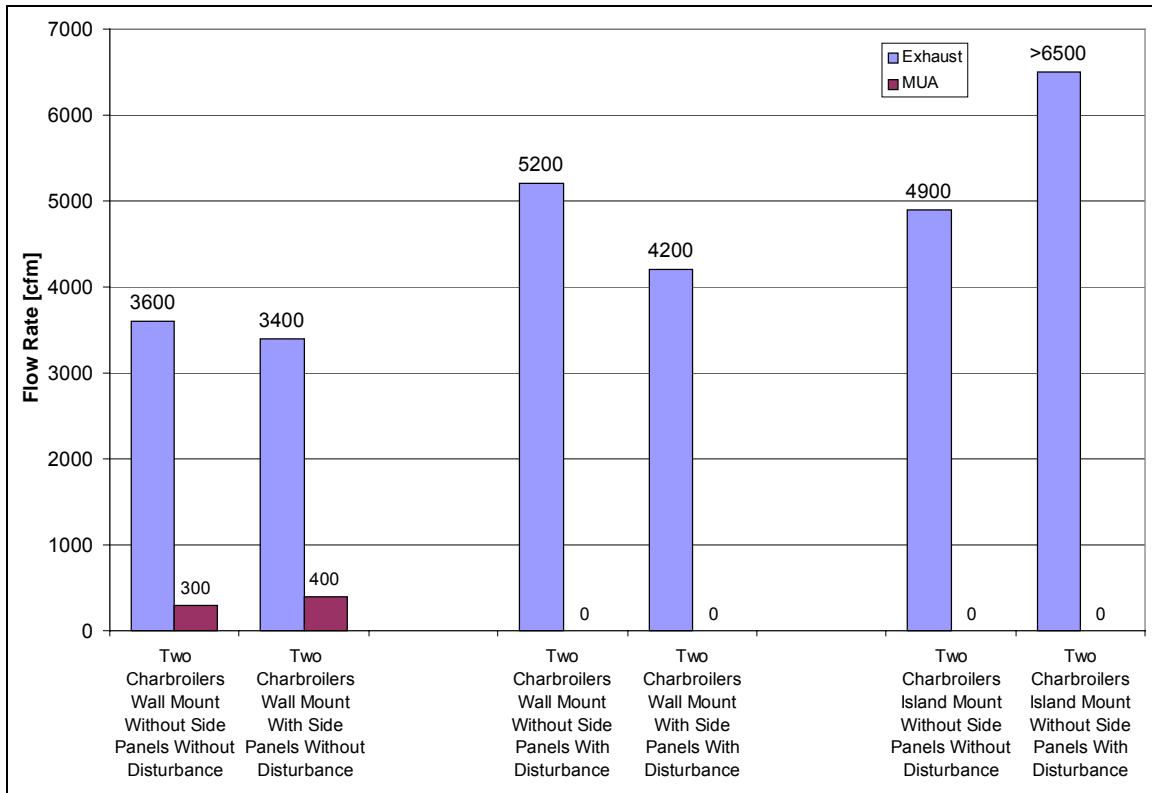

Figure 42: Exhaust and Front Face Flow Rates for the Two Charbroilers during Idle Conditions

4.3.2.1 Charbroilers Idling

During idle conditions with all replacement air supplied from the displacement diffusers, the wall-mounted hood without side panels required an exhaust rate of 3600 cfm. A maximum of 300 cfm (8 percent) could be introduced from the front face before it would disturb and start spilling the thermal plume. The addition of side panels allowed the replacement air from the displacement diffusers to be reduced to 3400 cfm. With the side panels, a maximum of 400 cfm could be introduced through the front face before the thermal plume would spill.

When a cross draft was added to the test set-up, during the condition without side panels, an additional 1600 cfm (44 percent) was required to capture and contain the thermal plume (5200 cfm total exhaust rate). Any additional air from the front face caused spillage. In the test case with side panels and a cross draft, an additional 800 cfm was required to capture and contain the thermal plume (4200 cfm total exhaust rate).

For the island-mounted hood configuration, without side panels and a cross draft, the exhaust flow rate was in excess of 6500 cfm and the thermal plume could not be contained with the capacity available from the lab's exhaust system. However, the same island test setup without a

cross draft required 4900 cfm exhaust flow rate, which is 1300 cfm (36 percent) above the displacement exhaust rate for the wall mounted canopy hood.

During cooking conditions for two charbroilers, the results were similar to the idle conditions (Figure 43).

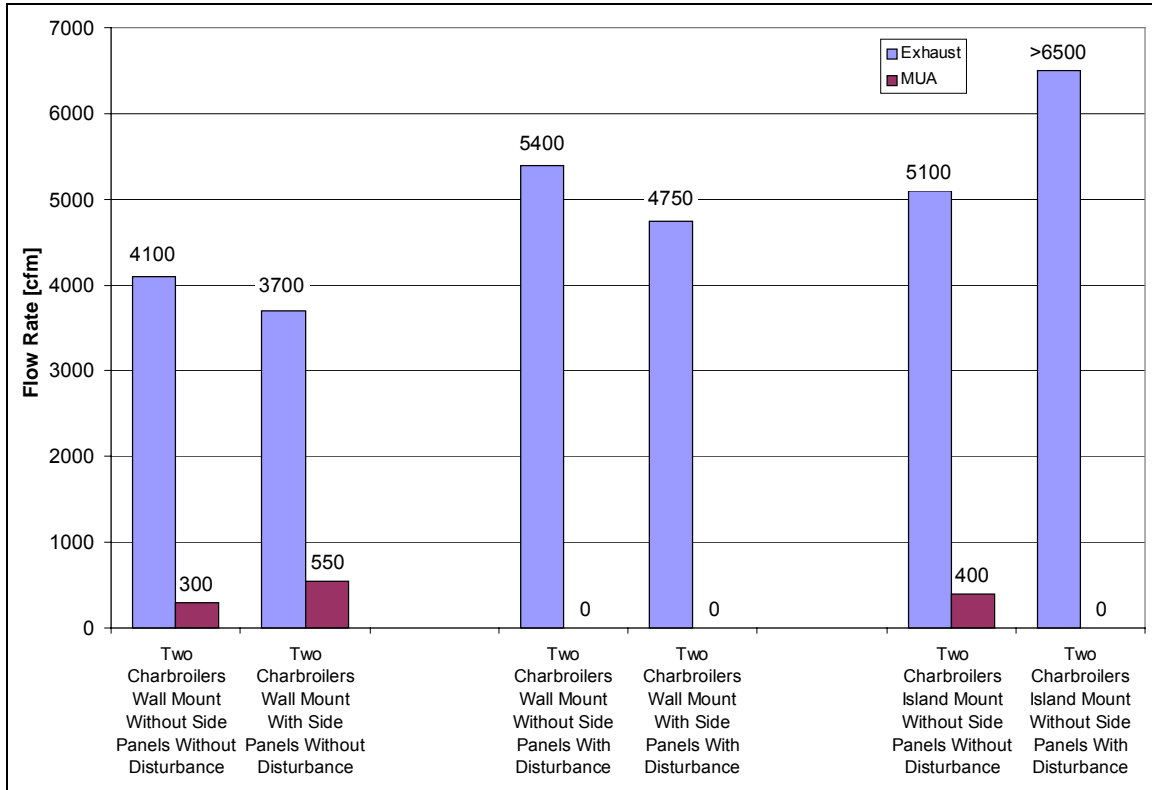

Figure 43: Exhaust and Front Face Flow Rates for the Two Charbroilers during Cooking Conditions

4.3.2.2 Charbroilers Cooking

Side panels decreased the effect of cross drafts for the wall mounted canopy hood, and the island mounted configuration performed worse than wall mounted. The lab’s exhaust fan, operating at 6500 cfm, was not able to capture and contain the thermal plume in the island case with cross drafts.

The influence of the stronger thermal plume from cooking versus idle can be seen by comparing Figures Figure 42 and Figure 43. In the wall mounted canopy hood tests without cross drafts and without side panels, an equal amount of front face air could be introduced during cooking conditions as in the idle case (i.e., 300 cfm). For the tests with side panels, the cooking condition allowed 150 cfm more through the front face diffuser than in the idle case (550 cfm during cooking versus 400 cfm during idle).

The influence of the stronger thermal plume can also be seen in the island case. During cooking conditions with displacement MUA, side panels, and no cross draft, C&C was achieved with an exhaust rate of 5100 cfm and with as much as 400 cfm brought through the front face. During

idle conditions with the same test configuration, C&C required 4900 cfm of exhaust, but no air could be brought through the front face. For the case with a cross draft during cooking and idling conditions, and with and without side panels, no amount of front face supply air could be introduced without spilling the thermal plume while exhausting at displacement ventilation rates.

4.3.3 Findings for Griddles

During idle conditions, two griddles exhibited similar characteristics in as the two-charbroiler conditions (Figure 44).

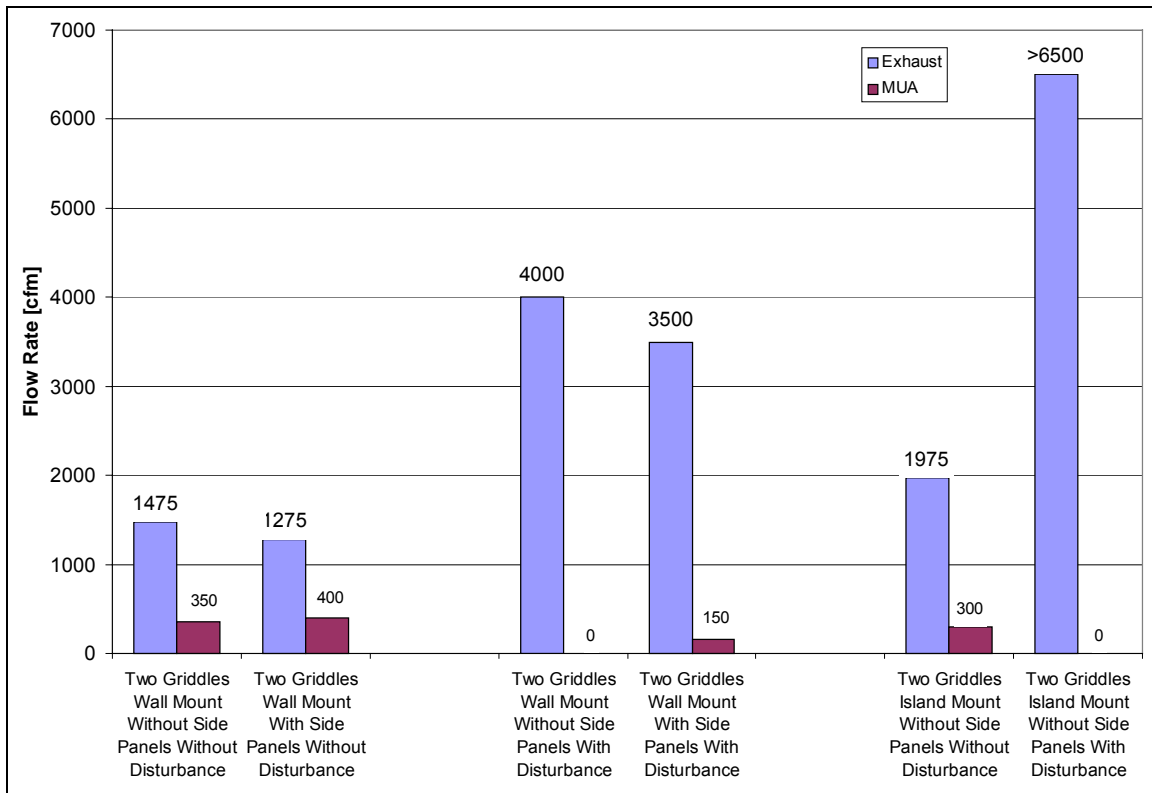

Figure 44: Exhaust and Front Face Flow Rates for the Two Griddles during Idle Conditions

4.3.3.1 Griddles Idling

During idle conditions under a wall mounted hood without a cross draft present, the amount of air from the front face was similar for the griddles (medium duty appliances) and the charbroilers (heavy-duty appliances). Without side panels installed, the front face could supply 300 cfm for the two charbroilers and 350 cfm for the two griddles. For the case with side panels, 550 cfm could be supplied for the two charbroilers and 400 cfm for the two griddles.

The MUA as a percentage of the exhaust is greater for the griddles because the C&C exhaust rate is lower for these medium duty appliances. For the case without side panels, 24 percent of the displacement exhaust flow rate could be introduced from the front face without causing a spill condition for the two griddles, whereas only 8 percent could be introduced for the two charbroilers. For the case with side panels, 31 percent of the displacement exhaust flow rate

could be introduced from the front face without causing a spill condition for the two griddles, whereas only 12 percent could be introduced for the two charbroilers.

For the cases with cross drafts, there was no amount of air that could be introduced from the front face without causing the thermal plume to spill at the exhaust rate required for displacement ventilation. In the case with side panels, 150 cfm could be introduced from the front face without causing spillage at the displacement exhaust rate of 3500 cfm.

For the island mounted configuration without cross drafts, up to 300 cfm could be introduced from the front face without causing spilling. However, the thermal plume in the case of island-mounted configuration with cross drafts could not be captured and contained with the capacity of the lab's exhaust system.

4.3.3.2 Griddles Cooking

Figure 45 shows results for griddles during cooking conditions. Comparing Figure 44 and Figure 45 and, the exhaust flow rates were higher for cooking than for idle, although the amount of air through the front face was similar. The front face was able to supply 200 cfm during cooking versus 350 during idle without side panels and 430 cfm during cooking versus 400 during idle without side panels.

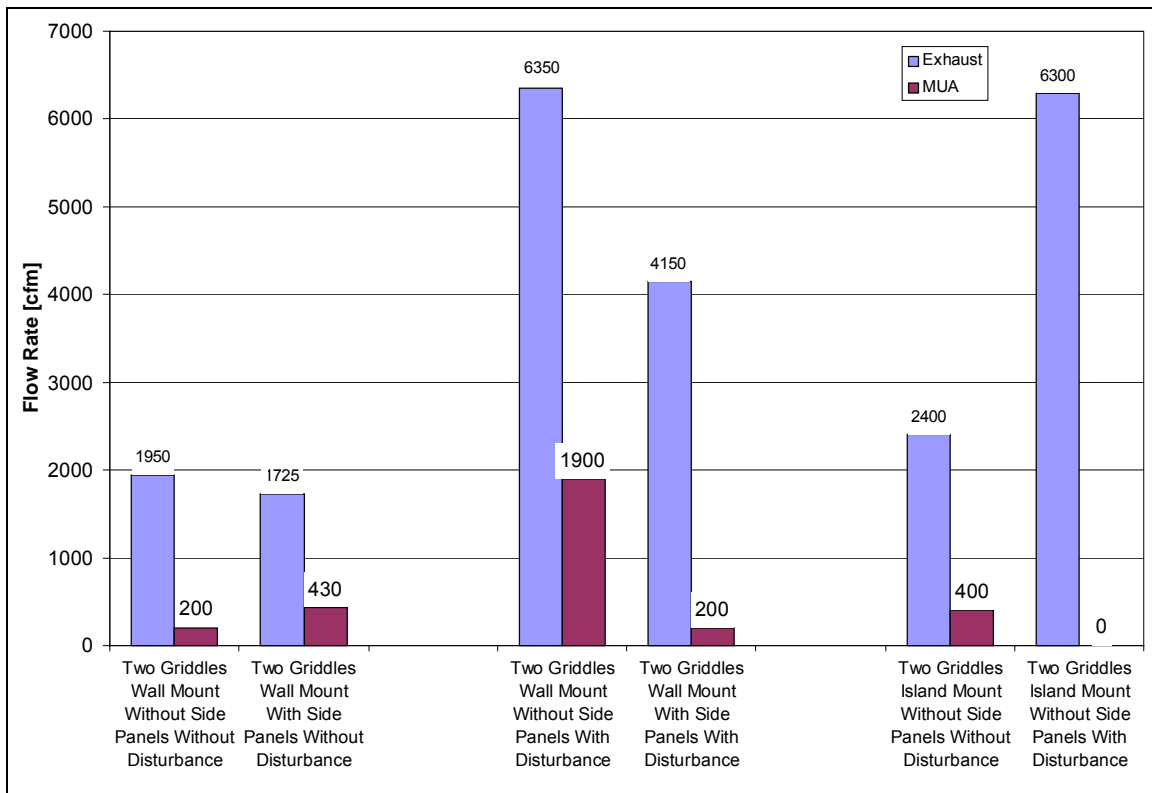

Figure 45: Exhaust and Front Face Flow Rates for the Two Griddles during Cooking Conditions

In the cases with cross drafts, it was very difficult to capture and contain without side panels. However when captured at an exhaust rate of 6350 cfm, 1900 cfm (30 percent of exhaust) could

be brought in through the front face. In the case with side panels, C&C was achieved at a much lower exhaust rate, 4150 cfm, but only 200 cfm could be brought in through the front face.

In the island-mounted cases with cross drafts, C&C was beyond the capacity of the lab exhaust fan. Without cross drafts, 400 cfm (17 percent of exhaust) could be brought through the front face without spilling the thermal plume at the displacement exhaust rate.

4.3.4 Front Face Plenum Internal Design Sensitivity Analysis

Some manufacturers claim their designs allow supplying as much as 90 percent of the MUA through the front face diffusers. When bringing in such large quantities of air, the direction of the air being discharged becomes paramount. The optimum direction for introducing makeup air through the front face without negatively affecting capture and containment performance is horizontal, or perpendicular to the front face. In order to achieve a uniform and perpendicular discharge, some manufacturers use internal baffling, air dams and/or layers of perforated sheets. The front face plenum used during the testing was supplied without any internal baffling, air dams or layers of perforated sheets. Sensitivity testing was conducted to determine how the internal design of the plenum could affect the C&C exhaust flow rate.

Two designs on the front face plenum were investigated to determine their effects. The original design was a custom fabricated plenum, and the second design included a solid 25.75-inch x 32-inch wide baffle installed per Figure 46.

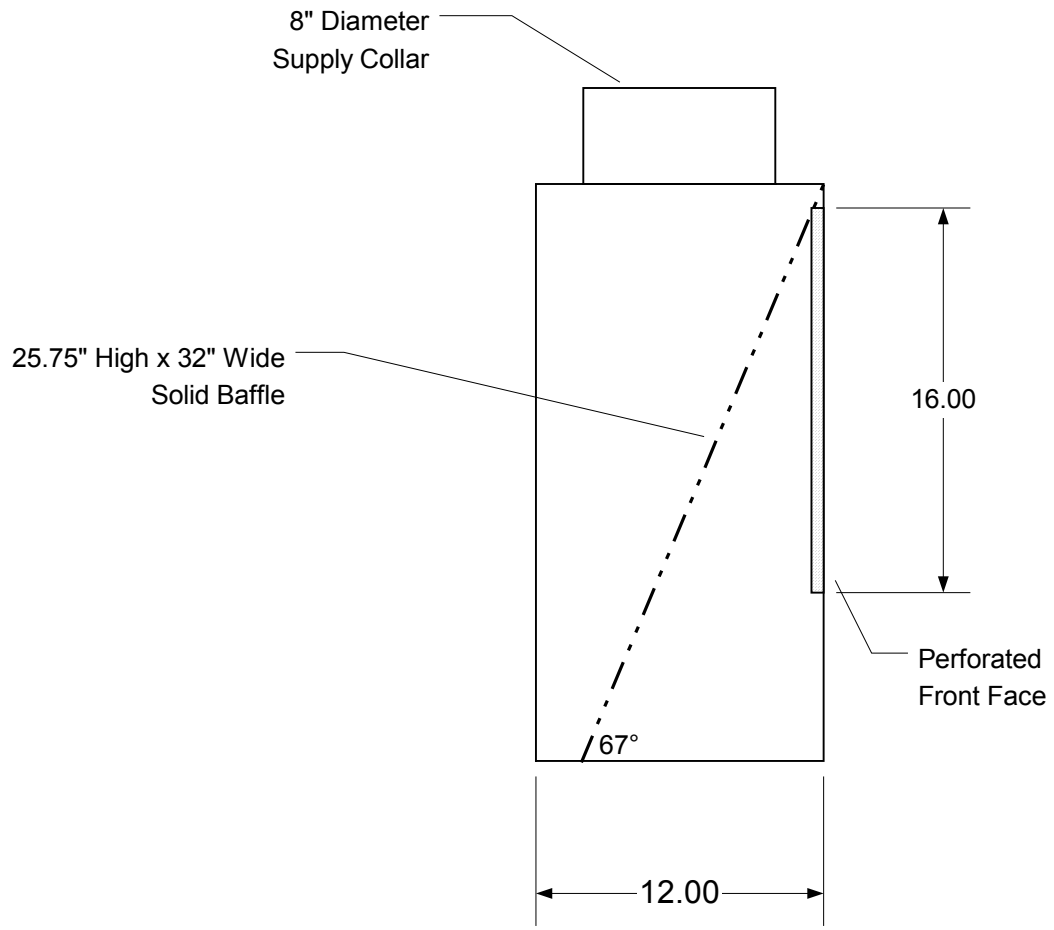

Figure 46: Detail Cross Section of Front Face Supply – Original and Modified Designs

The baffle blocked off the line of sight between the supply collar and the perforated face. Without the baffle, the supply air moved directly between the entrance to the plenum and through the perforated front face at a steep vertical angle. The supply air distribution for 1800 cfm is shown as a map of the face velocities as measured and shown in Figure 47.

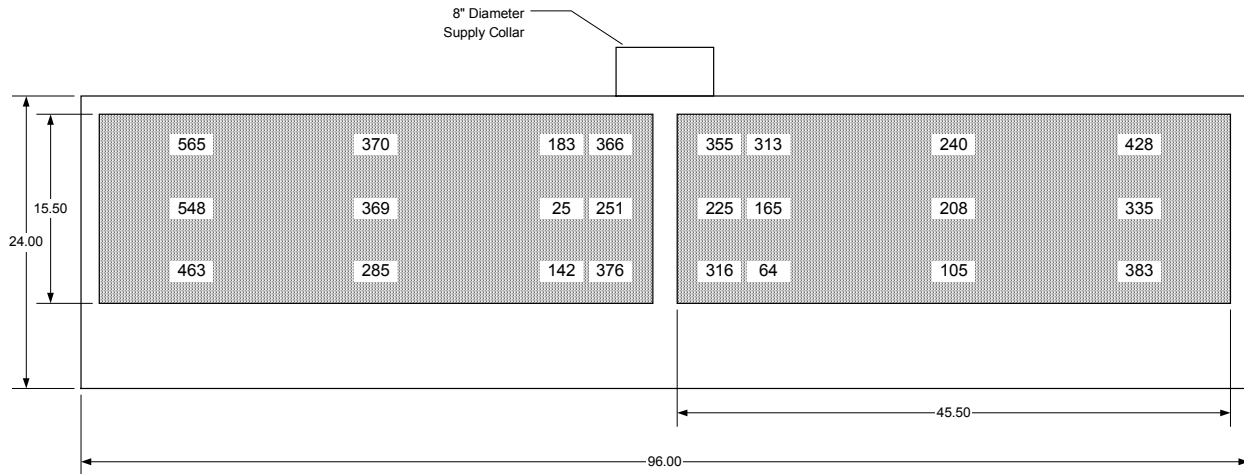

Figure 47: Air Speed in Feet per Minute as Discharged from the Front Face Plenum at an Airflow of 1800 CFM

The velocity map shows higher discharge rates near the center and left side of the plenum. In the center, the air exited at an almost vertical angle (at a very shallow angle to the front face of the hood). This promoted entrainment of the plume from inside the hood and accounts for the degradation in hood performance at relatively low MUA amounts. The shallow angle of discharge at the center of the MUA plenum was due to the direct path between the perforated face and supply duct connection. The lack of internal distribution allowed the air to be supplied directly through the perforated front face close to the supply collar. There was no pressure equalization or velocity leveling. The average velocity was 295 fpm, with a standard deviation of 140 fpm.

Figure 48 shows the exhaust and front face airflow rates. The exhaust airflow rates were determined as the front face airflow rates were increased as percentages of the original displacement ventilation rate.

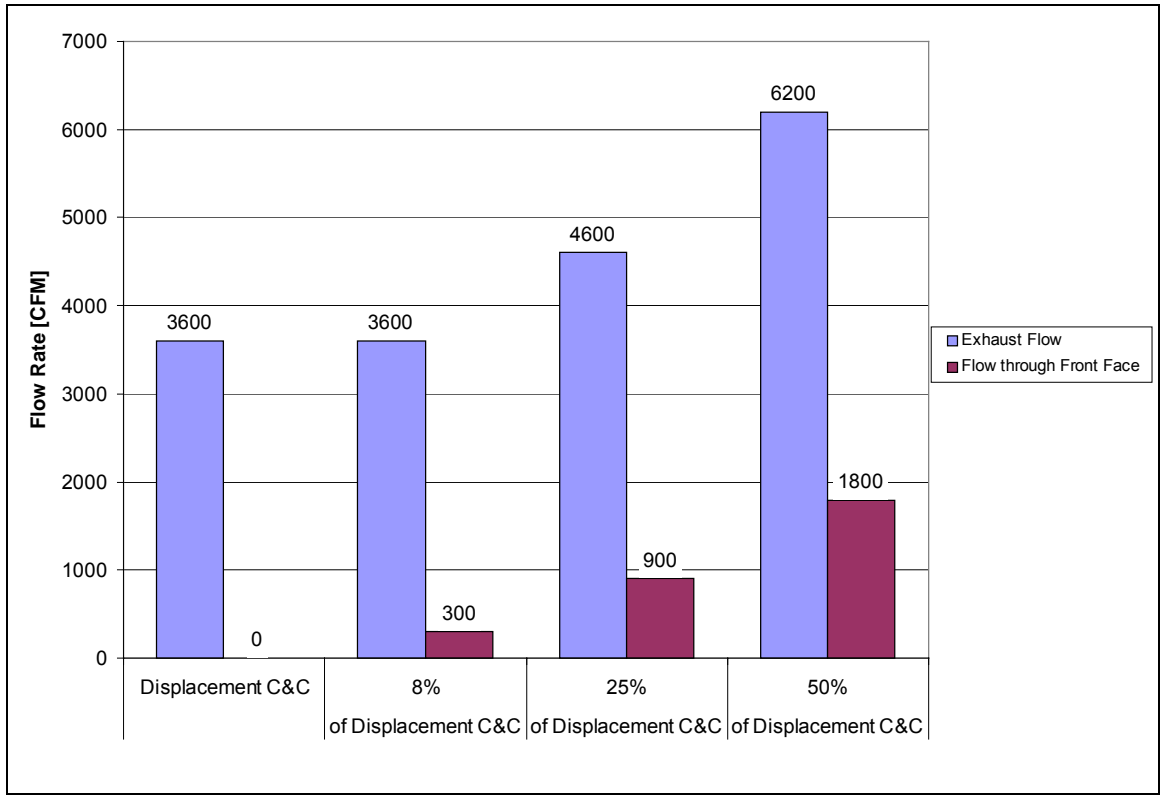

Figure 48: Exhaust and Front Face Airflow Rates as Front Face Airflow Rates were Increased as Percentages of the Original Displacement Ventilation Rate

Figure 49 shows the amount of exhaust air required as a function of amount of air brought in through the front face supply.

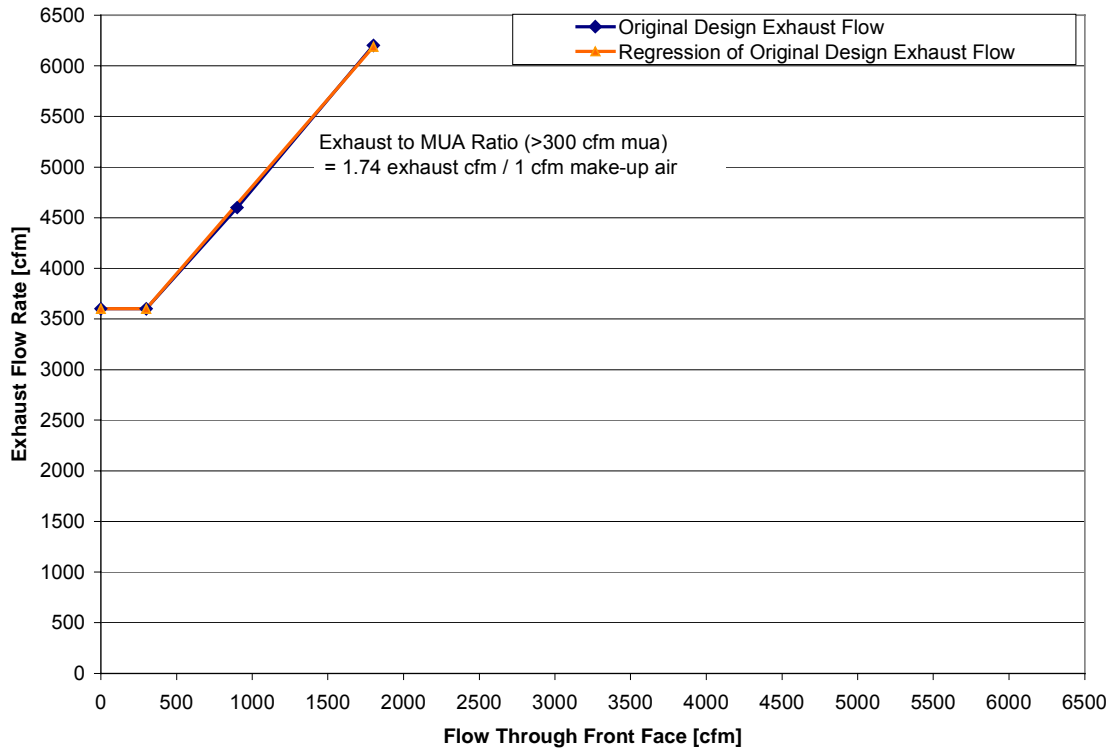

Figure 49: The Amount of Exhaust Air Required as a Function of the Amount of Air Brought in Through the Front Face Supply Plenum

The front face supply showed no effect on hood performance up to 300 cfm. Beyond the 300 cfm, the steep angle at which the local supply was introduced entrained the thermal plume at the hood’s lower edge. This led to higher requirements in exhaust flow rate for every cfm brought in through the front face. In the original configuration, the exhaust flow rate to local MUA ratio was 1.74; or for every one cfm of MUA introduced, the exhaust flow rate had to increase 1.74 cfm.

The 25.75-inch high by 32-inch wide solid baffle that was added to the supply plenum eliminated the shallow exit angle for MUA at the center of the plenum and resulted in less variation (although not uniform) in discharge velocity profile. Figure 50 shows the front face velocity profile.

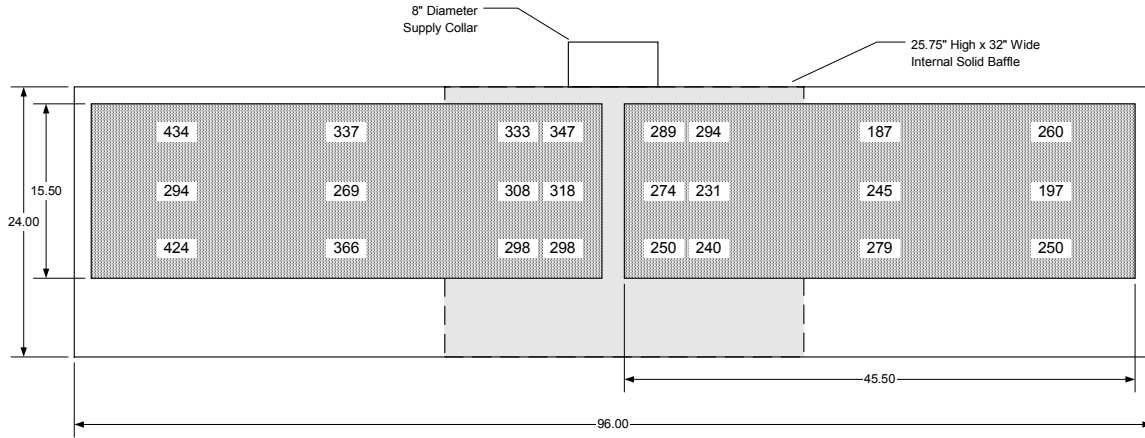

Figure 50: Air Speed in Feet per Minute as Discharged from the Modified Front Face Plenum at an Airflow of 1800 CFM

The velocity leveling as a result of the internal baffling had a dramatic effect on the hood's performance. The average velocity was 295 fpm. The standard deviation of the velocity dropped from 140 fpm without the baffle to 60 fpm with the baffle. The exhaust airflow rates required to capture and contain were much less than the rates than with the typical open plenum original configuration. Figure 51 shows the exhaust and front face airflow rates.

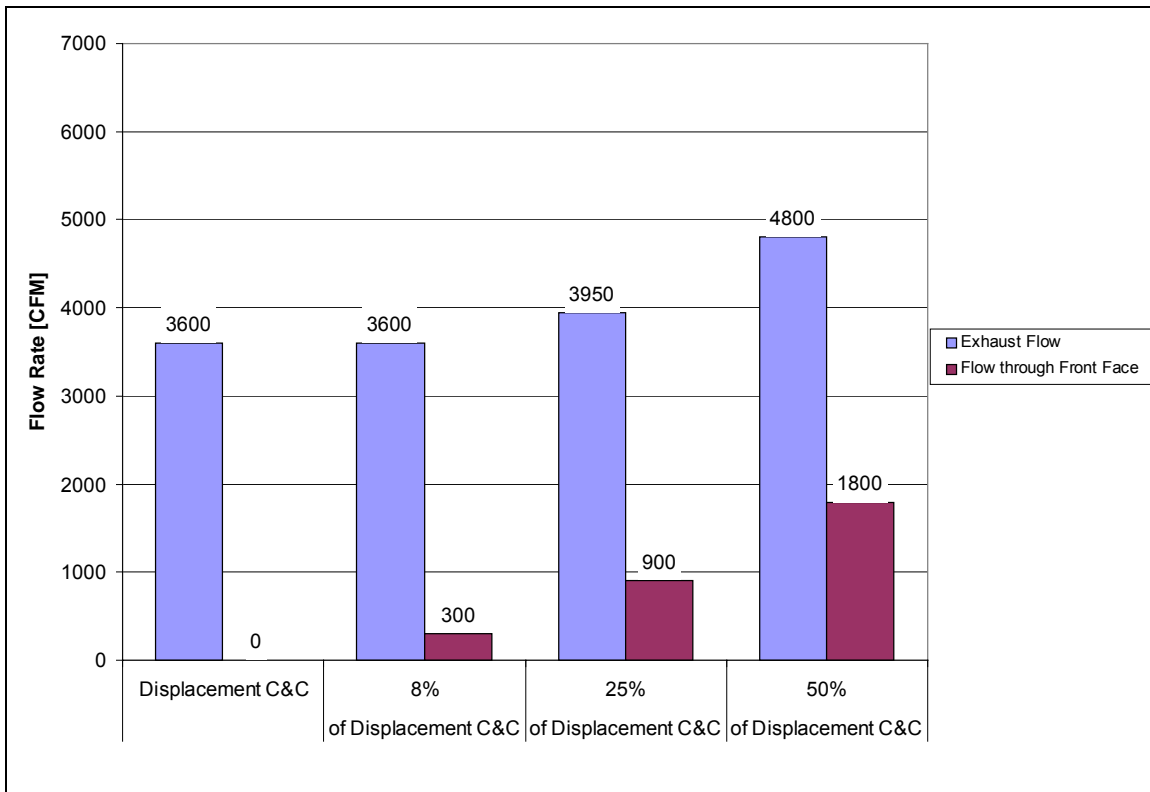

Figure 51: Exhaust and Front Face Airflow Rates as Front Face Airflow Rates were Increased as Percentages of the Original Displacement Ventilation Rate with Modified Supply Plenum

The amount of exhaust air required to capture and contain an increase in front face supply with the internal baffle was less than half as in the case of the original design. Figure 52 shows the relationship.

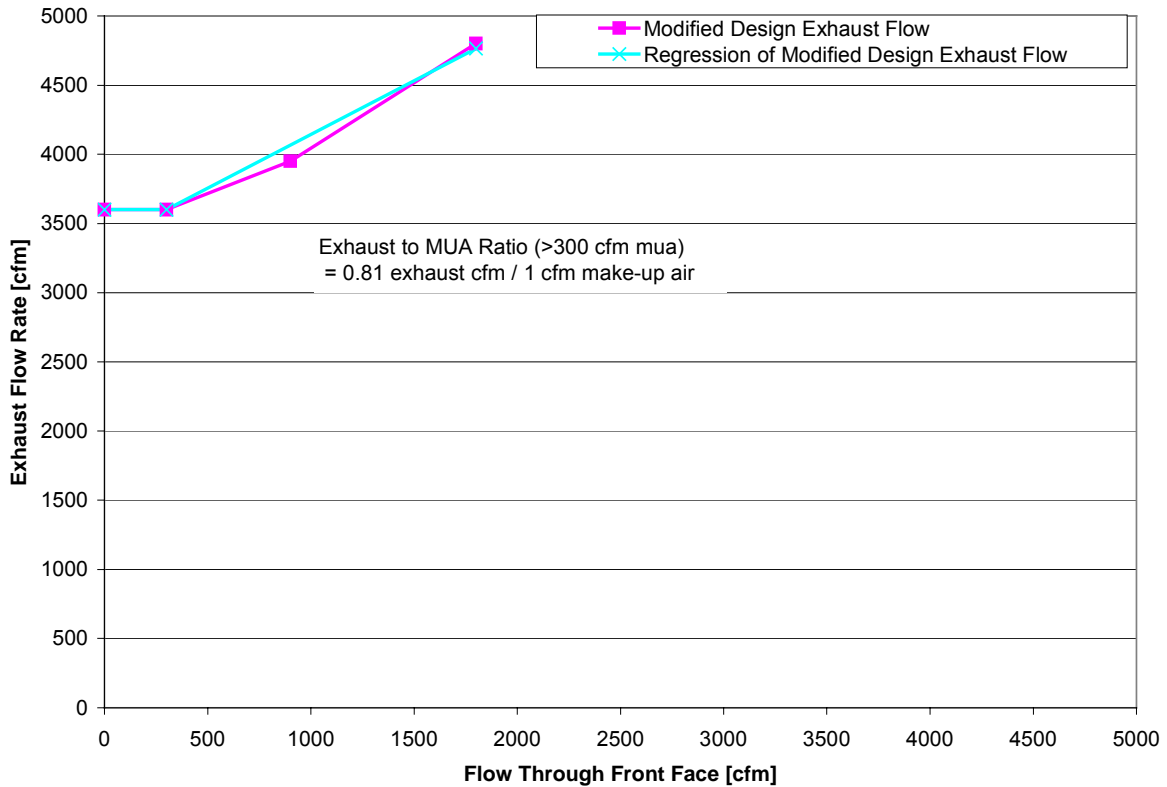

Figure 52: The Amount of Exhaust Air Required as a Function of the Amount of Air Brought in Through the Front Face Supply as Tested with the Modified Supply Plenum

Similar to the original design, the front face supply with the internal baffle showed no effect on hood performance up to 300 cfm. Beyond the 300 cfm flow rate, requirements in exhaust flow rate for every cfm brought through the front face was much less than in the original design. The exhaust flow rate to local MUA ratio for the modified plenum was 0.81; or for every one cfm of MUA introduced, the exhaust flow rate was required to rise 0.81 cfm.

4.4 Four-Way Ceiling Diffusers

Distributing replacement air through 4-way ceiling diffusers is a common method of supplying MUA for a kitchen exhaust hood, as well as providing general ventilation to the kitchen and adjacent spaces. By design, ceiling diffusers are intended to cause mixing of the supply and room air.

Diffusers, particularly 4-way diffusers, located close to the hood may interfere with hood performance by entraining effluent from inside the hood reservoir. In addition, diffuser velocity may change as HVAC or MUA units change operating modes. Economizer mode can lead to increased local velocities because opening the outside air damper effectively reduces the static pressure on the return side of the system. This allows more air through the system, which can create excessive velocities through the kitchen 4-way diffusers. These increased discharge velocities can cause degraded hood performance, especially if not located properly with respect to the hood.

4.4.1 Test Setup

Hood performance as affected by 4-way ceiling diffusers was determined for both an exhaust-only canopy and a proximity hood. Figure 53 shows a cross section of the 8-foot long exhaust-only hood used.

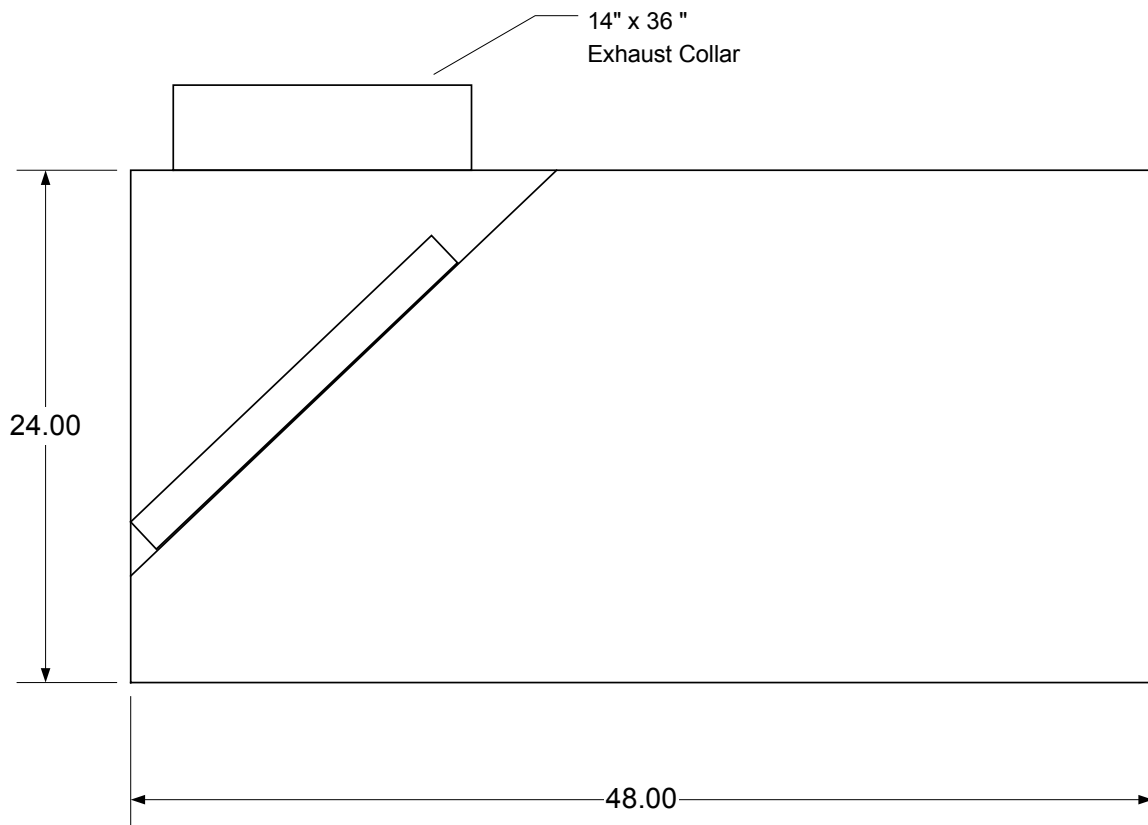

Figure 53: Cross-Section Drawing of the Exhaust Only Canopy Hood

The front lower edge of the hood was located at 78 inches above the finished floor. A 6-inch fascia was attached between the top of the hood and the drop ceiling. The ceiling was located 108 inches above the floor.

To determine the effect of diffuser location on hood C&C performance, the wall mounted and island mounted canopy hood configurations were used. Five 2-ft by 2-ft 4-way ceiling diffusers (with 15-inch by 15-inch internal collars) were located on two-foot centerlines from the front and sides of the canopy hood. The left side, left front and center front diffusers were run independently at a flow rate of 1000 cfm (71 percent of its rating) and a C&C exhaust flow rate was determined.

Figure 54 shows the canopy hood test set-up and diffuser locations.

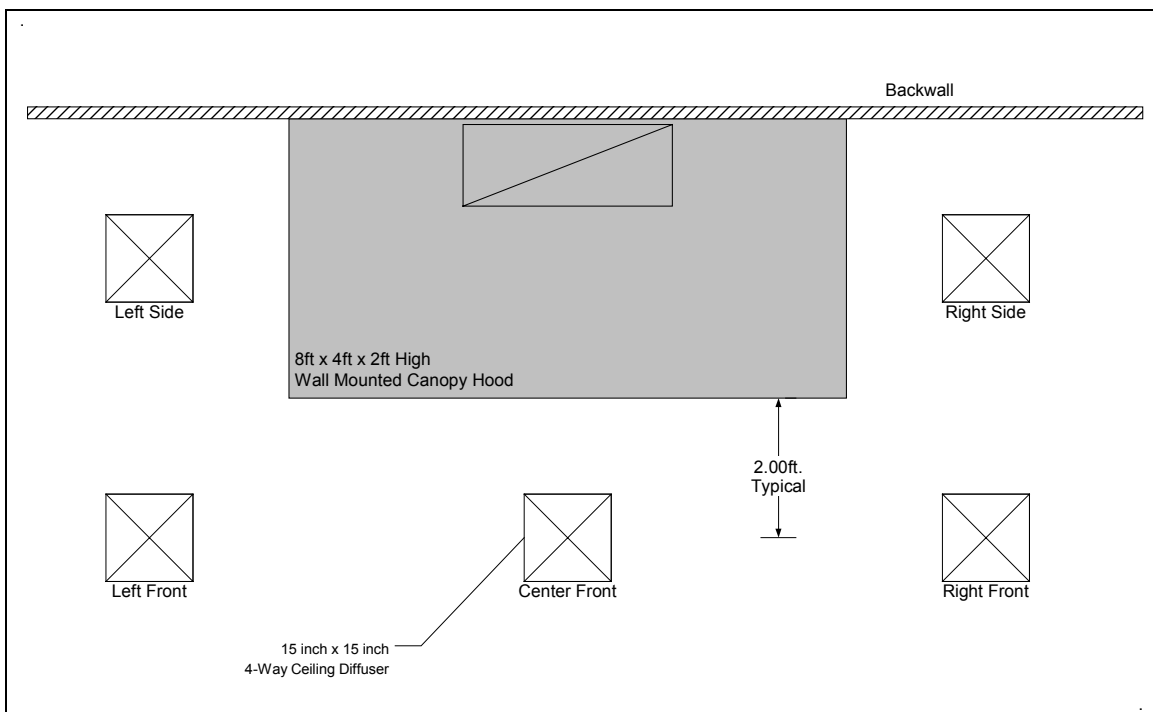

Figure 54: Test Set-Up for Exhaust Only Canopy Hood and Locations of the Four-Way Ceiling Diffusers

Figure 55 shows the test set-up as viewed from the schlieren optical system.



Figure 55: Test Set-Up for Exhaust Only Canopy Hood and Two Gas Griddles as Viewed from the Schlieren Optical System

Figure 56 shows the same vantage point as in Figure 55, as viewed with the schlieren system. It is during a condition of C&C with an exhaust flow rate of 2525 cfm and 1000 cfm discharging from the front center 4-way diffuser.



Figure 56: Schlieren View of C&C of Exhaust Only Canopy Hood and Two Griddles Simulated Cooking at 2525 CFM Exhaust and 1000 CFM Front Center 4-Way Diffuser Airflow Rates

Figure 57 shows a schlieren image of spillage of the thermal plume at 1850 cfm exhaust flow rate and 1400 cfm from the 4-way diffuser. At high discharge rates from the diffuser, the thermal plume is pulled from the front lower edge of the hood, as shown in the schlieren photo below. The diffuser flow is downward along the front face of the hood. It is only evident by the effect it has on the thermal plume (down and away from the lower edge of the hood).

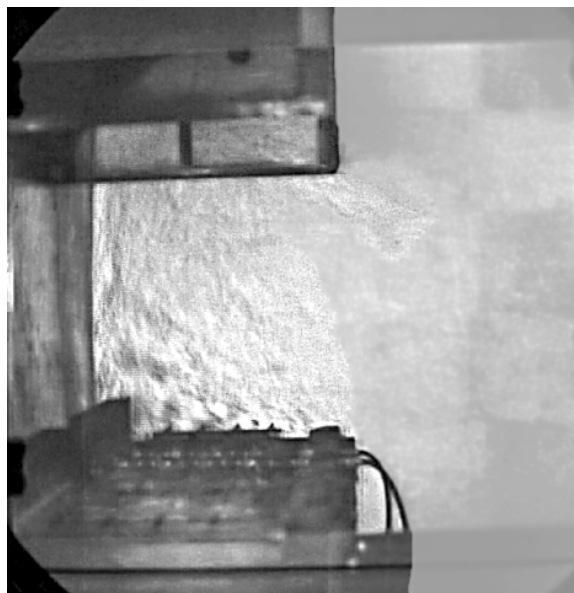

Figure 57: Schlieren View of Spillage from Exhaust Only Canopy Hood with Two Griddles Simulated Cooking at 1850 CFM Exhaust and 1400 CFM Front Center 4-Way Diffuser Airflow Rate

Figure 58 shows a cross section of the 86.5-inch wide proximity hood used.

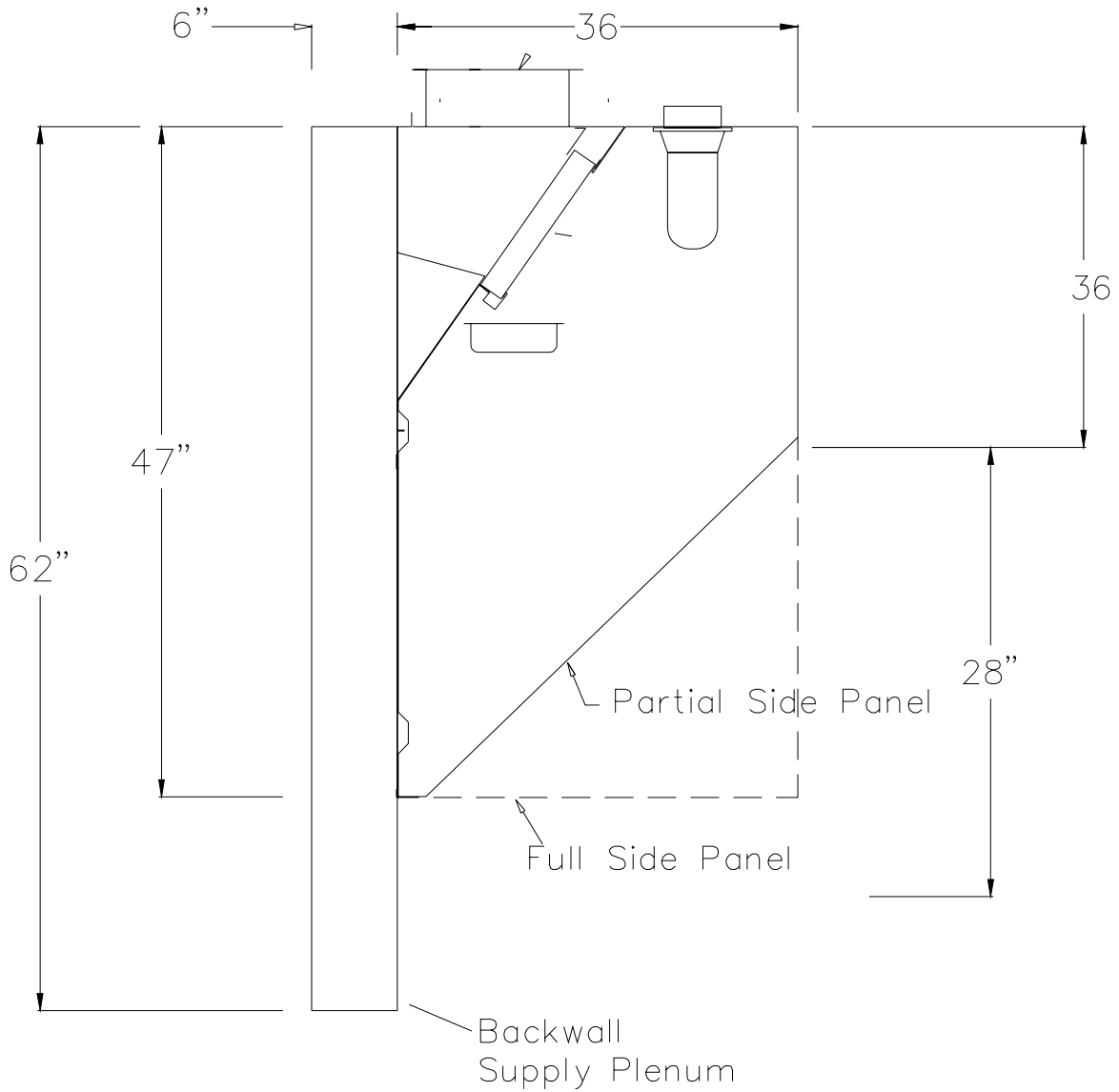

Figure 58: Cross-Section Drawing of Proximity Hood

The proximity hood was hung from the ceiling of the lab. The top of the hood was located at 90 inches above the finished floor. The ceiling was located 108 inches above the floor.

Figure 59 shows the test set-up as viewed from the schlieren optical box.



Figure 59: Test Set-Up for Proximity Hood and Two Gas Griddles as Viewed from the Schlieren Optical Box

Figure 60 shows the same vantage point as in Figure 59, as viewed with the schlieren system. It is during a condition of C&C with an exhaust rate of 1250 cfm and 425 cfm discharging from the front center 4-way diffuser.



Figure 60: Schlieren View of a Proximity Hood and Two Charbroilers with Simulated Cooking at 1250 CFM Exhaust and 425 CFM Front Center 4-Way Diffuser Airflow Rates Showing C&C

Figure 61 shows a schlieren image of spillage of the thermal plume at 1250 cfm exhaust flow rate and 1000 cfm from the 4-way diffuser. At high discharge rates from the diffuser, the thermal plume is pulled from the front lower edge of the hood, as shown in the schlieren photo below. The diffuser flow is downward along the front face of the hood. It is evident by the effect it has on the thermal plume (down and away from the lower edge of the hood).



Figure 61: Schlieren View of a Proximity Hood and Two Charbroilers with Simulated Cooking at 1250 CFM Exhaust and 1000 CFM Front Center 4-Way Diffuser Airflow Rates Showing Spillage

Figure 62 shows the positioning of the front center 4-way diffuser with respect to the proximity hood.

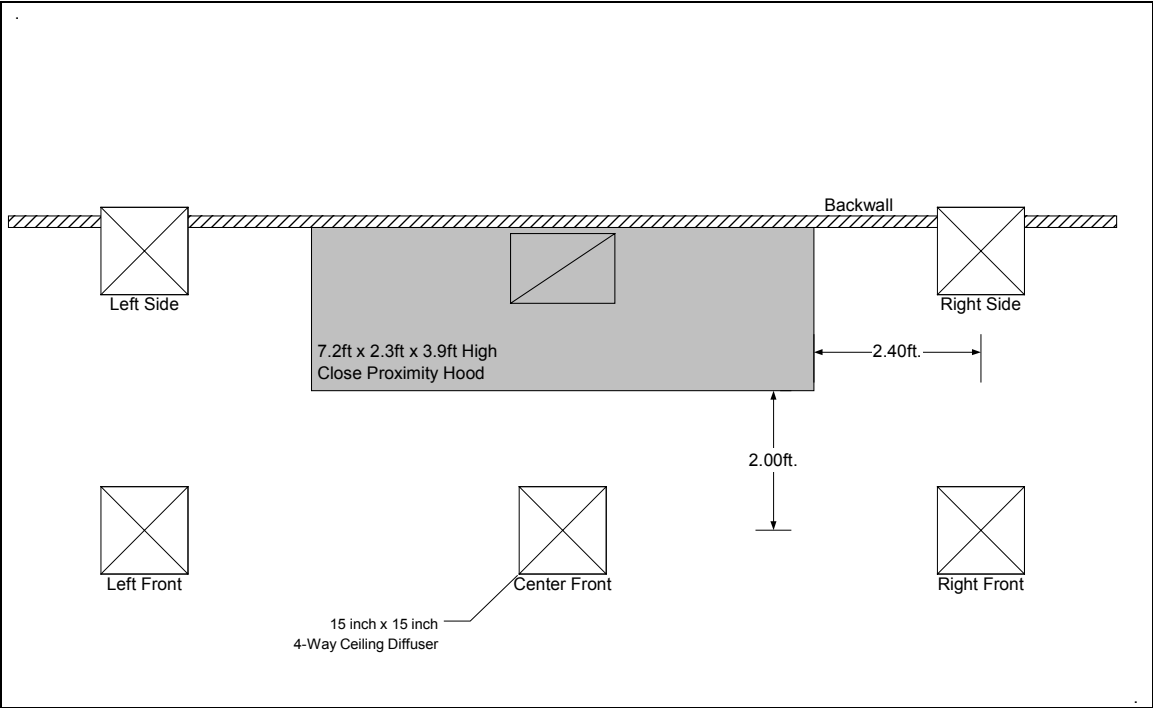

Figure 62: Four-Way Ceiling Diffuser and Proximity Hood Locations-Plan View

Figure 63 shows the diffuser layout and velocity measurements from each diffuser for 1000 cfm flow rate. The flow rates were not measured simultaneously. The differences in velocities from the diffusers are due to the supply duct connection to the diffuser. A tight elbow or short vertical run into the diffuser changed the velocity profile as discharged from the diffuser. The velocities shown in Figure 63 were measured with the greatest vertical run available for the supply ducts.

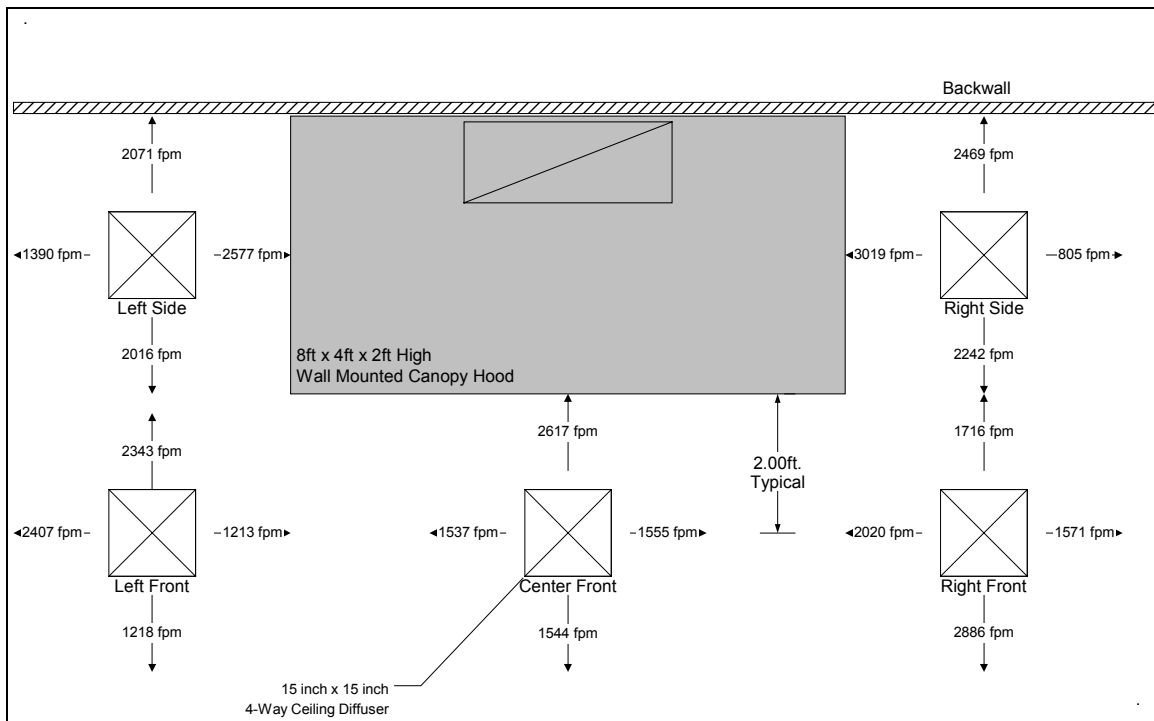

Figure 63: Four-Way Ceiling Diffuser Locations and Velocities at 1000 cfm Diffuser Flow Rates-Plan View

Figure 64 shows the C&C exhaust flow rates for two charbroilers idling and a constant 1000 cfm discharged from each of the 4-way diffusers. The airflow rates are also compared to the exhaust rates when supplied from the displacement system instead of the ceiling diffusers.

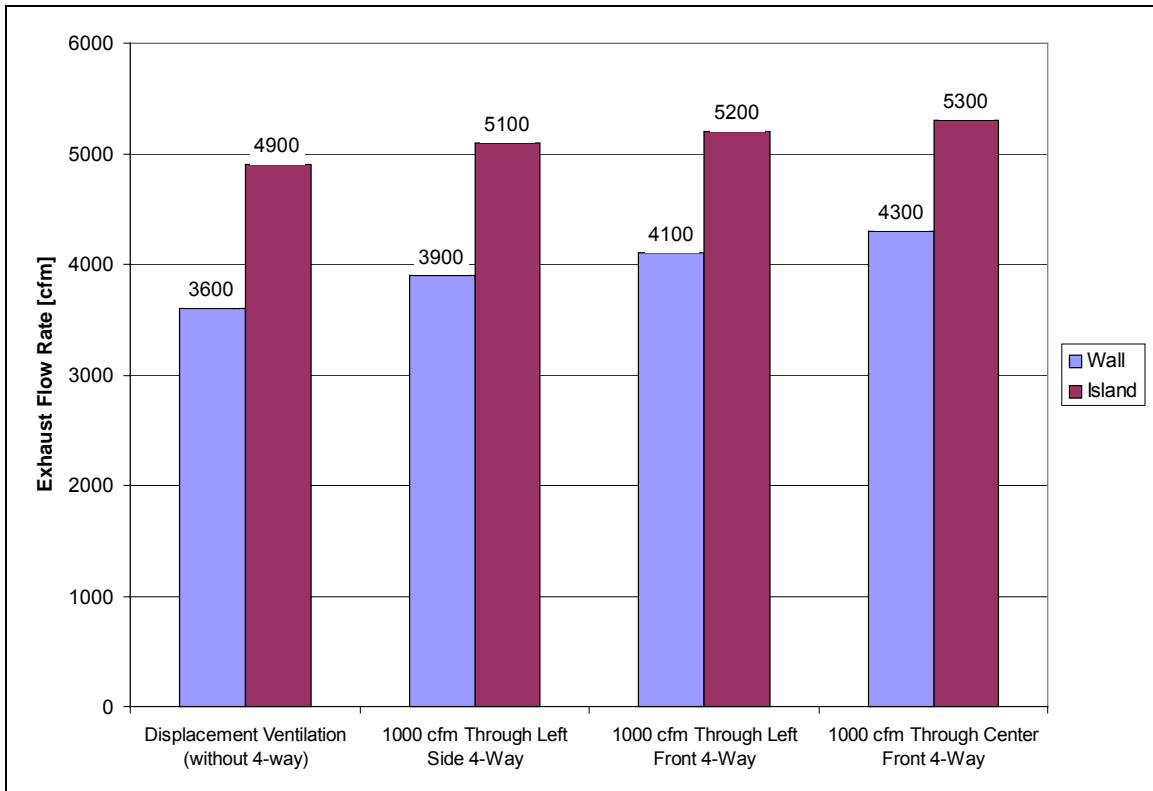

Figure 64: Exhaust Flow Rates for an Exhaust Only Canopy Hood and 2 Charbroilers Idling with Displacement Ventilation Compared to Three Different Ceiling Diffuser Locations

The data in Figure 64 illustrates that for the test conditions investigated, the 4-way diffuser located at the front of the canopy hood had the most detrimental effect on the C&C performance. The 4-way diffuser located at the front was worse than the same located at the side or corner. With the island-mounted configurations, the diffuser airflow not only tended to draw the effluent out from the lower edge, but also pushed the plume out the rear.

With the replacement air being supplied from the displacement system, the exhaust C&C rate for the wall-mounted hood was 3600 cfm. The exhaust rate requirement increased 700 cfm (19 percent) to 4300 cfm when 1000 cfm was supplied through the diffuser located at the center front of the hood. Note, only 250 cfm (theoretically) was directed towards the hood. For the case of the island-mounted hood with 1000 cfm through the same diffuser, the exhaust C&C rate increased 400 cfm to 5300 cfm from the 4900 cfm displacement rate.

The testing proceeded to determine the C&C exhaust flow rate with 1000 cfm discharged from the front center diffuser under various appliance and cooking conditions.

4.4.2 Findings for Charbroilers

4.4.2.1 Charbroilers Idling

Figure 65 shows the results for two charbroilers in the idle condition. In general, the average increase in exhaust flow rate for the canopy hood cases due to 1000 cfm introduced from the front center 4-way diffuser was 530 cfm as compared to the displacement only. For the proximity hood cases, the average increase was 325 cfm.

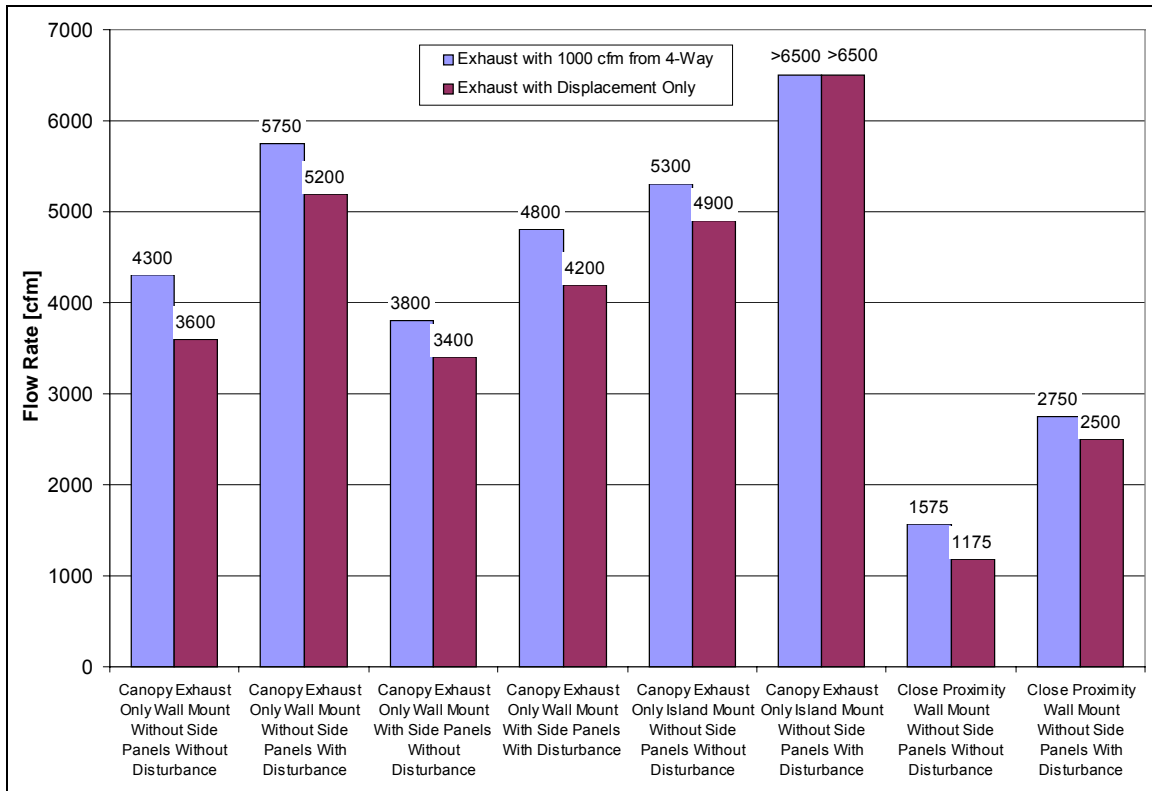

Figure 65: Exhaust Flow Rates for the Two Charbroilers During Idle Conditions Under Canopy and Proximity Hoods for Displacement and 1000 cfm through the Center Front 4-Way Diffuser

For the baseline case where the replacement air is supplied to a wall mounted canopy hood without side panels and without a cross draft from a displacement ventilation system, 3600 cfm was determined as the C&C exhaust flow rate. When 1000 cfm was introduced from the 4-way ceiling diffuser located at the front, the exhaust requirements increased 700 cfm (19 percent) to 4300 cfm. For the similar island case, the exhaust flow rate increased 400 cfm (8 percent) above the 4900 cfm required for C&C with displacement ventilation to 5300 cfm total.

The proximity hood captured and contained the same thermal plume at a much lower exhaust flow rate. For the case without side panels and a cross draft, and with 1000 cfm from the front diffuser, an exhaust rate of 1575 cfm was required. That is 2725 cfm (63 percent) below the canopy hood rate, and only 400 cfm (34 percent) above the rate required with a displacement ventilation system. When a cross draft was added to the proximity hood scenario, the exhaust rate increased to 2750 cfm (75 percent), which is 250 cfm above the displacement exhaust flow rate for a cross draft.

A cross draft required a 1450 cfm (34 percent) increase in exhaust flow rate for the canopy case without side panels and a 1000 cfm (26 percent) increase in exhaust flow rate for the case with side panels. For the proximity hood, a cross draft required a 1175 cfm (75 percent) increase for the case without side panels. It appeared that the front center diffuser has less of an effect on the proximity hood, probably due to the higher MUA entrance velocity at the capture edge of the proximity hood.

In addition, the use of side panels allowed a 12 percent reduction (500 cfm) in exhaust flow rate for the canopy hood without cross drafts or cross draft, and a 17 percent reduction (950 cfm) with a cross draft. Side panels have the greatest merit in reducing cross draft effects.

4.4.2.2 Charbroilers Cooking

During cooking conditions, the C&C rates for two charbroilers exhibited similar characteristics as in the idle conditions, except for the island case without cross draft (Figure 66).

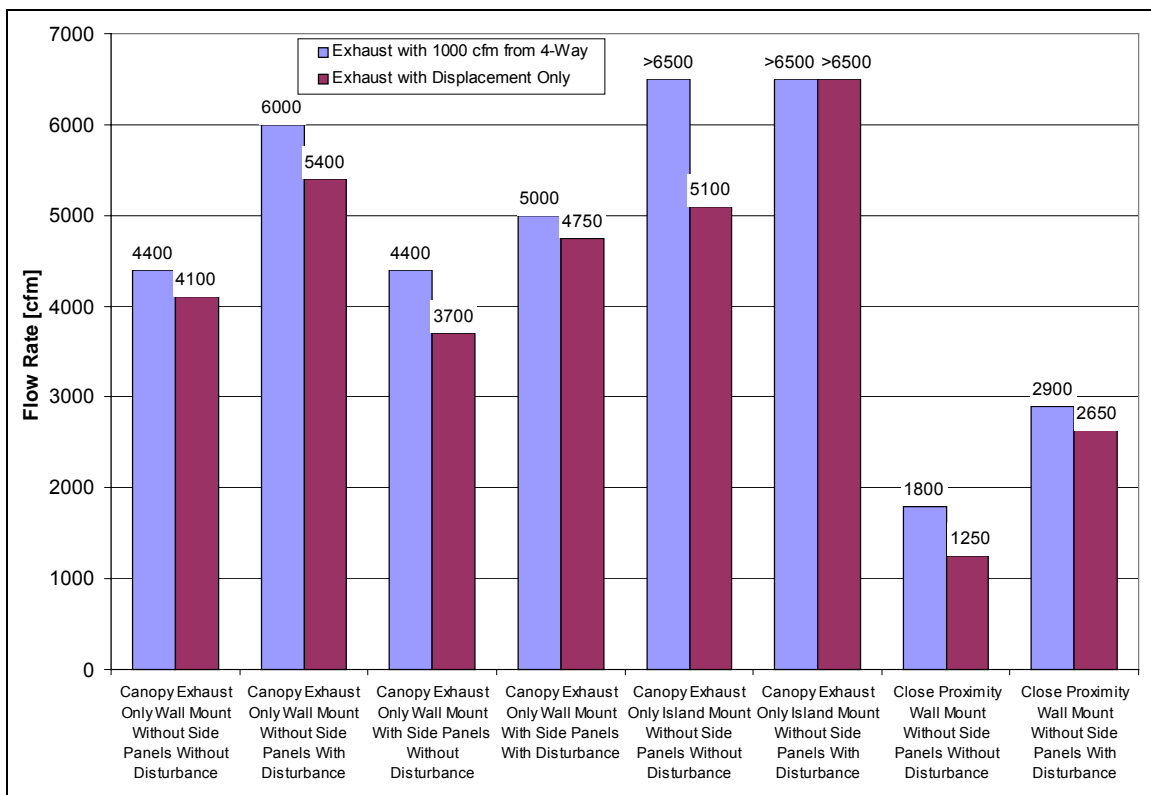

Figure 66: Exhaust Flow Rates for the Two Charbroilers During Cooking Conditions Under Canopy and Proximity Hoods for Displacement and 1000 cfm through the Center Front 4-Way Diffuser

For the baseline displacement ventilation case, the wall mounted canopy hood without side panels and without a cross draft had a C&C exhaust rate of 4100 cfm. When 1000 cfm was introduced from the front 4-way ceiling diffuser, the exhaust requirements increased 300 cfm (7 percent) to 4400 cfm. Adding a cross draft required a 1600 cfm (36 percent) increase in exhaust flow rate to 6000 cfm for the canopy hood without side panels and a 600 cfm (14 percent) increase from an identical 4400 cfm to 5000 cfm for the canopy hood case with side panels. These results show the use of side panels had no effect in required exhaust flow rate for the

canopy hood without cross drafts but did cause a reduction of 1000 cfm (17 percent) with a cross draft present.

For the island-mounted canopy case with displacement ventilation, the exhaust rate required for C&C was 5100 cfm. When 1000 cfm was introduced from the 4-way ceiling diffuser, the lab's exhaust system was not capable of capturing and containing the thermal plume at the 6500 cfm available. The addition of a cross draft increases the exhaust rate required for C&C and was therefore not tested.

For the proximity hood with displacement ventilation, the exhaust rate required for C&C was 1250 cfm. When 1000 cfm was introduced from the front 4-way ceiling diffuser, the exhaust requirements increased 550 cfm (44 percent) to 1800 cfm. A cross draft required an 1100 cfm (61 percent) increase to 2900 cfm for the proximity hood case without side panels. That is 3100 cfm below the required exhaust rate of 6000 cfm for the canopy hood under similar conditions.

4.4.3 Findings for Griddles

During idle conditions, the C&C rates for two griddles exhibited similar characteristics as in the charbroiler idle conditions, except for three cases. Two cases with the proximity hood, and one case with a cooking island mounted hood case with cross draft, had exhaust flow rates with displacement ventilation greater than the exhaust flow rate with the ceiling diffuser. In the island-mounted case, the unexpected results are likely due to the difficulty in viewing the MUA mixing with the room air. See Figure 67 and Figure 68.

When considering the canopy hood group as a whole, the average increase in exhaust flow rate due to 1000 cfm introduced from the front center 4-way diffuser was 665 cfm as compared to the displacement only case. For the proximity hood cases, the average increase was 360 cfm.

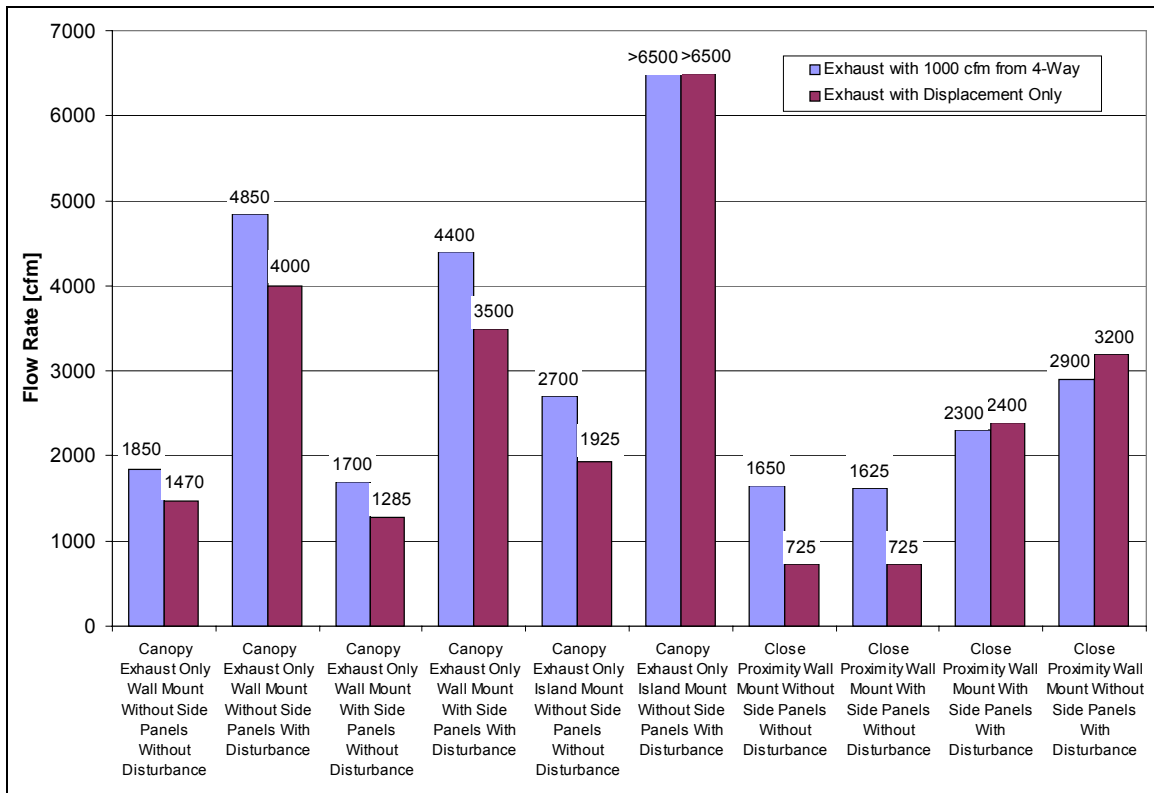

Figure 67: Exhaust Flow Rates for the Two Griddles During Idle Conditions Under Canopy and Proximity Hoods for Displacement and 1000 cfm through the Center Front 4-Way Diffuser

4.4.3.1 Griddles Idling

For the baseline displacement ventilation case of two griddles idling under the wall mounted canopy hood without side panels and without cross draft, the exhaust C&C rate was 1470 cfm. When 1000 cfm was introduced from the 4-way ceiling diffuser located at the front, the exhaust requirement increased 380 cfm (26 percent) to 1850 cfm. Adding a cross draft required a 3000 cfm (162 percent) increase in exhaust flow rate to 4850 cfm for the canopy hood without side panels and a 2700 cfm (158 percent) increase in exhaust flow rate to 4400 cfm for the canopy

hood with side panels. The use of side panels allowed a 150 cfm (8 percent) reduction in exhaust flow rate for the canopy hood without cross drafts or cross draft, and a 450 cfm reduction (9 percent) with a cross draft.

For the similar island case, the 2700 cfm exhaust flow rate necessary to capture and contain the thermal plume with 1000 cfm through the diffuser was 775 cfm (40 percent) above the exhaust rate of 1925 cfm required for displacement ventilation. The addition of a cross draft caused failure to capture and contain the plume up to and including the maximum 6500 cfm (241 percent increase) available from the exhaust system at the laboratory.

For the similar proximity hood case, the 1650 cfm exhaust flow rate necessary to capture and contain the thermal plume with 1000 cfm through the diffuser was 925 cfm (128 percent) above the exhaust rate of 725 cfm required for displacement ventilation. When a cross draft was added to the proximity hood scenario, the 1650 cfm exhaust rate increased by 1250 cfm (76 percent) to 2900 cfm for proper C&C. The addition of full side panels had a negligible effect when no cross draft was present. However, when a cross draft was present with 4-way diffuser ventilation, the required exhaust rate dropped from 2900 cfm to 2300 cfm, a 600 cfm (21 percent) reduction.

4.4.3.2 Griddles Cooking

During cooking conditions, the C&C rates of two griddles exhibited similar characteristics as in idle conditions (Figure 68).

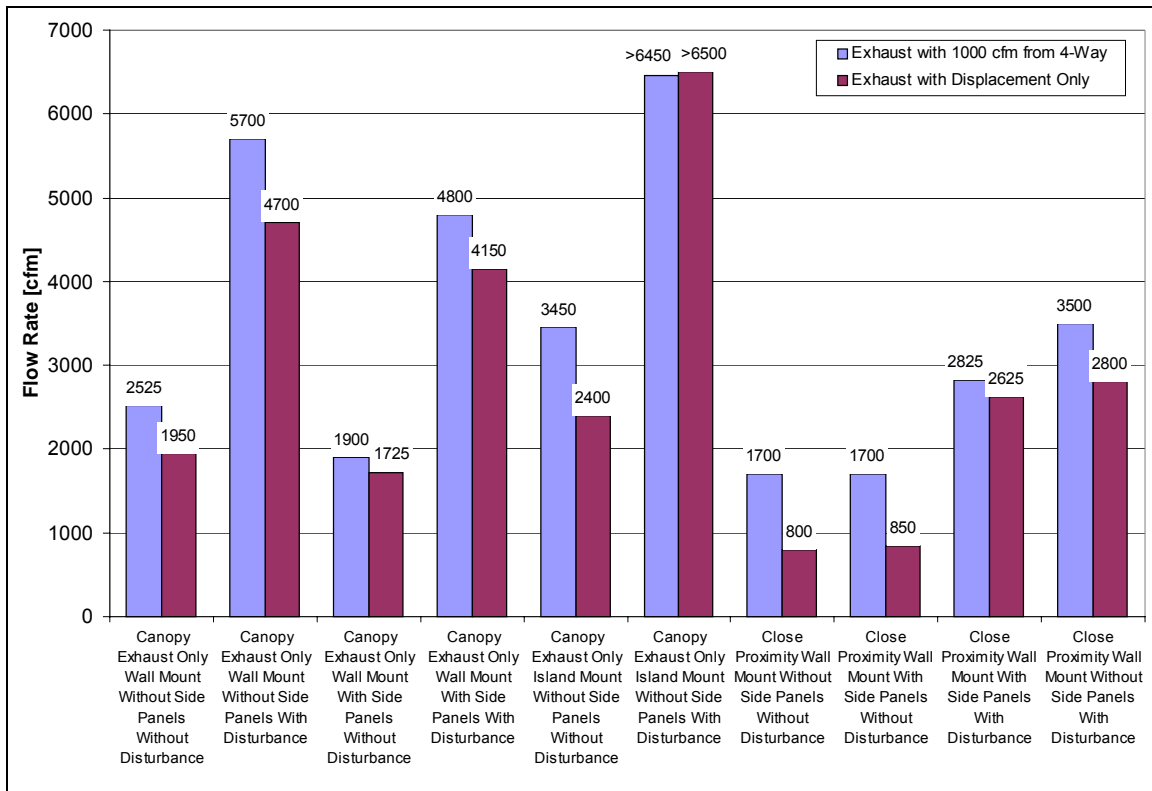

Figure 68: Exhaust Flow Rates for the Two Griddles During Cooking Conditions Under Canopy and Proximity Hoods for Displacement and 1000 cfm through the Center Front 4-Way Diffuser

In general, the average increase in exhaust flow rate for canopy hoods due to 1000 cfm introduced from the front center 4-way diffuser was 690 cfm as compared to the displacement only case. For the proximity hood cases, the average increase was 660 cfm. A similar increase was required for griddles idling under a canopy hood; but for the proximity hood case, the exhaust increase was nearly double (360 cfm idle versus 660 cfm cook).

For the baseline displacement ventilation case for the two griddles cooking under the wall mounted canopy hood without side panels and without cross draft, the C&C exhaust flow rate was 1950 cfm. When 1000 cfm was introduced from the 4-way ceiling diffuser located at the front, the exhaust requirement increased 575 cfm (29 percent) to 2525 cfm. A cross draft required an additional 3175 cfm (126 percent) increase in exhaust flow rate for the canopy case without side panels, and a 2900 cfm (152 percent) increase in exhaust flow rate for the canopy hood with side panels. Also, the use of side panels allowed a 24 percent (625 cfm) reduction in exhaust flow rate for the canopy hood without cross draft, and a 16 percent (900 cfm) reduction with a cross draft. ***Side panels clearly show promise as a method to mitigate cross draft problems in existing or new kitchens.***

For the similar island case, the 3450 cfm exhaust flow rate necessary to capture and contain the thermal plume with 1000 cfm through the ceiling diffuser was 1050 cfm (44 percent) above the displacement rate of 2400 cfm. The addition of a cross draft caused failure to capture and contain the plume up to and including the maximum 6500 cfm (188 percent increase) available from the exhaust system at the laboratory.

For the similar proximity hood case, the 1700 cfm exhaust flow rate necessary to capture and contain the thermal plume with 1000 cfm through the diffuser was 900 cfm (113 percent) above the exhaust rate of 800 cfm required for displacement ventilation. That exhaust rate was 825 cfm (33 percent) below the canopy hood rate.

For the proximity hood without side panels, an 1800 cfm (105 percent) increase to 3500 cfm was required for the presence of a cross draft. This increase was 700 cfm above the 2800 cfm exhaust flow rate required with a disturbance and displacement ventilation and continue to represent substantial design safety factors.

4.4.4 Analysis of Diffuser Air Velocity Effects at Hood Lower Edge

The effect on hood performance from the ceiling 4-way diffusers is mainly due to the speed and angle at which the air approaches the lower lip of the hood. The diffuser air, which follows the ceiling and eventually turns vertically down the front face of the hood, can create a negative pressure zone at the lower edge of the hood that entrains the thermal plume from the inside edge. The higher the air velocity at the edge, the greater the pressure to draw out the plume. Testing was done to measure the velocity at the lower edge of the hood at which the diffuser flow rate degrades the C&C performance of the hood.

The flow and throw data from 4-way diffusers are well documented by manufacturers, although they may be affected by ductwork used to supply them. Figure 69 shows a cross section of the 15-inch by 15-inch 4-way ceiling diffuser.

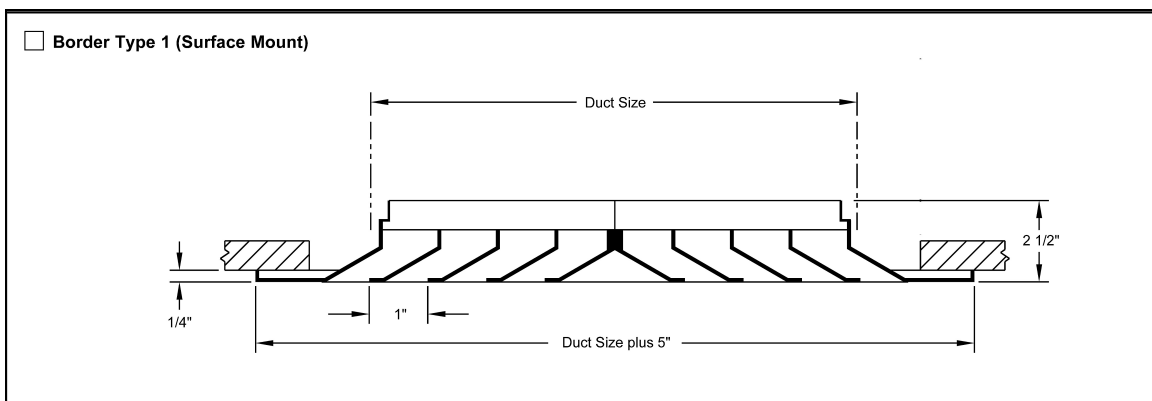

Figure 69: Detail Cross Section of 4-Way Ceiling Diffuser

Table 3 shows typical manufacture’s data for the above diffuser.

Table 3: Typical Flow and Throw Data for a 15 inch by 15 inch 4-Way Diffuser

Total Flow (cfm)	469			938		
Side Flow (cfm)	117			234		
Neck Velocity (fpm)	300			600		
	Throw at terminal velocity of			Throw at terminal velocity of		
	150 fpm	100 fpm	50 fpm	150 fpm	100 fpm	50 fpm
	7 ft	12 ft	20 ft	16 ft	20 ft	28ft

Source: Titus catalog dated 3/10/97 (TITUS, 990 Security Row, Richardson, Texas 75081)

The diffuser flow rate used during the study was 1000 cfm total. The table shows at a diffuser flow rate of about 940 cfm, the terminal velocity of 150 fpm would occur at a distance of 16 feet from the diffuser and similarly, the terminal velocity of 50 fpm would occur 28 feet from the center of the diffuser.

Velocity measurements were taken at the lower edge of the canopy hood at diffuser flow rates from 100 to 1400 cfm. The velocity was measured in a vertical direction at the lower edge of the hood. The 9 measurement locations were at 1-foot increments along the front of the hood, from left to right. Figure 70 shows the velocity profiles.

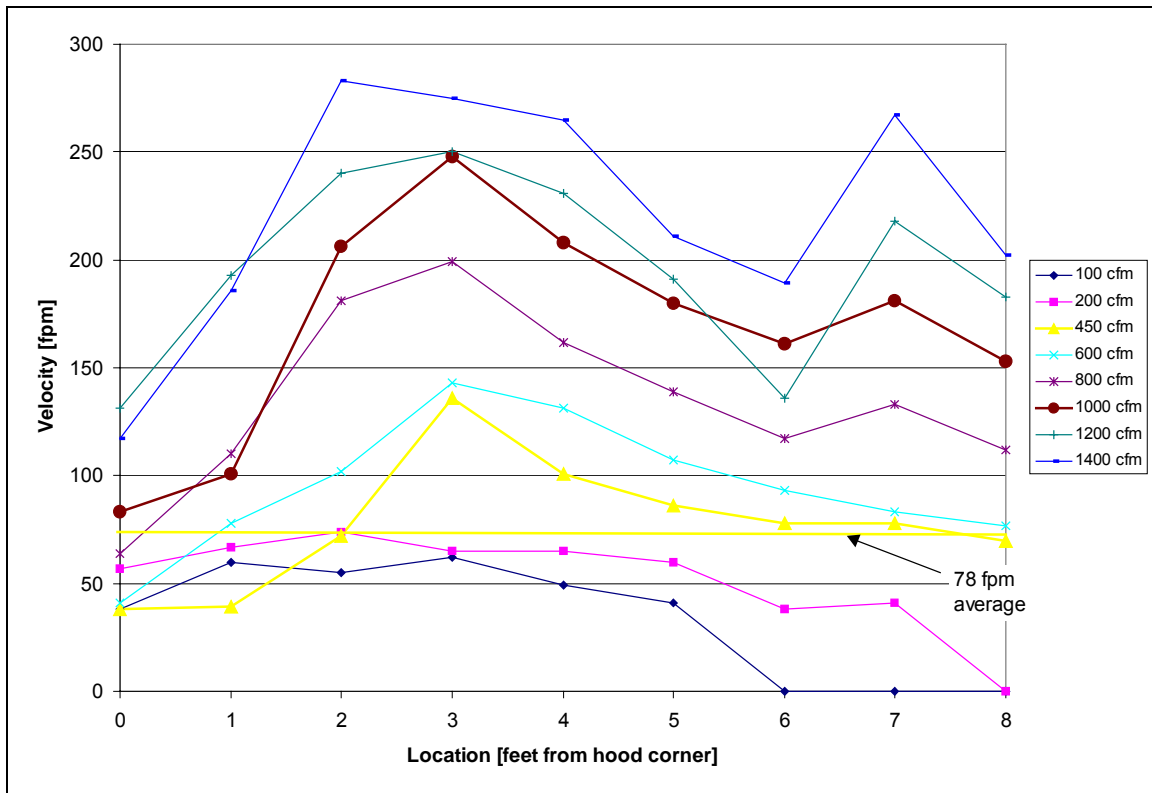

Figure 70: Velocity Profiles along the Front Lower Edge of the Canopy Hood for 4-Way Diffuser Flow Rates Between 100 and 1400 cfm

For the 1000 cfm delivered by the diffuser during the MUA tests, the maximum velocity measured was 250 fpm (location 3), the minimum was 85 fpm (location 0), and the average was 170 fpm.

For the case of two charbroilers idling, 450 cfm delivered from the diffuser caused spillage of the thermal plume for the displacement ventilation’s required exhaust rate of 3600 cfm. At a flow rate of 450 cfm, the velocity measurements at the lower edge of the hood were a maximum of 135 fpm (location 3), a minimum of 40 fpm (locations 0&1), and an average of 80 fpm. It was the maximum velocity of 135 fpm at location 3 (7 feet from the center of the diffuser) that caused the thermal plume to become entrained in the diffuser jet and began to degrade the performance of the hood. Per Figure 70 above, at the flow rate of 470 cfm, 150 fpm terminal velocity occurs at a 7-foot throw from the diffuser. The velocity measurements correspond well with the manufacture’s data (i.e., 135 fpm vs. 150 fpm).

If we return to the test case where 1000 cfm was discharged from the diffuser, according to Figure 70, a 135 fpm terminal velocity (i.e., the velocity measurement at the edge for the spill flow rate found previously) would occur approximately 19 feet from the center of the diffuser. A 19-foot path to the diffuser from the lower edge of the hood would locate the diffuser

approximately 16.5 feet from the hood. A 17 foot distance would ensure a low enough terminal velocity (i.e., less than 135 fpm) at the lower edge of a 2 foot high canopy hood (installed 6 inches under ceiling) so as not to degrade the performance. If a 15-inch by 15-inch 4-way diffuser was supplying 1000 cfm, a 17 foot distance between the hood and diffuser would be required to assure no loss of hood performance due to the diffuser effects for a hood operating at the C&C exhaust flow rate specified.

Alternatively, it may be inferred from these tests that by supplying less than 1000 cfm per diffuser the diffusers may be located closer to the hood. However, recommendations can not be provided from the limited testing undertaken in this study. The study results clearly show that airflow from a single diffuser can have detrimental effects on hood performance. The influence of other diffusers in the vicinity may mitigate or exacerbate the impact on hood performance. Since most kitchens have more than one ceiling diffuser, additional testing of a multiple diffuser layout would provide valuable information for the California restaurant design and operations community. The complexity of possible diffuser layouts, airflow rates, and test conditions (type of hood, specific geometry of hood, type of diffuser, and cross drafts) would yield a large potential test matrix, from which a number of representative test conditions could be selected.

4.4.5 Analysis of Diffuser Effect on Appliance Duty

To determine the effect of diffuser flow rate on hood performance with different duty appliances, the flow to the front center diffuser was increased and the exhaust C&C flow rate was determined for separate cases with 2 griddles and 2 charbroilers idling under a canopy hood.

The marginal increase in exhaust air required to capture and contain the thermal plume was greater for 2 griddles idling than for 2 charbroilers under a wall mounted canopy hood. Figure 71 shows the relationship.

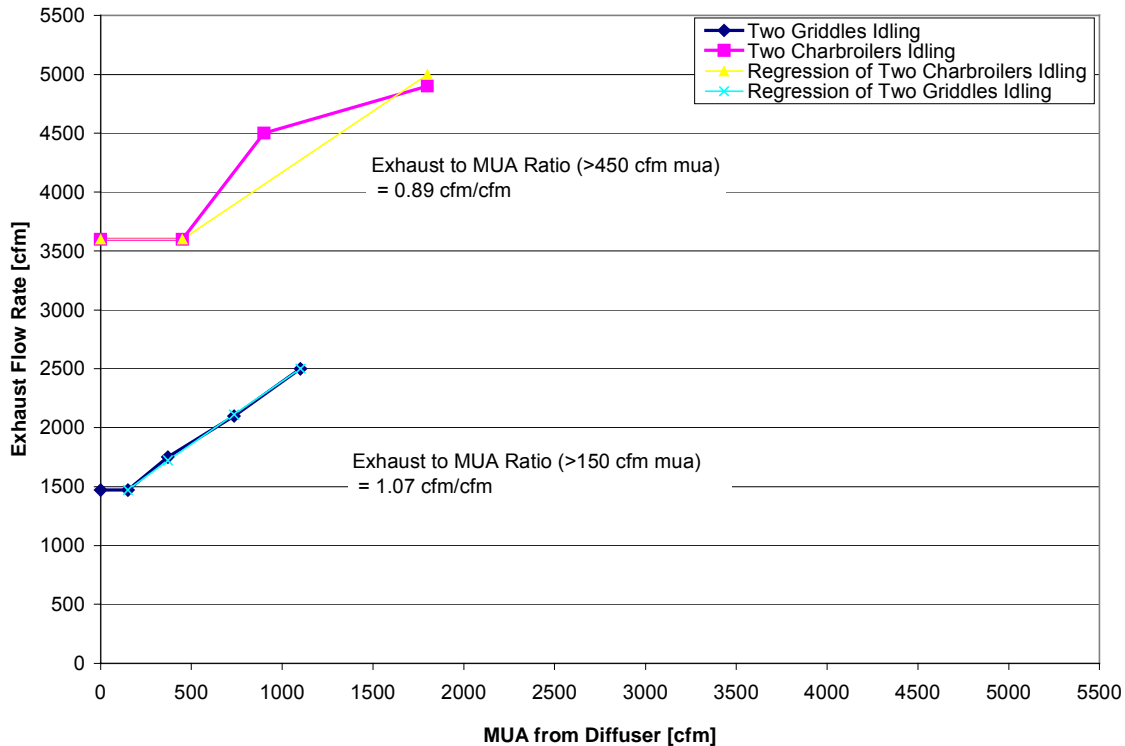

Figure 71: The Amount of Exhaust Air Required as a Function of the Amount of Air Brought in Through the Front Center 4-Way Diffuser for Two Griddles and Two Charbroilers Idling Under a Canopy Hood

The data show no effect on hood performance for two charbroilers up to 450 cfm supplied from the front center 4-way and up to 150 cfm supplied for two griddles. Beyond the 450 cfm flow rate for the charbroilers; if a slope were regressed using the remaining data points, the exhaust to local MUA ratio would be 0.88 cfm exhausted for every cfm supplied through the 4-way diffuser. If a slope were determined in the same manner for the griddles, the exhaust to local MUA ratio would be 1.07 cfm exhausted for every cfm supplied through the 4-way diffuser.

The difference in exhaust to local MUA ratios shows the sensitivity of appliance duty to MUA introduced through a front center 4-way. The medium duty griddles were slightly more sensitive than the heavy-duty charbroilers. It could be that a higher velocity diffuser jet is required to disrupt the stronger thermal plume created by the charbroilers. Conversely, the

relatively weak griddle plume is more sensitive to the diffuser jet. The result is shown in the exhaust to local MUA ratios. The larger ratio (or higher exhaust flow rate requirement) of the two griddles infers a greater sensitivity to the 4-way diffuser jet. The difference in ratios implies a 13 percent greater effect on two griddles idling than two charbroilers idling.

4.5 Short Circuit Supply

With increasing energy prices, engineers and end users wanted a way to satisfy the code-mandated exhaust flow rates, while reducing the net volume of conditioned air being removed from the kitchens. They observed that oftentimes the exhaust rate was excessive for the cooking process, and significant cost savings could be realized.

To realize a cost savings, untempered air was introduced inside the hood and was generally directed at the exhaust filters, effectively “short circuiting” the room’s air conditioning system. The volume of air introduced internally was typically increased until spillage occurred, then reduced a small amount to regain acceptable performance. Since the exhaust flow rate was not adjusted, the hood still satisfied the building code requirements, while removing less conditioned air from the space (net exhaust from the space). And when the short circuit hood’s cost of additional fans, ductwork, and more complicated design were compared with the savings provided by reducing the volume of conditioned air from the space, the analysis favored the short circuit design and many units were installed over the years.

Today, a majority of kitchen exhaust hoods are listed under UL Standard 710, which allows hoods to be installed at exhaust rates below the mandated code rates. However, short circuit hoods still exist and are being marketed as a successful means of reducing the amount of tempered air removed from the kitchen. Many of these hoods are listed with exhaust rates well under code requirements and with a very high percentage of short circuit air. With these airflow rates, the exhaust system is working mostly to remove the short circuit air, with little capacity remaining to exhaust the cooking process.

To evaluate the short circuit hood design, a canopy hood was selected from a leading manufacturer. Testing revealed high percentages of short circuit air to be detrimental to performance, while relatively small percentages could be introduced with minimal impact on performance. The installation of side panels improved hood performance and allowed slightly higher amounts of short circuit air to be introduced.

The hood failed to perform in the island configuration and in all conditions with side drafts, regardless of the amount of short circuit air being introduced. In addition, the exhaust flow rate could not be increased to achieve acceptable performance with the laboratory’s current exhaust fan, due to the restrictive characteristics of the hood’s small exhaust duct collar. Testing at 1525 cfm exhaust rate revealed that the exhaust collar static pressure was 0.62 inches of water, and a 3575 cfm exhaust rate created a static pressure of 4.42 inches of water.

4.5.1 Test Setup

The overall hood measured 8-foot 8-inches long by 4-foot 4-inches deep by 24 inches high. Exhaust and supply collars measured 8 inches deep by 16 inches long. The supply plenum discharged into the hood through a 3.25-inch wide slot. The slot was at a 45° angle along the length of the hood. The exhaust traveled through 16-inch tall baffle filters along the length of the hood. A cross section of the short circuit canopy hood is shown in Figure 72.

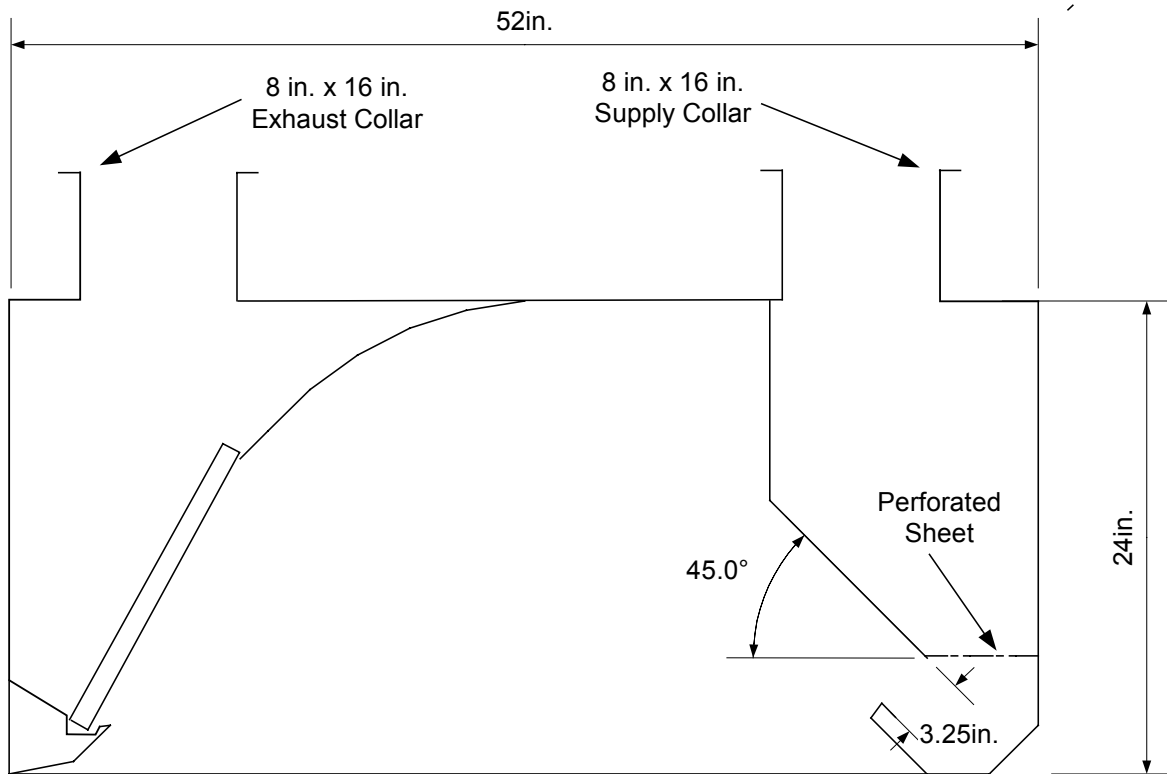

Figure 72: Cross-Section Drawing of Wall Mounted Short Circuit Canopy Hood.

A photograph of the short circuit canopy hood over two charbroilers is shown in Figure 73. The photograph illustrates the image a human eye would see with the two broilers idling at 600°F. The hood is flush against a clear plastic backwall, and the bottom edge is located 78 inches above the finished floor. A sheet metal insert is also shown between the two charbroilers. This insert was used to prevent drafts between the two appliances. The broilers are positioned within the hood footprint with a 6-inch side overhang at both ends of the hood, as well as a 6 inch front overhang measured from the front edge of the cooking surface to the inner most point of the hood's front lip.



Figure 73: View of Two Charbroilers under a Wall Mounted Short Circuit Canopy Hood from the Perspective of the Schlieren Flow Visualization System

Figure 74 and Figure 75 are schlieren images of the two broilers idling under the short circuit canopy hood. In Figure 74, the hood is exhausting 3375 cfm with 600 cfm (17 percent) being supplied with short circuit air. The plume is completely captured and contained within the hood, showing acceptable hood performance. Figure 75 shows the exhaust rate held constant and the short circuit air increased to 2100cfm (62 percent). The hood failed to contain the volume of the plume and spillage occurred. The C&C assessment for the short-circuited MUA was the most difficult situation to evaluate. The internal MUA mixed with the thermal plume and the resulting air temperature was slightly above room temperature which made spillage hard to qualify, especially since many of the failures were along the bottom of the rear wall and away from the hood. This spillage was confirmed using smoke seeding.

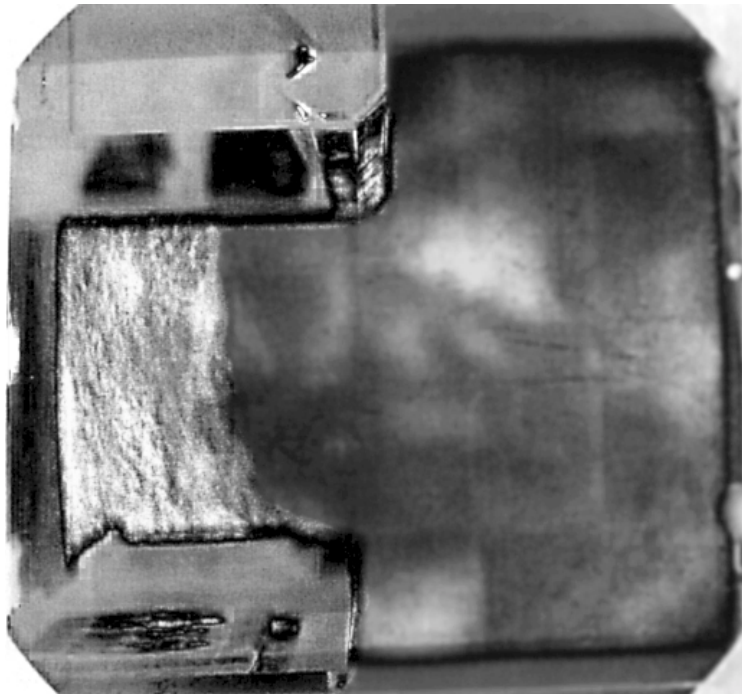

Figure 74: Schlieren Image of C&C for Two Charbroilers Idling under a Wall Mounted Short Circuit Canopy Hood Exhausting 3500 cfm with 600 cfm (17 percent) Internal MUA

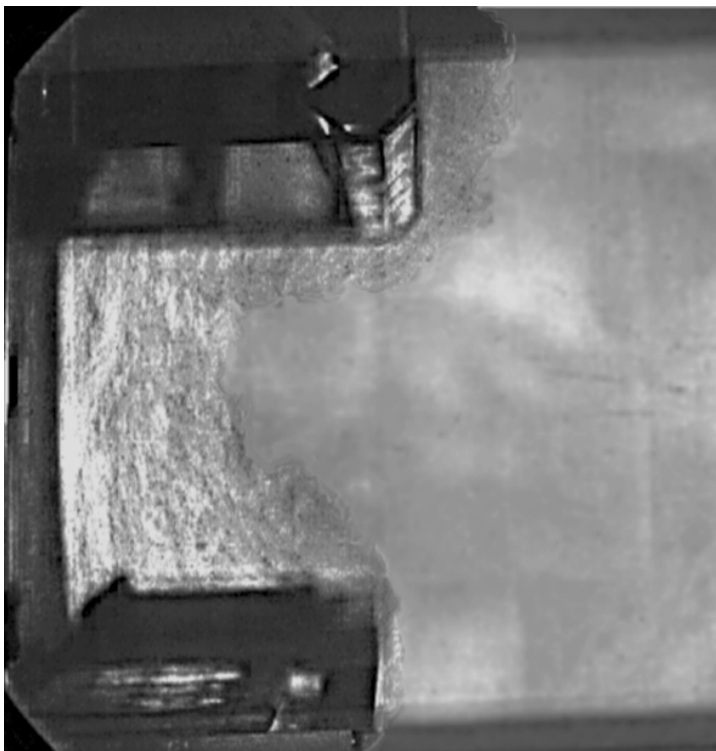

Figure 75: Schlieren Image of Wall Mounted Short Circuit Canopy Hood with Two Charbroilers Idling, Showing Spillage at 3375 cfm Total Exhaust and 2100 cfm (62 percent) Internal MUA

4.5.2 Analysis of Findings

A maximum of 21 percent and an average of 14 percent short circuit air could be supplied without diminished hood performance during the tests. Increasing beyond these levels caused failure of plume C&C. A summary of the successful short circuit air percentages is presented in Figure 76.

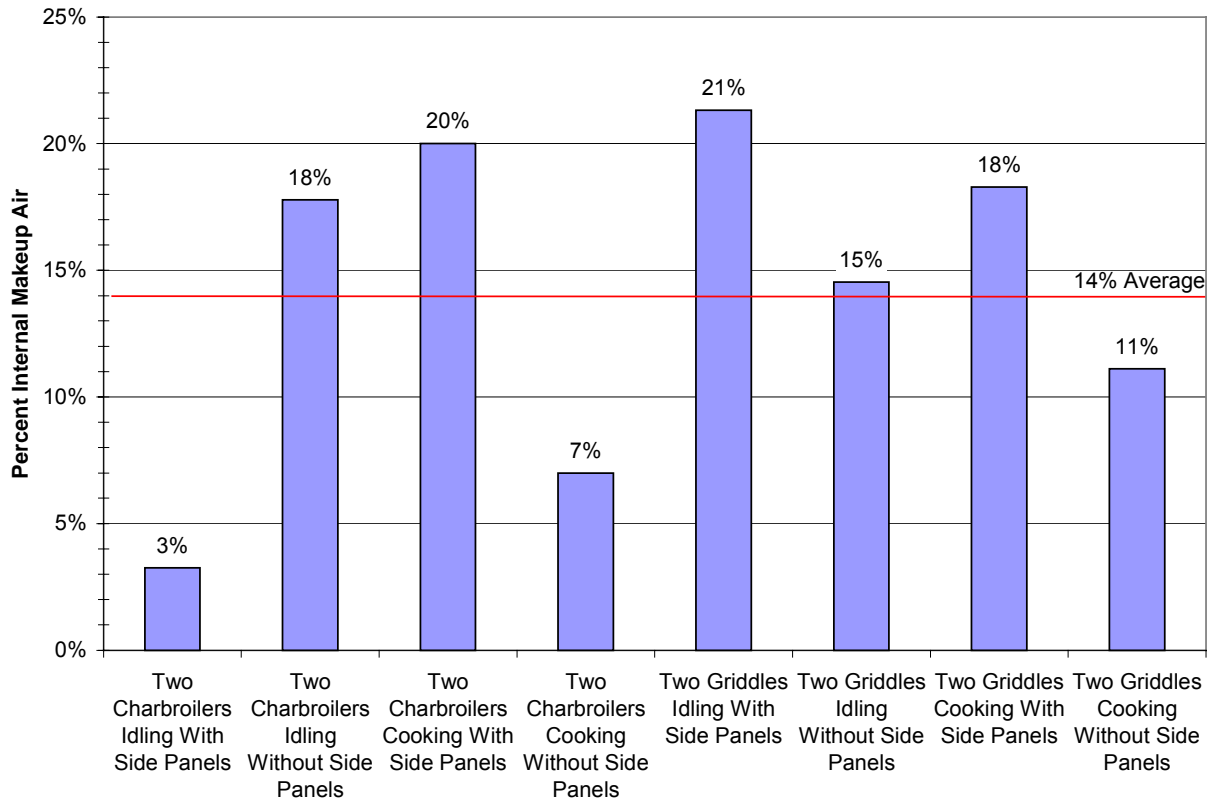

Figure 76: Summary of Successful Short Circuit Air Percentage for a Short Circuit Canopy Hood

Comparing absolute exhaust flow rates for the short circuit canopy hood revealed some general trends as graphically summarized in Figure 77. If all conditions tested (idle and cooking, with and without side panels) are considered, two medium-duty griddles required an exhaust flow rate that averaged 1925 cfm, compared to the heavy-duty charbroilers 3350 cfm average exhaust requirement. For these particular appliances, switching from medium-duty to extra heavy-duty appliances required a 1425 cfm increase in the exhaust flow rate.

The maximum short circuit air rate for exhausting two griddles was 325 cfm, with an average value of 300 cfm. For the two charbroilers, the maximum rate was 675 cfm, with an average of 405 cfm. Comparing the two average short circuit rates shows that for a higher duty appliance at a higher exhaust rate, a slightly higher volume of internal MUA can be used. In this case, an exhaust increase of 1425 cfm corresponded to a 105 cfm increase in short circuit air, resulting in a net increase of 1320 cfm exhausted from the kitchen space for the heavy-duty equipment. Average net exhaust rate was 2944 cfm for the charbroilers and 1625 cfm for the griddles. This represents a difference of 1344 cfm, or having to increase the net exhaust for charbroilers by 81 percent compared to the net exhaust for the griddles.

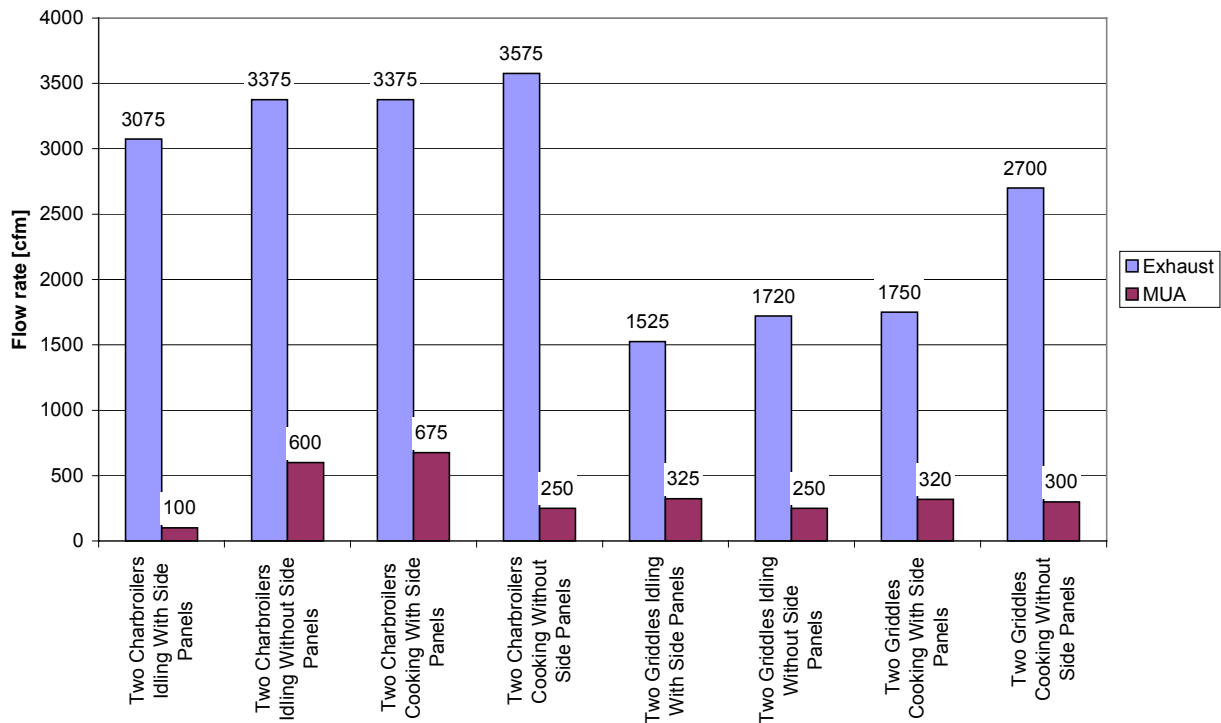

Figure 77: Summary of Successful MUA Quantity for a Short Circuit Canopy Hood

The exhaust to local MUA ratio was investigated for the short-circuit hood. There was no effect on hood performance up to 300 cfm supplied internally (11 percent). Above the 300 cfm flow rate; the internal flow of the MUA disrupted the thermal plume and typically pushed it out the rear of the hood. This led to higher requirements in exhaust flow rate for every cfm brought in internally.

In theory, during optimum conditions, for every cfm increase in MUA, a one cfm increase in exhaust air would be required. Generally speaking, our testing did support this theory. However, a data point suggested a significantly higher short circuit air percentage than did the other test points. This single test point may be in error due to the difficulty in visualizing the spillage in this configuration. When including this data point, the exhaust to local MUA ratio was 0.46; or for every one cfm of MUA introduced, the exhaust flow rate had to increase 0.46 cfm. However, when using all data points available except the questionable data point, the exhaust flow rate to local MUA ratio was 1.33, which is more consistent with the theory that the exhaust rate must increase at least as much as the increase in the short circuit air. Figure 78 shows the ratios.

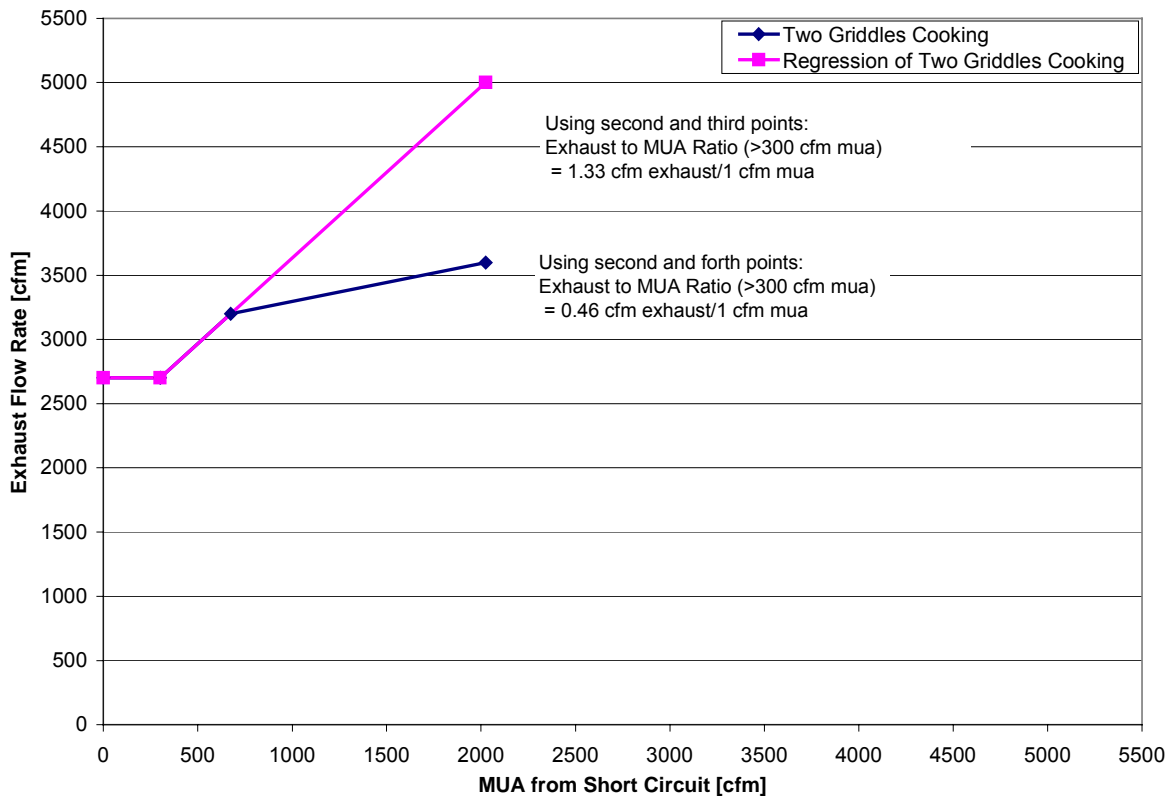

Figure 78: The Amount of Exhaust Air Required as a Function of the Amount of Internal MUA Brought into a Short Circuited MUA Hood

4.6 Backwall Supply

For backwall supply, the MUA is fed through a supply plenum that also functions as the backwall, and is discharged below the cooking surface in a downward direction. Variations include discharging downward as well as towards the rear of the cooking appliance, as was the case in the design used for this study. Backwall supply systems are catalog items for many major hood manufacturers and have been traditionally used in the southern United States. The goal of this design, as with most local MUA designs, is to provide air for the kitchen hood to exhaust at a lower cost by minimizing the tempering of the exhausted air. Ideally, the local MUA would be pulled into the exhaust air stream, and have minimal impact on the conditions in the kitchen but in reality a portion of the local MUA does enter the kitchen space.

To evaluate the backwall supply MUA design, an exhaust-only canopy hood and an exhaust only proximity hood were fitted with backwall supply systems. Both supply systems spanned the length of the hood, and were 6 inches in depth. The backwall supply for the canopy hood discharged downward through perforated screens that were located directly above the lower edge of the wall. The rear supply wall for the proximity hood had a perforated panel on its bottom surface to discharge the air downward, as well as 7 inches of perforated panel along the lower front surface of the wall to discharge the MUA towards the rear of the appliances.

The backwall supply strategy allowed significant amounts of air to be locally supplied without a detrimental effect on hood C&C performance in most cases. The local MUA was shown to mostly enter the kitchen space, rather than remain contained in the cooking zone. This local MUA entering the kitchen space may potentially creates an additional load on the kitchen, depending on the temperature of the MUA being supplied.

The canopy hood allowed a higher percentage of backwall MUA to be introduced than did the proximity hood. Introduction of a cross draft caused hood performance to severely deteriorate in virtually all cases. Installation of side panels achieved C&C at lower airflow rates, with the canopy hood benefiting more than the proximity hood. It is worth noting that the canopy was modified with quarter side panels, while the proximity hood had integrated quarter side panels and was modified using full side panels.

4.6.1 Canopy Hood Test Setup

The overall hood measured 2-feet high by 8-feet long by 4-feet deep. The exhaust collar measured 36-inches long by 14-inches deep. The exhaust traveled through 20-inch tall baffle filters along the length of the hood. Attached to the rear of the hood, the MUA supply plenum measured 4-feet high by 8-feet long by 6 inches deep, with two supply collars measuring 24-inches by 4-inches. The backwall supply unit included perforated panels 3-inches above the discharge area for better air distribution. The air discharged 7 inches below the height of the cooking surface. Figure 79 shows a cross section of the canopy hood with backwall supply.

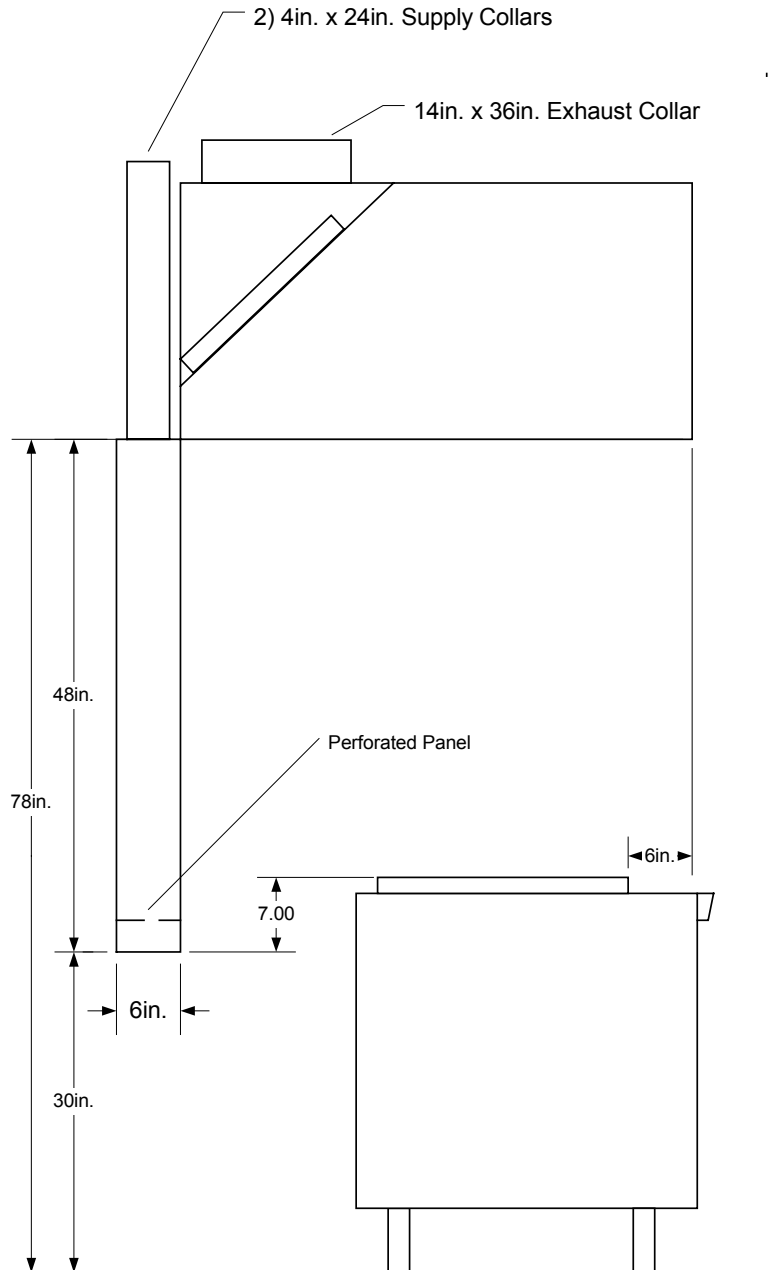

Figure 79: Cross-Sectional Drawing of the Wall Mounted Backwall Supply Canopy Hood

Figure 80 is a photograph of the canopy hood equipped with a backwall supply plenum over two gas charbroilers. The photograph illustrates the image a human eye would see with the two broilers idling at an average cooking surface temperature of 600°F. The hood's lower edge was located 78-inches above the floor and the discharge area of the backwall supply plenum was 30 inches above the floor. Behind the plenum was a clear plastic backwall. A sheet metal insert was located between the two charbroilers to prevent drafts between the two appliances. The broilers are positioned within the hood footprint with a 6-inch side overhang at both ends of the hood. Located on the floor in front of the charbroilers was a shadowgraph system. Relocating the shadowgraph system enabled the visualization of air movement along the floor, given an adequate temperature difference with the surrounding air.



Figure 80: View of Two Charbroilers under a Wall Mounted Backwall Supplied Canopy Hood from the Perspective of the Schlieren Visualization System

Figure 81 and Figure 82 are schlieren images of the two charbroilers under the backwall supply equipped canopy hood. In Figure 81, the hood is exhausting 3600 cfm with displacement only ventilation. The plume is completely captured and contained within the hood, showing acceptable hood performance. Figure 82 also shows proper C&C performance with the exhaust rate reduced to 2950 cfm and the backwall supply set at 2000 cfm (68 percent). Both are acceptable for proper C&C. The 650 cfm (18 percent) decrease in exhaust was possibly due to

the 2000 cfm of backwall supply air preventing room air flowing upward behind the appliances and redirecting the airflow toward the front, where the velocity could better contain the thermal plume.



Figure 81: Schlieren Image of C&C with Two Charbroilers Idling under a Wall Mounted Canopy Hood Exhausting 3600 cfm with Displacement-Only MUA

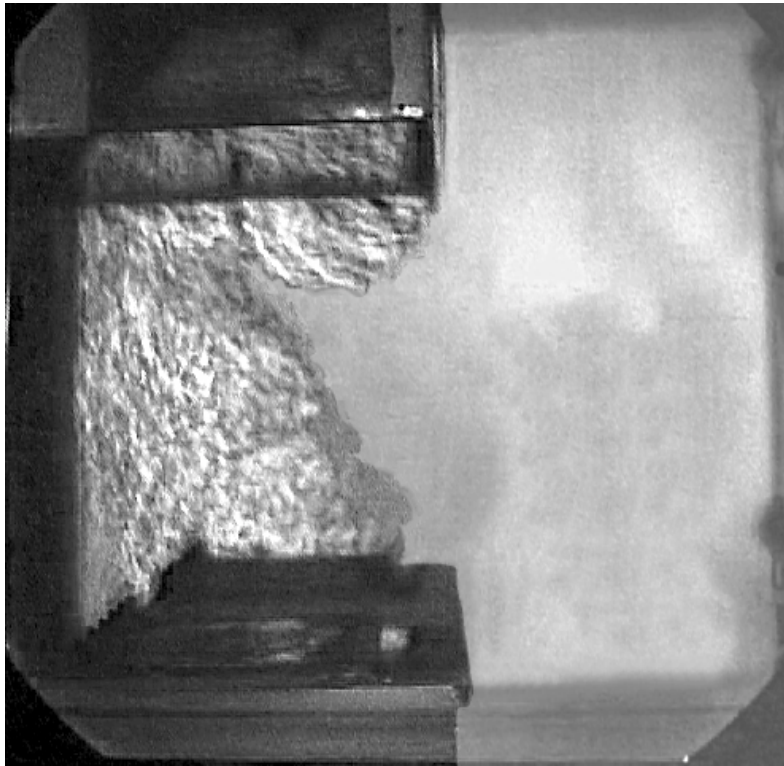

Figure 82: Schlieren Image of C&C with Two Charbroilers Idling under a Wall Mounted Canopy Hood Exhausting 2950 cfm with 2000 cfm MUA from Backwall Supply

4.6.2 Proximity Hood Test Setup

The overall hood measured 47-inches high by 86-1/2 inches long by 28-inches deep. The exhaust collar measured 18-inches long by 12-inches deep. The exhaust traveled through 11-1/2-inch tall baffle filters along the length of the hood. Attached to the rear of the hood, the supply plenum measured 62-inches high by 86-1/2-inches long by 6 inches deep, with two supply collars measuring 24-inches by 5-inches. The backwall supply unit incorporated a perforated plate across the bottom of the plenum and across the lower 7-inches of the wall surface nearest the appliances. The air discharged 9-1/2 inches below the height of the cooking surface.

Figure 83 shows a cross section of the proximity hood with backwall supply. Figure 84 is a photo of the test setup.

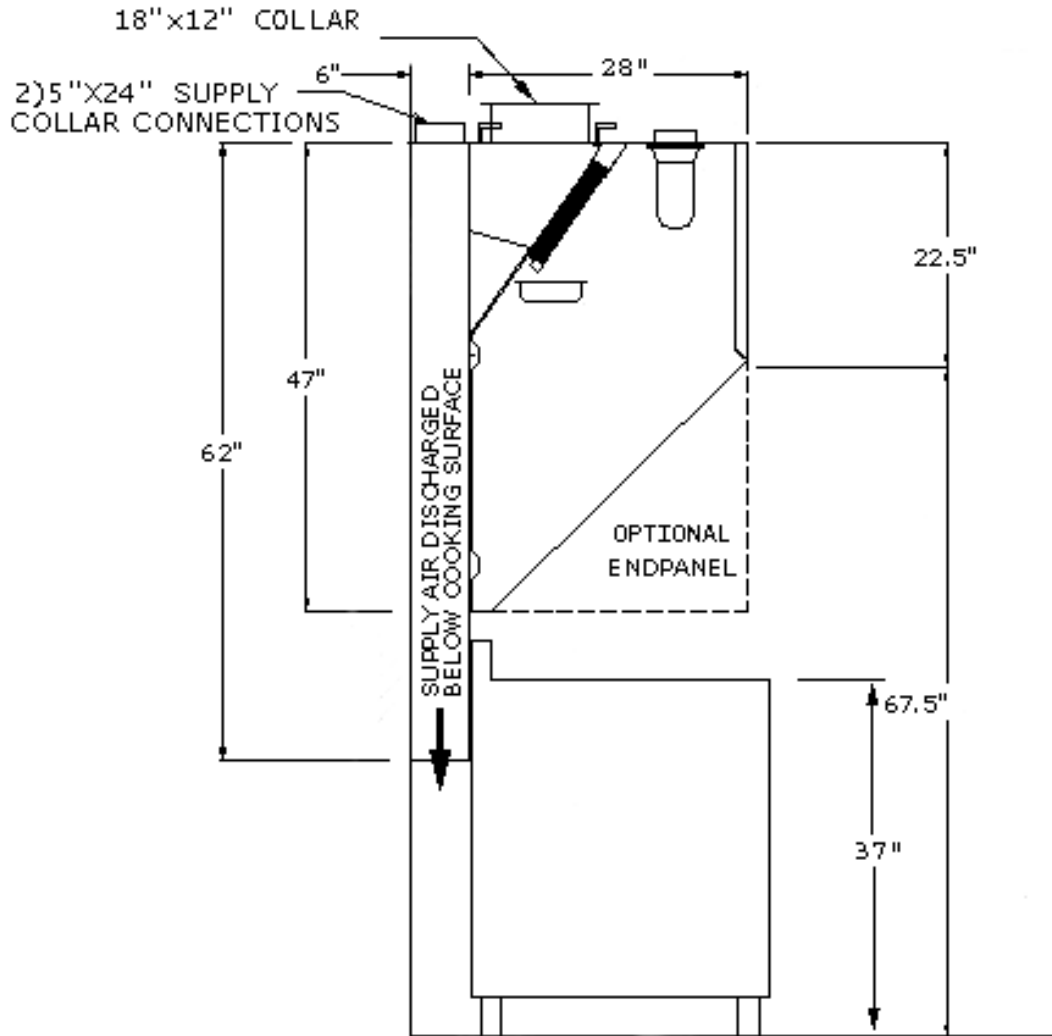

Figure 83: Cross-Sectional Drawing of the Wall Mounted Backwall Supply Proximity Hood



Figure 84: View of Two Griddles under a Backwall Supply Proximity Hood from the Perspective of the Schlieren Visualization System

Figure 85 and Figure 86 are schlieren images of the two griddles under the backwall supply equipped proximity hood. In Figure 85, the hood is exhausting 1250 cfm with 325 cfm (26 percent) from the backwall supply. The plume is completely captured and contained within the hood, showing acceptable hood performance. Figure 86 shows failure of C&C performance with the exhaust rate maintained at 1250 cfm and the backwall supply increased to 940 cfm (75 percent).

A plume at the front of the appliances pushing out into the room illustrates the path of the MUA supplied by the backwall supply. While not detrimental to hood C&C performance, a large volume of the MUA is entering the space. This MUA plume is shown clearly Figure 85 and faintly shown in Figure 86. The difference in rear supply air clarity may be due to a change in the relative temperatures of the rear supply air and the ambient laboratory air, as well as slight difference in digital photograph enhancement.



Figure 85: Schlieren Image of C&C with Two Griddles Idling under the Proximity Hood Exhausting 1250 cfm with 325 cfm MUA from the Backwall Supply



Figure 86: Schlieren Image of Spillage from the Proximity Hood Exhausting 1250 cfm with Two Griddles Idling with 940 cfm MUA from the Backwall Supply

4.6.3 Findings for Charbroilers

4.6.3.1 Charbroilers Idling

Figure 87 shows C&C rates for two gas charbroilers idling under the backwall supply equipped hoods. For similar conditions, the proximity hood required 38 percent-56 percent of the typical exhaust rate required by the wall-mounted canopy hood, but allowed a much lower percentage of MUA to be introduced from the backwall supply.

The wall-mounted canopy configuration without side panels or a cross draft required 3600 cfm when only displacement ventilation was used. At this exhaust rate, the local MUA from the backwall could be increased to 2000 cfm (56 percent) without hood performance failure. Additional airflow from the backwall supply may have been acceptable. However, the capacity of the laboratory was only able to achieve 2000 cfm in this configuration. Since the backwall supply air was at maximum, and spillage had not occurred, the exhaust rate was reduced until spillage occurred at 2950 cfm. This shows a 650-cfm reduction in the required exhaust rate due to the backwall supply system, which was still supplying 2000 cfm (68 percent). When a cross draft was introduced, C&C could not be achieved with 2000 cfm of MUA due to the capacity of the exhaust system. Adding side panels for conditions with and without the cross draft provided C&C at lower exhaust rates, while maintaining 2000 cfm of backwall supply MUA. Without cross draft, the exhaust rate could be decreased by 450 cfm (15 percent) to 2500 cfm. With a cross draft present, the hood was able to capture at an exhaust rate of 4100 cfm.

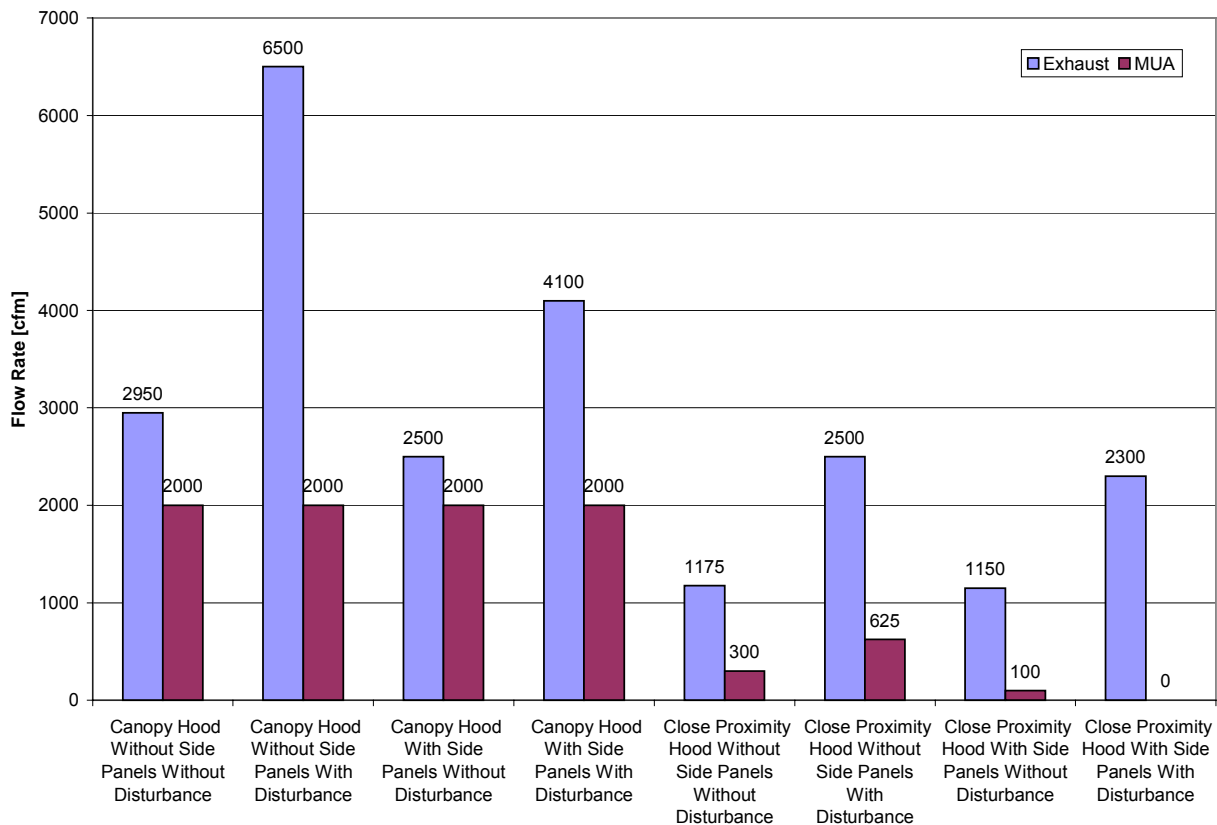

Figure 87 : MUA Comparison of Two Charbroilers Idling Under Backwall Supply Hoods

For the proximity hood case without side panels or a cross draft, 1175 cfm was required when only displacement ventilation was used. At this exhaust rate, the local MUA could be increased to 300 cfm (26 percent) without hood performance failure. When a cross draft was introduced, the exhaust rate needed to be increased by 1325 cfm (113 percent) to 2500 cfm. At this exhaust rate, the local MUA was increased by 325 cfm to 625 cfm (25 percent). Adding full side panels had minimal effect on improving the exhaust rates in either case. For conditions without a cross draft, the exhaust rate was reduced 25 cfm to 1150 cfm, while the MUA was reduced by 200 cfm to 100 cfm (9 percent). With a cross draft present, the exhaust rate was reduced by 200 cfm and required the elimination of the 625 cfm of MUA.

4.6.3.2 Charbroilers Cooking

Figure 88 shows C&C rates for two gas charbroilers cooking under the backwall supply equipped hoods. For similar conditions, the proximity hood required 36-57 percent of the typical exhaust rate required by the canopy hood, but allowed a much lower percentage of MUA to be introduced from the backwall supply. The exhaust flow rate was closer to the actual volume from the thermal plume with the proximity hood, rather than with the canopy hood. Introducing a small amount of makeup air from the backwall negatively affected the C&C

performance, since the exhaust system must ventilate the plume from the appliances, as well as a portion of the air supplied by the backwall.

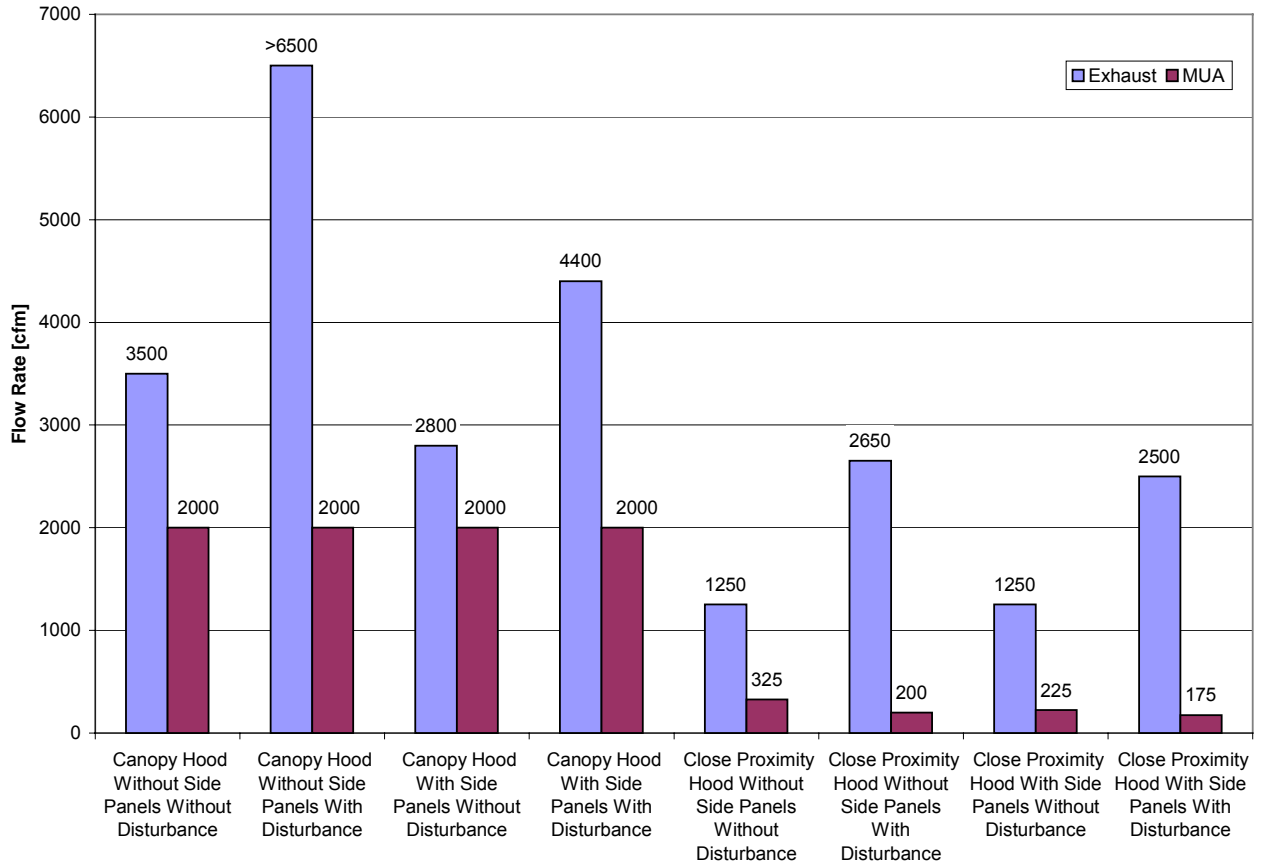

Figure 88: MUA Comparison of Two Charbroilers Cooking under Backwall Supply Hoods

The wall-mounted canopy configuration without side panels or a cross draft required 4100 cfm when only displacement ventilation was used. At this exhaust rate, the local MUA could be increased to 2000 cfm (49 percent) without hood performance failure. Additional airflow from the backwall supply may have been acceptable. However, the capacity of the laboratory was only able to achieve 2000 cfm in this configuration. Since the backwall supply air was at maximum, and spillage had not occurred, the exhaust rate was reduced until spillage occurred at 3500 cfm. This shows a 600-cfm reduction in the required exhaust rate due to the backwall supply system, which was still supplying 2000 cfm (57 percent). When a cross draft was introduced, C&C could not be achieved with 2000 cfm of MUA due to the capacity of the exhaust system. Adding side panels for conditions with and without the cross draft provided C&C at lower exhaust rates, while maintaining 2000 cfm of backwall supply MUA. Without a cross draft, the exhaust rate decreased by 700 cfm (20 percent) to 2800 cfm. With a cross draft present, the hood was able to capture at an exhaust rate of 4400 cfm.

For the proximity configuration without full side panels or cross draft, 1250 cfm was required when only displacement ventilation was used. At this exhaust rate, the local MUA could be increased to 325 cfm (26 percent) without hood performance failure. When a cross draft was

introduced, the exhaust rate needed to be increased by 1400 cfm (112 percent) to 2650 cfm. At this exhaust rate, the MUA was decreased by 125 cfm to 200 cfm (8 percent). Adding full side panels had a minimal effect on improving the exhaust rates in either case. For conditions without a cross draft, the exhaust rate was maintained, while the MUA was reduced by 100 cfm (31 percent) to 225 cfm. With a cross draft present, the exhaust rate was reduced 150 cfm and required a 50-cfm (22 percent) reduction of the MUA flow rate to 175 cfm.

4.6.4 Findings for Griddles

4.6.4.1 Griddles Idling

Figure 89 shows C&C rates for two gas griddles idling under the backwall supply equipped hoods. For similar conditions, the proximity hood required 38 percent-56 percent of the typical exhaust rate required by the wall-mounted canopy hood. The net volume of air removed from the space was lower with the proximity hood in 3 out of 4 tests.

The wall-mounted canopy configuration without side panels or a cross draft required 1475 cfm when displacement ventilation was used. At this exhaust rate, the local MUA could be increased to 900 cfm (61 percent) without hood performance failure. When a cross draft was introduced, C&C could not be achieved due to the capacity of the exhaust system. Adding side panels resulted in a 190-cfm exhaust flow reduction for conditions without a cross draft, but could not help achieve capture with a cross draft.

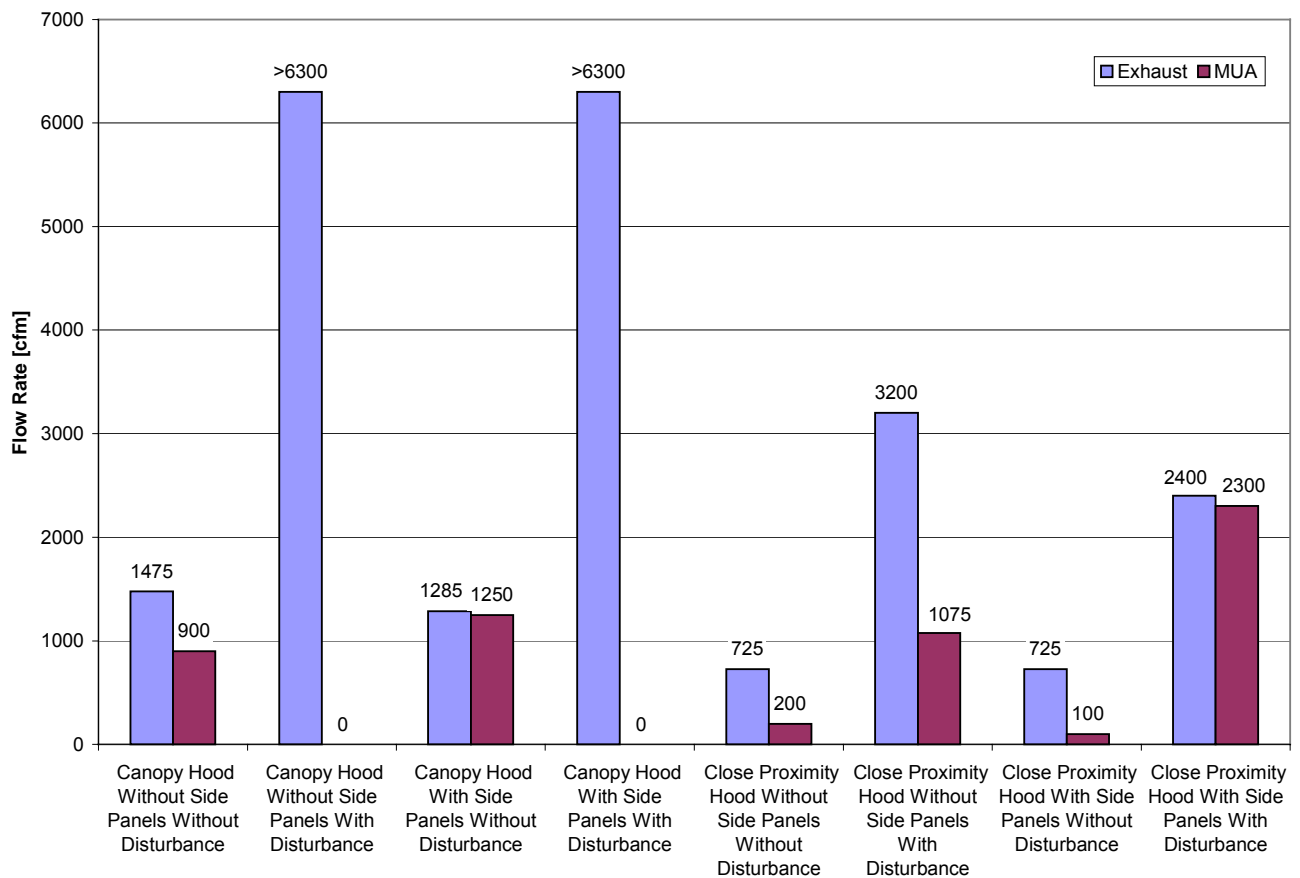

Figure 89: MUA Comparison of Two Griddles Idling under Backwall Supply Hoods

For the proximity configuration without full side panels or an air cross draft, 725 cfm was required when displacement ventilation was used. At this exhaust rate, the local MUA could be increased to 200 cfm (28 percent) without hood performance failure. When a cross draft was

introduced, the exhaust rate needed to be increased by 2475 cfm (343 percent) to 3200 cfm. At this exhaust rate, the MUA was increased by 875 cfm to 1075 cfm (34 percent). When full side panels were installed, the exhaust rate without a cross draft was unchanged, but required a 100-cfm decrease in the MUA to 100 cfm. With a cross draft, the side panels reduced the required exhaust flow by 800 cfm to 2400 cfm. In this configuration, testing proved the MUA could be operated at 2300 cfm (96 percent) with acceptable C&C performance.

Due to the unusually high percentage of MUA being acceptable, further evaluations were performed, including seeding the effluent with smoke, seeding the MUA with smoke and verifying the sensitivity of the visualization systems. The testing showed that the local MUA was entering the space outside the hood, but did not show any visible spillage of effluent into the space. Consideration should be given to further testing of backwall supply proximity hoods.

4.6.4.2 Griddles Cooking

Figure 90 shows C&C rates for two gas griddles cooking under the backwall supply equipped hoods. For similar conditions, the proximity hood required 42 percent-49 percent of the typical exhaust rate required by the canopy hood. The net volume of air removed from the space was significantly lower with the proximity hood in 3 out of 4 tests.

The wall-mounted canopy configuration without side panels or a cross draft required 1950 cfm when displacement ventilation was used. At this exhaust rate, the MUA could be increased to 200 cfm (10 percent) without hood performance failure. When a cross draft was introduced, C&C was achieved at 5700 cfm with the elimination of the MUA from the backwall supply. Adding side panels resulted in a 175 cfm exhaust flow reduction for conditions without a cross draft. Adding side panels showed proper C&C performance with a 1450 cfm increase in air being supplied from the backwall supply to 1650 cfm (96 percent). When side panels were installed during conditions with a cross draft, a 300-cfm increase in exhaust flow was required, but allowed 2800 cfm of MUA to be introduced from the backwall supply. This small exhaust increase is most likely a testing anomaly and is potentially due to the more aggressive makeup airflow rate.

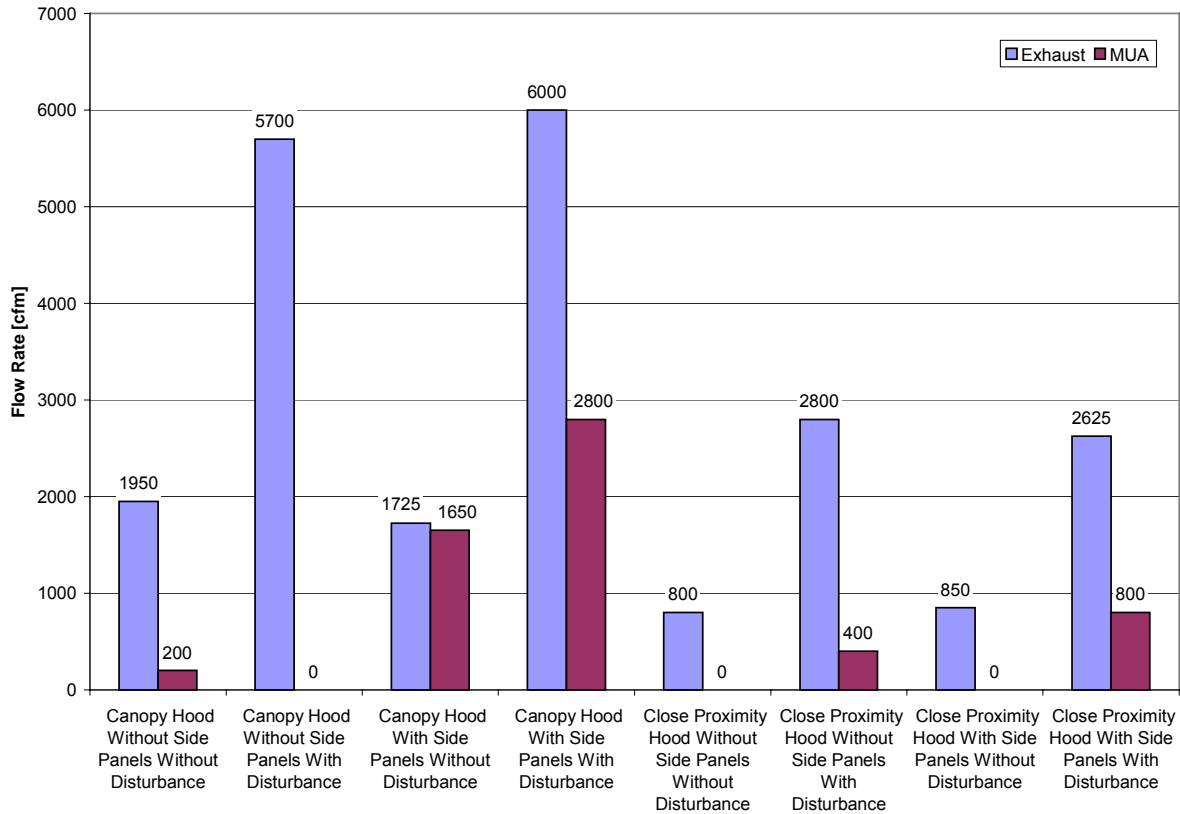

Figure 90: MUA Comparison of Two Griddles Cooking under Backwall Supply Hoods

For the proximity configuration without full side panels or a cross draft, 800 cfm was required when displacement ventilation was used. At this exhaust rate, the backwall supply was unable to supply MUA without causing failure of C&C performance. When a cross draft was introduced, the exhaust rate needed to be increased by 2000 cfm (250 percent) to 2800 cfm. At this exhaust rate, the MUA was increased to 400 cfm (14 percent). When full side panels were installed, the exhaust rate without a cross draft increased 50 cfm (6 percent) to 850 cfm, and maintained the MUA at 0 cfm. With a cross draft, the full side panels reduced the required exhaust flow by 175 cfm to 2625 cfm. In this configuration, testing proved the MUA could be operated at 800 cfm (30 percent) with acceptable C&C performance.

The exhaust to local MUA ratio was calculated for the backwall strategy for both charbroilers cooking under a proximity hood and griddles cooking under a wall-mounted canopy hood. The exhaust to local MUA ratio for the griddles under the canopy hood was 0.07, and for the charbroilers under the proximity hood was 0.16. Figure 91 shows the data.

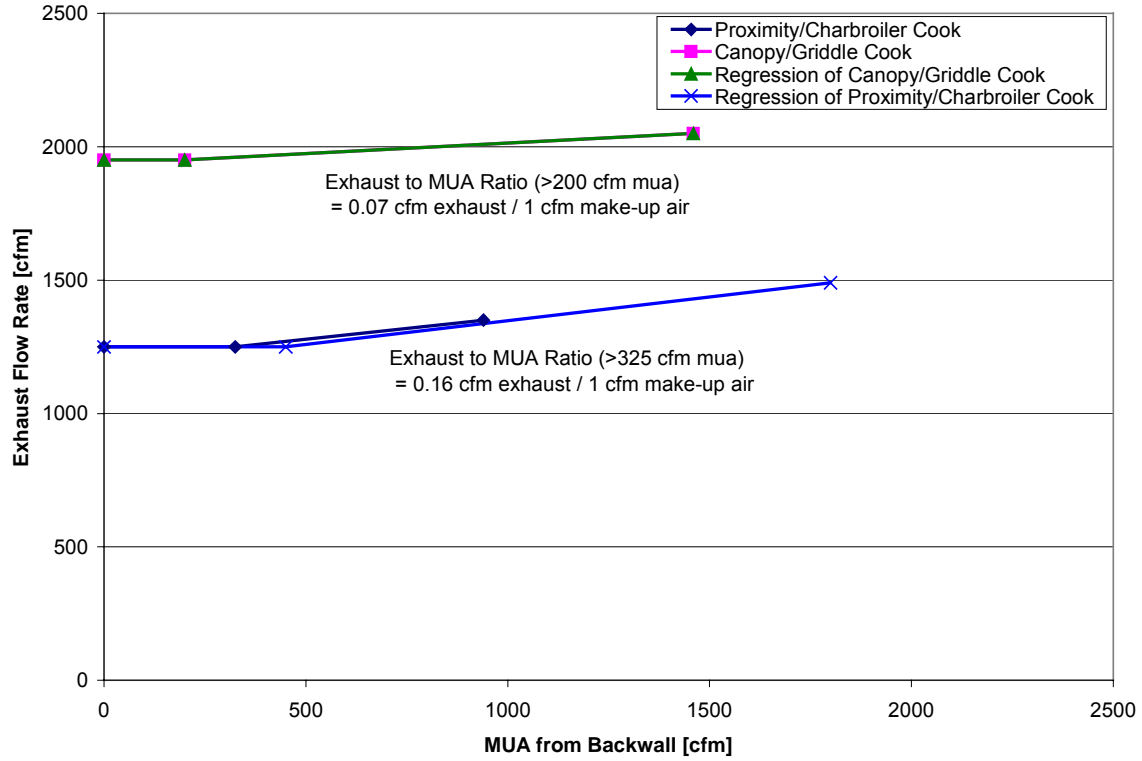

Figure 91: The Amount of Exhaust Air Required as a Function of the Amount of Air Brought in Through the Backwall Supply Plenum

5.0 Outcomes

The primary hypothesis of the study was the following:

If the MUA strategy were to have no effect on hood performance (i.e., equivalent to the displacement base-case condition), then it would be possible to replace 100 percent of the air exhausted through the MUA configuration being investigated.

The assessment process used two methods to compare the influence of local MUA on hood performance. For most cases, the hood exhaust rate was held constant at the displacement case C&C threshold while gradually increasing the MUA supply flow until spillage of effluent was observed. For the ceiling diffuser cases, the MUA was set at 1000 cfm and then the exhaust rate was adjusted until C&C was achieved.

Results for specific MUA strategies, hood styles, cross drafts, side panels, recommendations for future research, and general conclusions, including limitations of the study, are discussed in separate sections within this chapter.

5.1 Outcomes Specific to MUA Strategy

The results for the baseline case, displacement ventilation are discussed first, and then each MUA strategy in turn from most the most intrusive to the least intrusive.

5.1.1 Displacement Ventilation (Base Case)

Displacement ventilation was the baseline for the study because it provides a uniform, nearly laminar bulk airflow. From past testing experience, low velocity bulk supply attains C&C with the lowest exhaust flow rate. The displacement system replicates transfer air from an adjoining space under good design conditions. It also allowed parameters other than locally distributed MUA to be evaluated, such as hood type geometric differences, cross draft effects and side panels.

Using a proximity hood instead of a wall-mounted canopy hood over the same appliances allowed a reduction in exhaust rate as high as 59 percent (1150 cfm) for the griddles and 70 percent (2850 cfm) for the charbroilers (for base case cooking conditions, no side panels, no drafts).

The testing revealed that the greatest increase in exhaust flow rate was required for cross drafts. The airflow required to properly capture and contain the plume increased 2750-cfm (141 percent) for the griddles during a cooking condition and in some cases could not be increased enough to perform properly. Generally, the cross drafts affected the griddles more so than the charbroilers. This observation is likely due to the higher temperatures in the charbroiler plume creating a stronger buoyancy effect and updraft velocity.

Side panels allowed a reduction in the exhaust rate to a greater degree for cross draft situations than without cross drafts, and for charbroilers more than griddles. Side panels permitted a 1000 cfm (19 percent) reduction for the case of two charbroilers under the 8-ft. wall-mounted canopy hood with cross drafts. Full side panels on the proximity hood over the charbroilers had a marginal effect on reducing the C&C flow rate. The difference in performance may be attributed to the following factors:

- A proximity hood has higher C&C efficacy than a canopy hood (C&C efficacy means the ability of a hood to capture and contain a given thermal plume using the least amount of replacement air).
- Side panels on a canopy hood have a greater relative effect in bringing the hood edges closer to the appliances compared to the proximity hood, which by its design has hood edges that are closer to the appliances.
- In addition, the proximity hood's integrated partial side panels were compared to full side panels whereas the canopy hoods compared operation without side panels to operation to partial side panels.

5.1.2 Air Curtain

The air curtain MUA strategy was the worst performing design for this project, even at very low supply rates. For the test conditions where C&C was achieved, the average percentage of local MUA through the air curtain was about 10 percent of the exhaust rate. At local MUA flow rates greater than 10 percent, the exhaust airflow had to be increased by almost ten cfm for every one cfm of air delivered by the air-curtain strategy in order to maintain C&C. Performance of the tested air curtain suggests that this strategy is highly sensitive to design geometry and local MUA flow rate – consequently, there may be better performing designs available. Although the degradation of performance was much greater than anticipated at the onset of the study, it is consistent with anecdotal experience of the CKV industry. Several hood manufacturers recommend that the percentage of MUA supplied through an air-curtain be limited to less than 20 percent of the exhaust rate. The data generated by this study can be used effectively within CKV design guidelines and the ASRHAE Handbook to caution designers about the application limitations of air curtains.

5.1.3 Short Circuit

The short circuit strategy did not perform well. For the test conditions where the hood was able to achieve C&C of the plume, the average allowable short circuit supply rate was 14 percent and the maximum possible was 21 percent. Operation above 21 percent of the exhaust rate, such as at typical short-circuit specifications of 50 percent, 75 percent or 80 percent of exhaust rate, resulted in the hood's failure to capture and contain the effluent plume. To achieve short circuit airflow rates of 50 to 80 percent usually requires increasing the exhaust rate above the base case, which of course increases fan energy use and costs.

The short circuit hood performance may be explained by conservation of mass-flow theory. When a short-circuit hood is exhausting at a threshold C&C condition, and the short-circuit supply flow rate is increased, then the exhaust flow rate must be increased by an equal amount to prevent spillage from the hood reservoir. In other words, an increase of 1 cfm in supply would require an increase of 1 cfm in exhaust. This reflects an incremental exhaust-to-supply flow ratio of 1:1 and the fact that supplying more short-circuit air into the hood reservoir simply requires an equal increase in the exhaust rate, thus defeating the original intent of the strategy. In other words, if 100 percent of the exhaust airflow is supplied by the short circuit source, the difference in net exhaust (i.e., the total hood exhaust airflow rate less the makeup airflow rate delivered directly to the interior of the hood cavity) becomes zero.

Unfortunately, there were limitations within the experimental setup and design that prevented graphic schlieren documentation of the negative impact that supplying air in this fashion has on hood performance. Based on testing with smoke seeding, it appears that effluent spillage from the hood reservoir, as the flow of short-circuit air is increased, occurs in a diffused and mixed condition along the back of the appliances, exiting the hood footprint near floor level. The temperature of this spilled mixed air is reduced and not easily observed using the schlieren system.

5.1.4 Front Face

Front face supply has been widely promoted by hood manufacturers and is representative of a large population of systems in commercial kitchens. It was the local MUA strategy that the research team had anticipated would least impede the performance of the exhaust hood. Results of testing demonstrated otherwise, as the front face supply significantly compromised the ability of the exhaust hood to capture and contain. In a fashion similar to the air curtain, the velocity of the MUA tended to aggressively “pull” the effluent plume from beneath the hood. For the test conditions where the hood was able to achieve C&C of the plume, the average percentage of MUA allowable from the front face was about 14 percent.

An important caveat to this observation was the fact that the front-face plenum and perforated grille tested was not a manufacturer’s catalogue item. It had been designed and fabricated within the scope of the research project to facilitate switching from the air-curtain to face-discharge configuration. Although the air-curtain component probably was representative of typical off-the-shelf designs, the face supply may not be representative of manufacturer-specific designs. Since modifications that were made to the front-face plenum by the researchers resulted in significantly improved hood performance, it is hypothesized that design differences from one manufacturer to another could influence the impact of this MUA strategy.

5.1.5 Four Way Ceiling Diffuser

This study focused on documenting what has been anecdotally reported as being the worst type of ceiling diffuser to install in the vicinity of an exhaust hood – namely, a 4-way louvered diffuser. Five four-way ceiling diffusers were mounted at a distance of about two feet from the diffuser to the vertical face of the hood. These were tested one at a time to determine sensitivity to location. The most sensitive location was centered left to right along the face of the hood. The remaining tests were performed by introducing local makeup air through this diffuser. For the single diffuser test setup under all test conditions, the average percentage of MUA allowable from the diffuser was about 15 percent of the exhaust rate.

In general, the average increase in exhaust flow rate for the canopy hood cases due to 1000 cfm introduced from the front center 4-way diffuser ranged from 350 to 650 cfm compared to the displacement only case. The key to successful use of ceiling diffusers (of all types) is to assure that the air velocity at the hood entrance is relatively low (50 fpm or less). While determining location sensitivity, it was found that the connection between the 4-way diffuser and the ductwork had a significant effect on the velocity distribution from the diffuser.

Four-way diffusers located close to kitchen exhaust hoods operating at maximum design flow rates may have a detrimental effect on hood performance. C&C performance is affected by the

airflow from the diffuser moving across the lower edge of the hood and entraining the thermal plume. The greater the vertical velocity of the air at the lower edges of the hood, the worse the effect. This downward velocity from the diffuser entrains the thermal plume along the lower edge of the hood and spills effluent into the kitchen. The maximum velocity at the lower edge of the hood is dependent on the airflow rate and throw of the particular diffuser, as well as the velocity of the replacement air moving into the hood reservoir.

5.1.6 Backwall Supply

The back-wall supply configuration was the most successful local air introduction strategy tested. The percentage of MUA supplied from the backwall supply while maintaining acceptable hood performance was the highest tested for the study.

The canopy hood was able to use a higher percentage of MUA from the backwall supply system (average 46 percent) than the proximity hood (20 percent average). However, the proximity hood design used between 36 percent - 57 percent of the exhaust flow and net replacement flow rates required by the canopy hood.

5.1.7 Summary: Influence of MUA Strategy on C&C Exhaust Rate

What was not anticipated during the design of the study was how sensitive the C&C threshold would be to the local introduction of MUA. Spill conditions often were observed when as little as 10 percent of the exhaust rate was supplied by a given MUA strategy.

Figure 92 shows the trends for changes in exhaust airflow rate as makeup airflow rate increases for each of the strategies tested. The graph shows that the air curtain strategy required the most exhaust volume increase and the backwall supply strategy required the least. These trends reflect the relative amount of disturbance that each MUA strategy had on plume stability, and hence C&C, for the conditions tested. These trend lines are revealing, as most of the strategies investigated required significant increases in the exhaust rate to overcome the negative impact of the MUA introduction.

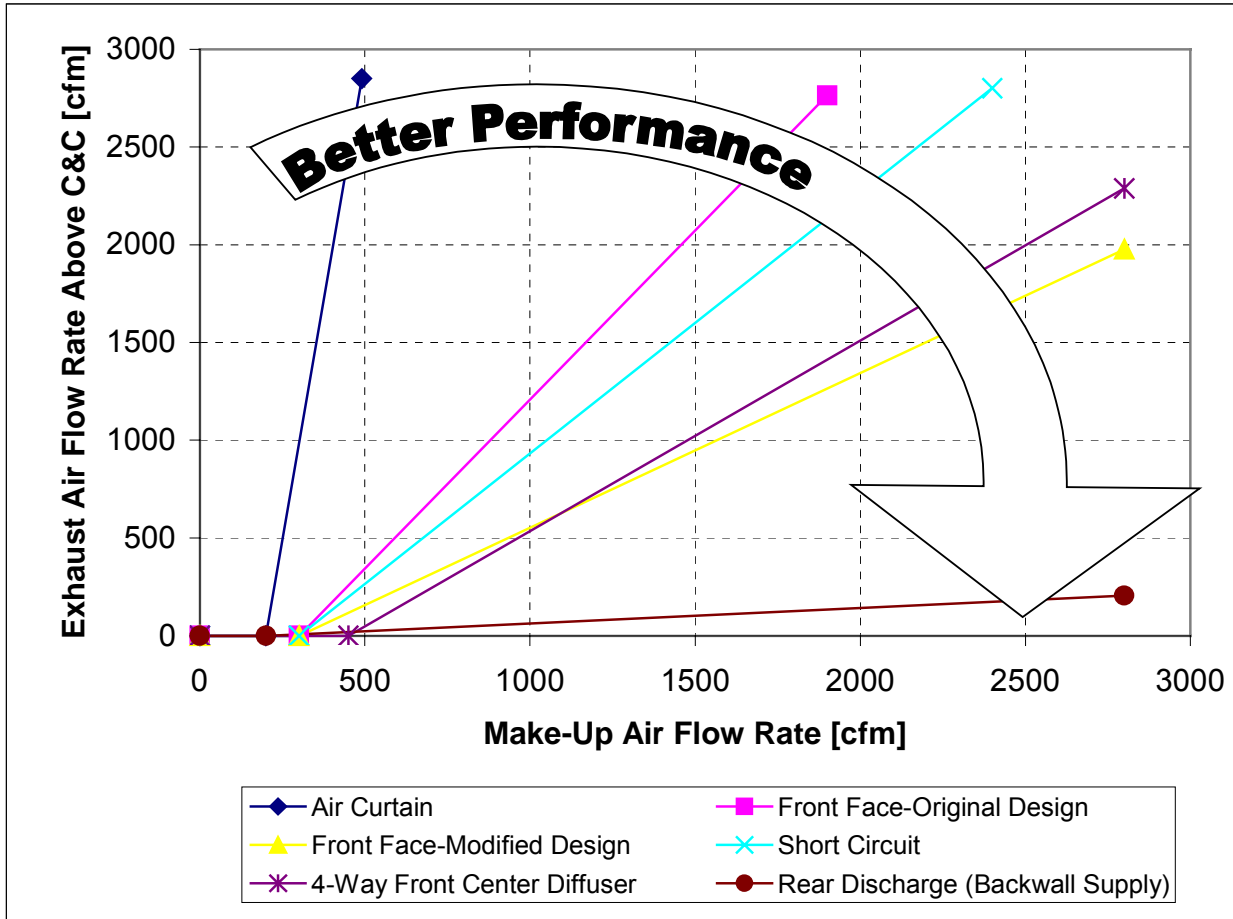

Figure 92: Summary of Exhaust to MUA Airflow Rate Trends

5.2 Outcomes Specific to Hood Design

5.2.1 Hood Style

As anticipated in the design of this study, hood type had a significant impact on the exhaust rate required for C&C over the tested appliances. The results confirmed that the island mounted canopy hood required the highest exhaust rate, the wall mounted canopy hood required less, and the proximity hood required the least. The island canopy hood proved to be more sensitive to the effects of MUA velocities and air disturbances when compared to the wall mounted canopy hood. Increases in exhaust rate ranged from a few percent to unmeasurable because the exhaust capacity of the lab was exceeded.

5.2.2 Side Panels

The installation of side panels improved C&C performance in static conditions (average 10 – 15 percent exhaust reduction) and in dynamic conditions (up to 35 percent exhaust reduction). Tapered quarter side panels were evaluated for the canopy hood designs. For the proximity hood, tapered side panels were part of the hood design, so the application of full side panels

was evaluated. Side panels are not appropriate for single island canopies and were not evaluated for this configuration.

5.3 Outcomes Specific to Room Conditions

Kitchen activities that can disrupt thermal plumes include walking by the cooking areas, opening and closing doors and drive through windows, and preparing food under the hood. If a portable fan is in the kitchen to provide comfort to the workers, it may have a constant and potentially strong negative influence on the hood's performance.

To give a representative example of the effect of room dynamics on hood performance, a 16-inch pedestal fan was used for this study. Test results showed that the disturbance caused by the cross draft of the fan had a detrimental effect on all hood and appliance combinations. As anticipated, cross drafts had the greatest impact on the island-mounted hood, since all four sides are open to the space. Subjecting the island canopy hood, in all MUA configurations, to the fan-generated cross draft caused the laboratory exhaust fan to top out at maximum capacity. For example, the cross draft required that the exhaust rate be increased by 238 percent while testing griddles cooking with displacement ventilation, but C&C could not be achieved.

C&C for the short circuit canopy hood could not be achieved for any test configuration having cross drafts. The exhaust collar of this particular hood was too small and could not draw enough air to achieve C&C. The air curtain wall mounted canopy hood required a 37 percent average increase. Along with the increased exhaust rate, the air curtain flow rate needed to be reduced an average of 13 percent, and in many cases completely turned off. The backwall supply canopy hood was able to capture and contain the effluent in a majority of the tests, requiring an average increase in exhaust rate of about 50 percent. The backwall supply proximity hood, which operated at lower flow rates than the canopy hood configuration, required an average increase in exhaust rate of about 60 percent.

5.4 Outcomes Specific to Appliances

Under all test conditions, exhaust rates for idling conditions were less than for cooking conditions. Using two-speed or variable exhaust flow rates for idle and cooking conditions would minimize operating costs by operating at higher airflow requirements only as needed. Appliances idle for much of the day in commercial and institutional kitchens, so energy savings and environmental impact could be significant over time.

An increase in side overhang greatly improves the ability of a hood to capture the thermal plume from an appliance. When a single appliance was moved from the center of an 8-foot hood to a 6-inch side overhang the C&C exhaust flow rate increased 225 cfm (18 percent) for one griddle idling and 750 cfm (27 percent) for one charbroiler idling. Side overhang has more influence on C&C for heavy-duty appliances such as charbroilers.

The influence of diversity in appliance operation on C&C exhaust rates is not a linear relationship. The C&C exhaust flow rate was only reduced by 15 percent when operating over one griddle idling versus two griddles. Similarly, for one charbroiler idling instead of two, the exhaust rate was reduced by 24 percent, not by 50 percent as might be expected. Additionally, the open area of the hood perimeter and the appliance setback distance are other factors that influence the C&C rate as appliances are turned on or off.

Plumes from a thermostatically controlled appliance can differ greatly while the appliance is cycling off and on. When thermostatically controlled appliances such as gas griddles are on, a strong plume is present. When the burners cycle off because the cooking surface is at set point, most of the plume from the burner area is eliminated, and the cooking surface becomes the major plume source. Further testing regarding the appliance burner duty cycle and alternative routing of the combustion products may reveal additional optimization potential.

Heat gain to space generated by cooking appliances is affected more by the amount of hood shielding than the number of appliances. Two charbroilers idling under an 8-foot hood produced a heat gain of 17.7 kBtu/h. For one charbroiler under a 5-foot hood with similar overhang, but half the input, the heat gain was not 50 percent, but 80 percent at 14.2 kBtu/h. Increasing the effective overhang by operating one charbroiler under an 8-foot hood decreased the heat gain to 69 percent of the two-charbroiler value (12.2 kBtu/h). Testing with griddles showed similar results, but with overall lower heat gain rates.

Differences in the strength of the thermal plume based on appliance duty rating influenced net exhaust rate. The displacement case with two charbroilers idling, without side panels and cross drafts, required 145 percent higher exhaust rate than two griddles idling. Also, cross drafts affected two griddles more than two charbroilers, reflecting the weaker plume strength of the griddles compared to the charbroilers.

6.0 Conclusions and Recommendations

6.1 General Conclusions

The strategy used to introduce replacement (makeup) air may significantly impact hood performance and should be a key factor in the design of kitchen ventilation systems. MUA introduced close to the hood's capture zone may create local air velocities and turbulence that result in periodic or sustained failures in thermal plume C&C. Furthermore, the more MUA supplied (expressed as a percentage of the total replacement air requirement), the more dramatic the negative effect.

The experimental design incorporated a test setup that produced a steady state, worst-case cooking effluent challenge for each combination of appliance/hood/MUA system that was investigated. This allowed the effects of a given MUA strategy and airflow to be documented and compared to each other with a level of confidence. However, this condition of peak effluent production may only represent a fraction of appliance operating time in a working kitchen. Thus the failure of an exhaust hood to capture and contain due to a MUA disturbance may not be continuous. The negative impact of a specific MUA strategy may be suppressed on a time-weighted basis to such an extent that the food service operator is not be aware of the compromised performance.

The evaluation a MUA strategy and condition on hood performance commenced with the exhaust rate set to the threshold value that exhibited complete C&C with an ideal MUA supply (i.e., displacement, base case condition). If a designer of a CKV system applied a significant safety factor to the exhaust ventilation rate, then the negative impact of a MUA supply strategy may be suppressed.

The influence of MUA being supplied in close proximity to the exhaust hood had not been systematically investigated before this project. Consequently, the research plan was broad in scope but not exhaustive, and designed to investigate suspected failure mechanisms, including some worst-case scenarios. There are numerous configurations that were not investigated, several of which merit additional research. This factor must be considered before one extrapolates the results of this study to real-world design and manufacturer-specific MUA configurations. Although the study demonstrated the potential for a given MUA strategy to impede capturing and containing cooking effluent, we were not able to conclude that performance degradation of the exhaust system would always result from a given strategy. For example, the negative impact of a 4-way diffuser was demonstrated for a worst-case location and relatively high airflow through the diffuser. The results confirmed anecdotal experience of kitchen ventilation professionals. But one cannot conclude that all 4-way diffusers installed within the vicinity of the hood will be detrimental to the performance of the exhaust system.

Having stated this caveat, it was conclusively demonstrated that each of the MUA strategies and specific configurations tested in this study created a situation where the ability of the exhaust hood to completely capture and contain the thermal plume and/or effluents was compromised. In some cases, this was due to the generic strategy itself (air-curtain supply and short-circuit supply), while in others it was a result of design-specific features of the configuration tested (e.g., front face supply). In most cases, the negative impact exceeded the predictions of the research team.

6.2 Benefits to California

The Commission estimates that in the year 2000 food service facilities accounted for about 145 million square feet of commercial floor space, 5960 GWh of electric use and 929 MW of demand. Growth in restaurant floor space may add an additional 33 million square feet by 2012.

Based on an estimated 225 million cubic feet per minute of exhaust air from existing food service facilities in the State of California, exhaust and replacement air fan energy uses about 460 GWh and 90 MW demand. Applying the research results would lead to a reduction in electric energy use and demand of about 69 GWh and 14 MW, assuming an across the board reduction in exhaust and replacement air fan energy of 15 percent. These savings do not include cooling and heating energy associated with replacement air. Reductions up to 50 percent are possible with innovative new designs.

6.3 Recommendations

This CKV study was a general, broad-brush investigation into the impact that the supply of MUA may have on hood performance. Despite its elaborate experimental design and comprehensive test matrix, the research team recognized (relying extensively on hindsight) that the project only had scratched the surface with respect to characterizing the effects that MUA supply can have on hood performance. There are many untested combinations and permutations of MUA strategies, systems, and operating conditions that deserve additional research. Of significance, and in support of further research, was the fact that all MUA configurations tested (with respect to the displacement MUA supply) impaired the ability of the exhaust hood to capture and contain cooking effluent. This finding supports the premise that supplying large percentages of the replacement air requirement within the vicinity of an

exhaust hood can be a challenge for the designer and food service operator. Consequently, continuing to research methods of introducing MUA that minimize impacts on hood performance is important and worthwhile. The need for and merits of further investigations are discussed under the different categories of MUA supply tested within this study. Research into MUA temperature effects and other performance evaluation techniques (energy balance, CFD) are discussed in separate sections.

6.3.1 MUA Strategies

6.3.1.1 Air Curtain Supply

The air curtain design that was tested may have been a worst-case design. There are other designs, including patented ones, which may be successful approaches to introducing makeup air. It is recommended that future research compare a number of off-the-shelf units from various manufacturers to determine the effects of design geometries.

6.3.1.2 Front Face Supply

It is recommended that future research compare a number of off-the-shelf units from various manufacturers to determine the effects of internal baffling, open area of perforated surfaces, distance from hood lip, and other geometric factors such as supply collar location and position.

6.3.1.3 Ceiling Diffuser Supply

Testing various face diffusers such as slotted registers in addition to the perforated registers could clarify performance differences due to design. Also testing perforated perimeter supply combinations (at or near ceiling level in front of the hood) could be included within an expanded study of MUA supply through ceiling grilles and diffusers. Additional testing may reveal a more successful strategy for introducing local MUA from the ceiling. It would be useful to test the following configurations: (1) a number of four-way diffusers in operation at the same time, (2) perforated-plate ceiling diffusers instead of fixed vane ceiling diffusers, and (3) single or multiple three-way ceiling diffusers.

6.3.1.4 Short-Circuit Supply

Further study of short-circuit hoods is recommended, using several off-the-shelf designs. The application of the energy balance protocol to quantify spillage and diffusion of air escaping the hood footprint is discussed in a separate subsection to follow.

6.3.1.5 Backwall Supply

In this study, the backwall or rear MUA supply demonstrated the least intrusion on the performance of the exhaust hood and required the smallest increase in exhaust rate to ensure C&C. However, testing at different supply temperatures (see “Temperature Effects” below) is imperative before this method of supplying MUA can be endorsed within CKV design guidelines.

6.3.2 Temperature Effects

Testing under an unrelated project revealed that the MUA discharge temperature has a dramatic effect on the C&C rate. Most of the MUA effects in this project were documented with a neutral supply air temperature (i.e., typical room conditions of $75 \pm 5^\circ\text{F}$). Although this is representative of supplying conditioned MUA through ceiling diffusers or front-face diffusers, it may not reflect the range in design temperatures that would be experienced if untempered MUA was supplied to a short-circuit hood, back-wall supply or an air curtain. It would be worthwhile to investigate and then be able to recommend optimum MUA temperatures with respect to hood performance, in addition to quantifying heating and cooling loads that result from particular MUA strategies (using the energy balance protocol).

6.3.3 Energy Balance (Heat Gain) Protocol

The steady-state, peak-effluent rates produced by the plume simulator sets the stage for applying the energy balance protocol defined by ASTM Standard F 1704. Using cooking simulation strategies for both the griddles and underfired broilers, a time-weighted rate of effluent spill for a given CKV/appliance condition can be determined. Applying the energy balance protocol to a steady-state cooking effluent generation scenario, heat-gain curves for cooking conditions could be generated that would be similar to the idle heat gain curves reported by earlier research. At the point of spillage, the heat gain curve would begin to climb upwards, indicating spillage of effluent. This may be a very effective way to better illustrate the failure of short-circuit hood systems.

It is feasible that the energy balance protocol can be applied to determine the percentage of MUA (supplied locally, but outside the hood itself) that was directed back into the hood without diffusing throughout the space. Unconditioned MUA that escapes the hood and mixes with the general kitchen air may result in heat gain to the entire kitchen, depending on its temperature. In this case, the desired outcome would be to minimize the percentage of supplied MUA that diffused and mixed with room air before returning to the hood perimeter as replacement air. For example, the schlieren images generated for the backwall supply suggest that a portion of the MUA does not stay within the hood footprint and is pushed beyond the front of the appliances (contrary to manufacturers' claims that suggest otherwise). However, the schlieren visualization imaging also shows that, for MUA that is warm relative to the surrounding air, the buoyancy effect causes a portion of the MUA to rise in front of the equipment and then enter the hood boundary. This interpretation is subjective, as quantifying the mass flow using a schlieren visualization is very difficult.

6.3.4 Computational Fluid Dynamics (CFD)

CFD simulations are becoming more prevalent in the industry as a tool to design ventilation systems and educate customers on system design. Outside the scope of this project, results from the schlieren visualization systems were compared with a CFD program simulation for the wall-mounted canopy hood equipped with a perforated front-face supply system. Comparing the two evaluations, the schlieren visualization system clearly showed the MUA from the face supply blowing downward and slightly forward, which contributed to the hood's failure to capture and contain the effluent. The CFD model assumed that the air from the front-face supply was traveling perpendicular to the face and did not show any problems caused by the

perforated front-face supply. This comparison demonstrates that CFD modeling depends greatly on initial boundary conditions. While the CFD program correctly modeled the dimensions and airflow, the assumption of the air direction leaving the face supply created an inaccurate result. Future side-by-side comparison of the two evaluation tools may lead to more accurate CFD modeling.

6.3.5 Test Method Development

Future testing related to hood performance should include standardized cooking methods and thermal plume simulators. Standardized cooking methods allowed accurate and repeatable results. Variations in food being tested, cooking times, and methods of handling the food and appliances can greatly change the plume challenging the hood. ASTM established guidelines provide test results that are more usable for comparisons and more repeatable for uncertainty calculations.

Thermal plume simulators should be given consideration to save time and money during hood performance evaluation. Most variables present during the conventional cooking process are eliminated and the limited evaluation time during peak cooking effluent production is expanded from approximately 10 percent to 100 percent of the testing time. The actual food product is also eliminated, thereby reducing the cost of supplies needed for repetitive testing and the resulting waste.

7.0 References

ASHRAE HVAC Applications Handbook. 1999. American Society of Heating, Ventilating, and Air-conditioning Engineers. Atlanta, GA.

ASHRAE Standard 41.2-1987, *Standard Methods for Laboratory Airflow Measurement*. American Society of Heating, Ventilating, and Air-conditioning Engineers. Atlanta, GA.

ASTM 1275-95 *Standard Test Method for the Performance of Griddles*. ASTM International. West Conshohocken, PA

ASTM Standard 1704-99, 99 *Standard Test Method for the Performance of Commercial Kitchen Ventilation Systems*. ASTM International. West Conshohocken, PA

ASTM Standard 1695-96, *Standard Test Method for Performance of Underfired Broilers*. ASTM International. West Conshohocken, PA

UL Standard 710. UL 710, *Exhaust Hoods for Commercial Cooking Equipment*. Underwriters Laboratories

Swierczyna, R., D. Fisher, D. Horton. 2002. Effects of Commercial Kitchen Pressure on Exhaust System Performance. ASHRAE Transactions AEC-02-16-3. ASHRAE, Atlanta, GA.

8.0 Glossary

AGA	American Gas Association
AHU	Air Handling Unit
ASHRAE	American Society of Heating, Refrigeration and Air-conditioning Engineers, Inc.
ASTM	American Society for Testing and Materials
AMCA	Air Movement and Control Association
CFD	Computational Fluid Dynamic simulations
C&C	Capture and Containment The condition where none of the thermal plume and/or cooking effluent spills from the hood..
CKV	Commercial Kitchen Ventilation
EPRI	Electric Power Research Institute
HVAC	Heating Ventilation And Cooling
GRI	Gas Research Institute
GTI	Gas Technology Institute
LFE	Laminar Flow Element
MUA	Makeup Air. Outside air that replaces exhausted air. In the context of this report, replacement air may be introduced through the general building HVAC system, through dedicated mechanical units serving the kitchen, or through infiltration.
NIST	National Institute of Standards and Technology
PG&E	Pacific Gas and Electric Company

Attachment 1: Design Guide - Improving Commercial Kitchen Ventilation System Performance

Design Guide

Improving Commercial Kitchen Ventilation System Performance

This design guide provides information that will help achieve optimum performance and energy efficiency in commercial kitchen ventilation systems. The information presented is applicable to new construction and, in many instances, retrofit construction. The audience for this guideline is kitchen designers, mechanical engineers, food service operators, property managers, and maintenance people. This guide is intended to augment comprehensive design information published in the Kitchen Ventilation Chapter in the ASHRAE Handbook on HVAC Applications.

Introduction

An effective commercial kitchen ventilation (CKV) system requires balance—air balance that is. And as the designer, installer or operator of the kitchen ventilation system, you may be the first person called upon to perform your own “balancing act” when the exhaust hood doesn’t work. Unlike a cooking appliance, which can be isolated for troubleshooting, the exhaust hood is only one component of the kitchen ventilation system. To further complicate things, the CKV system is a subsystem of the overall building heating, ventilating and air-conditioning (HVAC) system. Fortunately, there is no “magic” to the relationship between an exhaust hood and its requirement for replacement or makeup air (MUA). The physics are simple: air that exits the building (through exhaust hoods and fans) must be replaced with outside air that enters the building (intentionally or otherwise). The essence of *air balance*: “air in” = “air out!”

Background

If the replacement air doesn’t come in, that means it doesn’t go out the exhaust hood and problems begin. Not only will the building pressure become too “negative,” the hood may not capture and contain (C&C) cooking effluents due to reduced exhaust flow. We have all experienced the “can’t-open-the-door” syndrome because the exhaust fan is sucking too hard on the inside of the restaurant. The mechanical design may call for 8000 cubic feet per minute (cfm) of air to be exhausted through the hood. But if only 6000 cfm of outdoor air is able to squeeze in through closed dampers on rooftop units and undesirable pathways in the building envelope, then only 6000 cfm is available to be exhausted through the hood. The exhaust fan creates more suction (negative pressure) in an unsuccessful attempt to pull more air through the hood.

There is no piece of equipment that generates more controversy within the food service equipment supply and design community than the exhaust hood in all its styles and makeup air combinations. The idea that by not installing a dedicated

Introduction	1
Background	1
Kitchen Ventilation Fundamentals	2
Influence of Makeup Air	5
MUA Recommendations	6
Influence of Other Factors	9
Energy Saving Considerations	6
Design Guide Summary	12
Case Study	13

makeup air supply, the operator is going to save money (in both first cost and operating cost) is short sighted. It may be okay if, by design, all of the makeup air can be provided through the rooftop HVAC units (this strategy has been adopted successfully by several leading quick-service restaurant chains). However, in full-service and institutional kitchens with larger exhaust requirements, it may not be practical (or energy efficient) to supply 100% of the replacement (makeup) air through the building HVAC system.

The solution is to specify an independent makeup air supply. But, once dedicated MUA has been added to the system, the challenge becomes introducing this air into the kitchen without disrupting the ability of the hood to capture and/or without causing discomfort for the kitchen staff. Kitchens are not large and dumping 7000 cfm of MUA, for example, in front of a cook line does not go as smoothly in practice as it does on the *air balance schedule!* Not only can makeup air velocities impact the ability of the hood to capture and contain cooking effluent, locally supplied makeup air that is too cold or too hot can create an uncomfortable working environment. This design guide presents strategies that can minimize the impact that the makeup air introduction will have on hood performance and energy consumption.

Fundamentals of Kitchen Ventilation

Hot air rises! An exhaust fan in the ceiling could easily remove the heat produced by cooking equipment. But mix in smoke, volatile organic compounds, grease particles and vapor from cooking, a means to capture and contain the effluent is needed to avoid health and fire hazards. While an exhaust hood serves that purpose, the key question is always: what is the appropriate exhaust rate? The answer always depends on the type (and use) of the cooking equipment under the hood, the style and geometry of the hood itself, and how the makeup air (conditioned or otherwise) is introduced into the kitchen.

Cooking appliances are categorized as light-, medium-, heavy-, and extra heavy-duty, depending on the strength of the thermal plume and the quantity of grease and smoke produced. The strength of the thermal plume is a major factor in determining the exhaust rate. By their nature, these thermal plumes are very turbulent and different cooking processes have different “surge” characteristics. For example, the plume from hamburger cooking is strongest when flipping the burgers. Ovens and pressure fryers may have very little plume until they are opened to remove food product. Open flame, non-thermostatically controlled appliances, such

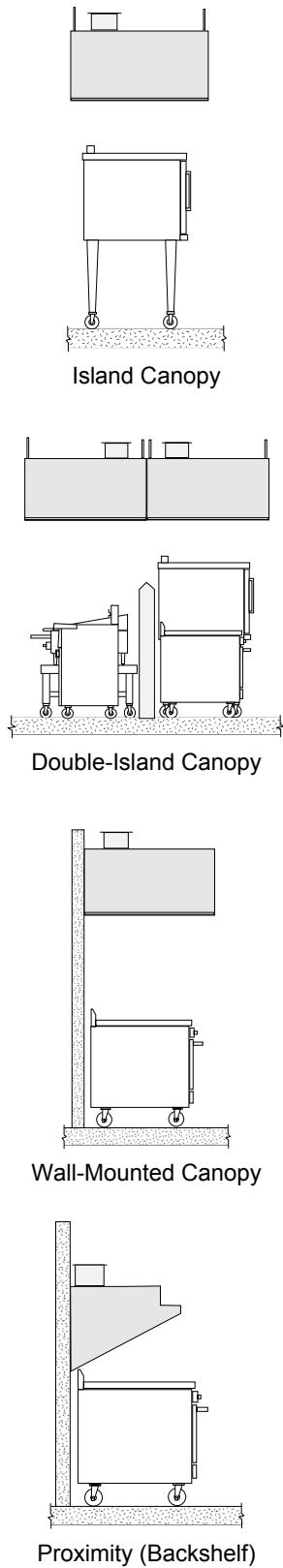

Figure 1. CKV Hood Types.

as underfired broilers and open top ranges, exhibit strong steady plumes. Thermostatically controlled appliances, such as griddles and fryers have weaker plumes that fluctuate in sequence with thermostat cycling (particularly gas-fired equipment). As the plume rises by natural convection, it is captured by the hood and removed by the suction of the exhaust fan. Air in the proximity of the appliances and hood moves in to replace it. This replacement air, which originates as outside air, is referred to as makeup air.

The design exhaust rate also depends on the hood style and design features. Wall-mounted canopy hoods, island (single or double) canopy hoods, and proximity (backshelf, pass-over, or eyebrow) hoods all have different capture areas and are mounted at different heights relative to the cooking equipment (see Figure 1). Generally, a single-island canopy hood requires more exhaust than a wall-mounted hood, and a wall-mounted hood requires more exhaust than a proximity hood. The performance of a double-island canopy tends to emulate the performance of two back-to-back wall-canopy hoods, although the lack of a physical barrier between the two hood sections makes the configuration more susceptible to cross drafts.

Lastly, the layout of the HVAC and MUA distribution points can affect hood performance. These can be sources that disrupt thermal plumes and hinder capture and containment. Location of delivery doors, service doors, pass-through openings and drive-through windows can also be sources of cross drafts. Safety factors are typically applied to the design exhaust rate to compensate for the effect that undesired air movement within the kitchen has on hood performance.

CKV System Performance Testing

The phrase "hood capture and containment" is defined in ASTM F-1704 *Standard Test Method for the Performance of Commercial Kitchen Ventilation Systems* as "the ability of the hood to capture and contain grease-laden cooking vapors, convective heat and other products of cooking processes." Hood capture refers to these products entering the hood reservoir from the area under the hood, while containment refers to these products staying in the hood reservoir and not spilling out into the adjacent space. The phrase "minimum capture and containment" is defined as "the conditions of hood operation in which minimum exhaust flow rates are just sufficient to capture and contain the products generated by the appliance in idle or heavy-load cooking conditions, and at any intermediate prescribed load condition." The abbreviation "C&C" refers to the "minimum capture and containment" flow rate as defined in ASTM F-1704.

Performance testing in accordance with ASTM F-1704 at the CKV Laboratory in Wood Dale, IL, incorporates a schlieren flow-visualization system to verify capture and containment. This system is a major breakthrough for visualizing thermal and effluent plumes from cooking processes. “Schlieren” is derived from the German word for “smear.” A schlieren system presents an amplified optical image (see Figure 2) due to the different air densities, similar to the mirage effect we see over hot pavement.

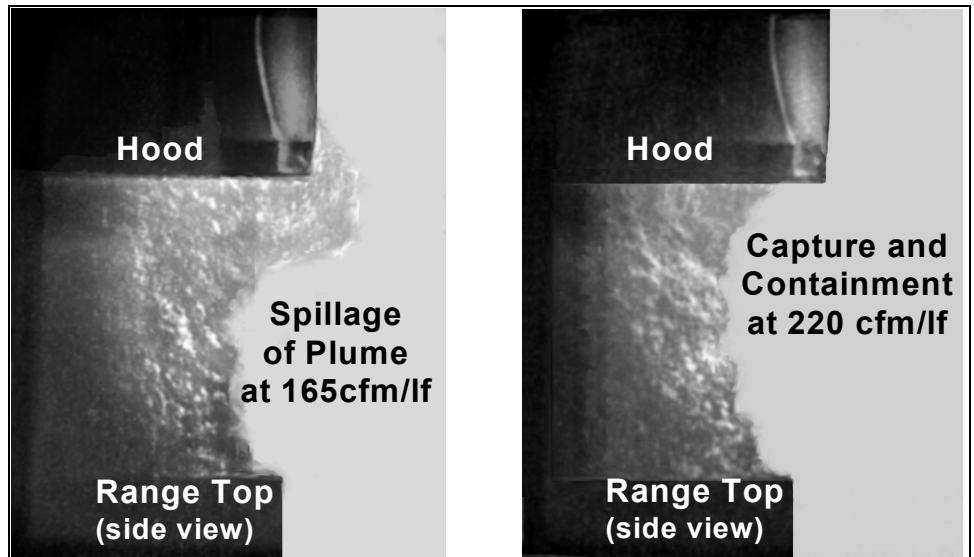

Figure 2. Schlieren images at different exhaust rates per linear foot (lf).

Replacement (Makeup) Air Distribution

Air that is removed from the kitchen through an exhaust hood must be replaced with an equal volume of makeup air through one or more of the following pathways:

- Transfer air (e.g., from the dining room)
- Displacement diffusers (floor or wall mounted)
- Ceiling diffusers with louvers (2-way, 3-way, 4-way)
- Slot diffusers (ceiling)
- Ceiling diffusers with perforated face
- Integrated hood plenum (see Figure 3) including:
 1. Short circuit (internal supply)
 2. Air curtain supply
 3. Front face supply
 4. Perforated perimeter supply
 5. Backwall supply (rear discharge)
 6. Combinations of the above

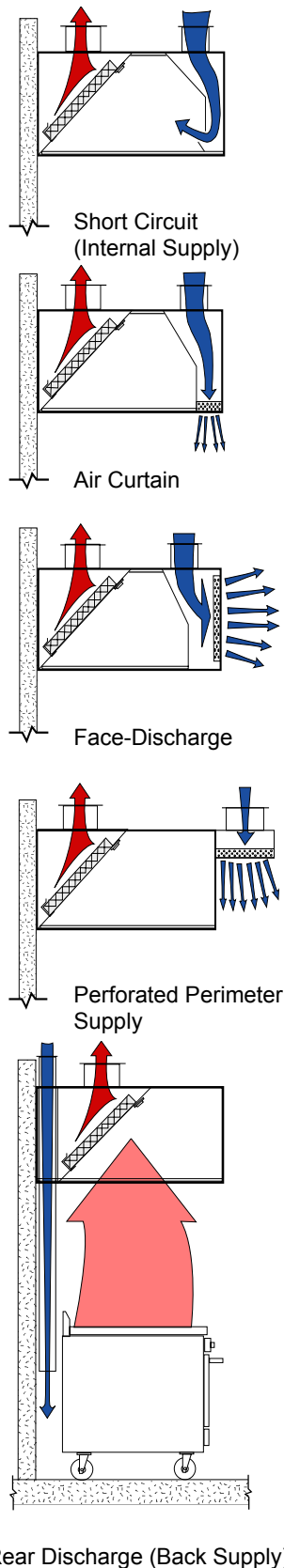

Figure 3. Types of MUA Supply Integrated with the hood.

Influence of Makeup Air on Exhaust Hood Performance

Makeup air that is supplied through displacement ventilation diffusers remote from the hood, perforated diffusers located in the ceiling as far as possible from the hood, or as transfer air from the dining room generally works well if air velocities approaching the hood are less than 75 feet per minute (fpm). Makeup air introduced in close proximity to an exhaust hood has the potential, however, to interfere with the hood’s ability to capture and contain. The chances of makeup air affecting hood performance increases as the percentage of the locally supplied MUA (relative to the total exhaust) is increased. In fact, the 80% rule-of-thumb for sizing airflow through a MUA unit can be a recipe for trouble, particularly if the exhaust flow rate has been over-specified to start with.

Temperature of the locally supplied makeup air can also impact hood performance as air density (buoyancy) impacts the dynamics of air movement around the hood. Generally, hotter MUA temperatures (e.g., 90°F) will affect hood performance more adversely than cooler air (e.g., 75°F). In most temperate climates, such as many areas in California, evaporative cooling is an effective method of maintaining MUA temperatures within a range that is comfortable for kitchen staff and does not hamper hood performance. However, the maintenance requirements of evaporative coolers must be factored into the equation.

The primary recommendation for minimizing the impact that locally supplied MUA will have on hood performance is to minimize the velocity (fpm) of the makeup air as it is introduced near the hood. This can be accomplished by minimizing the volume (cfm) of makeup air through any one pathway, by maximizing the area of the grilles or diffusers through which the MUA is supplied, or by using a combination of pathways.

The first step in reducing the MUA requirement is to minimize the design exhaust rate. This can be accomplished by prudent selection and application of UL Listed hoods and taking advantage of the “exhaust flow” recommendations from hood suppliers for the cookline under consideration. Exhaust hood manufacturers’ sales and engineering departments have a lot of experience that CKV design consultants can tap to help minimize the “safety factor” applied to exhaust rates.

The second step in reducing MUA flow is to take credit for outside air that must be supplied by the HVAC system to meet code requirements for ventilating the dining room. Depending on the architectural layout between the kitchen and the dining room, it may be practical to transfer most of this air from the dining room to

the kitchen. For example, if 2400 cfm of outdoor air that is being supplied to a 160-seat dining room can be transferred to the kitchen, the local makeup air requirement can be reduced accordingly.

Rather than supplying 80 to 90% of the exhaust rate through one makeup air strategy, designers should make an effort to keep this ratio below 60% (obviously, the other 40% of the replacement air must be derived from another source such as transfer air, another local strategy, or HVAC supply). Although this may contradict past practice, it will be effective! Not only will hood performance be superior, the kitchen environment will benefit from the cooling contribution of the “recycled” dining room air. It is important to realize that the outdoor air required by code is usually conditioned before it is introduced into the dining room. So... why not use this outdoor air as a makeup air credit?

The third step in reducing MUA flow is to select a configuration for introducing this local makeup air into the kitchen that compliments the style and size of hood. If transfer air is not an option, consider a combination of makeup air strategies (e.g., backwall supply and perforated ceiling diffusers). This reduces the velocity of air being supplied through each local pathway, mitigating potential problems with hood capture. Effective options (at 60% or less) include front face supply, backwall supply, and perforated perimeter supply. Short-circuit supply is not recommended, and air-curtains should be used with extreme caution. The pros and cons of the different configurations are discussed below. Note a frequent theme—minimizing MUA discharge velocity is key to avoiding detrimental impacts on hood capture and containment.

Short-Circuit Supply (Internal Makeup Air)

The application of short-circuit makeup air hoods is a controversial topic. These internal makeup air hoods were developed as a strategy to reduce the amount of conditioned air required by an exhaust system. By introducing a portion of the required makeup air in an untempered condition directly into the exhaust hood reservoir, the net amount of conditioned air exhausted from the kitchen is reduced. Research has shown however, that in the cases tested, internal MUA cannot be introduced at a rate that is more than 15% of the threshold C&C exhaust rate without causing spillage (despite what is shown on the air balance schedule or marketing literature). When short circuit hoods are operated at higher percentages of internal MUA they fail to capture and contain the cooking effluent, often spilling at the back of the hood (although front spillage is observed in Figure 5). Dilution of the cook-

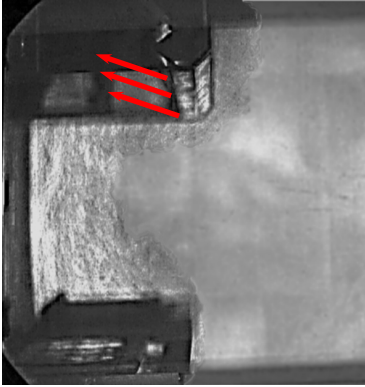

Figure 5. Schlieren image shows the thermal plume being displaced by short circuit supply causing hood to spill.

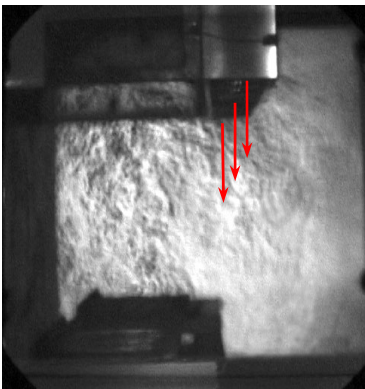

Figure 6. Schlieren image shows the thermal plume being pulled outside the hood by the air curtain.

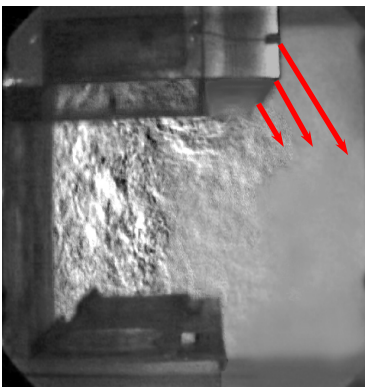

Figure 7. Schlieren image shows the thermal plume being pulled outside the hood by a poorly engineered front face supply.

ing effluent with the internal MUA makes it hard to visualize spillage (even using a schlieren system), but a degraded kitchen environment is confirmation that hood performance has been compromised. If the design exhaust rate is significantly higher than the threshold for C&C (i.e., includes a large safety factor), the percentage of short-circuit air can be increased accordingly, creating a condition of apparent benefit.

Short-circuit hoods are simply not recommended. This recommendation is endorsed by leading hood manufacturers, even though they may still include short-circuit hoods in their catalogue.

Air Curtain Supply

Introducing MUA through an air curtain is a risky design option and most hood manufacturers recommend limiting the percentage of MUA supplied through an air-curtain to less than 20% of the hood's exhaust flow. The negative impact of an air curtain is clearly illustrated in Figure 6 by the schlieren flow visualization recorded during a test of a wall-mounted canopy hood operating over two underfired broilers.

An air curtain (by itself, or in combination with another pathway) is not recommended, unless velocities are kept to a minimum and the designer has access to performance data on the actual air-curtain configuration being specified. It is too easy for the as-installed system to oversupply, creating higher discharge velocities that cause cooking effluent to spill into the kitchen.

Front Face Supply

Supplying air through the front face of the hood is a configuration that has been recommended by many hood manufacturers. However, a front face discharge, with louvers or perforated face, can perform poorly if its design does not consider discharge air velocity and direction. Not all face discharge systems share the same design; internal baffling and/or a double layer of perforated plates improve the uniformity of flow. Face discharge velocities should not exceed 150 fpm and should exit the front face in a horizontal direction. Greater distance between the lower capture edge of the hood and the bottom of the face discharge area may decrease the tendency of the MUA supply to interfere with hood capture and containment. Figure 7 represents a poorly designed face supply, which can negatively affect hood capture in the same fashion as an air-curtain or four-way diffuser.

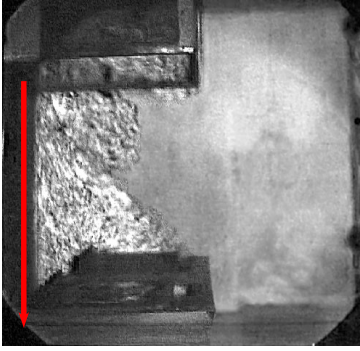

Figure 8. Schlieren image shows the thermal plume being pulled captured with backwall supply.

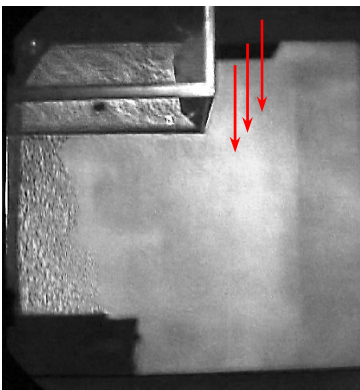

Figure 9. Schlieren image shows effective plume capture with MUA supplied through a 16-in wide perforated perimeter supply.

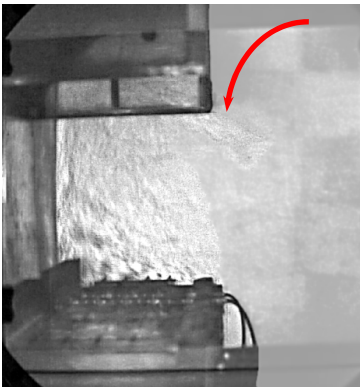

Figure 10. Schlieren image shows the thermal plume being pulled outside the hood by the air discharged from a 4-way diffuser.

Backwall Supply (Rear Discharge)

Lab testing has shown that the backwall supply can be an effective strategy for introducing MUA (see Figure 8). However, the discharge area of the backwall supply should be at least 12 inches below the cooking surfaces of the appliances to prevent the relative high velocity introduction of MUA from interfering with gas burners and pilot lights. As with other local MUA strategies, the quantity of air introduced through the backwall supply should be no more than 60% of the hood's exhaust flow. Hoods with a deeper plenum or increased diffuser area have lower discharge velocities, allowing higher supply airflows. The back supply plenum may offer the advantage of meeting a “clearance to combustibles” code requirement. It may also be an option to convert a single island canopy into a more functional wall-mounted canopy (without actually constructing the wall) as utility distribution can be incorporated within the plenum. If the rear supply utilizes perforated diffusers, it is important that cleanout access be provided (as with any supply diffuser).

Perforated Perimeter Supply

Perforated supply plenums (with perforated face diffuser) are similar to a front face supply, but the air is directed downward as in Figure 9 toward the hood capture area. This may be advantageous under some conditions, since the air is directed downward into the hood capture zone. Face discharge velocities should not exceed 150 fpm from any section of the diffuser and the distance to lower edge of the hood should be no less than 18 inches (or the system begins to act like an air curtain). Widening the plenum will lower the discharge velocity for a given flow of MUA and reduce the chance of the supply air affecting C&C. If the perforated supply plenum is extended along the sides of the hood as well as the front, the increased area will permit proportionally more MUA to be supplied.

Four-Way Ceiling Diffusers

Four-way diffusers located close to kitchen exhaust hoods (see Figure 10) can have a detrimental affect on hood performance, particularly when the flow through the diffuser approaches its design limit. Air from a diffuser within the vicinity of the hood should not be directed toward the hood. Discharge velocity at the diffuser face should be set at a design value such that the terminal velocity does not exceed 50 fpm at the edge of the hood capture area. It is recommended that only perforated plate ceiling diffusers be used in the vicinity of the hood, and to reduce air velocities from the diffusers at a given supply rate, the more diffusers the better!

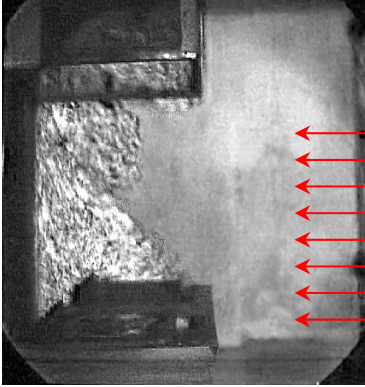

Figure 11. Schlieren image shows the plume being effectively captured when makeup air is supplied at low velocity from displacement diffusers.

Displacement Diffusers

Supplying makeup air through displacement diffusers at a good distance away from the hood as illustrated in Figure 11 is an effective strategy for introducing replacement air. It is analogous to low-velocity “transfer air” from the dining room. However, the diffusers require floor or wall space that is usually a premium in the commercial kitchen. A couple of remote displacement diffusers (built into a corner) could help diversify the introduction of makeup air into the kitchen when transfer air is not viable.

Influence of Other Factors on Hood Performance

Cross Drafts

Cross drafts have a detrimental affect on all hood/appliance combinations. Cross-drafts adversely affect island canopy hoods more than wall mounted canopy hoods. A fan in a kitchen, especially pointing at the cooking area, severely degrades hood performance and may make capture impossible. Cross drafts can also be developed when the makeup air system is not working correctly, causing air to be pulled from open drive-through or pass-through windows or doors.

Side Panels and Overhang

Side (or end) panels (as represented in Figure 12) permit a reduced exhaust rate in most cases, as they direct the replacement airflow to the front of the equipment. They are a relatively inexpensive way to improve capture and containment and reduce the total exhaust rate. In fact, one of the greatest benefits of end panels is to mitigate the negative effect of cross drafts. It is important to know that partial side panels can provide almost the same benefit as full panels. Although tending to defy its definition as an “island” canopy, end panels can improve the performance of a double-island or single-island canopy hood.

An increase in overhang should improve the ability of the hood to capture, although for unlisted hoods this may mean an increase in the code-required exhaust rate. Larger overhangs are recommended for appliances that create plume surges, such as convection and combination ovens, steamers and pressure fryers.

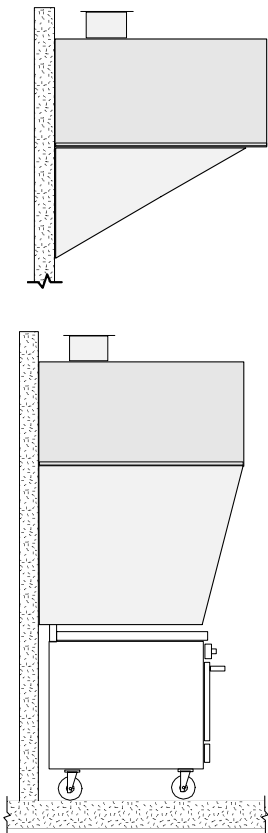

Figure 12. Illustration of partial and full side panels.

Safety Factor in Exhaust Rates

Diversity in appliance use, hood reservoir size, as well as the fact that maximum effluent generation from cooking only occurs randomly during normal kitchen operations, may mask the detrimental influence of local MUA sources on

hood performance. Consequently, spillage may be infrequent or simply unobserved. However, better MUA designs allow reduced exhaust rates and minimized energy costs while maintaining a margin of safety with respect to C&C.

Design Considerations for Energy Savings

Hood Style

Wall-mounted canopy hoods function effectively with a lower exhaust flow rate than the single-island hoods. Island canopy hoods are more sensitive to MUA supply and cross drafts than wall mounted canopy hoods. Engineered proximity hoods may exhibit the lowest capture and containment flow rates. In some cases, a proximity hood performs the same job as a wall-mounted canopy hood at one-third the exhaust rate.

Hood Geometry

Interior angles close to, or at, the capture edge of the hood improve C&C performance, allowing reduced exhaust by directing effluent back towards the filters. Hoods designed with these better geometric features require as much as 20% less exhaust rate compared to hoods identical in size and shape without these features. Capture and containment performance may also be enhanced with active “low-flow, high-velocity air jets” along the perimeter of the hood.

Variable Speed Fans and Idle Conditions

Appliances idle much of the day. Using two-speed or variable exhaust flow rates to allow reductions in exhaust (and makeup) while appliances are idling would minimize operating costs. NFPA 96 (Standard for Ventilation Control and Fire Protection of Commercial Cooking Operations) was recently amended to allow minimum exhaust duct velocity as low as 500 fpm (at the exhaust collar and ductwork). Typical design values of 1500 to 1800 fpm at the exhaust collar are still recommended for normal cooking conditions. This code change will facilitate the application of variable speed systems.

Energy Perspective

The exhaust ventilation system can be a major energy user in a commercial kitchen – but it doesn’t need to be in temperate climates like California. Mild climates, such as San Diego, may require no heating or cooling. Some facilities may cool replacement air to improve kitchen comfort. Combined heating and cooling

costs for MUA range from \$0.00 to \$0.60 per cfm in California climates, assuming 16 hours per day for 360 days per year. California climates are mild compared to other areas in North America so heating and mechanical cooling of MUA often is not necessary. Evaporative cooling can be very effective in desert climates.

Rule-of-thumb figures are useful, but how can designers calculate the costs based on a specific kitchen design and operation? The Outdoor Airload Calculator (OAC) software, freely available for download (www.archenergy.com/ckv/oac), is the best tool for quickly estimating the energy use for different CKV design and operating strategies. Figure 13 illustrates the OAC program interface and output.

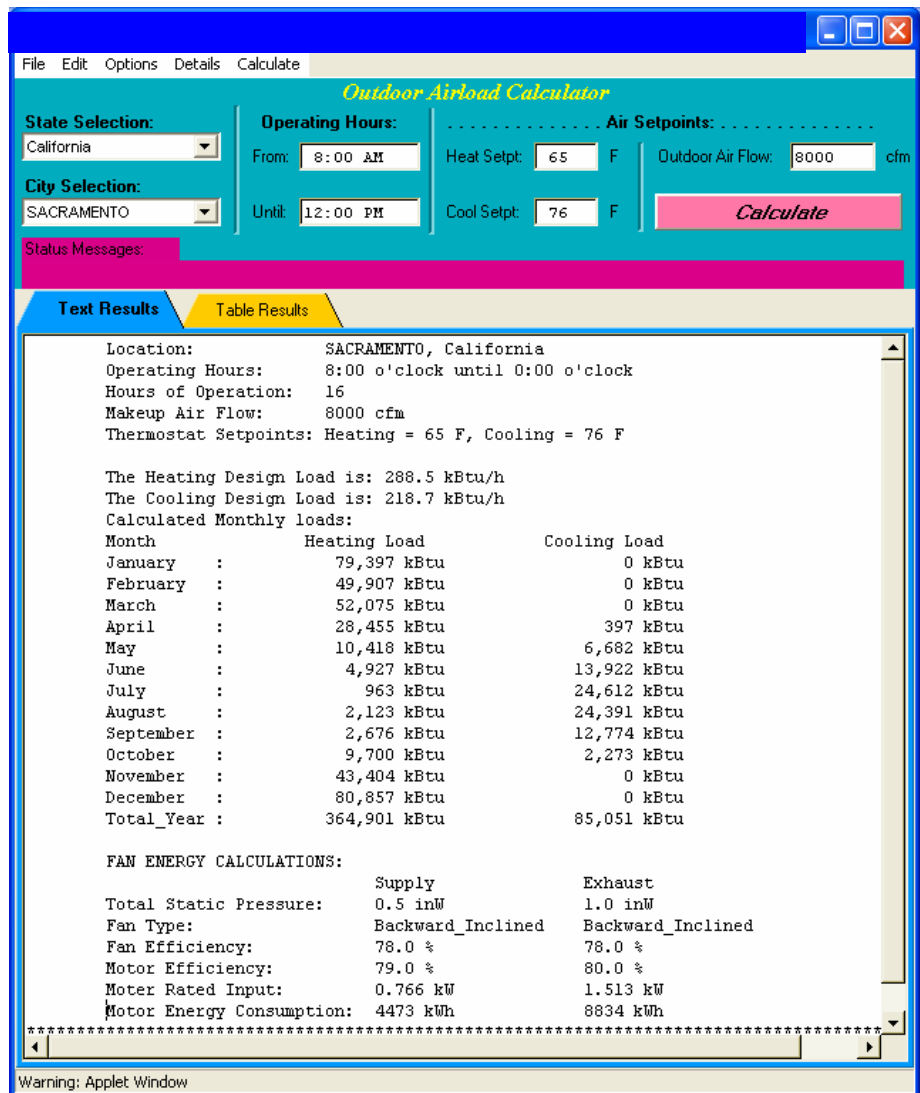

Figure 13. Sample output from Outdoor Airload Calculator screen.

Design Guide Summary

The strategy used to introduce replacement (makeup) air can significantly impact hood performance and should be a key factor in the design of kitchen ventilation systems. Makeup air introduced close to the hood's capture zone may create local air velocities and turbulence that result in periodic or sustained failures in thermal plume capture and containment. Furthermore, the more makeup air supplied (expressed as a percentage of the total replacement air requirement), the more dramatic the negative effect.

The following design suggestions can improve the energy efficiency and performance of commercial kitchen ventilation systems:

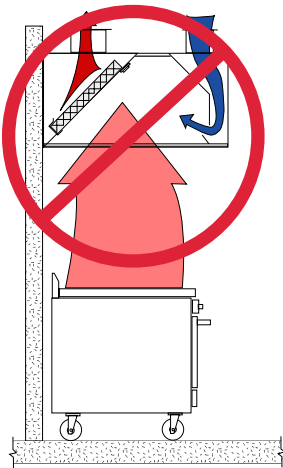

Figure 14. Don't use short circuit hoods.

- Group appliances according to effluent production and associated ventilation requirements. Specify different ventilation rates for hoods or hood sections over the different duty classification of appliances. Where practical, place heavy-duty appliances such as charbroilers in the center of a hood section, rather than at the end.
- Use UL Listed proximity type hoods where applicable.
- Hood construction details (such as interior angles and flanges along the edge) or high-velocity jets can promote capture and containment at lower exhaust rates.
- Install side and/or back panels on canopy hoods to increase effectiveness and reduce heat gain.
- Integrate the kitchen ventilation with the building HVAC system (i.e., use dining room outdoor air as makeup air for the hood).
- Maximize transfer air/minimize direct makeup air.
- Do not use short-circuit hoods (Figure 14). Use caution with air-curtain designs.
- Avoid 4-way or slot ceiling diffusers in the kitchen, especially near hoods.
- Diversify makeup air pathways (use combination of backwall supply, perforated perimeter supply, face supply, displacement diffusers, etc.).
- Minimize MUA velocity near the hood; it should be less than 75 fpm.
- Use direct-fired MUA heating if heating is necessary. In most temperate climates, including much of California, design for no MUA heating.
- Consider evaporative MUA cooling in dry climates such as California.
- Consider variable or 2-speed exhaust fan control for operations with high diversity of appliances and/or schedule of use.
- Provide air balance requirements to avoid over- or under-supply of MUA.
- Require building air balancing and system commissioning as part of the construction requirements.

Case Study: Wall-Mounted Canopy Hood

Challenge: Improve hood C&C and reduce ventilation energy

Off-the-Shelf Approach

An un-listed¹ wall mounted canopy hood (20-ft by 4-ft) without side panels: total exhaust 8,000 cfm. Four-way ceiling diffusers supplying air from the kitchen HVAC and MUA unit are located about 2 feet from front and sides of the hood.

Makeup Air Sources:

- 1000 cfm from dining and kitchen HVAC unit (25 Ton refrigeration capacity),
- 7000 cfm from independent MUA (heating only, ductstat set to 65°F) supplied through 4-way ceiling diffusers.

Annual CKV energy cost (including MUA conditioning and exhaust and MUA fan energy) estimated at \$6000 (\$0.75 per cfm) for Sacramento, CA location (using \$0.15/kWh and \$0.60 per therm).

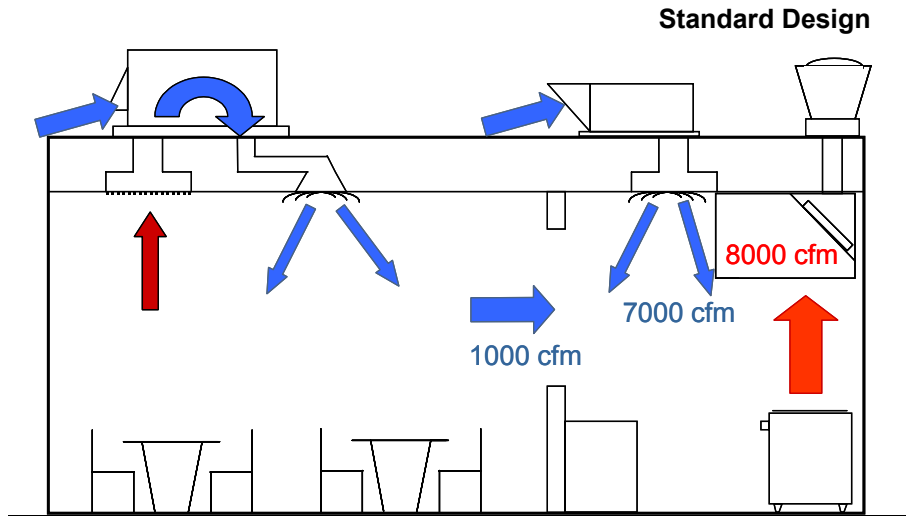

Engineered Approach

A "listed" hood (20-ft by 4.5-ft each) with partial side panels for a total exhaust of 6,000 cfm. Maximized use of transfer air. Perforated ceiling diffusers away from the hoods for the MUA supply.

Makeup Air Sources:

- 1500 cfm from kitchen HVAC unit (15 Ton, 7000 cfm total supply)
- 1500 cfm from dining HVAC unit (10 Ton, 5000 cfm total supply)
- 3000 cfm from independent MUA (no heating with evaporative cooling)

Annual CKV energy cost estimated at \$2000 (\$0.25 per cfm) for Sacramento, CA location, for a \$4000 saving over standard design.

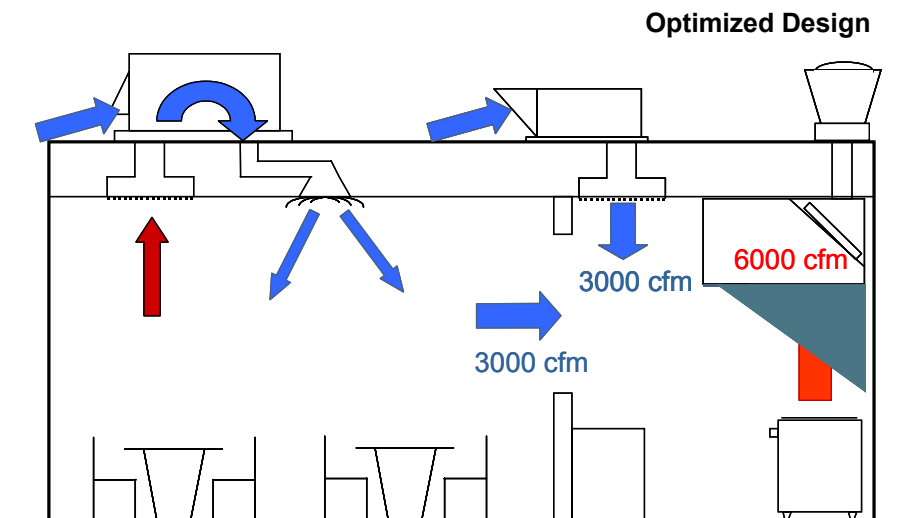

¹ Hoods designed to meet exhaust levels required by building codes, but not listed by a certified laboratory in accordance with a recognized test standard. For identical cooking equipment unlisted hoods typically require higher exhaust flows than listed hoods.

Notes and Acknowledgments

Funding

California Energy Commission
1516 Ninth Street, MS-29
Sacramento, CA 95814-5512
(916) 654-4287
www.energy.ca.gov/pier/buildings

Pacific Gas and Electric Company
P.O. Box 770000 MCN6G
San Francisco, CA 94177
(415) 973-0106
www.pge.com

Research Team

Architectural Energy Corporation
2540 Frontier Ave, Suite 201
Boulder, CO 80301
(800) 450-4454
www.archenergy.com

Fisher Nickel, inc.
12949 Alcosta Boulevard, Suite 101
San Ramon, CA 94583
(925) 838-7561
www.fishnick.com

Research Labs

Commercial Kitchen Ventilation Laboratory
955 North Lively Blvd.
Wood Dale, IL 60191
(630) 860-1439
www.archenergy.com/ckv

Food Service Technology Center
12949 Alcosta Boulevard, Suite 101
San Ramon, CA 94583
(925) 866-2864
www.pge.com/fstc



Legal Notice

This design guide was prepared as a result of work sponsored by the California Energy Commission. It does not necessarily represent the views of the Commission, its employees, or the State of California. The Commission, the State of California, its employees, contractors, and subcontractors make no warranty, express or implied, and assume no legal liability for the information in this report; nor does any party represent that the use of this information will not infringe upon privately owned rights. This guide has not been approved or disapproved by the Commission nor has the Commission passed upon the accuracy or adequacy of this information in this guide.

Architectural Energy Corporation, Boulder, CO, and Fisher-Nickel, inc., San Ramon, CA, prepared this design guide. The first edition of this design guide was included as an attachment in the Energy Commission report titled *Makeup Air Effects on the Performance of Kitchen Exhaust Systems* (publication P500-03-007F, December 2002). Updated editions of this design guide may be downloaded from www.fishnick.com or www.archenergy.com.

© 2002 by the California Energy Commission. Permission is granted to reproduce this document in its entirety provided that this copyright notice is included.

Appendix I: Summary of Data

Serial #	Condition	Exhaust
47	Island Mounted Canopy Hood Without Side Panels with Two Charbroilers Cooking With Cross Draft	6500
43	Island Mounted Canopy Hood Without Side Panels with Two Charbroilers Cooking Without Cross Draft	5100
28	Island Mounted Canopy Hood Without Side Panels with Two Charbroilers Idling With Cross Draft	6500
27	Island Mounted Canopy Hood Without Side Panels with Two Charbroilers Idling Without Cross Draft	4900
17	Island Mounted Canopy Hood Without Side Panels with Two Griddles Cooking With Cross Draft	6500
12	Island Mounted Canopy Hood Without Side Panels with Two Griddles Cooking Without Cross Draft	2400
10	Island Mounted Canopy Hood Without Side Panels with Two Griddles Idling With Cross Draft	6500
9	Island Mounted Canopy Hood Without Side Panels with Two Griddles Idling Without Cross Draft	1925
45	Wall Mounted Canopy Hood With Side Panels with Two Charbroilers Cooking With Cross Draft	4750
44	Wall Mounted Canopy Hood With Side Panels with Two Charbroilers Cooking Without Cross Draft	3700
26	Wall Mounted Canopy Hood With Side Panels with Two Charbroilers Idling With Cross Draft	4200
25	Wall Mounted Canopy Hood With Side Panels with Two Charbroilers Idling Without Cross Draft	3400
15	Wall Mounted Canopy Hood With Side Panels with Two Griddles Cooking With Cross Draft	4150
14	Wall Mounted Canopy Hood With Side Panels with Two Griddles Cooking Without Cross Draft	1725
8	Wall Mounted Canopy Hood With Side Panels with Two Griddles Idling With Cross Draft	3500
7	Wall Mounted Canopy Hood With Side Panels with Two Griddles Idling Without Cross Draft	1285
46	Wall Mounted Canopy Hood Without Side Panels with Two Charbroilers Cooking With Cross Draft	5400
42	Wall Mounted Canopy Hood Without Side Panels with Two Charbroilers Cooking Without Cross Draft	4100
24	Wall Mounted Canopy Hood Without Side Panels with Two Charbroilers Idling With Cross Draft	5200
23	Wall Mounted Canopy Hood Without Side Panels with Two Charbroilers Idling Without Cross Draft	3600
16	Wall Mounted Canopy Hood Without Side Panels with Two Griddles Cooking With Cross Draft	4700

Table 1: Displacement (baseline) Raw Data

Serial #	Condition	Exhaust
11	Wall Mounted Canopy Hood Without Side Panels with Two Griddles Cooking Without Cross Draft	1950
6	Wall Mounted Canopy Hood Without Side Panels with Two Griddles Idling With Cross Draft	4000
5	Wall Mounted Canopy Hood Without Side Panels with Two Griddles Idling Without Cross Draft	1470
336	Wall Mounted Proximity Hood With Side Panels with Two Charbroilers Cooking With Cross Draft	2500
335	Wall Mounted Proximity Hood With Side Panels with Two Charbroilers Cooking Without Cross Draft	1250
317	Wall Mounted Proximity Hood With Side Panels with Two Charbroilers Idling With Cross Draft	2300
316	Wall Mounted Proximity Hood With Side Panels with Two Charbroilers Idling Without Cross Draft	1150
299	Wall Mounted Proximity Hood With Side Panels with Two Griddles Cooking With Cross Draft	2625
298	Wall Mounted Proximity Hood With Side Panels with Two Griddles Cooking Without Cross Draft	850
284	Wall Mounted Proximity Hood With Side Panels with Two Griddles Idling With Cross Draft	2400
283	Wall Mounted Proximity Hood With Side Panels with Two Griddles Idling Without Cross Draft	725
337	Wall Mounted Proximity Hood Without Side Panels with Two Charbroilers Cooking With Cross Draft	2650
319	Wall Mounted Proximity Hood Without Side Panels with Two Charbroilers Cooking Without Cross Draft	1250
318	Wall Mounted Proximity Hood Without Side Panels with Two Charbroilers Idling With Cross Draft	2500
315	Wall Mounted Proximity Hood Without Side Panels with Two Charbroilers Idling Without Cross Draft	1175
300	Wall Mounted Proximity Hood Without Side Panels with Two Griddles Cooking With Cross Draft	2800
292	Wall Mounted Proximity Hood Without Side Panels with Two Griddles Cooking Without Cross Draft	800
285	Wall Mounted Proximity Hood Without Side Panels with Two Griddles Idling With Cross Draft	3200
282	Wall Mounted Proximity Hood Without Side Panels with Two Griddles Idling Without Cross Draft	725

Table 2 Air Curtain Data			
Serial #	Situation	Exhaust	MUA
96	Island Mounted Canopy Hood Without Side Panels With Two Charbroilers Cooking With Cross Draft	Fail @ 6500	0
89	Island Mounted Canopy Hood Without Side Panels With Two Charbroilers Cooking Without Cross Draft	4900	0
95	Island Mounted Canopy Hood Without Side Panels With Two Charbroilers Cooking Without Cross Draft	5100	400
90	Island Mounted Canopy Hood Without Side Panels With Two Charbroilers Idling With Cross Draft	Fail @ 6500	0
127	Island Mounted Canopy Hood Without Side Panels With Two Griddles Cooking With Cross Draft	Fail @ 6500	1000
133	Island Mounted Canopy Hood Without Side Panels With Two Griddles Cooking With Cross Draft	Fail @ 6500	1000
126	Island Mounted Canopy Hood Without Side Panels With Two Griddles Cooking Without Cross Draft	3450	1000
132	Island Mounted Canopy Hood Without Side Panels With Two Griddles Cooking Without Cross Draft	2300	1000
114	Island Mounted Canopy Hood Without Side Panels With Two Griddles Idling With Cross Draft	Fail @ 6500	0
121	Island Mounted Canopy Hood Without Side Panels With Two Griddles Idling With Cross Draft	Fail @ 6500	1000
108	Island Mounted Canopy Hood Without Side Panels With Two Griddles Idling With Cross Draft	6500	0
113	Island Mounted Canopy Hood Without Side Panels With Two Griddles Idling Without Cross Draft	1975	300
120	Island Mounted Canopy Hood Without Side Panels With Two Griddles Idling Without Cross Draft	2700	1000
102	Island Mounted Canopy Hood Without Side Panels With Two Charbroilers Cooking With Cross Draft	6500	0
101	Island Mounted Canopy Hood Without Side Panels With Two Charbroilers Cooking Without Cross Draft	5100	250
72	Island Mounted Canopy Hood Without Side Panels With Two Charbroilers Idling With Cross Draft	6500	0
78	Island Mounted Canopy Hood Without Side Panels With Two Charbroilers Idling With Cross Draft	Fail @ 6500	failure @ 0
84	Island Mounted Canopy Hood Without Side Panels With Two Charbroilers Idling With Cross Draft	6500	1275
71	Island Mounted Canopy Hood Without Side Panels With Two Charbroilers Idling Without Cross Draft	4900	250
77	Island Mounted Canopy Hood Without Side Panels With Two Charbroilers Idling Without Cross Draft	4900	300
83	Island Mounted Canopy Hood Without Side Panels With Two Charbroilers Idling Without Cross Draft	4900	1275
142	Island Mounted Canopy Hood Without Side Panels With Two Griddles Cooking With Cross Draft	6300	0
107A	Island Mounted Canopy Hood Without Side Panels With Two Griddles Cooking Without Cross Draft	1975	1580

Table 2 Air Curtain Data			
Serial #	Situation	Exhaust	MUA
141	Island Mounted Canopy Hood Without Side Panels With Two Griddles Cooking Without Cross Draft	6250	600
140	Island Mounted Canopy Hood Without Side Panels With Two Griddles Cooking Without Cross Draft	2400	200
140	Island Mounted Canopy Hood Without Side Panels With Two Griddles Cooking Without Cross Draft	2400	200
141	Island Mounted Canopy Hood Without Side Panels With Two Griddles Cooking Without Cross Draft	6250	600
107	Island Mounted Canopy Hood Without Side Panels With Two Griddles Idling Without Cross Draft	1975	200
92	Wall Mounted Canopy Hood Without Side Panels With Two Charbroilers Cooking With Cross Draft	5400	0
94	Wall Mounted Canopy Hood With Side Panels With Two Charbroilers Cooking With Cross Draft	4750	0
98	Wall Mounted Canopy Hood Without Side Panels With Two Charbroilers Cooking With Cross Draft	5400	0
91	Wall Mounted Canopy Hood Without Side Panels With Two Charbroilers Cooking Without Cross Draft	4100	300
93	Wall Mounted Canopy Hood With Side Panels With Two Charbroilers Cooking Without Cross Draft	3700	550
99	Wall Mounted Canopy Hood With Side Panels With Two Charbroilers Cooking Without Cross Draft	3700	250
97	Wall Mounted Canopy Hood Without Side Panels With Two Charbroilers Cooking Without Cross Draft	4100	250
86	Wall Mounted Canopy Hood With Side Panels With Two Charbroilers Idling With Cross Draft	5200	0
88	Wall Mounted Canopy Hood Without Side Panels With Two Charbroilers Idling With Cross Draft	4200	0
70	Wall Mounted Canopy Hood With Side Panels With Two Charbroilers Idling With Cross Draft	4200	200
76	Wall Mounted Canopy Hood With Side Panels With Two Charbroilers Idling With Cross Draft	4200	100
82	Wall Mounted Canopy Hood With Side Panels With Two Charbroilers Idling With Cross Draft	4200	1275
68	Wall Mounted Canopy Hood Without Side Panels With Two Charbroilers Idling With Cross Draft	5200	300
74	Wall Mounted Canopy Hood Without Side Panels With Two Charbroilers Idling With Cross Draft	5200	400
80	Wall Mounted Canopy Hood Without Side Panels With Two Charbroilers Idling With Cross Draft	5200	1275
87	Wall Mounted Canopy Hood Without Side Panels With Two Charbroilers Idling Without Cross Draft	3400	400
69	Wall Mounted Canopy Hood With Side Panels With Two Charbroilers Idling Without Cross Draft	3400	300
75	Wall Mounted Canopy Hood With Side Panels With Two Charbroilers Idling Without Cross Draft	3400	1000
81	Wall Mounted Canopy Hood With Side Panels With Two Charbroilers Idling	3400	1275

Table 2 Air Curtain Data			
Serial #	Situation	Exhaust	MUA
	Without Cross Draft		
67	Wall Mounted Canopy Hood Without Side Panels With Two Charbroilers Idling Without Cross Draft	3600	200
73	Wall Mounted Canopy Hood Without Side Panels With Two Charbroilers Idling Without Cross Draft	3600	250
79	Wall Mounted Canopy Hood Without Side Panels With Two Charbroilers Idling Without Cross Draft	3600	1275
123	Wall Mounted Canopy Hood Without Side Panels With Two Griddles Cooking With Cross Draft	5700	1000
125	Wall Mounted Canopy Hood With Side Panels With Two Griddles Cooking With Cross Draft	4800	1000
129	Wall Mounted Canopy Hood Without Side Panels With Two Griddles Cooking With Cross Draft	4700	1000
131	Wall Mounted Canopy Hood With Side Panels With Two Griddles Cooking With Cross Draft	4150	1000
139	Wall Mounted Canopy Hood With Side Panels With Two Griddles Cooking With Cross Draft	4150	250
136	Wall Mounted Canopy Hood Without Side Panels With Two Griddles Cooking With Cross Draft	6300	0
122	Wall Mounted Canopy Hood Without Side Panels With Two Griddles Cooking Without Cross Draft	2525	1000
124	Wall Mounted Canopy Hood With Side Panels With Two Griddles Cooking Without Cross Draft	1900	1000
128	Wall Mounted Canopy Hood Without Side Panels With Two Griddles Cooking Without Cross Draft	1850	1000
130	Wall Mounted Canopy Hood With Side Panels With Two Griddles Cooking Without Cross Draft	1900	1000
137	Wall Mounted Canopy Hood With Side Panels With Two Griddles Cooking Without Cross Draft	1725	150
138	Wall Mounted Canopy Hood With Side Panels With Two Griddles Cooking Without Cross Draft	4000	430
137	Wall Mounted Canopy Hood With Side Panels With Two Griddles Cooking Without Cross Draft	1725	150
138	Wall Mounted Canopy Hood With Side Panels With Two Griddles Cooking Without Cross Draft	4000	430
134	Wall Mounted Canopy Hood Without Side Panels With Two Griddles Cooking Without Cross Draft	1950	200
135	Wall Mounted Canopy Hood Without Side Panels With Two Griddles Cooking Without Cross Draft	4800	490
134	Wall Mounted Canopy Hood Without Side Panels With Two Griddles Cooking Without Cross Draft	1950	200
135	Wall Mounted Canopy Hood Without Side Panels With Two Griddles Cooking Without Cross Draft	4800	490
110	Wall Mounted Canopy Hood Without Side Panels With Two Griddles Idling With Cross Draft	4000	0
112	Wall Mounted Canopy Hood With Side Panels With Two Griddles Idling With Cross Draft	3500	150

Table 2 Air Curtain Data			
Serial #	Situation	Exhaust	MUA
117	Wall Mounted Canopy Hood Without Side Panels With Two Griddles Idling With Cross Draft	4850	1000
119	Wall Mounted Canopy Hood With Side Panels With Two Griddles Idling With Cross Draft	4400	1000
106	Wall Mounted Canopy Hood With Side Panels With Two Griddles Idling With Cross Draft	3500	0
104	Wall Mounted Canopy Hood Without Side Panels With Two Griddles Idling With Cross Draft	4000	0
109	Wall Mounted Canopy Hood Without Side Panels With Two Griddles Idling Without Cross Draft	1475	350
111	Wall Mounted Canopy Hood With Side Panels With Two Griddles Idling Without Cross Draft	1275	400
116	Wall Mounted Canopy Hood Without Side Panels With Two Griddles Idling Without Cross Draft	1850	1000
118	Wall Mounted Canopy Hood With Side Panels With Two Griddles Idling Without Cross Draft	1700	1000
105	Wall Mounted Canopy Hood With Side Panels With Two Griddles Idling Without Cross Draft	1275	250
103	Wall Mounted Canopy Hood Without Side Panels With Two Griddles Idling Without Cross Draft	1475	700
103a	Wall Mounted Canopy Hood Without Side Panels With Two Griddles Idling Without Cross Draft	1475	1180
100	Wall Mounted Canopy Hood With Side Panels With Two Charbroilers Cooking With Cross Draft	4750	0
85	Wall Mounted Canopy Hood Without Side Panels With Two Charbroilers Idling Without Cross Draft	3600	300
125	Wall Mounted Canopy Hood With Side Panels With Two Griddles Cooking With Cross Draft	4800	1000
129	Wall Mounted Canopy Hood Without Side Panels With Two Griddles Cooking With Cross Draft	4700	1000

Table 3 Front Face Supply Raw Data			
Serial #	Condition	Exhaust	MUA
85	Wall Mounted Front Face Canopy Without Side Panels With Two Charbroilers Idling Without Cross Draft	3600	300
87	Wall Mounted Front Face Canopy With Side Panels With Two Charbroilers Idling Without Cross Draft	3400	400
86	Wall Mounted Front Face Canopy Without Side Panels With Two Charbroilers Idling With Cross Draft	5200	0
88	Wall Mounted Front Face Canopy With Side Panels With Two Charbroilers Idling With Cross Draft	4200	0
89	Island Mounted Front Face Canopy Without Side Panels With Two Charbroilers Idling Without Cross Draft	4900	0
90	Island Mounted Front Face Canopy Without Side Panels With Two Charbroilers Idling With Cross Draft	Fail @ 6500	0
91	Wall Mounted Front Face Canopy Without Side Panels With Two Charbroilers Cooking Without Cross Draft	4100	300
93	Wall Mounted Front Face Canopy With Side Panels With Two Charbroilers Cooking Without Cross Draft	3700	550
92	Wall Mounted Front Face Canopy Without Side Panels With Two Charbroilers Cooking With Cross Draft	5400	0
94	Wall Mounted Front Face Canopy With Side Panels With Two Charbroilers Cooking With Cross Draft	4750	0
95	Island Mounted Front Face Canopy Without Side Panels With Two Charbroilers Cooking Without Cross Draft	5100	400
96	Island Mounted Front Face Canopy Without Side Panels With Two Charbroilers Cooking With Cross Draft	6500	0
109	Wall Mounted Front Face Canopy Without Side Panels With Two Griddles Idling Without Cross Draft	1475	350
111	Wall Mounted Front Face Canopy With Side Panels With Two Griddles Idling Without Cross Draft	1275	400
110	Wall Mounted Front Face Canopy Without Side Panels With Two Griddles Idling With Cross Draft	4000	0
112	Wall Mounted Front Face Canopy With Side Panels With Two Griddles Idling With Cross Draft	3500	150
113	Island Mounted Front Face Canopy Without Side Panels With Two Griddles Idling Without Cross Draft	1975	300
114	Island Mounted Front Face Canopy Without Side Panels With Two Griddles Idling With Cross Draft	Fail @ 6500	0
143	Wall Mounted Front Face Canopy Without Side Panels With Two Griddles Cooking Without Cross Draft	1950	200
146	Wall Mounted Front Face Canopy With Side Panels With Two Griddles Cooking Without Cross Draft	1725	430
145	Wall Mounted Front Face Canopy Without Side Panels With Two Griddles Cooking With Cross Draft	6350	1900
147	Wall Mounted Front Face Canopy With Side Panels With Two Griddles Cooking With Cross Draft	4150	200
148	Island Mounted Front Face Canopy Without Side Panels With Two Griddles Cooking Without Cross Draft	2400	400
149	Island Mounted Front Face Canopy Without Side Panels With Two Griddles	Fail @ 6300	0

Table 3 Front Face Supply Raw Data			
Serial #	Condition	Exhaust	MUA
	Cooking With Cross Draft		
143	Wall Mounted Front Face Canopy Without Side Panels With Two Griddles Cooking Without Cross Draft	1950	200
	Wall Mounted Front Face Canopy With Side Panels With Two Griddles Cooking Without Cross Draft	1725	430
144	Wall Mounted Front Face Canopy Without Side Panels With Two Griddles Cooking Without Cross Draft	2200	490

Table 4 4-Way Ceiling Diffuser Raw Data			
Serial #	Condition	Exhaust	MUA
53	Island Mounted Canopy Hood Without Side Panels with Two Charbroilers Cooking With Cross Draft	Fail @ 6500	1000
52	Island Mounted Canopy Hood Without Side Panels with Two Charbroilers Cooking Without Cross Draft	Fail @ 6500	1000
41	Island Mounted Canopy Hood Without Side Panels with Two Charbroilers Idling With Cross Draft	Fail @ 6500	1000
40	Island Mounted Canopy Hood Without Side Panels with Two Charbroilers Idling Without Cross Draft	5300	1000
127	Island Mounted Canopy Hood Without Side Panels with Two Griddles Cooking With Cross Draft	Fail @ 6500	1000
126	Island Mounted Canopy Hood Without Side Panels with Two Griddles Cooking Without Cross Draft	3450	1000
121	Island Mounted Canopy Hood Without Side Panels with Two Griddles Idling With Cross Draft	Fail @ 6500	1000
120	Island Mounted Canopy Hood Without Side Panels with Two Griddles Idling Without Cross Draft	2700	1000
51	Wall Mounted Canopy Hood With Side Panels with Two Charbroilers Cooking With Cross Draft	5000	1000
50	Wall Mounted Canopy Hood With Side Panels with Two Charbroilers Cooking Without Cross Draft	4400	1000
39	Wall Mounted Canopy Hood With Side Panels with Two Charbroilers Idling With Cross Draft	4800	1000
38	Wall Mounted Canopy Hood With Side Panels with Two Charbroilers Idling Without Cross Draft	3800	1000
125	Wall Mounted Canopy Hood With Side Panels with Two Griddles Cooking With Cross Draft	4800	1000
124	Wall Mounted Canopy Hood With Side Panels with Two Griddles Cooking Without Cross Draft	1900	1000
119	Wall Mounted Canopy Hood With Side Panels with Two Griddles Idling With Cross Draft	4400	1000
118	Wall Mounted Canopy Hood With Side Panels with Two Griddles Idling Without Cross Draft	1700	1000
49	Wall Mounted Canopy Hood Without Side Panels with Two Charbroilers Cooking With Cross Draft	6000	1000
48	Wall Mounted Canopy Hood Without Side Panels with Two Charbroilers Cooking Without Cross Draft	4400	1000
37	Wall Mounted Canopy Hood Without Side Panels with Two Charbroilers Idling With Cross Draft	5750	1000
36	Wall Mounted Canopy Hood Without Side Panels with Two Charbroilers Idling Without Cross Draft	4300	1000
176	Wall Mounted Canopy Hood Without Side Panels with Two Charbroilers Idling Without Cross Draft	3600	0
177	Wall Mounted Canopy Hood Without Side Panels with Two Charbroilers Idling Without Cross Draft	4500	900
178	Wall Mounted Canopy Hood Without Side Panels with Two Charbroilers Idling Without Cross Draft	4900	1800
179	Wall Mounted Canopy Hood Without Side Panels with Two	3600	450

Table 4 4-Way Ceiling Diffuser Raw Data			
Serial #	Condition	Exhaust	MUA
	Charbroilers Idling Without Cross Draft		
123	Wall Mounted Canopy Hood Without Side Panels with Two Griddles Cooking With Cross Draft	5700	1000
122	Wall Mounted Canopy Hood Without Side Panels with Two Griddles Cooking Without Cross Draft	2525	1000
117	Wall Mounted Canopy Hood Without Side Panels with Two Griddles Idling With Cross Draft	4850	1000
116	Wall Mounted Canopy Hood Without Side Panels with Two Griddles Idling Without Cross Draft	1850	1000
171	Wall Mounted Canopy Hood Without Side Panels with Two Griddles Idling Without Cross Draft	1470	0
172	Wall Mounted Canopy Hood Without Side Panels with Two Griddles Idling Without Cross Draft	1470	150
173	Wall Mounted Canopy Hood Without Side Panels with Two Griddles Idling Without Cross Draft	1750	370
174	Wall Mounted Canopy Hood Without Side Panels with Two Griddles Idling Without Cross Draft	2100	735
175	Wall Mounted Canopy Hood Without Side Panels with Two Griddles Idling Without Cross Draft	2500	1100
345	Wall Mounted Proximity Hood With Full Side Panels with Two Charbroilers Cooking With Cross Draft	2500	100
342	Wall Mounted Proximity Hood With Full Side Panels with Two Charbroilers Cooking Without Cross Draft	1250	100
328	Wall Mounted Proximity Hood With Full Side Panels with Two Charbroilers Idling With Cross Draft	2300	
325	Wall Mounted Proximity Hood With Full Side Panels with Two Charbroilers Idling Without Cross Draft	1150	
305	Wall Mounted Proximity Hood With Side Panels with Two Griddles Cooking With Cross Draft	2825	1000
304	Wall Mounted Proximity Hood With Side Panels with Two Griddles Cooking Without Cross Draft	1700	1000
288	Wall Mounted Proximity Hood With Side Panels with Two Griddles Idling With Cross Draft	2300	1000
287	Wall Mounted Proximity Hood With Side Panels with Two Griddles Idling Without Cross Draft	1625	1000
348	Wall Mounted Proximity Hood Without Side Panels with Two Charbroilers Cooking With Cross Draft	2650	
350	Wall Mounted Proximity Hood Without Side Panels with Two Charbroilers Cooking With Cross Draft	2900	1000
341	Wall Mounted Proximity Hood Without Side Panels with Two Charbroilers Cooking Without Cross Draft	1800	1000
331	Wall Mounted Proximity Hood Without Side Panels with Two Charbroilers Idling With Cross Draft	2500	
333	Wall Mounted Proximity Hood Without Side Panels with Two Charbroilers Idling With Cross Draft	2750	1000
321	Wall Mounted Proximity Hood Without Side Panels with Two Charbroilers Idling Without Cross Draft	1175	
323	Wall Mounted Proximity Hood Without Side Panels with Two	1575	1000

Table 4 4-Way Ceiling Diffuser Raw Data			
Serial #	Condition	Exhaust	MUA
	Charbroilers Idling Without Cross Draft		
306	Wall Mounted Proximity Hood Without Side Panels with Two Griddles Cooking With Cross Draft	3500	1000
302	Wall Mounted Proximity Hood Without Side Panels with Two Griddles Cooking Without Cross Draft	800	
303	Wall Mounted Proximity Hood Without Side Panels with Two Griddles Cooking Without Cross Draft	1700	1000
289	Wall Mounted Proximity Hood Without Side Panels with Two Griddles Idling With Cross Draft	2900	1000
286	Wall Mounted Proximity Hood Without Side Panels with Two Griddles Idling Without Cross Draft	1650	1000

Table 5 4-Way Location Sensitivity			
Serial #	Condition	Exhaust	MUA
33	Wall Mounted Canopy Hood Without Side Panels with Two Charbroilers Idling and 1000 cfm from the Left Rear 4-way	3900	1000
34	Wall Mounted Canopy Hood Without Side Panels with Two Charbroilers Idling and 1000 cfm from the Left Front 4-way	4200	1000
35	Wall Mounted Canopy Hood Without Side Panels with Two Charbroilers Idling and 1000cfm from the Center Front 4-way	4100	1000
30	Island Mounted Canopy Hood Without Side Panels with Two Charbroilers Idling and 1000cfm from the Left Rear 4-way	5800	1000
31	Island Mounted Canopy Hood Without Side Panels with Two Charbroilers Idling and 1000cfm from the Left Front 4-way	5600	1000
32	Island Mounted Canopy Hood Without Side Panels with Two Charbroilers Idling and cfm from the Center Front 4-way	6000	1000

Table 6 Hood Edge Velocity Map										
MUA Flow Rate from 4-Way cfm	Location									Average Velocity fpm
	0	1	2	3	4	5	6	7	8	
	(Distance from Corner of Hood in Feet)									
100 cfm	38	60	55	62	49	41	0	0	0	34
200 cfm	57	67	74	65	65	60	38	41	0	52
450 cfm	38	39	72	136	101	86	78	78	70	78
600 cfm	41	78	102	143	131	107	93	83	77	95
800 cfm	64	110	181	199	162	139	117	133	112	135
1000 cfm	83	101	206	248	208	180	161	181	153	169
1200 cfm	131	193	240	250	231	191	136	218	183	197
1400 cfm	117	186	283	275	265	211	189	267	202	222
1600 cfm	138	198	313	288	272	231	193	276	237	238

Table 7 Short Circuit Raw Data			
Serial #	Condition	Exhaust	MUA
223	Wall Mounted Short Circuit Canopy Hood Without Side Panels With Two Charbroilers Cooking Without Cross Draft	3576	250
226	Wall Mounted Short Circuit Canopy Hood With Side Panels With Two Charbroilers Cooking Without Cross Draft	3377	675
233	Wall Mounted Short Circuit Canopy Hood Without Side Panels With Two Charbroilers Idling Without Cross Draft	3377	0
234	Wall Mounted Short Circuit Canopy Hood With Side Panels With Two Charbroilers Idling Without Cross Draft	3077	0
239	Wall Mounted Short Circuit Canopy Hood Without Side Panels With Two Charbroilers Idling Without Cross Draft	3377	600
242	Wall Mounted Short Circuit Canopy Hood With Side Panels With Two Charbroilers Idling Without Cross Draft	3077	100
252	Wall Mounted Short Circuit Canopy Hood Without Side Panels With Two Griddles Idling Without Cross Draft	1720	0
253	Wall Mounted Short Circuit Canopy Hood With Side Panels With Two Griddles Idling Without Cross Draft	1525	0
258	Wall Mounted Short Circuit Canopy Hood Without Side Panels With Two Griddles Idling Without Cross Draft	1720	250
259	Wall Mounted Short Circuit Canopy Hood With Side Panels With Two Griddles Idling Without Cross Draft	1525	325
272	Wall Mounted Short Circuit Canopy Hood Without Side Panels With Two Griddles Cooking Without Cross Draft	2700	300
273	Wall Mounted Short Circuit Canopy Hood Without Side Panels With Two Griddles Cooking Without Cross Draft	3200	675
274	Wall Mounted Short Circuit Canopy Hood Without Side Panels With Two Griddles Cooking Without Cross Draft	3600	2025
275	Wall Mounted Short Circuit Canopy Hood With Side Panels With Two Griddles Cooking Without Cross Draft	1750	320

Table 8 Backwall Supply Raw Data			
Serial #	Condition	Exhaust	MUA
48	Wall Mounted Canopy Hood Without Side Panels with Two Charbroilers Cooking Without Cross Draft	4400	1000
37	Wall Mounted Canopy Hood Without Side Panels with Two Charbroilers Idling With Cross Draft	5750	1000
36	Wall Mounted Canopy Hood Without Side Panels with Two Charbroilers Idling Without Cross Draft	4300	1000
176	Wall Mounted Canopy Hood Without Side Panels with Two Charbroilers Idling Without Cross Draft	3600	
177	Wall Mounted Canopy Hood Without Side Panels with Two Charbroilers Idling Without Cross Draft	4500	
178	Wall Mounted Canopy Hood Without Side Panels with Two Charbroilers Idling Without Cross Draft	4900	
179	Wall Mounted Canopy Hood Without Side Panels with Two Charbroilers Idling Without Cross Draft	3600	
123	Wall Mounted Canopy Hood Without Side Panels with Two Griddles Cooking With Cross Draft	5700	1000
122	Wall Mounted Canopy Hood Without Side Panels with Two Griddles Cooking Without Cross Draft	2525	1000
117	Wall Mounted Canopy Hood Without Side Panels with Two Griddles Idling With Cross Draft	4850	1000
116	Wall Mounted Canopy Hood Without Side Panels with Two Griddles Idling Without Cross Draft	1850	1000
171	Wall Mounted Canopy Hood Without Side Panels with Two Griddles Idling Without Cross Draft	1470	
172	Wall Mounted Canopy Hood Without Side Panels with Two Griddles Idling Without Cross Draft	1470	
173	Wall Mounted Canopy Hood Without Side Panels with Two Griddles Idling Without Cross Draft	1750	
174	Wall Mounted Canopy Hood Without Side Panels with Two Griddles Idling Without Cross Draft	2100	
175	Wall Mounted Canopy Hood Without Side Panels with Two Griddles Idling Without Cross Draft	2500	
345	Wall Mounted Proximity Hood With Full Side Panels with Two Charbroilers Cooking With Cross Draft	2500	
342	Wall Mounted Proximity Hood With Full Side Panels with Two Charbroilers Cooking Without Cross Draft	1250	
328	Wall Mounted Proximity Hood With Full Side Panels with Two Charbroilers Idling With Cross Draft	2300	
325	Wall Mounted Proximity Hood With Full Side Panels with Two Charbroilers Idling Without Cross Draft	1150	
305	Wall Mounted Proximity Hood With Side Panels with Two Griddles Cooking With Cross Draft	2825	1000
304	Wall Mounted Proximity Hood With Side Panels with Two Griddles Cooking Without Cross Draft	1700	1000
288	Wall Mounted Proximity Hood With Side Panels with Two Griddles Idling With Cross Draft	2300	1000
287	Wall Mounted Proximity Hood With Side Panels with Two Griddles	1625	1000

Table 8 Backwall Supply Raw Data			
Serial #	Condition	Exhaust	MUA
	Idling Without Cross Draft		
348	Wall Mounted Proximity Hood Without Side Panels with Two Charbroilers Cooking With Cross Draft	2650	
350	Wall Mounted Proximity Hood Without Side Panels with Two Charbroilers Cooking With Cross Draft	2900	1000
341	Wall Mounted Proximity Hood Without Side Panels with Two Charbroilers Cooking Without Cross Draft	1800	1000
331	Wall Mounted Proximity Hood Without Side Panels with Two Charbroilers Idling With Cross Draft	2500	
333	Wall Mounted Proximity Hood Without Side Panels with Two Charbroilers Idling With Cross Draft	2750	1000
321	Wall Mounted Proximity Hood Without Side Panels with Two Charbroilers Idling Without Cross Draft	1175	
323	Wall Mounted Proximity Hood Without Side Panels with Two Charbroilers Idling Without Cross Draft	1575	1000
306	Wall Mounted Proximity Hood Without Side Panels with Two Griddles Cooking With Cross Draft	3500	1000
302	Wall Mounted Proximity Hood Without Side Panels with Two Griddles Cooking Without Cross Draft	800	
303	Wall Mounted Proximity Hood Without Side Panels with Two Griddles Cooking Without Cross Draft	1700	1000
289	Wall Mounted Proximity Hood Without Side Panels with Two Griddles Idling With Cross Draft	2900	1000
286	Wall Mounted Proximity Hood Without Side Panels with Two Griddles Idling Without Cross Draft	1650	1000

Table 9 Heat Gain Values			
Serial #	Condition	Exhaust [cfm]	Heat Gain [kBtu]
3	8ft.w x 4ft.d Canopy Hood Without Side Panels with Two Griddles Idling Without Cross Draft	2500	6.0
20	8ft.w x 4ft.d Canopy Hood Without Side Panels with Two Charbroilers Idling Without Cross Draft	3200	17.7
188	8ft.w x 4ft.d Canopy Hood Without Side Panels with One Griddle Idling Without Cross Draft	2400	2.2
193	8ft.w x 4ft.d Canopy Hood Without Side Panels with One Charbroiler Idling Without Cross Draft	3200	12.2
N/A	5ft.w x 4ft.d Canopy Hood Without Side Panels with One Griddle Idling Without Cross Draft	1500	4.7
N/A	5ft.w x 4ft.d Canopy Hood Without Side Panels with One Charbroiler Idling Without Cross Draft	2000	14.2

Appendix II: Laboratory Description

The test laboratory's size and shape were configured to closely model a typical commercial kitchen. The structure was built with layered airtight walls and multiple airtight roof penetrations or "curbs" to which hoods and fans could be installed in various locations throughout the facility. The laboratory doors were custom fabricated and sealed to provide access to the room without allowing air leakage to occur.

To ensure accurate and repeatable test results, the laboratory was equipped with state of the art metrology. A nozzle-type airflow measurement chamber was installed on a single air supply system for the laboratory. Precise control of the air volume entering and leaving the test laboratory was achieved using variable speed drives on the hood's exhaust fan, as well as the laboratory's single supply fan. The laboratory control system was programmed to automatically maintain a near-zero differential pressure between inside and outside of the test laboratory. With the laboratory being airtight and the differential pressure at zero, it was known that the air volume entering the laboratory equaled the air volume leaving the laboratory. Therefore, airflow measurement could be done on the clean supply air stream to protect the sensors.

The laboratory uses floor-standing displacement ventilators along the wall furthest from the tested equipment as one of its supply air systems. This displacement ventilation strategy has proven to minimize the impact of the supply airflow on the hood's capability to capture effluent from the appliances.

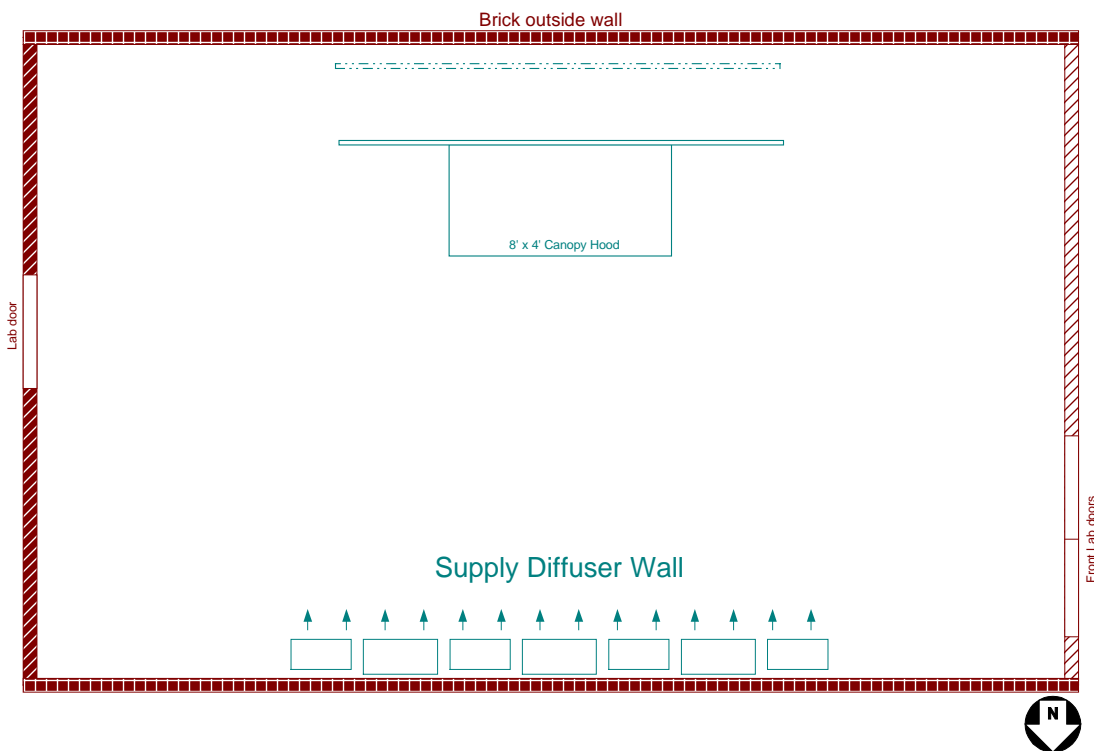

Figure A-1 Plan View of the test laboratory. The airflow from the supply diffusers to the hood is indicated through arrows.

A second air supply system was used to study various independent MUA strategies. With this system, concepts such as short-circuit hoods, as well as other hood-local air supplies could be readily evaluated. While this second system supplies the local MUA, the before explained supply system can be used to maintain a minimal differential pressure between the laboratory's interior and exterior.

The here explained second supply system uses a 16-inch utility type fan that horizontally discharges into a 16-inch diameter airflow measurement system employing a pitot tube array. The air stream then turns downward and enters the laboratory. For the MUA study, the air is distributed over five 12-inch diameter ducts, equipped with remote-controlled dampers and laminar flow elements (LFE's) for airflow measurement. The measured air supply is then available for any supply configuration to be tested.

Figure A-2 shows the roof of the laboratory with the three ventilation systems. Each system turns downward 90 degrees to enter the airtight test area through a sealed penetration curb.

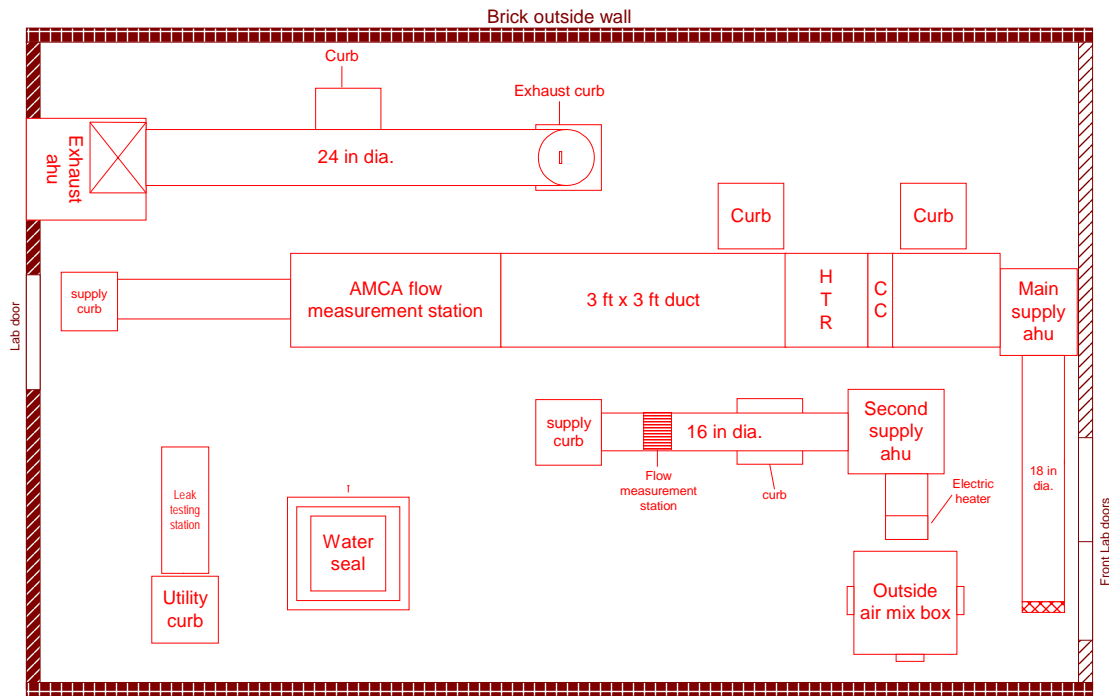

Figure A-2 Plan View of the laboratory roof with all HVAC equipment.

A suspended ceiling at a height of 9 feet, which is typical for commercial kitchens, was used to simulate and test the effects of ceiling. The ceiling included five 4-way supply diffusers located 1-foot from the hood. Using remote-control dampers and LFE's, air distribution from the ceiling can be modulated for a variety of test scenarios.

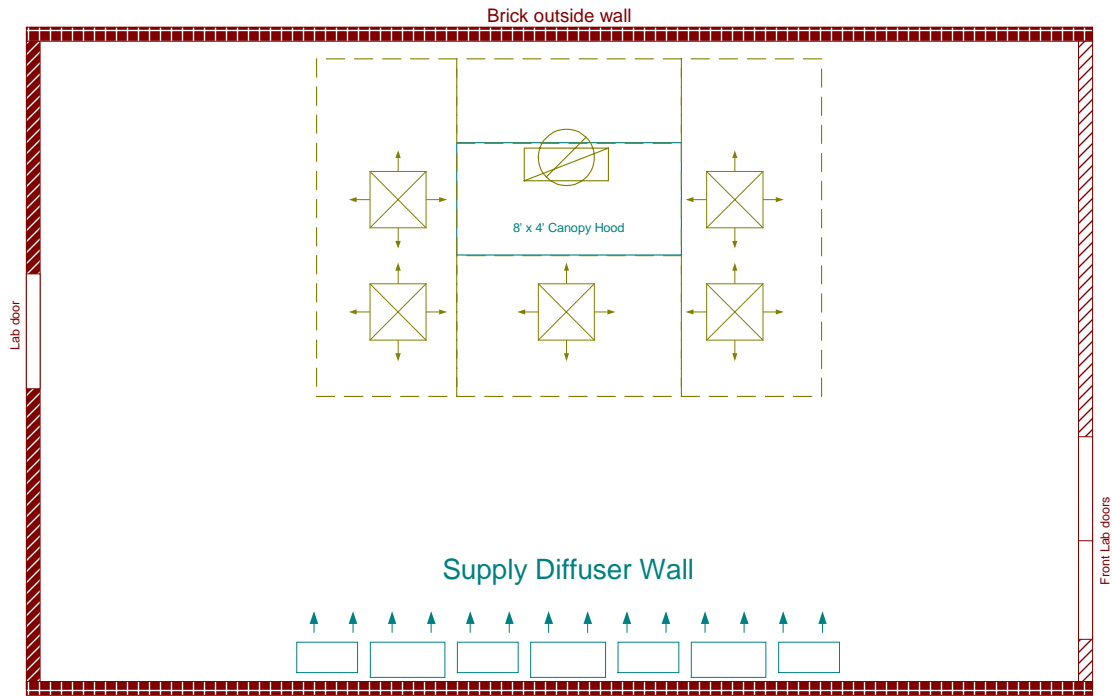

Figure A-3 Plan View of supply air equipment and exhaust hood in the test laboratory.

Oversized strut-type bracing was used to suspend the hood, ceiling, MUA ductwork, and portable backwall to allow for quick adaptability to the various test requirements.

A portable backwall allows fast changing from a wall-mounted to an island-mounted canopy hood. The 16-foot wide by 8-foot tall wall was constructed of clear plastic to accommodate the visualization systems, and mounted to a trolley system in the suspended ceiling. The wall can also shift left to right and partially collapse to allow for test changes.

Instrumentation and Control

The data acquisition system consists of various components communicating with a custom developed control program. The sensors interface with a modular data acquisition rack, capable of reading a wide range of input signals and providing control signals out to the equipment. Temperatures are monitored with an IEEE-bus controlled high precision multimeter and scanner designed for high-accuracy 4-wire 100-ohm platinum resistance thermal devices (RTDs). The system uses industry standard inputs including 4.20mA, 0.5VDC, various pulse inputs, and more to communicate with a variety of signal transducers. Equipment can be controlled through digital output channels as well as through industry standard analog signals.

The control program modulates the MUA supply system or exhaust blower to achieve the desired airflow rate and room pressure. All measured values during tests can be recorded to a single data file in designated time intervals.

The AMCA flow measurement station contains three precision-spun nozzles, located on a board inside a fully welded chamber. The airflow through this chamber can be calculated from the absolute pressure upstream before the nozzles combined with the measured differential pressure across the nozzles. Dew point and dry bulb temperature of the supply air are also measured to allow conversion of the calculated airflow to standard conditions.

The second MUA system uses a pitot tube array to measure its airflow. Dew point and dry bulb are measured to allow conversion of the airflow to standard conditions. LFE's are used to measure the airflow through each of the five ceiling diffusers, allowing the evaluation of subtle changes in MUA distribution.

Temperatures are measured every few seconds and recorded. Measured points include; natural gas temperature, cooking process, appliance surface, and hood surface temperatures. An equal-area concentric array of 12 RTDs is located in the exhaust duct to record the exhaust air temperature. For calculating heat gain to the space, the temperature of the air approaching the appliance/hood combination is monitored by twelve aspirated RTDs mounted to four vertical posts in a semi-circle around the appliance.

Pressure transducers are used to monitor airflow station pressures, room differential pressure, exhaust hood static pressure, and natural gas pressure with an accuracy of 0.25% of full scale. The barometric pressure is measured with a transducer having an error of less than 0.1% of full scale.

Gas volume is measured with laboratory-grade, positive displacement gas meters, which are modified to provide a pulse output to the data acquisition system. The calorific value of the natural gas is continuously measured to monitor the amount of energy contained in each cubic foot of natural gas. The energy input from natural gas is then calculated from volume, calorific value, and temperature of the natural gas.

Standard utility watt-hour meters measure regulated 208V three-phase electrical energy with pulse outputs to the data acquisition system. Energy input from 120VAC single phase is monitored by a watt hour transducer.

All measuring devices and instrumentation are periodically calibrated against standards of known accuracy. Using NIST traceable calibration standards, their respective manufacturers certify the calibration instruments according to a documented calibration schedule.

Precision and Bias

The Precision and Bias section in ASTM 1704-99 *Standard Test Method for the Performance of Commercial Kitchen Ventilation Systems* states that the error in the capture and containment value shall not exceed 20%. The airflow measurements in the laboratory are in compliance with ASHRAE Standard 41.2-1987, *Standard Laboratory Methods for Airflow Measurement*. The error on the make-up airflow rate measurement is less than 2% and the error on the supply airflow rate measurement is less than 1%. The repeatability of capture and containment measurements at the CKV laboratory was investigated and the error was found to be below 14% with a typical error of about 7%. Circumstances that affect the capture and containment repeatability include situations that render the visualization system less effective such as dilution air that reduces the temperature difference between exhaust air and room air, and volumetric effects of seeding.