



PDHonline Course M285 (1 PDH)

Kitchen Ventilation Improvement

Instructor: Steven G. Liescheidt, P.E., CCS, CCPR

2020

PDH Online | PDH Center

5272 Meadow Estates Drive
Fairfax, VA 22030-6658
Phone: 703-988-0088
www.PDHonline.com

An Approved Continuing Education Provider

Design Guide

Improving Commercial Kitchen Ventilation System Performance

This design guide provides information that will help achieve optimum performance and energy efficiency in commercial kitchen ventilation systems. The information presented is applicable to new construction and, in many instances, retrofit construction. The audience for this guideline is kitchen designers, mechanical engineers, food service operators, property managers, and maintenance people. This guide is intended to augment comprehensive design information published in the Kitchen Ventilation Chapter in the ASHRAE Handbook on HVAC Applications.

Introduction

An effective commercial kitchen ventilation (CKV) system requires balance—air balance that is. And as the designer, installer or operator of the kitchen ventilation system, you may be the first person called upon to perform your own “balancing act” when the exhaust hood doesn’t work. Unlike a cooking appliance, which can be isolated for troubleshooting, the exhaust hood is only one component of the kitchen ventilation system. To further complicate things, the CKV system is a subsystem of the overall building heating, ventilating and air-conditioning (HVAC) system. Fortunately, there is no “magic” to the relationship between an exhaust hood and its requirement for replacement or makeup air (MUA). The physics are simple: air that exits the building (through exhaust hoods and fans) must be replaced with outside air that enters the building (intentionally or otherwise). The essence of *air balance*: “air in” = “air out!”

Background

If the replacement air doesn’t come in, that means it doesn’t go out the exhaust hood and problems begin. Not only will the building pressure become too “negative,” the hood may not capture and contain (C&C) cooking effluents due to reduced exhaust flow. We have all experienced the “can’t-open-the-door” syndrome because the exhaust fan is sucking too hard on the inside of the restaurant. The mechanical design may call for 8000 cubic feet per minute (cfm) of air to be exhausted through the hood. But if only 6000 cfm of outdoor air is able to squeeze in through closed dampers on rooftop units and undesirable pathways in the building envelope, then only 6000 cfm is available to be exhausted through the hood. The exhaust fan creates more suction (negative pressure) in an unsuccessful attempt to pull more air through the hood.

There is no piece of equipment that generates more controversy within the food service equipment supply and design community than the exhaust hood in all its styles and makeup air combinations. The idea that by not installing a dedicated

Introduction	1
Background	1
Kitchen Ventilation Fundamentals	2
Influence of Makeup Air	5
MUA Recommendations	6
Influence of Other Factors	9
Energy Saving Considerations	6
Design Guide Summary	12
Case Study	13

makeup air supply, the operator is going to save money (in both first cost and operating cost) is short sighted. It may be okay if, by design, all of the makeup air can be provided through the rooftop HVAC units (this strategy has been adopted successfully by several leading quick-service restaurant chains). However, in full-service and institutional kitchens with larger exhaust requirements, it may not be practical (or energy efficient) to supply 100% of the replacement (makeup) air through the building HVAC system.

The solution is to specify an independent makeup air supply. But, once dedicated MUA has been added to the system, the challenge becomes introducing this air into the kitchen without disrupting the ability of the hood to capture and/or without causing discomfort for the kitchen staff. Kitchens are not large and dumping 7000 cfm of MUA, for example, in front of a cook line does not go as smoothly in practice as it does on the *air balance schedule!* Not only can makeup air velocities impact the ability of the hood to capture and contain cooking effluent, locally supplied makeup air that is too cold or too hot can create an uncomfortable working environment. This design guide presents strategies that can minimize the impact that the makeup air introduction will have on hood performance and energy consumption.

Fundamentals of Kitchen Ventilation

Hot air rises! An exhaust fan in the ceiling could easily remove the heat produced by cooking equipment. But mix in smoke, volatile organic compounds, grease particles and vapor from cooking, a means to capture and contain the effluent is needed to avoid health and fire hazards. While an exhaust hood serves that purpose, the key question is always: what is the appropriate exhaust rate? The answer always depends on the type (and use) of the cooking equipment under the hood, the style and geometry of the hood itself, and how the makeup air (conditioned or otherwise) is introduced into the kitchen.

Cooking appliances are categorized as light-, medium-, heavy-, and extra heavy-duty, depending on the strength of the thermal plume and the quantity of grease and smoke produced. The strength of the thermal plume is a major factor in determining the exhaust rate. By their nature, these thermal plumes are very turbulent and different cooking processes have different “surge” characteristics. For example, the plume from hamburger cooking is strongest when flipping the burgers. Ovens and pressure fryers may have very little plume until they are opened to remove food product. Open flame, non-thermostatically controlled appliances, such

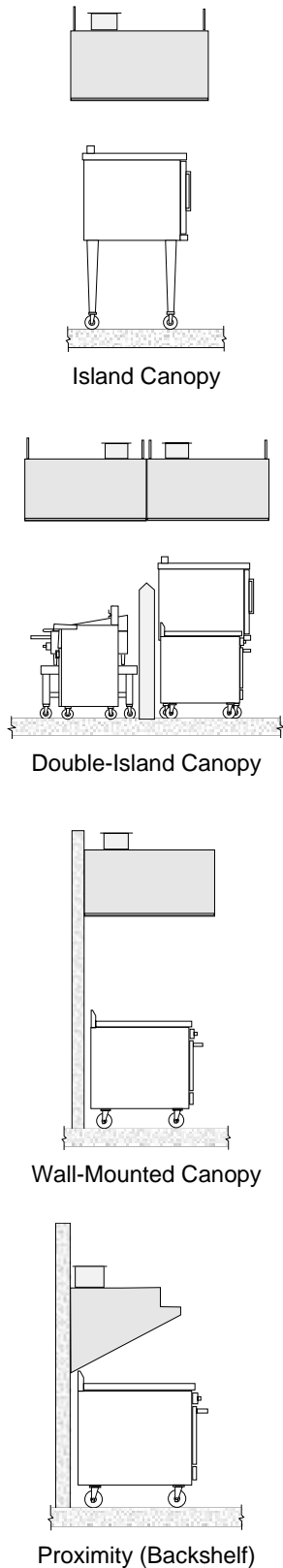

Figure 1. CKV Hood Types.

as underfired broilers and open top ranges, exhibit strong steady plumes. Thermostatically controlled appliances, such as griddles and fryers have weaker plumes that fluctuate in sequence with thermostat cycling (particularly gas-fired equipment). As the plume rises by natural convection, it is captured by the hood and removed by the suction of the exhaust fan. Air in the proximity of the appliances and hood moves in to replace it. This replacement air, which originates as outside air, is referred to as makeup air.

The design exhaust rate also depends on the hood style and design features. Wall-mounted canopy hoods, island (single or double) canopy hoods, and proximity (backshelf, pass-over, or eyebrow) hoods all have different capture areas and are mounted at different heights relative to the cooking equipment (see Figure 1). Generally, a single-island canopy hood requires more exhaust than a wall-mounted hood, and a wall-mounted hood requires more exhaust than a proximity hood. The performance of a double-island canopy tends to emulate the performance of two back-to-back wall-canopy hoods, although the lack of a physical barrier between the two hood sections makes the configuration more susceptible to cross drafts.

Lastly, the layout of the HVAC and MUA distribution points can affect hood performance. These can be sources that disrupt thermal plumes and hinder capture and containment. Location of delivery doors, service doors, pass-through openings and drive-through windows can also be sources of cross drafts. Safety factors are typically applied to the design exhaust rate to compensate for the effect that undesired air movement within the kitchen has on hood performance.

CKV System Performance Testing

The phrase "hood capture and containment" is defined in ASTM F-1704 *Standard Test Method for the Performance of Commercial Kitchen Ventilation Systems* as "the ability of the hood to capture and contain grease-laden cooking vapors, convective heat and other products of cooking processes." Hood capture refers to these products entering the hood reservoir from the area under the hood, while containment refers to these products staying in the hood reservoir and not spilling out into the adjacent space. The phrase "minimum capture and containment" is defined as "the conditions of hood operation in which minimum exhaust flow rates are just sufficient to capture and contain the products generated by the appliance in idle or heavy-load cooking conditions, and at any intermediate prescribed load condition." The abbreviation "C&C" refers to the "minimum capture and containment" flow rate as defined in ASTM F-1704.

Performance testing in accordance with ASTM F-1704 at the CKV Laboratory in Wood Dale, IL, incorporates a schlieren flow-visualization system to verify capture and containment. This system is a major breakthrough for visualizing thermal and effluent plumes from cooking processes. “Schlieren” is derived from the German word for “smear.” A schlieren system presents an amplified optical image (see Figure 2) due to the different air densities, similar to the mirage effect we see over hot pavement.

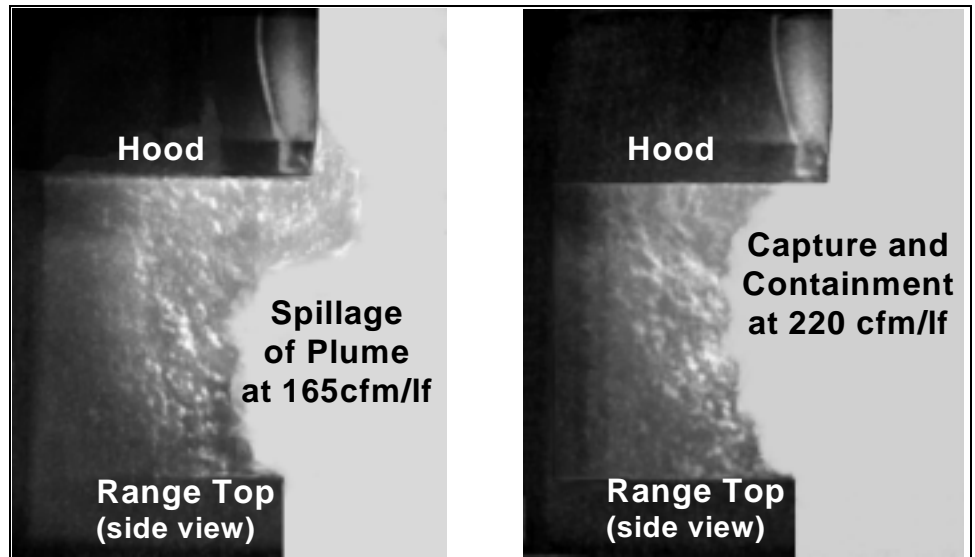

Figure 2. Schlieren images at different exhaust rates per linear foot (lf).

Replacement (Makeup) Air Distribution

Air that is removed from the kitchen through an exhaust hood must be replaced with an equal volume of makeup air through one or more of the following pathways:

- Transfer air (e.g., from the dining room)
- Displacement diffusers (floor or wall mounted)
- Ceiling diffusers with louvers (2-way, 3-way, 4-way)
- Slot diffusers (ceiling)
- Ceiling diffusers with perforated face
- Integrated hood plenum (see Figure 3) including:
 1. Short circuit (internal supply)
 2. Air curtain supply
 3. Front face supply
 4. Perforated perimeter supply
 5. Backwall supply (rear discharge)
 6. Combinations of the above

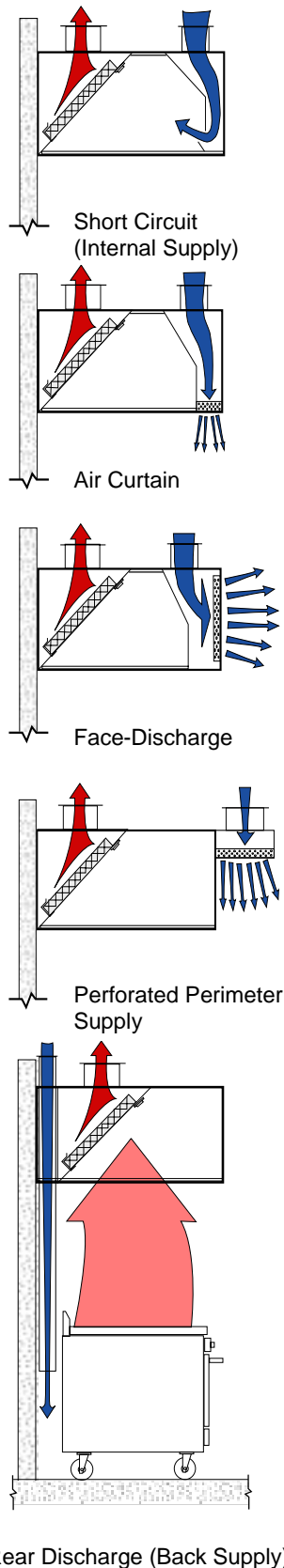

Figure 3. Types of MUA Supply Integrated with the hood.

Influence of Makeup Air on Exhaust Hood Performance

Makeup air that is supplied through displacement ventilation diffusers remote from the hood, perforated diffusers located in the ceiling as far as possible from the hood, or as transfer air from the dining room generally works well if air velocities approaching the hood are less than 75 feet per minute (fpm). Makeup air introduced in close proximity to an exhaust hood has the potential, however, to interfere with the hood’s ability to capture and contain. The chances of makeup air affecting hood performance increases as the percentage of the locally supplied MUA (relative to the total exhaust) is increased. In fact, the 80% rule-of-thumb for sizing airflow through a MUA unit can be a recipe for trouble, particularly if the exhaust flow rate has been over-specified to start with.

Temperature of the locally supplied makeup air can also impact hood performance as air density (buoyancy) impacts the dynamics of air movement around the hood. Generally, hotter MUA temperatures (e.g., 90°F) will affect hood performance more adversely than cooler air (e.g., 75°F). In most temperate climates, such as many areas in California, evaporative cooling is an effective method of maintaining MUA temperatures within a range that is comfortable for kitchen staff and does not hamper hood performance. However, the maintenance requirements of evaporative coolers must be factored into the equation.

The primary recommendation for minimizing the impact that locally supplied MUA will have on hood performance is to minimize the velocity (fpm) of the makeup air as it is introduced near the hood. This can be accomplished by minimizing the volume (cfm) of makeup air through any one pathway, by maximizing the area of the grilles or diffusers through which the MUA is supplied, or by using a combination of pathways.

The first step in reducing the MUA requirement is to minimize the design exhaust rate. This can be accomplished by prudent selection and application of UL Listed hoods and taking advantage of the “exhaust flow” recommendations from hood suppliers for the cookline under consideration. Exhaust hood manufacturers’ sales and engineering departments have a lot of experience that CKV design consultants can tap to help minimize the “safety factor” applied to exhaust rates.

The second step in reducing MUA flow is to take credit for outside air that must be supplied by the HVAC system to meet code requirements for ventilating the dining room. Depending on the architectural layout between the kitchen and the dining room, it may be practical to transfer most of this air from the dining room to

the kitchen. For example, if 2400 cfm of outdoor air that is being supplied to a 160-seat dining room can be transferred to the kitchen, the local makeup air requirement can be reduced accordingly.

Rather than supplying 80 to 90% of the exhaust rate through one makeup air strategy, designers should make an effort to keep this ratio below 60% (obviously, the other 40% of the replacement air must be derived from another source such as transfer air, another local strategy, or HVAC supply). Although this may contradict past practice, it will be effective! Not only will hood performance be superior, the kitchen environment will benefit from the cooling contribution of the “recycled” dining room air. It is important to realize that the outdoor air required by code is usually conditioned before it is introduced into the dining room. So... why not use this outdoor air as a makeup air credit?

The third step in reducing MUA flow is to select a configuration for introducing this local makeup air into the kitchen that compliments the style and size of hood. If transfer air is not an option, consider a combination of makeup air strategies (e.g., backwall supply and perforated ceiling diffusers). This reduces the velocity of air being supplied through each local pathway, mitigating potential problems with hood capture. Effective options (at 60% or less) include front face supply, backwall supply, and perforated perimeter supply. Short-circuit supply is not recommended, and air-curtains should be used with extreme caution. The pros and cons of the different configurations are discussed below. Note a frequent theme—minimizing MUA discharge velocity is key to avoiding detrimental impacts on hood capture and containment.

Short-Circuit Supply (Internal Makeup Air)

The application of short-circuit makeup air hoods is a controversial topic. These internal makeup air hoods were developed as a strategy to reduce the amount of conditioned air required by an exhaust system. By introducing a portion of the required makeup air in an untempered condition directly into the exhaust hood reservoir, the net amount of conditioned air exhausted from the kitchen is reduced. Research has shown however, that in the cases tested, internal MUA cannot be introduced at a rate that is more than 15% of the threshold C&C exhaust rate without causing spillage (despite what is shown on the air balance schedule or marketing literature). When short circuit hoods are operated at higher percentages of internal MUA they fail to capture and contain the cooking effluent, often spilling at the back of the hood (although front spillage is observed in Figure 5). Dilution of the cook-

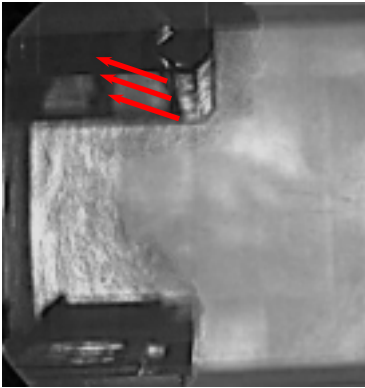

Figure 5. Schlieren image shows the thermal plume being displaced by short circuit supply causing hood to spill.

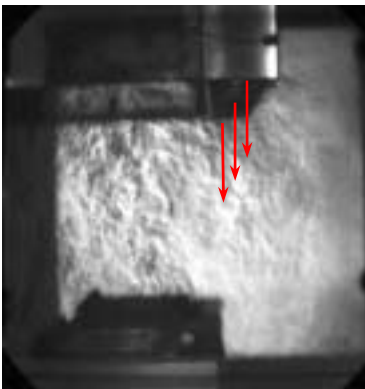

Figure 6. Schlieren image shows the thermal plume being pulled outside the hood by the air curtain.

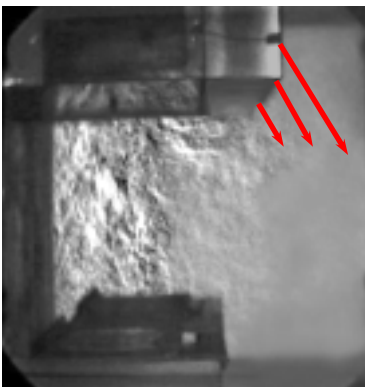

Figure 7. Schlieren image shows the thermal plume being pulled outside the hood by a poorly engineered front face supply.

ing effluent with the internal MUA makes it hard to visualize spillage (even using a schlieren system), but a degraded kitchen environment is confirmation that hood performance has been compromised. If the design exhaust rate is significantly higher than the threshold for C&C (i.e., includes a large safety factor), the percentage of short-circuit air can be increased accordingly, creating a condition of apparent benefit.

Short-circuit hoods are simply not recommended. This recommendation is endorsed by leading hood manufacturers, even though they may still include short-circuit hoods in their catalogue.

Air Curtain Supply

Introducing MUA through an air curtain is a risky design option and most hood manufacturers recommend limiting the percentage of MUA supplied through an air-curtain to less than 20% of the hood's exhaust flow. The negative impact of an air curtain is clearly illustrated in Figure 6 by the schlieren flow visualization recorded during a test of a wall-mounted canopy hood operating over two underfired broilers.

An air curtain (by itself, or in combination with another pathway) is not recommended, unless velocities are kept to a minimum and the designer has access to performance data on the actual air-curtain configuration being specified. It is too easy for the as-installed system to oversupply, creating higher discharge velocities that cause cooking effluent to spill into the kitchen.

Front Face Supply

Supplying air through the front face of the hood is a configuration that has been recommended by many hood manufacturers. However, a front face discharge, with louvers or perforated face, can perform poorly if its design does not consider discharge air velocity and direction. Not all face discharge systems share the same design; internal baffling and/or a double layer of perforated plates improve the uniformity of flow. Face discharge velocities should not exceed 150 fpm and should exit the front face in a horizontal direction. Greater distance between the lower capture edge of the hood and the bottom of the face discharge area may decrease the tendency of the MUA supply to interfere with hood capture and containment. Figure 7 represents a poorly designed face supply, which can negatively affect hood capture in the same fashion as an air-curtain or four-way diffuser.

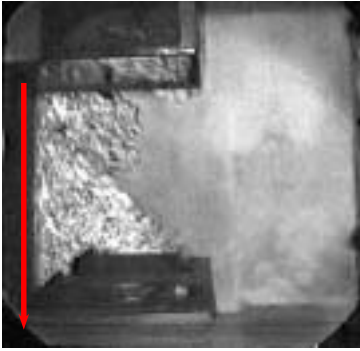

Figure 8. Schlieren image shows the thermal plume being pulled captured with backwall supply.

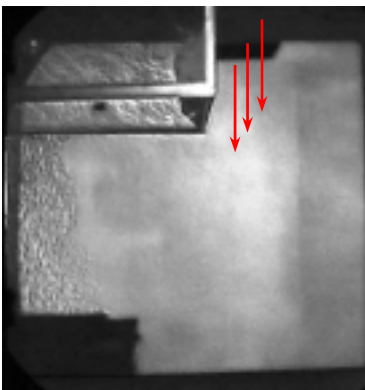

Figure 9. Schlieren image shows effective plume capture with MUA supplied through a 16-in wide perforated perimeter supply.

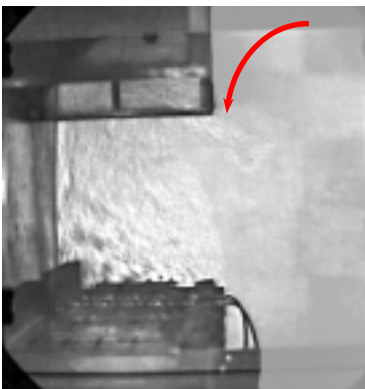

Figure 10. Schlieren image shows the thermal plume being pulled outside the hood by the air discharged from a 4-way diffuser.

Backwall Supply (Rear Discharge)

Lab testing has shown that the backwall supply can be an effective strategy for introducing MUA (see Figure 8). However, the discharge area of the backwall supply should be at least 12 inches below the cooking surfaces of the appliances to prevent the relative high velocity introduction of MUA from interfering with gas burners and pilot lights. As with other local MUA strategies, the quantity of air introduced through the backwall supply should be no more than 60% of the hood's exhaust flow. Hoods with a deeper plenum or increased diffuser area have lower discharge velocities, allowing higher supply airflows. The back supply plenum may offer the advantage of meeting a "clearance to combustibles" code requirement. It may also be an option to convert a single island canopy into a more functional wall-mounted canopy (without actually constructing the wall) as utility distribution can be incorporated within the plenum. If the rear supply utilizes perforated diffusers, it is important that cleanout access be provided (as with any supply diffuser).

Perforated Perimeter Supply

Perforated supply plenums (with perforated face diffuser) are similar to a front face supply, but the air is directed downward as in Figure 9 toward the hood capture area. This may be advantageous under some conditions, since the air is directed downward into the hood capture zone. Face discharge velocities should not exceed 150 fpm from any section of the diffuser and the distance to lower edge of the hood should be no less than 18 inches (or the system begins to act like an air curtain). Widening the plenum will lower the discharge velocity for a given flow of MUA and reduce the chance of the supply air affecting C&C. If the perforated supply plenum is extended along the sides of the hood as well as the front, the increased area will permit proportionally more MUA to be supplied.

Four-Way Ceiling Diffusers

Four-way diffusers located close to kitchen exhaust hoods (see Figure 10) can have a detrimental affect on hood performance, particularly when the flow through the diffuser approaches its design limit. Air from a diffuser within the vicinity of the hood should not be directed toward the hood. Discharge velocity at the diffuser face should be set at a design value such that the terminal velocity does not exceed 50 fpm at the edge of the hood capture area. It is recommended that only perforated plate ceiling diffusers be used in the vicinity of the hood, and to reduce air velocities from the diffusers at a given supply rate, the more diffusers the better!

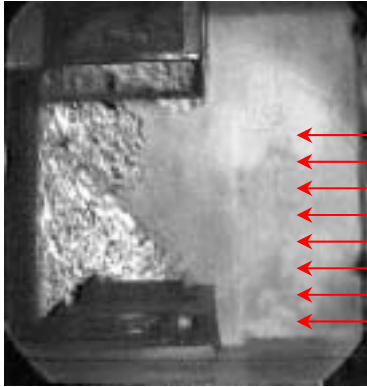

Figure 11. Schlieren image shows the plume being effectively captured when makeup air is supplied at low velocity from displacement diffusers.

Displacement Diffusers

Supplying makeup air through displacement diffusers at a good distance away from the hood as illustrated in Figure 11 is an effective strategy for introducing replacement air. It is analogous to low-velocity “transfer air” from the dining room. However, the diffusers require floor or wall space that is usually a premium in the commercial kitchen. A couple of remote displacement diffusers (built into a corner) could help diversify the introduction of makeup air into the kitchen when transfer air is not viable.

Influence of Other Factors on Hood Performance

Cross Drafts

Cross drafts have a detrimental affect on all hood/appliance combinations. Cross-drafts adversely affect island canopy hoods more than wall mounted canopy hoods. A fan in a kitchen, especially pointing at the cooking area, severely degrades hood performance and may make capture impossible. Cross drafts can also be developed when the makeup air system is not working correctly, causing air to be pulled from open drive-through or pass-through windows or doors.

Side Panels and Overhang

Side (or end) panels (as represented in Figure 12) permit a reduced exhaust rate in most cases, as they direct the replacement airflow to the front of the equipment. They are a relatively inexpensive way to improve capture and containment and reduce the total exhaust rate. In fact, one of the greatest benefits of end panels is to mitigate the negative effect of cross drafts. It is important to know that partial side panels can provide almost the same benefit as full panels. Although tending to defy its definition as an “island” canopy, end panels can improve the performance of a double-island or single-island canopy hood.

An increase in overhang should improve the ability of the hood to capture, although for unlisted hoods this may mean an increase in the code-required exhaust rate. Larger overhangs are recommended for appliances that create plume surges, such as convection and combination ovens, steamers and pressure fryers.

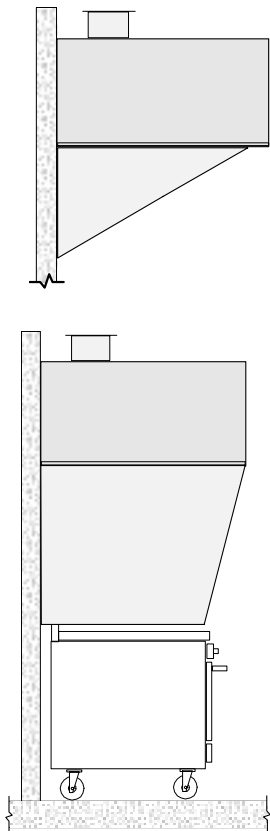

Figure 12. Illustration of partial and full side panels.

Safety Factor in Exhaust Rates

Diversity in appliance use, hood reservoir size, as well as the fact that maximum effluent generation from cooking only occurs randomly during normal kitchen operations, may mask the detrimental influence of local MUA sources on

hood performance. Consequently, spillage may be infrequent or simply unobserved. However, better MUA designs allow reduced exhaust rates and minimized energy costs while maintaining a margin of safety with respect to C&C.

Design Considerations for Energy Savings

Hood Style

Wall-mounted canopy hoods function effectively with a lower exhaust flow rate than the single-island hoods. Island canopy hoods are more sensitive to MUA supply and cross drafts than wall mounted canopy hoods. Engineered proximity hoods may exhibit the lowest capture and containment flow rates. In some cases, a proximity hood performs the same job as a wall-mounted canopy hood at one-third the exhaust rate.

Hood Geometry

Interior angles close to, or at, the capture edge of the hood improve C&C performance, allowing reduced exhaust by directing effluent back towards the filters. Hoods designed with these better geometric features require as much as 20% less exhaust rate compared to hoods identical in size and shape without these features. Capture and containment performance may also be enhanced with active “low-flow, high-velocity air jets” along the perimeter of the hood.

Variable Speed Fans and Idle Conditions

Appliances idle much of the day. Using two-speed or variable exhaust flow rates to allow reductions in exhaust (and makeup) while appliances are idling would minimize operating costs. NFPA 96 (Standard for Ventilation Control and Fire Protection of Commercial Cooking Operations) was recently amended to allow minimum exhaust duct velocity as low as 500 fpm (at the exhaust collar and ductwork). Typical design values of 1500 to 1800 fpm at the exhaust collar are still recommended for normal cooking conditions. This code change will facilitate the application of variable speed systems.

Energy Perspective

The exhaust ventilation system can be a major energy user in a commercial kitchen – but it doesn’t need to be in temperate climates like California. Mild climates, such as San Diego, may require no heating or cooling. Some facilities may cool replacement air to improve kitchen comfort. Combined heating and cooling

costs for MUA range from \$0.00 to \$0.60 per cfm in California climates, assuming 16 hours per day for 360 days per year. California climates are mild compared to other areas in North America so heating and mechanical cooling of MUA often is not necessary. Evaporative cooling can be very effective in desert climates.

Rule-of-thumb figures are useful, but how can designers calculate the costs based on a specific kitchen design and operation? The Outdoor Airload Calculator (OAC) software, freely available for download (www.archenergy.com/ckv/oac), is the best tool for quickly estimating the energy use for different CKV design and operating strategies. Figure 13 illustrates the OAC program interface and output.

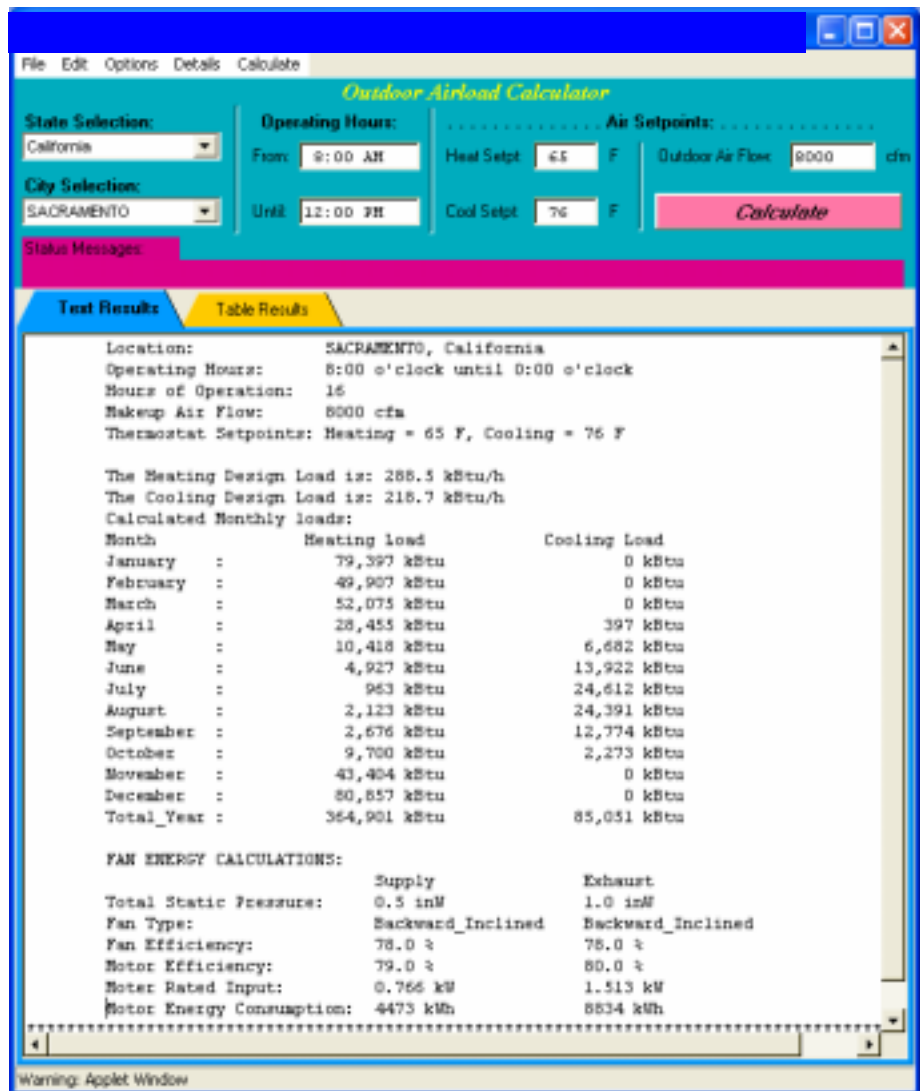

Figure 13. Sample output from Outdoor Airload Calculator screen.

Design Guide Summary

The strategy used to introduce replacement (makeup) air can significantly impact hood performance and should be a key factor in the design of kitchen ventilation systems. Makeup air introduced close to the hood's capture zone may create local air velocities and turbulence that result in periodic or sustained failures in thermal plume capture and containment. Furthermore, the more makeup air supplied (expressed as a percentage of the total replacement air requirement), the more dramatic the negative effect.

The following design suggestions can improve the energy efficiency and performance of commercial kitchen ventilation systems:

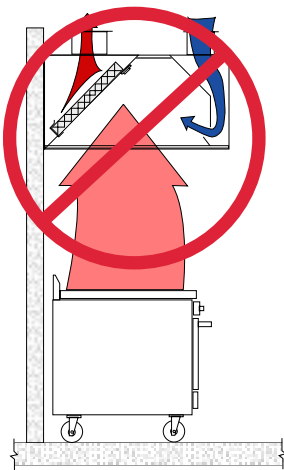

Figure 14. Don't use short circuit hoods.

- Group appliances according to effluent production and associated ventilation requirements. Specify different ventilation rates for hoods or hood sections over the different duty classification of appliances. Where practical, place heavy-duty appliances such as charbroilers in the center of a hood section, rather than at the end.
- Use UL Listed proximity type hoods where applicable.
- Hood construction details (such as interior angles and flanges along the edge) or high-velocity jets can promote capture and containment at lower exhaust rates.
- Install side and/or back panels on canopy hoods to increase effectiveness and reduce heat gain.
- Integrate the kitchen ventilation with the building HVAC system (i.e., use dining room outdoor air as makeup air for the hood).
- Maximize transfer air/minimize direct makeup air.
- Do not use short-circuit hoods (Figure 14). Use caution with air-curtain designs.
- Avoid 4-way or slot ceiling diffusers in the kitchen, especially near hoods.
- Diversify makeup air pathways (use combination of backwall supply, perforated perimeter supply, face supply, displacement diffusers, etc.).
- Minimize MUA velocity near the hood; it should be less than 75 fpm.
- Use direct-fired MUA heating if heating is necessary. In most temperate climates, including much of California, design for no MUA heating.
- Consider evaporative MUA cooling in dry climates such as California.
- Consider variable or 2-speed exhaust fan control for operations with high diversity of appliances and/or schedule of use.
- Provide air balance requirements to avoid over- or under-supply of MUA.
- Require building air balancing and system commissioning as part of the construction requirements.

Case Study: Wall-Mounted Canopy Hood

Challenge: Improve hood C&C and reduce ventilation energy

Off-the-Shelf Approach

An un-listed¹ wall mounted canopy hood (20-ft by 4-ft) without side panels: total exhaust 8,000 cfm. Four-way ceiling diffusers supplying air from the kitchen HVAC and MUA unit are located about 2 feet from front and sides of the hood.

Makeup Air Sources:

- 1000 cfm from dining and kitchen HVAC unit (25 Ton refrigeration capacity),
- 7000 cfm from independent MUA (heating only, ductstat set to 65°F) supplied through 4-way ceiling diffusers.

Annual CKV energy cost (including MUA conditioning and exhaust and MUA fan energy) estimated at \$6000 (\$0.75 per cfm) for Sacramento, CA location (using \$0.15/kWh and \$0.60 per therm).

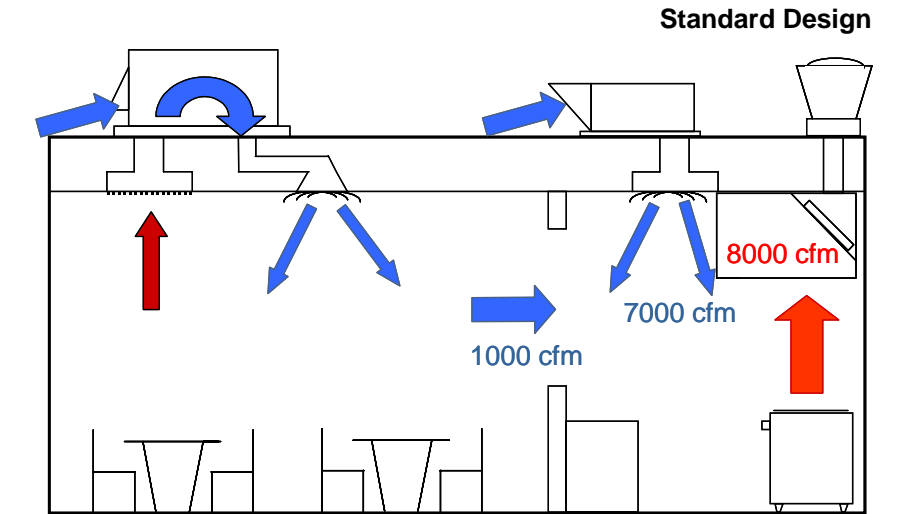

Engineered Approach

A "listed" hood (20-ft by 4.5-ft each) with partial side panels for a total exhaust of 6,000 cfm. Maximized use of transfer air. Perforated ceiling diffusers away from the hoods for the MUA supply.

Makeup Air Sources:

- 1500 cfm from kitchen HVAC unit (15 Ton, 7000 cfm total supply)
- 1500 cfm from dining HVAC unit (10 Ton, 5000 cfm total supply)
- 3000 cfm from independent MUA (no heating with evaporative cooling)

Annual CKV energy cost estimated at \$2000 (\$0.25 per cfm) for Sacramento, CA location, for a \$4000 saving over standard design.

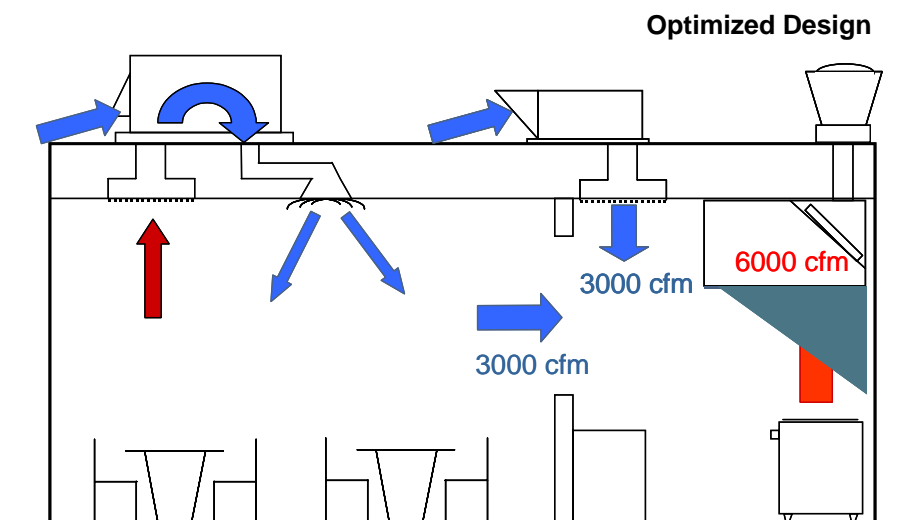

¹ Hoods designed to meet exhaust levels required by building codes, but not listed by a certified laboratory in accordance with a recognized test standard. For identical cooking equipment unlisted hoods typically require higher exhaust flows than listed hoods.

Notes and Acknowledgments

Funding

California Energy Commission
1516 Ninth Street, MS-29
Sacramento, CA 95814-5512
(916) 654-4287
www.energy.ca.gov/pier/buildings

Pacific Gas and Electric Company
P.O. Box 770000 MCN6G
San Francisco, CA 94177
(415) 973-0106
www.pge.com

Research Team

Architectural Energy Corporation
2540 Frontier Ave, Suite 201
Boulder, CO 80301
(800) 450-4454
www.archenergy.com

Fisher Nickel, inc.
12949 Alcosta Boulevard, Suite 101
San Ramon, CA 94583
(925) 838-7561
www.fishnick.com

Research Labs

Commercial Kitchen Ventilation Laboratory
955 North Lively Blvd.
Wood Dale, IL 60191
(630) 860-1439
www.archenergy.com/ckv

Food Service Technology Center
12949 Alcosta Boulevard, Suite 101
San Ramon, CA 94583
(925) 866-2864
www.pge.com/fstc



Legal Notice

This design guide was prepared as a result of work sponsored by the California Energy Commission. It does not necessarily represent the views of the Commission, its employees, or the State of California. The Commission, the State of California, its employees, contractors, and subcontractors make no warranty, express or implied, and assume no legal liability for the information in this report; nor does any party represent that the use of this information will not infringe upon privately owned rights. This guide has not been approved or disapproved by the Commission nor has the Commission passed upon the accuracy or adequacy of this information in this guide.

Architectural Energy Corporation, Boulder, CO, and Fisher-Nickel, inc., San Ramon, CA, prepared this design guide. The first edition of this design guide was included as an attachment in the Energy Commission report titled *Makeup Air Effects on the Performance of Kitchen Exhaust Systems* (publication P500-03-007F, December 2002). Updated editions of this design guide may be downloaded from www.fishnick.com or www.archenergy.com.

© 2002 by the California Energy Commission. Permission is granted to reproduce this document in its entirety provided that this copyright notice is included.