



PDHonline Course M330 (5 PDH)

Psychrometrics and Air Conditioning Processes

Instructor: A. Bhatia, B.E.

2020

PDH Online | PDH Center

5272 Meadow Estates Drive
Fairfax, VA 22030-6658
Phone: 703-988-0088
www.PDHonline.com

An Approved Continuing Education Provider

Psychrometrics and Air-Conditioning Processes

A. Bhatia, B.E.

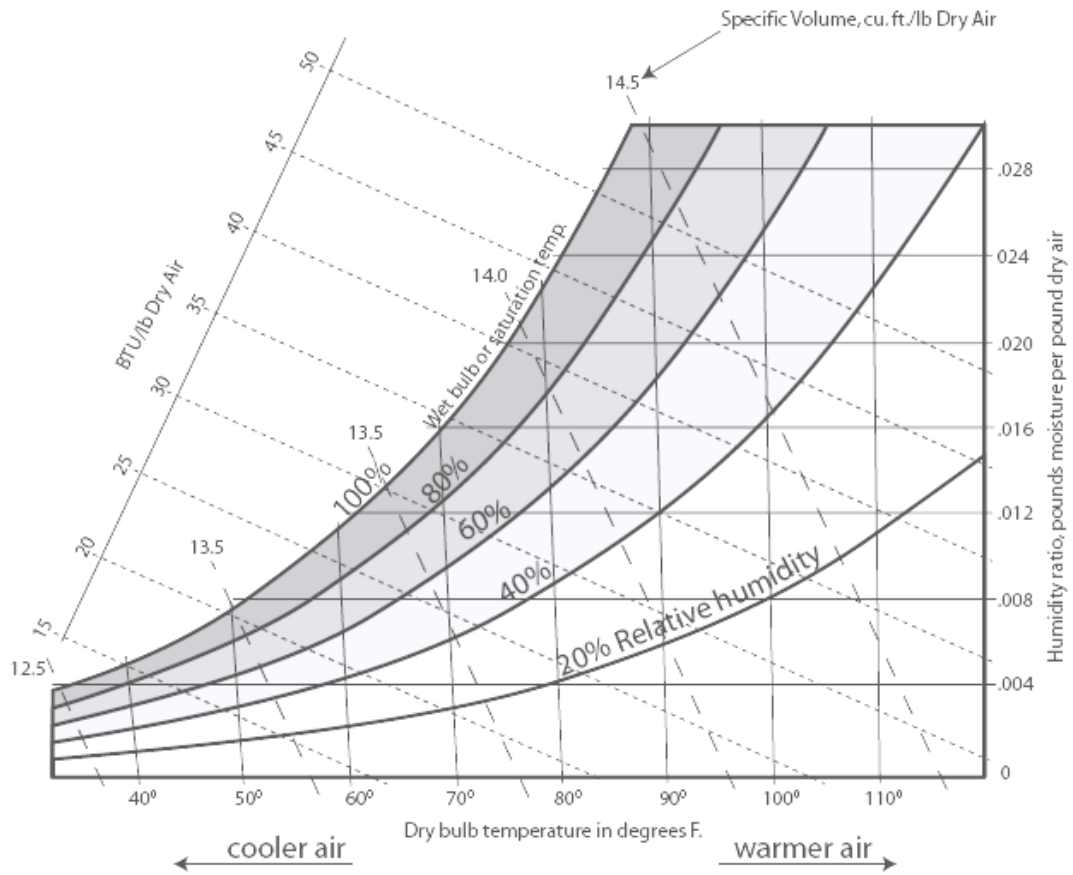

AIR CONDITIONING AND PSYCHROMETRICS

In air-conditioning system, the air must undergo one or several of the following processes:

- Cooling
 - Heating
- } Temperature Control
- Dehumidification
 - Humidification
- } Humidity Control

Psychrometrics can be used to predict changes in the environment when the amount of heat and/or moisture in the air changes. Use of psychrometric analysis is also important to determine the volume flow rates of air to be pushed into the ducting system and the sizing of the major system components.

Approaches to Temperature Control

Temperature control in an air conditioning system is achieved by passing the air through the cooling or heating coil, which may use any of the following approaches:

1. Vary the temperature of air supplied to the space while keeping the airflow rate constant. This is the basic constant volume, variable temperature approach.
2. Vary the airflow rate while keeping the temperature constant for air supplied to the space. This is the variable volume, constant temperature approach.
3. Vary the airflow rate and change the temperature for air supplied to the space. This is the variable volume and temperature approach.
4. Vary both the supply air temperature and flow rate where the airflow rate is varied down to a minimum value, then energy input to reheat the coil is controlled to vary the supply air temperature. This is the variable volume reheat approach.

Approaches to Humidity Control

Humidity control in a conditioned space is done by controlling the amount of water vapor present in the air in the space. When relative humidity at the desired temperature set-point is too high, dehumidification is required to reduce the amount of water vapor in the air for humidity control. Similarly, when relative humidity at the desired temperature set point is too low, humidification is required to increase the amount of water vapor in the air for humidity control.

Commonly used dehumidification methods include:

1. Surface dehumidification on cooling coils simultaneous with sensible cooling.
2. Direct dehumidification with desiccant-based dehumidifiers

Humidification is not always required in an HVAC system but, when required, it is provided by a humidifier. Commonly used humidification methods include:

1. Water spray humidifier
2. Steam pan humidifier

AIR CONDITIONING SYSTEM DESIGN

In designing air conditioning systems, the first challenge is to understand the components that affect the building heat gain or heat loss - this process is called heating or cooling load estimation. The reactive challenge is to "design" controlled processes to maintain the desired condition or state-point within the occupied space - these are usually called the system processes that use psychrometrics.

Estimating Cooling & Heating Load

Load estimates are the summation of heat transfer elements into (gains) or out of (losses) the spaces of a building. Each heat transfer element is called load components, which can be assembled into one of three basic groups, external space loads, internal space loads and system loads. To properly understand the workings of

the various external, internal and system load components, the following items need to be gathered from a set of plans, existing building surveys or occupant interviews:

- Building square-footage and volume
- Orientation of the building (sun effects on surfaces)
- Year round weather data (design conditions, heat transfer)
- Use of the spaces within the building (offices, conference room, lab, data center)
- Hours of operation (occupied and unoccupied)
- Thermostat set points (main comfort parameter)
- Dimensions of walls, roofs, windows and doors
- Construction materials (gather densities, external color and U-factors or describe material type layer by layer (R-values)
- Stairways and elevators (floor-to-floor openings)
- People occupancy and activity, and when they are present
- Lighting intensity and hours used
- Motor and appliance sizes or kW and times they are used
- Ventilation needs (IAQ and exhaust makeup)

The total cooling load is then determined in kW or tons* by the summation of all of the calculated heat gains. Along with psychrometrics, load estimating establishes the foundation upon which HVAC system design and operation occur.

*One ton is equivalent to heat extraction rate of 12000 Btu's/hr and 1 kW is equivalent to 3414 Btu's/hr.

Determine Design Supply Airflow Rate

HVAC engineers use psychrometrics to translate the knowledge of heating or cooling loads (which are in kW or tons) into volume flow rates (in m³/s or CFM) for the air to be circulated into the duct system. The volume flow rate is used to determine the size of fans, grills, outlets, air-handling units, and packaged units. This in turn affects the physical size (foot print) of air handling units and package units and is the single most important factor in conceptualizing the space requirements for mechanical rooms and also the air-distribution ducts.

The main function of the psychrometric analysis of an air-conditioning system is to determine the volume flow rates of air to be pushed into the ducting system and the sizing of the major system components. We will study this in detail but before that let's first refresh some elementary psychrometrics.

PSYCHROMETRICS

Psychrometrics is the science of studying the thermodynamic properties of moist air. The amount of moisture vapour in the air varies quite significantly under different conditions. When the air is hot, it can contain a large amount of moisture vapour, sometimes as much as 5% by volume. When it is cold, its capacity to hold the moisture is reduced. When the temperature of warm air begins to fall, the vapour also cools and, if cooling continues, it will condense into tiny moisture droplets. In the atmosphere this results in the formation of clouds and eventually rain.

Definitions of Air

Three basic definitions are used to describe air under various conditions:

1. **Atmospheric air** - contains nitrogen, oxygen, carbon dioxide, water vapor, other gases, and miscellaneous contaminants such as dust, pollen, and smoke. This is the air we breathe and use for ventilation.
2. **Dry air** - exists when all of the contaminants and water vapor have been removed from atmospheric air. By volume, dry air contains about 78 percent nitrogen, 21

percent oxygen, and 1 percent other gases. Dry air is used as the reference in psychrometrics.

3. **Moist air** - is a mixture of dry air and water vapor.

For practical purposes, moist air and atmospheric air can be considered equal under the range of conditions normally encountered.

Psychrometric Chart

The Psychrometric Chart provides a graphic relationship of the state or condition of the air at any particular time. It displays the properties of air: dry bulb temperature (vertical lines), wet bulb temperature (lines sloping gently downward to the right), dew point temperature (horizontal lines), and relative humidity (the curves on the chart). Given any two of these properties, the other two can be determined using the chart. The chart's usefulness lies beyond the mere representation of these elementary properties –it also describes the air's moisture content (far right scale), energy content (outer diagonal scale on upper left), specific volume (lines sloping sharply downward to the right), and more.

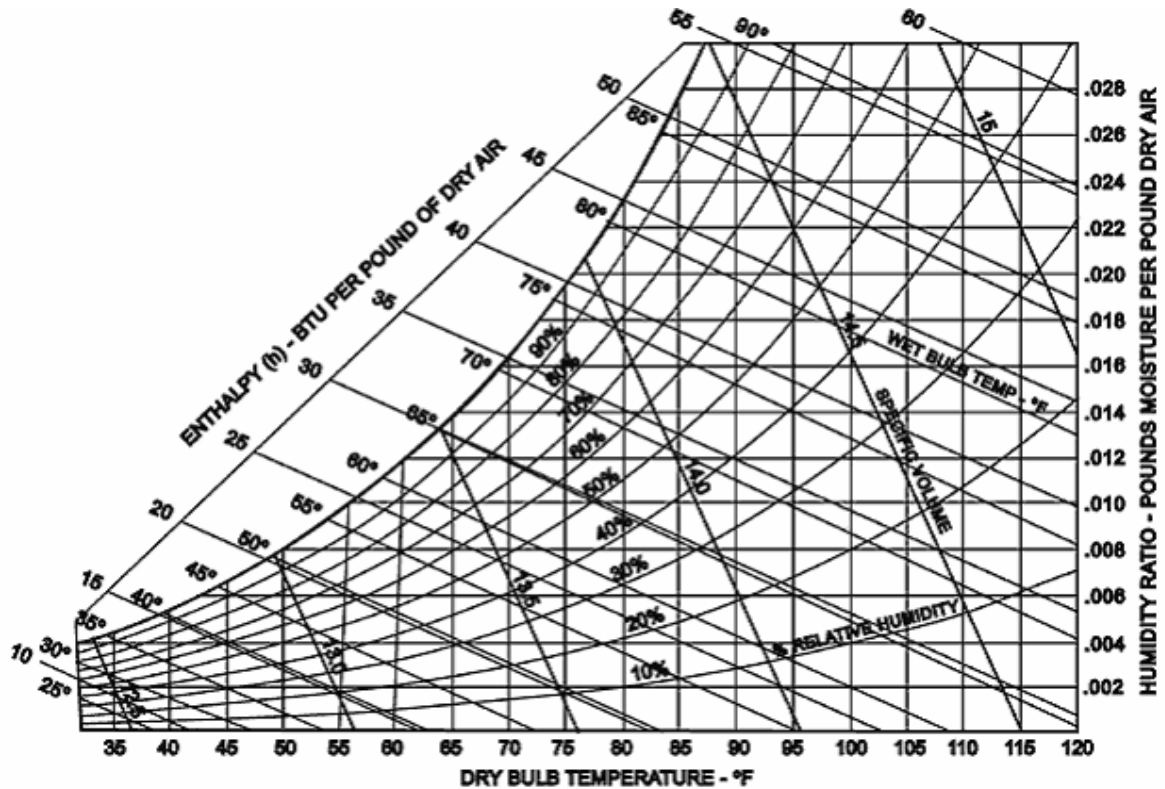

Uses of Psychrometric Chart

The psychrometric chart conveys an amazing amount of information about air. It provides an invaluable aid in illustrating and diagnosing environmental problems such as why heated air can hold more moisture, and conversely, how allowing moist air to cool will result in condensation. To predict whether or not moisture condensation will occur on a given surface you need three pieces of information; the temperature of the air, the relative humidity of the air, and the surface temperature. The psychrometric chart explains that by raising the surface temperature or by lowering the moisture content of the air or employ some combination of both can avoid surface condensation. A rule of thumb is that, a 10°F rise in air temperature can decrease relative humidity 20 percent. Use of a psychrometric chart will show that this is true.

A psychrometric chart also helps in calculating and analyzing the work and energy transfer of various air-conditioning processes. In practical applications, the most common psychrometric analysis made by HVAC contractors involves measuring the dry and wet bulb temperatures of air entering and leaving a cooling coil. If these temperatures are known along with the volumetric air flow rate (CFM) through the coil,

the cooling capacity of a unit can be verified. Using the dry and wet bulb temperature information, two points can be located on a psych chart and the corresponding enthalpy values read for them. The total BTUH cooling capacity can then be determined by multiplying 4.5 times the CFM value times the enthalpy difference of the two air state points [i.e. $4.5 * CFM * \Delta h$]. Contractors often have to perform this calculation to prove that their equipment is working satisfactorily.

READING PSYCHROMETRIC CHART

To the novice, a psychrometric chart seems a dizzying maze of lines and curves going every which way, but once a few fundamental things are understood about the psych chart, it is not really that difficult to understand. If we dissect the components piece by piece, the usefulness of the chart will be clearer.

Temperature: Dry Bulb

Dry Bulb Temperature (DBT) is the temperature that we measure with a standard thermometer that has no water on its surface. When people refer to the temperature of the air, they are commonly referring to its dry bulb temperature. Several temperature scales commonly are used in measuring the temperature. In the inch-pound (I-P) system of units, at standard atmosphere, the Fahrenheit scale has a water freezing point of 32°F and a boiling point of 212°F. In the International System (SI) of units, the Celsius scale has a water freezing point of 0°C and a boiling point of 100°C. On the Kelvin scale, 0°K equals -273°C.

Dry-bulb temperature is located on the X-axis, of the psychrometric chart and lines of constant temperature are represented by vertical chart lines.

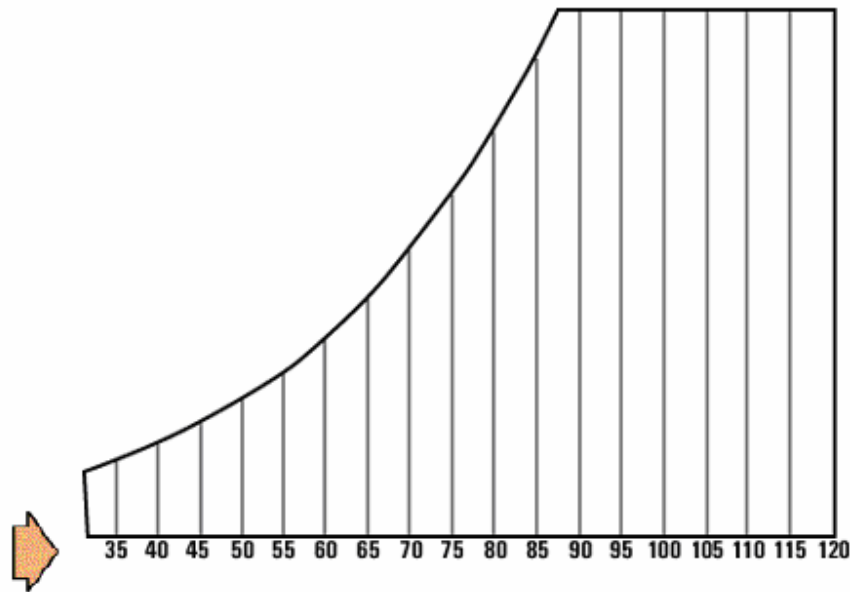

Dry bulb temperature lines shown on the Psychrometric Chart

Temperature: Wet Bulb

The wet bulb temperature (WBT) is a temperature associated with the moisture content of the air. Wet bulb temperature is taken by surrounding the thermometer with a wet wick and measuring the reading as the water evaporates. Because of the evaporative cooling effect, Wet bulb temperatures are always lower than dry bulb temperatures and the only time that they will be the same is at saturation (i.e. 100% relative humidity).

The wet bulb temperature (WBT) relates relative humidity to the dry bulb temperature. If the relative humidity is low and the temperature is high, moisture will evaporate very quickly so its cooling effect will be more significant than if the relative humidity was already high, in which case the evaporation rate would be much lower.

Wet bulb temperature on psychrometric chart is represented by lines that slant diagonally from the upper right of the chart (along the line of saturation) down to the lower left of the chart. These follows lines of constant enthalpy but values are read off at the upper, curved, saturation temperature boundary. The unit of measure used for wet bulb temperature is degrees Celsius ($^{\circ}\text{C}$) or degrees Farenheight ($^{\circ}\text{F}$).

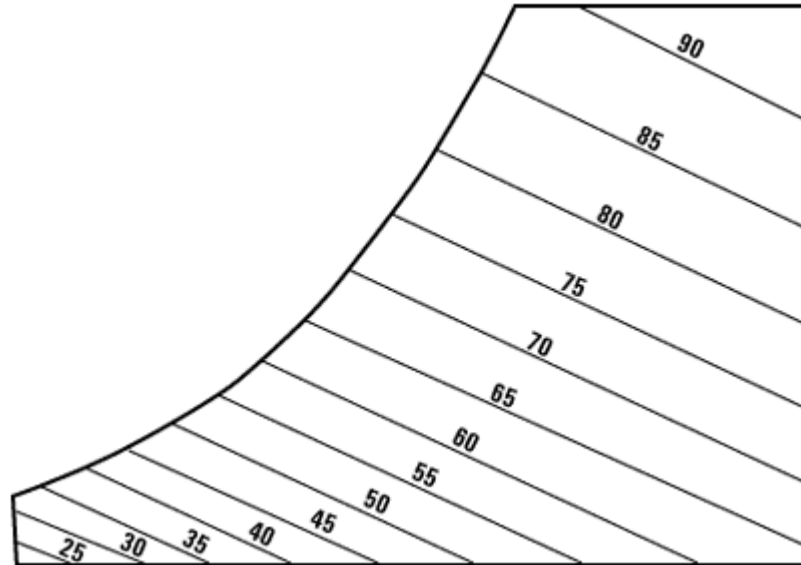

Lines of constant wet-bulb temperature on the Psychrometric Chart

Enthalpy

Enthalpy is the measure of heat energy in the air due to sensible heat or latent heat. Sensible heat is the heat (energy) in the air due to the temperature of the air and the latent heat is the heat (energy) in the air due to the moisture of the air. The sum of the latent energy and the sensible energy is called the air enthalpy. Enthalpy is expressed in Btu per pound of dry air (Btu/lb of dry air) or kilojoules per kilogram (kJ/kg).

Enthalpy is useful in air heating and cooling applications. Air with same amount of energy may either be dry hot air (high sensible heat) or cool moist air (high latent heat).

The enthalpy scale is located above the saturation, upper boundary of the chart. Lines of constant enthalpy run diagonally downward from left to right across the chart; follow almost exactly the line of constant wet bulb temperature.

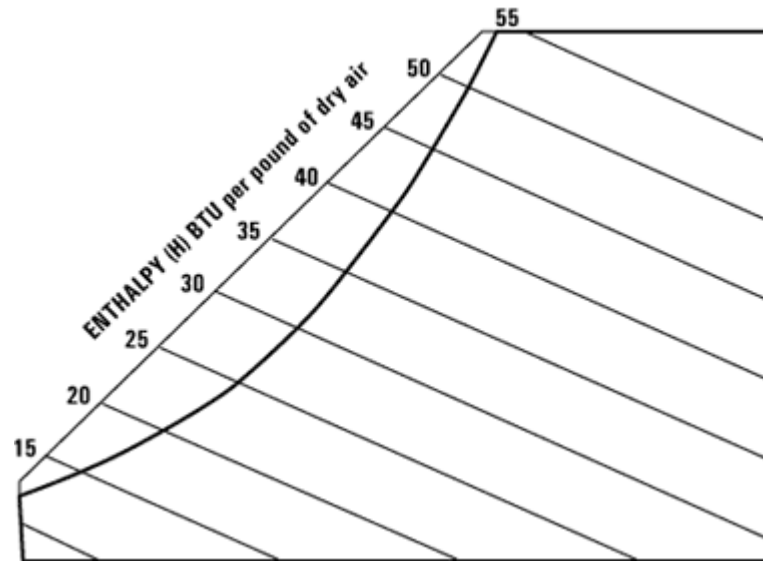

Enthalpy lines shown on Psychrometric Chart

Relative Humidity (RH)

Relative humidity (RH) is a measure of the amount of water air can hold at a certain temperature. *Air temperature (dry-bulb) is important because warmer air can hold more moisture than cold air.* As a rule of thumb, the maximum amount of water that the air can hold doubles for every 20°F increase in temperature.

Lines of constant relative humidity are represented by the curved lines running from the bottom left and sweeping up through to the top right of the chart. The line for 100 percent relative humidity, or saturation, is the upper, left boundary of the chart.

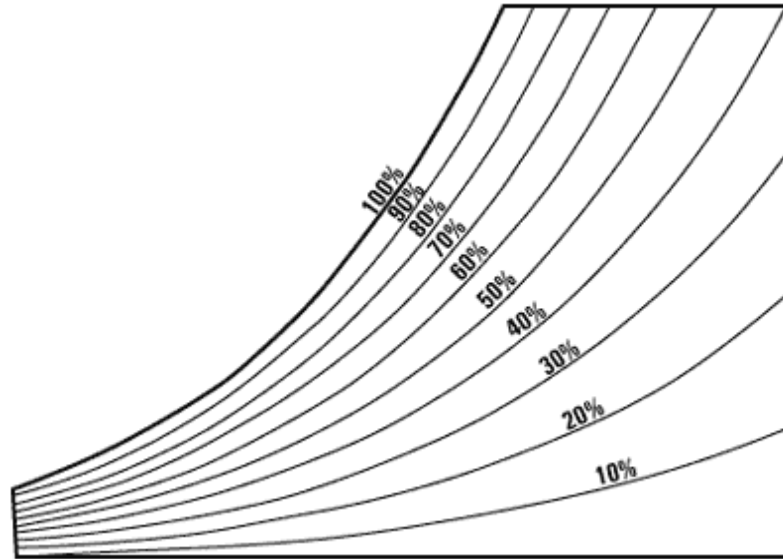

Relative humidity lines shown on Psychrometric Chart

The 100 % RH (saturation) line corresponds to the wet bulb and the dew-point temperature scale line and the line for zero percent RH falls along the dry-bulb temperature scale line

Note that air holds more water vapor at increasing temperatures. Air at 60 percent relative humidity contains 60 percent of the water it could possibly hold (at that temperature). It could pick up 40 percent more water to reach saturation. Because RH varies significantly with dry bulb temperature, it is important to state dry bulb temperature and relative humidity together, such as 70°F and 50% RH.

RH should not be confused with absolute humidity which is defined as the actual amount of moisture in the air and is measured in pounds of moisture per pound of dry air (lb/lb of d.a). Relative humidity (RH) is a measure of how much moisture is present compared to how much moisture the air could hold at that temperature. RH is expressed as a percent.

Absolute Humidity or Humidity Ratio

Absolute Humidity is the vapor content of air, given in grams or lb of water vapor per lb of dry air (i.e., lb of moisture/lb of d.a). It is also known as moisture content or humidity

ratio. Air at a given temperature can support only a certain amount of moisture and no more. This is referred to as the saturation humidity.

Humidity ratio is represented on the chart by lines that run horizontally and the values are on the right hand side (Y-axis) of the chart increasing from bottom to top.

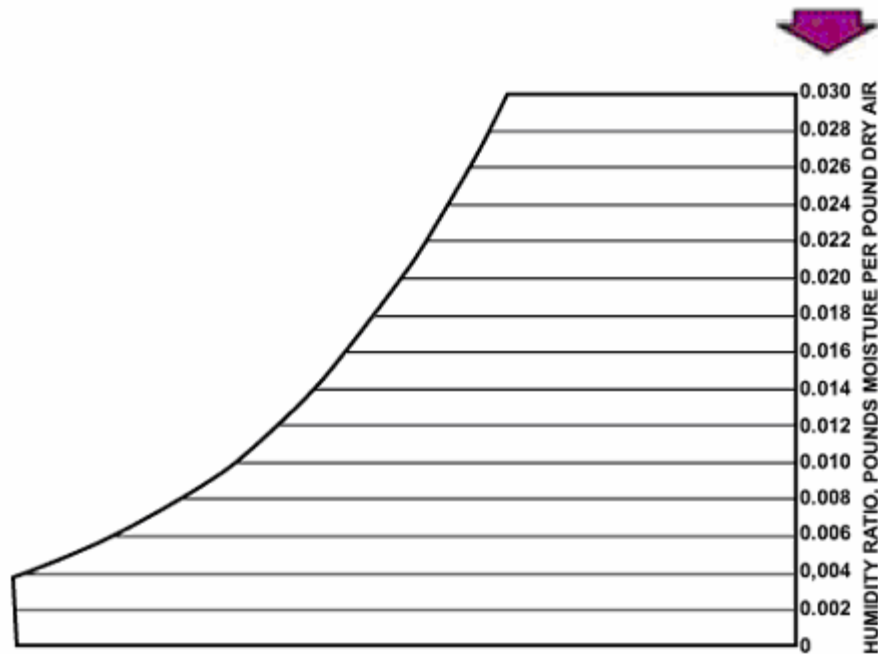

Humidity Ratio lines shown on Psychrometric Chart

Dew Point

Dew point temperature indicates the temperature at which water will begin to condense out of moist air. When air is cooled, the relative humidity increases until saturation is reached and condensation occurs. Condensation occurs on surfaces which are at or below the dew point temperature.

Dew point is represented along the 100% relative humidity line on the psychrometric chart. Dew point temperature is determined by moving from a state point horizontally to the left along lines of constant humidity ratio until the upper, curved, saturation temperature boundary is reached. At dew point, dry bulb temperature and wet bulb temperature are exactly the same.

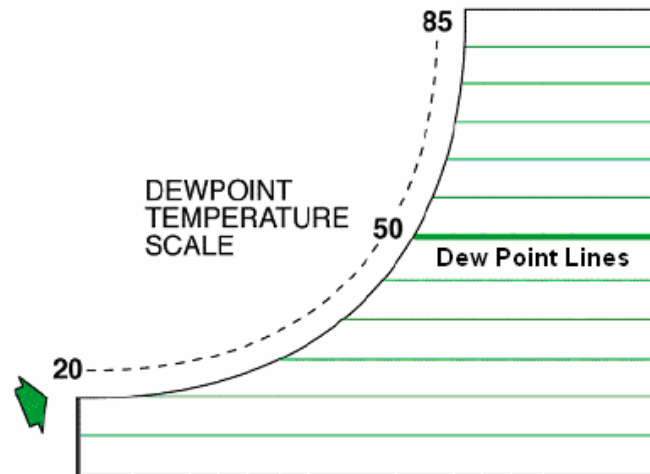

Dew Point lines shown on Psychrometric Chart

The dew point is closely related to the nighttime low temperature on still nights. When the air temperature drops to the dew point, energy is added back to the air as frost or dew forms and the temperature stabilizes at the dew point temperature. The dew point temperature is directly related to the actual quantity of moisture in the air and does not change much throughout a day unless a weather front moves through an area and adds or removes large amounts moisture. So the dew point temperature measured during daytime hours can be used as an estimate of the nighttime low temperature.

Specific Air Volume

Specific Volume is the volume that a certain weight of air occupies at a specific set of conditions. The specific volume of air is basically the reciprocal of air density. *As the temperature of the air increases, its density will decrease as its molecules vibrate more and take up more space (as per Boyle's law). Thus the specific volume will increase with increasing temperature.*

Since warm air is less dense than cool air which causes warmed air to rise. This phenomenon is known as thermal buoyancy. By similar reasoning, warmer air has greater specific volume and is hence lighter than cool air.

The specific volume of air is also affected by humidity levels and overall atmospheric pressure. The more the moisture vapour present in the air, the greater shall be the specific volume. With increased atmospheric pressure, the greater the density of the air - so the lower its specific volume. The unit of measure used for specific volume is cubic feet/lb of dry air.

Specific volume is represented on Psychrometric Chart by lines that slant from the lower right hand corner towards the upper left hand corner at a steeper angle than the lines of wet bulb temperature and enthalpy.

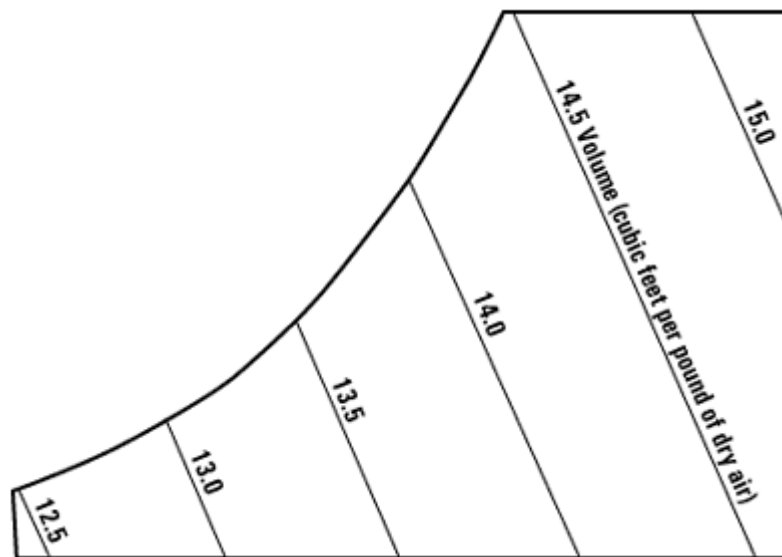

Specific Volume lines shown on Psychrometric Chart

Vapour Pressure

Water vapour is one of several gaseous constituents of air, the other principal ones being nitrogen, oxygen and carbon dioxide. Each exerts its own partial pressure on the surrounding environment in proportion to the amount of gas present, the sum of the pressures making up the total or barometric pressure of the air. When there is a difference in concentration of one of these gases between two points, there will be a corresponding difference in partial pressure. This will cause a flow of that particular gas from the point of higher concentration to the lower. When a partial pressure

difference exists between two sides of a material, the gas involved will diffuse through the material until the partial pressures of that gas are equalized.

The rate of diffusion will be determined by the partial pressure difference, the length of the flow path, and the permeability to the particular gas involved of the medium through which flow is taking place.

When water changes state from a liquid to a gas, as it does when it evaporates into the air, the water molecules in the vapour expand. Just as air pressure is directly related to the number of gas molecules per cubic meter of space, so vapour pressure results from the number of water vapour molecules per cubic meter. The greater the moisture vapour content of air, the greater the vapour pressure. Thus vapour pressure is linearly related to absolute humidity and is represented on Psychrometric Chart by lines that run horizontally and the values are on the far right hand side of the chart increasing from bottom to top. The unit of measure for vapour pressure is inches-w.g. or PASCAL.

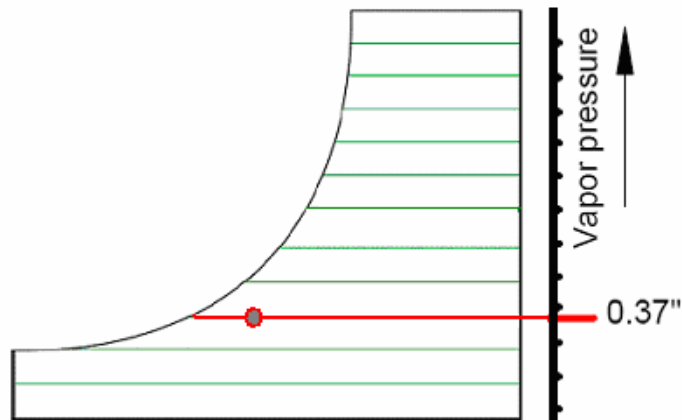

Vapour Pressure shown on Psychrometric Chart

Vapour pressure directly affects evaporation rate. If the vapour pressure in the air is already very high, it is more difficult for water molecules to break free from a liquid surface and enter the air as vapour. That is why there is very little evaporation in humid environments. The point at which absolutely no more evaporation will occur because the air is already saturated is called, interestingly enough, saturation pressure and coincides with the saturation point.

MEASURING PSYCHROMETRIC VARIABLES

All psychrometric properties of air are determined by measuring two psychrometric variables: for example, if wet- and dry-bulb temperatures are measured, then relative humidity, vapor pressure and dew point. Many variables can be measured to determine the psychrometric state of air, but dry-bulb temperature, wet-bulb temperature, dew point temperature, and relative humidity are most commonly measured.

Measuring Dry Bulb Temperature

Dry-bulb temperature can be simply measured by a mercury-in-glass thermometer, which is freely exposed to the air but is shielded from moisture and radiation heat sources. A thermometer can be made from any substance whose property changes predictably with temperature for instance the *volume of mercury increases* with increasing temperature. Beside mercury-in-glass, other liquids can also be used in this way. Other forms of volume-based thermometers use the differential expansion of metals in the form of a wound spring.

More recently, materials have been found whose electrical resistance change with temperature. These are usually manufactured from the oxides of transition metals such as manganese, cobalt, copper or nickel. They are called thermistors and are usually found in data-loggers and as computer-based sensors. *When the temperature increases, the resistance of the thermistor decreases.* Conversely, if the temperature decreases, the thermistor's resistance increases.

In a weather station, the temperature and relative humidity equipment is usually housed in a white box shelter called *Stevenson Screen*. It shields the instruments from sunshine and precipitations and has louvered sides to permit the free movement of air. Ideally the shelter is placed over grass, mounted at 1 meter above the ground and as far from any buildings as circumstances permit.

Measuring Wet Bulb Temperature

Wet bulb temperature is easily measured with a standard thermometer which has its sensing bulb encased in a wetted wick that is subjected to rapid air motion across its surface. Such devices, called sling or whirled psychrometers, have a frame that can be whirled in the air by hand. When the sling psychrometer whirls through the air, water from the wetted sack evaporates, causing it to cool to the wet-bulb temperature. The amount of cooling that occurs depends on the relative humidity. The lower the humidity, the faster will be the evaporation, and the more the bulb will cool. High humidity will cause less evaporation, slowing the cooling process.

An accurate wet-bulb temperature reading depends on 1) sensitivity and accuracy of the thermometer, 2) maintenance of an adequate air speed past the wick, 3) shielding of the thermometer from radiation, 4) use of distilled or de-ionized water to wet the wick, and 5) use of a cotton wick.

The thermometer sensitivity required to determine an accurate humidity varies according to the temperature range of the air. More sensitivity is needed at low than at high temperatures. For example, at 150°F a 1°F error in wet-bulb temperature reading results in a 2.6 percent error in relative humidity determination, but at 32°F that same error results in a 10.5 percent error in relative humidity.

The rate of evaporation from the wick is a function of air speed past it. A minimum air speed of about 500 feet per minute is required for accurate readings. An air speed much below this will result in an erroneously high wet-bulb reading. Wet-bulb devices that do not provide a guaranteed air flow cannot be relied on to give an accurate reading.

As with the dry-bulb thermometer, sources of radiant heat such as motors, lights, and so on can affect the wet-bulb thermometer. The reading must be taken in an area protected from these sources of radiation or thermometers must be shielded from radiant energy.

A buildup of salts from impure water or contaminants in the air affects the rate of water evaporation from the wick and results in erroneous data. Distilled or de-ionized water should be used to moisten the wick and the wick should be replaced if there is any sign of contamination. The wick material should not have been treated with chemicals such as sizing compounds that affect the water evaporation rate.

Special care must be taken when using a wet-bulb thermometer when the wet-bulb temperature is near freezing. Most humidity tables and calculators are based on a frozen wick at wet-bulb temperatures below 32°F. At temperatures below 32°F, touch the wick with a piece of clean ice or another cold object to induce freezing, because distilled water can be cooled below 32°F without freezing. The psychrometric chart or calculator must use frost-bulb, not wet-bulb temperatures, below 32°F to be accurate with this method.

Measuring Humidity

The instruments used to measure humidity are called hygrometers. The simplest form of hygrometer is called a psychrometer. It consists of two thermometers mounted on the same frame that can be whirled in the air by hand. This is described in detail in the wet bulb temperature measurement above.

The wet- and dry-bulb temperatures together determine the state point of the air on the psychrometric chart, allowing all other variables to be determined. In air that has less than 100 per cent relative humidity, the wet bulb will record a lower temperature than the dry bulb. This difference in temperature is known as wet-bulb depression. A special chart is used to convert the wet bulb depression to relative humidity.

The relationship between dry-bulb, wet-bulb and RH is tabulated below:

Dry Bulb (°F)	Wet Bulb (°F)	Relative Humidity (%)
68	67	95
68	66	90
68	63	76
68	58	55

68	48	17
----	----	----

Higher the differential between the dry bulb and wet bulb temperature, lower shall be the relative humidity. *A 10°F differential represents the Relative humidity of 55%.*

- *If the wet bulb temperature is lower than dry bulb the air-vapor mixture is un-saturated*
- *If the wet bulb temperature is the same as the dry bulb the air vapor is saturated*

Other humidity measurement devices include an electric sensing element or a mechanical system.

The mechanical hygrometer uses a single human hair as a sensing element. The hair is attached to a spring and a dial. When the relative humidity increases, the cells in the hair swell and contract, pulling the spring and the dial hand. At a lower relative humidity, the hair cells relax and it lengthens, releasing the tension on the spring and allowing the dial hand to move in the opposite direction. The response to changes in relative humidity is slow and is not dependable at very high relative humidity. These devices are acceptable as an indicator of a general range of humidity but are not suitable for accurate measurements.

A more accurate measurement is achieved with an electronic hygrometer. It measures the change in the electrical resistance of a thin layer of lithium chloride, or of a semiconductor device, as the relative humidity changes. Other hygrometers sense changes in weight, volume, or the transparency of various substances that respond to relative humidity.

Measuring Dew Point

Two types of dew point sensors are commonly used today: a condensation dew point method and a saturated salt system.

The condensation dew-point hygrometer is a polished metal mirror that is cooled until moisture just begins to condense onto it. This occurs when the surrounding air reaches its dew point. The temperature of the metal is then the same as the dew point

temperature. Knowing the atmospheric temperature and the dew-point temperature, the relative humidity can be determined by means of a table.

The saturated salt system operates at dew points between 10° to 100°F with an error of less than $\pm 2^\circ\text{F}$. The system costs less than the condensation system, is not significantly affected by contaminating ions, and has a response time of about 4 minutes. The condensation type is very accurate over a wide range of dew point temperatures (less than $\pm 1^\circ\text{F}$ from -100° to 212°F). A condensation dew point hygrometer can be expensive.

Measuring Vapour Pressure

Measuring vapour pressure is very difficult without complex laboratory instrumentation. However, it can be relatively easily derived from more measurable properties. The ratio between the weight of water vapour actually present in the air and the weight it can contain when saturated at the same temperature is called the relative humidity of the air. It is usually expressed as a percentage. As the vapour pressures are set by the quantities of vapour in the air, the relative humidity is also given by the ratio between the actual vapour pressure and the saturation vapour pressure at the same temperature. Thus, if the temperature and relative humidity are known, the actual vapour pressure can be calculated from the product of the relative humidity (expressed as a decimal) and the saturation pressure.

These saturation vapour pressures and the corresponding quantities of water in the air can be read directly off the psychrometric chart or from tables.

Example

An air-conditioned room at sea level has an indoor design temperature of 75°F and a relative humidity of 50%. Determine the humidity ratio, enthalpy, density, dew point, and thermodynamic wet bulb temperature of the indoor air at design condition.

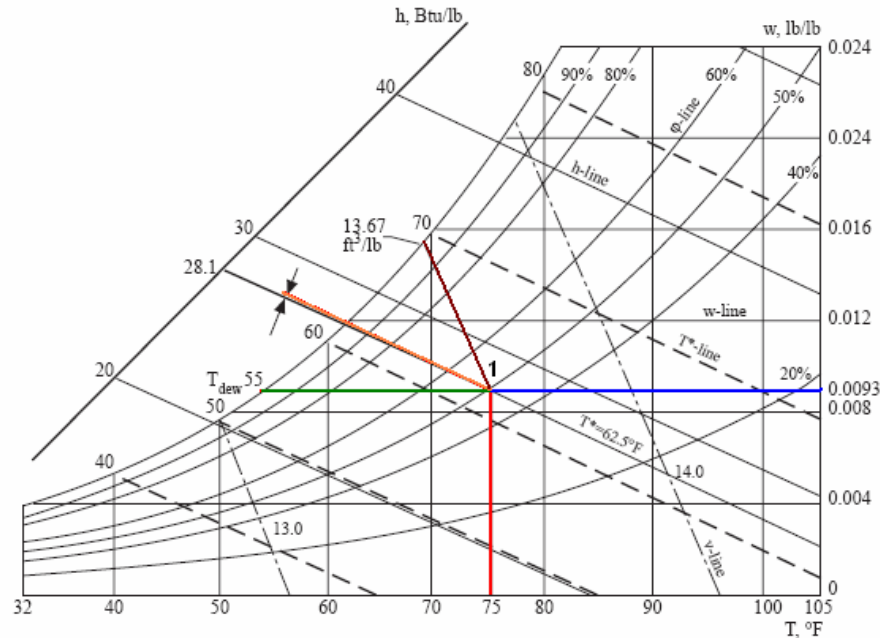

Solution

Since the air-conditioned room is at sea level, a psychrometric chart of standard atmospheric pressure of 14.697psi should be used to find the required properties.

1. Plot the state point of the room air at design condition on the psychrometric chart. First, find the room temperature 75°F on the horizontal temperature scale. Draw a line parallel to the 75°F temperature line. This line meets the relative humidity curve of 50% at point 1, which denotes the state point of room air (refer figure above).
2. Draw a horizontal line toward the humidity ratio scale from point 1. This line meets the ordinate and thus determines the room air humidity ratio $W = 0.0093$ lb/lb.
3. Draw a line from point 1 parallel to the enthalpy line. This line determines the enthalpy of room air on the enthalpy scale, $h_1 = 28.1$ Btu/lb.
4. Draw a line through point 1 parallel to the moist volume line. The perpendicular scale of this line indicates $v = 13.67$ ft³/lb.
5. Draw a horizontal line to the left from point 1. This line meets the saturation curve and determines the dew point temperature, $T_{dew} = 55^\circ\text{F}$.

6. Draw a line through point r parallel to the thermodynamic wet bulb line. The perpendicular scale to this line indicates that the thermodynamic wet bulb temperature $T^* = 62.5^\circ\text{F}$.

Example

A sling psychrometer gives a dry-bulb temperature of 78°F and a wet-bulb temperature of 65°F . Determine other moist air properties from this information.

Solution

Find the intersection of the two known properties, dry-bulb and wet-bulb temperatures, on the psychrometric chart.

The dry-bulb temperature is located along the bottom horizontal axis. Find the line for 78°F , which runs vertically through the chart.

Wet-bulb temperature is located along diagonal dotted lines leading to scale readings at the upper, curved boundary marked "saturation temperature".

The intersection of the vertical 78°F dry-bulb line and the diagonal 65°F wet-bulb line has now established a "state point" for the measured air. Now read relative humidity as 50 percent (curving line running from left to right up through the chart) and dew point temperature as 57.8°F (follow horizontal line, moving left, toward the curved upper boundary of saturation temperatures).

The humidity ratio for air in this example is about 0.0102 lb moisture/ lb dry air (move right horizontally from state point to humidity ratio scale).

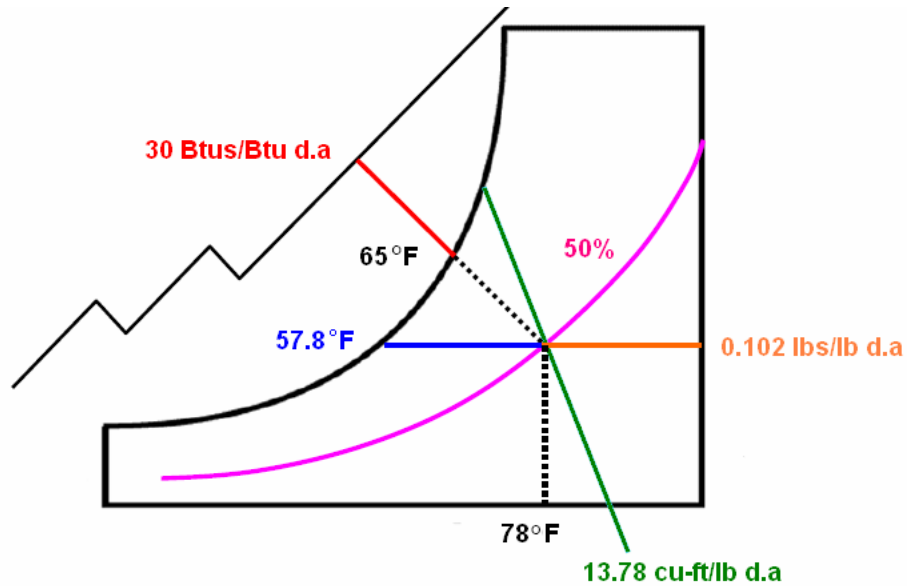
**Answer**

Relative humidity = 50%

Dew Point = 57.8 degrees

Absolute humidity = .0102 lbs water / lb dry air

Specific volume = 13.78 cu-ft/lb dry air

Enthalpy = 30 Btu's/lbs dry air

Example

The dry bulb reading is 78°F and the wet bulb is 58°F. Using the chart determine the following values.

Answer

Relative humidity = 28%

Dew Point = 42 degrees

Absolute humidity = .0056 lbs water / lb dry air

Specific volume = 13.65 cu-ft/lb dry air

Enthalpy = 25 Btu's/lbs dry air

Example

The dry bulb reading is 70°F and the wet bulb is 54°F. Using the chart determine the following values.

Answer

Relative humidity = 33%

Dew Point = 40 degrees

Absolute humidity = .0050 lbs water / lb dry air

Specific volume = 13.45 cu-ft/lb dry air

Enthalpy = 22.5 Btu's/lbs dry air

Example

The dry bulb reading is 85°F and the wet bulb is 60F. Using the chart determine the following values.

Answer

Relative humidity = 22%

Dew Point = 41 degrees

Absolute humidity = .0055 lbs water / lb dry air

Specific volume = 13.85 cu-ft/lb dry air

Enthalpy = 26.5 Btu's/lbs dry air

PSYCHROMETRIC PROCESSES

A thermodynamic system is said to undergo a process whenever it changes from one state-point to another. In psychrometric analysis this change in state can be caused by adding or removing heat, causing work to be performed on or by the fluid, adding or removing mass (usually of water vapor), or mixing two fluids which are at dissimilar states.

At any specific time, the condition of the air can be represented as a single point somewhere within the chart. If conditions change, then the point will move around the graph. The direction the point moves depends upon what properties of the air are changing.

Most processes encountered in air conditioning practice are one of, a combination of or a sequence of the following:

Cooling And Heating

In HVAC systems, air is typically cooled by passing it over a cooling coil. Most cooling coils are finned-tube heat exchangers in which cool water or refrigerant flows through tubes, and the tubes have external fins to increase heat transfer area. If the air is cooled below the dewpoint temperature, water will condense and must be drained from the bottom of the cooling coil. A schematic of a cooling coil is shown below.

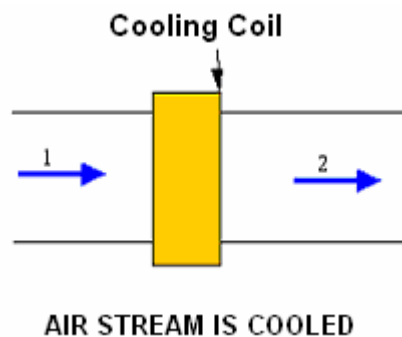

Sensible Cooling

Air dew point temperature T_{dewpoint} is the temperature when air is 100% saturated and water begins to condense out of the air. When warm wet air is cooled as it passes over a cooling coil, the temperature begins to decrease. If the air leaves the coil at a temperature above its dew point temperature, then no condensation occurs. On a psychrometric chart,

the exiting air is at a lower temperature than the incoming air while the humidity ratio remains constant since no moisture is condensed from the air. Reducing the temperature of air without changing the quantity of water in the air is called sensible cooling, and is shown schematically below.

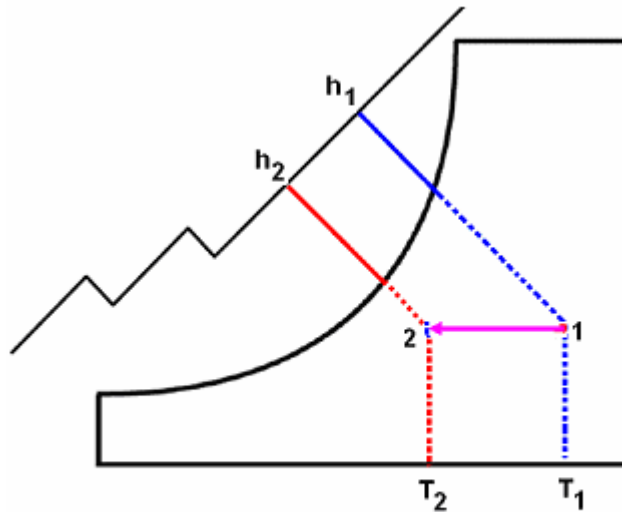

Sensible Cooling

Since the humidity ratio remains unchanged, and so we use a horizontal line on the psychrometric chart to represent this process. This provides no control over the relative humidity and may produce conditions that are uncomfortable. The relative humidity increases with sensible cooling.

Sensible Heating

In HVAC systems, air is typically heated by passing it over a heating coil or use of electrical strip heaters. A schematic of a cooling coil is shown below.

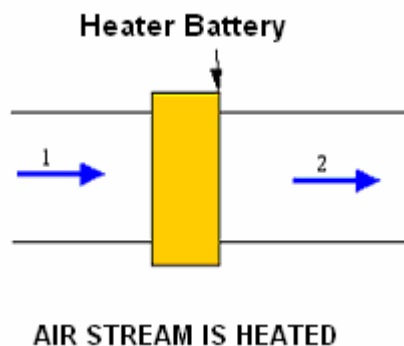

The process of sensible heating is represented on the psychrometric chart by straight horizontal lines parallel to the abscissa.

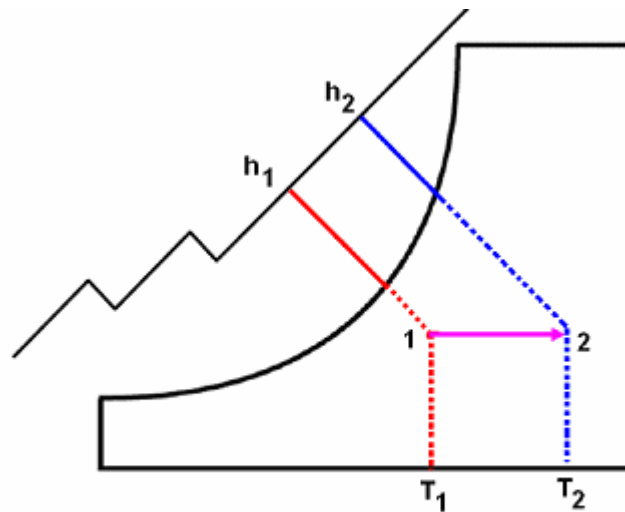

Sensible Heating

Since the humidity ratio remains unchanged, and so we use a horizontal line on the psychrometric chart to represent this process. Heating will result in lower relative humidity.

Typical sensible cooling or heating processes include space heating loads, sensible cooling loads, heating coils, space heating devices, fans that move the air, sensible cooling coils and radiant cooling or heating devices.

Observable features of a sensible heating process

- The dry bulb temperature increases
- the relative humidity decreases
- the enthalpy increases
- the wet bulb temperature increases
- the specific volume increases
- the humidity ratio, vapor pressure and dew point remains constant

Observable features of a sensible cooling process

- the dry bulb temperature decreases
- the relative humidity increases
- the enthalpy decreases
- the wet bulb temperature decreases
- the specific volume decreases
- the humidity ratio, vapor pressure and dew point remains constant

Heating and cooling **do** change the relative humidity. This is because the saturation point changes with dry bulb temperature. As relative humidity equals the absolute humidity divided by the saturation point, if the temperature and the saturation points change but the absolute humidity remains the same, then the relative humidity must change.

Governing Equation for Sensible Heating and Cooling

$$1) Q_s = M_a \cdot (h_2 - h_1) \text{ and}$$

$$2) q_s = m_a \cdot (h_2 - h_1)$$

Where:

- Q_s = sensible heat added, Btu
- M_a = Mass of dry air, lb [= (volume of air)/(specific volume of moist air in ft³/lb d.a)]
- h = Enthalpy of air, Btu/lb of dry air
- q_s = Rate of sensible heat transfer, Btu/min
- m_a = Mass airflow, lb/min [= (volume of moist airflow per min)/(specific volume of moist air in ft³/lb d.a)]

Example:

Calculate the amount of sensible heat that must be added to 100lb of air at 85°F dry bulb and 75°F wet bulb to raise the temperature of air to 100°F dry bulb.

Solution

- a) Locate the 85°F dry bulb and 75°F wet bulb – this corresponds to 62% Relative humidity.
- b) Move from point established in a) above to right to 100°F on a horizontal dry bulb temperature scale – this corresponds to 39.6% Relative humidity.

The condition of the air is changing from state 1 to state 2

- c) Read h_2 and h_1
 - $h_2 = 39$ Btu's/lb dry air
 - $h_1 = 43.5$ Btu's/lb dry air
- d) Estimate heat addition : $Q = m [h_2 - h_1]$
 - $Q = 10 \times [43.5 - 39]$
 - $Q = 10 \times 4.5$
 - $Q = 450$ Btu's

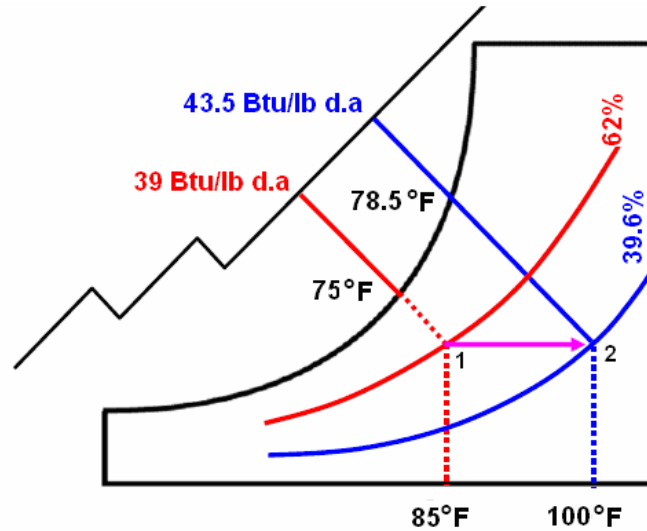
**Example:**

Determine the amount of sensible heat needed to increase the temperature of air from 50°F and 50% RH to 90°F.

Solution:

Enthalpy (50°F, 50% RH) = 16 Btu/lb (HR = 0.0038 lb/lb d.a)

Enthalpy (90°F, same HR) = 26 Btu/lb

Heat added = 26 - 16 = 10 Btu/lb

Example

Determine the cooling required to sensibly cool 20,000 cfm of air from a temperature of 90 F and a relative humidity of 60% to a temperature of 75 F.

Solution

From Psychrometric Chart

$$T = 90^{\circ}F \quad \phi = 60\% \quad h_1 = 41.6 \left[\frac{Btu}{lba} \right] \quad v_1 = 14.26 \left[\frac{ft^3}{lba} \right] \quad w_1 = .0183 \left[\frac{lbw}{lba} \right]$$

$$T = 75^{\circ}F \quad w_1 = w_2 \quad h_2 = 37.9 \left[\frac{Btu}{lba} \right]$$

M-balance:

$$\dot{m}_{a1} = \dot{m}_{a2} \quad \text{and} \quad \dot{m}_{a1} = \frac{\dot{V}_1}{v_1} \quad (\text{Note } \dot{V}_1 \neq \dot{V}_2 \text{ because } v_1 = v_2)$$

E-balance:

$$\dot{m}_{a1}h_1 - \dot{Q}_c - \dot{m}_{a2}h_2 = 0 \quad (SS)$$

$$\begin{aligned} \dot{Q}_c &= \dot{m}_{a1}(h_1 - h_2) = \frac{\dot{V}_1}{v_1}(h_1 - h_2) = 20,000 \left[\frac{ft^3}{min} \right] \times 60 \left[\frac{min}{hr} \right] \times \frac{1}{14.26} \left[\frac{lba}{ft^3} \right] \times (41.6 - 37.9) \left[\frac{Btu}{lba} \right] \\ &= 311,360 \left[\frac{Btu}{hr} \right] \end{aligned}$$

Humidification (Heating or Cooling)

This is the process of introducing moisture into the airstream. In winter, humidification frequently is required because the cold outside air, infiltrating into a heated space or intentionally brought in to satisfy the space ventilation requirement, is too dry. In summer, humidification is usually done as part of an evaporative cooling system. Humidification is achieved in various ways that range from using spray washers to passing the air over a pool of water to injecting steam.

Heating and Humidifying is the process of simultaneously increasing both the dry-bulb temperature and humidity ratio of the air. The total heat gained (Q or q) in going from the initial to the final condition can be broken into sensible and latent heat portions. To separate the total enthalpy into sensible and latent heat, consider a horizontal movement on the chart as sensible heat and a vertical movement as latent heat. The humidity ratio is constant for the horizontal movement (sensible) and the dry-bulb temperature is constant for the vertical movement (latent).

On psychrometric chart, this process is shown as a line sloping upward and to the right. The heating and humidification of the air is best considered by looking at the two processes sequentially. The first, from state 1 to state 0, is the sensible heating that

occurs when the air passes through the heat exchanger. The second, from state 0 to state 2, is the humidification process.

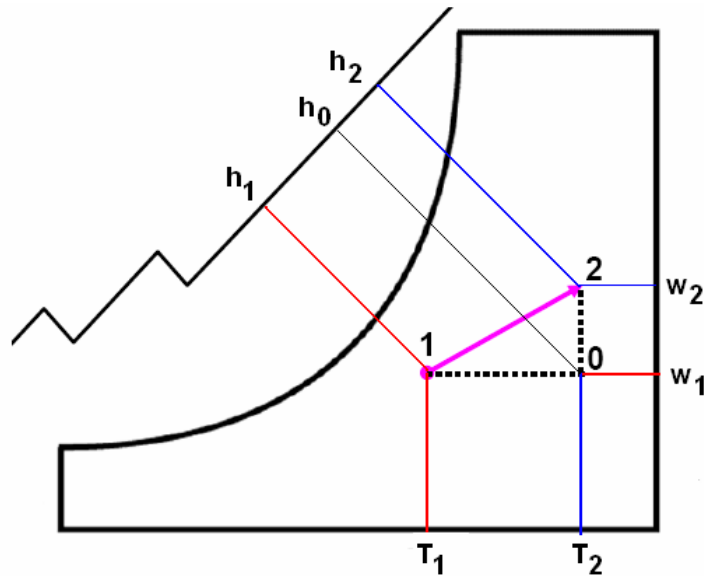

Governing Equation for Heating and Humidification

If the condition of the air is changing from state 1 to state 2, consider that the intersection of a horizontal line through state 1 and a vertical line through state 2 occurs at state 0. Then the change in heat can be expressed as:

$$1) Q_s = M_a \cdot (h_0 - h_1) \text{ and } q_s = m_a \cdot (h_0 - h_1) \text{ -----Eq- 1}$$

$$2) Q_L = M_a \cdot (h_2 - h_0) \text{ and } q_s = m_a \cdot (h_2 - h_0) \text{ -----Eq- 2}$$

Where:

- Q_s = sensible heat added, Btu
- Q_L = latent heat added, Btu
- M_a = Mass of dry air, lb [= (volume of air)/(specific volume of moist air in ft³/lb d.a)]
- h = Enthalpy of air, Btu/lb of dry air
- q_s = Rate of sensible heat transfer, Btu/min

- m_a = Mass airflow, lb/min [= (volume of moist airflow per min)/(specific volume of moist air in ft³/lb d.a)]

The rate of moisture addition to the air, M_{water} , is determined by a water vapor mass balance:

$$3) M_{\text{water}} = Ma (w_2 - w_0) \text{ or } mw = ma (w_2 - w_0) \text{ -----Eq-3}$$

Where:

- w_2 = humidity ratio of the moist air upstream of the humidifier
- w_0 = humidity ratio of the moist air downstream of the humidifier

Example:

Ninety cubic-ft of lumber is dried at 60°C (140°F) dry bulb temperature and 52°C (125.6°F) wet bulb temperature. The drying rate of the lumber is 5.68 lb of water per hour. If outside air is at 27°C (80.6°F) dry bulb temperature and 80% relative humidity, how much outside air is needed per minute to carry away the evaporated moisture?

Solution

- Locate the 80.6°F dry bulb and 80% Relative humidity as Node 1.
- Locate the 140°F dry bulb and 125.6 °F wet bulb temperature as Node 2.
- Move from point established in a) above to right to 100°F on a horizontal dry bulb temperature scale – this corresponds to 39.6% Relative humidity.

The condition of the air is changing from state 1 to state 2

- Read absolute humidity w_2 and w_1
 - $w_2 = 0.092$ lb/lb dry air
 - $w_1 = 0.0185$ lb/lb dry air
- Estimate moisture gain : $\Delta HR = [w_2 - w_1]$ lb/lb dry air

- $\Delta HR = (0.092 - 0.0185) \text{ lb/lb dry air}$
 - $\Delta HR = 0.0735 \text{ lb/lb dry air}$
- f) Estimate drying air: $w = \text{drying rate}/\Delta HR$
- $w = (5.68 \text{ lb/hour}) / (0.0735 \text{ lb/lb dry air}) = 0.417 \text{ lb dry air/hour}$
- g) Estimate volumetric air flow rate for drying: $V = w \times \text{specific volume}$
- $V = (0.417 \text{ kg dry air/hour}) (13.95 \text{ ft}^3/\text{lb dry air}) = 5.817 \text{ ft}^3/\text{hour}$

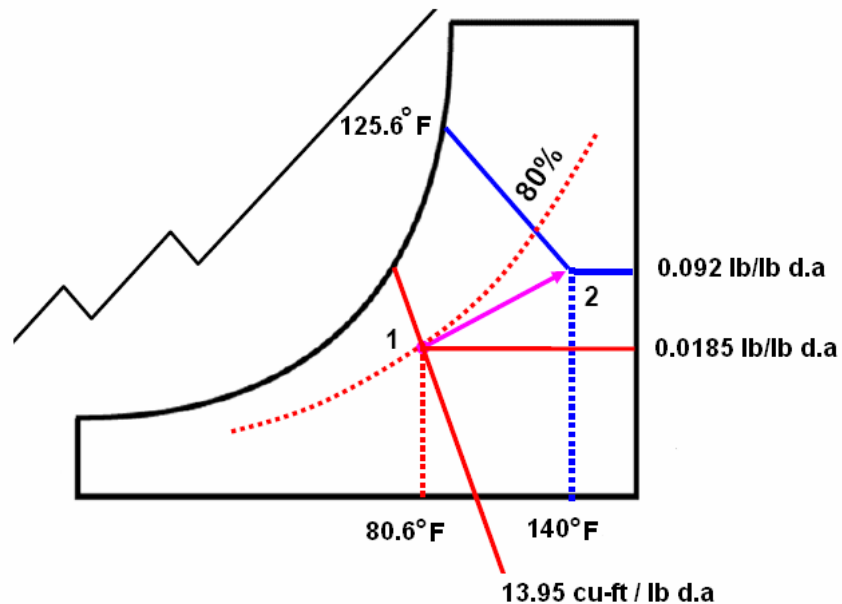
**Example:**

How much moisture is added to 20 lb of air going from 50°F, 50% RH to 80°F, 60% RH?

Solution:

HR (50 F, 50% RH) = 0.0038 lb/lb d.a

HR (80 F, 60% RH) = 0.0132 lb/lb d.a

Water added = 20 lb * (0.0132 - 0.0038) lb/lb = 0.188 lb-m

Observable features of a humidification process are:

1. Humidification adds moisture to the air which increase the absolute humidity
2. Water is added in vapor form
3. Water is converted from liquid to gas
4. There is an increase in the energy level

Cooling and Dehumidifying

When air is cooled below the dew point temperature, T_{dewpoint} , condensation occurs and moisture is removed from the air stream. The exiting air stream is at a lower temperature and humidity ratio than the incoming air stream. The cooling to condense water from the air is called latent cooling or dehumidification. Thus, this process includes both sensible and latent cooling. The total cooling is the sum of the latent and sensible cooling. The process is shown schematically below.

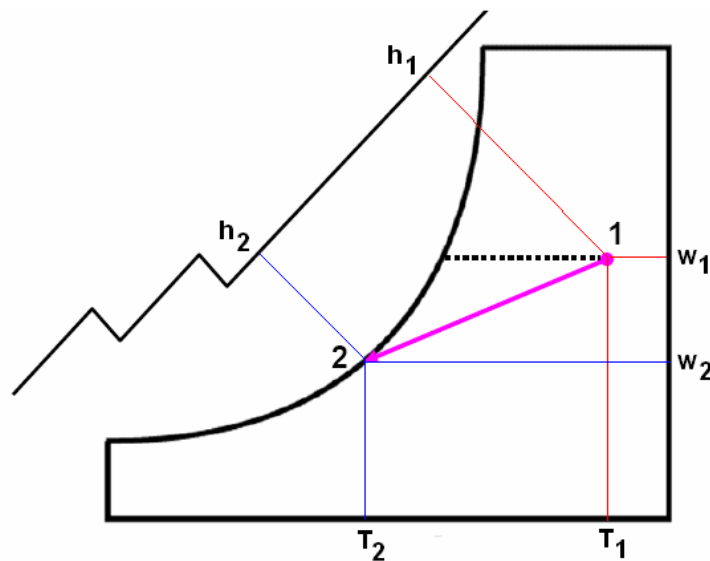

On psychrometric chart, this process is represented as line sloping downward and to the left. This process is assumed to occur as simple cooling first and then

condensation. While the moisture is condensing the air is assumed to remain saturated.

This process is used in air-conditioning systems operating in hot, humid climates. It is accomplished by using a cooling coil with a surface temperature below the dew-point temperature of water vapor in air. Typical cooling coils in air conditioning systems operate at approximately 40° - 50°F, below the dew-point temperature of typical indoor air conditions. The calculations are identical to those for heating and humidifying the only difference being that the initial state (state 1) is the warmer more humid state. As before, the total heat change (Q or q) in going from the initial to the final condition can be broken into a sensible and latent heat portion.

This process is used in air-conditioning systems operating in hot, humid climates. Typical cooling and dehumidifying process include chilled water and refrigerant cooling coils which condition re-circulated room air or mixtures of re-circulated air and outdoor air which is introduced for ventilation. The cooling coil shall have a surface temperature below the dew-point temperature of water vapor in air for effective condensation.

Observable characteristics of a cooling and dehumidifying process are:

1. dry bulb temperature decreases
2. humidity ratio decreases
3. vapor pressure decreases
4. dew point temperature decreases
5. wet bulb temperature decreases
6. enthalpy decreases (there is a decrease in the energy level and with the loss of energy, condensation occurs)
7. relative humidity increases

Governing Equations:

The combined process of cooling and dehumidification can be modeled using mass balances on the air and water, and an energy balance on the entire process. The steady state mass and energy balances are shown below.

Mass balance (air): $\dot{m}_{a1} = \dot{m}_{a2}$

Mass balance (water): $\dot{m}_{w1} = \dot{m}_{w2} + \dot{m}_w$
 $\dot{m}_w = \dot{m}_{w1} - \dot{m}_{w2} = \dot{m}_{a1}w_1 + \dot{m}_{a2}w_2 = \dot{m}_a(w_1 - w_2)$

Energy balance: $\dot{m}_a h_1 - \dot{Q}_c - \dot{m}_a h_2 - \dot{m}_w h_w = 0$ (SS)
 $\dot{Q}_c = \dot{m}_a(h_1 - h_2) - \dot{m}_w h_w$

Example

Consider a hot humid day 90°F and 90% RH. We want to condition the air to 70°F at about 50% RH. We do this by chilling the air far enough to condense out enough moisture to dehumidify it: the goal is to have air with absolute humidity not exceeding 0.008 lbs of moisture per pound of air (~50 to 55 grains per pound of dry air). Show the processes on the psychrometric chart.

Solution

Plot 90° and 90% RH on the chart

Read the absolute humidity at this point to 0.029 lbs moisture per lb of dry air or (195 grains of moisture per pound of air)

Check the final condition of 0.008 lbs moisture per lb of dry air and run the horizontal line to saturation curve. Read the temperature as 50°F

Cool the air from 90°F @ 90% RH to 50°F – Now there are 0.008 lbs moisture per lb of dry air and 100% RH. 0.021 lbs of moisture per lb of dry air (142 grains of moisture) have condensed out – the air is now dehumidified.

The air is dehumidified, but cold (50°F) and is at 100% RH; however it only has 53 grains of moisture.

Warm Back Up to 70°F (sensible heating), the RH raises to ~50%

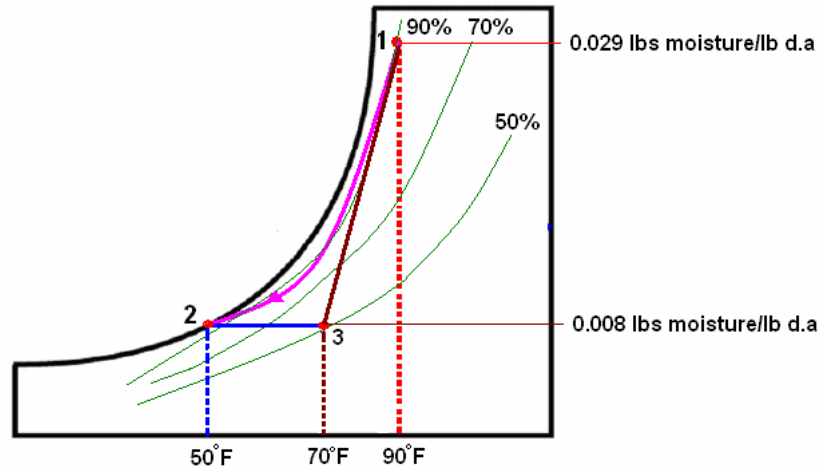

Summary

We had hot humid air

- chilled it to condense the moisture out (state point 2)
- warmed it back up to reach our target humidity (state point 3)
- Table below gives the temp, RH and specific humidity at each step

Temperature	RH	Specific Humidity
90°F	90%	0.029 lbs of moisture per lb d.a
50°F	100%	0.008 lbs of moisture per lb d.a
70°F	50%	0.008 lbs of moisture per lb d.a

Example

Determine the total, sensible and latent cooling required cooling 20,000 cfm of air from a temperature of 90 F and a relative humidity of 60% to a temperature of 55 F and 100% relative humidity.

Solution

From Psychrometric Chart, cooling 20,000cfm from 90F, $\phi = 60\%$ to 55F and $\phi = 100\%$:

$$T_1 = 90^\circ F \quad \phi_1 = 60\% \quad h_1 = 41.6 \left[\frac{Btu}{lba} \right] \quad v_1 = 14.26 \left[\frac{ft^3}{lba} \right] \quad w_1 = .0183 \left[\frac{lbw}{lba} \right]$$

$$T_2 = 55^\circ F \quad \phi_2 = 100\% \quad h_2 = 23.1 \left[\frac{Btu}{lba} \right] \quad w_2 = .0092 \left[\frac{lbw}{lba} \right]$$

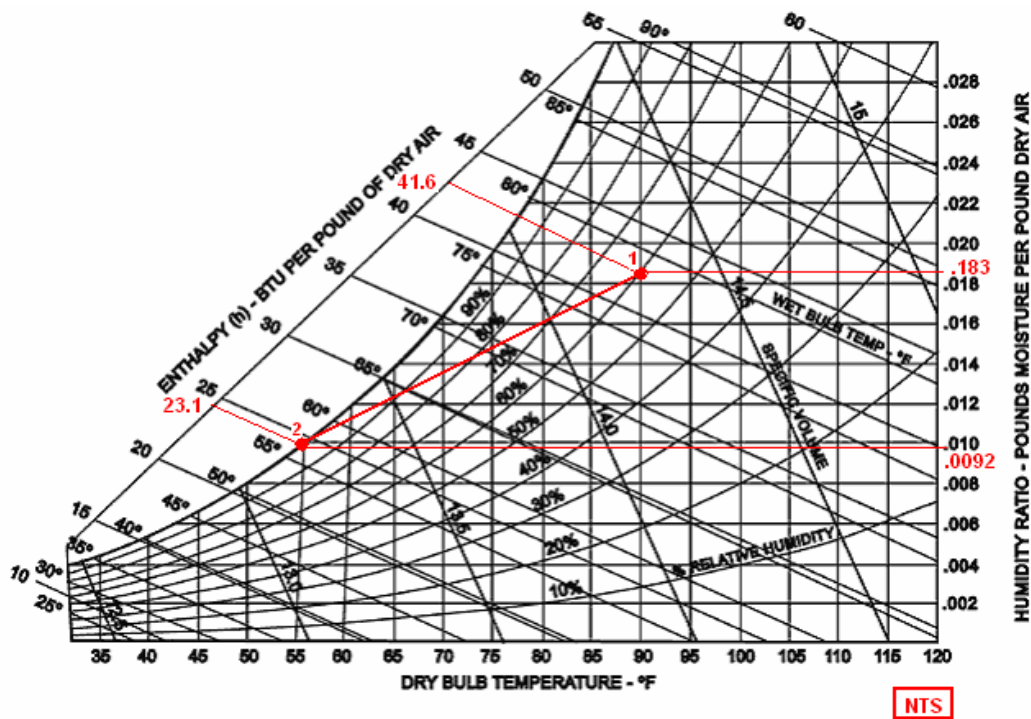
**Mass balance:**

$$\begin{aligned}\dot{m}_w &= \dot{m}_a (w_1 - w_2) \\ &= \frac{\dot{V}_1}{v_1} (w_1 - w_2) = \frac{20,000}{14.26} \left[\frac{\text{ft}^3 \cdot \text{lb}_a}{\text{min} \cdot \text{ft}^3} \right] \times (0.0183 - 0.0092) \left[\frac{\text{lb}_w}{\text{lb}_a} \right] \times 60 \left[\frac{\text{min}}{\text{hr}} \right] = 766 \left[\frac{\text{lb}_w}{\text{hr}} \right]\end{aligned}$$

Energy balance:

$$\begin{aligned}\dot{Q}_c &= \dot{m}_a (h_1 - h_2) - \dot{m}_w h_w \\ &= \left(\frac{20,000 \times 60}{14.26} \left[\frac{\text{ft}^3 \cdot \text{lb}_a \cdot \text{min}}{\text{min} \cdot \text{ft}^3 \cdot \text{hr}} \right] \times (41.6 - 23.1) \left[\frac{\text{Btu}}{\text{lb}_a} \right] \right) - \left(766 \left[\frac{\text{lb}_w}{\text{hr}} \right] \times 23.1 \left[\frac{\text{Btu}}{\text{lb}_w} \right] \right) = 1,539 \left[\frac{\text{kBtu}}{\text{hr}} \right]\end{aligned}$$

Approximate Method

$$\dot{Q}_{12} = \dot{m}_a (h_1 - h_2) = \dot{Q}_{\text{sen}} + \dot{Q}_{\text{lat}}$$

$$\begin{aligned}\dot{Q}_{\text{ext}} &= \dot{Q}_{\text{sen}} + \dot{Q}_{\text{lat}} \\ &= \dot{m}_a c_p \Delta T + \dot{m}_w h_{fg} = \dot{V} \rho c_p \Delta T + \dot{V} \rho (w_1 - w_2) h_{fg} \\ &= \left(20,000 \left[\frac{\text{ft}^3}{\text{min}} \right] \times 60 \left[\frac{\text{min}}{\text{hr}} \right] \times 0.018 \left[\frac{\text{Btu}}{\text{ft}^3 \cdot ^\circ\text{F}} \right] \times (90 - 55) ^\circ\text{F} \right) \\ &\quad + \left(20,000 \left[\frac{\text{ft}^3}{\text{min}} \right] \times 60 \left[\frac{\text{min}}{\text{hr}} \right] \times 80 \left[\frac{\text{Btu} \cdot \text{lb}_a}{\text{ft}^2 \cdot \text{lb}_w} \right] \times (0.0183 - 0.0092) \left[\frac{\text{lb}_w}{\text{lb}_a} \right] \right) \\ &= 756 \left[\frac{\text{kBtu}}{\text{hr}} \right] + 874 \left[\frac{\text{kBtu}}{\text{hr}} \right] = 1,630 \left[\frac{\text{kBtu}}{\text{hr}} \right]\end{aligned}$$

Heating and Dehumidification (Chemical Dehydration)

Heating and Dehumidification, also referred to as “chemical dehydration” is seeing increasing use in modern air-conditioning particularly in industrial environment. When air is brought into contact with a desiccant or sorption material the water vapor molecules will be adsorbed and the air will become “drier”. As this occurs, the heat of condensation will enter the air stream, thereby increasing its temperature. The process is essentially adiabatic or isenthalpic.

Dehumidification by solid desiccants is represented on the psychrometric chart by a process of increasing dry-bulb temperature and a decreasing humidity ratio. Dehumidification by liquid desiccants is also represented by a similar line, but when internal cooling is used in the apparatus, the process air line can go from warm and moist to cool and dry on the chart.

The mechanism of desiccant dehumidification in this case is either absorption (when physical or chemical changes occur) or adsorption (when there are no physical or chemical changes).

Observable characteristics of a heating and dehumidification process are:

1. dry bulb temperature increases
2. humidity ratio decreases
3. dew point temperature decreases
4. vapor pressure decreases
5. relative humidity decreases
6. enthalpy remains essentially constant
7. wet bulb temperature remains essentially constant

Typical heating and dehumidification processes are desiccant heat wheels which can be configured for controlled dehumidification (usually dew point control) or for latent heat recovery in ventilation air streams in warm humid climates.

Evaporative Cooling

Evaporative cooling is an adiabatic process, that is, there is no net heat loss or gain. When hot air stream is made to pass through wet spray, the sensible heat of air vaporizes the water and the air's dry bulb temperature will fall. The sensible heat used to vaporize the water enters the air as latent heat in added vapor; thus no heat is added or removed. Wet-bulb temperature remains constant.

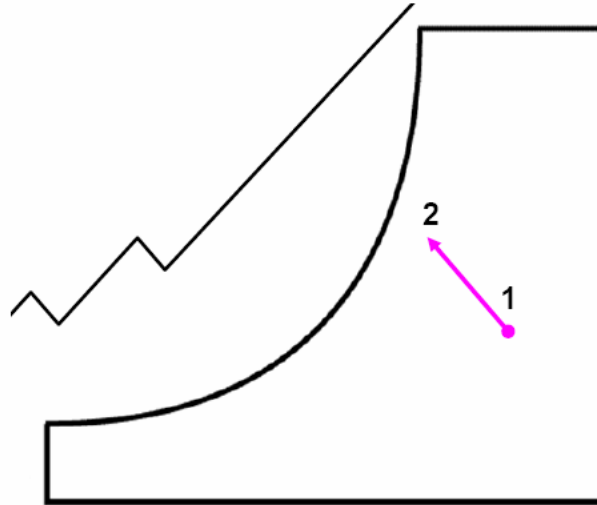

The evaporative cooling process is commonly employed to reduce the dry bulb temperature of the air without refrigeration. It is a constant wet bulb process of reducing dry bulb temperature. The hardware used to achieve this process usually consists of the basic components of the adiabatic saturation chamber plus some type of device to amplify the interface surface area between the water reservoir and the air, such as wetted wick, matting, plates, spray, etc.

Example

Evaporative cooling uses heat contained in the air to evaporate water. Air temperature (dry-bulb) drops while water content (humidity) rises to the saturation point. Evaporation is often used in hot weather to cool ventilation air. The process moves upward along the line of constant enthalpy or constant wet-bulb temperature, for example, from point D to point E in Figure below. Notice that hot dry air (points D to E with a 24°F temperature drop) has more capacity for evaporative cooling than hot humid air (points F to G with only a 12°F temperature decrease).

Solution

Refer the plot below:

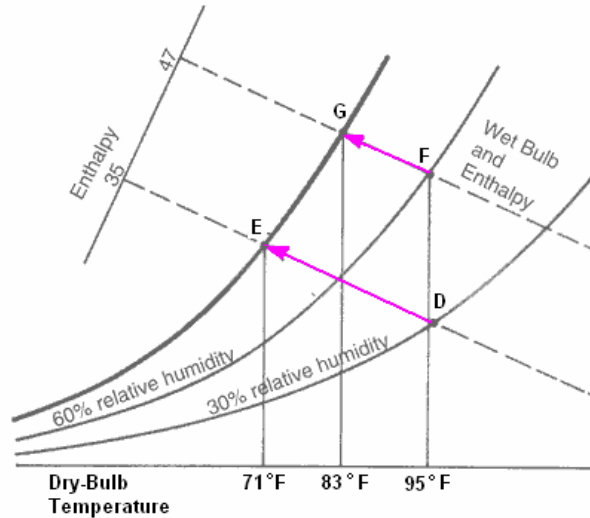

Evaporative cooling process with hot dry air from points D to E and with hot humid air from points F to G. Notice greater evaporative cooling capacity with dry air.

Observable features of the evaporative cooling process are:

1. Constant wet bulb temperature
2. Decreasing dry bulb temperature
3. Increasing humidity ratio
4. Increasing dew point temperature
5. Increasing vapor pressure
6. Essentially constant enthalpy
7. Decreasing specific volume
8. There is no loss or gain of heat within the system because the amount of sensible heat removed equals latent heat added to the water.

A typical evaporative cooling process is the direct conditioning of air for human comfort conditions in hot-dry climates and other applications where sensible cooling effects are desired and increasing humidity ratios can be tolerated.

This method adds moisture to the air stream while cooling it, and so would be useful in dry and arid regions where the warm air has a low humidity. The result of evaporative cooling is air that is cooler and more humid, and a surrounding that is dryer. For this reason, the process of evaporative cooling is sometimes referred to as drying.

Adiabatic Processes

The term 'Adiabatic' simply means without energy loss or gain. This refers mainly to the processes of evaporative cooling and desiccant dehumidification.

Evaporative cooling occurs when warm air passes near water. Even at temperatures well below its boiling point, water molecules on the surface will absorb sufficient energy from the passing air to change phase into a gas and become moisture vapour. As the moisture vapour then becomes part of the air, the energy is transferred from sensible heat into latent heat of vaporization. Thus the temperature of the air falls, but the absolute humidity rises, meaning that the overall energy content (or enthalpy) remains the same.

Desiccant dehumidification occurs when the air comes into contact with a substance such as Condi's Crystals or silica gel. Such substances simply absorb moisture directly from the air. In the process, the latent heat of vaporization is released back into the air, raising its temperature and reducing the absolute humidity. Once again, the net overall enthalpy remains the same.

Mixing Process (Steady Flow)

When two streams of air with different properties and flow rates are mixed, the properties of the resulting mixture (enthalpy, dry bulb temperature and saturation ratio) can be determined by simple proportional mass and energy balances.

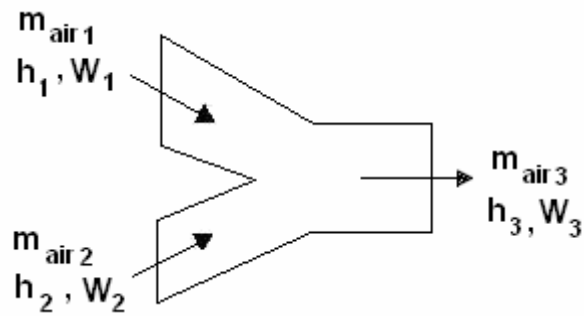

In most cases, heat loss from the system is negligible and the system can be modeled at adiabatic. On a psychrometric chart, the condition of the exiting air stream must be on the line connecting the incoming air streams. The distance along that line is determined by the ratio of the mass flow rates of the incoming streams.

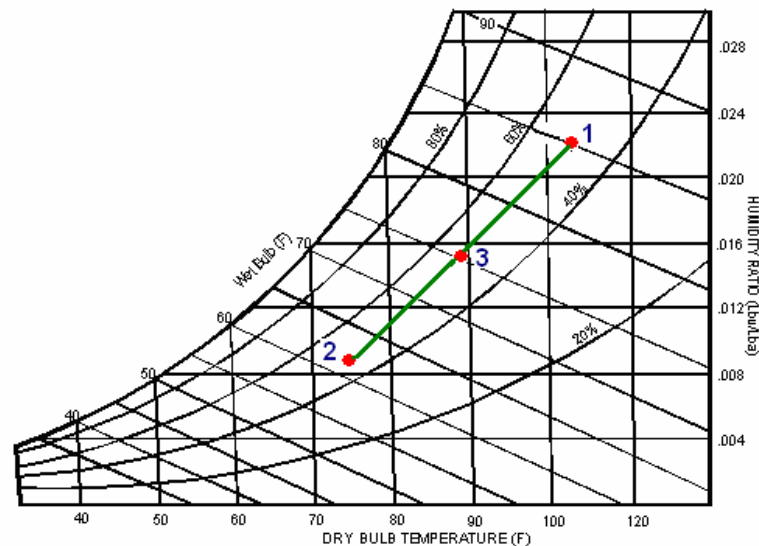

Schematic and result of mixing two air streams of different states

Examples of steady flow mixing process include the outdoor air - return air mixing chamber of an air handling unit; warm stream - cold stream mixing in dual stream systems (double duct or multi-zone); and supply air - recirculated air mixing in fan powered terminals.

Governing Equations:

The governing equations for this process are

Air Mass Balance

$$\dot{m}_1 + \dot{m}_2 = \dot{m}_3$$

$$\dot{V}_1 / v_1 + \dot{V}_2 / v_2 = \dot{V}_3 / v_3$$

Total Energy Balance:

$$\dot{m}_1 h_1 + \dot{m}_2 h_2 = \dot{m}_3 h_3$$

$$h_3 = \frac{\dot{m}_1 h_1 + \dot{m}_2 h_2}{\dot{m}_1 + \dot{m}_2}$$

$$h_3 \approx \frac{\dot{V}_1 h_1 + \dot{V}_2 h_2}{\dot{V}_1 + \dot{V}_2} \quad (\text{if } \rho_1 \approx \rho_2)$$

PSYCHROMETRIC PROCESS AS APPLICABLE TO DIFFERENT REGIONS

There are generally four extreme climatic conditions that may involve an air-conditioning system.

1. Hot and Humid (e.g. Miami) where both dry bulb temperature and humidity ratio is always high. Here the air-conditioning system is typically composed of a cooling coil with a surface temperature below the dew point temperature. That way, the system can achieve cooling and dehumidification.
2. Hot and Dry (e.g. Phoenix) where dry bulb temperature is high but the humidity ratio is low. Here the evaporative coolers will be most advantageous.
3. Cold and Dry (e.g., Minneapolis), the environment is typically very dry. In this case, the air-conditioning system usually is composed of a heating coil and a humidifying device, with the former being located upstream of the latter. The humidifying device may be a spray washer composed of a spray chamber in which a number of spray nozzles and risers are installed. Spray washers are typically used in industrial applications where the device performs the dual function of air humidification and cleaning.
4. Cold and Humid (e.g. Seattle), the outdoor air is cool but humid. Here, there may not be a need to humidify the air and the air-conditioning system typically is composed of a heating coil only. However, because the humidity ratio at low

temperatures is low even though the relative humidity may be high, some humidification may be required when the dew point is low during the winter.

In addition to these four extreme climatic conditions, the air-conditioning system may need to operate in the fall and spring. This mixed-mode operation usually requires switching between heating and cooling based on the value of the outdoor temperature. However, because of the potential energy waste associated with this mode of operation, the system usually is set to operate only if the outdoor temperature goes outside of a pre-specified wide band (to minimize the frequency of cycling between the heating and cooling modes).

To provide the reader with an idea of the psychrometric analyses that need to be performed on an air-conditioning system, the cooling and dehumidification process is described in more detail below. The cool, humid mode of operation is identical to the cold, dry mode (except in the absence of the humidifying device).

SUMMER MODE AIR CONDITIONING PROCESS

A basic air-conditioning schematic for summer mode is shown below:

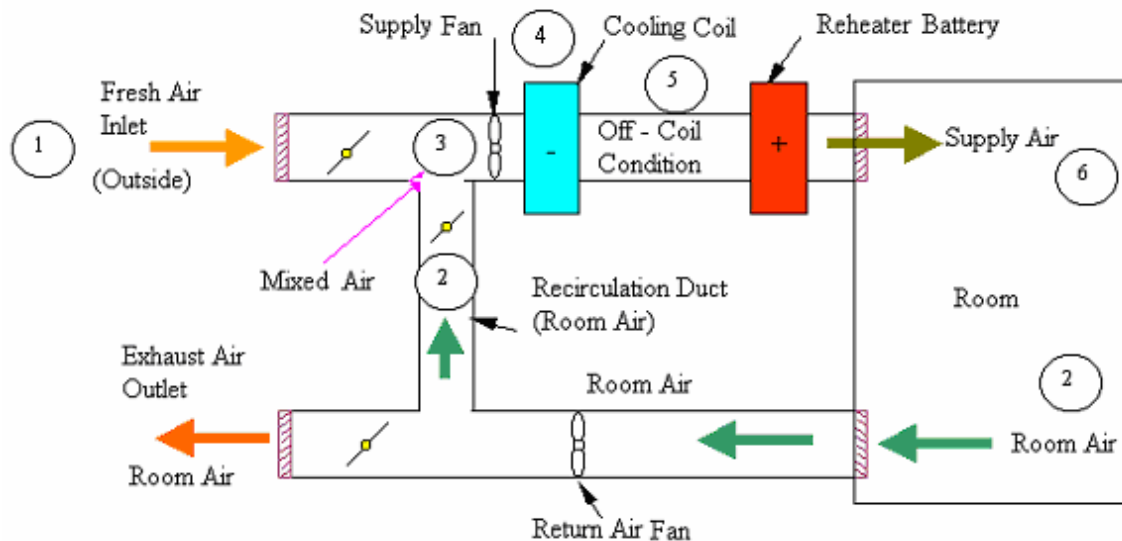

Here, return air from the conditioned space (2) mixes with required amount of outdoor air (1) at point (3) for acceptable indoor air quality and energy saving. The mixture is then cooled and dehumidified to ADP (4) at the cooling coil. The actual off-coil condition is represented as (5) due to inefficiency (bypass) of cooling coil. The conditioned air is

supplied to the room through the supply fan, supply duct, and ceiling diffuser (6). Supply air then absorbs the sensible and latent load from the space, becoming the space air (2). Room air is returned back to the cooling unit again and forms a closed cycle. Part of the return air is exhausted to balance the outdoor air intake and infiltration.

The psychrometric process is illustrated below for **summer** cycle.

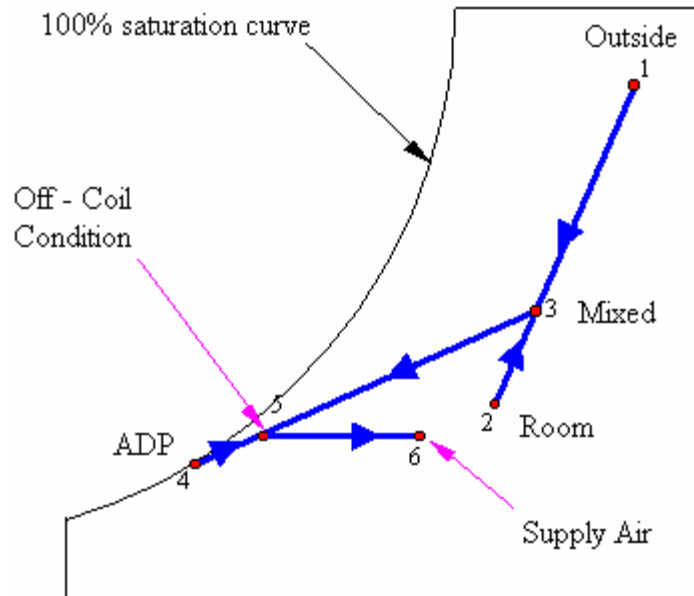

PSYCHROMETRIC CHART SHOWING TYPICAL
SUMMER CYCLE

You may notice that the off-coil condition is represented by node 5 away from ADP point 4. This is because the cooling coil is not 100% efficient and some of the air going through a cooling coil does not come into contact with the tubes or fins of the cooling coil and is therefore not cooled to the ADP temperature.

This may be looked upon as an inefficiency of the coil and is usually given as the cooling coil contact factor.

Bypass Factor

In most cooling applications, the air leaving the cooling coil is not entirely saturated since some air does not come in contact with the cooling coil. The fraction of air that misses the coil is called the bypass factor, BF. The bypass factor can be determined from the

temperature of water supplied to the cooling coil and from the states of incoming and exiting air. The process is shown on the psychrometric chart below.

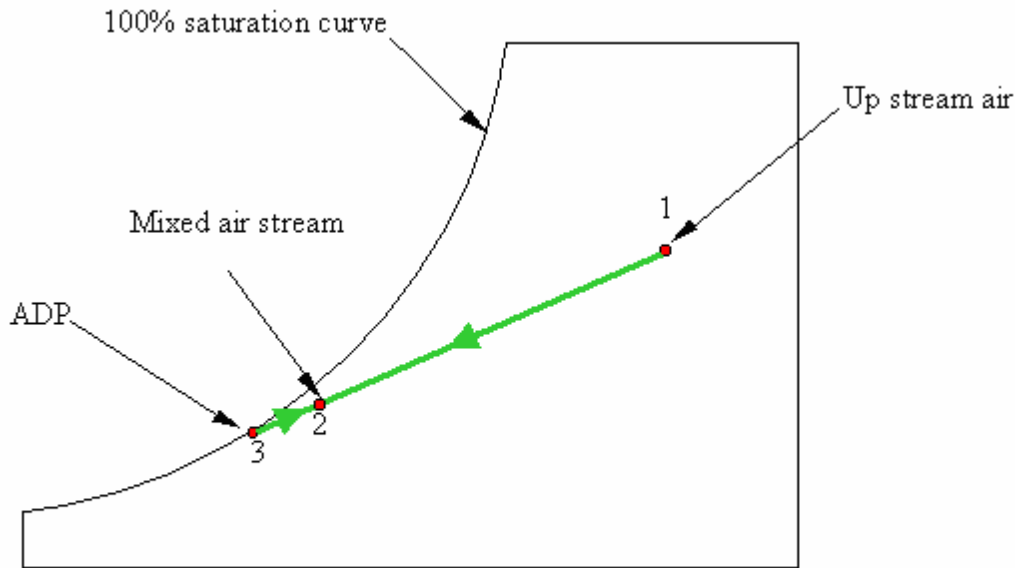

PSYCHROMETRIC CHART SHOWING COOLING COIL CONTACT FACTOR

The air that does not come in contact with the cooling coil is the “bypass factor” (BF) of a cooling coil may be found from;

$$BF = \frac{T_2 - T_3}{T_1 - T_3}$$

Example

Air enters a coil at 90°F, $\phi = 60\%$, while the coil is at 55°F and the BF = 0.2. What is the leaving air temperature?

Solution

$$BF = \frac{T_2 - T_3}{T_1 - T_3}$$

Or

$$T_2 = BF(T_1 - T_3) + T_3 = .2(90 - 55) + 55 = 62^\circ F$$

WINTER MODE HEATING PROCESS

The schematic diagram below shows a typical plant system for **winter** heating.

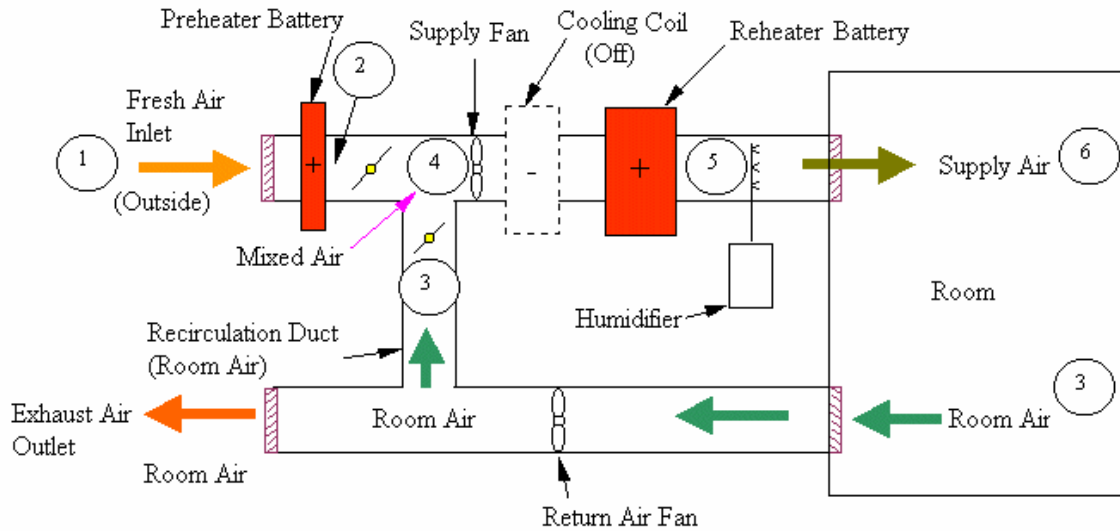

The psychrometric diagram below shows a typical **winter** cycle.

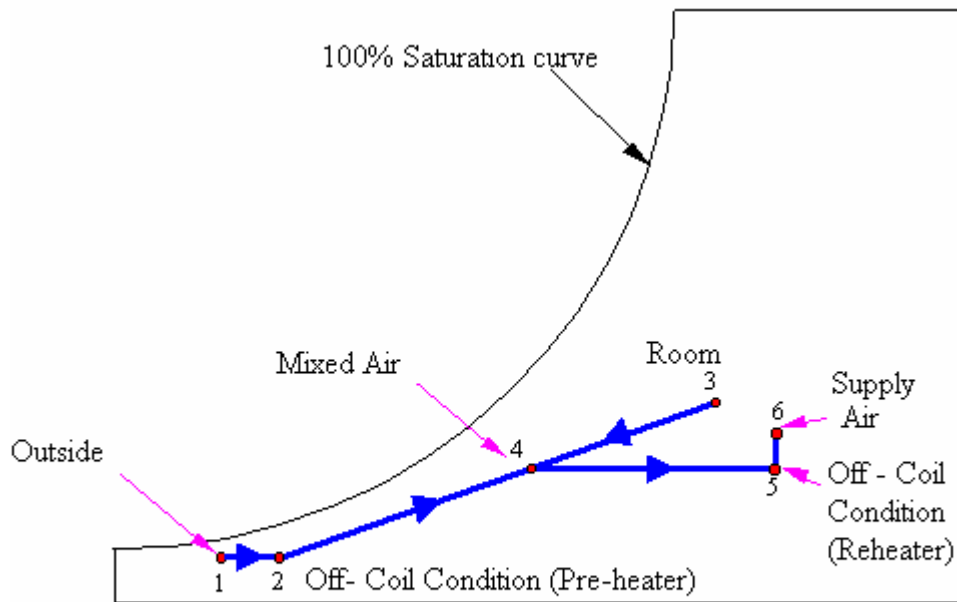

PSYCHROMETRIC CHART SHOWING TYPICAL WINTER CYCLE

APPLICATION OF PSYCHROMETRICS TO COOLING COIL SIZING

Sensible Heat V/s Latent Heat

Sensible Heat is the heat content causing an increase in dry-bulb temperature.

Latent Heat is the heat content due to the presence of water vapor in the atmosphere. It is the heat which was required to evaporate the given amount of moisture.

Sensible Heat Factor

An air-conditioning process describes the change in thermodynamic properties of moist air between the initial and final stages of conditioning as well as the corresponding energy and mass transfers between the moist air and a medium, such as water, refrigerant, absorbent or adsorbent, or moist air itself. The energy balance and conservation of mass are the two principles used for the analysis and the calculation of the thermodynamic properties of the moist air.

The thermal properties of air can be separated into latent and sensible heat. The *sensible heat ratio* (SHR) of an air-conditioning process is defined as the ratio of the change in absolute value of sensible heat to the change in absolute value of total heat, both in Btu/hr:

$$SHF = \frac{SH}{SH + LH} = \frac{SH}{TH}$$

SHF = sensible heat factor

SH = sensible heat

LH = latent heat

TH = total heat

For any air-conditioning process, the sensible heat change

$$SH = 60 * V_s * \rho * c * (T_2 - T_1) = 60 * m * c * (T_2 - T_1)$$

Where

- V_s = volume flow rate of supply air, cfm
- ρ_s = density of supply air, lb/ft³
- T_2, T_1 = moist air temperature at final and initial states of an air-conditioning process, °F and
- The mass flow rate of supply air is $m = V_s * \rho$

The latent heat change is

$$LH = 60 * V_s * \rho * (w_2 - w_1) * h_{fg} = 1060 * 60 * V_s * \rho * (w_2 - w_1)$$

Where

w_2, w_1 = humidity ratio at final and initial states of an air-conditioning process, lb/lb.

In Equation above, $h_{fg} \sim 1060$ Btu/lb represents the latent heat of vaporization or condensation of water at an estimated temperature of 58°F, where vaporization or condensation occurs in an air-handling unit or packaged unit.

The ratio of space sensible cooling to total cooling is useful for plotting the slope of the path that supply air travels after introduction into the space. The relationships among the psychrometric states, capacities, and sensible heat ratio are shown graphically in figure below. For a given pair of entering and leaving air states, the figure shows that sensible, latent, and total capacities are proportional to the differences in temperature, humidity ratio, and enthalpy, respectively. The SHR is defined by the *slope* of the line connecting the two points.

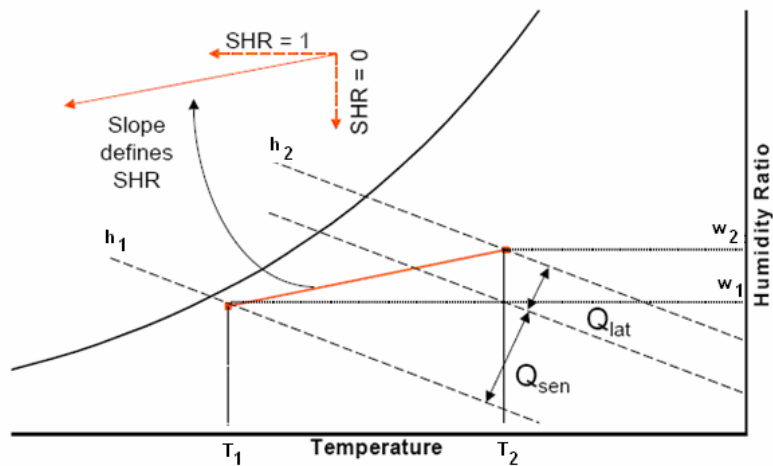

Room Sensible Heat Factor (RSHF)

The room sensible heat factor (RSHF) represents the psychrometric process of the supply air within the conditioned space. Room Sensible Heat Factor is the ratio of room sensible and room latent heat.

$$RSHF = \frac{RSH}{RSH + RLH} = \frac{RSH}{RTH}$$

RSHF = room sensible heat factor

RSH = room sensible heat

RLH = room latent heat

RTH = room total heat

The supply air to a conditioned space must have the capacity to offset simultaneously both the room sensible and room latent heat loads. The process is plotted on the standard psychrometric chart as below.

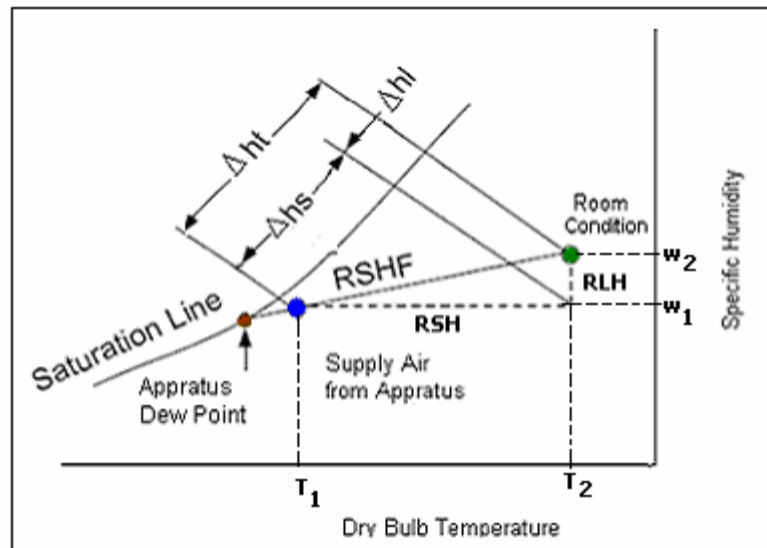

FIGURE - 1

The slope of the RSHF line illustrates the ratio of sensible to latent loads within the space. RSH is projected on the enthalpy lines to estimate the Δh_s (sensible load) and RLH is projected on the enthalpy lines to estimate the Δh_l (latent load). Room total load (RTH) is the enthalpy difference between the room design condition and the supply air condition.

Thus, if adequate air is supplied to offset these room loads, the room requirements will be satisfied, provided both the dry- and wet-bulb temperatures of the supply air fall on this line.

The figure above also shows a third point, defined as the apparatus dew point (ADP). The ADP represents an effective coil surface condition and the apparatus dew point

temperature can loosely be thought of as the coil temperature. The ADP is determined by extending the straight line between the entering and leaving air states until it reaches the saturation curve.

Grand Sensible Heat Factor (GSHF)

Grand Sensible Heat Factor is the ratio of the total sensible heat to the grand total heat load that the conditioning apparatus must handle, including the outdoor air heat loads.

This ratio is expressed as:

$$\text{GSHF} = \frac{\text{TSH}}{\text{TLH} + \text{TSH}} = \frac{\text{TSH}}{\text{GTH}}$$

GSHF = grand sensible heat factor

TSH = total sensible heat

TLH = total latent heat

GTH = grand total heat

The air which is passing through the AHU coil increases or decreases the temperature and/or the moisture content. The amount of rise or fall is determined by the total sensible and latent heat load that the conditioning apparatus must handle. The condition of the air entering the apparatus (mixture condition of outdoor and returning room air) and the condition of the air leaving the apparatus is plotted on the psychrometric chart as shown below.

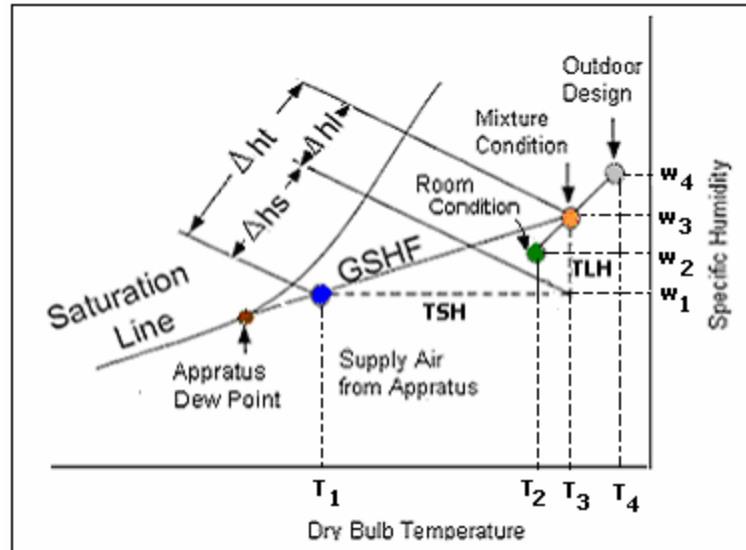

FIGURE - 2

GSHF Line is plotted between mixture conditions to supply air leaving condition from apparatus. The slope of the GSHF line represents the ratio of sensible and latent heat that the apparatus must handle. GSH is projected on the enthalpy lines to estimate the Δh_s (grand sensible load) and RLH is projected on the enthalpy lines to estimate the Δh_l (grand latent load). Grand total load (GTH) is the enthalpy difference between the mixed air condition and the supply air condition.

Notes

1. The RSHF line in Figure -1 is the line sloping between room condition and the supply air temperature whereas the GSHF line in Figure – 2 is the line sloping between the mixture condition and the supply air temperature.
2. The Apparatus dew point (ADP) is the coil surface dew point temperature required to accomplish a cooling/dehumidifying process.

Air Quantity

The air quantity required offsetting simultaneously the room sensible and latent loads and the air quantity required through the apparatus to handle the total sensible and latent loads may be calculated, using the conditions on their respective RSHF and

GSHF lines. For a particular application, when both the RSHF and GSHF ratio lines are plotted on the psychrometric chart, the intersection of the two lines represents the condition of the supply air to the space. It is also the condition of the air leaving the apparatus. The figure below illustrates what actually happens when these supplementary loads are considered in plotting the RSHF and GSHF lines.

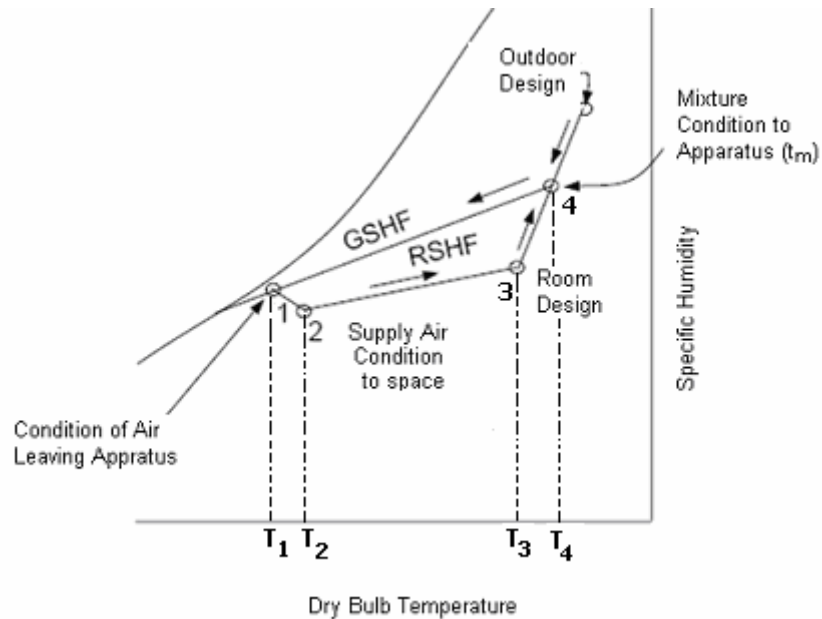

RSHF and GSHF Line Plotted with Supplementary Load Line

Point (1) is the condition of air leaving the apparatus and point (2) is the condition of supply air to the space. Line (1 - 2) represents the temperature rise of the air stream resulting from fan horsepower and heat gain into duct. Point (3) is the room design condition and point (4) is the mixture conditions entering the cooling coil (result of mixing return air and outside air).

The air quantity (mass flow rate) required to satisfy the room load may be calculated from the following equation:

$$RSH = m * C_p * \Delta T$$

In volumetric terms air flow rate in cubic feet per minute (CFM) is estimated below:

For air at $\rho = 0.075 \text{ lbm/ft}^3$ and $C_p = 0.24$

$$\text{RSH} = 0.075 * 0.24 * \text{CFM} * \Delta T / 60$$

$$\text{RSH} = 1.08 * \text{CFM} * (T_3 - T_2)$$

$$\text{CFM} = \text{RSH} / [1.08 * (T_3 - T_2)]$$

The air quantity required through the air conditioning apparatus, to satisfy the total air conditioning load (including the supplementary loads) may be calculated from the following equation:

$$\text{GSH} = 1.08 * \text{CFM} * (T_4 - T_1)$$

$$\text{CFM} = \text{GSH} / [1.08 * (T_4 - T_1)]$$

For all practical purposes, the required air quantity supplied to the space is equal to the air quantity required through the apparatus, neglecting leakage losses.

In well designed, tight systems the difference in supply air temperature and the condition of the air leaving the apparatus ($T_2 - T_1$) is usually no more than a few degrees. The difference in temperature between the room and the air supply to the room determines the amount of air required to satisfy the room sensible and latent loads. As this temperature difference increases (supplying colder air, since the room conditions are fixed), the required air quantity to the space decreases. This temperature difference can increase up to a limit where the RSHF line crosses the saturation line on the psychrometric chart; if it is assumed that the available conditioning equipment is able to take the air to 100% saturation.

The value of T_4 is determined by hit and trial. When the supply, return, and outdoor air temperatures are known equation below can be used to calculate outside air percentage or the mixed air temperature.

$$\% \text{ Outside Air} = \frac{T_{\text{Mixed Air}} - T_{\text{Return Air}}}{T_{\text{Outside Air}} - T_{\text{Return Air}}}$$

This equation assumes that perfect mixing occurs; the temperature or moisture content of the mixed air stream will be the same regardless of where they are measured in the

air stream. This approach works best when there are significant differences between the outdoor air temperature and the return temperature.

Once the required air flow rate (CFM) is known, the room specific humidity differential (Δw in lb of water vapor per lb of dry air) can be estimated as:

$$\Delta w = \text{RLH} \times \frac{1}{\text{CFM}} \times \frac{1}{\rho} \times \frac{1}{h_w} \times \frac{1}{60}$$

Where

Δw = Specific humidity differential in lb_w/lb_a

RLH = Room latent heat, Btu/hr

CFM = calculated air flow rate

ρ = air density (0.075 lb/ft³ at 60°F)

h_w = latent heat of vaporization (1059 Btu/lb, at 60°F)

60 = min/hr

Example

Consider an interior core room of a building has a sensible load of 120000 Btu/h; a latent load of 30000 Btu/h and is conditioned by a single zone AHU. The inside conditions to be maintained are 78°F dry bulb and 50% RH and the design supply air temperature is 58°F. Determine the air flow requirements.

The design airflow rate (CFM) will be:

$$\text{CFM} = \text{RSH} / [1.08 \times (T_{\text{Room}} - T_{\text{Supply Air}})]$$

$$\text{Air flow rate (CFM)} = 120,000 / [1.08 \times (78 - 58)]$$

$$\text{Air flow rate (CFM)} = 5555 \text{ CFM}$$

The point defined by these two differential values can be plotted on a psychrometric chart. The validity of the point must be verified, based on the cooling capabilities of the coil, and the AHU arrangements.

Psychrometric Representation for Draw-through AHU Arrangement

We have learnt that when both the RSHF and GSHF ratio lines are plotted on the psychrometric chart, the intersection of the two lines represents the condition of the supply air to the space. It is also the condition of the air leaving the apparatus. However this neglects fan and duct heat gain, duct leakage losses, etc. In actual practice, these heat gains are taken into account in estimating the cooling load. Therefore, the temperature of the air leaving the apparatus is not necessarily equal to the temperature of the air supplied to the space. For a draw-through arrangement, that is with the supply fan past the cooling coil- The supply air temperature will be greater than the "coil leaving" temperature, because of the heat added by the fan work.

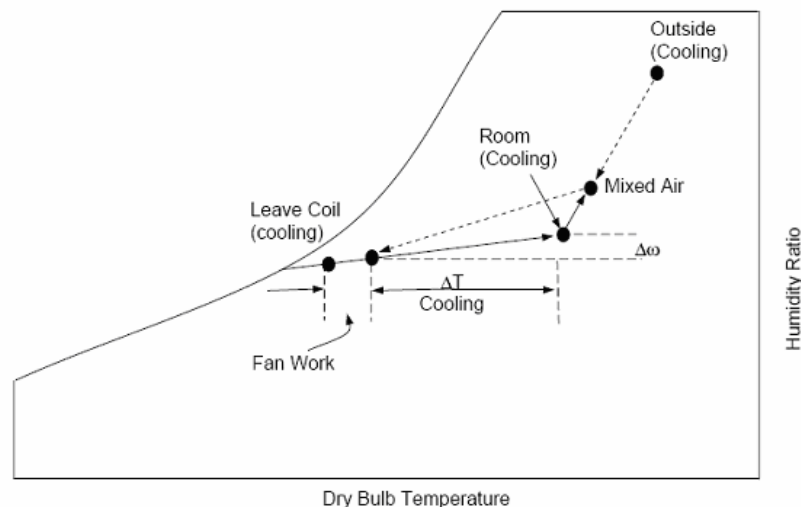

For this example if a 5hp motor is required, the temperature rise will be:

$$\Delta T = P \times \frac{1}{\text{cfm}} \times \frac{1}{1.08}$$

$$\Delta T = 5 \times 2545 \times \frac{1}{5555} \times \frac{1}{1.08}$$

Where

P is the power rating in hp and 2545 is Btu/hp

$$\Delta T = 2.1^{\circ}\text{F}$$

Thus the actual coil leaving condition shall be $58 - 2.1 = 55.9^{\circ}\text{F}$ DB which should be plotted on the chart.

For a *blow-through* arrangement, the fan work causes an increase in the mixed-air temperature before the air goes through the cooling coil, and the process is as in figure below. For this case, it is necessary to increase the supply of air ΔT to 22°F to get a valid "coil leaving" condition. This will reduce the air quantity to 5050 cfm and will require more care in the air distribution system to avoid cold air spillage and drafts. The Δw will be greater due to the reduction in cfm. Humidity control is not always required, but some upper limit will be inherent in any refrigeration-type cooling process-chilled water, brine, or direct expansion.

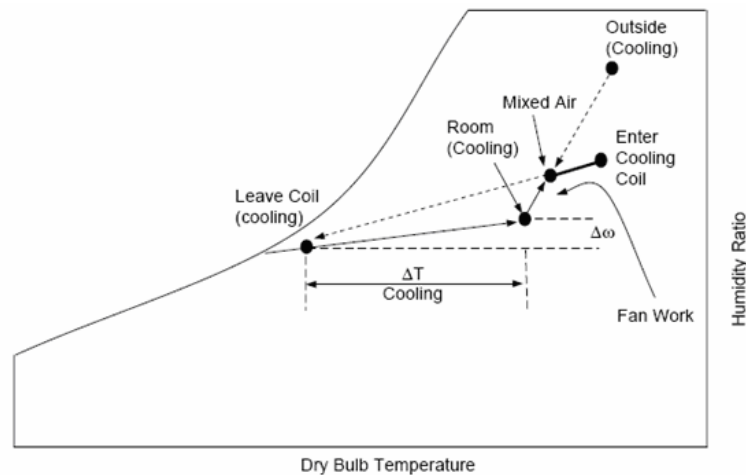

Psychrometric representation for blow-through AHU

Summarizing, draw-through units typically require 10% more supply air than blow-through systems for the same temperature off the cooling coil. This will increase duct size and fan operating cost. The fan heat will ensure the supply air is not fully saturated, avoiding moisture issues.

Blow-through units add the fan heat (usually equivalent to 2-3°F) before the cooling coil. The leaving air temperature from the cooling coil then becomes the supply air temperature. This provides the maximum temperature rise between the cooling air and the space design temperature (or the least amount of supply air will be required). Since the air is often fully saturated and moisture may be an issue, blow-through should not be used with final filters downstream of the coils.

COOLING COIL CAPACITY

A cooling coil serving one or more conditioned spaces is sized to meet the highest sum of the instantaneous space loads for all the spaces served by the coil, plus any external loads such as fan heat gain, duct heat gain, duct air leakage, and outdoor air ventilation loads (sensible and latent). At design condition, a cooling coil provides design air flow at design off-coil air temperature and humidity, which are determined to meet each zone's temperature and humidity requirements. For dehumidification applications, the cooling coil should have adequate latent cooling capacity as well as sensible cooling capacity.

Find below a simple cooling system:

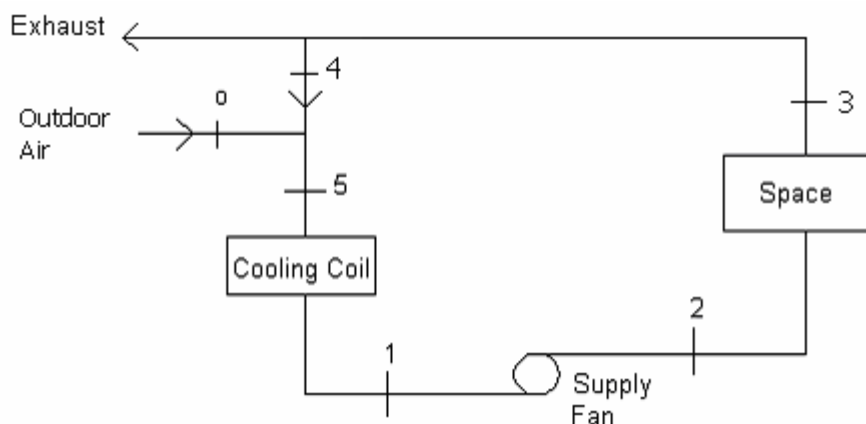

Simple Schematic of Cooling Unit

The nodes description is as follows:

1. The outside air conditions are located at point "o" in figure above.

2. The coil leaving conditions are located at point 1.
3. The supply air conditions are located at point 2 (note with the arrangement depicted, supply fan motor heat is added to the air stream)
4. The inside air conditions are located at point 3.
5. The mass flow rate of return air is located at point 4 (temperature conditions are essentially similar to point 5, but the mass flow rate varies depending on what portion of return air will be exhausted)
6. The mixture conditions are located at point 5 (note proportion of return air and outdoor air are mixed)

Plotting these nodes on the psychrometric chart:

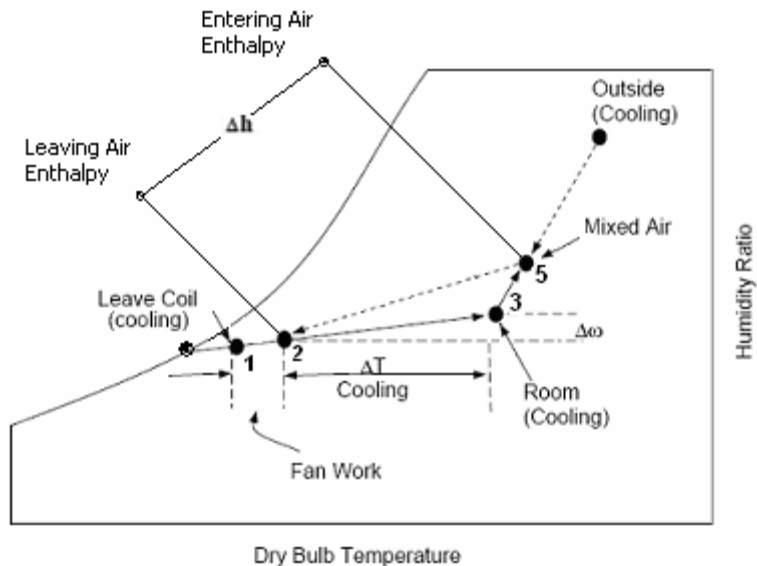

The room air flow is given by equation:

$$\text{CFM} = \text{RSH} / [1.08 \times (T_3 - T_2)]$$

Normally, zone air flow is calculated based on design sensible loads and design supply air flow, which may not meet humidity requirements. For dehumidification applications, the design air flow must meet both temperature and humidity requirements. A psychrometric chart is used to determine the enthalpy at point 5 and point 2 and the

mass flow rate at point 1. The total cooling coil load is calculated by the following equation:

$$Q_{\text{coil}} = m_1 * (h_5 - h_2) \text{ or}$$

Empirically

$$Q_{\text{coil}} = 4.5 \times \text{CFM} \times (h_5 - h_2)$$

Where:

- m_1 is the mass flow rate at point 1
- h_5 is the enthalpy at point 5
- h_2 is the enthalpy at point 2

Coil Load Calculation Example

Determine the minimum cooling coil load and required chilled water flow for a system serving an office space with a sensible cooling load of 30,800 Btu/h and a latent load of 13,500 Btu/h. Indoor design conditions are 75°F/50% RH, and Outdoor design conditions are 85°F DB/70°F WB. The minimum ventilation air is 25% of the total supply air which is delivered at 55°F. The fan selected is a 70% efficient "draw-through" arrangement, and delivers air at 4.0 inches total pressure. No manufacturer's coil data is available. Assume 10°F chilled water temperature rise through the coil.

$$\text{RSH} = 1.08 \times \text{CFM} \times \Delta T$$

$$\text{CFM} = \text{RSH} / (1.08 \times \Delta T)$$

$$\text{CFM} = 30,800 / [1.08 (75 - 55)]$$

$$\text{CFM} = 1425$$

$$\text{SHR} = 30,800 / (30,800 + 13,500) = 0.70$$

Psychrometrics

Plot Space Conditions of 75°F/50% RH Find the intersection of the SHR line with space temperature and supply air temperature

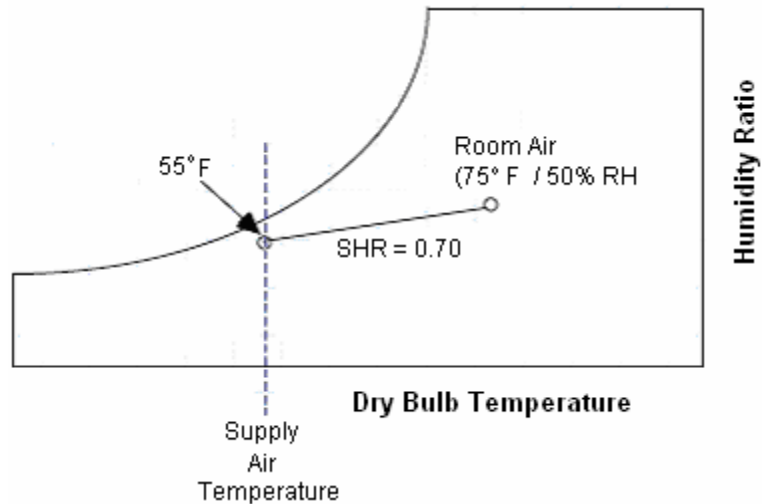

Plot Outdoor Conditions of 85°F/ 70°F WB; Locate Mixed Air Condition (25% OA) and Account for Fan ΔT (consider 2 degree rise).

Assuming the perfect mixing occurs, the mixed air conditions can be found by equation:

$$\% \text{ Outside Air} = \frac{T_{\text{Mixed Air}} - T_{\text{Return Air}}}{T_{\text{Outside Air}} - T_{\text{Return Air}}}$$

$$T_{\text{Mixed Air}} = \% \text{ Outside Air} [T_{\text{Outside Air}} - T_{\text{Return Air}}] + T_{\text{Return Air}}$$

$$T_{\text{Mixed Air}} = 0.25 [85 - 75] + 75$$

$$T_{\text{Mixed Air}} = 77.5^\circ \text{ F}$$

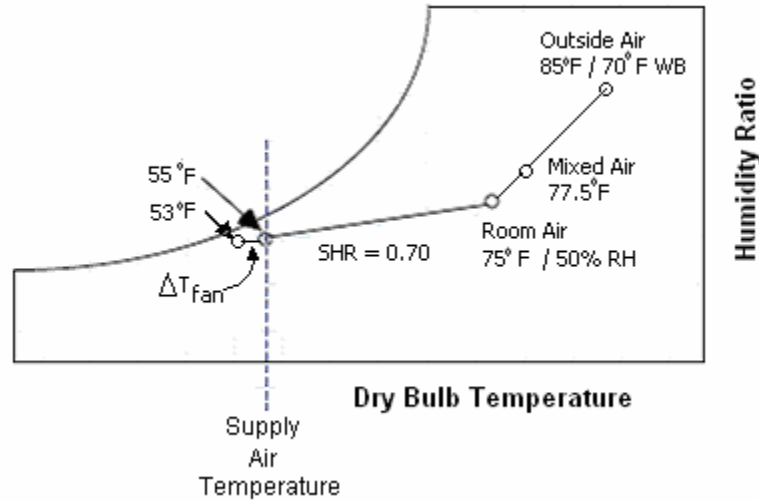

Determine enthalpy for coil entering and leaving conditions

$$Q_{\text{coil}} = 4.5 \times \text{CFM} \times \Delta h$$

$$Q_{\text{coil}} = 4.5 \times 1425 \times (29.8 - 20.5)$$

$$Q_{\text{coil}} = 58,636 \text{ Btu/hr}$$

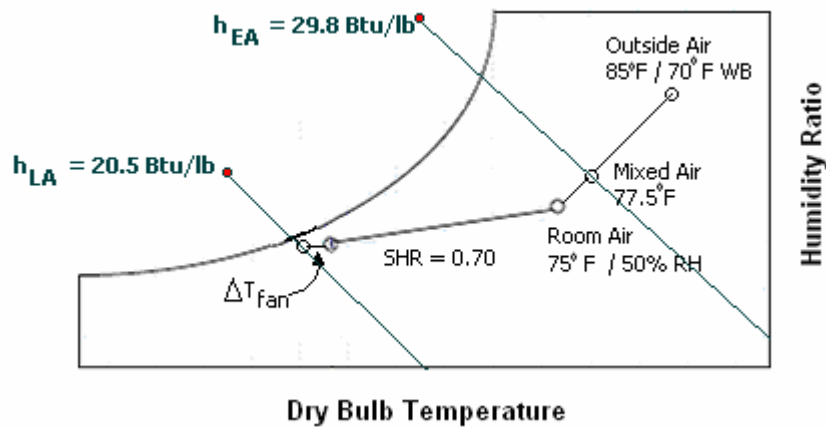

Determine Chilled Water Flow

$$Q_{\text{total}} = m \cdot C_p \cdot \Delta T$$

For water at $\rho = 62.34 \text{ lbm/ft}^3$ and $C_p = 1.0$

$$Q_{\text{total}} = 500 \times \text{GPM} \times \Delta T$$

$$\text{GPM} = Q \text{ coil} / (500 \times \Delta T) = 58,590 / (500 \times 10^\circ\text{F})$$

$$\text{GPM} = 11.7$$

Room Specific Humidity Differential (Δw)

$$\Delta w = \text{Latent heat} \times \frac{1}{\text{CFM}} \times \frac{1}{\rho} \times \frac{1}{h_w}$$

$$\Delta w = 13500 \times \frac{1}{1425} \times \frac{1}{0.075} \times \frac{1}{1059} \times \frac{1}{60}$$

$$\Delta w = 0.00198 \frac{\text{lb}_w}{\text{lb}_a}$$

Where

13500 = latent heat, Btu/hr

1425 = calculated air flow rate, cfm

0.075 = air density, lb/ft³ (saturated air)

1059 = latent heat of vaporization at 60°F, Btu/lb

60 = min/hr

STANDARD EQUATIONS IN AIR-CONDITIONING

The following formulae and factors are used in the air conditioning field:

Thermal Load

Thermal Load

$$\text{Btu} = (\text{lbs}) * (\text{sp. heat}) * (\Delta T)$$

$$\text{Btu/hr} = (\text{lbs/hr}) * (\text{sp. heat}) * (\Delta T)$$

$$\text{Btu/hr} = (\text{lbs/hr}) * (\text{hg} - \text{hf})$$

Mass – Volume Relation

$$\text{Lbs/hr (std. air)} = (\text{CFM}) * (\text{lbs/ft}^3) * (60 \text{ min/hr})$$

$$= (\text{CFM}) * (0.075) * (60)$$

$$= (\text{CFM}) * 4.5$$

Sensible Heat

$$\text{SH, Btu/hr (std. air)} = (\text{lbs/hr}) * (\text{sp. heat}) * (\Delta T)$$

$$= (\text{CFM}) * (4.5) * (0.24) * (\Delta T)$$

$$= (\text{CFM}) * (1.08) * (\Delta T)$$

Air Flow Rate

$$\text{CFM} = \text{SH} / [(1.08) * (\text{room temperature} - \text{supplied air temperature})]$$

Latent Heat

$$\text{LH, Btu/hr (std. air)} = (\text{lbs/hr}) * (\text{hg} - \text{hf}) (\text{grains of moisture diff. } /7,000 \text{ grains/lb})$$

$$= (\text{CFM}) * (4.5) * (1,054) (\text{grains diff. } /7,000)$$

$$= (\text{CFM}) * (0.68) * (\text{grains diff.})$$

Where $(h_g - h_f) = 1,054$ Btu/lb represents the heat of vaporization at 70°F. Variation in value for different conditions will be small.

Chilled Water Flow Rate

$$\text{Lbs/hr (water)} = (\text{GPM}) * (\text{lbs/gal}) * (\text{min/hr})$$

$$= (\text{GPM}) * (8.33) * (60)$$

$$= (\text{GPM}) * (500)$$

Fan Power

$$\text{HP air} = [(\text{CFM}) * (\Delta P)] / [(6,350) * (\text{fan efficiency})]$$

Pump Power

$$\text{HP water} = [(\text{GPM}) * (\Delta P)] / [(3,960) * (\text{pump efficiency})]$$

Where

ΔT = temperature difference

ΔP = pressure difference

Relative Humidity

The relative humidity of moist air leaving the water cooling coil or DX coil depends mainly on the outer surface area of the coil including pipe and fins. For coils with ten or

more fins per inch, if the entering moist air is around 80°F dry bulb and 68°F wet bulb, the relative humidity of air leaving the coil (off-coil) may be estimated as:

Four-row coil 90 to 95%

Six-row and eight-row coils 96 to 98%

CONCLUSION

The air around us is mixture of dry air and water vapor, and can be modeled as a mixture of these two ideal gasses. The study of moist air is called psychrometry. The properties of this mixture of moist air at a given pressure are displayed on a psychrometric chart.

Proper analysis of air-conditioning processes is crucial in accurately computing the volume flow rates of air through the air-conditioning ducts. This phase, in an air-conditioning design process, follows the load calculation phase. While the latter phase produces quantities that represent the sensible and latent loads imposed on the conditioned space, the psychrometric analysis is capable of incorporating the effects of introducing fresh outside air into the space for ventilation purposes.

Cooling or heating equipment sizing takes into account not only the load imposed on the conditioned space, but also the outside load. By specifying the amount of outside air to be introduced for a specified set of outdoor and indoor conditions, psychrometric analysis enables the HVAC designer to compute the load imposed on the conditioning equipment (grand load).

The analysis is inherently capable of distinguishing between the sensible and latent load quantities of outside and conditioned space (room) air, thus providing an insightful picture of how to handle the existing moisture.

Psychrometric analysis also enables the designer to account for other smaller loads that may be imposed on the system such as ducts and fans in equipment sizing. By identifying the different state points of the air as it passes through the duct system and over the supply and return fans, the volume flow rates of air computed by the analysis become necessarily inclusive of the effects of the ducts and fans in equipment sizing.
