



PDHonline Course M493 (5 PDH)

Mach 1 & Beyond: The Quest for Supersonic Flight

Instructor: Jeffrey Syken

2020

PDH Online | PDH Center

5272 Meadow Estates Drive
Fairfax, VA 22030-6658
Phone: 703-988-0088
www.PDHonline.com

An Approved Continuing Education Provider



Table of Contents

<u>Slide/s</u>	<u>Part</u>	<u>Description</u>
1	N/A	Title
2	N/A	Table of Contents
3-47	1	The Rocketeers
48-104	2	Is it Possible?
105-191	3	The Need for Speed
192-237	4	America First
238-327	5	This is the Concorde
328-400	6	A New World of Flight

2

Part 1

The Rocketeers

3

Freedom From the Air

4

"The rocket is now in that most interesting period of discovery where the shore lines are unplotted and the future limited only by imagination. We cannot state what speeds or ranges the rocket may attain, but it is not restricted by the rotation of an engine or by dependence on the atmosphere. As the airplane gave man freedom from the earth, the rocket offers him freedom from the air."

Charles Lindbergh, 1938

5

86 Guns

6

"A standard type plane which can be made into a rocket-propelled machine by equipping it with gun-barrel attachments is shown in the picture at the right. The machine is the invention of Maurice Poirier of

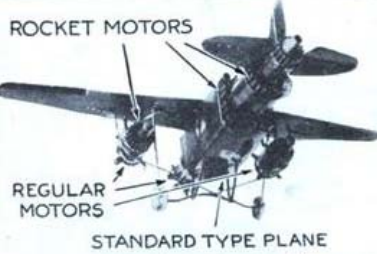

Burbank, Cal. Regular gasoline motors are used in the plane in addition to the rockets. There are 86 gun barrels attached to the fuselage of the plane, and the concussion resulting from explosions in the tubes is expected to give the plane a speed of 400 miles an hour."
Modern Mechanix, January 1929

7

Rocket Driven Plane

8

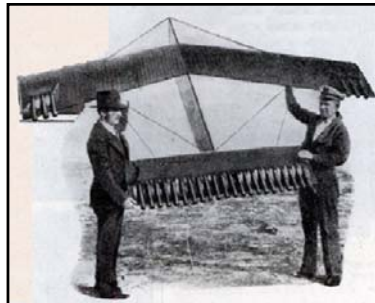

"If their calculations are correct, a barrage of rockets will soon send a ten-foot model plane whizzing through the air. Maurice Poirier and Franklin L. Wallace, of Los Angeles, Calif., built the model and if it flies they will attempt to build a full-sized craft on the

same plan. They predict that the rockets will give the model a speed approaching ten miles a minute."

Popular Science, December 1930

Above: caption: "Model of rocket-driven plane which its inventors say will whiz through air at ten miles a minute"

9

Rocket Driven Bomb

10

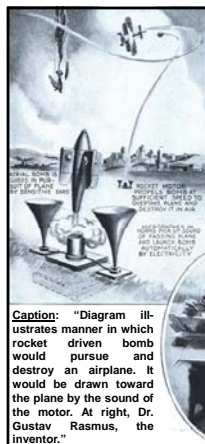

"A bomb that could chase an airplane in the air and destroy it is the amazing war weapon proposed by a San Diego, Calif., man. Launched from the ground automatically, the self-propelled rocket bomb would be guided in the air by the sound of the plane's motor. No matter how the pilot might twist and turn, the bomb would follow him until it overtook the plane. The impact would set off a charge of high explosive. A model of such a bomb was recently exhibited to a Popular Science Monthly correspondent by Dr. Gustav Rasmus, San Diego patent attorney, who suggests this unique defense weapon. According to this inventor, he is secretly testing the possibilities of the plan with actual working models. If found practical, it would be used in the following way, he says: For firing, the bomb is set in a mortarlike stand connected to sound detectors. The sound of an airplane passing overhead starts the bomb electrically. Its rocket motor enables it to travel fast enough to overtake the swiftest airplane. In the air the bomb is guided by sensitive 'ears' housed in knobs on the four guide vanes. They actuate rudder flaps. An impact on any one of five points detonates a charge of high explosive in the head of the bomb. Such a bomb, Dr. Rasmus says, could be made as large as desired."
Popular Science, July 1931

11

Rocket Mail

12



"Another step toward the establishment of rocket airmail was reached in England recently when a rocket perfected by Gerhard Zucker, German inventor, successfully completed a short test flight. Carrying a load of 1,200 letters, the rocket was fired from Brighton and made a two-mile trip without damaging its cargo. The letters were then removed and posted in the ordinary manner. Encouraged by results of the test flight, a British rocket syndicate is planning a series of extensive experiments."

Modern Mechanix, November 1934

Above: caption: "Photo shows loading of airmail rocket, preparatory to its test flight. Launched at Brighton, England, the rocket traveled two miles without damaging its cargo of mail."



"The rocket-shooters are going to pitch in again this coming summer. Undaunted by reverses and tragedies during the past year's experiments, the rocketeers are tackling their work with renewed vigor and ambition, plus improved apparatus and chemicals. Ernst Loebell, famous German engineer and rocket designer, promises to bring the rocket engines to their greatest point of achievement next summer. He is now in this country and is an active worker in the Cleveland Rocket Society. Loebell has been carrying on his preliminary experiments on the big Hanna estate in a suburb of Cleveland. In their operations the Cleveland group has been making use of the lessons taught by the experiments of Loebell's countryman, the late Reinhold Tilling, a noted radio engineer and rocket builder..."

Modern Mechanix, May 1934

Above: caption: "Success of this rocket driven auto paved the way for conquest of the ether"

"...Ernst Loebell and his assistant, Ted Banna, have also investigated another secret German rocket - that of the famous Fischer brothers, details of which have also been closely guarded. The Fischers have achieved the biggest advance thus far in the field of passenger rocket flying. The Fischers pursued their experiments on the island of Rugen in the Baltic Sea under the auspices of the German War Ministry. Otto Fischer, brother of Bruno, who designed the rocket, was shot up 32,000 feet, more than six miles, into the air in a 24-foot steel projectile. At the peak of the rocket's trajectory, Otto released a parachute attached to the rocket and maneuvered a safe landing. The ascent lasted 10 minutes and 26 seconds..."

Modern Mechanix, May 1934

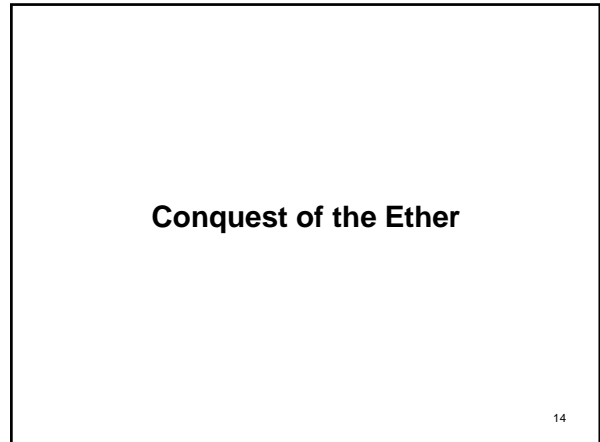

Conquest of the Ether



"...Prior to his death, Tilling had been experimenting with rockets and rocket planes for months. The success of a rocket which reached a height of 6,000 feet in 1931 spurred him on to the construction of a rocket with glider wings which unfolded when the fuel was exhausted and brought the projectile gently to earth. This feat was hailed as one of the first practical steps toward the development of mail and passenger carrying rockets. The Tilling rockets were set in motion by telignition from a distance of 100 yards. They attained a speed of 700 miles an hour and landed five miles from the starting point, in accordance with calculations. Herr Tilling was working on a system designed to manipulate his rockets by radio control when he and a female assistant were killed in the explosion of a rocket which they were charging. Such information as emanated from the secrecy surrounding Tilling's operations at Osnarbrueck, Germany, has since been in the possession of the Cleveland Rocket Society's guiding geniuses. They plan to adopt the Tilling heritage and carry his work to further perfection..."

Modern Mechanix, May 1934

Top: caption: "Capable of both horizontal and vertical flight, this rocket snaps a picture and returns to the sender"



Middle: caption: "The late Herr Tilling, German rocket builder, was famous for his... rockets"



Left: caption: "Penetration of the stratosphere to a depth of fifteen miles is planned by the Cleveland Rocket Society here shown conducting a successful test of a new rocket motor. The model motor consists only of a combustion chamber. A highly volatile gas combination is fed through two tubes in the nose. Oxygen is poured through one inlet and gasoline under 250 pounds pressure through the other."



"...Equipped with a knowledge of the experiments of all their contemporaries, the Cleveland rocketeers are ready to make progress with their own design which they think will have greater practical value than the products of the scientists across the sea...Tongues of yellow flame shot from the exhaust, changing to a bluish-white streak as Loebell readjusted the fuel valves. The staccato explosions of the exhaust became a dull drone. The motor tugged violently at its fastenings. Combustion lasted for five minutes, indicating that the completed rocket would easily have attained a five-mile altitude..."

Modern Mechanix, May 1934

“...The completed rocket is expected to be fifteen feet high. When shot from the bottom of a thirty-foot shaft, its inventors hope to penetrate fifteen miles into the stratosphere. The shaft is necessary to give the rocket direction. When the rocket reaches the peak of its arc and starts falling, a delicate ‘trip’ trigger will release a parachute to lower the rocket gently to earth.”

Modern Mechanix, May 1934

Main Caption: “An artist’s conception of the man-carrying rocket of the future. Note autogyro vanes which float the rocket back to earth when power is spent, allowing it to settle gently on landing fins.”

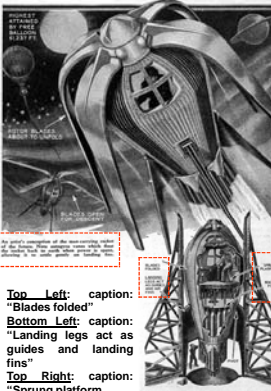

Top Left: caption: “Blades folded”

Bottom Left: caption: “Landing legs act as guides and landing fins”

Top Right: caption: “Sprung platform”

Bottom Right: caption: “Rocket fuel”

19

Dream or Reality?

20



Top: caption: “Prophetically depicting what future commercial rocket flight ‘space ships’ will look like, a recent motion picture features scenes showing a passenger rocket taking off from a long runway (left) and another super-rocket ship being nosed out of its hangar (left center) in preparation for a transcontinental flight at speeds surpassing 1,000 miles per hour. Bona fide rocket experimenters, however, acknowledge that it will be a long time before passenger rockets will be practical.”

Middle: caption: “In the photo at right, an experimental rocket is seen just at the moment of leaving the ground. Rockets do not have to be shot into the air in order to conduct tests, but are usually ‘launched’ on a proving stand, special instruments indicating power, rate of climb, and other data.”

Bottom: caption: “Much in the manner of pioneer aircraft experimenters, groups of rocket fans are constantly seeking to improve rocket flight in an effort to hasten the day when commercial rocket travel will be practical. Left - German experimenters with a newly developed rocket. Above - Test plane fitted with a rocket motor at tail. Rocket motors have also been tested in boats and automobiles.”

Modern Mechanix, June 1938

21

Number One Rocket Man

22

“...About three miles north of Roswell, a shop 30 by 55 feet was erected, and near it a 20-foot tower built for proving-stand tests of motors and rockets. Fifteen miles farther north, on the plains, stands the 60-foot launching tower from which actual rocket shots are made. The region thereabout lies an altitude of about 3,500 feet - enough to reduce noticeably the resistance of the air to rapid flight, as compared with the denser air at sea level. The country is level and open. There is space for high experimental flights without much danger of the rocket landing on an indignant bystander...”

Scientific American, May 1938

23



“On a flat, dry plain, 18 miles north of Roswell, New Mexico, rises a 60-foot tower of steel that has roused more curiosity, and has probably had a greater influence on the future of the world, than any other feature of all New Mexico’s arresting landscape. From this tower, at irregular intervals, a Massachusetts physicist and his assistants send roaring into the skies certain gleaming, cigar-shaped projectiles of metal, powered by gasoline and liquid oxygen, and landed by parachutes...”

Scientific American, May 1938

Left: caption: “Erection of the 60-foot launching tower formerly employed in the east”

24



"...The physicist is Dr. Robert Hutchings Goddard, a bald, spare, pleasant man who will be 56 years old next October 5 (1938). Rocket experimenters the world over recognize him as their Number One man. Not only has he made more contributions to the new field of rocket engineering than any other one individual, but it was Dr. Goddard who launched modern rocket research with his clear presentation of the possibilities of rockets, both their limitations and advantages, 19 years ago. His publication, modestly entitled 'A Method of Reaching Extreme Altitudes,' was published by the Smithsonian Institution

in 1919. Dr. Goddard at that time had already been a rocket experimenter for nearly ten years. His first trials were made during studies of the upper atmosphere while he was an instructor at the Worcester Polytechnic Institute, in 1909. Baffled by the uncertainty and limitations of sounding balloons, he imagined that by building some kind of huge skyrocket he could shoot self-recording instruments high into the stratosphere and bring back information of value to science.

Above: caption: "Prof. Robert H. Goddard, 'Number One Rocket Man,' in the well-equipped shop three miles from Roswell, New Mexico, where his rockets are prepared" 25

"...This idea of reaching high altitudes with rockets was by no means new with Dr. Goddard. In fact, we are told that a certain Chinese mandarin in the 13th Century sought to lift himself to the moon by fastening rockets to the legs of his chair. Cyrano de Bergerac, the novelist, wrote a story 300 years ago in which the hero transported himself by rocket power. Warring men saw in rockets a potential carrier of explosives centuries ago, and in the Napoleonic wars rocket brigades blossomed in Europe. In the siege of Boulogne, the English succeeded in setting the town afire with rockets designed by Sir William Congreve. But those early efforts were rule-of-thumb procedures, and really came to little. What Dr. Goddard proposed, 29 years ago, was to apply the methods of modern engineering to the construction of rockets. He perceived that several diverse and complicated problems would have to be tackled: (1) the fuel, (2) the materials, (3) the methods of feeding the fuels, (4) the aerodynamic design, (5) control in flight, (6) the further unknowns. For the rocket, though a seemingly simple device, is really very complicated. It works by recoil - by application of the ancient principle that every action has an equal and opposite reaction. The action is produced by rapid combustion and simultaneous ejection of gas at high velocity. The reaction occurs in the body of the rocket, which flies at an accelerated rate in the direction opposite that of the ejected gases..."

Scientific American, May 1938 26

"...Talk of rockets is so commonplace today - such success has attended the efforts of experimenters - that rocketry is almost respectable. But in the old days of 1914 and earlier, few sane engineers spoke of them except humorously, and physicists who entertained the idea of rocket transportation must have been as rare as one-armed flute players. Nevertheless, Dr. Goddard succeeded, one by one, in convincing his colleagues. In 1914, plugging away on his own, he took out two basic patents on rockets, pertaining to combustion chambers and nozzles. A short time later he talked the problem of rocketry through with Dr. Charles G. Abbot, Secretary of the Smithsonian Institution. So convincing was his argument that the conservative old Institution agreed to grant him modest funds for a series of experiments. In the tests that followed, Dr. Goddard demonstrated that rockets really need no air to push against, and that they are capable of development. He also proved that gunpowder-like fuels must be abandoned in favor of more powerful, more easily controlled kinds, probably liquefied gases..."

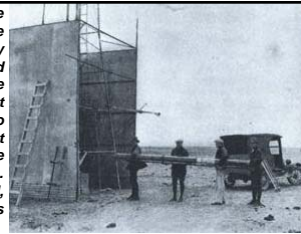

Scientific American, May 1938
Above: caption: "A rocket being placed in the 60-foot launching tower on the plains 18 miles north of Roswell, New Mexico" 27

"...Thus started what rocket engineers now refer to as the era of 'liquid-fuel' rockets - the real beginning of scientific rocketry. Simple calculations show that the most powerful release of energy, pound for pound, occurs during the combustion of carbon or hydrogen with oxy-gen. The problem was to produce this combustion at the right time, in the right place, and under the right conditions. After some preliminary trials, Dr. Goddard decided that the best fuel would be a chemical combination of hydrogen and carbon, as in gasoline, and that oxygen could most conveniently be supplied in the pure form, liquefied. These early tests were carried on very secretly near Auburn, Massachusetts, and apparently were the first 'proving-stand' experiments with liquid-fuel rocket motors - primitive, to be sure, but they set the foundation upon which a great deal of experimental work has since been built. Dr. Goddard tried out liquid oxygen and various members of the hydro-carbon series, including gasoline, kerosene, liquid propane, also ether. He finally discarded the others and settled on gasoline and oxygen. Virtually all of his experiments since have been made with these..."

Scientific American, May 1938 28

"...on March 16, 1926, at Auburn, he put an improved liquid-fuel rocket into his improvised launching rack and let her go...this was the first actual flight of a liquid-fuel rocket in this country or anywhere in the world... The experimenter timed it with a stop watch and later reported that it fired for two and a half seconds, during which time it flew 184 feet, 'making the speed along the trajectory about 60 miles an hour.' A queer-looking rocket it was, too, compared with the sleek projectiles Dr. Goddard's shop in New Mexico now turns out. The fuel tanks were slender tubes, placed one behind the other. The motor, consisting of the combustion chamber and its exhaust nozzle, was well ahead, supported on spidery arms which also carried the fuel lines. The whole contrivance was about ten feet long, but only about half of this length was actual rocket; the rest was the harness that joined the motor to the tanks. Pressure to force the fuels into the combustion chamber was furnished by an outside pressure tank and, after launching, by an alcohol heater carried on the rocket. The idea of putting the motor ahead of the tanks was the mistaken one that this method of 'pulling' the rocket, instead of pushing it, would make it fly better. In practice it did nothing of the kind; it only added to the difficulties of construction. Dr. Goddard abandoned the design at once in favor of rockets with the motor at the rear. Between 1926 and 1929 he shot a number of these, with varying success..."

Scientific American, May 1938 29



"The first flight with a rocket using liquid propellants was made yesterday at Aunt Effie's farm in Auburn. It looked almost magical as it rose... Some of the surprising things were the absence of smokg, the lack of very loud roar, and smallness of the flame."

-Dr. Goddard's Diary, 3/17/26

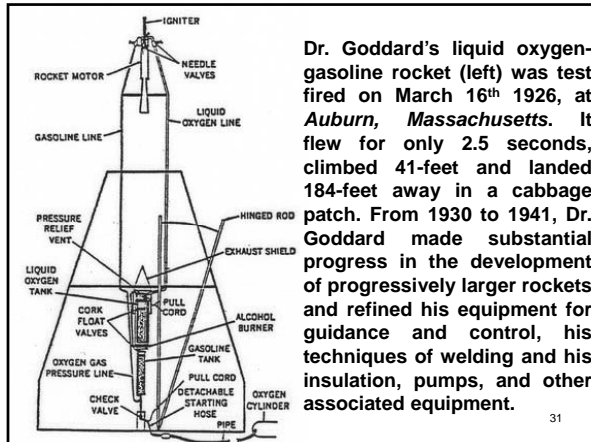

Dr. Goddard's liquid oxygen-gasoline rocket (left) was test fired on March 16th 1926, at Auburn, Massachusetts. It flew for only 2.5 seconds, climbed 41-feet and landed 184-feet away in a cabbage patch. From 1930 to 1941, Dr. Goddard made substantial progress in the development of progressively larger rockets and refined his equipment for guidance and control, his techniques of welding and his insulation, pumps, and other associated equipment.

31

Eyes on the Stratosphere

32

"...As a method of sending a missile to the higher, and even highest, part of the earth's atmospheric envelope, Professor Goddard's multiple-charge rocket is a practicable, and therefore promising device. Such a rocket, too, might carry self-recording instruments, to be released at the limit of its flight, and conceivable parachutes would bring them safely to the ground. It is not obvious, however, that the instruments would return to the point of departure; indeed, it is obvious that they would not, for parachutes drift exactly as balloons do. And the rocket, or what was left of it after the last explosion, would need to be aimed with amazing skill, and in a dead calm, to fall on the spot whence it started. But that is a slight inconvenience, at least from the scientific standpoint, though it might be serious enough from that of the always innocent bystander a few hundred or thousand yards from the firing line...After the rocket quits our air and really starts on its longer journey, its flight would be neither accelerated nor maintained by the explosion of the charges it then might have left. To claim that it would be is to deny a fundamental law of dynamics, and only Dr. Einstein and his chosen dozen, so few and fit, are licensed to do that...That Professor Goddard, with his 'chair' in Clark College and the countenancing of the Smithsonian Institution, does not know the relation of action and reaction, and of the need to have something better than a vacuum against which to react - to say that would be absurd. Of course he only seems to lack the knowledge ladled out daily in high schools..."

The New York Times, January 1920
RE: excerpt from an anonymous editorial concerning a front-page story appearing in the NYT on January 12th 1920 concerning Dr. Goddard's rocket plans

33

"Too much attention has been concentrated on the proposed flash powder experiment, and too little on the exploration of the atmosphere...Whatever interesting possibilities there may be of the method that has been proposed, other than the purpose for which it was intended, no one of them could be undertaken without first exploring the atmosphere."

Dr. R.H. Goddard, January 1920
RE: his rebuttal to the NYT editorial

34

"...The rocket motor used by Dr. Goddard in his New Mexico shots is 5.75 inches in diameter and weighs five pounds. It usually fires about 20 seconds, and delivers a maximum thrust of 289 pounds. Such a motor can hoist a real projectile into the air, and such, indeed, have been the projectiles that Dr. Goddard has been attaching to them. His first New Mexico rocket was shot on December 30, 1930. It was 11 feet long and weighed 33.5 pounds without fuel. It reached an altitude of 2,000 feet, and a maximum speed of 500 miles an hour. This was only the beginning. Heavier, more powerful rockets were to come. In August, 1934, the experimenter shot a pendulum-controlled rocket that made an altitude of 1,000 feet, then turned horizontally for 11,000 feet, landing a little over two miles from the launching tower. At one point its velocity touched 700 miles an hour. In none of these shots was altitude or speed the chief object. The experimenter, having tentatively solved, in order, the problems of fuel, material, methods of feeding the fuel, and aerodynamic design, was by now working on the hardest knot of all - control. Specifically, he was trying to build a rocket that would be capable of sure, dependable upward flight. After 25 years of experiment his eyes were still on the stratosphere..."

Scientific American, May 1938

35



From this tower near Roswell, N. Mex., Dr. R. H. Goddard will send rockets into the atmosphere. Right, the experimenter and assistants with one of the rockets

Above: caption: "From this tower near Roswell, N. Mex., Dr. R.H. Goddard will send rockets into the stratosphere. Right, the experimenter and assistants with one of the rockets" (Popular Science, 1935)

36

"...Now there may be some trick of aerodynamics or design that will guarantee vertical flight without special control mechanisms and the extra complications they entail. Many rocket experimenters hope so, but to date they haven't discovered it. After his early experiences with cantankerous projectiles, wishing through the air at express speed but following whimsical air-paths all their own, Dr. Goddard decided that a gyroscopically-operated control mechanism would have to be devised. In the beginning he tried some other devices, notably the pendulum, but these depend on gravity and are affected by the course and acceleration of the rocket. The gyroscope, however, holds its position with relation to space, regardless of the torque or acceleration of the projectile carrying it. The main problem was to construct a sensitive servo-mechanism that would steer the rocket back on course without disturbing the gyro. Dr. Goddard's idea was to have small vanes pushed into the path of the exhaust gases in such a manner as to deflect the flight. In his first trial the system didn't work as well as expected. The performance led the physicist to suspect that the vanes were too small, and he resolved later to try again with larger ones..."

Scientific American, May 1938

37

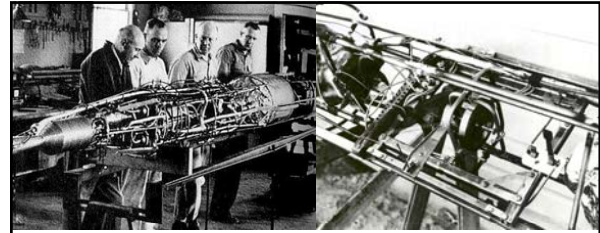

Left: caption: "Goddard Series P Rocket of large fuel capacity, with the rocket motor, pumps, and turbines in view"

Right: caption: "Close-up of Dr. Goddard's gyroscope and associated parts used in the stabilization of the rocket tested April 19th 1932 in New Mexico. The rocket was also painted to show whether revolution about its axis occurred during flight."

38

The Further Unknowns

39

"...The improved system worked better. The vanes, driven by gas pressure into the rocket exhaust stream, were set to apply controlling force when the axis of the projectile deviated as much as 10 degrees from the vertical. The finest shot so far reported with this system reached an altitude of 7,500 feet. Rising slowly from the launching tower, the rocket undulated from side-to-side as the gyro-control continually corrected the course. 'The first few hundred feet of the flight,' reported the experimenter, 'reminded one of a fish swimming in a vertical direction.' After the rocket had gained more speed, the curves smoothed out. Such a flight, of course, is not ideal. Much power is lost in useless undulations. But flight control had at least been started, and the physicist of Worcester could check off one more step in the series of conquests leading to the development of the rocket. Still before him are those problems classified as 'the further unknowns.' One of them is the problem of reducing the weight of the rocket, for every extra ounce requires extra fuel to lift it, and extra fuel to lift the extra fuel, ad infinitum. There are no filling stations on the route to extreme altitudes. The rocket must start with a full tank, and one filling is all it can expect. Other problems are those of improving the efficiency of the rocket motor, which is still far from that which is theoretically expected; improving the aerodynamic design for flight at supersonic velocities; smoother control; and a surer technique for releasing the parachute or other landing apparatus at the exact top of the flight..."

Scientific American, May 1938

40

"In justice it should be said that Dr. Goddard is no longer alone in the colossal task of mastering these difficulties. All over the world, since 1928, rocket societies and rocket experimenters have sprung up, some to make a few tests and drop the subject, others to plow on toward the goal as doggedly as does Dr. Goddard himself. In this country there are at least 20 other active experimenters, and a rocket society that numbers nearly 300 members. In England an experimental group has about 50 members. There are rocket experimenters in Austria, Russia, France, Japan, New Zealand, Canada. The American Rocket Society has an active affiliate at Yale University. Other American universities are considering the establishment of affiliate groups of experimenters among their engineering students and faculties. California experimenters cross the continent to report their work in New York before the Institute of Aeronautical Engineers. Dr. Goddard's work thus may have opened a new era in transportation, for rockets can do more than explore the upper atmosphere. They ultimately may carry mail and goods - and possibly even passengers - with speed rivaling that of the telegraph; usher in an epoch of swift communication more spectacular than that brought by the telephone and airplane; alter once more the complexion of civilization as only basic inventions can alter it."

Scientific American, May 1938

41

"Further investigation and experimentation have confirmed the findings of Isaac Newton in the 17th Century and it is now definitely established that a rocket can function in a vacuum as well as in an atmosphere. The Times regrets the error."

The New York Times

RE: forty-nine years after its editorial mocking Dr. Goddard (January 1920), on July 17th 1969 - the day after the launch of Apollo 11, The New York Times published a short item under the headline "A Correction." Three paragraphs in length, it concluded with this statement. Indeed, Dr. Goddard was correct in his assumption that a rocket engine could/would operate in a vacuum.

42

"Every vision is a joke until the first man accomplishes it; once realized, it becomes commonplace."

Dr. Robert H. Goddard

RE: Dr. Goddard has been recognized as the father of American rocketry and as one of the pioneers in the theoretical exploration of space. *Robert Hutchings Goddard*, born in *Worcester, Massachusetts* on October 5th 1882, was theoretical scientist as well as practical engineer. His dream was the conquest of the upper atmosphere and ultimately space through the use of rocket propulsion. Dr. Goddard died in 1945, but was probably as responsible for the dawning of the "Space Age" as the Wright brothers were for the beginning of the "Air Age." Paradoxically, his work attracted little serious attention during his lifetime. However, when the *United States* began to prepare for the conquest of space in the 1950's, American rocket scientists began to recognize the debt owed to the *New England* professor. They discovered that it was virtually impossible to construct a rocket or launch a satellite without acknowledging the work of Dr. Goddard. More than two-hundred patents (many of which were issued after his death) confirmed his great legacy.

43



44



"Don't you know about your own rocket pioneer? Dr. Goddard was ahead of us all."

Werner von Braun

RE: response when asked about Dr. Goddard's work following WWII

Left: von Braun on the cover of TIME magazine; February 17th 1958

45

The Reality of Tomorrow

46



"It has often proved true that the dream of yesterday is the hope of today and the reality of tomorrow."

Dr. Robert H. Goddard

47

Part 2

Is it Possible?

48

Three Routes

49

Three Routes to SUPERSONIC FLIGHT

THRUST. Like a Fourth of July Skyrocket, thrust-driven devices such as V-2s and the Wac Corporal depend upon the energy of their fuel charge and need no air to sustain them. Rocket speeds range up to 3,500 m.p.h., and this form of power may give man his first taste of supersonic flight.

WINGS. Airborne flight, represented in its simplest form by a child's paper airplane, utilizes aerodynamic forces, created by the action of air upon a wing passing through it, to provide lift. Limited partly by the very wings that sustain them, man-carrying airborne devices have as yet only nibbled at the bottom edge of the sonic barrier.

MOMENTUM. A cannon shell, like a pebble from a boy's slingshot, illustrates momentum-borne flight, in which an object is set in motion by a force greater than its own inertia and then coasts. Momentum plays a part even in the flight of thrust-borne devices after their fuel is exhausted, but true momentum-borne missiles carry no fuel and have no continuing propulsion.

"For millenia man dreamed about flying - and did nothing about it. In 1783 the balloon was invented and people could fly wherever the wind happened to blow them. More than a century later the airplane was invented - and people began to be able to fly where they wanted to go. Now, forty-four years later, man wants to fly faster than sound. He will do it. Aeronautical science is close to this goal; it may take only a year or two. But there are difficulties, and most, of them are tied up with something which is called a Mach number. (The term honors the Austrian physicist Dr. E. Mach, who was one of the first to investigate the problems of air resistance at high speeds.)..."

Mechanix Illustrated, February 1947

51

Ernst Mach's main contribution to physics involved his description and photographs of spark shock-waves and then ballistic shock-waves. He described how when a bullet or shell moved faster than the speed of sound, it created a compression of air in front of it. Using *Schlieren Photography*, he and his son Ludwig were able to photograph the shadows of the invisible shock waves. During the early 1890's, Ludwig was able to invent an *interferometer* which allowed for much clearer photographs.

Left: Ernst Mach (1838-1916)
Above: an Ernst Mach photograph of a bow shockwave around a supersonic bullet, 52 1888

"...The Mach number is a convenient means for expressing an important ratio in one word: it's the relationship between the speed of something - car, airplane, rocket or bullet - and the velocity of sound at the same altitude. This is important, since the velocity of sound is 765 mph at sea level but 100 mph less at 40,000 feet. To say that a plane flies with Mach number 0.5 means that it has just half the velocity of sound at the altitude where it happens to be. Because the velocity of sound decreases as we go up in the air, a plane might have Mach number 0.5 at or near sea level, but Mach number 0.7 at high altitudes. And that is where the difficulties start. When its Mach number approaches 0.7 the air begins to behave differently. Instead of smoothly flowing around the wing it tries to pile up, and at corners and surface irregularities the air gets into its own way, so to speak, and builds into a shock wave; and when the speed (and of course the Mach number) grows large enough there are additional shock waves where the airflow begins to separate from the wings. All this makes for big trouble at trans-sonic speeds..."

Mechanix Illustrated, February 1947

Above: when a jet aircraft travels faster than sound, the air in front of it is no longer moving freely but is "piled up" at high pressure on the front surfaces of the plane. As the aircraft moves through the ether, more and more air piles up in front of it while some escapes to the sides producing shock waves. The air in front of the plane hardly moves (relative to the aircraft), but is in a state of high compression. 53

The pressure buildup in front of the aircraft in supersonic flight is not very deep, a few feet at most.

Compressibility

54

"There are two reasons for our inability to hit the speed of sound with present-day aircraft: First, the lack of power; and, second, a little gadget called a Mach (pronounced mock) number. The second reason is the more important, for it is responsible for the first, and so, let's delve into this Mach business. It is merely for convenience that there is such a thing as a Mach number. It represents the relation of any speed to the speed of sound. For example a Mach number of 0.5 means that the speed so described is 50 percent of the speed of sound. The importance of the Mach numbers is that when an object begins to climb the speed scale up toward the speed of sound, many things can happen; the Mach numbers indicate at what point on this scale various things can be expected. For example, when the Mach number of a plane reaches 0.5 we run into what has been called compressibility..."

Popular Science, October 1944

55

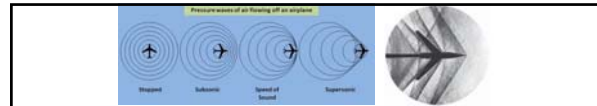

"...Compressibility is that point at which an object begins to make waves in the medium through which it is passing. A boat moves ahead slowly through the water, and no waves appear. It moves faster, and waves begin to stream around it, caused by the hull pushing ahead too fast for the water to part, let the hull pass, and then flow together behind it. There is a critical speed for every object, at which these waves appear. A boat with a sharp prow can reach a higher speed before the waves begin to appear than can a square-prowed barge. Even the latter can move without waves up to a certain speed, for any object moving through a liquid is preceded by a compression wave. This compression wave prepares the medium for the passage of the object causing the wave. In the case of an object such as an aircraft, projectile, or propeller moving through the air, this pressure wave that 'runs interference' for the object moves at the speed of sound. The air entered by the pressure wave is prepared so that it will part and flow about the object and then recombine with the air particles behind..."

Popular Science, October 1944

Above L&R: when an aircraft reaches the speed of sound, the pressure change can no longer be transmitted ahead of the aircraft. Now, it is moving as fast or faster than the gas molecules can be pushed out of the way. There is no longer a pile-up of pressure waves. Instead, they merge into one pressure wave, which travels with the aircraft. The air goes from uncompressed to fully compressed, almost instantaneously, as the aircraft passes. In fact, there are two pressure waves, one from the front of the aircraft and one from the rear (based on design, there may be other, smaller waves generated by points in the aircraft). These pressure waves are the sonic boom. They are close enough together that the double wave may be perceived as a single boom.

56

Shock Stall

57

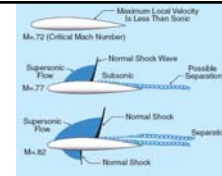

"...An airplane is dependent on airflow, especially the flow around the wings. As long as the speed is low, Mach number 0.5 or less, there is a smooth flow around wings and fuselage; or, rather, it is possible to design wings and fuselage in such a manner that the airflow is not noticeably disturbed. But when the speed goes up, shock waves begin to form, first in corners, then even along the wing, and when the process has gone far enough the airplane just can't fly any more. The formation of shock waves eats up energy which should be used for propulsion. This could be overcome with additional engine power, except for one thing: the shock waves forming on the wings directly destroy the lift of the wings, the wings lose their power to sustain the plane in the air - and the pilot finds himself confronted with 'shock stall'..."

Mechanix Illustrated, February 1947

Above: caption: "Shock wave on upper surface of wing moves rearwards as aircraft Mach increases. As the aircraft's wing approaches its critical Mach number, the aircraft is traveling below Mach 1.0. However, when accelerated airflow over the upper surface of the cambered wing exceeds Mach 1.0, a shock wave is created at the point on the wing where the accelerated airflow returns from supersonic to subsonic airflow. While the air ahead of the shock wave is in laminar flow, a boundary layer separation is created aft of the shock wave, and that section of the wing fails to produce lift."

58

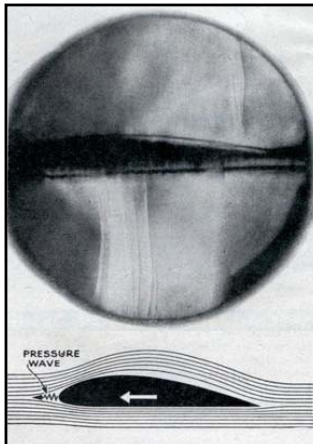

"...We also know that air flowing about any object must speed up and then slow down again to let the object pass. This may be an engine cowl, wing, tail, or cockpit cover. At about a Mach's number of 0.5 in an aircraft's speed, some of the air passing over parts of the plane's surface has already reached a higher Mach number, for it has had to go much faster to get around these parts - although the plane itself has not anywhere near approached the sonic speed..."

Popular Science, October 1944

Left: caption: "Shock waves created when a modern high-speed wing meets an airflow of only 580 m.p.h. are shown by this Schlieren wind-tunnel photograph made by the N.A.C.A. at Langley Field, Va. Note how the waves stand out vertically from the wing surfaces. Sketch below shows the normal flow of air around wing, with pressure wave clearing way."

59

"...Instead of flowing smoothly around the part, the air is smacked against it with such force that waves of compressed and rarefied air in alternate bands are formed at the point of impact. When an object is traveling at the speed of sound, which is also the speed of a compression wave, it is easy to see what this can mean. It is like a football player who cuts ahead of his interference and is tackled. He keeps his feet and tries to drag the tackler along with him. This takes power. Making waves takes power, too, whether in a boat or in the parts of a plane. In fact, it takes such power that a plane can reach a point where it can not go any faster without a staggering increase in power. For example, let's take a plane weighing 10 tons, with an engine of 5,000 hp., flying at a speed of nearly 500 m.p.h. At this speed, the air going over and around parts of the plane has already reached the speed of sound. Waves of compressibility appear in many places on its surface. These waves prevent the plane from going faster, for they need more power to drag them along through the air. We cannot just add another 1,000 hp. and reach 600 m.p.h. We will have to add 37,000 hp. to get that additional 100 m.p.h. This is obviously an impossibility in the case that has been cited. It is not attaining the speed of sound that causes trouble, but the compression waves and resulting turbulence when the air particles have to slow down again after the airfoil has passed. The air passing over the curve of the front of the airfoil starts off at great speed which almost instantly reaches sonic velocity and then runs smack into the slow-speed air in great turbulence behind the wing section. The result is a shock wave at the slow-down point..."

Popular Science, October 1944

60



CONVENTIONAL AIRFOIL
(THICK SECTION - BLUNT LEADING EDGE)

SUGGESTED SUPERSONIC AIRFOILS
(VERY THIN SECTION - SHARP LEADING EDGE)

“...There are figures available for two typical wing sections or airfoils. One is the airfoil type RAF 89; the other is NACA 0012. The former has a thickness of 25 percent of its chord, the latter a thickness of 12 percent of its chord. The former begins to give compressibility trouble at Mach number 0.6; the latter delays it until Mach number 0.75. Wing thickness is therefore very important. The arrangement of the wings seems to be almost as important as their shape. Carefully contrived experiments seem to favor a sweepback which would have been thought ridiculous only a few years ago. Strong taper also seems indicated. As for the leading edge itself, it is well established that it must be sharp...”
Mechanix Illustrated, February 1947

61

“...There is another very important factor. If the plane is fast enough there certainly will be shock waves somewhere, no matter how carefully everything has been designed. Now, a shock wave originating anywhere on the plane is bad enough as a source of energy loss even if it just travels out into the open air, but things get much worse if it can hit another part of the plane. This will not only lead to additional losses but can actually cause structural damage...”
Mechanix Illustrated, February 1947

62

“...If the speed of the wing were less, the air would be able to pass smoothly around it without separating from the surface. Compressibility difficulties are, in general, caused by trying to get too much lift out of a given airfoil at a given speed. The resulting turbulence and loss of lift are the same as if the wing were flying too slowly and stalled. This turbulence does not really stream out behind the wing. It merely remains for a time after the plane has passed, in the manner of dust after a car on a country road, and finally settles back into a state of calm. And, just as some of the dust is carried along with the passing car, some of the air particles are carried along with the plane to add to the general turbulence around the area. The effect on the tail surfaces of the plane is like that on a small boat being towed behind a bigger and faster boat which makes waves that do not fit the hull of the smaller boat. Turbulence resulting from the passage of air through the shock wave about the main wing and fuselage fittings smacks into the tail surfaces, making them inefficient and even subject to damage. A small angle about the cockpit canopy, control-surface hinge, or aerial mast will build up an airflow to a point of compressibility or wave-making air speed, with the result that a shock wave is formed which may cause damage unless the fitting can take the resulting shock...”
Popular Science, October 1944

63

“...The problem for our engineers is to design aircraft and their parts to minimize this shock wave or postpone its formation to a higher Mach number. The general formula seems to be to reverse all streamlining. It is not quite as simple as all that, but it appears that reversed streamlining, with the pointed end foremost, will enable the object to enter the unprepared air with a minimum of shock, which may postpone the forming of the shock wave over the surface...”
Popular Science, October 1944

64

Supersonic Plane?

65

“...Keeping all these problems in mind, the picture of the future trans-sonic and supersonic airplane emerges about as follows: the fuselage will have a circular or near circular cross section and the cross section will be as small as possible. The nose will taper to a sharp point, like the nose of a high-velocity projectile. The wings will be attached relatively far back on the fuselage. They will have a sweepback of about 60 degrees and, in all probability, will be strongly tapered. They will be very thin in cross section, with a ratio between thickness and chord of maybe as little as 6 to 8 percent. The tail assembly will have to be placed in such a manner that it is out of the way of any shock waves that will form in front. Propulsion will be by means of a jet engine or liquid fuel rocket motor, located in the extreme tail end, if at all possible...”
Mechanix Illustrated, February 1947

66

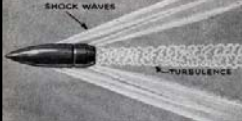

SHOCK WAVES
TURBULENCE

“...So far, supersonic speeds are relatively unknown except in propeller tips and bullets. Bullets, of course, can fly at supersonic speeds, but only for a matter of seconds. They can stand these turbulences, because they are solid structures, perfectly streamlined, and driven by the energy of an outside and left-behind power - gunpowder in explosion. Were it not for the fact that projectiles are primarily designed for penetration rather than for velocity, their shape might indeed be altered for even more speed. In fact, false streamlined noses have been added to certain types of long-range shells to give them higher velocity and added wallop. The smooth skin of the projectile helps, of course. In the same way, butt joints, polished metal surface coverings, and flush riveting on military aircraft help to prevent the air from separating about the surfaces and bursting off in a shock wave. Engineers are working to develop airfoils in which the formation of shock waves will be delayed as much as possible. They have found that, for a given enclosed volume, a body composed of two parabolic arcs causes the minimum of energy to be spent in wave motion. Of course, this would bring the tail right into the middle of the turbulence from the wing - unless the tail was placed ahead of the wing. Then the tail itself would produce a small turbulence to be felt by the wing. This might call for making the plane a flying wing...”
Popular Science, October 1944

Above: caption: “Bullets can travel faster than sound because they are solid metal streamlined shapes and can stand the pressures and shocks they encounter. The higher the speed, the more shock waves slant to the rear.” 67

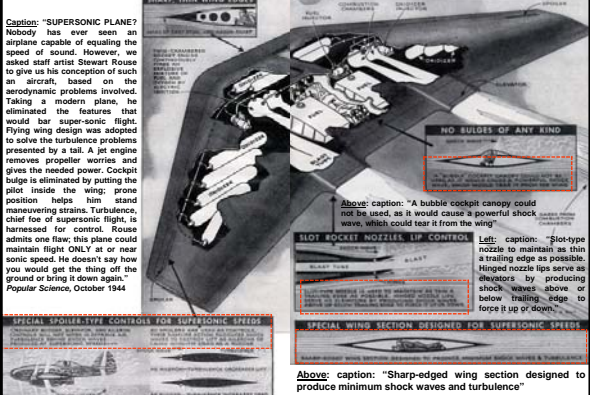

SHARP THIN WING EDGES

NO BULGES OF ANY KIND

SLIT ROCKET NOZZLE TIP CONTROL

SPECIAL WING SECTION DESIGNED FOR SUPersonic SPEEDS

SHARP-EDGED WING SECTION DESIGNED TO PRODUCE MINIMUM SHOCK WAVES AND TURBULENCE

“SUPERSONIC PLANE? Nobody has ever seen an airplane capable of equalling the speed of sound. However, we asked staff artist Stewart Rouse to give us his conception of such an aircraft, based on the aerodynamic problems involved. Taking a modern plane, he eliminated the features that would bar super-sonic flight. Flying wing design was adopted to solve the turbulence problems presented by a tail. A jet engine removes propeller worries and gives the needed power. Cockpit bulge is eliminated by putting the pilot inside the wing; prone position helps him stand maneuvering strains. Turbulence, chief foe of supersonic flight, is harnessed for control. Rouse admits one flaw: this plane could maintain flight ONLY at or near sonic speed. He doesn't say how you would get the thing off the ground or bring it down again.”
Popular Science, October 1944

Above: caption: “A bubble cockpit canopy could not be used, as it would cause a powerful shock wave, which could tear it from the wing.”

Left: caption: “Slit-type nozzle to maintain as thin a trailing edge as possible. Tipped nozzle has serve as elevators by producing shock waves above or below trailing edge to force it up or down.”

Above: caption: “Ordinary rudder, elevator, and aileron controls will not work in extreme air turbulence behind shock waves to destroy lift as ailerons or cause wing-tip drag as a rudder.” 68

Flying Down On The Job

69

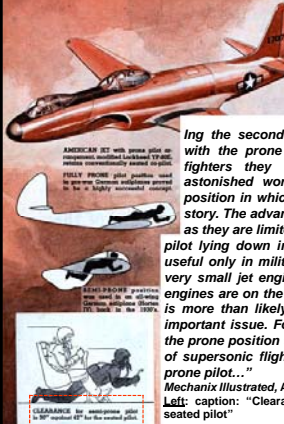

AMERICAN SET with prone pilot in comparison with Lockheed TP-42, which conventionally seated pilot.

SEMI-PRONE position used in the flying Delta 100 (shown in black) for 1939.

“The first airplane to get off the ground back in 1903 was flown by a prone pilot. Originated by the Wright Brothers, the prone pilot position was soon abandoned in favor of the upright seat and was to all intents and purposes a dead issue until the mid-30's. Then the Germans revived the idea in their search for better sailplane performance. During the second World War the Germans again experimented with the prone pilot position - this time in some of the jet fighters they were developing and demonstrating to an astonished world. They also experimented with the supine position in which the pilot lies on his back - but that's another story. The advantages of the prone pilot position are as obvious as they are limited. A much smaller airframe is possible with the pilot lying down instead of seated but this advantage would be useful only in military, racing or aerobatic aircraft, equipped with very small jet engines not yet in production. Several such small engines are on the way and once they are actually in production it is more than likely that the prone pilot position will become an important issue. For aerobatics the prone position is tops and in the prone position the pilot is much less vulnerable to the stresses of supersonic flight. The seated pilot blacks out long before the prone pilot...”
Mechanix Illustrated, April 1957

Left: caption: “Clearance for semi-prone pilot is 30” against 42” for the seated pilot”

“...At present, higher speeds can be made at lower altitudes without shock or compressibility waves being formed. This is possible because the speed of sound is greater at the lower levels. There is a 100-mile difference between sea-level and 35,000 feet. (Above 35,000 it is constant, since the temperature is constant.) This difference will allow a plane at sea level in the neighborhood of 100 m.p.h. more speed before the critical speed at which the compressibility effect and waves begin to form, although at high altitudes this condition may still be encountered around poorly faired cowlings and fittings if the angles are sufficient to step up the air flow about them. The possibility of fitting aircraft designs to the wave patterns formed is being considered, as is also the designing of planes to prevent wave formation. The airfoil needed apparently would have extremely thin entering and leaving edges with gentle curves between, which would require a minimum of air movement to allow its passage. The question now arises, whether such a wing designed for supersonic flight would be useful at less than these speeds. Such an airfoil might be testable in a high-speed wind tunnel, but its ability to provide lift at normal take-off speeds of 100 m.p.h. or less is another matter...”
Popular Science, October 1944

71

Power & Control

72

"...So far, we have very capily ducked the main problem in connection with supersonic flying. That is the matter of control of such an aircraft. The matter of control is a mighty ticklish one at speeds where the slightest movement of any part of the whole produces fantastic pressures and loads as well as more shock waves. Flying at supersonic speeds in straight, level flight is one thing, but maneuvering at these speeds is quite another. It is possible that pressure-changing devices, such as spoilers, will have to be incorporated in the design. It may be that jet impulses will have to be utilized to nudge the aircraft onto another course with gentle pushes against the airflow. No one knows at the present time. As we have mentioned, the power to attain these speeds is another problem. While gravity helps in a terminal-velocity dive (the only way we can now even approach the speed of sound with an aircraft as an entirety), reaching these speeds in level flight with the present power plants seems to be an impossibility..."

Popular Science, October 1944

Terminal Velocity

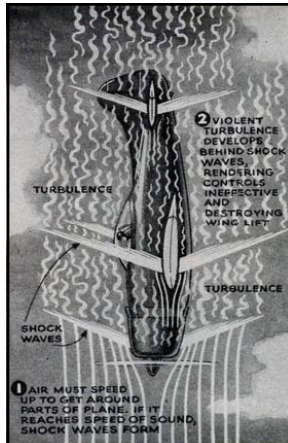

"...Despite glowing newspaper reports, man cannot now fly at the speed of sound. In fact it is doubtful, according to the best authorities, that man has ever closely approached sonic speed (764 m.p.h. at sea level and 664 m.p.h. at 40,000 feet), let alone attain or exceed it. Speeds of over 500 m.p.h. in level flight are a serious challenge to design and power-plant engineers. Even in a terminal-velocity dive (straight down with all stops open), it is doubtful that any pilot has attained the speed of sound..."

Popular Science, October 1944

Left caption: "A plane in a terminal-velocity dive cannot attain the speed of sound. Drag produced by shock wave turbulence holds its speed at a given point usually well below the sonic level. Shock waves also kill wing lift and neutralizes control surfaces." 75

Strength

"...What makes the problem of wing design for a supersonic plane so difficult is that, while the matter of strength is critical, to say the least, there is so very little room for the internal bracing of the thin wing required. There can be no external bracing, for each external brace would add its quota of shock waves. Another difficulty connected with the wing is the question of what it would do at low speeds. It is probable that a wing which has maximum excellence at Mach number 0.7 and higher will be inefficient at Mach number 0.5, and very poor still lower. Every airplane has to spend some time at relatively low speeds - the time taken in takeoff and landing. It may be that the takeoff troubles of a wing which is poor at low speeds will be circumvented by using a jet engine or rocket motor powerful enough to lift the plane and bring it up to speed regardless of poor wing performance - but there would still be the difficulty of landing..."

Mechanix Illustrated, February 1947



"...In addition to power and controllability, we must have strength. Our supersonic aircraft must be able to withstand these tremendous pressures and shock-wave buffeting. The pilot must be adequately protected, for failure of the structure would present him to a 700-m.p.h. air front, which would make bailing out anything but the harmlessly exciting thing it is now. The writer asked one authority what would be the effect on the human body of bailing out at supersonic speeds. The written reply was the one word 'AWFUL!' underlined several times..."

Popular Science, October 1944

Left caption: "Suicide is the word for the pilot who tries to escape from a supersonic plane by parachute. The billowing fabric 'chute' was a wonderful aerial lifesaver - till Air Force pilots started streaking faster than sound in rocket planes like the Bell XS-1. The impact of the air at such speeds is so terrific that it will not only shred the parachute like a burst of shrapnel but also peel the flesh off the pilot's bones. What can science do, then, to rescue the rocket pilot when his craft falls him? Look to the left, at MI artist Frank Tinsley's solution: a pressurized escape capsule with unfolding rotary-wing air brakes to let the flier down to a safe landing on the ground or at sea. The capsule was the pilot's cockpit before he fired a cartridge to blow the unit off to the rear. The idea is based on General Electric's new 'roto-chute' to bail out research instruments from V-2 rockets. Soon, the roto-chute will be bailing out rocket pilots." 78

Mechanix Illustrated, February 1949

Air Friction

79

"Engineers, who sometimes get pretty irritated when writers dream up catch phrases for their scientific findings, are not exactly happy with the term 'Flame Barrier' or 'Heat Barrier' which has been applied to hypersonic flight. (A barrier, say the engineers, is something you can climb over, sneak around or bull your way through. None of these work when an air-breathing, wing-lifted vehicle is trying to go faster and faster in the envelope of air which surrounds the earth). But regardless of what you call it, the obstacle - air friction - is there and gets worse with each extra mile per hour of speed. Eventually you wind up as a glowing ember, blob of molten metal, or a cloud of superheated dust..."

Mechanix Illustrated, October 1955

80



"...Using heat-resistant metals and ceramics, man can probe the front yard of the Flame Barrier. But with known materials he can only go so far. Aluminum melts under continued Mach 5 conditions. (Mach 1 is the speed of sound, approximately 750 mph at sea level. It varies according to the altitude and temperature.) Steel melts at a steadily-maintained Mach 6. Should you get very fancy and build a plane out of blast furnace bricks there would come an unhappy moment when these bricks would vaporize under super-Mach speed..."

Mechanix Illustrated, October 1955

Left: caption: "Carbon rod furnace is used to test heat resistance of metals at NACA's laboratory"

Right: caption: "Solid cone-cylinder, left, and duplicate that was melted by aerodynamic heating"

81

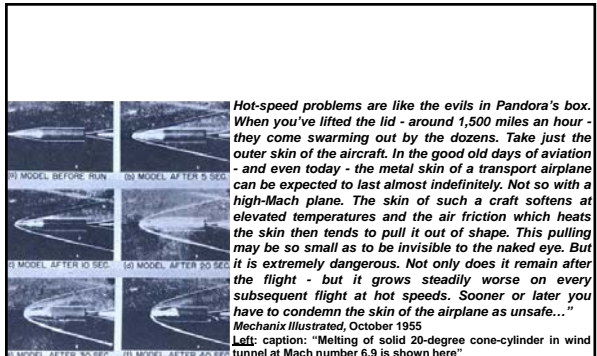

Hot-speed problems are like the evils in Pandora's box. When you've lifted the lid - around 1,500 miles an hour - they come swarming out by the dozens. Take just the outer skin of the aircraft. In the good old days of aviation - and even today - the metal skin of a transport airplane can be expected to last almost indefinitely. Not so with a high-Mach plane. The skin of such a craft softens at elevated temperatures and the air friction which heats the skin then tends to pull it out of shape. This pulling may be so small as to be invisible to the naked eye. But it is extremely dangerous. Not only does it remain after the flight - but it grows steadily worse on every subsequent flight at hot speeds. Sooner or later you have to condemn the skin of the airplane as unsafe..."

Mechanix Illustrated, October 1955

Left: caption: "Melting of solid 20-degree cone-cylinder in wind tunnel at Mach number 6.9 is shown here"

82

Thermal Buckling

83

"...Not only must you condemn the skin, the internal bracings are also affected by heat which has been transferred through the airplane's skin and have been weakened by the 'thermal buckling.' Imagine a column of metal fastened between two rigid surfaces. Heat it...it wants to elongate and can't...and so it does the only other thing - it buckles. A very little 'thermal buckling' inside a wing can render that wing unsafe for flight..."

Mechanix Illustrated, October 1955

84

Power Plant

85

"...Power plants for high-Mach flight will eventually be rockets. Turbojet engines - notably the Pratt and Whitney J-57, an improved version of which is said to develop 16,000 pounds of thrust with afterburner on - have several limiting features. One of them is the inability of the high-speed turbines to withstand the heat. Another is size, fuel and weight limitations. If you build a turbojet engine big enough and powerful enough to push an airplane up to 3,000 miles an hour, the airplane becomes enormous. Worse than that, you have to carry so much fuel there's no room for payload. The whole operation becomes impractical. A ramjet engine is a better bet in some ways but it, too, has drawbacks..."

Mechanix Illustrated, October 1955

86

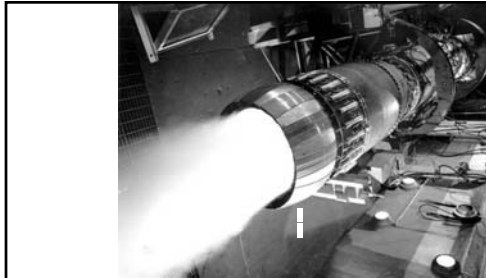

Above: caption: "A J-57 engine, shown here during testing, is capable of developing more than 10,000 pounds of thrust. More than 4,000 of the axial-flow jet engines have been built and now power several of the nation's first line fighter planes including the Air Force's F-100 and F-101, the F-102A and the Navy's F-4D and F8U shipboard fighters. The J-57 has powered more aircraft faster than the speed of sound in level flight than all the other jet engines in the Western world. Eight J-57s power the huge global bomber, the B-52. In the commercial field the J-57, along with Pratt & Whitney Aircraft J-75 will power the giant passenger jet transports now being built by Boeing and Douglas."

87

"...Rockets, which will work without any outside atmosphere, have many advantages. Bell Aircraft Company has done a great deal of research on rocket motors and has come up with an aluminum-alloy job which can be built quickly and cheaply out of standard alloys and uses a relatively plentiful and cheap type of rocket fuel - acid and standard JP-4 jet fuel. The Bell package has made runs of 10 minutes duration and some motors have logged an hour on power - which is a ripe old age for a rocket motor in any league. Bell can handle engines with 50,000 pounds of thrust in their laboratories at the moment - and 100,000 pound-thrust engines may be possible in this lab in the not too distant future. Rocket engines are admittedly hard to control. The best way at present seems to be to install four or five of them and use one at a time, as needed, conserving the rest. The thrust per pound of weight is fantastically good in a rocket - which is one of the main reasons why their future seems so bright in high-Mach flight. Bell experimental rocket planes have been flying for years at Muroc, where they have a tremendously long natural runway for power-off landings. Since it will not be possible to have these long runways commercially, some way must be found to shorten the landing roll of the rocket planes..."

Mechanix Illustrated, October 1955

88



Above: Bell XP-59A (left) and P-59A (right) at Muroc Dry Lake, CA (ca. 1944). The P-59A was the first U.S. jet fighter. In December 1949, Muroc Dry Lake was renamed "Edwards Air Force Base" in honor of Captain Glen W. Edwards, who was killed a year earlier in the crash of the Northrop YB-49 Flying Wing (at left, taking off for the first time at Muroc on October 21st 1947)

89

Stagnation Points

90



“...Sleek configuration of airplanes, with a minimum of knobs, fillets and other ‘stagnation points’ is a must in hot speed flight. Tests have shown that burbling air is many times hotter than air which slides smoothly over the surface of the plane like a coat of invisible skin. Flying Saucers may not be real but they are certainly the best theoretical shape for really high speeds. The hottest spots on current airplanes are places where the air rams the airplane head-on - leading edges of wings, tail surfaces, fuselage nose, air-scoops and the like. At tremendous speeds the plane backs air up well out in front of it - like a snowplow pushing a heavy drift - and the proof of this is the very long hypodermic-like needle which thrusts out of many high speed planes. It’s the tube for the air-speed indicator - and has to be long so it can pick up smooth non-turbulent air...”

Mechanix Illustrated, October 1955

Above: caption: “Minneapolis-Honeywell’s test chamber can simulate the effects of heat and height”

91

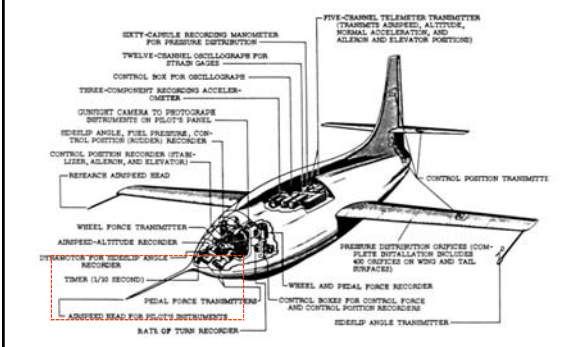

Above: caption: “NACA Research Instrumentation in XS-1 Rocket Airplane.” The “hypodermic-like needle” Airspeed Read for Pilot’s Instruments (extending from the nose) is highlighted.

92

“...Materials of construction are, of course, more critical than ever before. Some aluminum alloys now used in airframe construction begin to lose strength at 200° F., which is so low on the hot-speed scale as to be almost cool. A whole new set of heat-resistant alloys is currently being developed: thermanol, stainless steel, zirconium and a combination of the two, known as ‘cermets,’ and finally intermetallics - chemical combinations of metals. Titanium, so far, seems to be getting the nod from a number of the big companies supplying the Air Force with supersonic fighters and bombers. Titanium holds its efficiency pretty well up to 800° F. This is about the skin temperature of a missile flying 6,900 mph at 200,000 feet where rocket power would be absolutely necessary due to lack of oxygen. The Air Force speaks guardedly of a metal they call ‘three per cent manganese complex’ which has a strength of 200,000 pounds per square inch after heat treatment...”



Mechanix Illustrated, October 1955

Above: caption: “Republic’s Thunderflash is one of the first AF planes to use parts of titanium”

93

Range Trading

94



“...Cooling the airplane’s structure and skin are, of course, only part of the problem. Everything in a high-Mach airplane has to be cooled...The tubes in the radio have to be cooled. The pilot and passengers have to be cooled. The servo motors, the hydraulics systems, the oil lubricants, the wiring, the fuel lines - items by the hundreds - all have to be cooled. Some crazy things happen when the Mach numbers start rising. At Mach 2 - 1,500 miles an hour - a bomber at 40,000 feet would lose about 18 per cent of its hydrocarbon fuel due to evaporation - unless the fuel tanks were pressurized and insulated. With a layer of Fiberglas around the tanks and with four or five pounds per square inch pressure, the evaporation loss would be negligible. You have to pay your money and take your choice: 1. lose fuel by evaporation; 2. add weight with pressurizing equipment and insulation and save fuel. Whichever way will get you farthest for the least, you use. It’s called ‘range trading.’...”

Mechanix Illustrated, October 1955

Above: caption: “Ventilated flying suits are now under development to keep pilot cool⁹⁵ at high Mach speeds. This model circulates cool air and records body changes in flight.”

95

The Big Question Mark

96

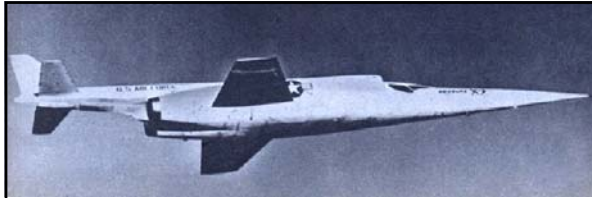

"...Insulation is the big question mark in high-Mach design at the moment. Fiberglas is great if you can put it under some outer covering so it won't be blown away. But you can't attach Fiberglas all over the outside of a high-Mach plane and expect to find any of it when you land. Unfortunately, to do any good the insulation must be outside where all the wind pressure is, and heat-transfer begins...To show you how important such insulation is, a Mach 0.5 airplane - without insulation - would have to use 25 per cent of its power to keep cool. Wrap that same plane with the equivalent of one inch of Fiberglas and it would need only two per cent of its power for cooling purposes!..."

Mechanix Illustrated, October 1955

Above: caption: "Tremendous heat generated at supersonic speeds poses problems in the latest high-speed aircraft like the needle-nosed Douglas X-3"

"...All sorts of elaborate coolers have been developed already and more can confidentially be expected. These coolers go into multi-stage step-downs, with each section of the unit knocking so many degrees out of the air until it finally gets down to usable temperature. Good old water, after long experiment, seems to be the best coolant for hot speed flight. One plan is to perforate the fuselage with many tiny pinholes and sweat the water out through the airplane's skin, the way water is released through the pores of the human body. Although this might seem fantastic, it is really quite practical and considerable research is going into it..."

Mechanix Illustrated, October 1955

98

Flying High

99

"...The most practical 'out,' however, is to sneak around the edge of the Hot Wall as much as possible, instead of barreling straight into it. By flying high, where the air is thin, the friction of the molecules of air against the skin of the airplane can be greatly reduced. By staying at high speed only a short time and not giving the friction a chance to hotsoak the airplane too much, heat tolerances can be held within acceptable limits. This seems to be the way high-Mach flight will be approached as far as civilian transport service is concerned. It would obviously have drawbacks in military maneuvers, since you couldn't very well stop fighting with somebody simply because you were getting too hot..."

Mechanix Illustrated, October 1955

100

Proceed Cautiously

101

"...Now that we are at the beginning of a new phase in the conquest of the air, we must proceed cautiously. We are entering an entirely new field of exploration - a field in which tragedy may await the unwary. Undoubtedly, there will be occasional unpremeditated forays into this unknown territory, and it will be up to the men who make them to add to the general fund of knowledge through careful analysis of their experiences. One by one the small barriers will be removed, so that the whole picture of supersonic flight will become clearer. Eventually, we shall be able to travel at speeds that now seem eternally impossible - just as present-day speeds might have seemed to the Wright brothers."

Popular Science, October 1944

102

"...Man will no doubt get his wish of flying faster than sound. We already recognize many of the difficulties between us and that goal. We no longer think them insurmountable, but there's no doubt that they are big..."
Mechanix Illustrated, February 1947

103

"...One thing is sure: high-Mach flight is coming in fast...It may well be possible, in our lifetime, to step casually into a rocket ship in San Francisco, hurtle eastward at 3,000 mph at 200,000 ft. altitude, and step out in the city of New York barely an hour later. And if we solve the problems of the Heat Barrier, you won't even raise a sweat!"
Mechanix Illustrated, October 1955

104

Part 3

The Need for Speed

105

Meteors & Komets

106

"...At Mach numbers of 0.65 or less (about 500 mph or less) airplanes are said to fly at subsonic speeds. At Mach numbers of 1.3 or higher (say, 1,000 mph and up) they are said to fly at supersonic speeds. The interval between the two is called trans-sonic...The fastest planes are already in the lower reaches of that range. The Mustang and a few other propeller-driven fighters had Mach number 0.6. The jet planes hit Mach 0.7 and the British 'Meteor' and the German 'Komet' (Me-163) got to Mach 0.8..."
Mechanix Illustrated, February 1947

107

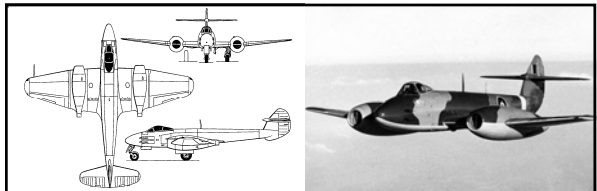

The *Gloster Meteor* (above L&R) was the first British jet fighter and the Allies first operational jet aircraft during. The Meteor's development was heavily reliant on its ground-breaking "turbojet engine." Development of the aircraft began in 1940 while work on the engines had begun in 1936. The Meteor first flew in 1943 and commenced operations on July 27th 1944. Although the Meteor was not an aerodynamically advanced aircraft, it proved to be a successful and effective combat fighter. The *Meteor F-1* was powered by two *Rolls-Royce "Welland"* turbojet engines producing 1,700 foot-pounds of thrust each, giving the aircraft a maximum speed of 417 mph. The *Meteor F-4* went into production in 1946 with *Rolls-Royce "Derwent 5"* engines and was 170 mph faster than the *F-1* at sea level (585 mph against 415 mph). Several major variants of the Meteor were made to incorporate technological advances during the 1940's and '50's. Thousands of Meteors were built to serve in the RAF and other air forces around the world and remained in use for several decades. 108

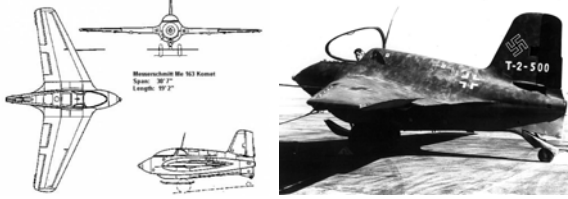

"German aeronautical engineering was much further advanced than our own at the end of the war in spite of that country's defeat. The Me-163 was the world's first successful rocket plane and it saw service against our bombers over Europe..."
Mechanix Illustrated, February 1946

RE: the Messerschmitt Me-163 "Komet" (above L&R) was the Luftwaffe's only rocket-powered fighter plane operational during WWII. Its design was revolutionary and the Me-163 was capable of performance unrivaled at the time. In July 1944, it reached 700 mph, not broken in terms of absolute speed until November 1947. Over three-hundred were built, however, the Komet proved ineffective as a fighter having been responsible for the destruction of only about nine Allied aircraft (ten were lost in combat).¹⁰⁹

Caption: "Germany's ME-163B fighter, was only a rumor when MI commissioned their staff artists to do drawing below that appeared in May, 1945, issue. Photo of real plane was recently released."

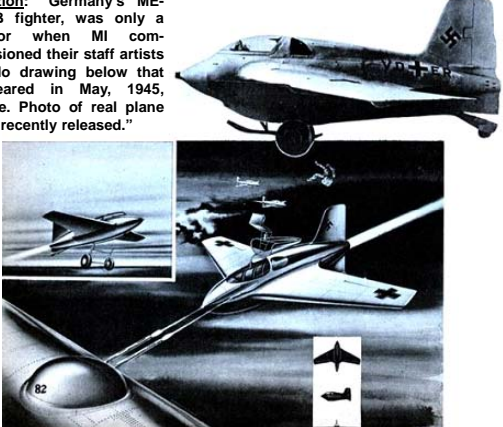

10

First Supersonic Fighter

111

"...Recently it has been revealed that to Germany, also, must go credit for developing the world's first supersonic fighter, the Jaeger P-13, which was under hurried construction before VE day. Had this plane been used early enough, the war may have continued many months longer, and might even have meant Nazi mastery of the skies over the Continent..."
Mechanix Illustrated, February 1946

112

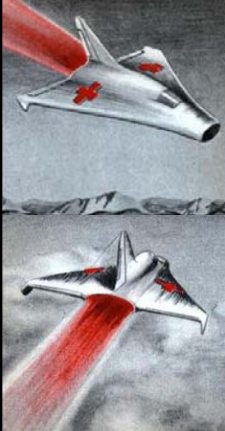

"...Powered by a revolutionary and advanced Lorin type ram-jet unit, a wind tunnel model had been tested and the prototype under construction when Nazi military might crumbled. Unlike any other fighter or aircraft in appearance, it was an all-wing design, with an extremely sharp taper commencing at the wing roots. A horizontal oval air duct provided the intake scoop at the machine's nose. Simplest and most efficient of all jet turbine designs, the ram-jet (or athodyd) powerplant uses the forward speed of the craft to produce air compression, therefore increasing in efficiency as the velocity increases. The only protuberances of the machine were the single vertical fin and rudder, and a very low, streamlined cockpit canopy which flowed into the fuselage-wing contours. The cockpit was directly aft of the nose-intake duct, and had a very slight and rounded turtleback to the vertical fin. Wingtips were turned down vertically; this seemed to add a substantial degree of stability. The Germans succeeded in discovering the solution to compressibility, something that has baffled our designers constantly with 500 mph-plus aircraft. Apparently a razor-sharp leading edge for the wing is not the answer. The 550-mph rocket-propelled 8-263 and Me-163B fighters were the first machines to utilize the German concept, an airfoil section with an unusually sharp sweep-back of entire airfoil and controls..."¹¹³
Mechanix Illustrated, February 1946

Left T&B: caption: "Jaeger P-13 claimed to fly +1,500 mph"

Triebflügel Flugzeug

114

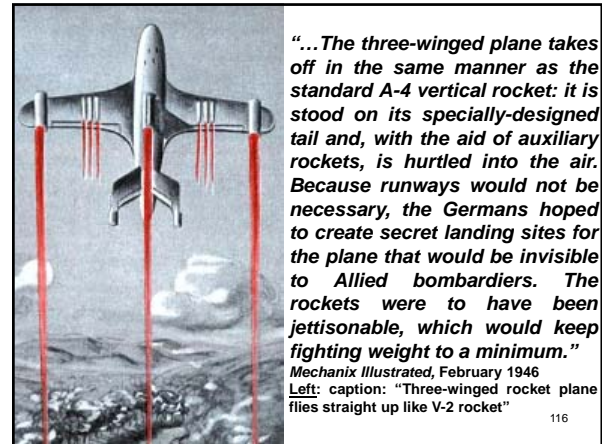
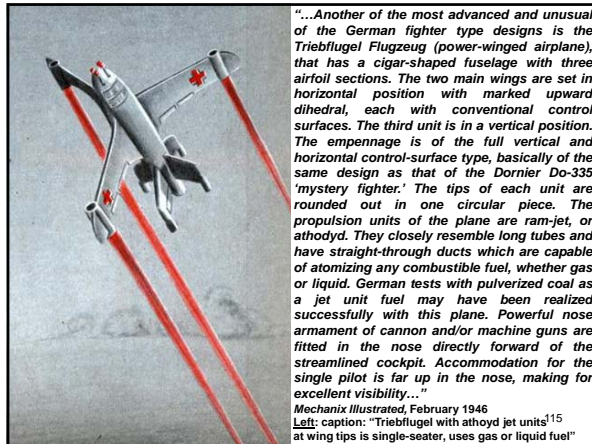

Research & Development

117

“...Until the advent of jet power, the speed of aircraft was always restricted by engine limitations. Today, for the first time, engine thrust has exceeded the ability of our airplanes to handle it. We have the power to drive airplanes into speeds beyond our knowledge of aerodynamics and construction to build them. Moreover, we stand only at the threshold of jet development. As new, tougher and more heat-resistant materials are developed – particularly for the turbine blades of jets – and as better cooling methods are discovered – power will increase beyond anything we have today...The new jet planes break down into four groups: trans-sonic research planes, jet fighters, jet bombers, and propeller-jet combinations in a variety of forms...”

FLYING magazine, December 1948

118

“...A comprehensive sonic research program is underway by the National Advisory Committee for Aeronautics in cooperation with the Air Force and the Navy Bureau of Aeronautics. Both rocket planes and turbo-jet planes have been and are being developed in collaboration with manufacturers and the services. Their purpose is to explore the still largely unknown trans-sonic and supersonic speed zones...”

FLYING magazine, December 1948

119

“...Three planes are already underway with this program. They are the Bell X-1, which has already flown faster than sound, the Douglas D-558-1 turbo-jet propelled ‘Skystreak,’ which may have breached the sonic barrier, and the Douglas D-558-2 ‘Skyrocket,’ propelled by a combination of turbo-jet and rocket power. The X-1 and the D-558-1 are exploring the trans-sonic zone. The Bell X-2 and the Douglas D-558-2, both with swept-back wings, will investigate the higher trans-sonic speeds, along with the Northrop X-4, a flying-wing version. The Douglas X-3 apparently has not yet been completed but is intended to investigate the high sub-sonic speed ranges and get well into supersonic speeds...”

FLYING magazine, December 1948

120

The Ugh-Known

121

"...with the XS-1, later shortened to X-1, we were flying through uncharted territory, the 'ugh-known' as we liked to call it. And as ominous as it seemed to us then, that was the whole point. America was at war with Germany and Japan in December 1943 when a conference was called at the fledgling National Advisory Committee for Aeronautics (NACA, NASA's forerunner) in Washington. The subject was how to provide aerospace companies with better information on high-speed flight in order to improve aircraft design. A full-scale, high-speed aircraft was proposed that would help investigate compressibility and control problems, powerplant issues and the effects of higher Mach and Reynolds numbers. It was thought that a full-scale airplane with a trained pilot at the controls would yield more accurate data than could be obtained in a wind tunnel. And, following the English experience with early air-breathing jet propulsion, the notion of using a conventional jet powerplant was advanced. Discussions continued through 1944, but winning the war was first on everyone's agenda. It wasn't until March of 1945, with the war drawing to a close, that the project picked up momentum. Researchers concluded, however, that jet engines of the period weren't powerful enough to achieve the required speeds. Rocket propulsion was explored - specifically, a turbo-pump-equipped rocket made by Reaction Motors Inc. Delivering 6,000 pounds of thrust, the acid-aniline-fueled engine was believed to be capable of boosting an airplane to the fringes of the known performance envelope..."

General Charles "Chuck" Yeager, 1997

122

Higher air-speeds brought about problems. Even the faster piston-engine fighters sometimes ran into trouble during high-speed dives, losing their wings or tails for no apparent reason. Designers knew that their enemy was the invisible, seemingly harmless air which became so compressed by the speeding aircraft that it formed shock-waves that hammered the structure until it broke up. By sweeping back the wings of their aircraft and making them thinner, designers managed to delay the shock-wave effects and gain a few extra precious mph; but many experts doubted that airplanes would ever be able to fly above the speed of sound and newspapers began to write about the "sound barrier." To discover if a specially-designed aircraft with a very powerful engine would be able to penetrate the barrier, the British government ordered a bullet shaped research monoplane from the Miles Company, but got cold feet and the project was cancelled. In the United States, work continued on a small rocket powered research aircraft known as the Bell XS-1 (later "X-1"), intended for a similar purpose. U.S. Air Force test pilot Chuck Yeager had no illusions about the hazards confronting him. Everything about the program was unusual, more akin to science fiction. To conserve fuel, it was necessary to drop the X-1 from a converted B-29 bomber - the "Fertile Myrtle," at a height of around 30K-feet, instead of taking off normally. Each time Yeager flew the X-1, he approached a little nearer to the speed of sound. Eventually he reached a speed of Mach 0.94 (94 per cent of the speed of sound) and felt the aircraft bucking under the hammer blows of shock waves that would have smashed anything else in the air at that time. But he had complete confidence in the X-1's aerodynamic design and high-strength aluminum airframe.

123

"...It was to be unlike any other airplane designed up to that day. The Germans had experimented with rocket planes in the waning days of the war. The ME-163, with its HWK 509C engine, was credited with a top speed of around 600 mph. (The ME-262, with two jet engines, was clocked at 527 mph.) But the Bell X-1 would be far superior - with a clean, aerodynamic profile that whispered 'power' even while dormant on the tarmac. The nose was shaped like a .50-cal. bullet, and its high-strength-aluminum fuselage stood a mere 10.85 ft. high and 30.9 ft. long. Wingspan was 28 ft. and wing area was 130 sq. ft. Launch weight was 12,250 pounds. Landing configuration was close to 7,000 pounds. Packed inside the X-1's diminutive frame were two steel propellant tanks, 12 nitrogen spheres for fuel and cabin pressurization, three pressure regulators, retractable landing gear, the wing carry-through structure, the Reaction Motors engine, more than 500 pounds of special flight test instrumentation, and a pressurized pilot's cockpit. Performance penalties, fuel limits and safety concerns dictated an air launch by a specially modified B-29. (However, I did make a successful ground takeoff on Jan. 5, 1949)..."

General Charles "Chuck" Yeager, 1997

124

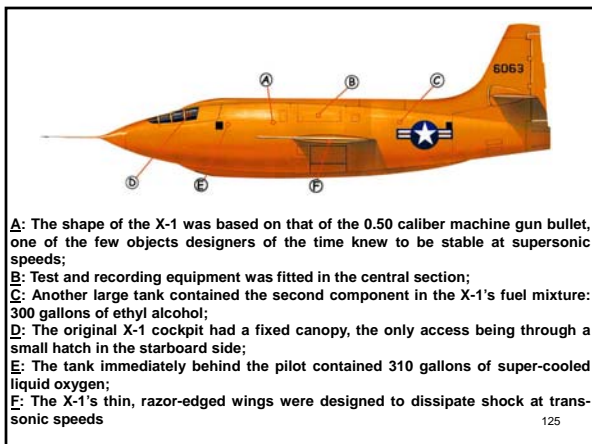

125

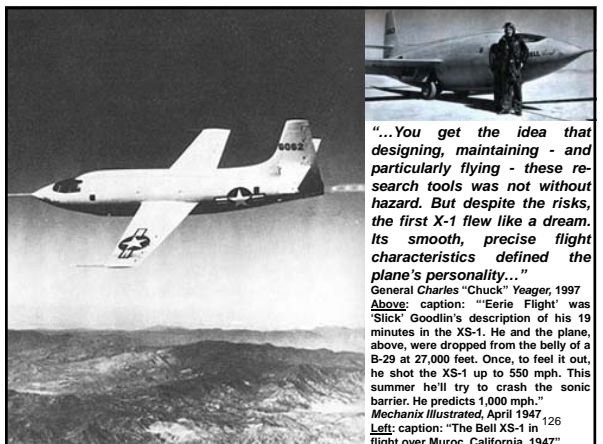

"After pilot entry in the usual fashion at 7,000 ft., the XS-1 was dropped from the B-29 at 20,000 ft. and at 260 mph indicated airspeed...Immediately after the drop, all cylinders were started in rapid sequence, and with all four in operation it was noted that No. 1 and No. 3 had 210-psi chamber pressure, No. 2 and No. 4 having 220 psi, with approximately 290-psi LOX and fuel line pressure...The climb was made at .85 to .88 Mach until 40,000 ft. was reached..."

RE: excerpt from Chuck Yeager's pilots' log after an X-1 flight on October 10th 1947

127

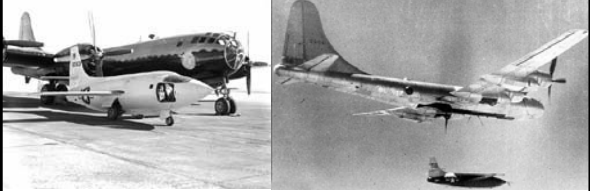

"...The drop itself was the next big obstacle, and like entering the bird, it's something that I never really got used to. During preflight checks, I'd practice neutralizing the controls and brace myself for the release. Cardenas would go through the countdown, finishing with an emphatic 'Drop!' The X-1 would float from the B-29 and I'd get launched right up to the cockpit overhead, caressing the canopy with my helmet in the sudden swell of microgravity. My heart was in my mouth, stomach right behind it..."

General Charles "Chuck" Yeager, 1997

RE: the Bell X-1 rocket plane was designed specifically for research in the trans-sonic speed range. Aircraft of the period, including F-80 and F-84 Jets, were limited to Mach numbers near 0.8-0.85 and could reach these speeds only in hazardous dives. In reaching subsonic speeds, these aircraft were virtually uncontrollable making it desirable to build a research aircraft which would be slowed merely by cutting the engine. Advanced X-1 series planes emphasized research in such areas as aerodynamic heating, pilot reaction control systems and problems of supersonic flight. Originally designated "XS-1" (for "Experimental Sonic") the Bell X-1 was a joint N.A.C.A. - U.S. Air Force supersonic research project. The Air Force took over the flight test program from the contractor on July 27th 1947 and, although data accumulated during the first few flights indicated that the X-1 could not break the sound barrier, on October 14th 1947 - with test pilot Chuck Yeager at the controls, the X-1 was the first aircraft to exceed the speed of sound in controlled, level flight. Though originally designed for conventional ground takeoffs, nearly all X-1 test flights were air-launched from a modified Boeing B-29 Superfortress bomber (above L&R). 128

"...Everything was set inside X-1 as Cardenas started the countdown. Frost assumed his position and the mighty crack from the cable release hurled the X-1 into the abyss. I fired chamber No. 4, then No. 2, then shut off No. 4 and fired No. 3, then shut off No. 2 and fired No. 1. The X-1 began racing toward the heavens, leaving the B-29 and the P-80 far behind. I then ignited chambers No. 2 and No. 4, and under a full 6,000 pounds of thrust, the little rocket plane accelerated instantly, leaving a contrail of fire and exhaust. From .83 Mach to .92 Mach, I was busily engaged testing stabilizer effectiveness. The rudder and elevator lost their grip on the thinning air, but the stabilizer still proved effective, even as speed increased to .95 Mach. At 35,000 ft., I shut down two of the chambers and continued to climb on the remaining two. We were really hauling! I was excited and pleased, but the flight report I later filed maintained that outward cool: 'With the stabilizer setting at 2 degrees, the speed was allowed to increase to approximately .95 to .96 Mach number. The airplane was allowed to continue to accelerate until an indication of .965 on the cockpit Machmeter was obtained. At this indication, the meter momentarily stopped and then jumped up to 1.06, and the hesitation was assumed to be caused by the effect of shock waves on the static source. I had flown at supersonic speeds for 18 seconds.' There was no buffet, no jolt, no shock. Above all, no brick wall to smash into. I was alive..."

General Charles "Chuck" Yeager, 1997

RE: the ninth X-1 flight of October 14th 1947, achieving a speed of Mach 1.06, breaking the sound barrier for the first time

129

"In flight 9, the pilot started a four-cylinder climb at 20,000 feet; as he approached 30,000 feet, he shut down two cylinders. The climb continued to 42,000 feet. As the altitude and mach number increased, the pilot move the stabilizer at Mach numbers of 0.83, 0.84, 0.88, and 0.92. At the top of the climb, the pilot turned on a third cylinder and pushed the nose down a little; a rate of descent of about 500 feet was noted. The airplane then accelerated to a Mach number of 0.98. At this mach number, the needle of the mach meter took an abrupt jump past M=1.0 and went against the peg, which is a distance equal to about 0.05 in Mach number past 1.0. The pilot reported that the elevator seemed more effective at this speed than at M=0.94 to 0.95. Aileron control appeared good throughout the speed range. The pilot reported no buffeting beyond an indicated mach number of 0.92. he did report that the right wing dropped between an indicated Mach number of 0.88 and 0.90, as in previous flights. When the Mach number went off the scale, the pilot shut down all cylinders and jettisoned fuel in a climb. At 45,000 feet, an unaccelerated stall was made which appeared normal to the pilot. The descent from 45,000 to 35,000 feet was made at a Mach number of 0.7 so that a pressure altitude survey could be made. Preliminary NACA data work-up indicates that a Mach number of 1.06 was reached, taken in account the calibrated error in static pressure and assuming no error in total-head. Evaluation of all data from these flights is in progress and preliminary data will be issued..."

RE: excerpt from the NACA Langley Laboratory report of X-1's October 14th 1947 flight which surpassed Mach 1 for the first time in aviation history

130

"...And although it was never entered in the pilot report, the casualness of invading a piece of space no man had ever visited was best reflected in the radio chatter. I had to tell somebody, anybody, that we'd busted straight through the sound barrier. But transmissions were restricted. 'Hey Ridley!' I called. 'Make another note. There's something wrong with this Machmeter. It's gone completely screwy!' 'If it is, we'll fix it,' Ridley replied, catching my drift. 'But personally, I think you're seeing things.'"

General Charles "Chuck" Yeager, 1997

131

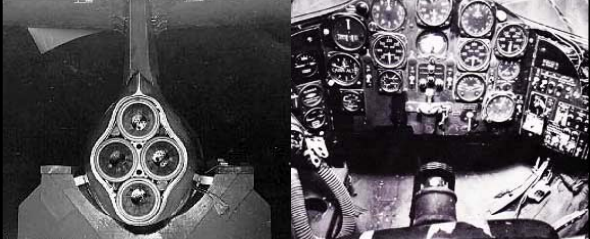

The Bell X-1 used its rocket engine to climb to its test altitude where it reached a speed of 700 mph; Mach 1.06, at an altitude of 43K-feet. This was the highest velocity and altitude reached by a manned airplane up to that time. The bullet-shaped X-1 was propelled by a four-chambered, liquid-fueled rocket engine. The maximum speed attained by the X-1 was Mach 1.45 (at 40,130-feet), approximately 957 mph, during a flight on March 26th 1948. On August 8th 1949, X-1 reached an altitude of 71,902-feet, the highest flight made by X-1. It continued flight test operations until mid-1950, by which time it had completed a total of nineteen contractor demonstration flights and fifty-nine Air Force test flights.

Left: aft-end of the X-1
Right: cockpit of the X-1

132

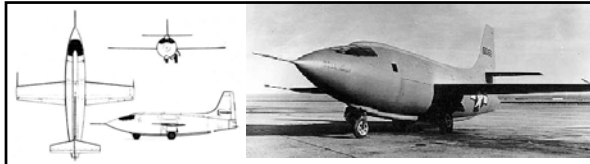

The smooth contours of the *Bell X-1* (above L&R) masked an extremely crowded fuselage containing two propellant tanks, twelve nitrogen spheres for fuel and cabin pressurization, the pilot's pressurized cockpit, three pressure regulators, retractable landing gear, the wing carry-through structure, a *Reaction Motors* 6K-pound-thrust rocket engine and more than five hundred pounds of special flight-test instrumentation. Many important structural and aerodynamic advances were first employed in the X-1, including extremely thin yet exceptionally strong wing sections and a horizontal stabilizer that could be adjusted up and down to improve control, especially at trans-sonic speeds. There were three X-1's built with the designations: X-1-1, X-1-2 and X-1-3, that were flown by eighteen pilots from 1946 to 1951. X-1-2 went to the N.A.C.A. and, after testing and modernizing in 1951, was re-designated the X-1E in 1954. X-1-3 was destroyed by an explosion on November 9th 1951 during contractor flight testing. The X-1 series became the first aircraft to provide data on control, stability, buffeting, and other aerodynamic phenomena associated with trans-sonic and supersonic flight.

133



"To John Stack, Research Scientist, NACA, for pioneering research to determine the physical laws affecting supersonic flight, and for his conception of transonic research airplanes; to Lawrence D. Bell, President Bell Aircraft Corporation, for the design and construction of the special research airplane X-1; and to Captain Charles E. Yeager, U.S. Air Force, who, with that airplane, on October 14, 1947, first achieved human flight faster than sound."

RE: NAA award citation. In December 1948, the *National Aeronautic Association* selected Bell Aircraft President *Lawrence D. Bell* (middle), N.A.C.A. Langley Laboratory scientist *John Stack* (left) and Air Force test pilot *Charles "Chuck" Yeager* (right) to receive the 1947 award of the *Robert J. Collier Trophy*, the association's annual prize for the greatest achievement in American aviation, for their roles exceeding the speed of sound for the first time and opening the pathway to practical supersonic flight. In a ceremony at the *White House*, POTUS *Harry S. Truman* presented the award citation to the recipients.

134



"Marked the end of the first great period of the air age, and the beginning of the second. In a few moments the subsonic period became history and the supersonic period was born."

General *Hoyt Vandenberg*, U.S. Air Force Chief of Staff
 RE: on August 26th 1950, General Vandenberg presented the X-1-1 to *Alexander Wetmore*, then Secretary of the *Smithsonian Institution*. The X-1-1 is owned by the *Smithsonian Institution's National Air and Space Museum* where it is on permanent display (above).

135



"The joke was on me. It was just after sunup on the morning of Oct. 14, 1947, and as I walked into the hangar at Muroc Army Air Base in the California high desert, the X-1 team presented me with a big raw carrot, a pair of glasses and a length of rope. The gifts were a whimsical allusion to a disagreement I'd had the previous evening with a horse. The horse won. I broke two ribs. And now, as iridescent fingers of sunlight gripped the eastern mountain rims, we made ready to take a stab at cracking the sound barrier - up until that point aviation's biggest hurdle. The Bell XS-1 No. 1 streaked past the speed of sound that morning without too much fanfare - broken ribs not withstanding. And when the Mach indicator stuttered off the scale barely five minutes after the drop from our mother B-29, America entered the second great age of aviation development. We'd fly higher and faster in the XS-1 No. 1 in later months and years. Its sister ships would acquit themselves ably as the newly formed U.S. Air Force continued to investigate the effects of higher Mach numbers." And Edwards Air Force Base, formerly known as Muroc Army Air Base, would witness remarkable strides in supersonic and even trans-atmospheric flight."

136

Specifications
 Length: 31-feet
 Wingspan: 22-feet 10-inches
 Height: 10-feet 10-inches
 Wing area: 115 square feet
 Empty weight: 6,850 lbs.
 Loaded weight: 14,750 lbs.
 Powerplant: 1x Reaction Motors RMI LR-8-RM-5 rocket, 6K-ft-lbs.

Performance
 Maximum speed: 1,450 mph (Mach 2.24)
 Range: 4 minutes 45 seconds (powered endurance)
 Service ceiling: +90K-feet

An improved version of the X-1; the X-1A (above), featured turbo-driven fuel pumps, nitrogen-pressure fuel feed, increased fuel capacity, longer fuselage, and a nitrogen-pressurized cockpit modified for improved visibility. The X-1A made its first powered flight on February 21st 1953. On December 12th 1953, the X-1A reached a speed of 1,650 mph and on June 4th 1954, reached an altitude of 90K-feet . The plane was transferred to the N.A.C.A. on March 1st 1955, but was destroyed in an explosion on August 8th 1955. The X-1B was modified for investigation of aerodynamic heating and characteristics of reaction controls and during a three-year test program, provided NACA with data on heat flow, effects of internal heat sources and sinks and the effects of boundary-layer transition and aerodynamic interference. Research into reaction controls during the X-1B test series involved test flights at altitudes above 90K-feet and paved the way for the hydrogen peroxide reaction system used in the *Bell X-15*.

137



138

Slender Wing Theory

139

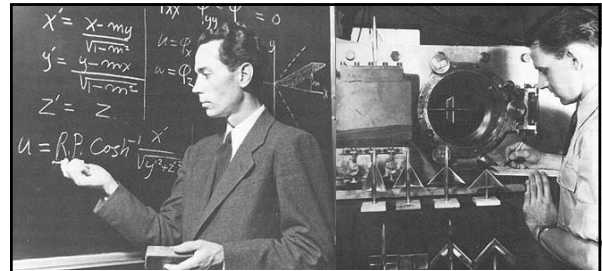

"...recently made a theoretical analysis, which indicates that a V-shaped wing traveling point foremost would be less affected by compressibility than other planforms. In fact, if the angle of the V is kept small relative to the Mach angle, the lift and center of pressure remain the same at speeds both above and below the speed of sound."
Robert T. Jones, NACA Aerodynamicist
Left: caption: "Robert T. Jones used the Lorentz transformation (i.e., a mathematical relation connecting the space and time coordinates of an event) to solve the critical problem of wing sweep in supersonic aerodynamics."
Right: caption: "Engineer tests models of various swept and delta wings in the 9-Inch Supersonic Tunnel, October 1946"¹⁴⁰

Jones sought a physical explanation for the total lack of compressibility effects on the theoretical performance of slender wings. After performing a series of complex calculations, he recognized that the physical explanation was related to the effect of sweepback on the lift of large-span wings. Jones guessed that his sweep theory would show that the effective Mach number would be much less than that of the flight Mach number even for moderately swept and thick wings. He did not realize how much less the effective Mach number could be until he tried sweeping the leading edge of a slender wing back behind the Mach cone; the idealized cone-shaped zone of disturbance that theoretically emanates from a body moving through the air (or any other fluid medium) at supersonic speed. The effective Mach number of the highly swept wing then appeared to be in the astonishing range of three to five times less than that of straight-wing planforms. The sweep smoothed out the sharply bending streamlines of supersonic flow that otherwise would have affected the wing adversely. This enabled a purely subsonic type of flow to exist on the wing's surface, a phenomenon which worked to eliminate the wave drag and compressibility shock of high-speed flight almost entirely. Jones now had a physical explanation for the missing compressibility effect shown by the mathematics of his theory. The result was a new theory that covered the entire sweep range from zero to 90 degrees and was not limited just to very slender wings.

141

X-4

142

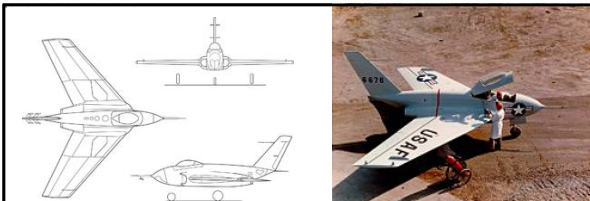

The Northrop X-4 "Bantam" (above L&R) was a prototype, small (only large enough to hold two Westinghouse J30 jet engines, a pilot, instrumentation and a 45-minute fuel supply), twin-jet aircraft produced in 1948. It had no horizontal tail surfaces, depending instead on combined elevator and aileron control surfaces (called "elevons") for control in pitch and roll attitudes, almost exactly in the manner of the similar-format, rocket-powered Messerschmitt Me-163. Some aerodynamicists had proposed that eliminating the horizontal tail would also do away with stability problems at high speeds (a.k.a. "shock stall") resulting from the interaction of supersonic shock waves from the wings and the horizontal stabilizers. Two aircraft had already been built using a semi-tailless design - the rocket-powered Me-163 "Komet" and the de Havilland DH-108 "Swallow," built after the war ended. The idea had merit, but the flight control systems of that time period prevented the X-4 from any real success.

143

D-558-1/2

144

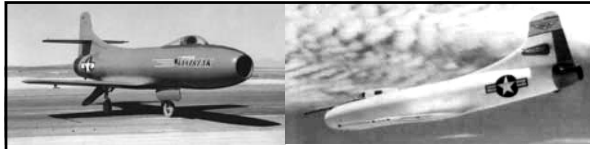

Above: the Douglas D-558-1 "Skystreak" was designed in 1944/45 and built for the U.S. Navy to explore handling characteristics and for obtaining high speed measurements not obtainable in existing U.S. wind tunnels, at the time. The first aircraft was completed in January 1947 (left) with the first flight being on April 28th 1947. Altogether three D-558-1 were built, with the second aircraft lost on April 3rd 1948 (the pilot was also killed). After the first aircraft was completed, a number of changes were made, the most notable being the replacement canopy (right). An attempt on the world speed record was made on September 29th 1947, with an average speed of 640.6 mph achieved.

145

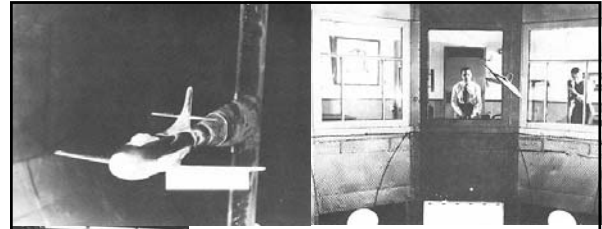

Above L&R: Models of the D-558 were tested in the 8-Foot High-Speed Tunnel (left) in June 1947 and in the 20-Foot Spin Tunnel (right) five months later

Left: caption: "Engineer tests models of various swept and delta wings in the 9-Inch Supersonic Tunnel, October 1946"

146

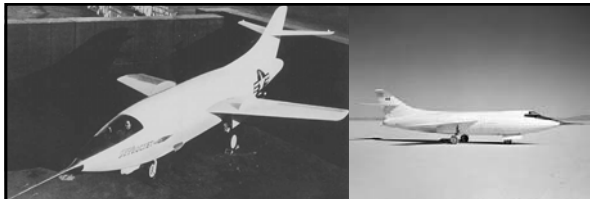

Above: the Douglas D-558-II "Skyrocket" (original flush canopy configuration, at left) was the follow up design to the Skystreak, with all the design work on the Skyrocket being done by the end of 1945, even before the D-558-1 had taken to the air (the D-558-1 fuselage could not be modified to accommodate both rocket and jet power). Powered by a Westinghouse J34-W-40 axial-flow turbojet engine with 3K-lbs. of thrust and a Reaction Motors XLR-8-RM-5 rocket engines making 6K-lbs. of thrust. The first flight was made on February 4th 1948 (powered by the Westinghouse engine alone since the rocket motor was not ready in time). A number of changes were made after the first test flight/s including a new raised canopy (right) and larger tailfin. Also, the jet engine was removed to make way for more fuel for the rocket motor. The Skyrocket's flight research was done at the NACA's Muroc Flight Test Unit, re-designated the "High-Speed Flight Research Station" (HSFRS) in 1949. The HSFRS became the "High-Speed Flight Station" in 1954 and is now known as the "NASA Dryden Flight Research Center." The three aircraft produced gathered a great deal of data about pitch-up and the coupling of lateral (yaw) and longitudinal (pitch) motions; wing and tail loads, lift, drag and buffeting characteristics of swept-wing aircraft at trans-sonic and supersonic speeds and the effects of the rocket exhaust plume on lateral dynamic stability throughout the speed range. Information about the effects of external stores (bomb shapes, drop tanks etc.) upon the aircraft's behavior in the trans-sonic region (roughly 0.7 to 1.3 times the speed of sound) was also gained.

147

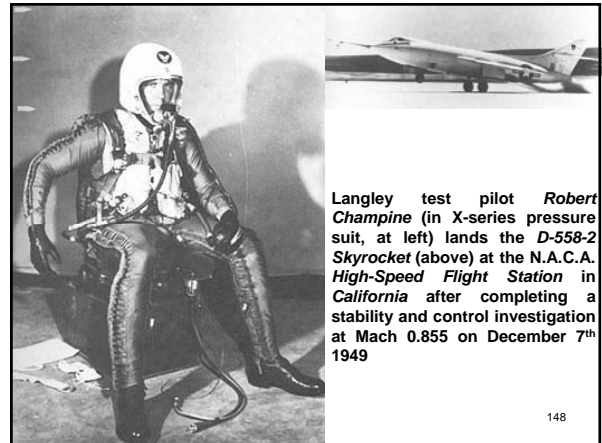

Langley test pilot Robert Champine (in X-series pressure suit, at left) lands the D-558-2 Skyrocket (above) at the N.A.C.A. High-Speed Flight Station in California after completing a stability and control investigation at Mach 0.855 on December 7th 1949

148

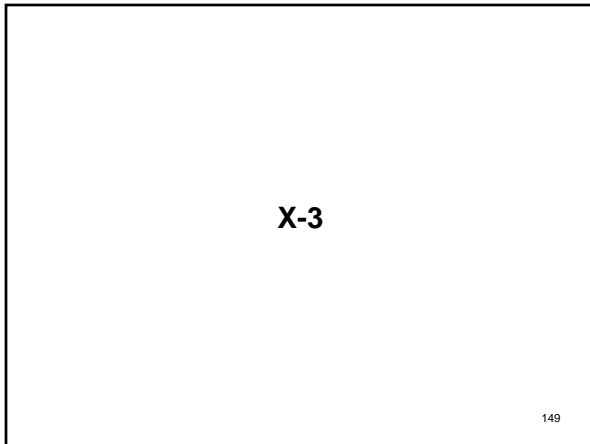

X-3

149

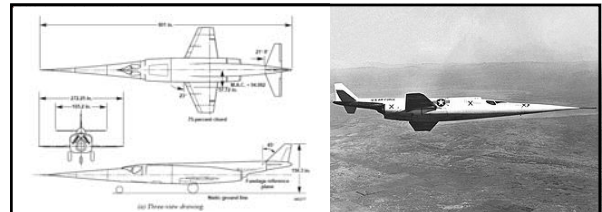

The Douglas X-3 "Stiletto" (above L&R) was an experimental jet aircraft with a slender fuselage and a long tapered nose. Its primary mission was to investigate the design features of an aircraft suitable for sustained supersonic speeds which included the first use of titanium in major airframe components. Douglas designed the X-3 with the goal of a maximum speed of approximately 2K mph, but it was seriously underpowered for this purpose and could not even exceed Mach 1 in level flight. Although the research aircraft was a disappointment, Lockheed designers used data from the X-3 tests for the Lockheed F-104 "Starfighter" which used a similar wing design in a successful Mach 2 fighter. The X-3 featured an unusual, rakish shape of a long cylindrical fuselage with tiny trapezoidal wings. The extended nose was to allow for the provision of test equipment. The X-3₅₀ first flew on October 15th 1952.

"...these three groups of tests will take many months, and possibly several years. It is expected that combat types of jet craft will be flying faster than sound before the supersonic phase of the tests is completed. Design of supersonic planes is still an uncertain matter, even though the X-1 has flown faster than sound and the swept-wing North American F-86 is reported to have exceeded sonic speeds in dives. Our knowledge of trans-sonic and supersonic aerodynamics is still rudimentary and the comprehensive research program is designed to find some of the answers..."

FLYING magazine, December 1948

151

FD2

152

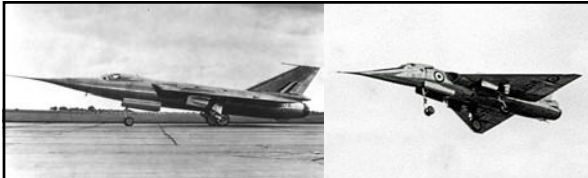

By 1956, Britain's delta-wing *Fairey Delta 2* (a.k.a. "FD2") research aircraft (left), powered by an ordinary jet-engine (a *Rolls-Royce Avon RA-14R* with an afterburner), was able to demonstrate that a properly-designed airplane can approach and pass the speed of sound with no more noticeable effect than a flicker of needles on the cockpit instruments as it does so. The design was a mid-wing tailless delta monoplane, with a circular cross-section fuselage and engine air-inlets blended into the wing roots. The Delta 2 had a very long tapering nose which obscured forward vision during landing, take-off and movement on the ground. To compensate, the nose section and cockpit drooped ten-degrees (landing with its "droop snoot" at the 1956 *Farnborough Air Show*, at right) in a similar way to that used later on the *Concorde SST*. The first FD2 made its maiden flight on October 6th 1954. On March 10th 1956, the FD2 broke the *World Air Speed Record*, raising it to 1,132 mph; an increase of some 300 mph over the record set in August 1955 by a *North American F-100* "Super Sabre." Thus, it became the first aircraft to exceed 1K mph in level flight. From that moment on, it became only a matter of time before a supersonic commercial airplane would be proposed and built. This record stood until December 12th 1957 when it was surpassed by a *McDonnell JF-101A "Voodoo"* of the *United States Air Force*.

153

Higher and Faster

154



An unofficial motto of flight research in the 1940's and 1950's was "higher and faster." By the late 1950s the last frontier of that goal was hypersonic flight (Mach 5+) to the edge of space. It would require a huge leap in aeronautical technology, life support systems and flight planning. The *North American X-15* rocket plane was built to meet that challenge. It was designed to fly at speeds up to Mach 6, and altitudes up to 250K-feet. The aircraft went on to reach a maximum speed of Mach 6.7 and a maximum altitude of 354,200-feet. Looking at it another way, Mach 6 is about one mile per second, and flight above 264,000 ft. qualifies an Air Force pilot for astronaut wings.

Above: caption: "The X-15 rocket airplane, designed to fly at speeds near 4,000 miles per hour and to altitudes above 50 miles, shown in Rogers Dry Lake at the NASA Flight Research Center, Edwards, California, where the research vehicle, underwent an extensive flight test program."

155



Model: North American X-15, a manned, hypersonic research aircraft.
Length: 50 ft. Height: 13 ft.
Wing Area: 200 sq. ft. in a 25° sweep-back.
Weight at Launching: 31,275 lbs.
Cargo: Pilot plus 1,300 lbs. of instruments.
Fabrication: Inconel-X, titanium and stainless steel to withstand temperatures in excess of 1,000°F.
Engine: Initial tests with two Reaction Motors XLR-11 engines. Test flight with single Reaction Motors XLR-99 Pioneer rocket engine.
Fuel: LOX and liquid ammonia.
Thrust: 50,000 lbs.
Speed: 3,600 mph.
Landing Gear: Dual nose wheel and rear skids.
Assignments: To research flight conditions beyond the earth's atmosphere. To increase knowledge of aerodynamic heating and heat transfer. To provide answers on control requirements for vehicles operating in a near vacuum.
Test Flight Date: February, 1959.
Pilot: Scott Crossfield, North American test pilot. The X-15 will then be turned over to NASA and Air Force pilots for further tests.
Cost: Under Navy, Air Force and NASA contracts through 1960—\$121,500,000.
Mechanix Illustrated, February 1959
Above: caption: "Cut-away drawing of the North American X-15"

156

The X-15 was a rocket-powered aircraft 50-feet long with a wingspan of 22-feet. It was a missile-shaped vehicle with an unusual wedge-shaped vertical tail, thin stubby wings and unique side fairings that extended along the side of the fuselage. The X-15 weighed about 14K-lbs. empty and approximately 34K-lbs. at launch. The "XLR-99" rocket engine, manufactured by Thiokol Chemical Corp., was pilot controlled and was capable of developing 57K-lbs. of thrust. North American Aviation built three X-15 aircraft for the program. The X-15 research aircraft was developed to provide in-flight information and data on aerodynamics, structures, flight controls and the physiological aspects of high-speed, high-altitude flight. A follow-on program used the aircraft as a test-bed to carry various scientific experiments beyond the Earth's atmosphere on a repeated basis. For flight in the dense air of the usable atmosphere, the X-15 used conventional aerodynamic controls such as rudders on the vertical stabilizers to control yaw and movable horizontal stabilizers to control pitch when moving in synchronization or roll when moved differentially. For flight in the thin air outside of the appreciable Earth's atmosphere, the X-15 used a reaction control system. Hydrogen peroxide thrust rockets located on the nose of the aircraft provided pitch and yaw control. Those on the wings controlled roll.

157



Left: caption: "Left above, exhaust of twin XLR-11 engines. Below, actuator of bottom speed brake."
 Right: caption: "Nose contour and trailing edges of wings are surprisingly blunt. In flight, pitch and yaw will be controlled by small ballistic rockets set into nose and wingtips. Bottom part of tail was taken off for rollout, will be replaced for flight. Only movable surfaces on the wings are the flaps."

Above: caption: "Drop launching is shown in drawing below. After release from B-52, the X-15 will rocket upward to 100-mile altitude."



Because of the large fuel consumption, the X-15 was air launched from a B-52 aircraft at 45K-feet and a speed of about 500 mph. Depending on the mission, the rocket engine provided thrust for the first 80 to 120 seconds of flight. The remainder of the normal 10 to 11 minute flight was powerless and ended with a 200-mph glide landing. Generally, one of two types of X-15 flight profiles was used; a high-altitude flight plan that called for the pilot to maintain a steep rate of climb, or a speed profile that called for the pilot to push over and maintain a level altitude. The X-15 was flown over a period of nearly 10 years: from June 1959 to Oct. 1968, and set the world's unofficial speed and altitude records of 4,520 mph (Mach 6.7) and 354,200-feet in a program to investigate all aspects of piloted hypersonic flight. Information gained from the highly successful X-15 program contributed to the development of the Mercury, Gemini and Apollo piloted spaceflight programs and also the Space Shuttle program. The X-15's made a total of 199 flights.

159

Above: caption: "Air Launch of X-15 No. 1 from Boeing B-52 Stratofortress"



"To the X-15 Research Airplane Team, the scientists, engineers, technicians, and pilots of the National Aeronautics and Space Administration; the Department of Defense; and North American Aviation, Incorporated for the conception, design, development, construction, and flight operation of the X-15 research airplane, which contributed valuable research information in the supersonic and hypersonic speed regime up to the fringes of space, and who have thereby made an outstanding contribution to American leadership in aerospace science and technology and in the operation of manned space flight."

Hugh L. Dryden, NASA Deputy Administrator
 RE: excerpt from his letter nominating the X-15 program for the 1961 Collier Trophy earlier that year. The X-15 program won the 1961 trophy with the citation noting its: "Invaluable technological contributions to the advancement of flight." Above, in a White House ceremony held on July 18th 1961, POTUS John F. Kennedy presented the Collier Trophy to X-15 pilot Major Robert M. White (shown standing next to the Trophy).

160

The Sound of Security

161

"With newer, faster supersonic planes, the sonic boom will become as inevitable and unavoidable as thunder. Since we can't escape it, the next best thing is to understand it. If you've never heard a sonic boom, it won't be long before you do. And you won't have to visit an air show or live close by an air base. It may awaken you from your sleep, or it may set dishes jumping in the cupboard at any hour of the day or night no matter where you live. It's no longer a stunt performed by a diving fighter pilot to impress a crowd. The boom is becoming part of the day-to-day operations of the Air Force, an inescapable element of straight-and-level flight at supersonic speeds. We must learn to live with it, for in today's unsettled world we cannot live without it. But, except in rare cases, it will only assault your eardrums. It isn't going to crack the plaster or start any earthquakes. It may break a few windows. And that will be about..."

Popular Science, May 1959

162

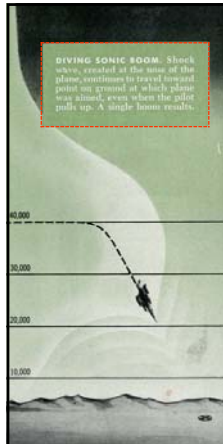

DIVING SONIC BOOM. Shock waves, created at the nose of the plane, continue to travel toward point on ground at which plane was aimed, even when the pilot pulls up. A single boom results.

40,000
30,000
20,000
10,000

“...In the days of slower aircraft it was possible to go faster than sound by diving a fighter plane, such as the North American F-86, and directing the boom at an air show or the wastes of a desert. The public got the idea that the boom was created as a single clap of thunder when the pilot passed through the ‘barrier’ that faced him when he reached Mach 1, or the speed of sound. It was commonly believed that this was the end of the noise, that it would be heard again only if the plane slowed down to less than Mach 1 and then broke the barrier again...”
Popular Science, May 1959
Above: caption: “DIVING SONIC BOOM. Shock wave, created at the nose of the plane, continues to travel toward point on ground at which plane was aimed, even when the pilot pulls up. A single boom results.”

163

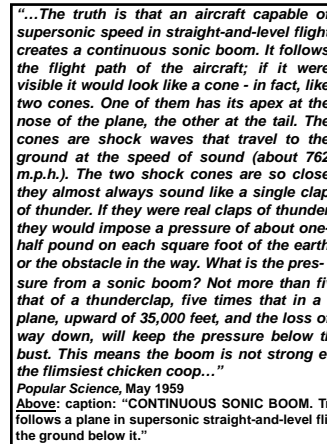

“...The truth is that an aircraft capable of supersonic speed in straight-and-level flight creates a continuous sonic boom. It follows the flight path of the aircraft; if it were visible it would look like a cone - in fact, like two cones. One of them has its apex at the nose of the plane, the other at the tail. The cones are shock waves that travel to the ground at the speed of sound (about 762 m.p.h.). The two shock cones are so close they almost always sound like a single clap of thunder. If they were real claps of thunder they would impose a pressure of about one-half pound on each square foot of the earth or the obstacle in the way. What is the pressure from a sonic boom? Not more than five pounds per square foot - 10 times that of a thunderclap, five times that in a boiler factory. But the altitude of the plane, upward of 35,000 feet, and the loss of energy that muffles the shock on the way down, will keep the pressure below the five-pound level. More boom than bust. This means the boom is not strong enough to inflict structural damage on the flimsiest chicken coop...”
Popular Science, May 1959
Above: caption: “CONTINUOUS SONIC BOOM. Trailing shock wave (shown in perspective) follows a plane in supersonic straight-and-level flight, and boom is dragged along the ground below it.”

164



“...Tests have shown that it takes a pressure of 70 or more pounds to damage ground buildings. In fact, tests with nuclear explosions have shown that it takes 150 to 300 pounds per square foot to damage brick or frame building construction. The strongest sonic-boom pressure ever recorded was 33 pounds per square foot, measured on a mountain top, with the aircraft only 280 feet away. But when people hear a noise that is roughly 10 times as loud as a clap of thunder, they immediately start looking for damage...”
Popular Science, May 1959

166



“...In an area such as southern California, where as many as 90 supersonic aircraft may be in the air at a time, this leads to serious complications. Under existing law, claims must be settled by the perpetrator: Air Force, Navy or manufacturer. But it is difficult in some cases to identify the airplane that broke a window. Air Force general policy, followed in facing demands for payment, includes these considerations:

- Plate and window glass may be broken by shock waves.
- Light bric-a-brac may be shaken or vibrated from shelves.
- Loosely latched doors may be pushed open and damaged.
- There is a possibility of aggravation of existing plaster cracks only when extensive damage is present.
- Structural damage to foundations and load-bearing walls is practically impossible.
- No sonic-boom pressure is strong enough to injure a person...”

Popular Science, May 1959
Left: caption: “When is noise objectionable? Not until it exceeds 128 decibels, or about one pound of pressure, test show. Somewhere between three and ten pounds of pressure (138 to 148 decibels) large plate-glass windows may break. It takes louder noise to crack small panes.”

167

“...For the Air Force, the problem first got critical in the New England area when the Lockheed F-104 interceptors were made operational at Westover Air Force Base, in Massachusetts. There are other areas: central Ohio, the St. Louis region, central Texas, and southern California. All of them involve military bases and aircraft-manufacturing plants. The biggest problem in 1959 is the Convair B-58 Hustler, our first supersonic bomber. So far, the B-58’s sins against the countryside have been minor disturbances created at irregular intervals by test pilots. Before this year is over, however, the airplane will be operational with the Strategic Air Command and flying regular practice missions all over the United States...”
Popular Science, May 1959

168

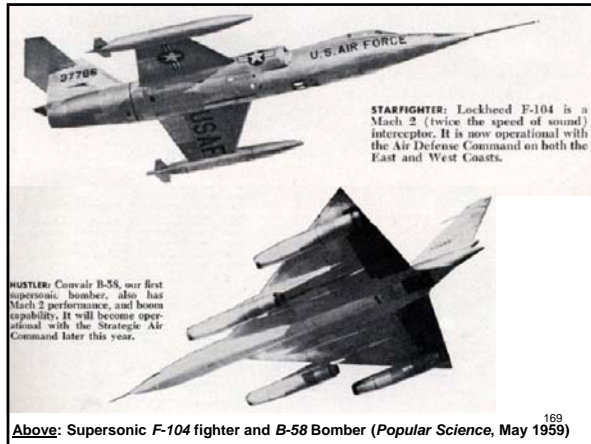

“...Boom in your future. About 30 cities, many of them major metropolitan areas, will be used as targets in simulated bombing raids at supersonic speeds. It will not always be the same 30 cities. In most cases there will be ample notice to the public, via newspapers and radio. Don't get the idea that the boom problem is going to remain forever the charge of men in uniform. The nation's airlines are giving it more and more attention as transport designers turn from their first subsonic jets to the idea of a Mach 2 or Mach 3 passenger liner. The airline problem, however, is several years in the future. The military problem is here today. Most of the people made unhappy by sonic booms have assumed that they are not necessary, are caused by aerial hot-rodgers and clowns in cockpits. Sonic booms are characteristic of supersonic missions flown for serious reasons. They are unavoidable. They are the Sound of Security.”

Popular Science, May 1959

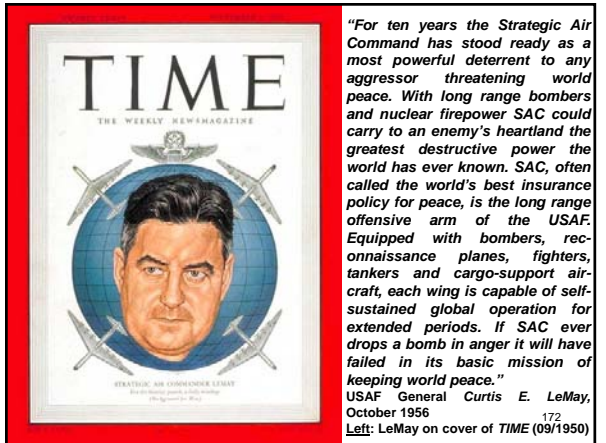

In 1955, the USAF issued “General Operational Requirement No. 38” for a new bomber with the payload and intercontinental range of the Boeing B-52 and the Mach 2 top speed of the Convair B-58 “Hustler.” The new bomber was expected to enter service in 1963. Both nuclear and conventional designs would be considered. The nuclear-powered bomber (subsonic) was placed under “Weapon System 125A” (WS125A) and pursued simultaneously with the jet-powered (supersonic) version; “Weapon System 110A” (WS110A). The USAF Air Research and Development Command (ARDC) requirement for WS-110A asked for a chemical fuel bomber with Mach 0.9 cruising speed and “maximum possible” speed during a 1K nautical miles entrance and exit from a target. The requirement also called for a 50K pound payload and a combat radius of 4K nautical miles (4,600 miles). In July 1955, six contractors were selected to bid on WS-110A studies. Boeing and North American Aviation (NAA) submitted proposals and, on November 8th 1955, were awarded contracts for Phase 1 development. In mid-1956, initial designs were presented by the two companies. “Zip” fuel (boron enriched) was to be used in the afterburners to improve range by 10% to 15% over conventional fuel. Both designs featured huge wing tip fuel tanks that could be jettisoned when their fuel was depleted before a supersonic dash to the target. The tanks also included the outer portions of the wing, which would also be jettisoned to produce a smaller wing planform suitable for supersonic speeds. The two designs had takeoff weights of approximately 750K pounds with large fuel loads.

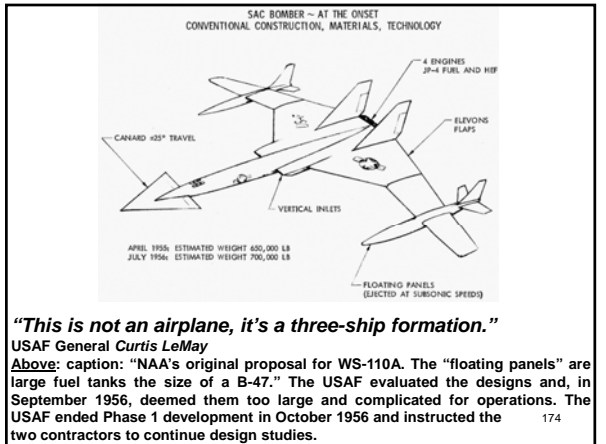

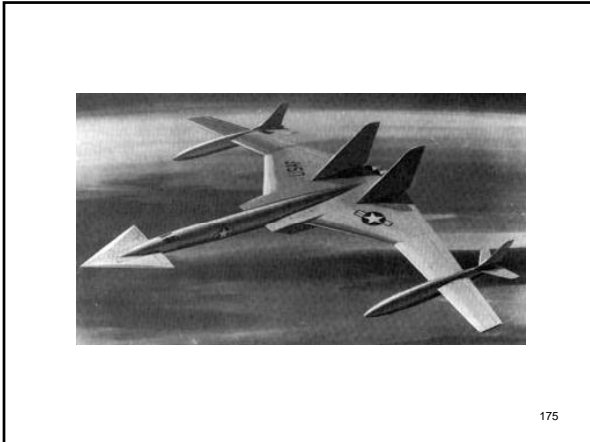

175

During the period that the original proposals were being studied, advances in supersonic flight were proceeding rapidly. The "long thin delta" was establishing itself as a preferred planform for supersonic flight, replacing earlier designs like the swept wing and compound sweep as seen on designs like the *Lockheed F-104 "Starfighter."* Engines able to cope with higher temperatures and widely varying inlet air speeds were also under design, allowing for sustained supersonic speeds. By March 1957, engine development and wind tunnel testing had progressed to the point that the potential for all-supersonic flight appeared feasible. The project decided that the aircraft would fly at speeds up to Mach 3 for the entire mission instead of a combination of subsonic cruise and supersonic dash (a.k.a. "cruise-and-dash") of the aircraft designs of the previous year. Zip fuel was still to be burned in the engine's afterburner to increase range. Both NAA and *Boeing* returned new designs with very long fuselages and large delta wings. They differed primarily in engine layout; the NAA design arranged its six engines in a semi-circular duct under the rear fuselage while the Boeing design used separate podded engines located individually on pylons below the wing. Known today as compression lift, the idea was to use the shock wave generated off the nose or other sharp points on the aircraft as a source of high pressure air. By carefully positioning the wing in relation to the shock, the shock's high pressure could be captured on the bottom of the wing and generate additional lift. To take maximum advantage of this effect, NAA redesigned the underside of the aircraft to feature a large triangular intake area far forward of the engines, better positioning the shock in relation to the wing.

176

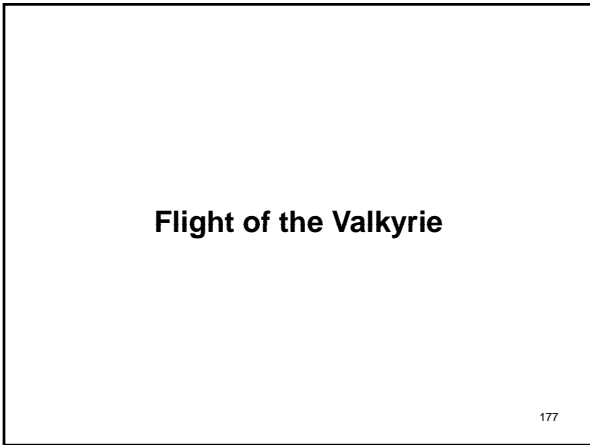

177

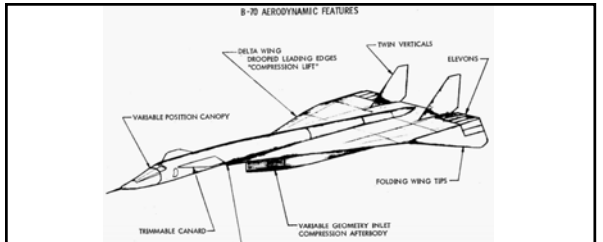

Above: caption: "NAA's final WS-110A proposal, built as the XB-70." The buildup of heat due to skin friction during sustained supersonic flight had to be addressed. During a Mach 3 cruise the aircraft would reach an average of 450-degrees F., although there were portions as high as 650-degrees F. NAA proposed building their design out of a sandwich panels, consisting of two thin sheets of stainless steel brazed to opposite faces of a honeycomb-shaped foil core. Expensive titanium would be used only in high-temperature areas like the leading edge of the horizontal stabilizer and the nose. For cooling the interior, the XB-70 pumped fuel en route to the engines through heat exchangers. On December 23rd 1957, the NAA proposal was declared the winner of the competition and on January 24th 1958, a contract was issued for Phase 1 development. In February 1958, the proposed bomber was designated "B-70," with the prototypes receiving the "X" (experimental prototype) designation.

178



179



"Two aircraft companies are taking first steps to introduce faster-than-sound, large sizes commercial and military planes within the coming decade. North American Aviation, Inc. is building a prototype of the B-70 Intercontinental bomber (above)...The B-70 will feature a supersonic survival seat for each of the four crew members. Constructed like a capsule, it is sealed so there is no need for the men to wear oxygen masks or pressurized flying suits. In an emergency, at near-vacuum heights above 70,000 feet, for example, the seat will rocket from the plane and be lowered by a 34-foot parachute. It will function as a boat should it land in water, and will carry 45 pounds of survival gear, giving protection against cold and heat..."

180

Popular Mechanics, April 1960



The North American B-70 "Valkyrie," with a planned cruise speed of Mach 3 and operating altitude of 70K-feet, was to be the ultimate high-altitude, high-speed manned strategic bomber of the Cold War era. To achieve Mach 3 performance, the B-70 was designed to "ride" its own shock wave, much as a surfer rides an ocean wave. The resulting shape used a delta wing on a slab-sided fuselage that contained the six jet engines (left) that powered the aircraft. The outer wing panels were hinged (middle). During take-off, landing and subsonic flight, they remained in the horizontal position. This feature increased the amount of lift produced, improving the lift-to-drag ratio. Once the aircraft was supersonic, the wing panels would be hinged downward. Changing the position of the wing panels reduced the drag caused by the wingtips interacting with the inlet shock wave. The repositioned wingtips also reduced the area behind the airplane's Center of Gravity which reduced trim drag. The down-turned outer panels also provided more vertical surface to improve directional stability at high Mach numbers. Attached to the delta was a long, thin forward fuselage. Behind the cockpit were two large canards (right), which acted as control surfaces.

181



As impressive a technological feat as the B-70 represented, the aircraft was under development at a time when the future of the manned bomber was uncertain. During the late 1950's and early 1960's, many felt that manned aircraft were obsolete and the future belonged to missiles. As a result, the Kennedy administration ended plans to deploy the B-70. Two experimental XB-70A prototypes were under construction at NAA when the program was canceled.

182

Hypersonic Spy

183

The Lockheed SR-71 "Blackbird" (a.k.a. "Habu," "SR," "Lady in Black" and "Sled") was developed as a long-range strategic reconnaissance aircraft capable of flying at speeds over Mach 3.2 and at 85K-feet. The first SR-71 to enter service was delivered in 1966. In the mid 1950's the U.S. Air Force and the CIA decided that it would be best to replace the high-flying but relatively slow and vulnerable "U-2" with something that would travel much faster to avoid enemy interceptors and surface-to-air missile systems. Lockheed, the developer of the U-2 was also given the contract to develop this supersonic aircraft after a competition with Convair. The project was called ARCHANGEL and the "Skunk Works," a division of the Lockheed Aircraft Corporation, went through twelve design proposals before they reached their final design; the A-12. On January 26th 1960, the CIA ordered twelve A-12 aircraft. Soon after, in May 1960, Francis Gary Powers was shot down in a U-2 over the Soviet Union. This event resulted in the United States and the Soviet Union signing an agreement not to fly manned vehicles over the Soviet Union again, a treaty that was undermined even before the SR-71 was built.

184



Lockheed's first proposal centered on a design propelled by liquid hydrogen. This proved to be impracticable because of considerable fuel consumption. Lockheed then reconfigured the design for conventional fuels. Lockheed's clandestine "Skunk Works" division (headed by the gifted design engineer Clarence L. "Kelly" Johnson) designed the A-12 to cruise at Mach 3.2 and fly well above 60K-feet. To meet these challenging requirements, Lockheed engineers overcame many daunting technical challenges. Flying more than three times the speed of sound generates 600-degree F. temperatures on external aircraft surfaces, which are enough to melt conventional aluminum airframes. The design team chose to make the jet's external skin of titanium alloy which shielded the internal aluminum airframe. Two conventional, but very powerful, afterburning turbine engines propelled the aircraft. These power plants had to operate across a huge speed envelope in flight; from a takeoff speed of 207 mph to more than 2,200 mph. To prevent supersonic shock waves from moving inside the engine intake causing flameouts, Johnson's team had to design a complex air intake and bypass system for the engines. The A-12's cross-section was designed to exhibit a low radar profile by carefully shaping the airframe to reflect as little transmitted radar energy (radio waves) as possible and by application of special paint designed to absorb, rather than reflect, these waves. This treatment became one of the first applications of stealth technology, but never completely met the design goals. Besides absorbing radar signals, the special paint was designed to radiate some of the tremendous airframe heat generated by air friction and to camouflage the aircraft against the dark sky at high altitudes. After the Air Force began to operate the SR-71, it acquired the official name "Blackbird" - for the special black paint that covered the airplane.

185



The first A-12 was completed and taken from Burbank, CA to the Groom Lake test facility on February 26th 1962. A few months later, the A-12 made its first flight on April 25th 1962. During the flight, there were some technical problems so the A-12 didn't make its official first flight until April 30th 1962 (above). A few days later, the A-12 went supersonic for the first time and reached Mach 1.1 during the second test flight. The A-12 was primarily an over-flight vehicle that was configured to fly over a target at very high speed and high altitude. It got all of the coverage that it could and then returned base. Now that the U.S. signed a treaty with the Soviet Union banning over-flights of Soviet territory, the A-12 (above) could never fly over the target that it was designed for. The Air Force needed something more. While Lockheed continued to refine the A-12, the U.S. Air Force ordered an interceptor version of the aircraft designated the "YF-12A." The Skunk Works, however, proposed a "specific mission" version configured to conduct post-nuclear strike reconnaissance. This system evolved into the USAF's "SR-71." The SR-71 was configured to use cameras that provided peripheral coverage. Thus, the aircraft need not enter enemy airspace. When the SR-71 became operational, orbiting reconnaissance satellites had already replaced manned aircraft to gather intelligence from sites deep within Soviet territory. However, satellites could not cover every geopolitical hotspot, so the Blackbird remained a vital strategic tool for global intelligence gathering.

186



Lockheed built fifteen A-12s, including a special two-seat trainer version. Two A-12s were modified to carry a special reconnaissance drone, designated "D-21." The modified A-12s were re-designated "M-21." These were designed to take off with the D-21 drone, powered by a Marquart ramjet engine mounted on a pylon between the rudders. The M-21 then hauled the drone aloft and launched it at speeds high enough to ignite the drone's ramjet motor. Lockheed also built three "YF-12A" models, but this type never went into production (two of the YF-12A's crashed during testing). Only one survives and is on display at the USAF Museum in Dayton, Ohio (the aft section of one of the "written off" YF-12A's which was later used along with an SR-71A static test airframe to manufacture the sole SR-71C trainer). One SR-71 was lent to NASA and designated YF-12C. Including the SR-71C and two SR-71B pilot trainers, Lockheed constructed thirty-two Blackbirds. The first SR-71 flew on Dec. 22nd 1964.

Above (left-to-right): YF-12A Blackbird / M-21 Blackbird / D-21 Drone

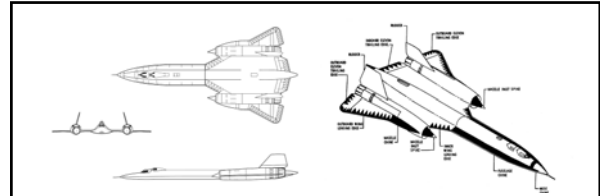

Early in 1963, the Blackbird made its first flight with two J58 engines (when the A-12 made its first flight, it was with two J75 engines since Pratt & Whitney did not have the powerful J58 yet complete). The program experienced its first Blackbird loss when an A-12 crashed near Wendover, Utah on May 24th 1963. Also, in November 1963, a Blackbird A-12 made its first flight at Mach 3.2; the top speed that the aircraft was designed for. On December 28th 1966, the decision was made to terminate A-12 operations by June 1st 1968. The Bureau of the Budget decided that it would be too costly to have both the SR-71 and the A-12 programs running at the same time because both aircraft were very similar and did similar tasks. The first flight of the A-12 in a combat mission over North Vietnam occurred in May 1967. In November 1967, the CIA's A-12 and the USAF's SR-71 conducted a reconnaissance "fly-off" to decide which aircraft was superior and worth keeping. The final choice was the SR-71 (above L&R).

The SR-71 was designed to fly deep into hostile territory, avoiding interception with its tremendous speed and high altitude. It could operate safely at a maximum speed of Mach 3.3 at an altitude more than sixteen miles, or 85K-feet, above the earth. The two-man crew (a Pilot and a Reconnaissance Systems Officer) had to wear pressure suits similar to those worn by astronauts. These suits were required to protect the crew in the event of sudden cabin pressure loss while at operating altitudes. To climb and cruise at supersonic speeds, the Blackbird's Pratt & Whitney J-58 engines were designed to operate continuously in afterburner. While this would appear to dictate high fuel flows, the Blackbird actually achieved its best "gas mileage," in terms of air nautical miles per pound of fuel burned, during the Mach 3+ cruise. A typical Blackbird reconnaissance flight might require several aerial refueling operations from an airborne tanker. Each time the SR-71 refueled, the crew had to descend to the tanker's altitude (usually about 20K to 30K-feet) and slow the airplane to subsonic speeds. As velocity decreased, so did frictional heat. This cooling effect caused the aircraft's skin panels to shrink considerably and those covering the fuel tanks contracted so much that fuel leaked forming a distinctive vapor trail as the tanker topped off the Blackbird. As soon as the tanks were filled, the SR-71's crew disconnected from the tanker, relit the afterburners and climbed to high altitude.



As the performance of space-based surveillance systems grew, along with the effectiveness of ground-based air defense networks, the USAF started to lose enthusiasm for the expensive program. Thus, SR-71 operations ceased in January 1990. Despite protests by military leaders, Congress revived the program in 1995. However, continued wrangling over operating budgets soon led to final termination. The National Aeronautics and Space Administration (NASA) retained two SR-71A's and the one SR-71B for high-speed research projects and flew these airplanes until 1999. On March 6th 1990, the service career of one Lockheed SR-71A Blackbird ended with a record-setting flight. This airplane flew from Los Angeles to Washington D.C. in one hour, four minutes and twenty seconds, averaging a speed of 2,124 mph. At the conclusion of the flight, the SR-71A landed at Dulles International Airport and taxied into the custody of the Smithsonian Institution's National Air and Space Museum where it remains on permanent display (left).

"Mr. President, the termination of the SR-71 was a grave mistake and could place our nation at a serious disadvantage in the event of a future crisis. Yesterday's historic transcontinental flight was a sad memorial to our short-sighted policy in strategic aerial reconnaissance."
Senator John Glenn, March 7th 1990
RE: excerpt from his Senate speech chastising the Department of Defense for terminating the SR-71 program

Part 4

America First

“...Lockheed Aircraft Corp. is advocating a 2,000-mile-per-hour transport adaptable for use as a military tanker, and has suggested a possible design as well as an estimate of production costs...Lockheed officials, arguing that there is now no technical, operational or economic reason why a supersonic transport could not be developed in the U.S., suggest that its shape could be a needle-pointed fore and aft, and that it have a swept-back stabilizer near the front of the fuselage. Passengers would sit forward of the delta wing. Such a 250,000-pound steel airliner would cost some \$160,000,000 to develop, according to Vice-President Burt C. Monesmith. He estimates that in quantities of 200 the planes could be built for \$9,240,000 each.”
Popular Mechanics, April 1960

193



Above: caption (Lockheed press release dated 06/17/59): "LOS ANGELES: Artist's conception shown could be an airliner of 1965 and as such, according to Hall L. Hibbard, Senior Vice President of Lockheed Aircraft, the vehicle could leave London at 11 AM, arrive in New York at 8:20 AM, and get to Los Angeles at 7:45 AM, all in the same morning. The plane might carry 90 passengers at altitudes of 60,000 to 90,000 feet and operate from existing airports."

A Perfect Testbed

195



During the late 1950's and early '60's, there was growing interest in an American supersonic transport (SST). Jet airliners had cut flight times by more than half in comparison to propeller-powered aircraft. A Mach 2 or 3 SST would make a similar improvement over the new subsonic jet airliners. The *Flight Research Center* had several SST studies underway during the early 1960's. NASA's *Douglas F5D-1* was used for landing studies, a *North American F-100C* was modified to simulate SST handling qualities, a *North American A-5A* was used to simulate an SST for tests of the air traffic control system and a *Lockheed "JetStar"* was modified as an in-flight SST simulator. The XB-70 "Valkyrie" seemed to be a perfect testbed for SST research. It was the same size as the projected SST designs and used similar structural materials such as brazed stainless steel honeycomb and titanium. Thus, the XB-70's role changed from a manned bomber prototype to one of the most remarkable research aircraft ever flown.

Above: NAA artist's impression of a supersonic transport derived from the B-70 Mach 3 bomber



The XB-70A number 1 (above) made its first flight from *Palmdale, CA* to *Edwards Air Force Base* on September 21st 1964. Tests of the XB-70's airworthiness occurred throughout 1964 and 1965 by NAA and USAF test pilots. The *Flight Research Center* prepared its instrument package. Although intended to cruise at Mach 3, the first XB-70 was found to have poor directional stability above Mach 2.5 and only made a single flight above Mach 3. Despite the problems, the early flights provided data on a number of issues facing SST designers. These included aircraft noise, operational problems, control system design, comparison of wind tunnel predictions with actual flight data and high altitude, clear-air turbulence. NASA's *Ames Research Center* at *Moffett Field, CA*, wind-tunnel studies led engineers at NAA in *Downey, CA*, to build the second XB-70A with an added five degrees of dihedral on the wings. This aircraft made its first flight on July 17th 1965. The changes resulted in much better handling, and the second XB-70 achieved Mach 3 for the first time on January 3rd 1966. The aircraft made a total of nine Mach 3 flights by June 1966.



At the same time, a joint agreement was signed between NASA and the USAF to use the second XB-70A prototype for high-speed research flights in support of the SST program. It was selected due to its better aerodynamics, inlet controls and a much superior instrument package (as compared to the first aircraft). The NASA research flights were to begin in mid-June 1966, once the NAA Phase I tests of the vehicle's airworthiness were completed. The flights were to evaluate the aircraft on typical SST flight profiles, and to study the problems of sonic booms on overland flights.

Left: XB-70A's cockpit flight controls

198



Plans went awry on June 8th 1966 when the second XB-70 crashed following a mid-air collision with NASA's *F-104N* chase plane (the *F-104N* pilot died in the accident). The NAA test pilot ejected from the XB-70 in his escape capsule, but received serious injuries in the process. However, the co-pilot, who was making his first flight in the XB-70, was unable to eject and died in the crash.

Left: caption: "All is calm just moments before the tragedy. The overhead contrail is from a passing B-58"

Middle: caption: "Moments after the impact. Joe Walker's *F-104* is in flames and the XB-70 has lost both her verticals"

Right: caption: "Mortally wounded, aerodynamic forces rupture the XB-70s wing tanks and she begins to leak fuel."

199



The two deaths resulting from the June 8th 1966 mid-air collision and the destruction of the second XB-70 had major consequences for the research program. The second XB-70 had been selected for the Phase II tests which were to be conducted jointly by NASA and the USAF. With this aircraft now destroyed, only the first aircraft was available. Given the aircraft's shortcomings, the USAF began to doubt that it would be able to meet the Phase II test goals. The first XB-70 (above) was undergoing maintenance and modifications at the time of the accident to its sister ship. It did not fly again until November 3rd 1966. The flight reached a top speed of Mach 2.1. Between November 1966 and the end of January 1967, a total of eleven joint USAF/NASA research flights occurred. A top speed of Mach 2.57 was the highest attained during the remainder of the XB-70 program.

200

These eleven joint USAF/NASA flights were made as part of the *National Sonic Boom Program*. The XB-70 flew at differing altitudes, Mach numbers and weights over an instrumented test range at *Edwards Air Force Base*. The "boom carpet" area was determined and the overpressure measured on two specially constructed housing units. The tests showed that a large aircraft, such as the XB-70 or the projected SST, could generate overpressures high enough to cause damage. Moreover, when the XB-70 made a turn, its shock waves converged, and often doubled the overpressure on the ground. Following these tests, the XB-70 was grounded for maintenance that lasted two and a half months. The Air Force had concluded by that point that the XB-70 program should be turned over to NASA as soon as possible. *Flight Research Center* director *Paul Bikle* and *Air Force Flight Test Center* (AFFTC) commander Major General *Hugh Manson* created a joint FRC/AFFTC XB-70 operating committee on March 15th 1967 (it was patterned on similar committees established for the X-15). The NASA XB-70 program continued to receive USAF assistance in terms of aircraft support and test pilots.

201

In the late 1950's when SST designs were being actively pursued, it was thought that although the boom would be very large, they could avoid problems by flying higher. This premise was proven false when the XB-70 started flying and it was found that the boom was a very real problem even at 70K-feet. It was during these tests that the "N-wave" was first characterized. *Richard Seebass* and his colleague *Albert George* at *Cornell University* studied the problem extensively and eventually defined a "Figure of Merit" (FM) to characterize the sonic boom levels of different aircraft. FM is proportional to the aircraft weight divided by the three-halves of the aircraft length ($FM = W/[3/2 \cdot L] = 2W/3L$). The lower this value, the less boom the aircraft generates (figures of about 1 or lower were considered acceptable). Using this calculation they would find FM's of about 1.4 for the *Concorde*, and 1.9 for the *Boeing 2707*. This eventually doomed most SST projects as public opposition mixed with politics eventually resulted in laws that made any such aircraft impractical (flying only over water only, for instance). Seebass and George also worked on the problem from another angle, examining ways to reduce the "peaks" of the N-wave and therefore smooth out the shock into something less annoying. Their theory suggested that body shaping might be able to use the secondary shocks to either spread out the N-wave or interfere with each other to the same end. Ideally, this would raise the characteristic altitude from 40K to 60K-feet, which is where most SST designs flew. The design required some fairly sophisticated shaping in order to achieve the dual needs of reducing the shock and still leaving an aerodynamically efficient shape and therefore had to wait for the advent of computer-aided design (CAD) before being able to be built.

202

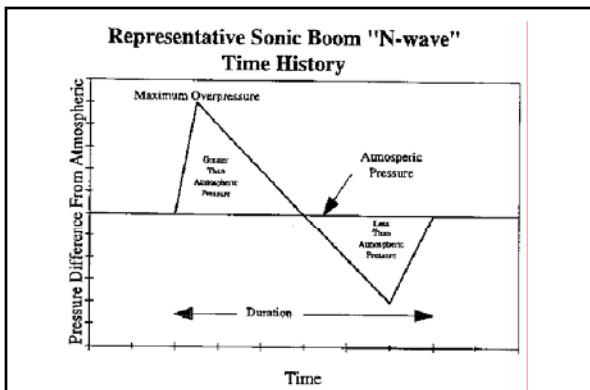

Above: caption: "Representative Time History of a Sonic Boom "N-wave" Pressure Pulse"

203

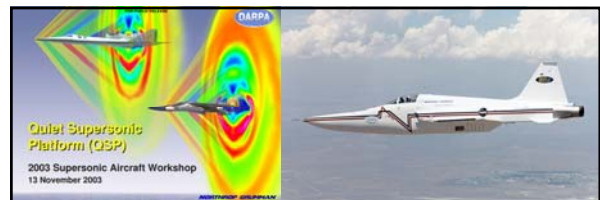

For decades, the N-wave theory went untested until the *Defense Advanced Research Projects Agency* (DARPA) started the "Quiet Supersonic Platform" (QSP) project (left) and funded the "Shaped Sonic Boom Demonstration" (SSBD) aircraft to test it. SSBD used an *F-5 Freedom Fighter* modified with a new body shape (right). Over a two year period, the SSBD aircraft was used in what became the most extensive study on the sonic boom ever pursued. After measuring the 1,300 recordings, some taken inside the shock wave by a chase plane, the SSBD aircraft demonstrated a reduction in boom by about one-third. Although one-third may appear to be a marginal reduction it could, in effect, have reduced the *Concorde* below the $FM = 1$ limit.

204



The first NASA XB-70 flight occurred on April 25th 1967 (above L&R). By the end of March 1968, another twelve research flights had been completed. The flights acquired data to correlate with an Ames ground-based SST simulator and the JetStar in-flight SST simulator at the FRC. Other XB-70 research goals were to measure its structural response to turbulence, determine the aircraft's handling qualities during landings and investigate boundary layer noise, inlet performance and structural dynamics including fuselage bending and canard flight loads. The XB-70 underwent modifications after a final flight on March 21st 1968. During research flights, the XB-70 pilots had frequently experienced trim changes and buffeting during high-speed/altitude flights. These resulted from clear-air turbulence and rapidly changing atmospheric temperatures. For a specialized research aircraft, these characteristics were little more than an annoyance. However, on a commercial SST they would be uncomfortable for the passengers, increase the pilots' workload and shorten the structural fatigue life of the SST.

205



206

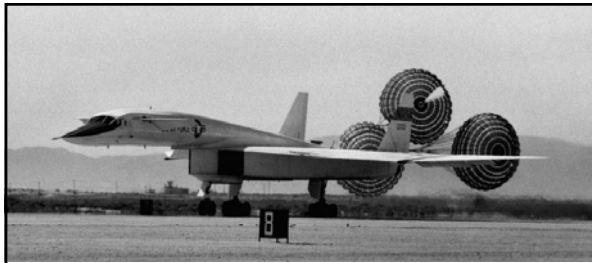

Above: drag (deceleration) parachutes deploy from the XB-70 upon landing. The XB-70 was fitted with two small vanes for the "Identically Located Acceleration and Force" (ILAF) experiment. The vanes rotated twelve degrees at a rate of up to eight cycles per second. This induced a structural vibration in the XB-70 at a known frequency and amplitude. The XB-70's accelerometers detected the disturbances, then signaled the aircraft's stability augmentation system to damp out the motion. When XB-70 research flights resumed on June 11th 1968, the ILAF proved its ability to reduce the effects of turbulence and atmospheric temperature changes.

207



Despite the accomplishments of the XB-70, time was running out for the research program. NASA had reached an agreement with the USAF to fly research missions with a pair of YF-12A's and a YF-12C, which was actually an SR-71 "Blackbird". These represented a far more advanced technology than that of the XB-70. In all, the two XB-70's had logged only one hour and forty-eight minutes of Mach 3 flight time. A YF-12 could log this much Mach 3 time in a single flight. The final XB-70 research flight occurred on February 4th 1969 (a subsonic structural dynamics test and ferry flight). The XB-70 took off from Edwards AFB and flew to Wright-Patterson AFB, Ohio, where the aircraft was put on display at the U. S. Air Force Museum in Dayton, Ohio (above).

208

XB-70A General Characteristics

Crew: 2

Length: 189 ft 0 in

Wingspan: 105 ft 0 in

Height: 30 ft 0 in

Wing Area: 6,297 ft²

Airfoil: Hexagonal; 0.30 Hex modified root, 0.70 Hex modified tip

Empty Weight: 253,600 lbs. (operating empty weight)

Loaded weight: 534,700 lbs.

Maximum Takeoff Weight: 542,000 lbs.

Powerplant: 6 x General Electric YJ93-GE-3 afterburning turbojet

Dry thrust: 19,900 lbf each

Thrust with Afterburner: 28,800 lbf each

Internal Fuel Capacity: 300,000 lbs. or 46,745 US gallons

Performance

Maximum Speed: Mach 3.1 (2,056 mph)

Cruise Speed: Mach 3.0 (2,000 mph)

Range: 3,725 nmi (4,288 mi) on combat mission

Service Ceiling: 77,350 ft

Wing loading: 84.93 lb/ft²

Lift-to-Drag: about 6 at Mach 2

Thrust/Weight: 0.314

209

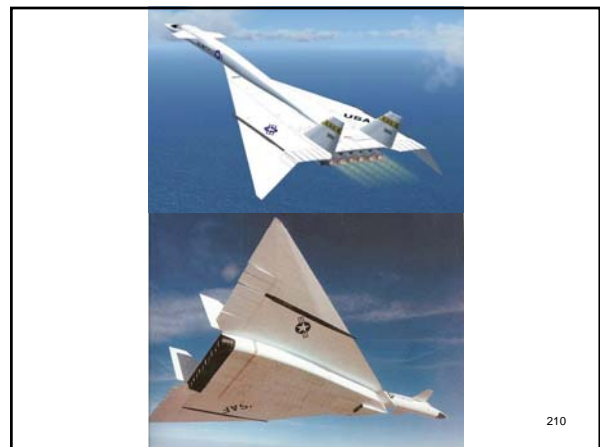

210

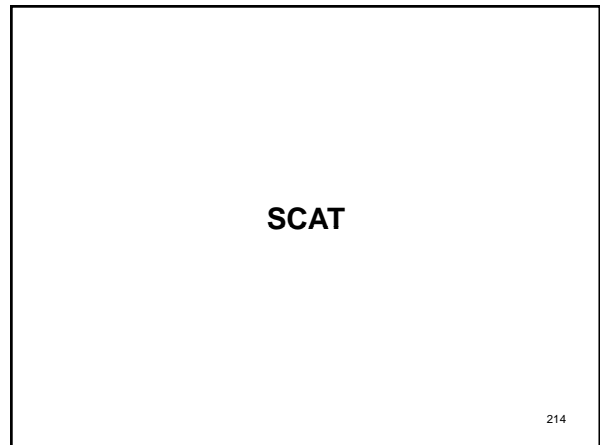
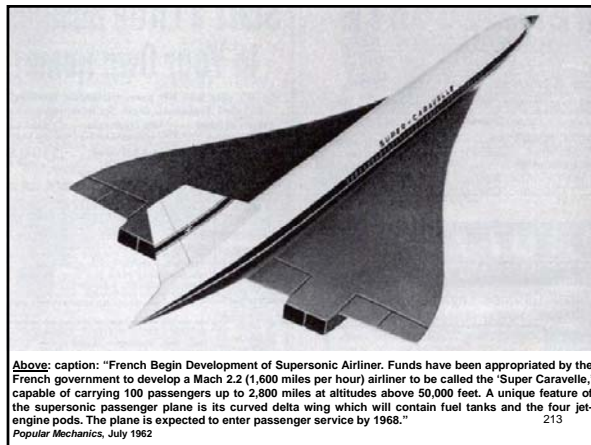
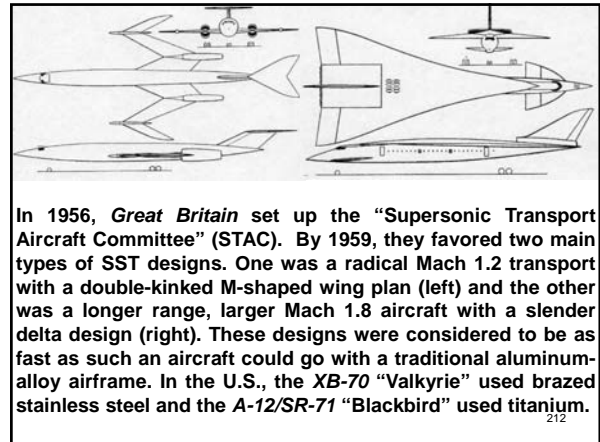
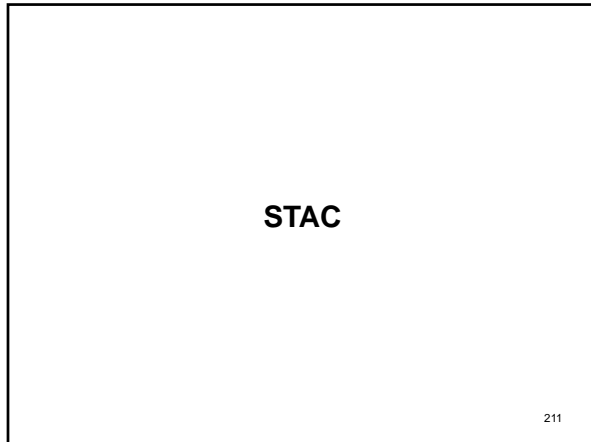

In early 1962, the British firm *Bristol Aeroplane Company* and the French *Sud Aviation* formed a consortium to produce the first bi-national supersonic commercial transport airplane. In November 1962, the Anglo-French consortium announced their SST project would proceed and was to be named "Concorde" (rather than the original French name: "Super Caravelle"). Other nations immediately began to work on SST designs of their own. In the *Soviet Union*, the *Tupolev Design Bureau* began working on their "TU-144." The *United States* could hardly stand by and watch this, in 1962, NASA began the "Supersonic Commercial Air Transport" (SCAT) program. The SCAT SST program got a significant boost when, in a speech delivered on June 5th 1963, POTUS *John F. Kennedy* announced that such a program was authorized and that the federal government would subsidize up to seventy-five percent (\$100 million) of the development costs of a commercial supersonic aircraft capable of meeting and exceeding the Concorde "threat" (it was believed by many, at the time, that all future airliners would be supersonic and *Concorde* would give the Europeans a serious advantage in the race for market share). The *Federal Aviation Authority* (FAA) issued an RFP (*Request for Proposals*) for an SST design to three airframe and three engine manufacturers: *Boeing*, *Lockheed*, *North American Aviation* (NAA), *Curtiss-Wright*, *General Electric* and *Pratt & Whitney*. The designs were submitted to the FAA on January 15th 1964. The Americans would aim for a Mach 3 (2K mph) capable airframe made of steel or titanium. *Concorde's* designers limited the speed to Mach 2.2, since this was the maximum speed possible for an aircraft made of aluminum alloys. With the *XB-70* and the *A-12/SR-71* having proved out new metallurgical technologies, America appeared to be at an advantage in the race for Mach speed, range and passenger capacity.

215

"It is my judgment that this Government should immediately commence a new program in partnership with private industry to develop at the earliest practical date the prototype of a commercially successful supersonic transport, superior to that being built in any other country in the world."

POTUS *John F. Kennedy*, 1963

RE: in 1963, *Pan American Airways* – the premier American international airline, placed the first large, initial order for *Concorde*, breathing life into the fledgling program. President *Kennedy* was enraged at this action by PAA and called PAA's legendary Chairman *Juan Trippe* on the carpet over it. *Trippe* responded that, given the alternative, he would consider an American SST but there was no such alternative so he turned to the Europeans instead. PAA was determined to always stay ahead of the pack when it came to emerging aviation technology and in the early 1960's, supersonic transport was the leading edge of advanced aviation technology. *Kennedy* and others in both the administration and industry saw this as a call to action. America would have to play catch-up, though there had been much American military R&D concerning supersonic flight in the post-WWII era.

216

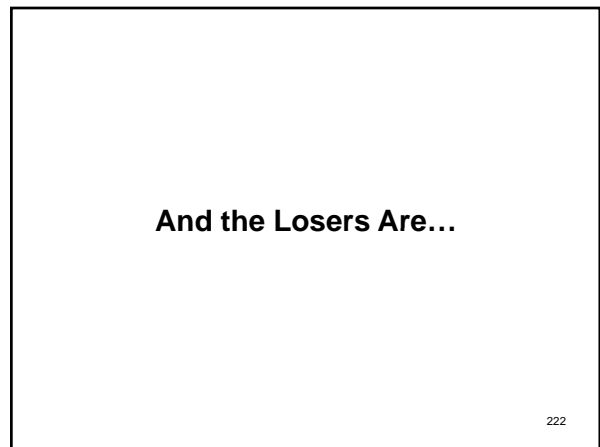
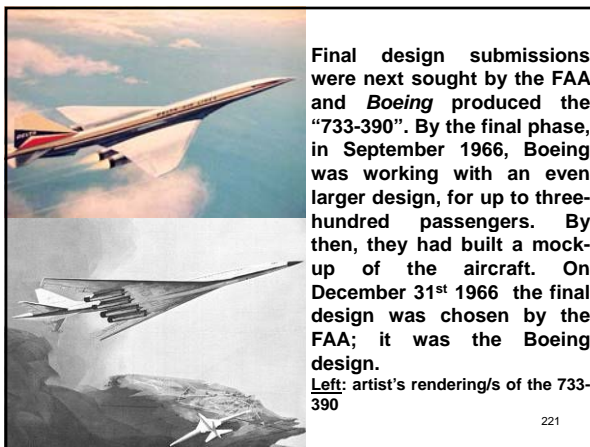
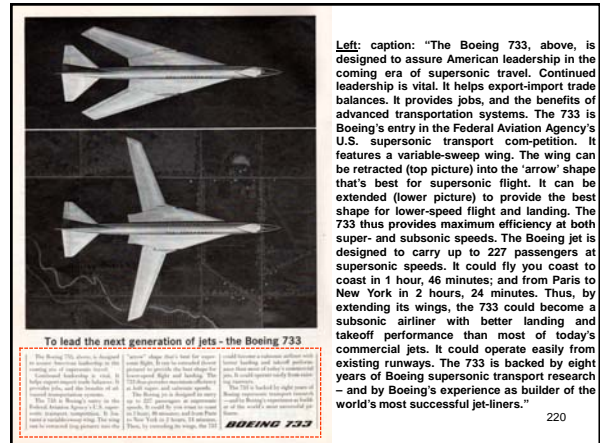
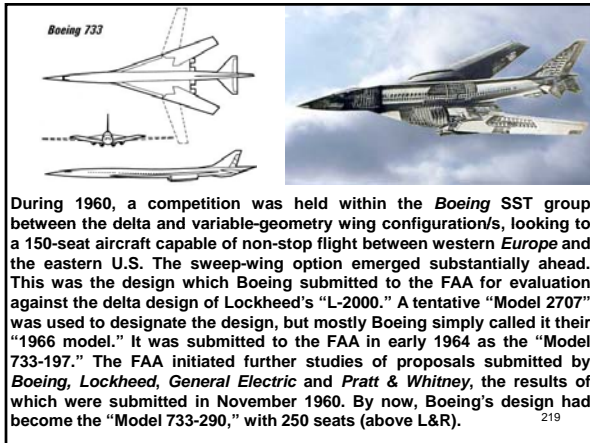
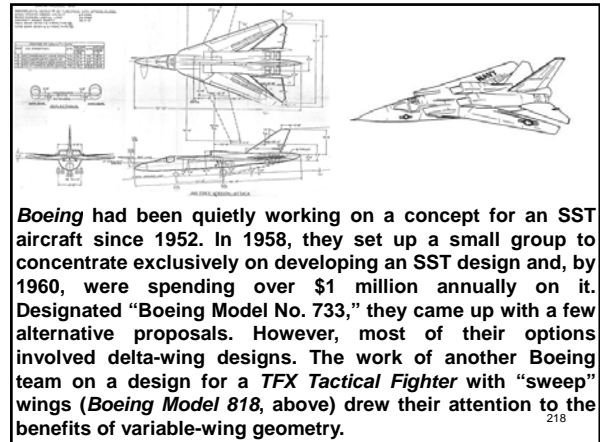
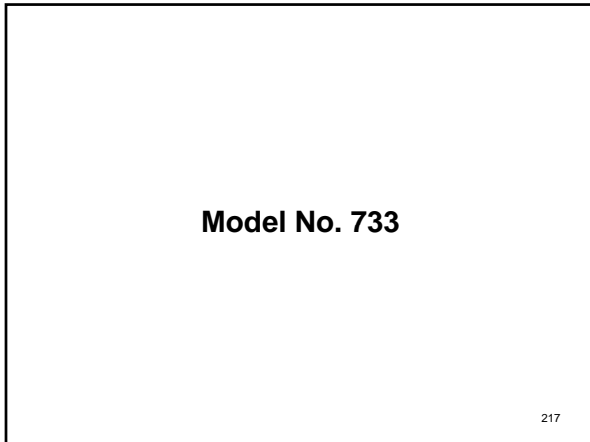

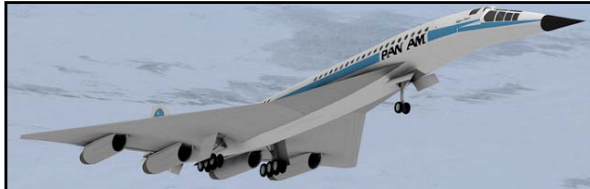

TWA and Pan Am Airways put forward \$2.1 million towards the purchase of twenty-one SST's from whomever won the FAA competition. Boeing and Lockheed, along with engine makers General Electric and Pratt & Whitney, were named as the initial Phase II winners of the SST design competition in early 1966. The designs would out-perform the Concorde, being faster and carrying more passengers. The Lockheed design (above) used a fixed-wing, double-delta layout. The aerodynamic pitching moment change from subsonic to supersonic flight necessitated configuration solutions for the design. The Lockheed double-delta counteracted the supersonic negative pitching moment because the forward delta begins to generate lift at supersonic speeds and the low speed regime is assisted by controlled vortex flow from the leading edge which increases lift. No slats or flaps were required as the large wing area (9,424 sq. ft.) had significant ground-cushion on landing. At the end of December 1966, the Lockheed L-2000 lost the competition to the Boeing design.

Page 5 LOCKHEED STAR June 27, 1966

Curtain Goes Up on Supersonic Transport Mockup

Lockheed today unveiled the full-scale mockup of one design for the U.S. 1000-hour transport that will compete for world air traffic supremacy in the 1970s against the challenge of the British-French Concorde.

The Lockheed mockup is a 100-foot-long model of a future U.S. supersonic transport, designed to carry 200 passengers at 2,000 mph. It is the largest model ever built in the U.S. for a supersonic transport.

The mockup is a 100-foot-long model of a future U.S. supersonic transport, designed to carry 200 passengers at 2,000 mph. It is the largest model ever built in the U.S. for a supersonic transport.

Important Deadlines Loom
FAA Expects SST Aircraft To Be In Commercial Service By 1974

The Federal Aviation Agency, which is directing the supersonic transport program under which we built the mockup, expects to announce its selection of a design to be built in commercial service by 1974.

Industry officials will say the FAA decision comes at a critical moment in the development of the SST.

The agency also is expected to announce its selection of a design to be built in commercial service by 1974.

The Lockheed design team says the result of work may be a 100-foot-long model of a future U.S. supersonic transport, designed to carry 200 passengers at 2,000 mph. It is the largest model ever built in the U.S. for a supersonic transport.

Double-Delta Wing Achieved An Aerodynamic Breakthrough

A major goal of aircraft designers—to provide a single-wing form that will fly with equal ease at subsonic and supersonic speeds—has been achieved in one double-delta wing design for the proposed U.S. SST.

LOOK UP THINGS TO COME—Here of the Lockheed 2000 supersonic transport comes, gracefully soaring. The 272-foot-long model is the most complete engineering model of a future military war bird. The model now looms 15 stories to create passion for school, industry flight, and landing gear and more landing gear extend into the hangar. The model assembly is produced in plywood and plastic the British Concorde proposed in our commercial SST design.

Double-Delta Wing Achieved An Aerodynamic Breakthrough

A major goal of aircraft designers—to provide a single-wing form that will fly with equal ease at subsonic and supersonic speeds—has been achieved in one double-delta wing design for the proposed U.S. SST.

Above: the June 27th 1966 issue of The Lockheed Star announcing the unveiling of their full-scale SST mockup

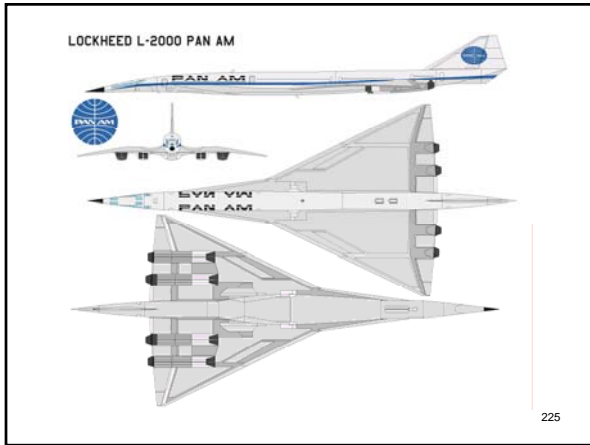

Atypical for an aerospace company of the day, North American Aviation opted to take a more conservative developmental approach to supersonic transport design by building on design, engineering and flight experience by using modified XB-70 "Valkyrie" bomber as an SST test-bed. By using this approach, NAA expected the experience to uncover various issues ahead of the actual design and production as well as service entry of a commercial SST. It was expected to provide 4K-5K flight hours of testing data before the final SST design was adopted. Therefore, NAA never planned for an actual SST design independent of the XB-70.

Left: artist's concept/s of an NAA commercial SST adapted from NAA's XB-70 Valkyrie bomber project
Right: collection of NAA SST model designs (ca. late 1963)

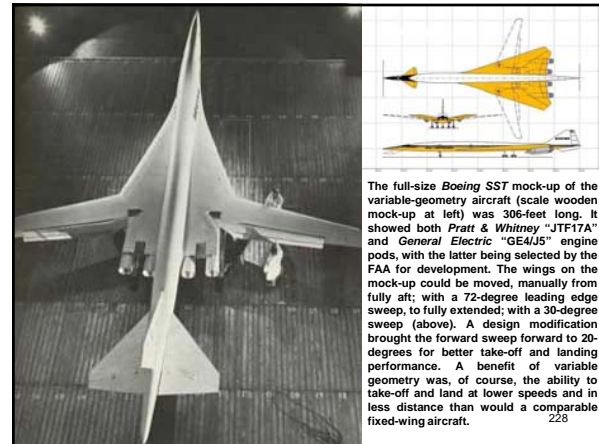

The full-size Boeing SST mock-up of the variable-geometry aircraft (scale wooden mock-up at left) was 306-feet long. It showed both Pratt & Whitney "JTF17A" and General Electric "GE4J5" engine pods, with the latter being selected by the FAA for development. The wings on the mock-up could be moved, manually from fully aft, with a 72-degree leading edge sweep, to fully extended; with a 30-degree sweep (above). A design modification brought the forward sweep forward to 20-degrees for better take-off and landing performance. A benefit of variable geometry was, of course, the ability to take-off and land at lower speeds and in less distance than would a comparable fixed-wing aircraft.

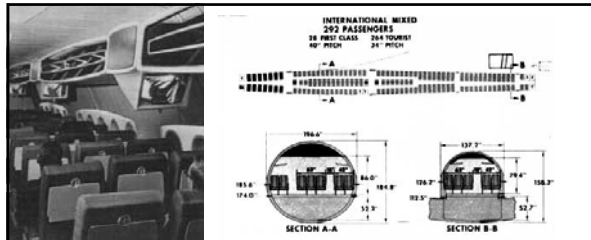

INTERNATIONAL MIXED
292 PASSENGERS
30 FIRST CLASS 264 TOURIST
80" PITCH

SECTION A-A
SECTION B-B

Seating was to be seven abreast, two seats each side with three in the centre, and two aisles. The mock-up was fitted with 277 seats (30 first-class and 247 tourist). The impression on entering the cabin was that the so-called "narrow" part of the fuselage was noticeably wider (about four-feet) than any contemporary jet transport. The cabin length was interrupted by two galley/toilet areas. Wardrobe racks, galley tray containers and bar units could be removed from stowed positions and wheeled up and down aisles. Overhead luggage racks included restrainers, and were capable of housing items which usually had to be stowed under passengers' feet.

Above: full-size cabin mockup (left), plan/section/s (right)

229



Like its European competitor Concorde, the Boeing SST had a variable nose geometry to improve flight deck forward views on approach. Boeing used a double-hinge, with the section forward of the cockpit angling down but the nose cone maintaining a similar axis to that of the fuselage. With the nose raised, minimum ground clearance was 8-feet, 9-inches, reducing to only 4-feet with it lowered.

Above: full-size mock-up of the 733's cockpit
Left: view of the full-size mock-up's variable nose

230

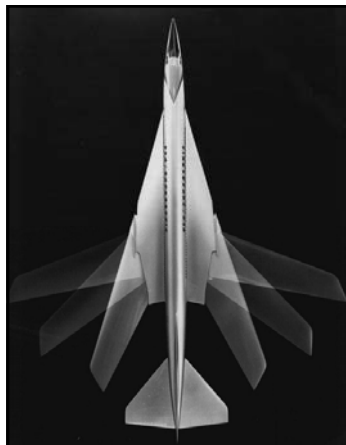

Boeing predicted that if design and construction of prototypes began in early 1967, the first flight could be made in early 1970. Design and fabrication of production aircraft could begin in early 1969 with the flight testing in late 1972. The first aircraft could then be certified and introduced to airline service in mid-1974. By 1980 the company estimated there would be a market for a larger "Model 390-475" SST, with between 700 and 1K aircraft being required.

231

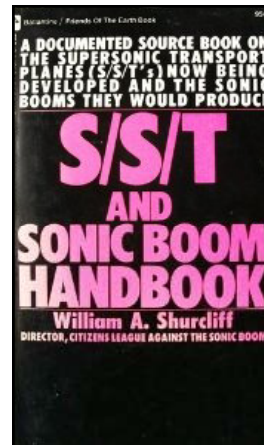

A DOCUMENTED SOURCE BOOK ON THE SUPERSONIC TRANSPORT PLANES (S/S/T's) NOW BEING DEVELOPED AND THE SONIC BOOMS THEY WOULD PRODUCE

S/S/T AND SONIC BOOM HANDBOOK

William A. Shurcliff
DIRECTOR, CITIZENS LEAGUE AGAINST THE SONIC BOOM

The Boeing SST suffered great opposition, especially from environmentalists. The major problem was the sonic boom. A "User's Sonic Boom," written by William Shurcliff (left) stated that a single flight would: "...leave a zone crash fifty miles wide by 2,000 miles in length..." which would cause serious problems for the population and environment in the over-flight area. Working from his home, Shurcliff; a physics professor at Harvard, set up the "Citizens League Against the Sonic Boom," in early 1967. Other environmentalists said the nitrogen oxides emitted by the engines at high altitude could affect the ozone layer of the stratosphere. Residents of nearby airports joined the opponents of the project because engines with afterburners on take-off are very loud. Oklahoma City was over-flown at high altitudes by supersonic USAF aircraft in a 1965 experiment resulting in 9,594 noise complaints registered with local authorities.

232

"...it is expected that about 65 million people in the United States could be exposed to an average of about ten sonic booms per day...A boom will initially be equivalent in acceptability to the noise from a present-day four-engined turbofan jet at an altitude of about 200 feet during approach to landing, or at 500 feet with takeoff power, or the noise from a truck at maximum highway speed at a distance of about 30 feet."

Karl Kryter, Sonic-Boom Specialist - Stanford Research Institute

233

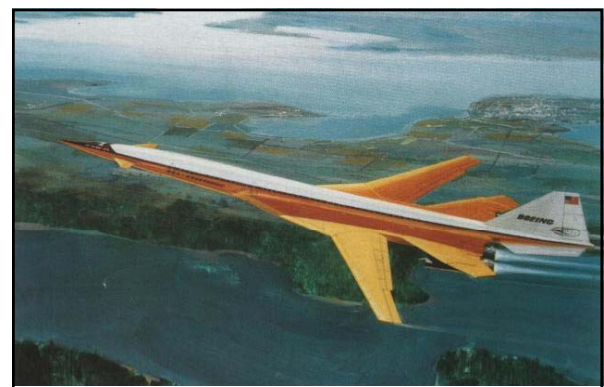

Above: caption: "Artist's conception of the Boeing 2707-200 variable geometry SST airliner, 1967 version"

234

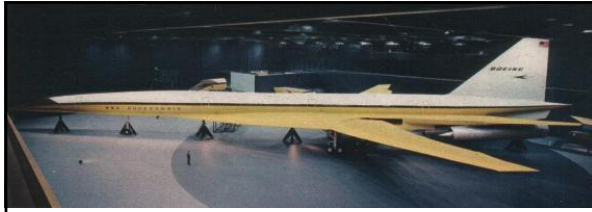

The *Boeing* variable-geometry SST dream was never realized. The variable-sweep wing idea was abandoned (due to excessive hinge weight) in October 1968 and the 2707-300 was cut to 234 seats with a fixed delta wing mounted ahead of a horizontal tail. It used essentially the same fuselage and engines as the preceding version. A full-size wooden mock-up and two prototypes were begun in September 1969. By this time, the project was already two years behind schedule and the Anglo-French *Concorde* had already made its first successful flight; on March 2nd 1969. Amid growing public protests against *Concorde*, the *U.S. Senate* closed down the *Boeing SST* program completely on March 24th 1971.
Above: caption: "Side view of the Boeing 2707 full-size mockup" 235



The design of the *Boeing SST* left an important technical legacy for the *Boeing Company* and aviation as a whole, especially its innovative variable-geometry wing design. In the wake of the SST debacle, Seattle-based Boeing was reinvigorated by the success of the *Boeing 737* and *747*, introduced in 1968 and 1969 respectively; two of the biggest successes in the history of commercial aviation. The full-size wooden mock-up of the *Boeing 733* was on display in *Kissimmee, Florida*, from 1973 to 1981. It is currently on display at the *Hiller Aviation Museum* (above) in *San Carlos, California*. The two unfinished prototypes were scrapped. 236



Above L&R: the 733 mock-up's variable nose in raised (left) and lowered (right) positions at the *Hiller Aviation Museum*
Left: view of the 733 mock-up's cockpit 237

Part 5
This is the Concorde
238

"This is it! This is the Concorde, the first airliner that will offer the thrill of supersonic flight to the average passenger. You, or anyone, will now be able to board this plane and break the forbidding sound barrier, fly at more than twice sound's speed, and streak into a world where no bird has been, nor man either except for that happy breed of military and test pilots. They paved the way so you may follow. Now the limits of flight seem less limited. The Concorde will take you from New York to London in 3 hours and 22 minutes, and no point on earth is less than 12 hours away. Besides supersonic flight, the Concorde offers several other firsts for commercial aviation. It's the first airliner with a delta wing, the first to change its configuration while in flight, and the first jetliner to introduce sound suppressors on its engines..."
Popular Mechanics, March 1968
239

No More than a Pond
240

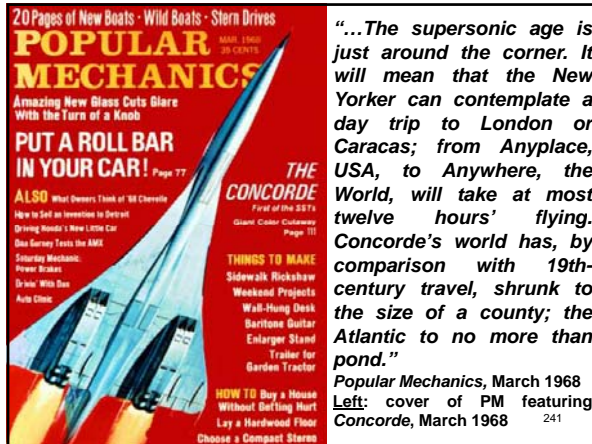

“...The supersonic age is just around the corner. It will mean that the New Yorker can contemplate a day trip to London or Caracas; from Anyplace, USA, to Anywhere, the World, will take at most twelve hours' flying. Concorde's world has, by comparison with 19th-century travel, shrunk to the size of a county; the Atlantic to no more than pond.”

Popular Mechanics, March 1968
 Left: cover of PM featuring Concorde, March 1968 241



Entente Cordiale

242



The Concorde grew out of a strong base of experience, in both Great Britain and France, in commercial aviation as well as supersonic flight. Britain's Sir Frank Whittle had invented the jet engine, after all. Americans had, for a time, been little more than prodigy's of the British, with General Electric building British-designed engines under license. De Havilland, a leading British aerospace company, parlayed this engine technology into the Comet (above), the world's first commercial jetliner. Though it targeted the transatlantic market, it proved uneconomical and failed to compete with the 707 and DC-8. It did, however, demonstrate a clear penchant for innovation and daring. 243



The French followed with the Caravelle, a small short-range jetliner built by Sud Aviation in Toulouse. Significantly, its engines also were British; Avon turbojets from Rolls Royce, with 12,600 pounds of thrust. In this fashion, the Caravelle set a precedent for future Anglo-French cooperation. It sold well in Europe and won sales in the United States as well. United Airlines bought twenty of them (above), putting the first ones in service in mid-1961. For France, this was a major breakthrough. Never before had a French manufacturer sold aircraft to a U.S. airline. 244



Frenchman Marcel Dassault spent the 1950's leading his country into supersonic flight. The company he headed; Avions Dassault, built the Mystere IV-B (left) fighter aircraft; the first European airplane to break the sound barrier in level flight. In October 1958, another Dassault aircraft; a Mirage III-A (right), became the first European aircraft to fly at Mach 2. Besides the French Air Force, both the Mystere and Mirage saw service in the Air Forces of many nations around the world, typically serving as their front-line fighter. 245



The British were also making significant progress in transonic and supersonic flight. The firm Fairey built an experimental jet; the Delta FD-2 (left). In March 1956, it set a world speed record at Mach 1.71 (1,132 mph). Another British company, Bristol Siddeley, developed a highly capable engine called the "Olympus" (an upgraded version would power the Concorde). Since 1948, the annual Farnborough Air Show (right) in Hampshire, England has become a major event in the aeronautical world and the Royal Aircraft Establishment at Farnborough a center for aeronautical research. 246

Two Companies, One Project

247

Thus, two aerospace firms; *Sud Aviation* and *British Aircraft* carried through the design studies that led to the *Concorde*. For the engine, *Bristol Siddeley* cooperated with *SNECMA*, a French firm that had built engines for the *Mirage* fighters of *Dassault*. As design concepts took shape, leaders in both *France* and *Great Britain* nurtured the hope that they might leap past the era of subsonic jets in which the *United States* had taken a strong lead and take the initiative in a new realm of supersonic flight. *France*, led by nationalist president *Charles de Gaulle*, had reasons of its own to proceed. De Gaulle had vowed to challenge what he called "America's colonization of the skies," and he won strong support from his nation. There was widespread resentment of American corporations that were dominating a host of European markets, including commercial aviation. Ironically, this resentment was quite similar to what Americans themselves would feel, two decades later, as *Japan* took over increasing shares of the automobile and electronics industries. The joint commitment to *Concorde* took the form of an inter-governmental agreement in November 1962, with the force of a treaty. Each nation agreed to carry half the cost. In turn, the four participating companies; *Sud*, *British Aircraft*, *Bristol Siddeley* and *SNECMA* would all work as contractors to their respective governments.

248

The Government of the United Kingdom of Great Britain and Northern Ireland and the Government of the French Republic. Having decided to develop and produce jointly a civil supersonic transport aircraft; have agreed as follows:

Article 1
 (1) The principle of this collaboration shall be equal sharing between the two countries, on the basis of equal responsibility for the project as a whole, of the work, of the expenditure incurred by the two Governments, and of the proceeds of sales.
 (2) This principle, which shall be observed as strictly possible, shall apply, as regards both development and production (including spares), to the project considered as a whole (airframe, engine, system and equipment).
 (3) The sharing shall be based upon the expenditure corresponding to the work carried out in each country, excluding taxes to be specified by agreement between the two Governments. Such expenditure shall be calculated from the data of the present agreements.

Article 2
 The two Governments having taken note of the agreement dated 25 October 1962 between *Sud Aviation* and the *British Aircraft Corporation* (BAC) and of the agreement dated 28 November 1961, between *Bristol Siddeley* and the *Societe Nationale d'Etude et de Construction de Moteurs d'Aviation* (SNECMA) have approved them with provisions, which are the subject of agreement between Governments.

Article 3
 (1) The technical proposals, which shall form the basis for the joint undertaking by *Sud Aviation* and BAC, comprise a medium range and a long range version of the aircraft.
 (2) The *Bristol Siddeley - SNECMA BS/593V* turbojet engine shall be developed jointly for the

Article 4
 In order to carry out the project, integrated organisations of the airframe and engine firms shall be set up.

Article 5
 A Standing Committee of officials from the two countries shall supervise the progress of the work, report to the Governments and propose the necessary measures to ensure the carrying out of the programme.

Article 6
 Every effort shall be made to ensure that the programme is carried out, both for the airframe and for the engine, with equal attention to the medium range and the long-range versions. It shall be for the two integrated organisations of the British and French firms to make detailed proposals for the carrying out of the programme.

Article 7
 The present Agreement shall enter into force on the date of its signature. In witness whereof by their respective Governments, having signed the present Agreement. Done in duplicate at London, this 29th day of November 1962 in the English and French languages, both texts being equally authoritative.
 For the Government of the United Kingdom of Great Britain and Northern Ireland:
 JULIAN AMERY
 PETER THOMAS
 For the Government of the French Republic:
 G. DE COURCEL

249

"...The Concorde is unique as an international venture. It's the sort of brave partnership normally attempted only in the emergency of wartime. Nominally, France and England each builds an equal number of the planes. In practice, all the wings, center sections of the fuselages and the undercarriages are made in France, while the noses, tails and engines are built in Britain. Special low-loading trailers carry the parts to and fro across the channel. Six times a week a private jet speeds between Bristol and Toulouse, carrying engineers and executives to a day's work abroad. To help with the language problem, there's even an Anglo-French aeronautical dictionary, in which 'sonic boom' comes out, surprisingly, as 'boom sonique.'..."
Popular Mechanics, March 1968
 RE: initially, the British sought an American joint-venture in developing an SST. Finding no interest in such an undertaking on this side of the pond, they looked across the channel; to *France*, for a partner and found one.

250

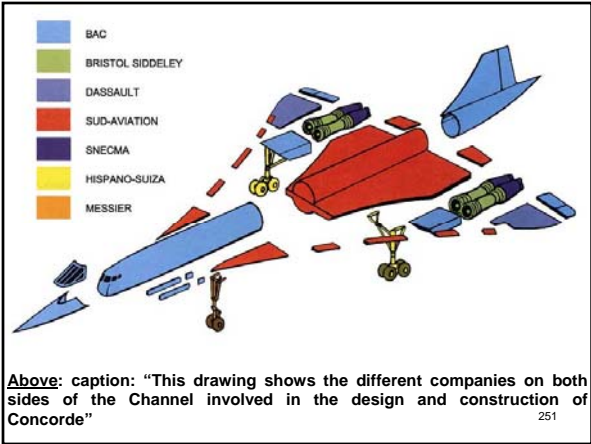

PERT

252

"...Automation and the computer have played a bigger part in the Concorde than in any other plane. The whole construction program was worked out by an American management aid called PERT (Program Evaluation and Review Technique). Much of the mechanical work is controlled by magnetically taped instructions to the multitude of power tools. During engine testing, the French and English test stations and the associated government research institutions were all wired to one computer link. Urgent results could thus be swapped – with complete accuracy – 20 times faster than by telephone..."

Popular Mechanics, March 1968

RE: when, in November 1962, the British and French governments agreed to develop and build a supersonic airliner, they and the manufacturers knew that there would have to be an exhaustive research and development program before the aircraft could be certificated for passenger operation. Even those closest to the project did not, at that time, foresee the full-scale complexity and cost of the program. The Concorde engineering team was working on the frontiers of technical knowledge and preparing to venture into areas not hitherto explored by commercial aircraft designers. They could not know where their research would lead them or what unpredictable problems might be ahead. In the end, the Concorde test program would require more than a decade of research on the ground and nearly 5K hours of flight development, by far the most thorough and comprehensive program ever mounted in support of a civilian aircraft type up to that time. In the earlier years of the program, the research effort was concentrated principally in aerodynamics, materials and structures. While this was going on, the engineering organization faced up to the difficult task of formulating a preliminary aircraft design, sufficiently detailed to enable marketing discussions with potential customers to be started.

253

"During the general assembly meetings of AICMA and Eurospace held in London recently, the British and French technical directors of the Concorde project presented papers outlining the basic concepts of this pioneer SST design. It is now just over a year since the Anglo-French agreement was signed, and this was the first time the team leaders had spoken publicly at any length about the Concorde's technical features. Monsieur P. Satre, technical director, spoke about the aerodynamic conception, and Dr. A.E. Russell, the vice technical director, described some of the structural issues and gave 'some of the reasons to justify the whole endeavour.' M. Satre began by recalling that Sud Aviation started preliminary research on the optimum design for a Mach 2.2 airliner in 1959. By 1961 this had led to the now familiar gothic-wing planform with a single fin. He went on: 'It is worthy of note that simultaneous but independent research by BAC had arrived at identical conclusions, and this was one of the essential factors underlying the decision made in 1962 to combine the efforts of the two companies into a single project'..."

FLIGHT International, December 1963

254

Five Objectives

"...Aerodynamically the Concorde has been evolved in such a way as to satisfy five main objectives: supersonic cruise; good performance for the various flight conditions; excellent flight characteristics; maximum simplicity; and wing volume enough to contain the necessary fuel. Commenting on the aims, M. Satre said: 'The quest for good performance levels outside supersonic flight conditions is necessary for maximum operational flexibility. Easy take-off and landing must be guaranteed, and it is desirable to have ample scope in selecting climb and descent patterns. Also it is important to minimize the occasions when engine failure would force the pilot to complete the flight subsonically. By reducing fuel reserves their effect on operating costs must be lessened. Supersonic flight led to the addition of stabilizing devices, but the search for good flying qualities should facilitate the development of flight-control systems and should ensure that, in case of breakdown of auxiliary stabilizing devices, the aircraft remains fully controllable. Such devices will not be used to obtain acceptance of mediocre flight characteristics...'"

FLIGHT International, December 1963

256

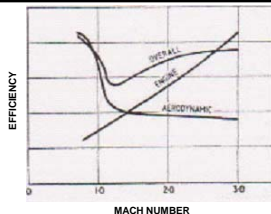

"...In choosing a cruising Mach number of 2.2, M. Satre noted that with regard to overall aerodynamic efficiency there is little advantage in flying any faster (Fig. 1). 'If we wish to consider operating cost factors, Mach 3 to 3.5 would in theory offer an improvement, but complications relating to structure, systems and fuel costs would have to be considered. At Mach 2.2 and with a delta wing, relatively large wing variations are possible without modifying cruise L/D ratio significantly...'"

FLIGHT International, December 1963

Above: caption: "Fig. 1: From the point of view of aerodynamic efficiency there is little to gain at cruising speeds much beyond Mach 2.2. This diagram, presented by M. Satre, shows how the major components of overall aerodynamic efficiency vary."

257

The Slender Delta

258

Every supersonic aircraft design presents the aerodynamicist with a range of difficult problems, including two which are of critical importance. One is the aerodynamic aspects of the powerplant installation. Propulsion is a critical factor in subsonic aircraft design, but it is even more crucial to the success of a supersonic aircraft and more difficult to achieve because of the widely varying airflow demands of the engine in different phases of supersonic flight. The second concerns the airframe configuration. To meet it, the aerodynamicist has to produce a satisfactory compromise between two inherently conflicting requirements; the need for minimum drag in supersonic flight and the need for controllability and ease of handling in subsonic flight, particularly in landing and take-off. Trim tabs, spoilers and other external moving surfaces used in subsonic aircraft control cannot be used in a supersonic airliner design since they would cause excessive drag. These considerations had a profound influence on the adoption of a long, streamlined fuselage and slender delta wing as the basic Concorde configuration (above). Proving the validity of this aerodynamic shape required 5K hours of studies in subsonic, trans-sonic and supersonic wind-tunnels, supported by large-capacity computers and extensive research. From this long, tedious process, the original design emerged refined and enlarged, but not fundamentally changed. Ground studies, backed by later flight experience, fully vindicated the earlier decision to avoid any form of variable-geometry wing as a means of achieving the supersonic-subsonic performance compromise. In supersonic military aircraft design, where operational economics is of secondary importance, the "swing wing" was a favored solution to this problem, at the time. However, the weight and complexity of the swing-wing hinge mechanism ruled it out for commercial application/operation.

"...The Concorde has none of the complications of 'variable-geometry' wings; endless trials, calculations and wind-tunnel tests showed designers how to build a slim, wingless-shaped delta wing that would be efficient both below and above the speed of sound. So thin they hardly look able to support the aircraft's 188-ton loaded weight, the 83-foot span wings derive their lift from a highly intricate and sophisticated cambering and curvature. The whole plane resembles that most elegant and basic aircraft, a schoolboy's paper dart..."

Popular Mechanics, March 1968

RE: the "slender delta" wing on Concorde had the appearance of total simplicity. In spite of this, there was probably no one area on the aircraft where more attention was paid to its design and construction. On the wing of a traditional subsonic aircraft there may be well over fifty moveable devices, including those for control and trim of the aircraft and the often complex flaps and leading edge slats for the generation of additional lift at slower speeds. Concorde had none of these. In fact, the Concorde delta wing only had six trailing edge "elevons" that replaced the traditional elevators and ailerons that allow control of both pitch and roll of the aircraft. As aircraft speeds have increased over time, the amount of "sweepback" that can be seen on the wings has also increased. The slender delta that featured on Concorde took this one step further. Looking head-on at the Concorde wing (above), it does not just sweep back (55-degrees) but it twists and droops, making what appears to be a very simple design in reality, very complex. It is the intricacies of this design that allowed Concorde to generate sufficient lift at low speeds by increasing the angle of attack of the wing, but also to perform very efficiently at high speeds as it generates very little drag.

"...The pitching inertia is less than that of the largest present-day machines, and moreover the aerodynamics of the aircraft allow advantage to be taken of ground effect during the final phase of landing. It is possible to perform the flare-out without changing the aircraft's attitude. This may be the procedure recommended for this aircraft, and it would lead to very low vertical speeds at touchdown, and so to very comfortable landings, and to a very much simplified procedure for the pilot, who would be assured of a perfect landing once the approach speed was correct..."

Monsieur P. Satre, Concorde Technical Director (1963)

RE: the control problem in a pitching plane is essentially linked, on the one hand, with pitching inertia and on the other with the extent of attitude change during a typical maneuver, such as landing

Left: caption: "Three elevons on each wing, that control roll and pitch"

Right: caption: "A two-piece rudder that controls yaw"

Above: caption: "When the elevons move together in the upwards direction, they cause the aircraft to pitch up, similarly when they move together in the downwards direction the aircraft will pitch down"

Above: caption: "When the elevons are deflected differentially they provide roll control, and behave in a similar way to a traditional aircraft's ailerons"

Above: caption: "Combining the two types of elevon deflection simultaneously controls the pitch and roll of the aircraft in flight"

Each of the eight flight control surfaces was independently controlled by a "Powered Flying Control Unit" (PFCU). The PFCU (top left) was actuated by an electro-hydraulic twin-ram servo system with either the blue, green or yellow standby hydraulics powering either of the rams. The PFCU's (top left) end stops allowed the inner elevons/nine-degrees of travel up or down and the outer/middle elevons could travel 23.5 degrees up or down. The end stops on the rudder allowed a travel range of thirty-degrees in either direction. The actual travel limits (controlled by the fly-by-wire mixing unit) were a little less than these mechanical maximums. Hydraulic power to the servo control panel on the flight deck, at lower left) with the Yellow standby system available for use if required in an emergency. The Green, Blue and Yellow hydraulic systems were powered by engine-driven pumps at a pressure of 4K-psi. The hydraulic system was distributed across all four engines to offer complete redundancy. The Green system was run from engine Nos. 1 and 2, the Blue system from engines Nos. 3 and 4 and the standby Yellow system from engines Nos. 2 and 4.

"Initially, research was aimed at a delta wing with a foreplane because of the large lift obtained. But it was soon shown that, with such a solution, low-speed handling problems were very difficult to solve. At large angles of attack especially, a canard surface forward of the main wing generates eddies which may seriously disturb flows around the other aircraft elements. In particular, the fin is greatly affected by the interaction of the canard surface, and in the case of a single mid-fin a directional instability occurs at angles much lower than those in normal approach and landing conditions. The canard solution thus makes necessary the adoption of two symmetrical fins, the one to compensate the other's inefficiency when it goes through the unfavorable interaction field of the foreplane; this solution involves a weight penalty. Even this would not entirely solve the problem since the gap between the fins is conditioned by another phenomenon affecting longitudinal stability. Low-speed aerodynamic behavior of delta wings is typified by the existence of a conical vortex sheet attached to the leading edge. As soon as the leading edge of the fin base intercepts this vortex center a violent pitch-up occurs through general separation at the wing-tip at angles of attack which are smaller in proportion to increasing fin distance. It can thus be seen that the development of a canard solution does not merely consist in defining and avoiding the limits of an unfavorable phenomenon with an adequate safety margin, but also in making a compromise in a specific area, bound in on each side by anomalies presenting the same degree of importance. Such a compromise is difficult to achieve in wind-tunnels and still more in flight, since interactions are involved, and a displacement of the phenomenon between wind-tunnel and flight testing possible. This is difficult to accept in the case of a civil transport aircraft having to satisfy stringent airworthiness requirements."

Monsieur P. Satre, Concorde Technical Director (1963)

RE: explanation of why the canard layout had been rejected

“...The search for an optimum wing was therefore continued in the direction of the delta solution without canard surface. This led to the design and testing of a large number of different models. To reach the objectives which had been set out, it proved necessary to alter the planform, which is no longer a true delta shape since the wing leading edge curves inward near the root thus giving an increased sweepback, and the wing tips have been truncated resulting in the gothic planform. It was also recognized that the wing had to be given an appropriate camber and twist, particularly to reduce trim drag. The problem of trimming was also partly solved by a fuel-transfer system. The engines were positioned under the wing, on the one hand to make use of the natural high-pressure region, and on the other to confer extra lift on the wing by the air-intake...”

FLIGHT International, Dec. 1963 265
Left: TU-144 with, Concorde w/o Canard

“...Dr. Russell touched on the aerodynamic issues which M. Satre had already mentioned. By means of a diagram reproduced in Fig. 3, he showed the effect on the various aerodynamic limits for variations in slenderness ratio and angle of incidence...”

FLIGHT International, December 1963
Above: caption: “Fig. 3: How the major aerodynamic considerations vary against incidence with different slenderness ratios” 266

“...Design studies soon showed that it was not necessary to provide variable geometry for the wing, as its L/D ratios are quite acceptable in all flight configurations; moreover, it is almost ideal for its function as fuel tank. In this way it has been possible to avoid the disadvantages of the variable geometry solutions: weight, complexity, cost, stability problems, less space available for fuel tanks (this would make it necessary to house a large part of them in the fuselage, thus increasing its volume and causing reduced performance and flying qualities). Furthermore, variable geometry would increase the cost of the aircraft and maintenance cost; hence the direct operating cost...”

Monsieur P. Satre, Concorde Technical Director (1963) 267

“...Firstly the coiled vortex sheet which produces a non-linear lift increment above that which could be expected from theory (with trailing edge separation only) breaks down at certain combinations of incidence and slenderness ratio. Secondly, dutch roll, where in yaw the strength and location of the vortices on either side of the wing are affected by the leading edge shape, stability is unsatisfactory at lower angles of incidence and at higher values of sweep or slenderness ratio. Thirdly, the lift coefficient must be sufficiently high to allow satisfactory landing speeds with an angle of incidence obtainable without the need for an excessively long landing gear. High slenderness ratios are again unfavorable. The diagram shows that the chosen wing form of the Concorde, with its excellent supersonic drag values, also can give satisfactory low speed handling qualities without the need to incorporate either a foreplane or variable wing geometry. This particular solution, however, is not suitable for much higher cruise speeds. Thus it can be regarded as a coincidence that both this general arrangement of the aircraft and the use of aluminum alloys in its primary structure have very closely the same upper limit of suitability as regards design speed...”

FLIGHT International, December 1963 268
Left T&B: Concorde's port wing profile

“...On take-off we have high thrust/weight ratio, and a low wing-loading when landing; the remarkable aerodynamic characteristics of the gothic wing at low speed which benefits from natural additional lift resulting from the leading-edge vortices at landing angles of attack that persist beyond the normal operation limit without any sign of stall. The increase in lift obtained in this manner is of the order of 30 per cent in relation to that forecast and measured for normal flow. Moreover, an extremely favorable ground effect further increases the lift by 60 per cent at the moment of wheel touchdown. On landing, the aircraft has conventional wheel brakes and thrust reversers...”

Monsieur P. Satre, Concorde Technical Director (1963)
RE: on a traditional aircraft's wing a swirling vortex is formed only at the wing tips. On a delta wing at low speeds, such a vortex is formed nearly enough along the entire wing surface and produces most of the lift in those conditions. With Concorde's high angle of attack at low speeds the amount of vortex lift that is generated by the wing increases significantly. This was fundamental for Concorde to be able to fly at slow speeds during take-off and landing. On a damp day the vortex could be seen to fully envelop the upper surface of the wing, when the aircraft is flying at slow speeds and at a high angle of attack. The picture above shows the way the vortex forms above the wing and causes the water vapor in the air to condense, due to the reduction of pressure. 269

“...Other favorable characteristics of the wing are: in the approach configuration a high angle of attack, and the correspondingly high drag will ensure effective aerodynamic braking as soon as the pilot throttles back. When the nose-wheel has touched down and the aircraft is horizontal, lift becoming practically zero, the wheel brakes will become effective at once. In supersonic cruising flight the L/D ratio of the wing is of the order of 7.5 to 8; in subsonic cruise conditions, normal flow is restored, which, due to the type of camber chosen, makes it possible to obtain L/D ratios of the order of 13 to 14, which is about the same as those of four engine subsonic aircraft. Consequently, the fuel consumption per mile is no higher in subsonic flight than in supersonic. This quality offers many advantages: it is not necessary to provide special reserves for any subsonic flight demanded by noise considerations; reserves for stand-off and re-routing will be minimized since the L/D ratio in such conditions will be higher; the performance on short feeder routes makes for acceptable fleet economics; the high L/D ratio enables high rates of climb to be obtained, thereby reducing the noise heard on take-off and, moreover, as this ratio is maintained in transonic flight, reheat is not required for acceleration beyond Mach 1...”

Monsieur P. Satre, Concorde Technical Director (1963)
RE: another benefit of the large "ogival" delta shape of the wing was the ground effect that is created when the aircraft comes in to land. As the aircraft gets closer to the ground, the downwash of the air between the wing and the ground creates a cushion. Due to this air cushion, a landing on Concorde tended to be very smooth even though it was at a much higher speed. The Concorde wing was the best compromise between a wing that provides sufficient lift at low speeds but also had the right profile for flying at supersonic speeds. The supersonic cruise demands a long chord, relatively slight thickness and short wingspan, that provide a great deal of lift in the high speed domain with very little drag. During the design of the wing, over 5K hours of wind tunnel testing were carried out to modify its camber, droop and twist, to ensure that the vortex that would be formed along the wing would be stable at high angles of attack. 270

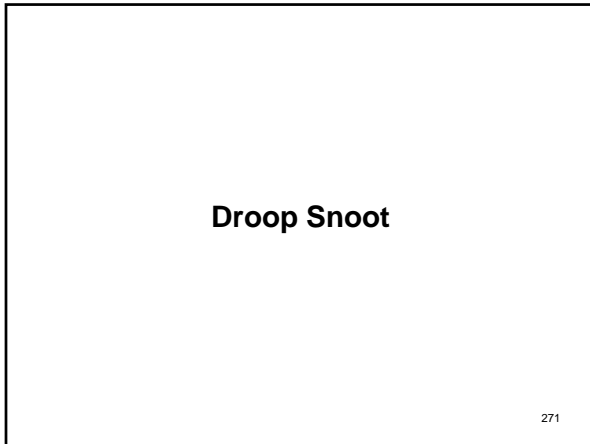

"...In the first sketches, it became clear that the Concorde must have an unusually long nose – so long (twenty feet in front of the pilot's controls) that visibility would be very poor for landing and take-off. To let the pilot see where he was heading, designers hinged the whole of the nose (which also doubles as a radome) to drop 17.5-degrees out of the way. In flight, the nose is lifted level with the rest of the fuselage, and for supersonic flight, a long visor rises from the nose to meet the top of the windshield, making the whole plane impeccably sleek and aerodynamically trim. As a contrast to the futuristic origins of the rest of the Concorde, the nose cones are made of about thirty layers of huge, conical, fiberglass stocking knitted by the elderly craftswomen of an old-established Scottish hosiery firm!..."

Popular Mechanics, March 1968

272

"...One hundred ninety-three feet long and only four seats and a corridor wide, the Concorde at rest is distinguished by a most unusual nose. Long and sharp like a cartoonist's mosquito, it appears to droop wildly toward the ground..."

Popular Mechanics, March 1968

RE: a movable nose is required on a supersonic airliner to give the pilot and co-pilot a good view of the runway on take-off and/or landing. Thus, the nose of a supersonic airplane, unlike the blunt rounded front end of the subsonic airliner, must be streamlined for Mach flight. It needs to be long and tapered to a sharp point, much like a needle. Concorde came in to land and take-off at a higher "nose-up" attitude than a subsonic aircraft. If fixed, the long nose could/would hamper the view from the flight deck on to the runway. To get over this problem, the nose unit (all that part of the fuselage forward of the flight deck) was made so that it could be lowered during landing and take-off and raised during the other phases of the flight. The "droop snoot" was composed of two sections: the main nose structure and the glazed upper section of the forward fuselage (known as the "visor") which could be lowered and/or raised independently. In supersonic cruise, the nose and the visor were raised. This streamlined the front-end of the aircraft to minimize air resistance and the visor protected the flight deck windows against kinetic heating and air pressure. Forward view from the flight deck was through the flight windows and the visor windows. At take-off and in the early stage of the subsonic climb, the visor and the nose were lowered to its intermediate position; five-degrees of droop. In subsonic cruise, the visor was lowered but the nose was raised. In the approach and at landing (also while taxiing at the airport), the visor was lowered and the nose put in the down position; 12.5-degrees of droop.

273

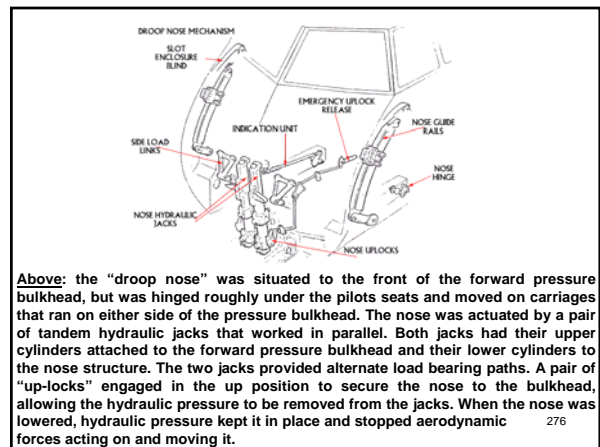
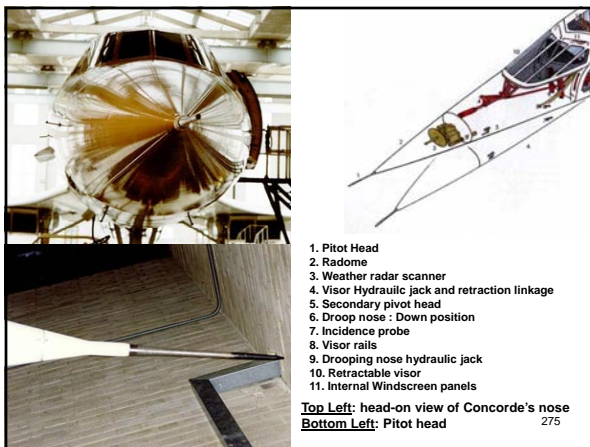
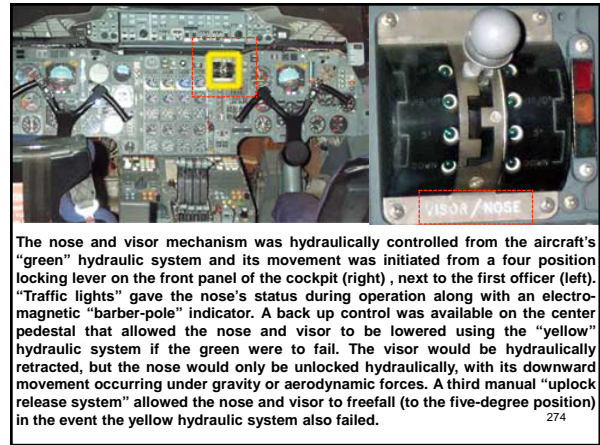

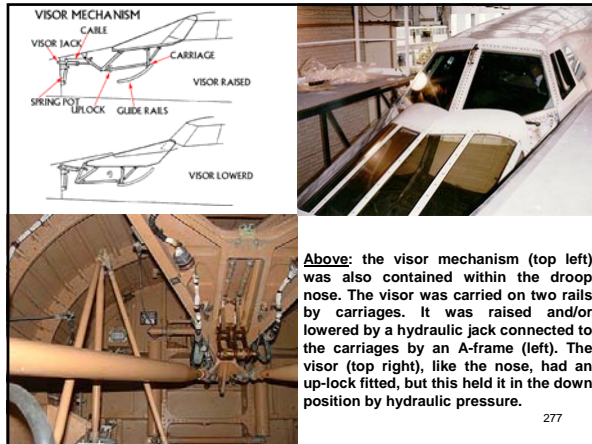

Above: the visor mechanism (top left) was also contained within the droop nose. The visor was carried on two rails by carriages. It was raised and/or lowered by a hydraulic jack connected to the carriages by an A-frame (left). The visor (top right), like the nose, had an up-lock fitted, but this held it in the down position by hydraulic pressure.

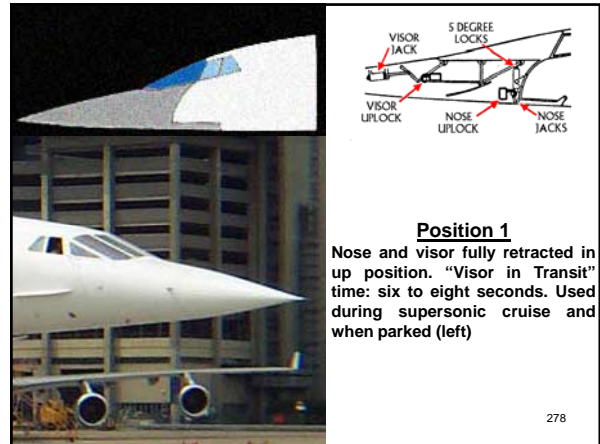

Position 1

Nose and visor fully retracted in up position. "Visor in Transit" time: six to eight seconds. Used during supersonic cruise and when parked (left)

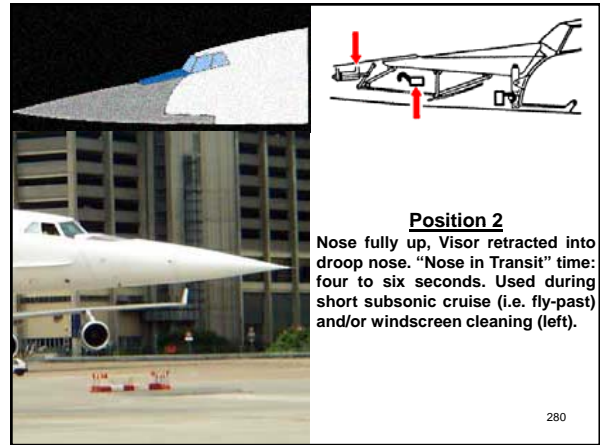
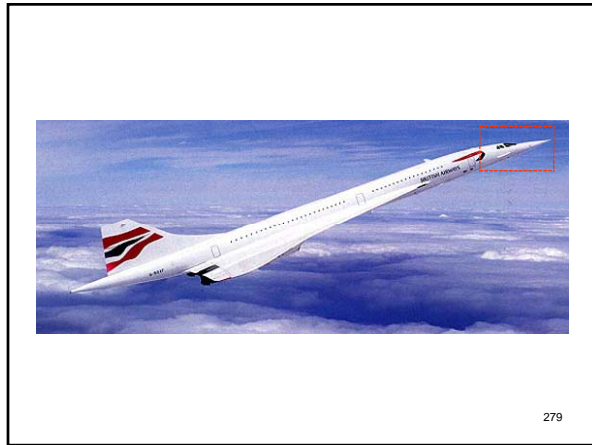

Position 2

Nose fully up, Visor retracted into droop nose. "Nose in Transit" time: four to six seconds. Used during short subsonic cruise (i.e. fly-past) and/or windscreen cleaning (left).

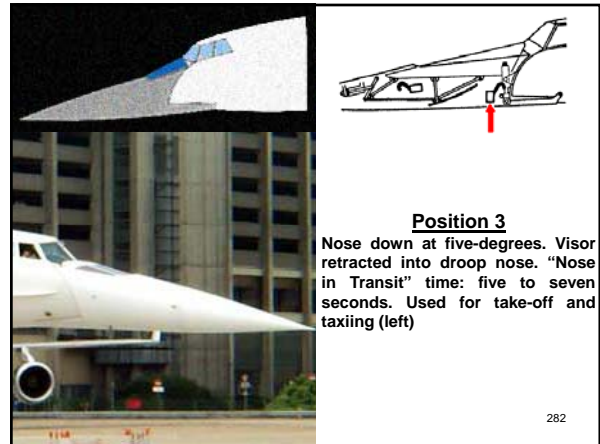
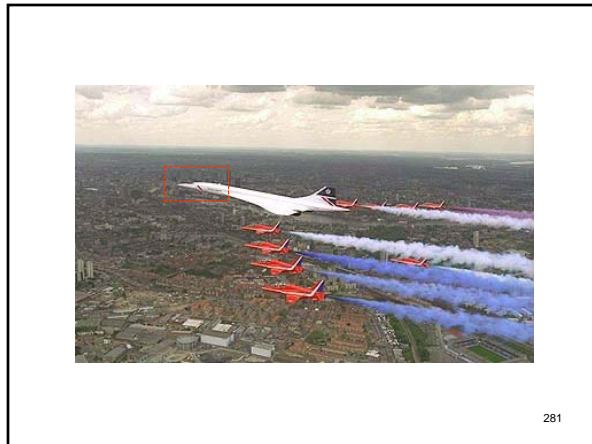

Position 3

Nose down at five-degrees. Visor retracted into droop nose. "Nose in Transit" time: five to seven seconds. Used for take-off and taxiing (left)

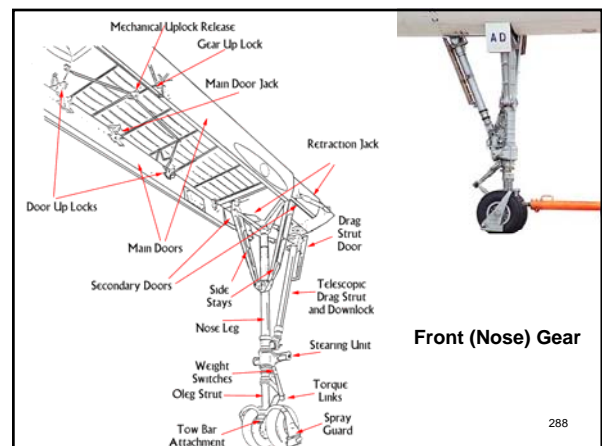
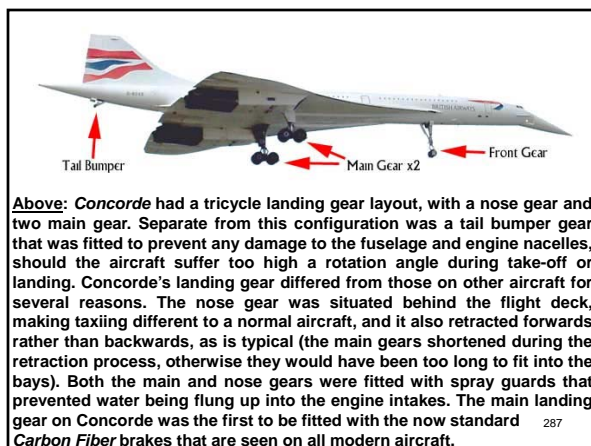
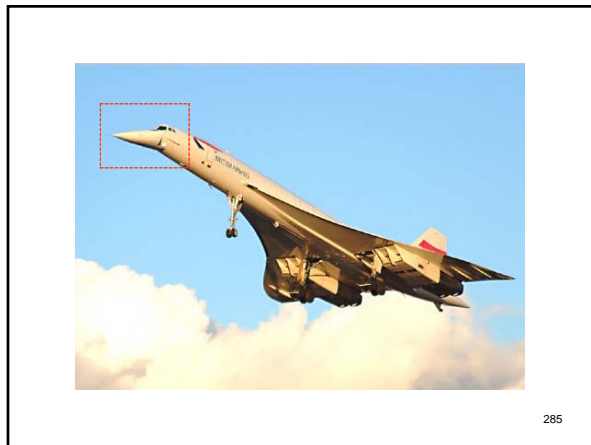
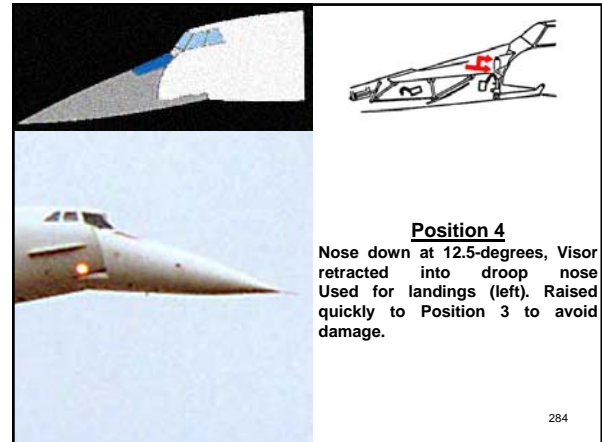

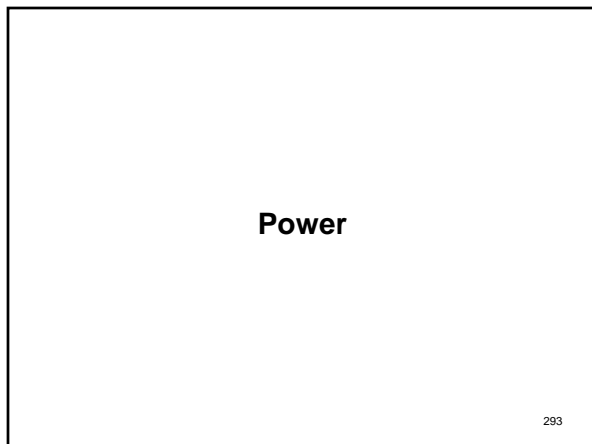
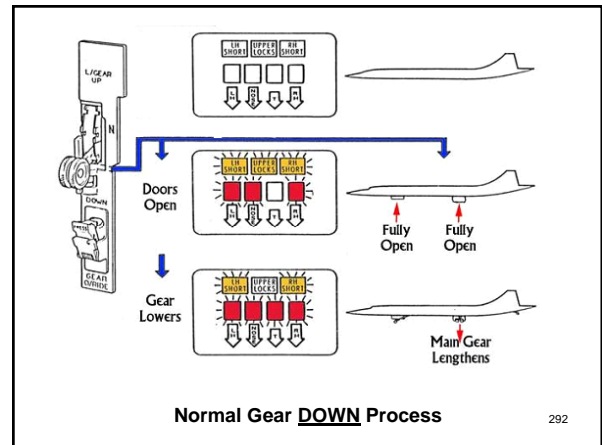
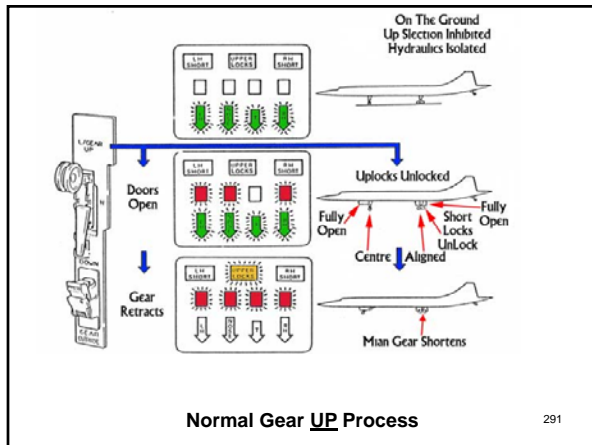
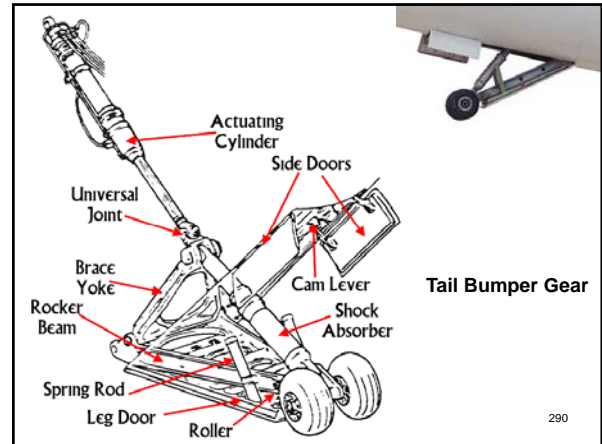
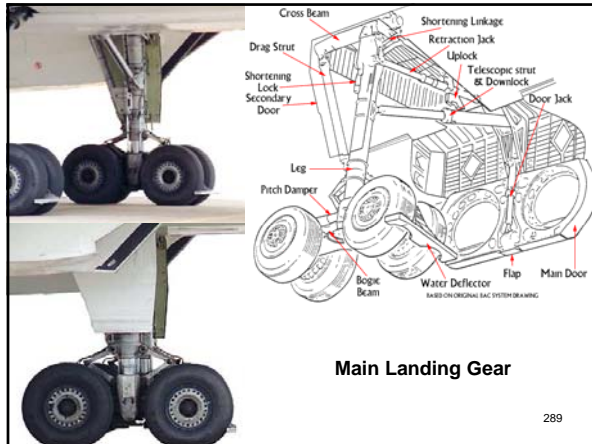

“...For engines, designers took the Olympus 320 meant for the now-defunct TSR 2, and worked from there. The basic principle, and the metallurgy, were proved to be fine. But this meant increasing the thrust from 30,000 lbs. (with afterburner) to 35,000 (without). For testing, they bolted it underneath a Vulcan bomber, flew it aloft, and then ran it under the surveillance of hundreds of gauges and four closed-circuit TV cameras. On the ground, they catapulted four-pound chickens, fusillades of hailstones, and gallons of oil into the air intake. Olympus 593 digested them all without so much as a cough. To guard against ‘buzz’ – a violent shockwave vibration caused by air entering the engine intake too fast – the 593 intake carries a complex system of ramps and spill doors to control the flow – all, of course, computer-controlled and linked to the autothrottle...”

Popular Mechanics, March 1968

294



"...For power, the Concorde will be whooshed upward and forward by four massive Olympus 593 turbojets, developed by Bristol Siddeley and the French firm SNECMA. They pack, in all, some 140,000 pounds of thrust, or almost enough power for the huge ocean liner 'United States.' So much of this power is in reserve that the plane will take-off from regular-length runways. The engines will get the aircraft to 40,000 feet in just eleven minutes, compared with a half-hour for a subsonic jet. The normal cruising altitude of 60,000 feet will be reached in 500 miles and only thirty minutes..."

Popular Mechanics, March 1968

Above: the Rolls-Royce/Snecma "Olympus" engines that were fitted to Concorde were a highly developed version of the Bristol-Siddeley Olympus that was fitted to the "Vulcan" bomber, which generated 11K-lbs of thrust. Roll-Royce provided the development of the Olympus engines while SNECMA developed the exhaust and reheat system. On the prototypes, this power plant system was upgraded to generate 33K-lbs of thrust and by the time it was fitted to the production aircraft, 38,050-lbs were available. The Olympus engines were "two-spool" engines (the inner shaft revolved within the outer shaft). The engine consisted of fourteen compressor stages (seven on each shaft) driven by their respective turbine systems. At supersonic speeds, when the air approaches the combustion chamber, it was very hot due to the high compression level of 80:1.

295

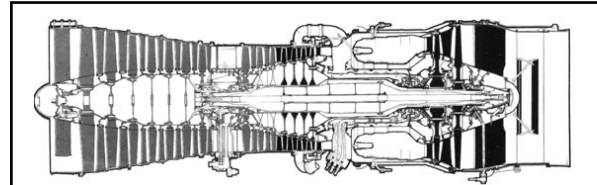

Above: caption: "The darker (black areas) are the areas more susceptible to heat and are thus constructed out of the nickel-alloy." To protect the later compression stages, the last four stages were constructed of a nickel-based alloy (nickel alloy was usually reserved only for the turbine area). The speed (RPM) of the engine's outer shaft was controlled by the amount of fuel being burned. By varying the surface area of the primary nozzle, the inner shaft's RPM could be controlled relative to the outer shaft's RPM. Concorde was the first civilian airliner placed in service with a "military style" afterburner system (installed to produce more power at key stages of the flight). The "reheat system" (as it was officially known) injected fuel into the exhaust and provided 6K-lbs. of the total available thrust per engine at take-off. This hotter, faster exhaust used on take-off was mainly responsible for the additional noise that Concorde made while taking-off. The reheats were turned off shortly after take-off when Concorde reached the "Noise Abatement Area" (NAA).

296

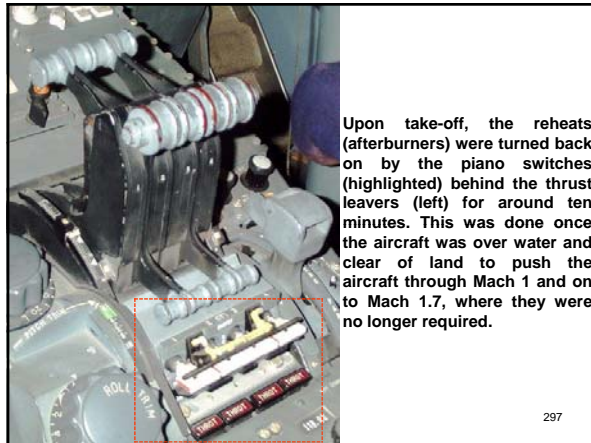

Upon take-off, the reheats (afterburners) were turned back on by the piano switches (highlighted) behind the thrust levers (left) for around ten minutes. This was done once the aircraft was over water and clear of land to push the aircraft through Mach 1 and on to Mach 1.7, where they were no longer required.

297

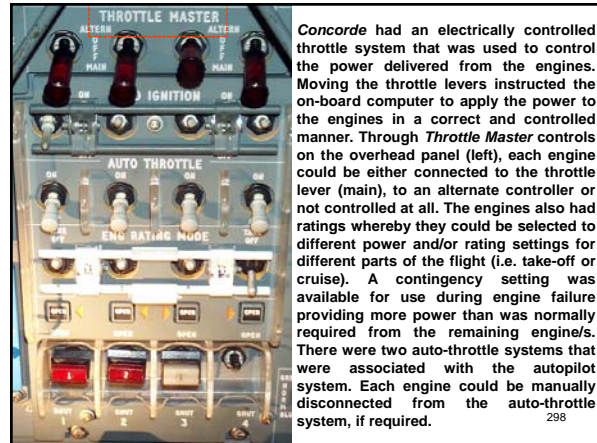

Concorde had an electrically controlled throttle system that was used to control the power delivered from the engines. Moving the throttle levers instructed the on-board computer to apply the power to the engines in a correct and controlled manner. Through Throttle Master controls on the overhead panel (left), each engine could be either connected to the throttle lever (main), to an alternate controller or not controlled at all. The engines also had ratings whereby they could be selected to different power and/or rating settings for different parts of the flight (i.e. take-off or cruise). A contingency setting was available for use during engine failure providing more power than was normally required from the remaining engine/s. There were two auto-throttle systems that were associated with the autopilot system. Each engine could be manually disconnected from the auto-throttle system, if required.

298



To further improve engine performance, the air flow through the engine area was varied at different speeds via a Variable Geometry Intake Control System (VGICS). Altering the airflow changed the amount of air available to the engine via complex ramp and nozzle assemblies. The air intake ramp assemblies' main job was to slow down the air being received at the engine face (above L&R) to subsonic speeds before it then entered the engines. At supersonic speeds, the engine would be unstable if the air being fed to it was also at a supersonic speed so it had to be slowed down before it got there.

299

The dual air intake ramp/s were controlled by eight "Air Intake Control Units" (AICU), two for each engine intake; Lane A and Lane B. The AICU's were the brains of the whole system and a great deal of the development work on the Concorde design was taken up in perfecting this important system which made supersonic cruise both achievable and affordable by constantly changing the positions of the ramps in respect to changes in airflow, air temperature, engine power and aircraft incidence. Seven out of the eight control units were required to be in working order, otherwise supersonic flight was unsustainable. Data such as true and indicated pressure along with the aircraft's level of incidence were fed to the AICU's via the "Air Intake Sensor Units" (AISU). The sensor units took the data from the relevant sensors on the aircraft in analog form and converted them to a digital data stream that could be processed by the AICU's. AISU sensors also fed directly to the AICU's the pressure and current positions of the ramps so that they could alter them as conditions dictated. The flight engineer had two main panels that allowed him to monitor both the status of the air intake processing and also the actual positions of the ramps. Today, digital computer technology such as this is commonplace, but for the 1970's, the system was well ahead of its time.

300

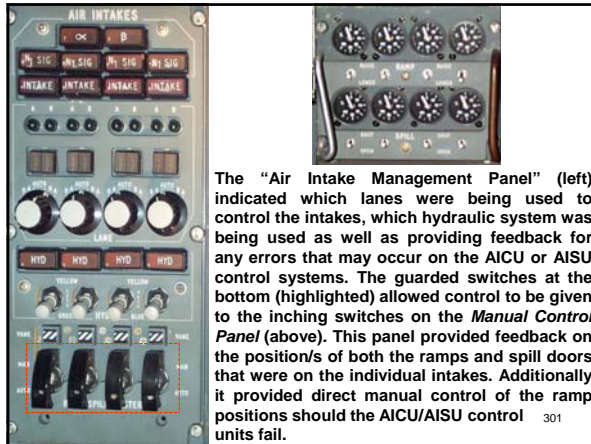

The "Air Intake Management Panel" (left) indicated which lanes were being used to control the intakes, which hydraulic system was being used as well as providing feedback for any errors that may occur on the AICU or AISU control systems. The guarded switches at the bottom (highlighted) allowed control to be given to the inching switches on the *Manual Control Panel* (above). This panel provided feedback on the position/s of both the ramps and spill doors that were on the individual intakes. Additionally it provided direct manual control of the ramp positions should the AICU/AISU control units fail.

301

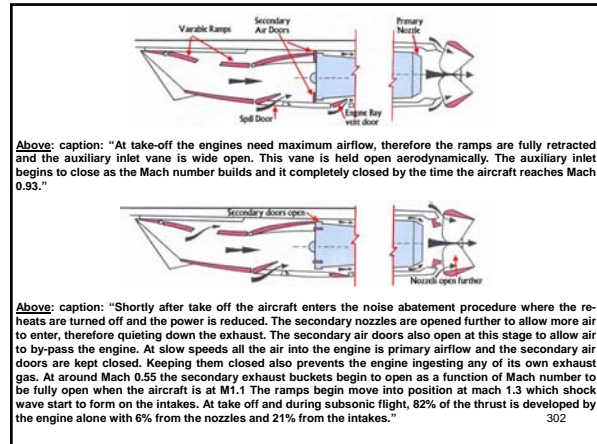

Above: caption: "At take-off the engines need maximum airflow, therefore the ramps are fully retracted and the auxiliary inlet vane is wide open. This vane is held open aerodynamically. The auxiliary inlet begins to close as the Mach number builds and it completely closed by the time the aircraft reaches Mach 0.93."

Above: caption: "Shortly after take off the aircraft enters the noise abatement procedure where the re-heats are turned off and the power is reduced. The secondary nozzles are opened further to allow more air to enter, therefore quieting down the exhaust. The secondary air doors also open at this stage to allow air to by-pass the engine. At slow speeds all the air into the engine is primary airflow and the secondary air doors are kept closed. Keeping them closed also prevents the engine ingesting any of its own exhaust gas. At around Mach 0.55 the secondary exhaust buckets begin to open as a function of Mach number to be fully open when the aircraft is at M1.1 The ramps begin move into position at mach 1.3 which shock wave start to form on the intakes. At take off and during subsonic flight, 82% of the thrust is developed by the engine alone with 6% from the nozzles and 21% from the intakes."

302

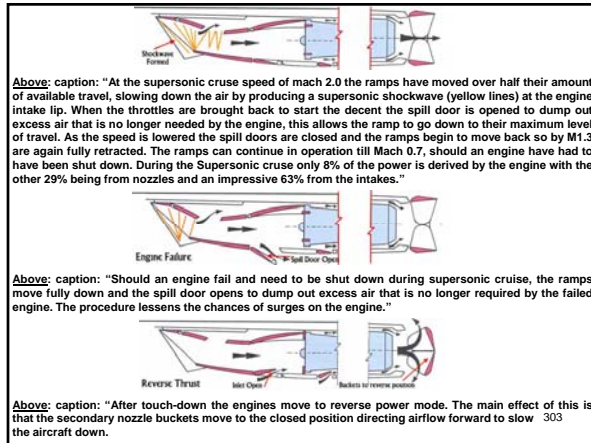

Above: caption: "At the supersonic cruise speed of mach 2.0 the ramps have moved over half their amount of available travel, slowing down the air by producing a supersonic shockwave (yellow lines) at the engine intake lip. When the throttles are brought back to start the decent the spill door is opened to dump out excess air that is no longer needed by the engine, this allows the ramp to go down to their maximum level of travel. As the speed is lowered the spill doors are closed and the ramps begin to move back so by M1.3 are again fully retracted. The ramps can continue in operation till Mach 0.7, should an engine have had to have been shut down. During the Supersonic cruise only 8% of the power is derived by the engine with the other 29% being from nozzles and an impressive 63% from the intakes."

Above: caption: "Should an engine fail and need to be shut down during supersonic cruise, the ramps move fully down and the spill door opens to dump out excess air that is no longer required by the failed engine. The procedure lessens the chances of surges on the engine."

Above: caption: "After touch-down the engines move to reverse power mode. The main effect of this is that the secondary nozzle buckets move to the closed position directing airflow forward to slow the aircraft down."

303

Although the same design as the other three engines, the starboard outboard engine required special treatment at slow airspeeds. In fact, the procedures relating to what needed to be done were not fully developed until *Concorde* was just going into passenger service in January 1976. The main issue was that, at slow airspeeds, the engine suffered vibrations on the low pressure compressor blades from air vortices that were created by the wing leading edge sections (entering it from both the air intake and fully open AUX inlet door) was moving in a counter-clockwise direction (which was opposite the engine's clockwise rotation). The effect was not seen on portside outboard engine No.1 since these vortices traveled in the same direction as the aircraft. Two solutions were adopted to smooth the airflow reaching the engine;

- The No. 4 engine was limited on take-off to 88% of No. 1 at speeds below sixty knots. A solenoid latched switch on the flight engineers' panel accomplished this task, and was automatically released by a signal from the "Air Data Computer" (ADC) to enable the No. 1 engine to rise back to the normal 97-99% level when the aircraft was above the sixty knot threshold. As such, the reheat flame on engine No. 4 was not as bright or stable as the other three during the initial take-off roll until the aircraft was moving at around sixty knots, when it matched the others.
- For air entering via the AUX inlet vane, a remedy was found that limited the opening of this vane by about four degrees. Compared to the other three engines, this reduced the buffeting to a tolerable level. Because of this, it could be clearly seen that the No. 4 AUX inlet vane was not as open as the other three on take-off.

304

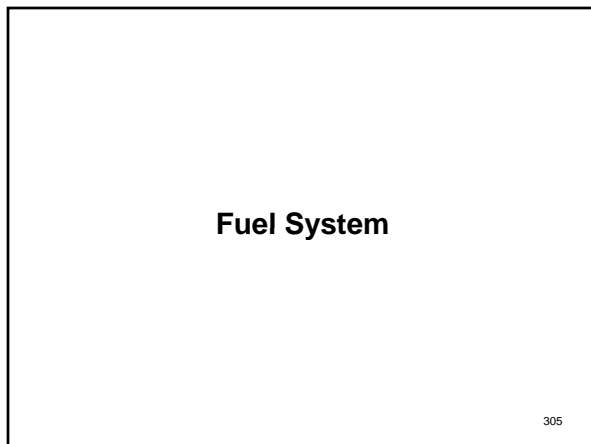

Fuel System

305

"...The other special characteristic of supersonic aircraft - and the *Concorde* is no exception - lies in the rearward shift of the aerodynamic center when the aircraft goes from subsonic to supersonic speed. In the case of the *Concorde* the aerodynamic center during subsonic flight is at about 50 per cent of the mean aerodynamic chord and moves back to about 60 per cent of the mean aerodynamic chord; this means a rearward shift of about 2.50m (8ft 3in). It is known that, in order to obtain good static longitudinal stability, the center of gravity must be located ahead of the aerodynamic centre but if it is located too far ahead, stability becomes excessive, in the sense that, to balance the aircraft, a high degree of elevon deflection would be needed, leading to an unacceptable increase in drag. It has therefore been found necessary to have recourse to a means of modifying the c.g. in flight. This is done by transferring fuel from the forward tanks to a trim tank, which is located in the rear fuselage. It will be easily understood that such a device must be absolutely fail-safe, since a return to subsonic flight with the supersonic center of gravity would produce a longitudinally unstable configuration. Safety of the fuel-transfer system will be obtained by duplicating the circuits and the transfer pumps, and by making it possible to drain the after-tank, as a last resort, by making use of the jettison system..."

Monsieur P. Satre, *Concorde* Technical Director (1963)

306

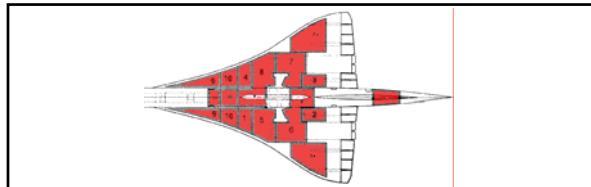

"...Stowed within the wings – and under the fuselage – are the plane's 18 fuel tanks. The Concorde holds a maximum of 95 tons of kerosene, about 15 tons of which is in reserve, enough to meet 45 minutes of airborne 'holding' and a 260-mile diversion. The fuel performs two other functions: Pumped to and from the rear tanks, it can adjust the plane's trim to cope with the different center of lift as speed changes, eliminating drag-producing trimming of control surfaces; it is also used as a 'heat sink' to absorb surplus heat extracted from the rest of the plane. Although it must be pressurized to keep it from boiling at high altitudes, the increased temperature of the fuel actually makes it more efficient..."

Popular Mechanics, March 1968
 Above: like all airliners, Concorde's multiple fuel tanks were located in the wings and/or fuselage. The difference being that during flight, fuel was transferred from tank-to-tank to maintain Concorde's trim and balance since it did not have a full tailplane which was/is used on a subsonic airliner to perform this task. Also, for supersonic flight, the Center of Gravity (CG) was critical and required to be adjusted for different speeds (when flying at Mach 2, it could move by six feet). On Concorde this was unacceptable due to the drag it would cause and reduction in flight control. The fuel was also used as a "heat sink" for cooling purposes. Surplus heat from the air conditioning and hydraulic systems, constant speed drive, generator and engine lubricating oil was passed through heat exchangers to the fuel. 307

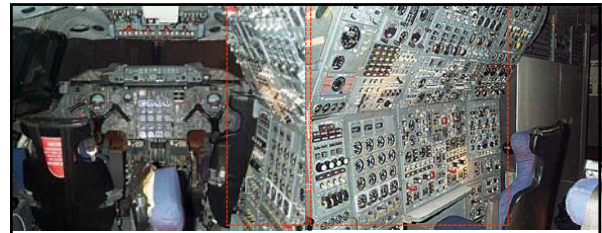

The Movement of fuel also provided additional benefits at lower (subsonic) speeds. Making Concorde aft-heavy during take-off and landing caused the elevon control surfaces to move downwards (to counteract the weight) and in so doing increased the camber of the wing generating more lift at slower speeds. Another feature was the ability to move fuel across the aircraft between tanks 1 and 4. This allowed Concorde's roll-trim to be set without having different deflections on the elevons which, otherwise, would add drag and reduce performance. The fuel transfers were carried out by the flight engineer from his Fuel Control Panel (FCP) on his Instrument Panel (above L&R). On Concorde, this was one of the most important and time consuming jobs for the flight engineer during flight operations. The panel allowed the engineer to set up the transfers to be carried out automatically and stop when the relevant quantities of fuel had been moved to the proper tanks. During flight, dynamic markers (a.k.a. "bugs") were shown on the CG displays on the pilot's instrument panel. These told the pilot what the CG limits were for the speed the aircraft was achieving. Bugs were also shown on the airspeed indicators that indicated what speeds could be flown for the real-time CG position. 308

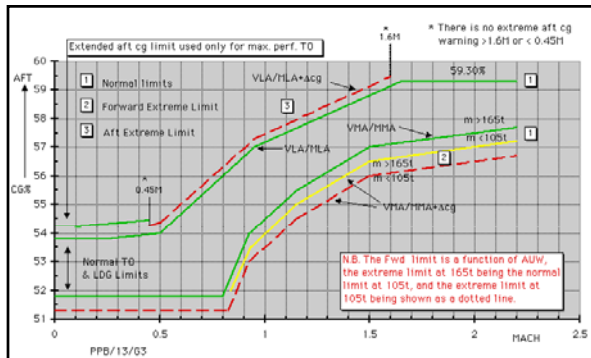

Above: Center of Gravity (CG) corridor diagram

309

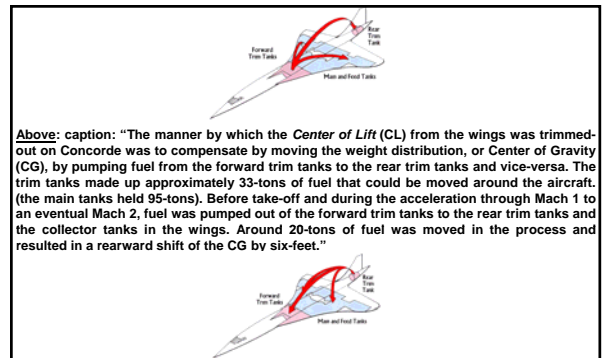

Above: caption: "The manner by which the Center of Lift (CL) from the wings was trimmed-out on Concorde was to compensate by moving the weight distribution, or Center of Gravity (CG), by pumping fuel from the forward trim tanks to the rear trim tanks and vice-versa. The trim tanks made up approximately 33-tons of fuel that could be moved around the aircraft. (The main tanks held 95-tons). Before take-off and during the acceleration through Mach 1 to an eventual Mach 2, fuel was pumped out of the forward trim tanks to the rear trim tanks and the collector tanks in the wings. Around 20-tons of fuel was moved in the process and resulted in a rearward shift of the CG by six-feet."

Above: caption: "At the end of the cruise (during the deceleration), it was necessary to pump fuel forward to the wing transfer and/or the forward trim tanks thus moving the CG forward again as the CL moved rearward. Once on the ground, it was standard practice to then pump more fuel into the forward trim tanks to correctly balance Concorde so it can be unloaded without any stability problems and the chance of it becoming a 'tailsitter'" 310

Automation

311

"...The Concorde may be the most 'computerized' plane ever built. It reaches over 200 mph on the runway alone, and in the air the three-man crew would have little time to work out the hundred-and-one things that affect course, altitude and speed. One computer collates current information about weather, fuel consumption, payload, noise regulations and course, and then recommends the correct setting. If, for example, one of the engines lost some power, the computer would adjust instantly to the new conditions: 'He could sit and do a crossword puzzle,' said a British Aircraft Corp. spokesman, 'but he won't, of course.'..."

Popular Mechanics, March 1968

312



"...With all low aspect ratio aircraft the maintenance of the airspeed along the flight path must be accompanied by a reverse movement of the throttles. An automatic device - the auto-throttle - will be necessary to fulfill this function, and it will be integrated with the blind landing system. Such a device is not new, since it is actually used on the Caravelle for blind landing, and on most Mach 2.2 military aircraft..."

Monsieur P. Satre, Concorde Technical Director (1963)

RE: Concorde had an "Automatic Flight Control System (AFCS) installed that, for the time, was state of the art. The system was designed to allow "hands-off" control of the aircraft from climb-out to landing. There were two main parts to the system; the *Auto-throttle* and *Autopilot* plus a number of associated systems such as the warning displays and test systems. The majority of the controls for the AFCS were situated on the "glareshield" (above).

313

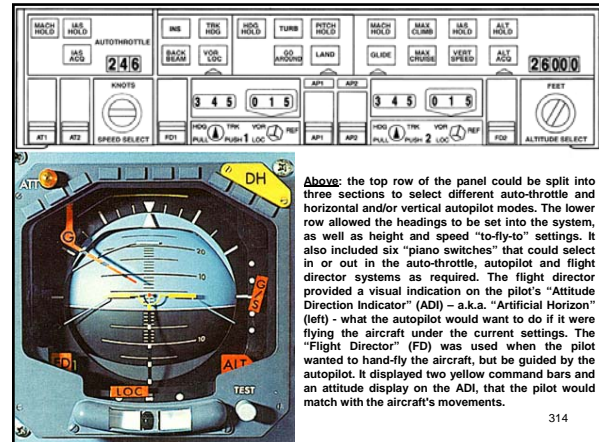

Above: the top row of the panel could be split into three sections to select different auto-throttle and horizontal and/or vertical autopilot modes. The lower row allowed the headings to be set into the system, as well as height and speed "to-fly-to" settings. It also included six "piano switches" that could select in or out in the auto-throttle, autopilot and flight director systems as required. The flight director provided a visual indication on the pilot's "Attitude Direction Indicator" (ADI) - a.k.a. "Artificial Horizon" (left) - what the autopilot would want to do if it were flying the aircraft under the current settings. The "Flight Director" (FD) was used when the pilot wanted to hand-fly the aircraft, but be guided by the autopilot. It displayed two yellow command bars and an attitude display on the ADI, that the pilot would match with the aircraft's movements.

314

"...In all, the Concorde carries about thirty micro-circuited computing devices, as small as a telephone or as big as a typewriter (their combined weight is only seventy pounds). Computers take over the autopilot, including the auto-throttle, the auto-stabilization (which makes the plane fly straight and level regardless of any roll or yaw), and the electric trim, which keeps the plane well balanced as conditions change, when fuel is used, at acceleration or deceleration, or even when three or four passengers walk down the aisle! The computer systems are completely duplicated for safety, and are built to such exacting standards that not even the minutest fault is expected more often than every 600 hours..."

Popular Mechanics, March 1968

315

ACD

316

"...The Concorde is a riot of new and ingenious inventions, many of which, as spin-offs, may bring benefit soon to the man in the street. Take Automatic Chart Display (ACD), for instance. In the center of the dashboard, an illuminated map shows the plane's course and position, and the surrounding countryside. As the plane moves or turns, the computer-controlled map shifts with it, always leaving the plane's position dead in the center. At the flick of the switch, the map - it's really a mini-TV screen - blows up to double scale. One tiny cassette holds 8,000 2,000-mile routes, any of which can be exposed at will. It is not hard to imagine the ACD - and its associated computerette - becoming a splendid 'optional extra' in the vacationer's family car..."

Popular Mechanics, March 1968

317

Fly-by-Wire

318

Conventional flight deck controls (yoke, pedals and trim controls) send signals to two electrical channels (Green and Blue) and, via relay jacks, to a third standby mechanical channel. Since “fly-by-wire” was still in its infancy in the 1970’s, a mechanical system was the order of the day. In *Concorde*, the mechanical system was not, as a matter of course, connected to the PFCU’s. Rather, it was automatically connected should a double failure occur in the green and/or blue electrical systems. Inputs from the flight controls were converted to electrical signals by way of “resolvers” that directly controlled the PFCU’s. In the mechanical channel, the pitch and roll commands were mixed by a mechanical mixing unit. A monitoring system was fitted to each of the electrical channels to monitor the flight control inverters, hydraulic systems and operation of the servo and electrical control channels. On the flight deck, a display in the center panel indicated the position/s of the flight control surfaces and, also, what electrical or mechanical channel was being used to control them. Eight red warning lights were also provided to draw attention to a failed system that required crew attention. When the autopilot was in operation, roll, pitch and yaw were directly controlled by the autopilot computers. The relay jacks provided an input to the system from the autopilot and also provided feedback to the flight deck controls.

319

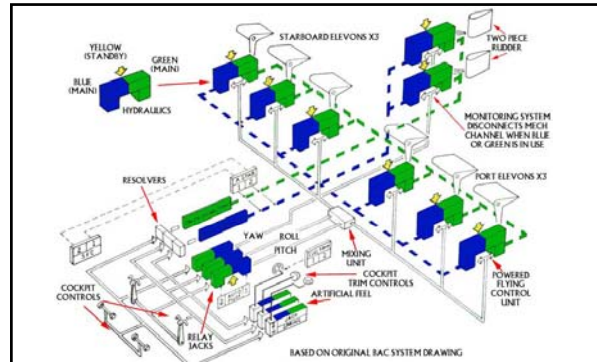

Above: caption: “Concorde was one of the first fly-by-wire aircraft in the world. With fly-by-wire, the aircraft is controlled by means of electrical signals that are sent to the hydraulically actuated flight controls.”

320

AFS

321

An “Artificial Feel System” (AFS) that made the aircraft feel to the pilot like a conventionally controlled aircraft was also incorporated. The system increased the cockpit control stiffness, through jack springs, as a function of the speed of the aircraft. On a traditionally controlled aircraft the controls would be harder to operate when the deflection of the control surfaces is increased at high speeds due to air resistance. On *Concorde*, the artificial feel system reinstated this resistance into the controls to make the aircraft handle as a traditional aircraft would. Otherwise, the flight control would just move to where they were sent, with very little effort by the pilot, making it very easy to over-control the aircraft. Two auto-stabilization (a.k.a. “autostab”) systems (main and spare) fed to the flight control surfaces. This improved the stability of the aircraft during flight and helped minimize the effects of any turbulence encountered. The systems also aided in controlling the aircraft should it suffer an engine failure. The signals from the autostab computers (unlike those from the autopilot) were sent directly to the PFCU’s thus no feedback was provided to the pilots’ controls. In the case where the cockpit flight controls became jammed between the control columns and the relay jacks, an emergency control system was fitted that, with the aid of strain gauges, measured the forces being applied to the controls by the pilot against the jam and sent the resulting signal directly into the electrical flight control channels.

322

Materials

323

“...All sorts of new problems arose in design. A cruising speed of Mach 2.2 (about 1,450 mph) would raise temperatures to 266-degrees F. at the leading edge of the wings, a sizzling 307-degrees F. at the nose. It meant the use of a special heat-resistant aluminum alloy called Hiduminium RR 58 in Britain (AU 2 GN in France). They foresook heavier stainless steel and titanium planned for the American SST. At subsonic speed, these surfaces could ice up, so they have to carry heaters, too. In the same way, the air-conditioning system has to heat the interior at subsonic speeds and then cool it after Mach 1 is passed...”
Popular Mechanics, March 1968

324

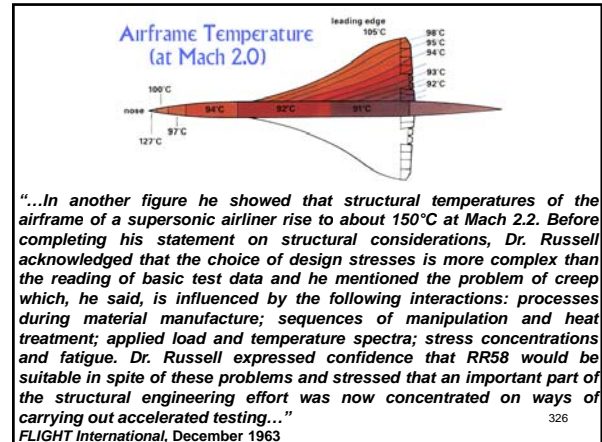
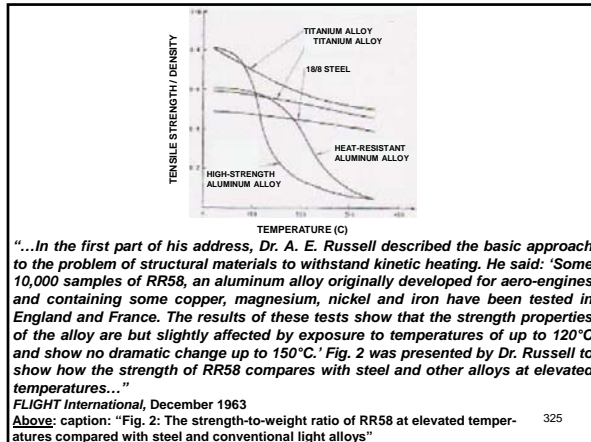

What About the Boom?

327

“...Over the last few years working methods have been developed which predict the strength of the boom shock waves produced by any form of aircraft in a given flight condition. Associated research has been directed to estimating community tolerance to various levels of intensity. This latter aspect has been the more difficult to assess. One would be led to expect, for example, greater tolerance from the citizens of Paris than those of Stockholm. Many observers who have been present at controlled tests covering a wide range of boom intensities have either fortuitously, or under the influence of reported impressions of other witnesses, reached similar conclusions. As a consequence it can be confessed that aircraft of much over 150 tons take-off weight would be greatly restricted in their operations. The implication is that the maximum payload on overland routes could not much exceed 100 passengers. It is also well known that supersonic flight must be restricted to altitudes as much above 40,000 ft. as possible. Such considerations have had a significant influence on the design of Concorde and its engines. With flight entirely restricted to subsonic speeds below altitudes of 40,000 ft. and with still further time spent in subsequent acceleration and deceleration, it is obvious that the block speed of supersonic aircraft will not be commensurate with cruise speed. Such differences will be more marked at shorter ranges and still higher Mach numbers. It is apparent that beyond Mach 2 a state of rapidly diminishing returns has been entered. Flight time differences then have little significance when judged against typical total journey times. As far as low operating costs are concerned, the scope for inventiveness subsonic aircraft is running dry.”

Dr. A.E. Russell, Concorde Vice Technical Director 328



Part 6

A New World of Flight

330

Just Over the Horizon

331

"A new world of flight will begin in 1969. And Pan Am will begin it. Yesterday, they were no more than dreams on a drawing board. Today, they're on their way to reality. And the reality will be a new world of almost unbelievable speed and size, comfort and quiet. Conjure up an image of some triumphant ocean liner suddenly sailing the skies - and you have our 747. Imagine a plane that makes it practical for you to take a business trip from New York to London and back in the same day - and you have our SSTs. Now you know why we can't wait to get these planes off the ground. They are the next generation of great aircraft. And making great aircraft come true has been our way of life ever since the 1920s. Remember our China Clipper and our B-314 Flying Boats? Our B-377 Stratocruisers? Our 707 and DC-8 Jet Clippers were tremendous breakthroughs - and we've been in on many others. And look what's coming. Take the Pan Am 747, for instance. Approximately two-thirds the length of a football field, it will make today's four-engine Jets look like baby brothers. The 747 will be 76 feet longer, 10 percent faster, twice as powerful. It will need almost 2,000 feet less runway on takeoff. And when the day comes that you enter this elegant giant, you'll rule out the word cabin. The interior will simply be too spacious for so small a word. And comfort will reign supreme. Our First-Class President Special section will consist of a lower deck with an honest-to-goodness bar and a spiral staircase leading to an upper deck. Our Rainbow Economy section will give you extra-wide seats for curling up, two extra-wide aisles for strolling about. Surprisingly enough, the 747 will also be less expensive to operate. This will enable us to press for even lower fares than we have right now. And that will only be fitting, for without Pan Am's participation, there wouldn't be any 747s at all. These, then, are the planes of tomorrow. We'll have more of them for you than any other airline. And they're all just over the horizon.

RE: text from a PAA advertisement in LIFE magazine, (April 1967) promoting the new Boeing 747 (1969), Concorde SST (1971) and the American SST (mid-1970's) to enter PAA service in the not-to-distant future thus ushering in a "New World of Flight"

A new world of flight will begin in 1969. And Pan Am will begin it.

1971. The Concorde Supersonic Transport. 1,450 miles an hour. 124 passengers. New York to London: 3 hours. Los Angeles to Hawaii: 2 hours 27 minutes. New York to Caracas: 2 hours 2 minutes. We were the first airline to order supersonic jets.

1969. The Boeing 747. 625 miles an hour. 366 passengers. New York to London: 6 hours 5 minutes. Los Angeles to Hawaii: 5 hours 3 minutes. New York to Caracas: 3 hours 58 minutes. It will be built to our specifications.

The Mid-1970s. The U.S. Supersonic Transport. 1,800 miles an hour. 270 passengers. New York to London: 2 hours 41 minutes. Los Angeles to Hawaii: 2 hours 13 minutes. New York to Caracas: 1 hour 53 minutes. We ordered more of them than any other airline.

333

"...In the meantime, confident representatives from sixteen airlines have examined the full-scale wooden mock-up (which itself cost \$350,000) and have deposited about \$300,000 per plane for options on 74 Concorde. In the United States, Pan AM wants eight; American, Eastern, TWA and United, six each; Braniff and Continental, three each. To meet these and other anticipated demands, the two manufacturing companies plan to turn out Concorde at the fantastic rate of one a week once they get going..."

Popular Mechanics, March 1968

Above: the full-size wooden Concorde mock-up, first displayed at the 27th Paris Air Show in 1967. Afterwards, it was moved to Paris' Orly Airport where it could be viewed by the public. It was the victim of an arsonist a few years later.

A Belt and Braces Job

335

"... 'It's a belt and braces job,' explained the BAC spokesman. Computer duplication is only one way that the Concorde is planned as the world's safest aircraft. The hydraulic system is triplicated - and even if all four engines should fail, their 'windmilling' action would still be enough to keep the hydraulics going. There are two parallel electrical circuits. The strict certificate-of-air-worthiness conditions even lay down that the aircraft shall be flyable manually, if all electric and electronic signaling aids break down together. In the same way, new CA regulations dictate that cabin pressure shall be maintainable even with one of the four air systems out and with one cabin window smashed. To allow for the remote chance of solar flares producing an unacceptable amount of radiation, a special device gives enough warning for the pilot to glide down to a safe 50,000 feet..."

Popular Mechanics, March 1968

336

"...Prototype 002 is scheduled to take-off in late summer. Already work has started on 01 and 02, the pre-production models. They are already different from the prototypes: twelve feet longer, with engines 7.5% more powerful. These first four planes will never fly in service, but their job is vitally important. Before Concorde No. 1 is judged satisfactory for public service, 001, 002, 01 and 02, and 1 and 2 of the production aircraft, must put in nearly 5,000 flying hours. Loaded with twelve tons of recording equipment, they will carry out rigorous testing and re-testing for power and fuel consumption, range and speed, maneuvering and stability, efficient pressurization and resistance to metal fatigue, comfortable and quiet take-off and smooth landing. They will be tried at high altitudes and low, in the freezing Arctic and at the scorching Equator, in gales and snow – every extreme condition that can be found..."

Popular Mechanics, March 1968

337



Above: caption: "Concorde 001: The wing shape on the prototype did not have the same twist and droop found on the later aircraft."

Top Left: caption: "Concorde 001: F-WTSS was different in shape to what we see today. The nose area and wing were markedly different."

Bottom Left: caption: "Concorde 001: The engine reverse system did not feature the "buckets" we see today."

338



Above: caption; "British Pre-Production Concorde 01, G-AXDN"

Left: caption: "The prototype and pre-production Concorde were fitted with flight test recorder stations for monitoring and recording all aspects of the test flights."

339



Above: caption: "Forward passenger cabin of an Air France Concorde. This area has forty seats in a 2+2 configuration"

Left: caption: "Production Concorde 101 (French built). Looking aft, you can see the amount of air data probes on the nose area of Concorde."

340

In total, twenty Concorde were built between 1966 and 1979. The first two Concorde were prototype models; one built in France and the other in England. Another two pre-production prototypes were built to further refine design and test-out ground breaking systems before the production runs (sixteen aircraft in total) commenced in both countries. The first production aircraft off each production line did not enter service but acted as a test-bed for production techniques, airline training and further development work. They also paved the way for the granting of airworthiness certification as well as providing extensive route proving information.

341

Building Concorde

342

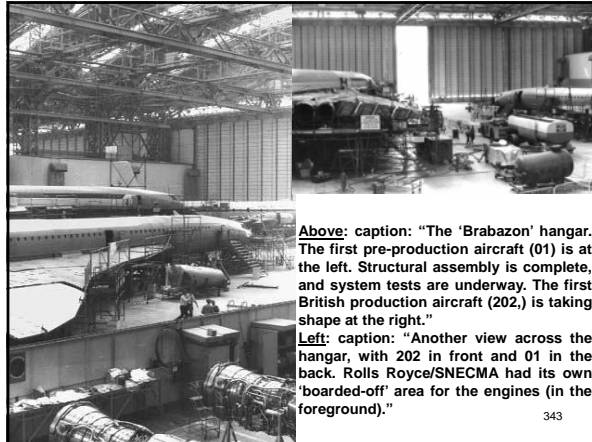

Above: caption: "The 'Brabazon' hangar. The first pre-production aircraft (01) is at the left. Structural assembly is complete, and system tests are underway. The first British production aircraft (202), is taking shape at the right."

Left: caption: "Another view across the hangar, with 202 in front and 01 in the back. Rolls Royce/SNECMA had its own 'boarded-off' area for the engines (in the foreground)."

343

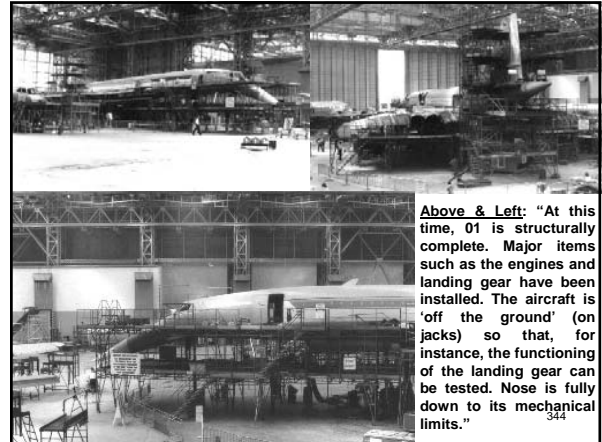

Above & Left: "At this time, 01 is structurally complete. Major items such as the engines and landing gear have been installed. The aircraft is 'off the ground' (on jacks) so that, for instance, the functioning of the landing gear can be tested. Nose is fully down to its mechanical limits."

344

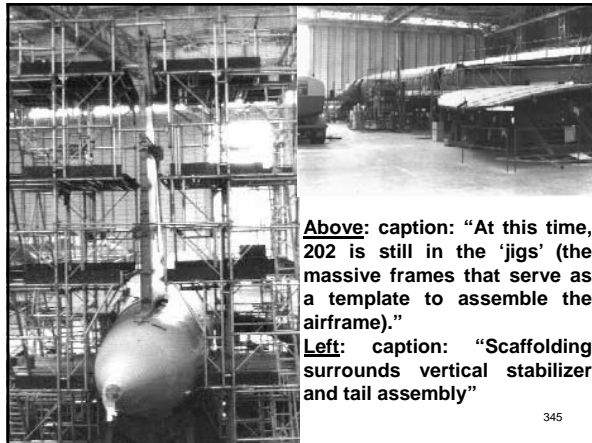

Above: caption: "At this time, 202 is still in the 'jigs' (the massive frames that serve as a template to assemble the airframe)."

Left: caption: "Scaffolding surrounds vertical stabilizer and tail assembly"

345

Excellence, England, Europe and Entente

346



On December 11th 1967, in *Toulouse, France* (with over 1,100 guests present), the first prototype *Concorde* (French spelling) was ceremonially rolled out (top). The aircraft was called "Concorde 001." With the British *Concord* prototype almost complete, British technology minister *Anthony Wedgwood Benn* announced at Toulouse that from then on the British aircraft would also be called "Concorde." The "e," he said, stood for "Excellence, England, Europe and Entente." It was said the overall shape, aerodynamics, flight controls, propulsion and auxiliary systems made *Concorde* a generation ahead of any other form of civilian transport. The first prototype, 001, was rolled out from its assembly hall at Toulouse. This first public appearance was intended, through the medium of television, newspapers and magazines, to give the world (and, in particular, the French and British taxpayers) a chance to see *Concorde* "in the flesh." But there was still much work to be done on the aircraft and months of painstaking checks and ground testing were to pass before the western world's first SST was ready to make its maiden flight. Representatives from the option holding airlines were present along with their respective cabin crews who posed for photographs in front of the aircraft (bottom).

347

Rollout, Take Two

348



Above: on September 19th 1968, nearly a year after the rollout of the French prototype (December 1967), the British prototype known as "Concorde 002" - the first aircraft assembled in Britain, was rolled out (left) from the "Brabazon" hangar (right) at the British Aircraft Corporation's plant at *Filton, Bristol*. The aircraft was fully painted and looked like it could possibly fly within the next few weeks, although in reality many months of ground testing lay ahead before her first flight.



Left: also visible (and nearing completion in the Brabazon hangar) was the first pre-production aircraft: "Concorde 01." This aircraft incorporated modifications from the prototype aircraft including a new "droop-snoot" nose, a fully transparent visor and a lengthened fuselage: from the original 184-feet to 193-feet (the production aircraft would be lengthened further, to 204-feet).
349

She Flies! She Flies!

350



Sunday, March 2nd 1969, was an emotional day for the people on both sides of the Channel who had planned and built *Concorde*. On this first flight, French assembled "Concorde 001" carried the hopes and dreams of thousands of people who had contributed to the most ambitious technological project in all of Europe's history. Loudspeakers informed the waiting crowd at *Filton, Bristol*, that Concorde's crew were aboard and pre-flight checks in progress. One by one, the four Olympus engines came to life. Concorde moved down the perimeter track (left) and turned slowly to line up on the runway. Then came a crescendo of sound and brakes released, the white aircraft on its tall undercarriage started to move along the runway, slowly at first but gathering speed. Then, the nose lifted and millions of television viewers in Britain heard commentator Raymond Baxter's excited shout: "She flies! she flies!" The crowd watched as she climbed into the blue sky (right), trailed by her attendant *Mirage* chase plane. It was a short flight, only forty minutes, but it gave test pilot *Andre Turcat* and his crew a taste of what flying a Concorde would be like. Afterwards, he reported that the aircraft handled better than the simulator had predicted. On her landing, she came into view and for the first time, the crowd saw Concorde's characteristic "sea-bird swoop" approach for landing. A puff of smoke indicated the main landing gear had made contact with the runway, the nose-wheel came down, reverse thrust was engaged and a drag tail parachute broke from its housing and ballooned out behind the aircraft bringing Concorde 001 to rest. The first flight of the British-assembled "Concorde 002" also took place at *Filton*: on April 9th 1969.
351

Mach Speed

352



Left: on October 1st 1969, *Concorde 001* - on its 45th test flight - exceeded Mach 1 for the first time. At an altitude of 36K-feet and seventy-five miles from *Toulouse*, it held Mach 1.05 for nine minutes. From then on, both *Concorde* prototypes were to proceed up the Mach scale during flight tests.

Right: Concorde 001 reached Mach 2 on November 4th 1970 while Concorde 002 reached Mach 2 on November 12th 1970. The photograph shows both aircraft in flight together at the *Paris Air Show*.
353

Flying Down to Rio

354



In September 1971, *Concorde 001* arrived back in *Toulouse* having completed a two week tour of *South America*. The tour started with *Concorde 001* making its first transatlantic flight. *Concorde* arrived in *Rio de Janeiro* via the *Cape Verde Islands*, *Cayenne* and *Sao Paulo*, where it was the highlight of the "France 71" exhibition and made several demonstration flights. During the tour, *Concorde 001* flew for a total 29 hours 52 minutes, of which 13 hours 30 minutes were at supersonic speed (9 hours 21 minutes at Mach 2).

355



Top: *Concorde 01*, the first pre-production aircraft was rolled out at *Filton* on September 20th 1971. After the rollout, four months of ground testing and final fit-outs took place before the first flight.



Bottom: on December 17th 1971, *Concorde 01*, the first pre-production aircraft, made its first flight from *Filton* to the test center at *RAF Fairford*.

356

Far East Tour

357



Above: on June 2nd 1972, *Concorde 002* left *RAF Fairford* and began a 45K-mile sales demonstration tour of twelve countries in the *Far East* and *Australia*. After the tour, *Concorde 002* returned to *London Heathrow* on July 1st 1972

358

Route Proving Flights

359



As part of the certification process, aviation authorities wanted *Concorde* to fly 1K-hours in "Route Proving Flights" before they would award a "Certificate of Airworthiness" to *Concorde*. Due to the work that had been carried out during the development program, this figure was lowered to 750 hours (mainly due to the extensive test flying done by 02). The route proving work kicked off in *France* on May 28th 1975 using the ill-fated F-BTSC: *Concorde 203*. The idea of route proving was to convince the authorities that the aircraft could be operated by the respective airlines over the routes that they would initially fly as a starting point for future services. *Air France* crews along with *Aerospatiale* test pilots flew route proving flights from *Paris* to *Rio de Janeiro* (via *Dakar*), *Caracas*, *Gander* and loops via the *North Atlantic* and the *Mediterranean*. The cabin staff on the flights were provided by *Air France*. The 124 route proving flights on 203 were completed on August 2nd 1975 and covered 367,900 statute miles. The aircraft carried 4,680 passengers and was supersonic for over 258 hours. *Concorde 203* was then returned to the manufacturer, but was subsequently leased to *Air France* for a few months when they started commercial service. The aircraft was bought by *Air France* for one French Franc, in 1980.

360

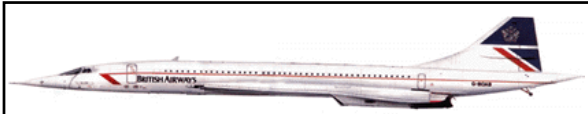

The British-based route proving flights began on July 7th 1975 using *Concorde 204* (G-BOAC). The aircraft flew flights that included destinations such as *Gander, Beirut, Singapore and Melbourne*. Due to a requirement by the UK's CAA, a BAC test pilot was required to be on the flight deck and in command at all times, even though he would be in the jump-seat. After the completion of the route proving flights on September 13th 1975, 204 was returned to BAC for final modifications to take place before the aircraft was officially delivered to *British Airways* in February 1976. Concorde 204 flew 130 flights that equated to 380 hours flying time (of which more than 208 hours were supersonic), covered 325K statute miles and carried approximately 6,500 passengers. The main technical issue that the route proving flights brought out was a deficiency in the autopilot system when set to "Mach Hold" mode. Since the mach number is a function of temperature, the changes experienced in outside air temperature tended to cause the aircraft to follow the Mach number in an erratic manner. This caused larger rates of climb and descent along with the speed variations between Mach 1.8 and 2.1. The problem was eventually solved by the engineers at *Aerospatiale*, but during the initial commercial flights in 1976, BAC observers had to be present in the cockpit, at the request of the CAA, on all BA flights. The French authorities were not too bothered about the autopilot system error and felt that their flight crew would understand and manage the issue.

361

Start of an Era

362



By January 1976, *Concorde* had finally been certified as airworthy and was available to the airlines to begin scheduled services. There were just a few hurdles to overcome: A lack of aircraft to fly and lack of destinations willing to accept *Concorde*. *Air France* took delivery of their first *Concorde* at *Toulouse* on December 19th 1975. A few proving and training flights were undertaken before the airline was ready to start passengers services. *British Airways* took delivery of their first *Concorde* on January 14th 1976 (due to upgrades to BA specifications, it would not be available until mid-February 1976. Both *British Airways* and *Air France* had been denied access to *Concorde*'s main destination: the *United States*, by the *U.S. Congress* for environmental reasons. Some saw this as retribution by a failed competitor to *Concorde*. However, this would eventually be overcome, but with severe restrictions. *Air France* decided to launch its first supersonic flights to *Rio de Janeiro*, via *Dakar*, with two weekly flights. *British Airways* would begin their supersonic services to *Bahrain*. The *Bahrain* sector would eventually, they hoped, form part of a route that would take *Concorde* to *Singapore* and onto *Australia*. On January 21st 1976, at 11:40am, *Air France Concorde F-BVFA* and *British Airways Concorde G-BOAA* took off simultaneously to the second, inaugurating the era of commercial supersonic travel.

363

Above: official BA photograph of the first *Concorde* flight: January 21st 1976



Above: on May 24th 1976, transatlantic service to *Washington D.C.* from *London* and *Paris* began with two *Concorde*'s; one *British Airways* and the other *Air France*, landing at *Dulles International Airport*. Before landing, both aircraft simultaneously flew over the *U.S. capital* and then made parallel approaches to the airport. Both aircraft touched down together, the *British Concorde* landed on runway 01L and the *French Concorde* on runway 01R. Special permission had been given by *U.S. Secretary of Transportation, William Coleman* for these flights to take place. After a long delay, both *British Airways* and *Air France* began services to *New York* from *London* and *Paris* on November 22nd 1977.

364

Ten Years of Service

365



In 1986, *Concorde* celebrated ten years in commercial service and had accumulated 71K supersonic flying hours. To celebrate, BA attempted something never done before. They decided that there could be no better way to celebrate the tenth anniversary of *Concorde* than to fly four aircraft in formation for a very special birthday photo. Days of detailed planning went into the project that would see four *Concordes* in the new BA "Landor" livery colors flying together over the south coast of *England*. *Concorde* schedules were reviewed to find a date when four of the fleet would be available. Three dates were found and the teams of engineers set to work to ensure that the chosen aircraft would be serviceable and not have to be withdrawn at the last moment. BA's Senior *Concorde* crews were chosen to fly the aircraft for the event. On December 24th 1985, the convoy of four *Concordes* (led by a *Lear Jet* that would capture the event on film and video) departed from the ramp and each aircraft lined up on *Heathrow's* runway 28R and within ten minutes, all five were in the air heading for the rendezvous point 15K-feet above *Lyneham* in *Wiltshire* (left). Two days later, on December 26th 1985 (*Boxing Day*), six of the aircraft were lined up on the ramp at *Heathrow* for a unique photograph (right). At the time, the seventh BA *Concorde* was 366 in the paint shop being put into the new livery colors.



Left: Pepsi Cola undertook a major \$500 million U.S. re-branding project, which would be unveiled in 1996, after about two years of preparation. Pepsi looked around for a spectacular and efficient manner to advertise its new brand and it was eventually decided to have an advertisement operation involving the Concorde. Thus, for two weeks in 1996, Air France's Concorde F-BTSD was painted in a "Pepsi Livery."
Right: on June 2nd 1996, Concorde flew in formation with the RAF's Red Arrows precision flying team and performed a fly-past for the 50th anniversary of London's Heathrow Airport.

367

My God, That's Concorde

368

"We watched it taking off when suddenly we saw a lot of smoke and flame coming out the back. There were hundreds of us there and we were all saying, 'my God, that's Concorde.'"

RE: eyewitness account of the fatal Concorde crash at Paris' Charles de Gaulle Airport on July 25th 2000

369



On Tuesday, July 25th 2000, the first fatal accident involving Concorde occurred involving Air France's Concorde 203, outbound from Paris to New York. A catastrophic crash occurred just sixty seconds after take-off when a tire blow-out caused a fuel tank to rupture starting a sequence of events that caused a fire which eventually led to two engines failing and the aircraft crashing. All 109 people (100 passengers and 9 crew members) on board were killed. Four people in a local hotel on the ground were also killed.

370

"We are used to Concorde, but straight away we could tell the noise was wrong. We looked out of our vehicle and it came just a few meters above us - it was too loud. It was hardly going up at all, there were flames from the No. 1 engine and there were bits - bits coming off, we could see them. I do not know if the pieces were from the engine or from the wing. We saw it for about twenty or thirty seconds, we could see it was in trouble and it was obvious it was going to come down. We were just wondering how many people were on board and if any would live."

Einar Forberg - Catering Director, Air Atlanta

RE: eyewitness to the 07/25/2000 Concorde crash

371

"Aviation experts believe that engine failure that knocked out the plane's control system might have caused Tuesday's crash of an Air France Concorde. Although the aircraft clearly had some kind of engine problem, experts pointed to witness accounts that the plane stalled before it crashed and then plummeted out of control. 'If that's what happened, then it looks like they lost flight control,' said Malcolm English, editor of the leading industry monthly Air International. The plane 'flipped over like a pancake,' one witness said. But he and other aerospace experts warned that, while they could intelligently speculate about the cause of the crash, only a formal inquiry could reliably determine the cause...A French judicial official said on Wednesday that the Concorde's pilot reported an engine failure just before the crash, which killed all 109 aboard and four on the ground. Air France said one engine had been worked on before the plane took off. One former Concorde pilot said the aircraft would become uncontrollable if it lost both engines on one side - a possibility since the Concorde's Rolls-Royce Olympus turbojets are mounted in side-by-side pairs. 'Failure of both engines at low speed just after takeoff is impossible to control,' pilot Germain Chambort told LCI television. Inside their cylindrical casing, jet engines are made up of rows of propeller-like blades racing at high speed. If blades break off - perhaps if a bird is sucked into the engine - they fly out into the casing with enormous energy. The casing is supposed to contain the blades to prevent damage to the rest of the plane, but there have been instances of so-called uncontained failure. If another engine is next to one that explodes, as on a Concorde, then it too might be knocked out...Aeronautical engineers were reluctant to comment, but one who asked not to be named pointed to the large flame in the now famous photograph taken just before the crash. The engine failure may have started a fuel tank fire which, in turn, downed the plane, he said. The Concorde's fuel tanks are embedded in the wings. 'To me, that looked too big to be just an engine fire,' the engineer said. English also said fire could rob the pilot of control of the aircraft. 'The (control) rods can burn through, if there is a very intense fire,' he said. In that case, the plane might pitch uncontrollably and stall - as witnesses said the Air France Concorde did on Tuesday."

RE: post-accident media report

372



"Former Concorde captain David Brister said he had been involved in an incident back in 1982 but claimed the plane was 'very safe.' Mr Brister, now 67, from Crowthorne, Berks, was taking off in the aircraft when at least one of its tires blew. The brakes then briefly caught fire but he managed to bring the aircraft to a safe stop on the runway. 'Concorde has always been a very safe aircraft, until now,' he said. 'Everyone got out safely and it really wasn't much of a big deal. Concorde was a very prestigious aeroplane to be flying, at the top of the tree. All the pilots on other planes used to be jealous.' But he added: 'It is very challenging. Everything happens twice as fast as in other aircraft. You are flying at twice the speed of sound and 60,000ft.' Mr Brister, who flew Concorde from 1976 to 1982, said the aircraft's unique design may have made it vulnerable to engine problems. 'Concorde is unusual in that the two engines on each wing are very close together. Any four-engined aircraft can cope perfectly well with losing one engine but if two go on the same side you can be in for a difficult time. But with Concorde the engines are so close that it is possible one could affect the other and then you have a much more serious situation. I must add that it is far too early to say anything definitive and these so-called experts on TV really should know better than to make suggestions about what happened.'" 373

RE: post-accident interview with former BA Concorde pilot

"The pilot of the doomed Concorde airliner reported one of his engines had failed just before the supersonic airliner crashed outside Paris with the loss of 113 lives, a French judicial official said on Wednesday. Air France said separately that a part of the same engine, the number two motor, had been replaced shortly before the plane took off from Charles de Gaulle airport on Tuesday for its ill-fated charter flight to New York...Air France said the doomed airliner left its gate more than an hour behind schedule on Tuesday after technicians replaced a part in the engine. The company said when the supersonic jet returned from a trip to New York on July 24, the system that reverses the thrust of the engine was not working. The company said a replacement part was not immediately available, but the plane could still fly without being repaired under specifications approved by the manufacturer. Air France said the captain of the doomed flight was notified of the problem but insisted that the necessary repairs be performed before he took off. 'The spare part was immediately taken from a reserve Concorde. The repair was completed in 30 minutes,' Air France said in a statement, adding that a delay in transferring passengers' luggage had also pushed back the take-off time. 'As soon as the part was replaced and all bags were loaded, the captain decided to take off,' the company said..." 374

RE: post-accident media report

"French investigators have found a piece of metal among the debris collected from the runway at Charles de Gaulle airport, raising questions about what role it may have played in the fatal Air France Concorde disaster. One fact is certain: The 40-centimeter (16-inch) long metal plate did not come from the doomed Concorde, said France's accident investigation agency...One aviation expert said the metal could have played a role in the first-ever Concorde crash. 'Having an object on the runway can be very dangerous for airplanes...notably for the Concorde, whose tires turn at a very, very high speed,' said aviation expert Germain Chambost...One of the tire pieces shows a slash, the agency statement said...Traces on the ground show that the plane veered toward the left of the runway as it neared takeoff. Also, traces of soot were observed on the runway where the debris was found, as were parts of a water deflector and a fuel tank...Describing what occurred in the seconds before the supersonic jet lifted off the runway, the statement said: 'Just before the rotation (the moment the pilot eases back the control wheel) the control tower signaled to the crew that there was a flame at the back of the plane. It seems an important fire had broken out at the level of the intrados (under surface) of the left wing. This fire did not come from the motor.' The Concorde, however, was beyond the point where the pilot could have aborted the takeoff. The French Transport Ministry has kept the rest of Air France's fleet of Concordes grounded until more is known about what caused the crash. On Thursday, the BEA announced that it had found a metal strip used to divert water from the engines. British Airways changed the design on its Concordes after the strip was implicated in the puncture of a fuel tank after a tire exploded on takeoff. Air France did not make that modification." 375

RE: post-accident media report

"British aviation officials have confirmed that a burst tire WAS the cause of the Air France Concorde crash, which killed 113 people. The Civil Aviation Authority gave the findings as British Airways was forced to ground its fleet, perhaps for months. Sir Malcolm Field, chairman of the CAA, said a tire on the left landing gear burst on take-off. 'This was the primary cause of the accident,' he said. A burst tire alone should not bring down an aircraft, he said, but the debris may have caused a major rupture of the fuel tanks which made the crash 'uniquely different.' The results of the initial inquiry have forced the CAA to withdraw Concorde's certificate of airworthiness, but Sir Malcolm said the authority 'fully supported' BA's decision to carry on flying after the crash on July 25th. It had 'done everything possible to ensure a safe operation,' he said. Modifications will be needed to 'ensure a satisfactory level of safety' and could take months, said Mike Bell, of the CAA safety regulation group. But he was confident Concorde would fly again. Concorde takes-off faster than any other plane, reaching 250 mph, and because of that it does suffer more tire blow-outs and has warning systems to warn pilots of any such bursts. The two pilots see a red light if there is a tire problem and the aircraft is traveling at less than 150 mph. Above that speed, it is probably too late to bring the aircraft to a halt on the runway. The flight engineer has a display to see the condition of the tires at all times. The damage sequence air accident investigators have determined so far:

- Front right tire of left landing gear bursts during the take-off run, probably because it ran over a shard of metal;
- At least one fuel tank was punctured, maybe more than once, leading to a major fuel leak;
- The leaking fuel ignited, leading to an intense fire within a few seconds of the tire bursting, one and then two engines lost thrust;
- The crew were not aware of where the fire was or how it started;
- They could not contain it."

RE: on Aug. 16th 2000, the British Civil Aviation Authority (CAA) removed Concorde's Certificate of Airworthiness as a result of its investigation as to the causes of the July 25th 2000 crash 376

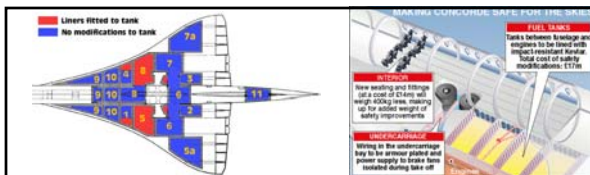

It was decided that the main cause of the accident was the ignition of the kerosene flowing from a massive rupture in a fuel tank caused by debris hitting the underside of the tank. After researching the possibilities for shielding the tanks, the best source of protection was found to be lining the insides of certain tanks with kevlar-rubber panels (right). "Self-sealing" fuel tanks were used on allied combat aircraft during WWII to protect their fuel tanks with a layer of rubber mounted on the inside of all the surfaces of the tanks. Thus, if/when bullets pierced the tanks, the rubber allowed the bullets through but then sealed the holes behind them preventing fuel from pouring out. After the completion of the tests by an Air France Concorde at the flight test center, it was decided that these panels be fitted to Tanks 5 and 8 and to parts of tanks 1, 4, 6 and 7 which would be susceptible to tire debris damage from the landing gear. These are shown in red on the diagram at left. The liners were designed to reduce the flow rate due to any tank rupture to around 0.5 liters/second The rupture that caused the July 2000 Paris accident was allowing fuel to escape at around 100 liters/second. 377



At the time of the crash, Michelin was developing a new tire technology for Concorde and other new aircraft such as the Airbus A340-600 and A380 "Super-Jumbo." The tire had been in development starting in 1999, but work was subsequently speeded up after the July 2000 crash. In the weeks that followed the Concorde accident, aviation officials contacted tire manufacturers around the world, including Michelin, to find out if any research was under way to improve the resistance of tires to damage by foreign objects. Thus, Michelin unveiled its latest innovation of radial technology: the radial NZG (left). This new aircraft tire technology, christened "NZG" (for "Near Zero Growth") uses a high-modulus reinforcement material offering higher damage resistance. "We think that this new tire will be a significant element for the process of re-certification of Concorde," declared Pierre Desmarests, general manager of aviation technology at Michelin. These tires were tested on an Air France Concorde at Istres - the military test base in the Rhone delta region of France, during a series of ground and flight tests that took place in May 2001. 378

Go for it Concorde!

379



"Both Air France and British Airways have re-started Concorde services to New York...An hour after the Air France departure, the first British Airways Concorde service to New York for nearly 16 months took off as Speedbird Concorde 001 at 10:44 GMT. An American Airlines pilot waiting to take off was heard to call out 'Go for it Concorde! Go!' as she sped down runway 27L at Heathrow...Captain Mike Bannister, BA's chief Concorde pilot, told passengers over the cabin's intercom: 'We have put Concorde back where she belongs. Sit back and relax. We're glad to be back.'...After the passengers had disembarked from both aircraft at New York's JFK airport, the Air France Concorde (Sierra Delta) was towed to the BA terminal where she was placed 'Nose to Nose' with the British Airways Aircraft (Alpha Echo). The crews from both airlines posed in front of the parked aircraft to jointly commemorate the return to service in the same way that every major milestone in the entire Concorde project was shared simultaneously between the UK and France..."

RE: media report concerning the return of transatlantic Concorde service on Nov. 7th 2001



Exactly fifty years from the start of the world's first scheduled passenger jet service on the *de Havilland Comet* (May 2nd 1952), the UK's *Royal Mail* celebrated the dawn of the jet age in civil aviation with the launch of the "Airliners Stamps" on May 2nd 2002. Britain pioneered jet engine development thus the Royal Mail service used the anniversary to acknowledge the technological advancements and achievements in British aviation; from the first jet airliner through the Concorde era (BA Concorde crew holding enlarged Concorde stamp above).

381



Above & Left: The finale of Queen Elizabeth II's "Golden Jubilee" weekend, held on June 4th 2002, was a fly-past that included twenty-seven aircraft from the *Royal Air Force* and a Concorde from *British Airways*. This was the first time Concorde was used in its "flagship" role since the fleet was grounded following the *Paris* accident in July 2000. Before the accident, around 1% of Concorde flights were in a flagship role which included flying the England Football and European Ryder cup team/s to tournaments as well as politicians to world summits.

382

Farewell to Concorde

383

"The costs of operating Concorde, and in particular maintenance and support, have become such that operations are unrealistic for any operator."

Noel Forgeard, Airbus CEO (2003)

RE: quote appearing in the *Financial Times*. In the wake of the July 2000 crash, *British Airways* and *Air France* were not recuperating the significant amount/s of money spent on safety modifications and other upgrades (i.e. interiors) to their Concorde fleets. Airbus - the manufacturer, was not willing to support the aircraft after October 2003. Post 9/11, the premium first class market for Concorde eroded negating any hope of paying back the modification cost let alone the further investment required to keep the aircraft in the air. On a day-to-day basis, Concorde was still breaking even, but it could no longer pay back any big expenditure items, so its days were numbered. At the time of re-launch (November 2001), there was no way of knowing that the downturn in business and premium travel would take effect to the extent it did despite the fact that, for a period after the re-launch, services were profitable. Modification work and testing programs were virtually complete and paid for by the time of the September 11th 2001 terrorist attacks, which had a major negative impact on business travel. Airbus was adamant that it would not support Concorde's continuing operation beyond October 2003. Airbus's chief executive Noel Forgeard was on the record as stating that no airline could operate Concorde without Airbus' support, being the key supplier in the Concorde operation. The Airbus consortium not only built Concorde, it specified the maintenance regime and supplied the spare parts which made it viable. An incident reported in *Flight International* whereby an Air France Concorde en-route to *New York* lost sixteen-tons of fuel due to an engine fault requiring it to divert to *Halifax, Nova Scotia*, was also part of their decision to retire their fleet five months ahead of BA. From the first official Concorde flight in 1976, more than 2.5 million passengers flew on Concorde.

"London April 10, 2003: British Airways announced today the retirement of its Concorde fleet of seven aircraft with effect from the end of October 2003. The airline said that its decision had been made for commercial reasons with passenger revenue falling steadily against a backdrop of rising maintenance costs for the aircraft. Detailed discussions over an extended period with Airbus, the aircraft's manufacturer, confirmed the need for an enhanced maintenance program in the coming years, the carrier added. British Airways has decided that such an investment cannot be justified in the face of falling revenue caused by a global downturn in demand for all forms of premium travel in the airline industry. The downturn has had a negative impact on Concorde bookings and is set to continue for the foreseeable future, according to the airline. Rod Eddington, British Airways' chief executive, said: 'Concorde has served us well and we are extremely proud to have flown this marvellous and unique aircraft for the past 27 years. This is the end of a fantastic era in world aviation but bringing forward Concorde's retirement is a prudent business decision at a time when we are having to make difficult decisions right across the airline.'
 RE: British Airways press release announcing the retirement of their Concorde fleet. A farewell tour began on Monday, October 20th 2003 concluding with the final BA Concorde flight landing at London's Heathrow Airport on Friday, October 24th 2003. The era of commercial supersonic travel inaugurated by Concorde had come to an end.

385



In the end, only British Airways and Air France purchased Concorde, with the airlines initially purchasing five and four aircraft respectively. The five surplus models were placed with the airlines in 1980 and eventually purchased for a nominal cost of 1 Pound/ 1 Franc each. British Airways acquired the two unsold British-built aircraft while Air France bought the three unsold French-built craft. Thus, British Airways had a fleet of seven aircraft while Air France had five. Air France returned four aircraft to service after the Paris accident in July 2000. Ultimately, the four Air France Concorde's were retired to museums in France, Germany and the United States. British Airways operated five aircraft after the accident with a further two in storage at London Heathrow (they were not modified post-accident). All seven have now been retired and are on display around the world, including the Smithsonian's Air & Space Museum.

386

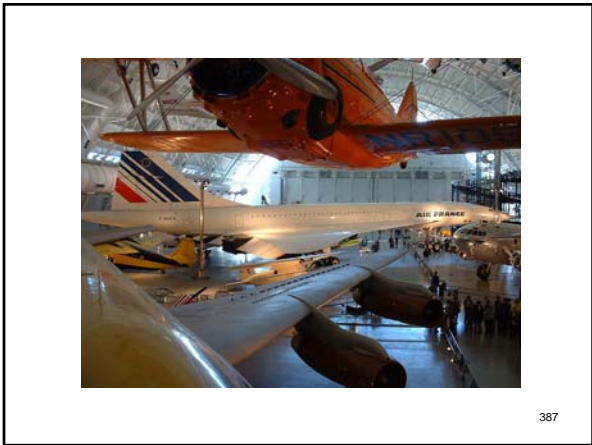

387

Concordski

388



During the 1960's, in the depths of the Cold War, the Soviet Union and the western world were competitors. Thus, anything spectacular the west achieved, the Kremlin wanted to do as well. That included a supersonic transport. The Tupolev Design Bureau developed the USSR's answer to the Concorde - the Tupolev "TU-144" (a.k.a. by its NATO codename: "Charger"). The TU-144 prototype first flew on December 31st 1968, beating Concorde by three months. Seventeen TU-144's were built, the last one coming off the production line in 1981. This includes one prototype, two "TU-144C" pre-production aircraft and fourteen full production aircraft (including nine initial-production "TU-144S" aircraft and five final production "TU-144D" models with improved engines). The TU-144 got off to an ignominious start. The second TU-144C pre-production machine crashed during a demonstration at the Paris Air Show on June 9th 1973 with the debris falling on the village of Goussainville. All six crew in the aircraft plus eight villagers on the ground were killed along with fifteen houses destroyed and sixty others injured. Considering the size of the crowd in attendance and the scope of the accident, the casualties were relatively light. The French eventually acknowledged that they had sent up a Mirage III jet to photograph the TU-144 in flight without telling the Russians. The French also allegedly shortened the TU-144's demonstration flight at the last minute and extended one by Concorde. The crew aboard the TU-144 were forced to improvise a landing and apparently tried to do so on the wrong runway. As they went around to make another attempt, they believed they were on a collision course with the Mirage. The pilot took evasive action by nosing down, which caused stalls and flameouts in some or all of the engines. He dropped the nose to restart, then oversteered the air frame trying to recover resulting in a crash.
 Above (left-to-right): the ill-fated TU-144 takes-off at the Paris Air Show / nose section after crash / devastated area of Goussainville

389

The TU-144 resembled the Concorde to such an extent that it was often referred to as "Concordski," and there were accusations that it was a copy. Many Western observers pointed out that there were also similarities between the Concorde and American SST proposals. Building an SST was an enormous design challenge for the Soviet Union. As a matter of national prestige, it had to be done with the Soviet aircraft doing it first. Since the USSR was behind the west in developing a supersonic commercial aircraft, the logical thing to do (from the Kremlin's point-of-view) was steal. An organization was established to collect and analyze open-source material on SST's from the west, and Soviet intelligence (KGB) targeted the Concorde program for deep penetration. In 1964, French counter-intelligence learned of the KGB's plans and sent out an alert to watch out for espionage and to be careful about releasing information. The French began to keep tabs on Sergei Pavlov, the head of the Paris office of Aeroflot - the USSR's national airline, whose official job gave him legitimate reasons for obtaining information from the French aviation industry and put him in an excellent position to spy on the Concorde project. Pavlov was not aware that French counterintelligence was on to him and so the French fed him misinformation to send Soviet research efforts leading down dead ends. Eventually, on February 1st 1965, the French arrested him while he was going to a lunch date with a contact and found that he had plans for the Concorde's landing gear in his briefcase. Subsequently, Pavlov was thrown out of the country. However, the KGB had another agent; Sergei Fabiev, collecting intelligence on Concorde and French counterintelligence knew nothing about him. His cover was finally blown in 1977 by a Soviet defector, leading to Fabiev's arrest. Fabiev had been highly productive up to that time. In the documents they seized from him, they found a congratulations from Moscow for passing on a complete set of Concorde blueprints. Although the Soviets did obtain considerable useful intelligence on Concorde, they were traditionally willing to use their own ideas and/or stolen ideas on the basis of which worked best. Thus, they could make good use of fundamental research obtained from the Concorde program to avoid dead-ends and get a leg up and they could leverage designs of Concorde subsystems to cut the time needed to build subsystems for the TU-144.

390



As such, the TU-144 was not a direct copy of *Concorde*. The general configuration of the two aircraft was similar, both being dart-like, delta-wing aircraft with four afterburning engines paired in two nacelles, a "droop snoot" to permit better view on take-off and landing and a flight crew of three. Both machines were mostly built of conventional aircraft alloys. However, there were many differences in detail:

- The TU-144 was slightly longer and larger, with five-abreast seating compared to the four-abreast layout of the *Concorde*, giving the Soviet machine a capacity of 140 passengers;
- The TU-144 was faster than *Concorde*, with a cruise speed of up to Mach 2.4; it incorporated steel and titanium assemblies on wing leading edges and other high-temperature elements of the airframe;
- While the *Concorde* wing outline was an elegant *ogival* curve, the TU-144's wing was a more straightforward "double delta," with a sweep of 76-degrees on the forward part of the wing and a sweep of 57-degrees on the rear part of the wing;
- The TU-144's engine nacelles were spaced closer together, with four elevons outboard of the engines on each wing and, unlike the *Concorde*, no elevons inboard of the engines. However, the TU-144 did have a two-part rudder like *Concorde*;
- The TU-144's main landing gear was more complex than that of the *Concorde*, featuring eight-wheel bogies in a four-across arrangement retracting forward into the engine nacelles. The prototypes had featured twelve-wheel bogies. It is unclear why so many tires were used. The Soviets had a strong inclination to design aircraft to operate from rough airstrips, though operating an SST from a dirt strip would seem to be pushing the limits. It is possible there wasn't enough space in the engine nacelles for a landing gear assembly with bigger tires. The gear doors were insulated to protect the landing gear from heat in flight. The two-wheel nose gear was steerable and retracted forward;
- The most significant visible difference between the *Concorde* and the TU-144 was that the TU-144 had a set of canard "winglets" behind the cockpit that were extended for takeoffs and landings. Apparently the French were very interested in the canards and the *Mirage* fighter at the 1973 *Paris Air Show* was 391 trying to obtain imagery of them in operation.



The TU-144 prototype (left) was a bit shorter and had ejection seats, though production aircraft did not, and the prototype also lacked the retractable canards. The engines fitted to the prototype had a lower thrust rating and were fitted into a single engine box, not a split box as in the production machines. The TU-144 was powered by four *Kuznetsov NK-144* afterburning turbofans. The engines had separate inlet ducts in each nacelle and variable ramps in the inlets. The TU-144D (right), which performed its first flight in 1978, was fitted with *Kolesov RD-36-51* engines that featured much improved fuel economy and upgraded thrust. Production machines had thrust reversers, but early machines apparently used drag (deceleration) parachutes instead. 392



The TU-144 was not put into service until December 26th 1976, and then only for cargo and mail transport by *Aeroflot* between *Moscow* and *Alma Ata*, *Kazakhstan*, for operational evaluation. The TU-144 did not begin passenger service until November 1st 1977. From passenger accounts, it was a cramped, uncomfortable and noisy flight. Operating costs were high and it seems the aircraft's reliability left much to be desired. On May 23rd 1978, the first TU-144D caught fire, had to perform an emergency landing at *Alma Ata* and was destroyed with some fatalities. The program never recovered. The TU-144 only performed a total of 102 passenger-carrying flights. Some flight research was performed on two of the aircraft up to 1990, when the TU-144 was finally grounded. 393

Above: caption (translation): "Routes of Flights of Supersonic Passenger Plane TU-144"



Despite TU-144's lack of commercial success, interest in building improved SST's lingered on through the 1980's and 1990's. The U.S. *National Aeronautics & Space Administration* (NASA) conducted studies on such aircraft and, in June 1993, officials of the Tupolev organization met with NASA officials at the *Paris Air Show* to discuss using one of the mothballed TU-144's as an experimental platform for improved SST design. In October 1993, the Russians and Americans announced that they would conduct a joint advanced SST research effort. The program was formalized in a June 1994 agreement. The final production TU-144D was selected for the tests, since it had only 83 flight hours when it was mothballed. Tupolev performed a major refurbishment on it, providing new, upgraded engines (*Kuznetsov NK-321* turbofans, used on the huge Tupolev TU-160 "Blackjack" bomber, details of which were secret-per-agreement thus barring NASA from inspecting them), strengthening the wings (to support the new engines), updating the fuel, hydraulic, electrical and avionics system/s and adding about five-hundred sensors feeding a French-designed digital data-acquisition system. The modified TU-144D was re-designated the "TU-144LL (above), whereby "LL" stood for "Letnoy Laboritoya" (Flying Laboratory). A sequence of about twenty-six test flights was conducted in *Russia* with officials from the *NASA Langley* at the *Zhukovsky Flight Test Center* from 1996 through 1999. 394

Future SST (?)

395

Despite the fact that the U.S. had given up on the *Boeing 2707-300* in 1971, NASA continued to conduct studies on SST development. Thus, in 1985, POTUS *Ronald Reagan* announced that the U.S. was going to develop a high-speed transport named the "Orient Express." The announcement was a bit confusing because it blended an attempt to develop a hypersonic space plane, which emerged as the "National Aerospace Plane" (NASP) effort, with NASA studies for an improved commercial SST. By the early 1990's, NASA's SST studies had emerged as the "High Speed Research" (HSR) effort, a collaboration with U.S. aircraft industries to develop a "High Speed Civil Transport" (HSCT) that would carry up to three-hundred passengers at speeds from Mach 2 to 3 over a distance of 6,500 miles, with a ticket price only 20% more than that of a conventional subsonic airliner (the fact that an SST could move more people in a shorter period of time was seen as an economic advantage). The NASA studies focused heavily on finding solutions to the concerns over high-altitude air pollution, airport vicinity noise levels and sonic booms. Other nations also conducted SST studies and there was an interest in international collaborative development efforts. The biggest non-environmental obstacle was development cost. While it might have been possible to develop an SST with reasonable operating costs, given the high development costs, it was hard to see how such an aircraft could be offered at a competitive price and achieve the sales volume needed to make it feasible to build in the first place. 396

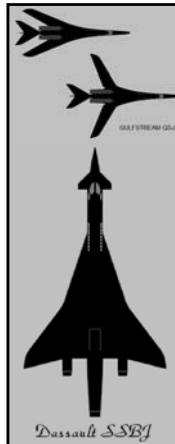

Some aerospace firms took a different approach on the matter, proposing small "Supersonic Business Jets" (SSBJ). The idea was that there is a market of people who regard time as money and who would be willing to pay a high premium to shave a few hours for a trip across the ocean. Development costs of such a machine would be relatively modest and the business model of serving a wealthy elite, along with delivering small volumes of urgent parcels in the cargo hold, seemed realistic. Dassault came up with an SSBJ concept (lower left) in the early 1990's, but it was never realized. Some aircraft manufacturers didn't give up on SST research after the fall of the HSCT program. One of the major obstacles to selling an SST was the fact that sonic booms prevented it from being operated at high speed over land, limiting its appeal, and of course an SST that didn't produce a sonic boom would overcome that obstacle. Studies showed that sonic boom decreased with aircraft length and with reduction in aircraft size. There was absolutely no way the big HSCT, which was on a scale comparable to that of the Boeing 2707-300, could fly without generating a sonic boom and so current industry concepts envision an SSBJ or small supersonic airliner. Gulfstream released a conceptual "Quiet Supersonic Jet" (QSJ) that would seat 24 passengers, have a gross takeoff weight of 150K pounds, a length of 160-feet and variable geometry wings (upper left). Gulfstream officials projected a market of from 180 to 400 machines over ten years, and added that the company had made a good profit in production runs as small as 200 aircraft. Other manufacturers have envisioned small SSTs with up to 50 seats.

397

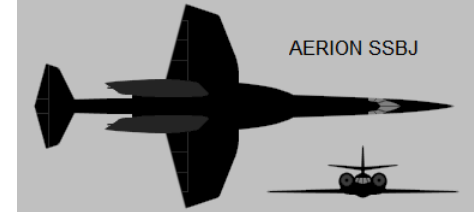

AERION SSBJ

In 2005, Aerion Corporation of Reno, Nevada, announced concepts for an SSBJ designed to carry 8 to 12 passengers, with a maximum range of 4K nautical miles (at Mach 1.5), a length of 149-feet 2 inches, a span of 64-feet 2-inches and a maximum take-off weight of 100K pounds. In most respects, the aircraft is technologically conservative. Configurations envision a dart-like shape with wedge-style wings fitted with long leading-edges, a steeply swept tailfin (with a center-mounted wedge-style tailplane) and twin Pratt & Whitney JT8D-219 turbofan engines mounted on stub pylons on the rear of the wings. A fly-by-wire system will provide controllability over a wide range of flight conditions. The wings will be ultralight, to be made of carbon composite materials and feature full-span trailing-edge flaps to allow takeoffs on typical runways. The Aerion SSBJ will be able to operate efficiently at high subsonic or low supersonic speeds over populated areas, where sonic boom would be unacceptable. The company believes there is a market for 250 to 300 SSBJ's and began taking orders at the Dubai Air Show in 2007.

398

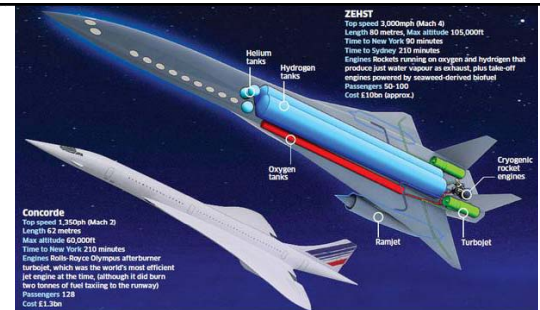

CONCORDE
 Top speed 1,350kph (Mach 2)
 Length 62 meters
 Mile altitude 60,000ft
 Time to New York: 2:10 minutes
 Engines Rolls-Royce Olympus afterburner turbojet, which was the world's most efficient jet engine at the time, (although it did burn two tonnes of fuel landing to the runway)
 Passengers 128
 Cost \$1.5bn

ZEHST
 Top speed 3,000mph (Mach 4)
 Length 80 meters, Mile altitude 105,000ft
 Time to New York: 90 minutes
 Time to Sydney 2:10 minutes
 Engines Rockets running on oxygen and hydrogen that produce just water vapour as exhaust, plus take-off engines powered by recovered-derived kerosene
 Passengers 50-100
 Cost \$1.5bn (approx.)

Labels: Helium tanks, Hydrogen tanks, Oxygen tanks, Cryogenic rocket engines, Ramjet, Turbojet

Despite the setbacks and failures, the idea of the SST continues on. In 2011, the European Aerospace & Defense Systems (EADS) group released a concept (above) for a "Zero-Emissions Hypersonic Transport" (ZEHST) that could carry up to one-hundred passengers at Mach 4 using turbofan, ramjet and rocket propulsion in phases. Presently, conventional turbo and/or ramjet engines are able to remain reasonably efficient up to Mach 5.5, some ideas for very high-speed flight above Mach 6 are also being considered, with the aim of reducing travel times down to one or two hours anywhere in the world. These conceptual proposals typically use either rocket or "scramjet" engines. "Pulse Detonation" engines have also been proposed. However, there are very many difficulties to be overcome with such "Hypersonic" flight; technical, economic, environmental and political.

399



"...The Zehst – or "Zero emission hypersonic transportation" – will fly twice as fast and twice as high as Concorde, if joint European and Japanese development plans come to fruition. The likely cost of a 90-minute 'space flight' from Paris to New York would be €6,000 (£5,300) per passenger. The Zehst, which resembles a lightweight version of the U.S. Space Shuttle, would carry up to 100 passengers at speeds of up to 4,800kph (3,000mph). The aircraft would have three different forms of propulsion in order to eliminate noise problems and meet future ecological constraints. The plane would take off using quiet turbo-reactors powered by a biofuel made from seaweed or algae. To reach its cruising height just outside the atmosphere, the Zehst would use clean rocket engines fuelled by liquid hydrogen and oxygen. Once in the stratosphere, it would switch to another form of rocket propulsion...Boeing, the great American rival of EADS and Airbus, is also working on a new generation of supersonic airliners and has already conducted test-flights with a pilotless model. The unveiling of the plans for the Zehst today is part of a merciless publicity and commercial war between the two aerospace giants...EADS, which has been working on Zehst with the Japanese for five years, is obviously keen to put down its old rival. 'I've heard nothing to suggest that Boeing's hypersonic plane would be environmentally clean like ours,' Mr. Botti told the newspaper Le Parisien. 'I don't think we are behind them. They are certainly going to have a surprise...'"

The Independent, June 20th 2011

400

Above: artist's conceptual rendering of Boeing's Space Shuttle-like Mach 6 "X-51A WaveRider" hypersonic jet plane